



TRAKTOR KONTROL Z1

Setup Guide



The information in this document is subject to change without notice and does not represent a commitment on the part of Native Instruments GmbH. The software described by this document is subject to a License Agreement and may not be copied to other media. No part of this publication may be copied, reproduced or otherwise transmitted or recorded, for any purpose, without prior written permission by Native Instruments GmbH, hereinafter referred to as Native Instruments.

“Native Instruments”, “NI” and associated logos are (registered) trademarks of Native Instruments GmbH.

Mac, Mac OS, GarageBand, Logic, iTunes, iPod, iPad, OSX, are registered trademarks of Apple Inc, registered in the U.S. and other countries. iOS is a trademark or registered trademark of Cisco in the U.S. and other countries, where it is used under license.

Windows, Windows Vista and DirectSound are registered trademarks of Microsoft Corporation in the United States and/or other countries.

All other trademarks are the property of their respective owners and use of them does not imply any affiliation with or endorsement by them.

Document authored by: Native Instruments GmbH

Software version: 2.7 (11/2019)

Special thanks to the Beta Test Team, who were invaluable not just in tracking down bugs, but in making this a better product.

NATIVE INSTRUMENTS GmbH

Schlesische Str. 29-30
D-10997 Berlin
Germany
www.native-instruments.de

NATIVE INSTRUMENTS North America, Inc.

6725 Sunset Boulevard
5th Floor
Los Angeles, CA 90028
USA
www.native-instruments.com

NATIVE INSTRUMENTS K.K.

YO Building 3F
Jingumae 6-7-15, Shibuya-ku,
Tokyo 150-0001
Japan
www.native-instruments.co.jp

NATIVE INSTRUMENTS UK Limited

18 Phipp Street
London EC2A 4NU
UK
www.native-instruments.co.uk

NATIVE INSTRUMENTS FRANCE SARL

113 Rue Saint-Maur
75011 Paris
France
www.native-instruments.com

SHENZHEN NATIVE INSTRUMENTS COMPANY Limited

5F, Shenzhen Zimao Center
111 Taizi Road, Nanshan District, Shenzhen, Guangdong
China
www.native-instruments.com



© NATIVE INSTRUMENTS GmbH, 2019. All rights reserved.

Table of Contents

1	Welcome to the TRAKTOR KONTROL Z1 Setup Guide	7
1.1	What Is Included in the Box?	7
1.2	Document Conventions	8
2	Software Installation	9
2.1	Read Before Installing	9
2.2	Installation on Mac OS X	9
2.2.1	Locate and Start the Installation Program	9
2.2.2	Select the Components to Install	10
2.2.3	Enter Your Password	12
2.2.4	Complete the Installation	12
2.3	Installation on Windows	13
2.3.1	Locate and Start the Installation Program	13
2.3.2	Confirm the Features to Install	14
2.3.3	Confirm the Application Installation Path	15
2.3.4	Select Your Hardware Drivers	16
2.3.5	Complete the Software Installation	16
3	Product Activation with Service Center	18
3.1	Start Service Center	18
3.2	Log In Into Your User Account	19
3.3	Activate the Product	20
3.4	Finish the Online Activation	21
3.5	Updating Your Product	22
3.5.1	Select Updates	22
3.5.2	Download the Updates	23
3.5.3	Open Your Download Folder	24

3.5.4	Install the Updates	25
3.6	Further Information	25
4	Using the Z1 with Your Computer	26
4.1	Connecting the Z1 to Your Computer	26
4.2	Connecting Headphones	32
4.3	Connecting an Amplification System	33
4.4	Overview of Your TRAKTOR KONTROL Z1 Computer Setup	34
4.5	Final Preparations	35
4.6	Starting the TRAKTOR Software on Your Computer	35
5	Using the Z1 with Your iOS Device	36
5.1	Connecting the Z1 to Your iOS Device	36
5.2	Connecting the Power Supply	37
5.3	Connecting Headphones	39
5.4	Connecting an Amplification System	40
5.5	Overview of Your TRAKTOR KONTROL Z1 iOS Device Setup	41
5.6	Final Preparations	42
5.7	Launching the TRAKTOR DJ App	42
6	What's Next?	44
7	Troubleshooting and FAQ	45
7.1	Installation Folder Not Found by an Update Installer	45
7.2	Audio Clicks and Drop-outs When Playing Tracks	45
7.3	More Troubleshooting Resources	45
8	Support	46
8.1	Knowledge Base / Online Support / Readme	46
8.2	Forum	47

8.3	Updates	47
9	Product Returns	48

1 Welcome to the TRAKTOR KONTROL Z1 Setup Guide

Thank you for purchasing the TRAKTOR KONTROL Z1. On behalf of the entire Native Instruments team, we hope you are truly inspired by this product. This Setup Guide covers the following topics:

- How to install the TRAKTOR software on your computer
- How to activate your TRAKTOR version using the Service Center application
- How to connect the devices and get your TRAKTOR KONTROL Z1 system up and running
- How to make use of your iOS device with the TRAKTOR KONTROL Z1
- How to proceed once your TRAKTOR KONTROL Z1 system is up and running
- How to solve common problems, and where to find further product support

1.1 What Is Included in the Box?

The TRAKTOR KONTROL Z1 box contains the following items:

- The TRAKTOR KONTROL Z1
- A power supply
- A USB cable
- A registration flyer with your TRAKTOR LE 2 software serial number, your TRAKTOR KONTROL Z1 hardware serial number, and a link to the hardware registration page, where you can register your hardware and download the TRAKTOR software
- A safety instructions flyer

1.2 Document Conventions

This document uses particular formatting to point out special facts and to warn you of potential issues. The icons introducing the following notes let you see what kind of information can be expected:



Whenever this exclamation mark icon appears, you should read the corresponding note carefully and follow the instructions and hints given there if applicable.



This light bulb icon indicates that a note contains useful extra information. This information may often help you to solve a task more efficiently, but does not necessarily apply to the setup or operating systems you are using; however, it's always worth a look.

Furthermore, the following formatting is used:

- Text appearing in (drop-down) menus (such as *Open...*, *Save as...*) and paths to locations on your hard drive or other storage devices is printed in *italics*.
 - Text referring to elements appearing on the screen (labels of buttons, controls, text next to checkboxes, etc.) is printed in light blue. Whenever you see this formatting applied, you will find the same text appearing on your computer screen.
 - Text referring to elements printed on hardware is formatted orange. Whenever you see this formatting applied, you will find the same text appearing on the hardware.
 - Important names and concepts are printed in **bold**.
1. Single instructions are introduced by this play button type arrow.
⇒ Results of actions are introduced by this smaller arrow.

2 Software Installation

2.1 Read Before Installing

Before starting the TRAKTOR software installer, here are some points to be aware of:

- **Make sure you have downloaded the TRAKTOR software** to your computer by following the instructions on the registration page:
www.native-instruments.com/go-z1
If you have already registered your device but need to download the installer again, you can find the relevant downloads in the "My Account" section of the NI website:
<https://www.native-instruments.com/en/my-account/my-products-serials>
- Please **carefully review the installer screens** and the suggested installation paths in order to avoid that any unwanted folders are created on your hard disk.
- **Moving any folders** related to Native Instruments software **after installation is not recommended**. Future software updates rely on the directory locations set during initial installation.

2.2 Installation on Mac OS X

At the end of the installation process, you will need to restart your computer. Please save your work and close all applications before proceeding.

2.2.1 Locate and Start the Installation Program

1. Locate and unpack the downloaded installer package file on your computer.
2. Double-click the **Traktor 2 Installer.mpkg** file to start the installation procedure.
3. Follow the on-screen instructions.

2.2.2 Select the Components to Install

After you have accepted the software license agreement, the installer window displays the components available for installation.



There is no dedicated entry for your TRAKTOR KONTROL Z1 in the components selection screen as the Z1 does not require a dedicated driver under MAC OS X. It is recommended to keep all remaining drivers selected unless you have a specific reason to deselect one (such as if the driver is already installed on your computer, or you are very sure you will never use the device with TRAKTOR).

This installer screen also contains information about how much disk space the individual components will use.

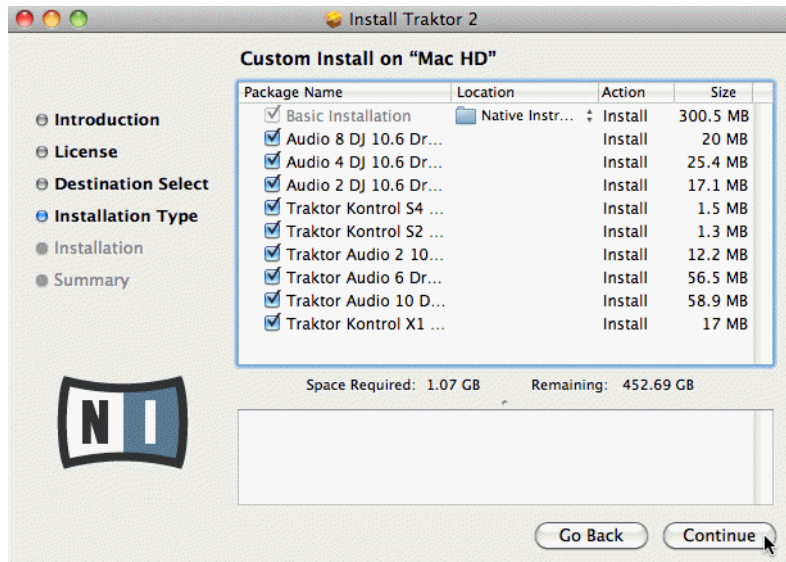

Basic Installation: This installs the TRAKTOR software along with its documentation. This component cannot be deselected. It also installs the Service Center application (required for activation of your product) and the Controller Editor application, which allows you to configure the controller's MIDI assignments for using the controller with other applications than TRAKTOR.

Audio 8/4/2 DJ Drivers: This installs drivers for the AUDIO 8 DJ, AUDIO 4 DJ and AUDIO 2 DJ audio interfaces by Native Instruments. If you do not intend to use any of these audio interfaces, you can deactivate the checkboxes.

Traktor Kontrol S4: This installs the driver for the TRAKTOR KONTROL S4 controller. If you do not intend to use a TRAKTOR KONTROL S4 controller on your computer, you can deactivate the checkbox.

Traktor Kontrol S2: This installs the driver for your TRAKTOR KONTROL S2 controller. If you do not intend to use a TRAKTOR KONTROL S2 controller on your computer, you can deactivate the checkbox.

Traktor Audio 2/6/10 Drivers: This installs the drivers for the TRAKTOR AUDIO 2, TRAKTOR AUDIO 6 and TRAKTOR AUDIO 10 audio interfaces by Native Instruments. If you do not intend to use any of these audio interfaces, you can deactivate the checkboxes.

Traktor Kontrol X1: This installs the driver for the TRAKTOR KONTROL X1 controller. If you do not intend to use a TRAKTOR KONTROL X1 controller on your computer, you can deactivate the checkbox.

Background Components

These components are not displayed in the installer window, but are installed depending on your system configuration:

Controller Editor: The Controller Editor application allows you to configure your controller for use as a MIDI controller with applications other than the TRAKTOR software. This component will automatically be installed unless a newer version of Controller Editor already exists on your computer.

Service Center: The Service Center application is required for activation of the TRAKTOR software. It will be installed independent of the selected drivers (unless a newer version of Service Center already exists on your computer).

It is strongly recommended to install the TRAKTOR software to the default location. If you still need to change the install location, click on the folder icon in the Location column and select the desired folder.

1. After you have customized the installation as required, click Continue and then follow the on-screen instructions.

2.2.3 Enter Your Password

Before installing the selected components, the installer will prompt you to enter your Mac OS X password. This is a standard behavior on Mac OS X that makes sure you are aware of the changes the installer is about to make.

The Mac OS X user account you are using needs to have Administrator privileges.

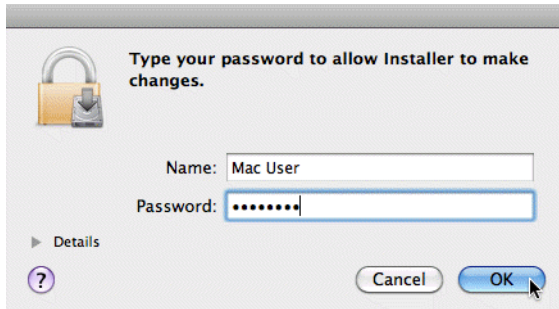

1. To proceed, enter your password and click OK.
⇒ The selected components will be installed.

2.2.4 Complete the Installation

After the components have been installed, you need to restart your computer.

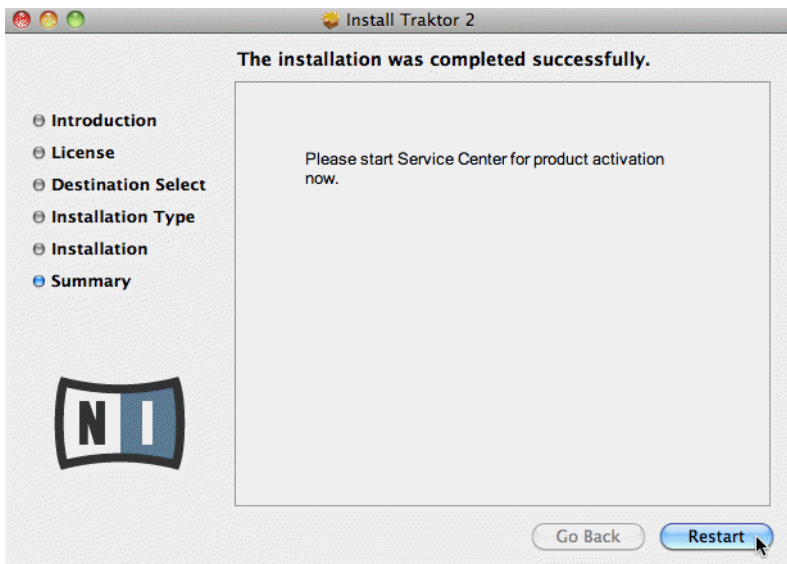

1. On the last screen of the installation program, click Restart to restart your computer and complete the software installation.
⇒ Your computer will immediately restart.
1. After your computer has restarted, continue reading in chapter [↑3, Product Activation with Service Center](#) of this Setup Guide for information about product activation.

2.3 Installation on Windows

This section describes the process of installing the TRAKTOR software on Windows.



It may be necessary to disable your anti-virus software during installation, please refer to the software's own documentation for further information.

2.3.1 Locate and Start the Installation Program

1. Locate and unpack the downloaded installer package file on your computer.
2. Double-click the **Traktor 2 Setup.exe** file to start the installation procedure.

3. Follow the on-screen instructions.

2.3.2 Confirm the Features to Install

After you have accepted the software license agreement, the installer window displays the features available for installation.

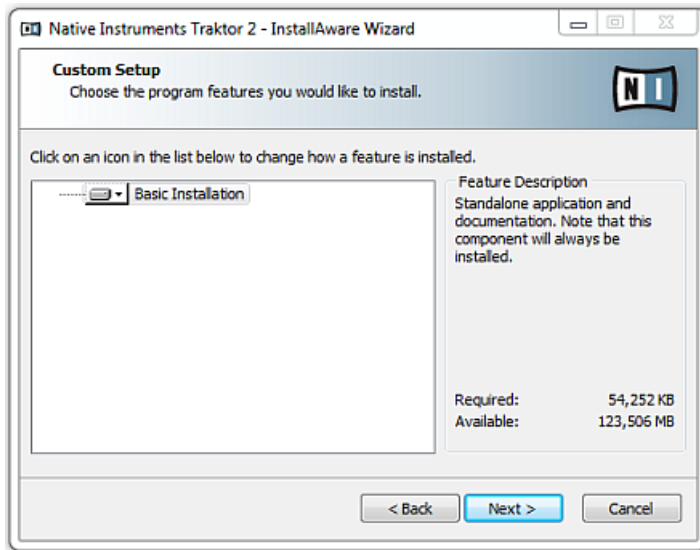

The components selection screen of the installation program.

Basic Installation: This installs the TRAKTOR software along with its documentation. This component cannot be deselected.

Background Components

These components are not displayed in the installer window, but are installed depending on your system configuration:

Controller Editor: The Controller Editor application allows you to configure your controller for use as a MIDI controller with applications other than the TRAKTOR software. This component will automatically be installed unless a newer version of Controller Editor already exists on your computer.

Service Center: The Service Center application is required for activation of the TRAKTOR software. It will be installed independent of the selected drivers (unless a newer version of Service Center already exists on your computer).

1. Click Continue and then follow the on-screen instructions.

2.3.3 Confirm the Application Installation Path

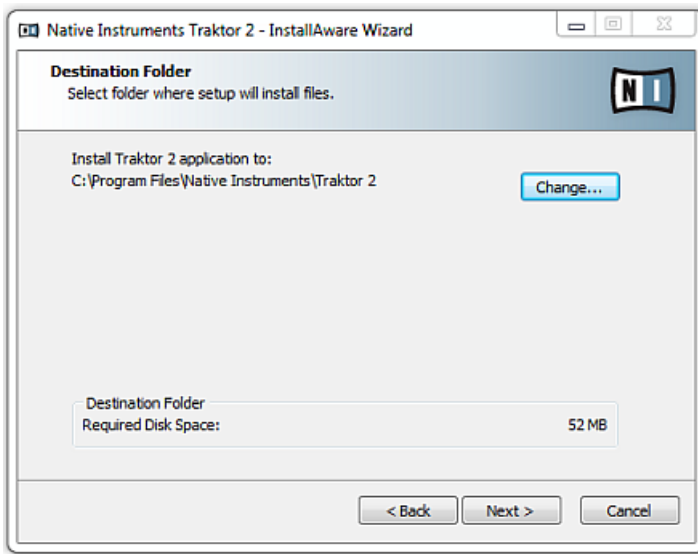

The software installation path screen of the installation program.

It is strongly recommended to install the TRAKTOR software to the default location. If you still need to change the install location, click Change to open a Folder Selection dialog and select the desired destination folder.

You will be asked to select and confirm an installation path for the TRAKTOR software.

1. Click Next to proceed.

2.3.4 Select Your Hardware Drivers

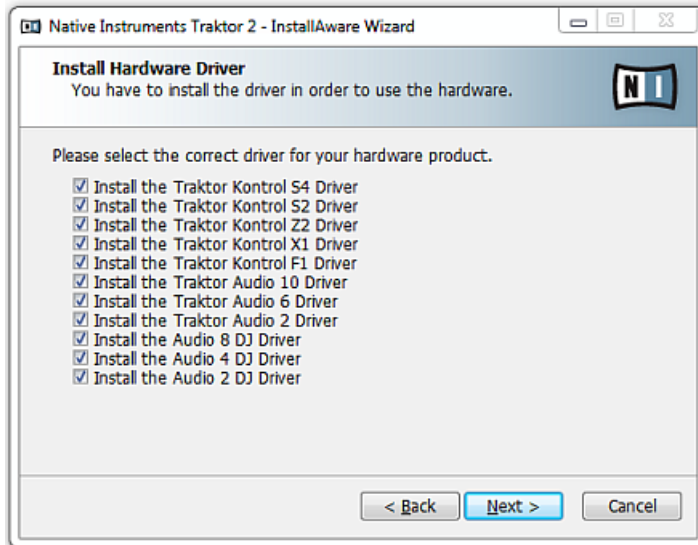

The Hardware Drivers screen of the installation program

After defining/confirming the program's installation path, you will be presented with a driver selection screen. It is recommended to select all drivers from the driver selection screen unless you have a specific reason to deselect a driver (such as if the driver is already installed on your computer, or you are very sure you will never use the device with TRAKTOR).

1. Click Next to proceed.

2.3.5 Complete the Software Installation

Once you have selected the driver and confirmed your selection, you will be forwarded to the last screen of the installation program.

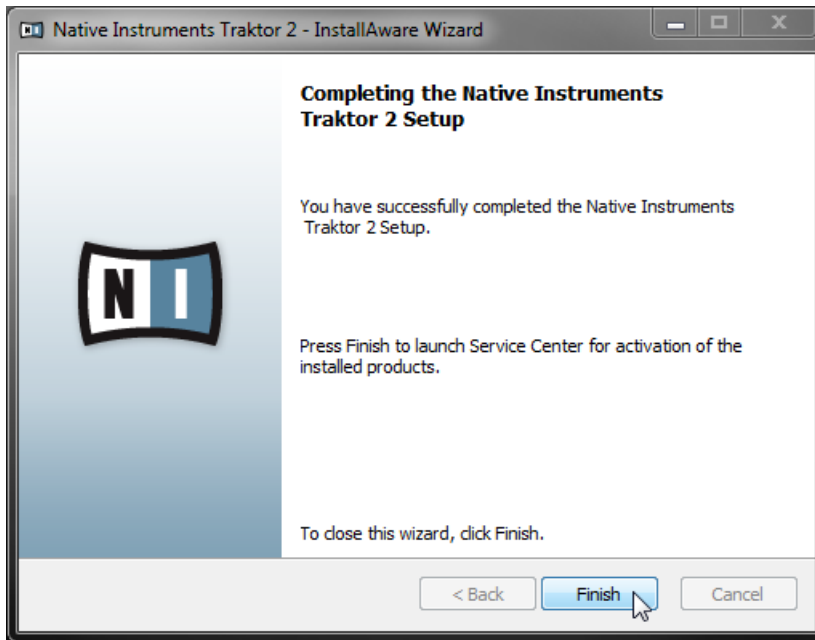

The final screen of the installation program.

1. On the last screen of the installation program, click Finish to complete the installation and exit the installation program.

Continue reading in chapter [↑3, Product Activation with Service Center](#) of this Setup Guide for information about product activation.

3 Product Activation with Service Center



This section of the Setup Guide uses a placeholder name (“NI Product”) on all screenshots. The relevant section on your screen will display the name of the Native Instruments product you are activating.

3.1 Start Service Center

1. Locate the Service Center application on your hard disk. During installation, a folder labeled **Native Instruments** was created in the Applications (Mac OS X) / Program Files (Windows) folder. Within this folder, a subfolder labeled **Service Center** holds the corresponding application.
2. Double-click the Service Center application to start the activation procedure.



It is necessary to activate your Native Instruments product in order to use its full functionality.

3.2 Log In Into Your User Account

SERVICE CENTER

Log in

Please log in using your e-mail address and password.

E-mail address

Password

Log me in automatically on next startup

› Forgot your password?

› Create new User Account

Log in

Status:
Online

1. Log in with your email address and Native Instruments password.
2. If you do not have a Native Instruments account yet, click on Create new User Account. Fill in the address form. The password will be sent to you via e-mail.

3.3 Activate the Product

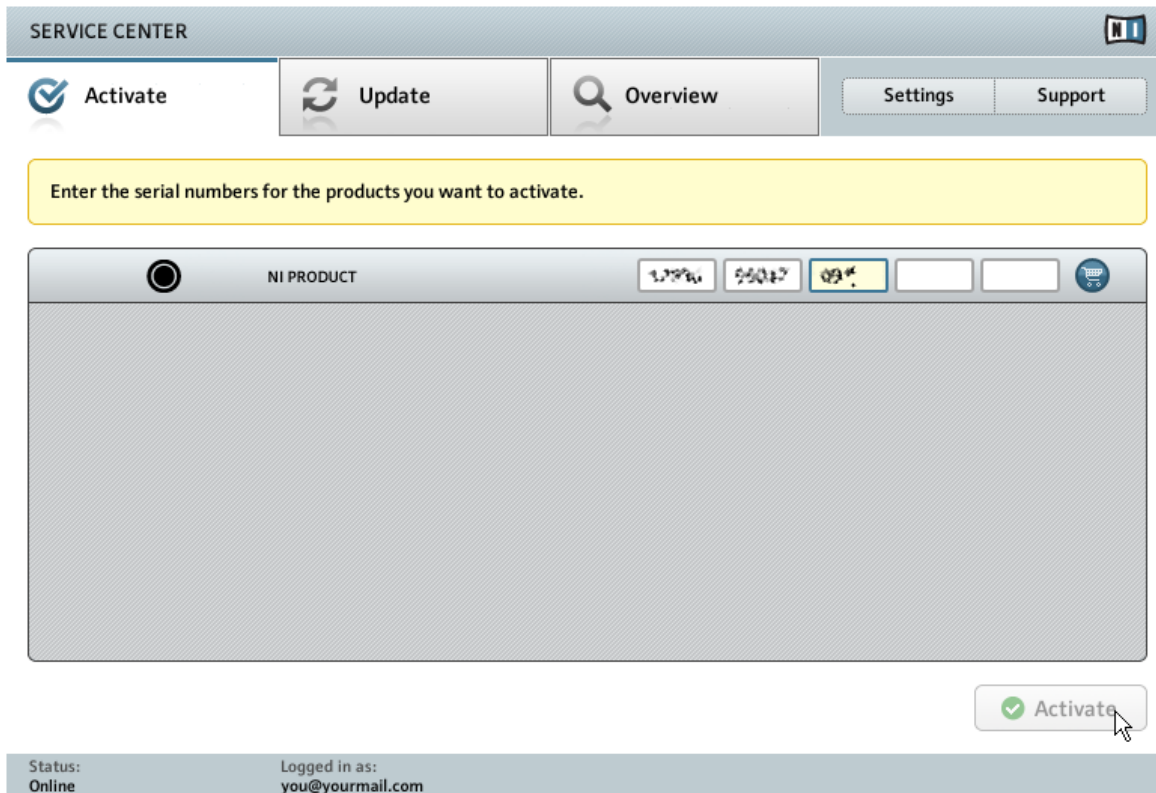

The product activation screen of Service Center.

1. Enter the software serial number in the number field. The software serial number is located on the registration flyer, which you can find in your TRAKTOR KONTROL Z1 product box.
2. Click Activate to proceed.

3.4 Finish the Online Activation

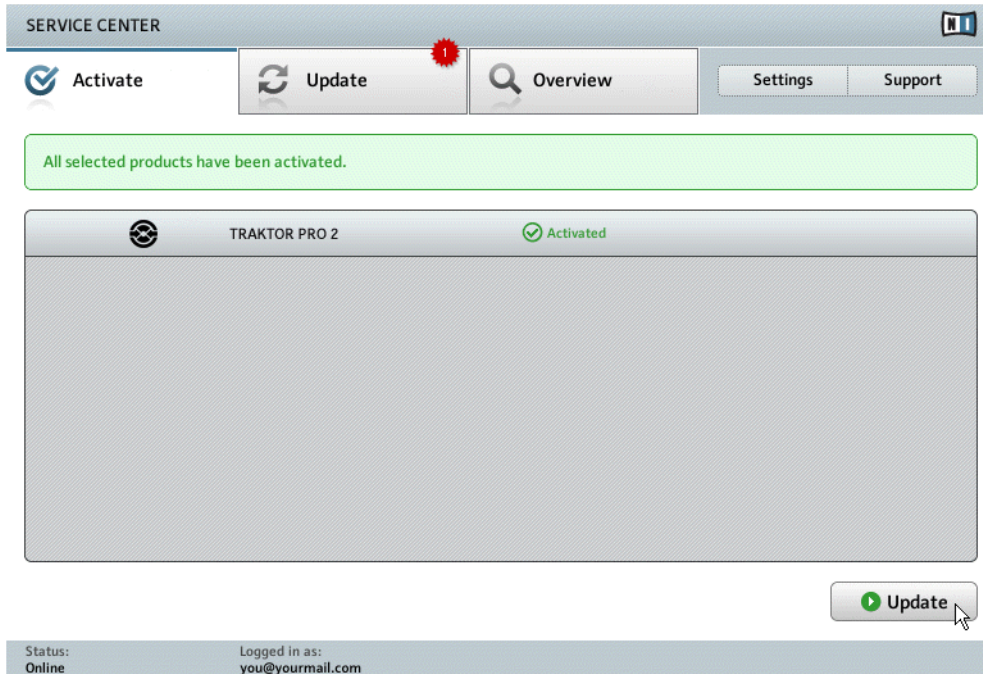

Service Center confirms that the product has been activated successfully. A search for updates will start automatically.

- If updates for any of the activated products are available, the button in the bottom right corner of the screen reads Update. To download the updates, click the Update button and proceed with chapter [↑3.5, Updating Your Product](#).
- If no updates are available, the button in the bottom right corner of the screen reads Exit. You can click it to close Service Center.

3.5 Updating Your Product

3.5.1 Select Updates

The screenshot shows the Service Center interface for selecting updates. At the top, there is a navigation bar with 'Activate', 'Update' (highlighted with a red notification bubble), 'Overview', 'Settings', and 'Support'. Below this is a yellow instruction box: 'Please select the updates you want to download. If you want to download updates for another operating system, visit www.native-instruments.com/updates.' The main area is titled 'Software Updates' with '1 file available' and a 'Hide Details' dropdown. A table lists one update: 'NI PRODUCT Update' with a checkmark, a refresh icon, an information icon, and the date '2010-09-01, 179.09 MB'. Below the table, the download folder is set to 'C:\...\downloads\'. A 'Download' button with a green checkmark is visible. At the bottom, the status is 'Online' and the user is logged in as 'you@yourmail.com'.

SERVICE CENTER

Activate Update Overview Settings Support

Please select the updates you want to download. If you want to download updates for another operating system, visit www.native-instruments.com/updates.

Software Updates 1 file available Hide Details

<input checked="" type="checkbox"/>		NI PRODUCT Update	2010-09-01, 179.09 MB
-------------------------------------	--	-------------------	-----------------------

Download folder: C:\...\downloads\

Download

Status: Online Logged in as: you@yourmail.com

3.5.2 Download the Updates

The screenshot displays the Service Center interface. At the top, there is a navigation bar with buttons for 'Activate', 'Update', 'Overview', 'Settings', and 'Support'. The 'Update' button is highlighted with a red notification icon. Below the navigation bar, a yellow message box states: "The selected files are currently being downloaded. This may take a while." The main area shows a 'Software Updates' section with '1 file available'. A progress bar for 'NI PRODUCT Update' is shown, indicating that 82.9 of 179.1 MB has been downloaded. The progress bar is at 45% completion. Below the progress bar, the download folder is listed as 'C:\...\downloads\'. A 'Cancel' button is visible on the right. At the bottom, the status bar shows 'Status: Online', 'Logged in as: you@yourmail.com', and 'Downloading...' with a progress indicator.

The product update is in progress.

Depending on the file size and the speed of your internet connection, downloading the files may take a while. We strongly recommend that you always install the latest updates.

3.5.3 Open Your Download Folder

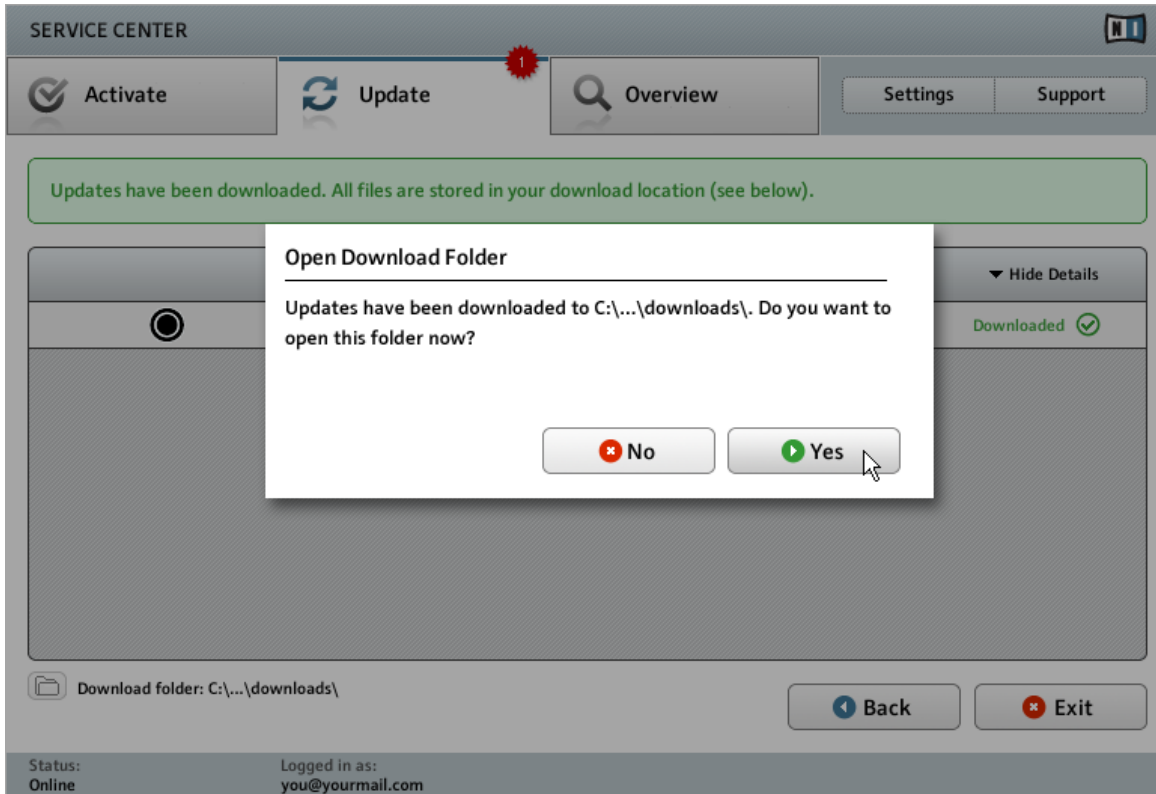

Service Center confirming all updates were downloaded, and offering to open the download folder.

After all files have been downloaded successfully, you will be asked to open the download folder.

1. Click Yes to open the download folder.
2. After the download folder has opened, you can quit Service Center by clicking Exit.

3.5.4 Install the Updates

1. Launch the first installer file from the download folder.
2. Follow the instructions of the Installation Wizard.
3. Proceed until you have installed all updates.

3.6 Further Information

For details on your registered products and their serial numbers as well as information on licenses and NI user account settings, please see My Account: <http://www.native-instruments.com/my-account/>

4 Using the Z1 with Your Computer

If you are using the Z1 with your computer, follow the instructions in this section. Before connecting the devices, and setting up your TRAKTOR KONTROL Z1, here are some points to be aware of:

- In the scenario of using TRAKTOR on a Windows system. Make sure that you have installed the Z1 hardware driver with the TRAKTOR software installer before you connect the Z1 to your computer! For this, please follow the instructions specific to your operating system in section [↑2, Software Installation](#).
- The Z1 may not work properly connected to a USB hub! Connect it directly to a USB port on your computer.



The Z1—in combination with a power amplifier, speakers, or headphones—can produce sounds in decibel ranges that may cause hearing damage. Also, switching off the device with the volume control set to a high level may damage your loudspeakers. Always make sure the volume faders on the Z1 are set to minimum before connecting the power supply, connecting external equipment, playing music, or switching the device on or off. Once everything is connected and set up, gradually raise the volume while music is playing until you reach the desired listening level.

4.1 Connecting the Z1 to Your Computer

To connect the TRAKTOR KONTROL Z1 to your computer:

1. Connect the device end (square plug) of the included USB cable to the USB socket on the rear panel of your Z1.
2. Connect the computer end (flat rectangle plug) of the USB cable to an available USB 2.0 port (or later) on your computer.

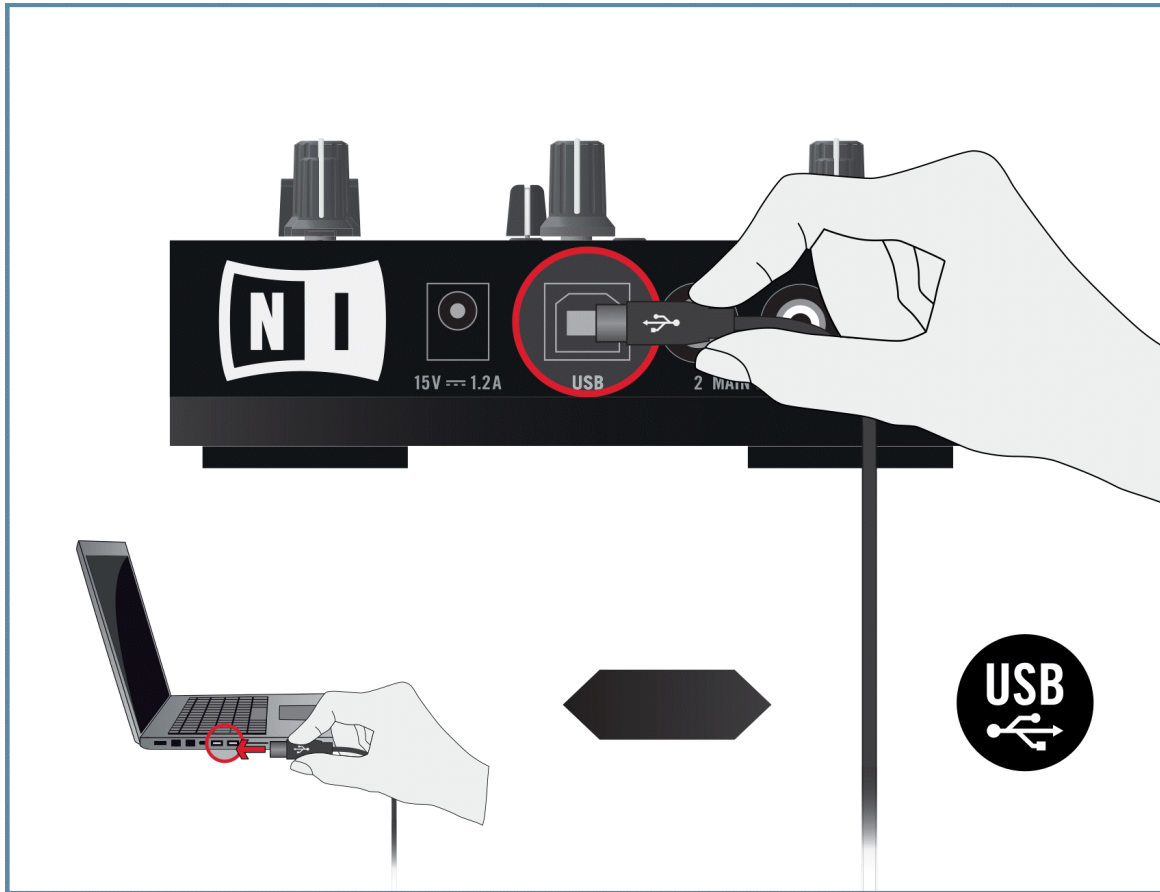

When the Z1 is connected to your computer, its power supply is not required. The Z1 is instead powered by the computer.

Windows Users Only: Completing the Device Driver Installation

Upon detection of the new hardware, Windows completes the device driver installation:

1. A message reading Installing device driver software will be displayed.



2. When the InstallAware Wizard pops up, click Next to proceed.

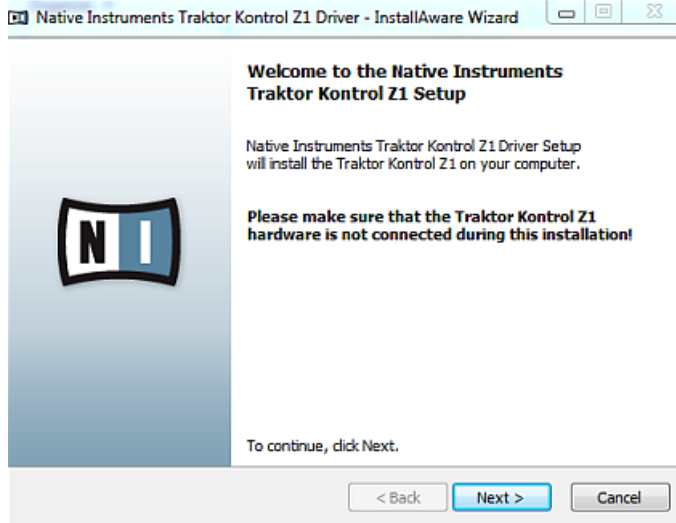

3. Select the suitable language from the drop-down menu and click Next to proceed.

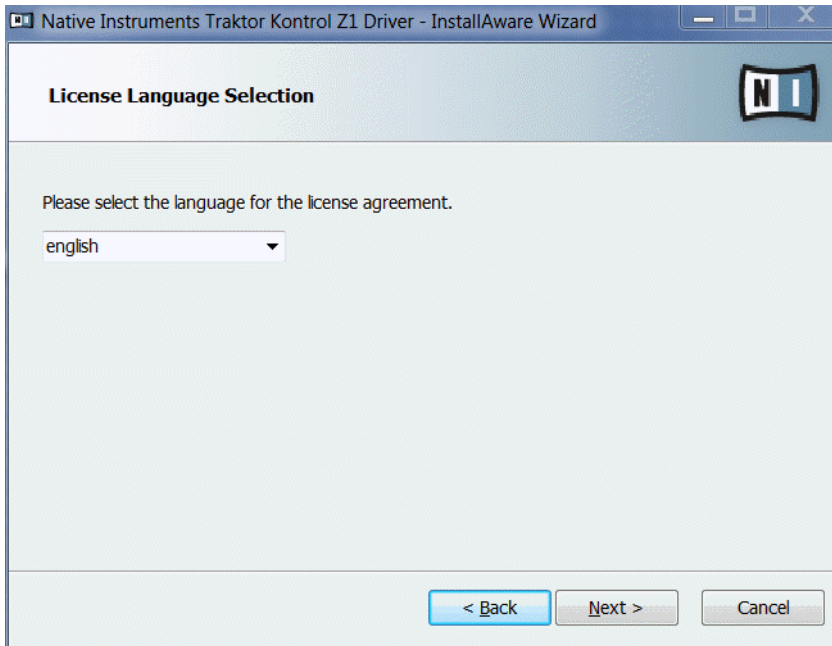

4. Check the box to accept the terms of the license agreement. Click Next to proceed.

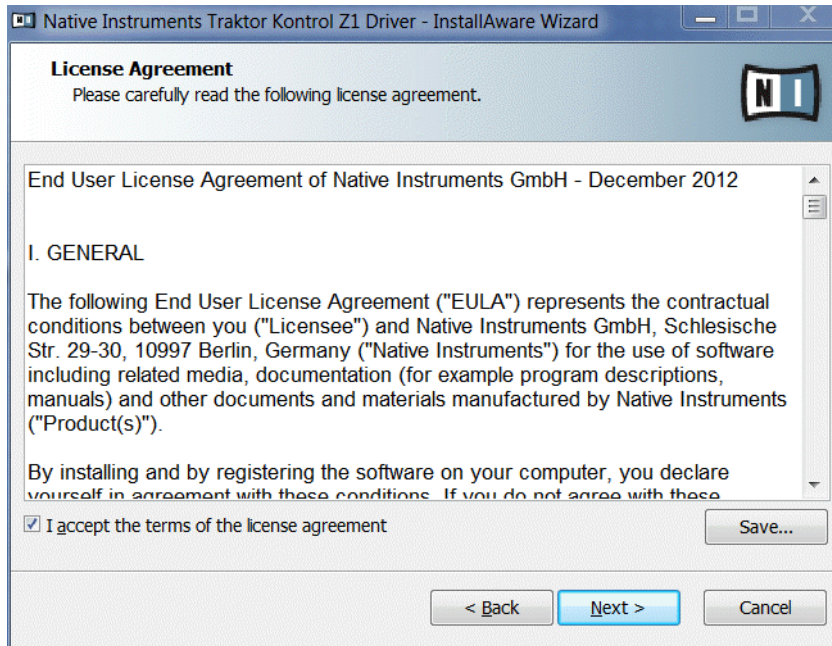

5. The InstallAware Wizard is now ready to configure the Z1. Click Next to complete the installation.

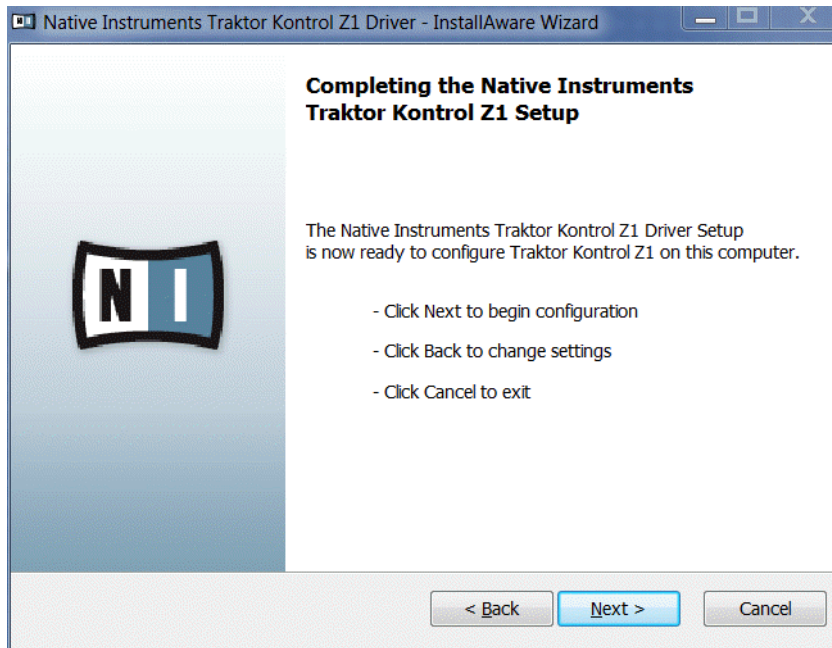

6. After device driver installation has finished, Windows will display the message Your devices are ready to use.

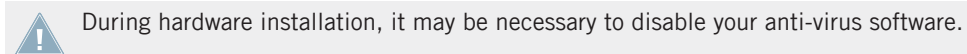
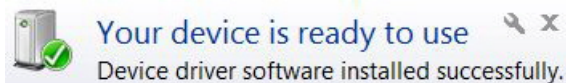

4.2 Connecting Headphones



Before putting on headphones, always make sure the headphone volume control (HP VOLUME knob on the Z1's top panel) is set to minimum! Slowly increase the headphone volume while music is playing until it reaches the desired listening level.

To connect your headphones to the TRAKTOR KONTROL Z1:

1. Connect your headphones to the PHONES socket on the front panel of the device; note that the headphones socket uses a 3.5mm jack.

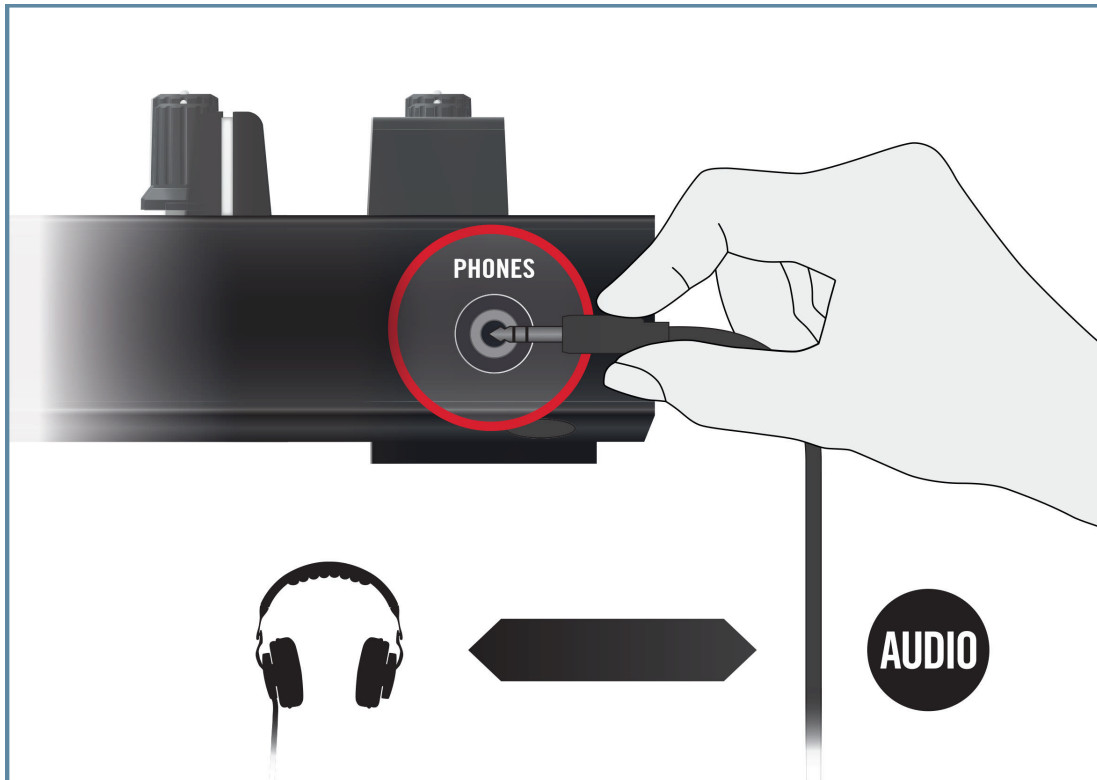

4.3 Connecting an Amplification System



Switch off your amplification system (active speakers or power amplifier), and set the volume faders on the Z1 to minimum before you proceed. Slowly increase the volume while music is playing until a desired listening level is reached.

To connect your power amplifier or active speakers to the TRAKTOR KONTROL Z1:

1. Connect the MAIN OUT RCA outputs on the back panel of the TRAKTOR KONTROL Z1 to the inputs of your amplification system using matching cables.

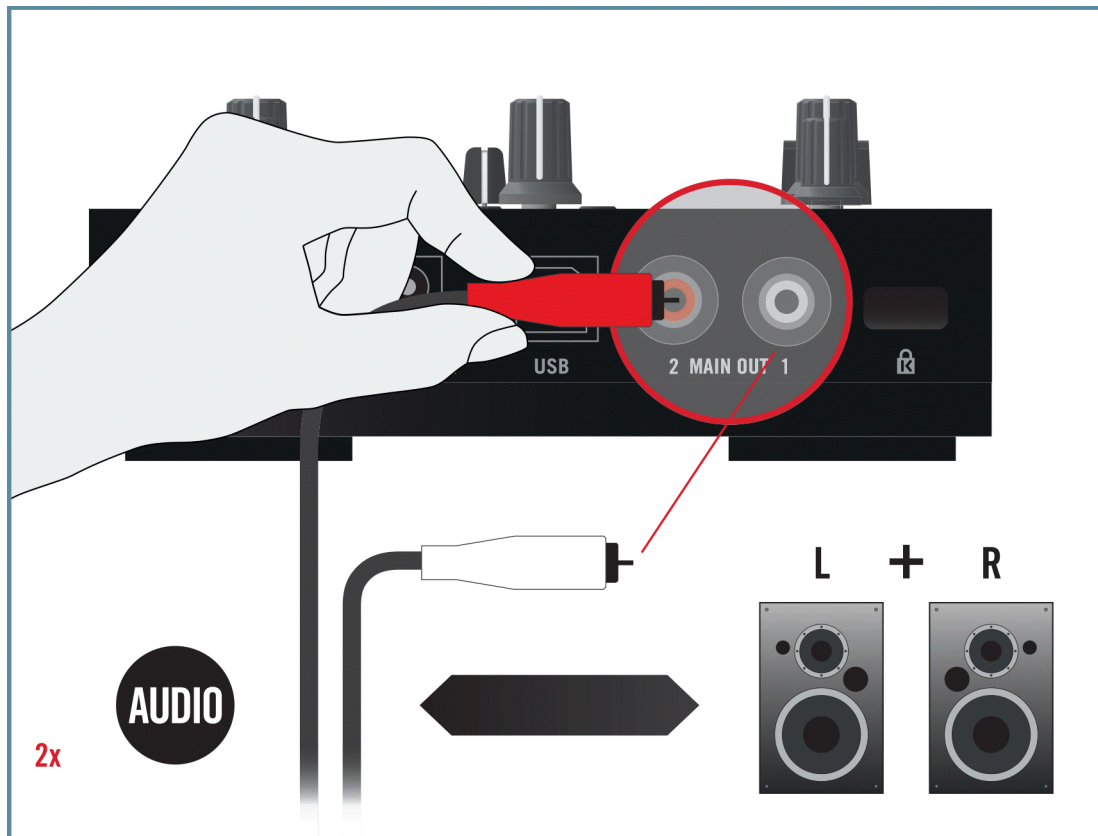

4.4 Overview of Your TRAKTOR KONTROL Z1 Computer Setup

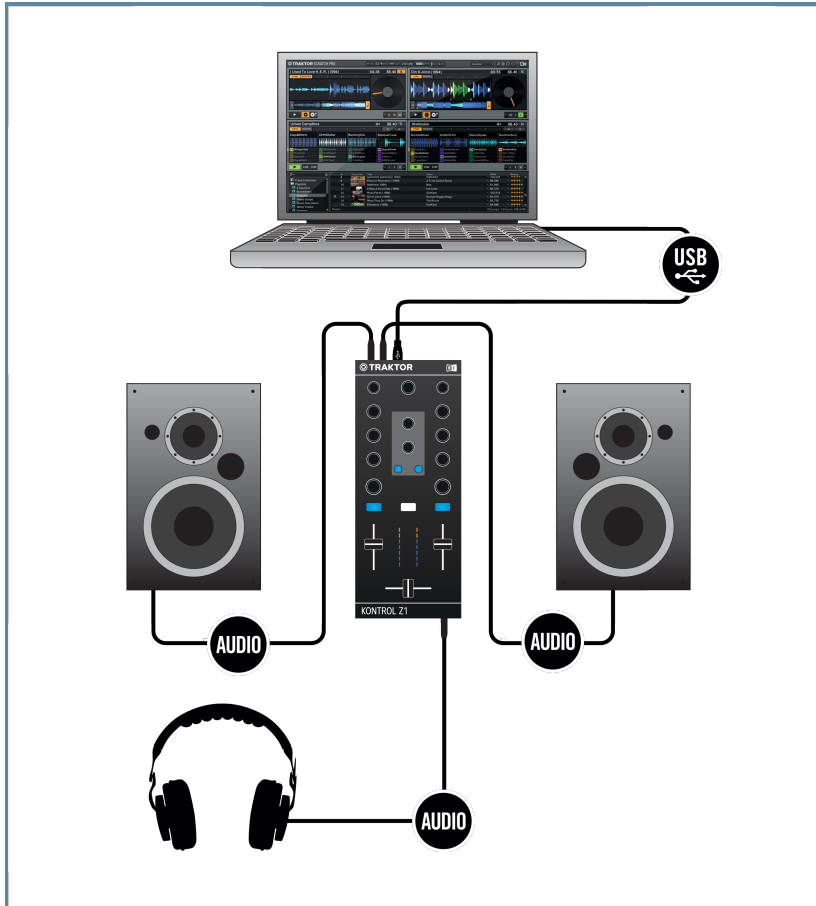

An example of a Z1 system setup using a computer

4.5 Final Preparations

It is recommended that you follow the instructions below order when switching on your devices:

1. Turn on your computer.
2. Ensure that the TRAKTOR KONTROL Z1 is connected to the computer's USB 2.0 port.
3. Turn on the amplification system (active speakers or power amplifier with passive speakers).

Later on, when the software is running and you have loaded tracks to TRAKTOR's Decks, gradually raise the volume controls while music is playing until a comfortable listening level is reached.



Before putting on headphones, always make sure the headphone volume control is set to minimum! While playing music, slowly increase the headphone volume until it reaches the desired listening level.

4.6 Starting the TRAKTOR Software on Your Computer

After successful installation, you will find the TRAKTOR software installation folder on your hard disk containing the application and the documentation resources. If you installed using the default settings, these folders can be found here:

- Mac OS X: *Macintosh HD/Applications/Native Instruments/Traktor 2/*
- Windows: *C:\Program Files\Native Instruments\Traktor 2*

To start TRAKTOR:

1. Double-click the **Traktor** application icon in the installation folder, or, on Windows, one of its aliases/shortcuts created during the installation procedure (for example on your desktop).
⇒ The TRAKTOR window with the Setup Wizard's start screen in front of it will open. Configure TRAKTOR following the steps in the Setup Wizard. For more information on TRAKTOR's Setup Wizard, please refer to the full TRAKTOR Getting Started Guide.

5 Using the Z1 with Your iOS Device

If you are using the Z1 with your iOS device, follow the instructions in this section. Before connecting the devices, and setting up your TRAKTOR KONTROL Z1, here are some points to be aware of:

- If you intend to use the Z1 in conjunction with TRAKTOR DJ on your iOS device, ensure that you have already downloaded the TRAKTOR DJ app before connecting the Z1. You can download TRAKTOR DJ from the iTunes App Store.
- For an up to date list of compatible iOS devices see www.native-instruments.com/traktorkontrolz1specifications



The Z1-in combination with a power amplifier, speakers, or headphones-can produce sounds in decibel ranges that may cause hearing damage. Also, switching off the device with the volume control set to a high level may damage your loudspeakers. Always make sure the volume faders on the Z1 are set to minimum before connecting the power supply, connecting external equipment, playing music, or switching the device on or off. Once everything is connected and set up, gradually raise the volume while music is playing until you reach the desired listening level.

5.1 Connecting the Z1 to Your iOS Device

To connect the TRAKTOR KONTROL Z1 to your iOS device:

1. Connect the device end (USB plug type B, device connector) of an iOS cable to the USB socket on the rear panel of the Z1.
2. Connect the Apple connection end of the cable to the Lightning connector of your iOS device.

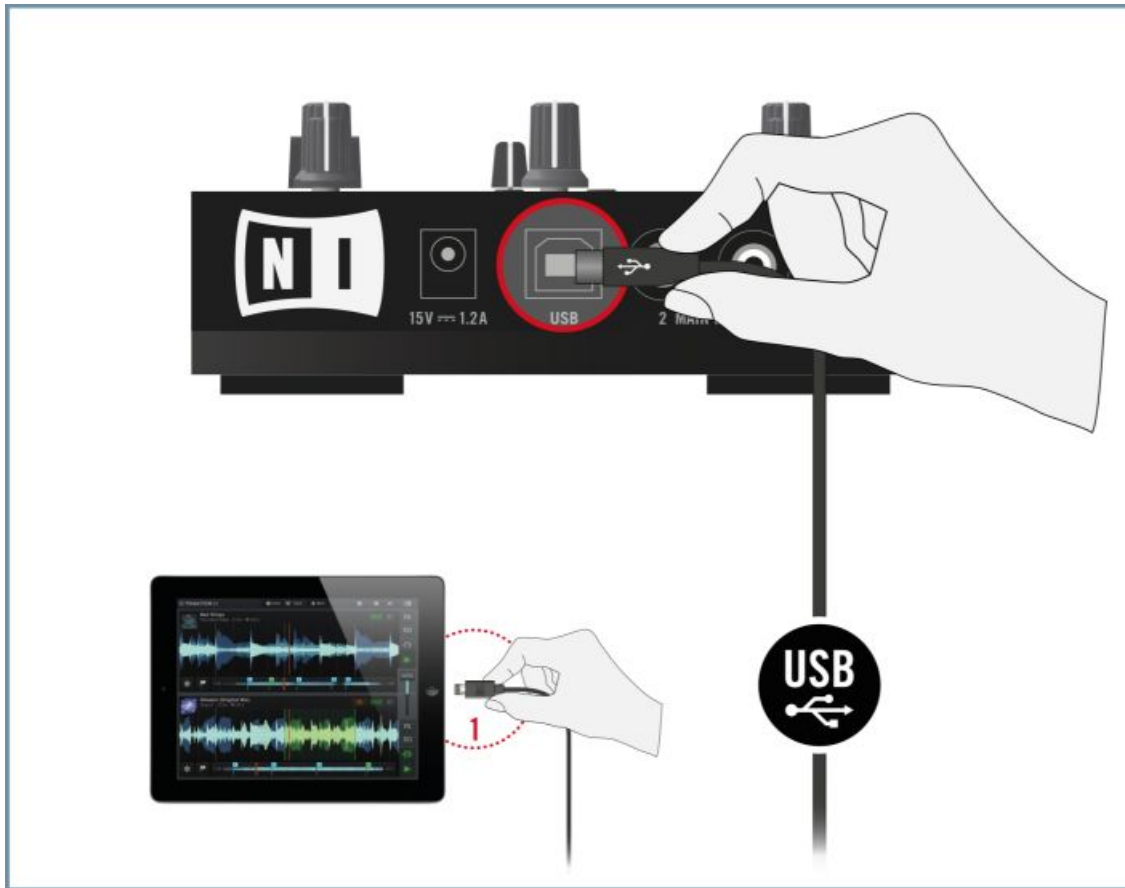

(1) The required iOS Cable connecting the iPad to the Z1.

5.2 Connecting the Power Supply

To connect the power supply:

1. Connect the plug of the power cable to a power outlet.

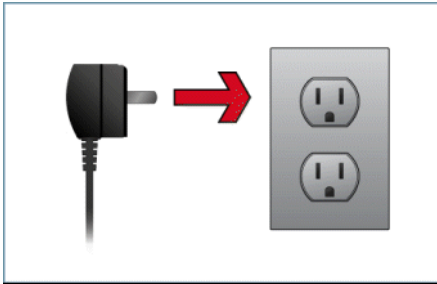

2. Connect the 15V male plug end of the power supply's cable to the power supply input on the rear panel of your TRAKTOR KONTROL Z1.

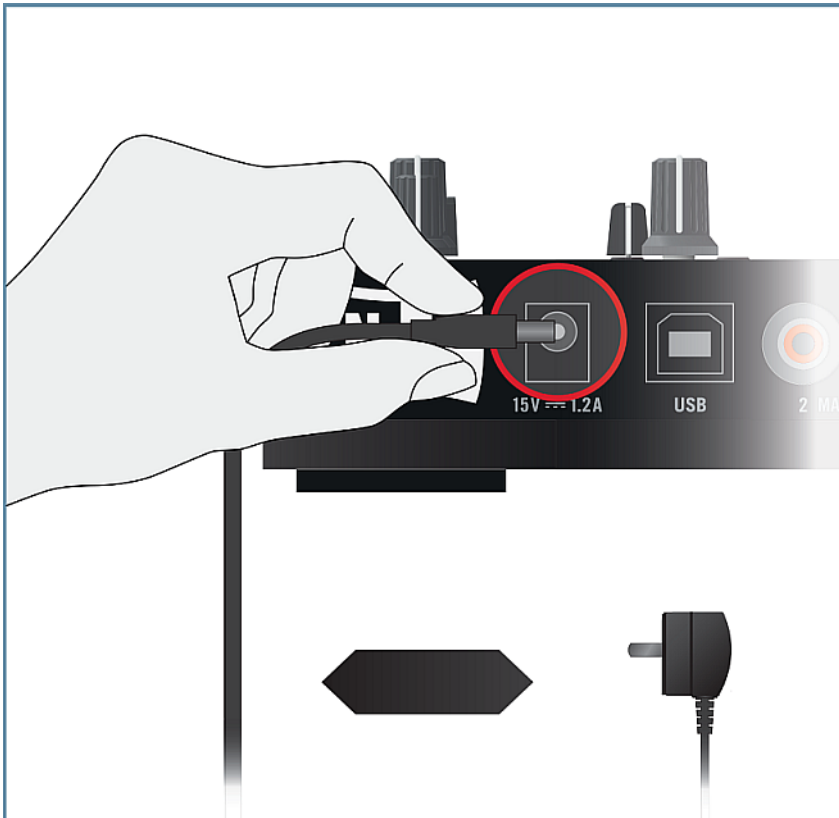

5.3 Connecting Headphones



Before putting on headphones, always make sure the headphone volume control (HP VOLUME knob on the Z1's top panel) is set to minimum! Slowly increase the headphone volume while music is playing until it reaches the desired listening level.

To connect your headphones to the TRAKTOR KONTROL Z1:

1. Connect your headphones to the PHONES socket on the front panel of the device; note that the headphones socket uses a 3.5mm jack.

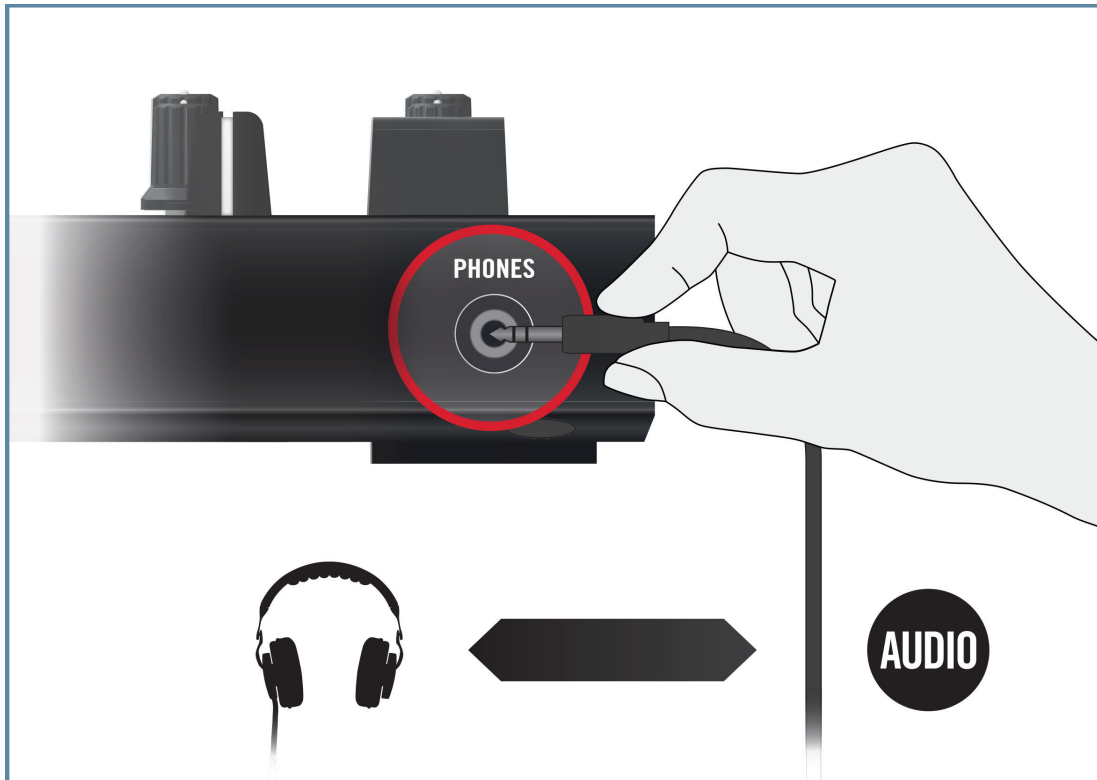

5.4 Connecting an Amplification System



Switch off your amplification system (active speakers or power amplifier), and set the volume faders on the Z1 to minimum before you proceed. Later on, slowly increase the volume while music is playing until a desired listening level is reached.

To connect your power amplifier or active speakers to the TRAKTOR KONTROL Z1:

1. Connect the MAIN OUT RCA outputs on the back panel of the TRAKTOR KONTROL Z1 to the inputs of your amplification system using matching cables.

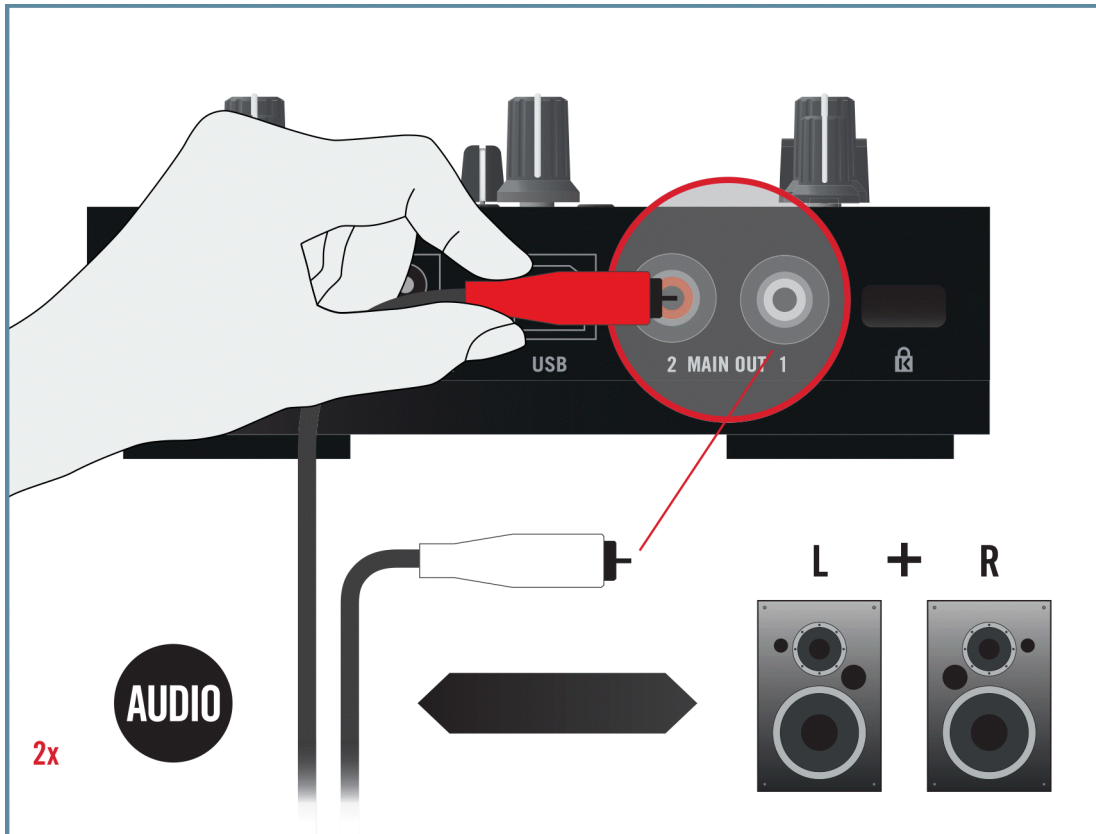

5.5 Overview of Your TRAKTOR KONTROL Z1 iOS Device Setup

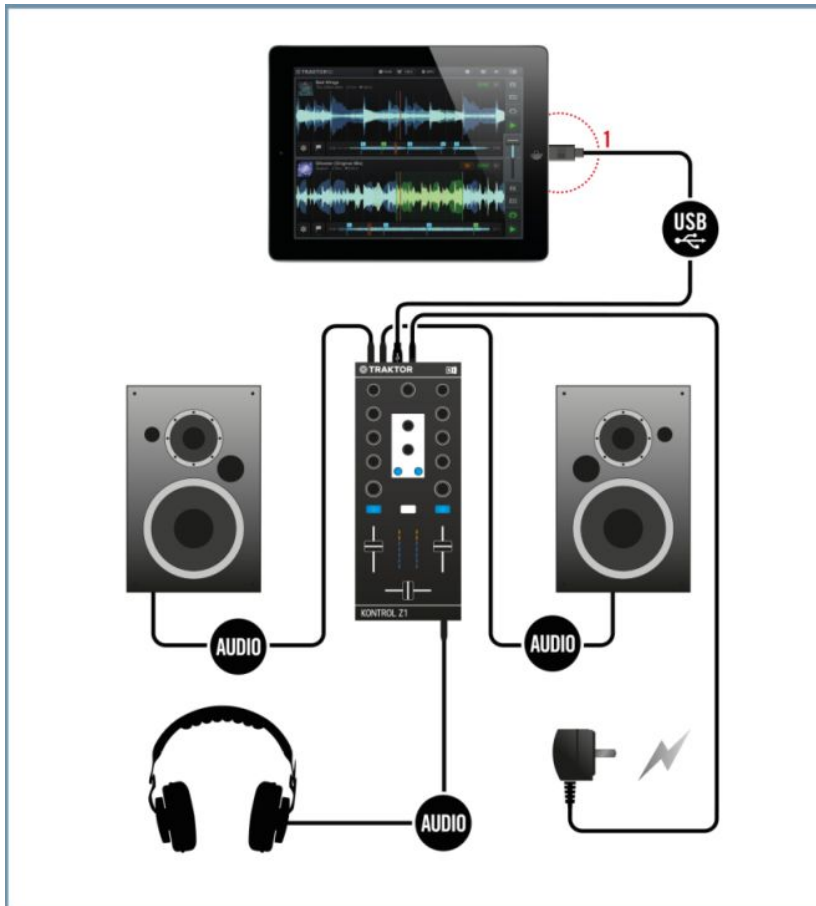

An example of a Z1 system setup using your iOS Device.

(1) The required iOS Cable connecting the iPad to the Z1



Note that iOS devices may not charge when connected to the Z1, if for example the iOS device's battery is completely discharged.

5.6 Final Preparations

It is recommended that you follow the instructions below when switching on your devices:

1. Turn on your iOS device.
2. Ensure that the TRAKTOR KONTROL Z1's power supply is connected.
3. Turn on the amplification system (active speakers or power amplifier with passive speakers).

When the software is running and you have loaded tracks to TRAKTOR DJ's Decks, gradually raise the volume controls while music is playing until a comfortable listening level is reached.



Before putting on headphones, always make sure the headphone volume control is set to minimum! Then, while playing music, slowly increase the headphone volume until it reaches the desired listening level.

5.7 Launching the TRAKTOR DJ App

1. Launch the TRAKTOR DJ app on your iOS device by tapping its icon. TRAKTOR DJ will now acknowledge the connection of the Z1. In the case of running TRAKTOR DJ on your iPad, the following dialog box will be displayed the first time the devices are connected.

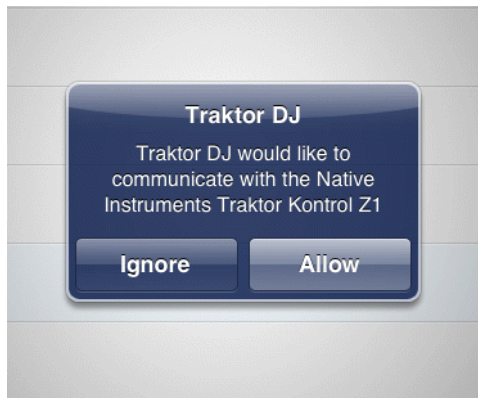

2. Tap Allow.

⇒ TRAKTOR DJ will automatically be configured with the Z1.

6 What's Next?

- For information on how to operate the Z1 and how to use it with the TRAKTOR software, please refer to the **TRAKTOR KONTROL Z1 Manual**. You can access the TRAKTOR KONTROL Z1 Manual via the Open Manual... entry from the Help menu in the TRAKTOR software.
- For information on all TRAKTOR features, refer to the **TRAKTOR Manual** and the **TRAKTOR Getting Started**. You can access these via the Open Manual... entry from the Help menu in the TRAKTOR software.

7 Troubleshooting and FAQ

This section contains some of the most frequently asked questions and answers along with references to Knowledge Base articles for additional details. In order to find an article, please visit the Native Instruments website, navigate to the Knowledge Base in the Support section and enter the article number in the search field.

7.1 Installation Folder Not Found by an Update Installer

If you have manually moved the location of a Native Instruments application on your hard drive, the installer, upon attempting to run an update, will display an error message and abort the installation. You can correct the application path in Service Center from the Overview tab. If an application cannot be found, a Locate button will appear on this tab. Click this button and browse to the actual location of the application.

7.2 Audio Clicks and Drop-outs When Playing Tracks

If you hear clicks and/or drop-outs when a track is playing, you might need to increase the latency setting of your TRAKTOR KONTROL Z1. To learn how to do this, please refer to the **TRAKTOR KONTROL Z1 Manual**, which thoroughly describes the TRAKTOR KONTROL Z1 Control Panel — the tool that allows you to adjust the audio interface settings.

7.3 More Troubleshooting Resources

If none of the suggestions in this chapter covers your problem, the TRAKTOR 2 Manual provides more detailed information on the topics discussed in this Setup Guide. Also check if the Knowledge Base has an answer:

<http://www.native-instruments.com/knowledge/>

8 Support

8.1 Knowledge Base / Online Support / Readme

To open the Knowledge Base / Online Support Form:

1. Open the Service Center application and click on the Support button in the upper right corner. Here you will find direct links to the Native Instruments **Online Knowledge Base** and the **Online Support Form**.

The Online Knowledge Base gathers useful information about your Native Instruments product and can be of great help to solve possible issues you may encounter when working with Native Instruments products.

If no Knowledge Base entry matches your problem, or if the matching entry does not solve the problem, you can use the Online Support Form to contact the Technical Support team at Native Instruments. The Online Support Form will ask you to enter information about your hardware and software setup. This information is essential for our support team to be able to provide you with quality assistance.

When communicating with the Native Instruments support team, keep in mind that the more details you can provide about your hardware, your operating system, the version of the software you are running, and the problem you are experiencing, the better they will be able to help you. In your description, you should mention:

- How to reproduce the problem
- What you have already tried to fix the problem
- A description of your setup, including all hardware
- The brand and specifications of your computer

When installing new software or software updates, a **Readme file** is included that contains late breaking news and new information that was not yet included in the documentation. Please open and read this Readme file before contacting Technical Support.

8.2 Forum

In the Native Instruments User Forum you can discuss product features directly with other users and with experts moderating the forum:

<http://www.native-instruments.com/forum>.

8.3 Updates

Whenever you encounter problems, it is recommended that you first download and install any available software updates. Updates are released regularly to fix known problems and to continuously improve the software. The version number of your software is displayed in the About dialog for any Native Instruments application. This dialog can be opened by clicking on the NI logo in the upper right corner of the user interface. Alternatively, you can find the version numbers of all installed Native Instruments applications when showing the details for an application within the Overview tab of the Service Center. Updates are available on the Update tab in Service Center or on our website under:

<http://www.native-instruments.com/updates>.

9 Product Returns

Please contact our Technical Support team prior to returning an item. If your product needs to be returned, they will assign you an RA (Return Authorization) number to expedite the processing of your return.

Contact Native Instruments Technical Support

<http://www.native-instruments.com/support>