



**INSTALLATION INFORMATION, DIRECT REPLACEMENT
EMG Models EMG-S, EMG-SA, EMG-SV, EMG-SAV, EMG COMBINATION SYSTEMS**

Specifications

Specifications	Model:			
	EMG-S	EMG-SA	EMG-SV	EMG-SAV
Logo Color	Silver	Gold	Gold	Gold
Resonant Frequency (Khz)	4.35	3.75	3.20	3.75
RMS Output Voltage	0.6	0.6	0.7	0.7
Peak Output Voltage	0.85	0.85	1.0	1.0
Output Noise (dbV)	-90	-90	-115	-90
Output Impedance (Kohm)	10	10	5.0	10
Current @ 9V (microamps).....	240	240	660	240
Battery Life (Hours).....	1000	1000	400	1000

(Specifications shown are the entire 3 Pickup System)

IMPORTANT INSTALLATION NOTES:

- 1) Only one battery is required per instrument. Adding EMG Accessories such as the EMG-SPC, RPC, EXG, PA2, PI2, etc. will not require an additional battery.
- 2) Use 9 Volt Alkaline or Lithium battery for longest life.
- 3) When battery replacement becomes necessary, remove the 4 screws from the pickguard that immediately surround the controls and selection switch. Gently lift the pickguard, replace the battery and refasten the pickguard.
- 4) Due to the low impedance design of EMG Systems the controls included are 25K Ohm, Audio Taper. This value of control is required for the system to work properly.
- 5) When installing EMG Pickups, **DO NOT** reconnect the bridge ground wire. This wire is usually soldered to a volume or tone control casing and goes to the bridge. This wire grounds the strings and uses them and your body as a shield against hum and buzz. It also creates a shock hazard. EMG Pickups are shielded internally and do not require string grounding. This greatly reduces the possibility of reverse polarity shock from microphones and the like.
- 6) EMG-S and SA Pickups have low magnetism, so sustain and string movement will not be affected by close adjustment to the strings. The EMG-SV and SAV Pickups feature pole piece magnets which can affect sustain and intonation when adjusted too closely to the strings.
- 7) If you want an installation other than those shown on this instruction sheet, you can refer to the EMG Wiring Book. If the Wiring Book is unavailable you may either phone or fax the factory for installation assistance.

Warranty:

All EMG Pickups and accessories are warranted for a period of two years. This warranty does not cover failure due to improper installation, abuse or damage. If at any time a pickup fails to work, return it postage prepaid with proof of purchase. If upon examination the pickup is determined to be defective, a replacement will be made at no charge. Warranty replacement products are covered by this same warranty. This warranty covers only those pickups and accessories sold by authorized EMG Dealers. This warranty is not transferable.



Installation procedure and diagram for EMG Systems: EMG-S, EMG-SA, EMG-SV and EMG-SAV and EMG-COMBINATION SYSTEMS.

- 1) Remove the strings.
- 2) Unscrew the output jackplate and unsolder the two wires from the output jack.
- 3) Unscrew and remove the pickguard from the body with the pickups, controls and selection switch intact.
- 4) Cut the bridge ground wire going to the vibrato cavity. It will not be reconnected. See: IMPORTANT NOTES (note 5) on page 1.
- 5) Remove all the pickups, controls and selection switch from the pickguard as a harness. Unsoldering is not necessary.
- 6) Install the EMG system onto the pickguard.
- 7) Once the control set and pickups are installed on the pickguard, plug the connectors into the pickups as shown in diagram 2.
- 8) Replace the existing output jack with the EMG output jack. With the EMG jack mounted, test the fit of the jackplate in the jack cavity with a plug inserted. Make sure the plug slides in and out easily without binding. If the fit isn't good, rotate the jack on the jackplate so that the plug will go in easily and refasten the jack to the plate.
- 9) Route the white and black wires from the volume control and the black wire of the battery clip from the control cavity to the jack cavity.

- 10) Solder the output, ground, and battery black wires to the jack as shown in the diagram.
- 11) Connect a battery to the battery clip. Wrap the battery in some foam or tape and be sure that no harness connections are in contact with the battery casing. Place it beneath tone controls.
- 12) Before fastening the pickguard and jackplate to the body, use a screwdriver and tap lightly on each pickup while plugged into an amp. If everything is working correctly, screw down the pickguard and jackplate and restring the guitar. Always unplug the guitar when not in use, this turns off the EMG system to avoid battery drain.

This completes the installation. If you have any questions, contact the factory at the number provided on the front page of these instructions. Assistance is readily available.

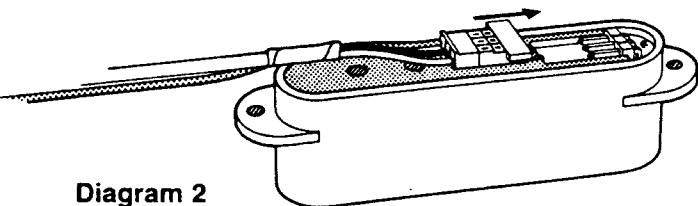

Diagram 2

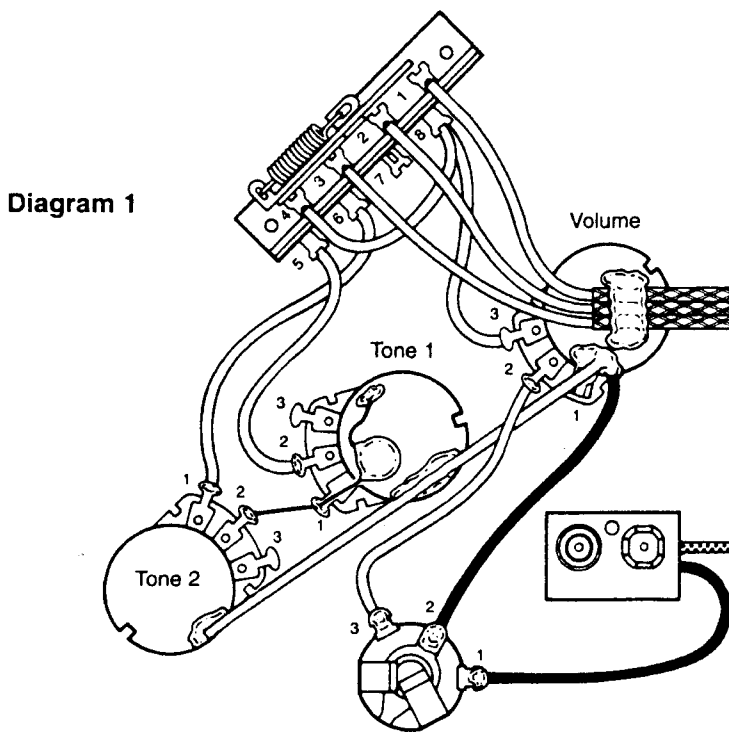
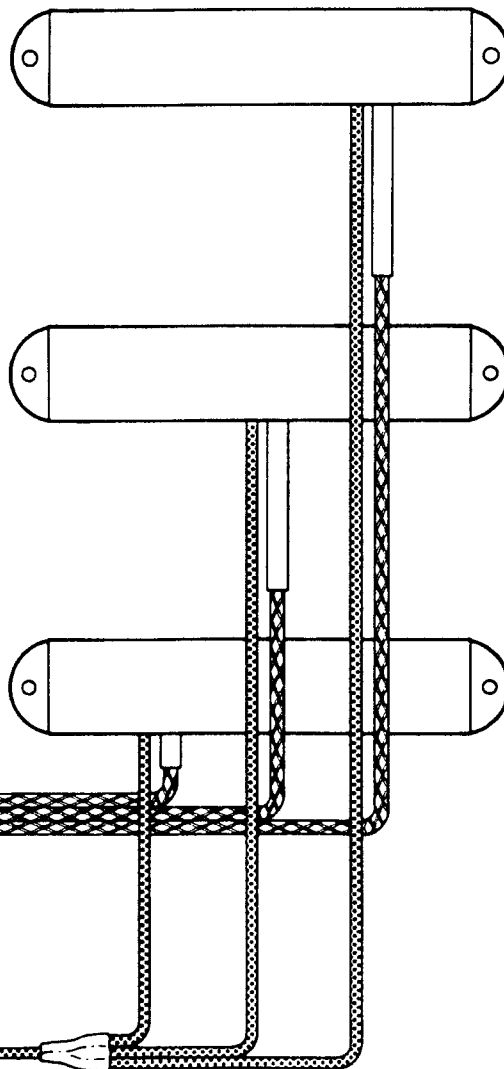

Diagram 1



Diagrams for Combination Systems including the EMG-89

Refer to Diagrams: 3A, 3B and 4

Diagram 3A

Switch up: Humbucker on,
Switch down: Single coil on

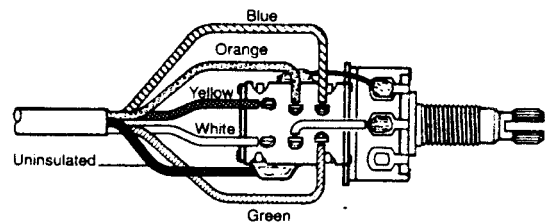
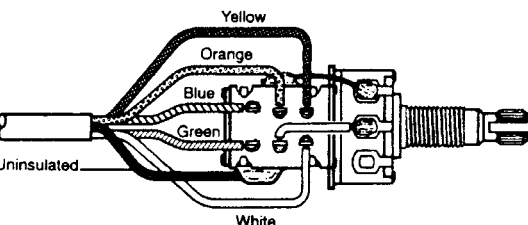

Diagram 3B

Switch up: Single coil on, Switch down: Humbucker on



The push/pull switch on the EMG-89 can be wired two different ways.

Diagram 3A shows the push/pull switch wired with the Humbucker ON in the PULL position and the Single-Coil ON in the PUSH position. This is standard factory wiring.

In Diagram 3B the push/pull switch is wired with the Single-Coil ON in the PULL

position and the Humbucker ON in the PUSH position.

Diagram 4 shows standard factory wiring for EMG Combination Systems featuring the EMG-89.

Diagram 4

Combination System with EMG-89

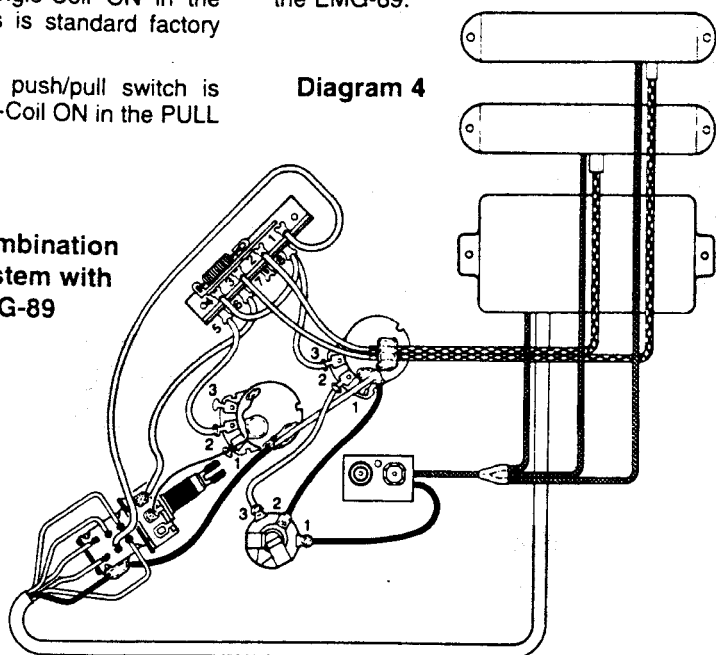

Installation Diagram for adding the EMG-SPC, RPC, or EXG Accessory to an existing harness.

Refer to Diagrams 1 and 5 Any of the EMG Accessory circuits can be added to an existing harness. Refer to Diagram 1 for the removal of the existing tone control. Diagram 5 shows Tone 1 as a master tone control while the Accessory replaces Tone 2. Refer to Diagram 1 for the removal of the existing tone control.

Tone Control Removal:

- 1) Unscrew the output jackplate and unsolder the three wires from the output jack.
- 2) Remove the strings and unscrew the pickguard from the body with the pickups and controls intact.
- 3) Removing Tone #2.
 - a) Unsolder and remove the white wire from lug 6 at the selector switch.
 - b) Cut the jumper wire between Tone 1 and Tone 2.
 - c) Cut the thick silver ground buss wire off at Tone 1.
 - d) Remove Tone 2 from the pickguard.
 - e) Unsolder and remove the white wire between lug 2 of the volume control and the output jack.

Accessory Installation: Refer to Diagram 5

- 4) Install the Accessory circuit onto the pickguard.
 - a) Solder a jumper wire between lugs 5 and 6 of the selection switch.
 - b) Solder the black wire from the Accessory to the casing of tone 1.
 - c) Solder the white wire from the Accessory to lug 2 of the volume control.
- 5) Remove the heat-shrink tubing that surrounds the red wires from the battery. Install the new piece of heat-shrink tubing onto the red battery wire then solder the red wire from the Accessory along with the red wires from the pickups and the battery. Cover the connection with the heat-shrink tubing and use light heat to shrink the tubing.

- 6) Route the green wire from the Accessory, the black wire from the volume control casing and the black wire from the battery clip to the jackplate cavity.
- 7) Solder the black wire from the battery clip to lug 1 of the jack (sleeve).
- 8) Solder the green wire to lug 3 of the jack (tip).
- 9) Solder the black wire from the volume control casing to lug 2 of the jack (ring).
- 10) Connect a battery to the battery clip. Wrap the battery in some foam or tape and be sure that no harness connections are in contact with the battery casing. Place it beneath tone controls.
- 11) Before fastening the pickguard and jackplate to the body, use a screwdriver and tap lightly on each pickup while plugged into an amp. Check the accessory circuit at the same time. If everything is working correctly, screw down the pickguard and jackplate and restring the guitar. Always unplug the guitar when not in use, this turns off the EMG system to avoid battery drain.

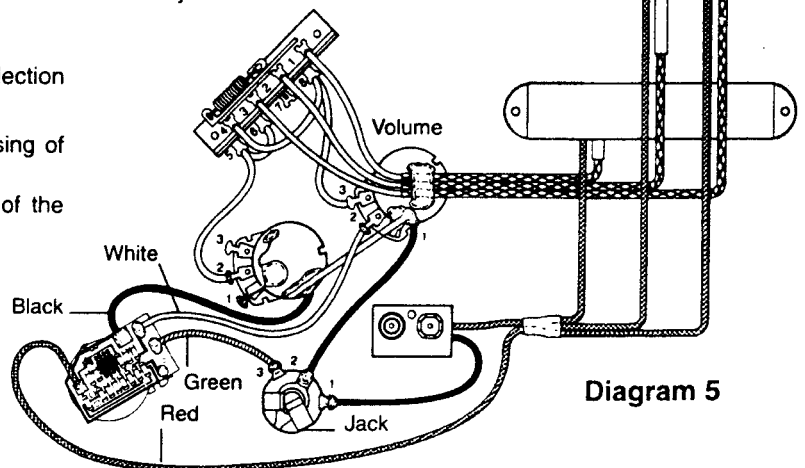

Diagram 5

Installation Diagram for adding two accessory circuits, EMG-SPC, RPC, or EXG to an existing harness.

Refer to Diagrams 1 and 6

Removing both Tone Controls:

- 1) Unscrew the output jackplate and unsolder the three wires from the output jack.
- 2) Remove the strings and unscrew the pickguard from the body with the pickups and controls intact.
- 3) Removing both Tone Controls.
 - a) Unsolder and remove the white wires from lugs 5 and 6 at the selector switch.
 - b) Unsolder and remove the thick silver ground buss wire at the volume control.
 - c) Remove Tones 1 and 2 from the pickguard.
 - d) Unsolder and remove the white wire between lug 2 of the volume control and the output jack.

Accessory Installation (2 Accessories):

Refer to Diagram 6

- 4) Mount the Accessory circuits onto the pickguard.
 - a) Solder the black wires of both the Accessory circuits to the volume control casing.
 - b) Solder the white wire of Accessory 1 to lug 2 of the volume control.
 - c) Solder the green wire of Accessory 1 to the white wire of Accessory 2 and cover this connection with heat shrink tubing.
- 5) Remove the heat-shrink tubing that surrounds the red wires from the battery. Install the new piece of heat-shrink tubing onto the red battery wire then solder the red wire

from each Accessory along with the red wires from the pickups and the battery. Cover the connection with the heat-shrink tubing and use light heat to shrink the tubing.

- 6) Route the green wire from Accessory 2, the black wire from the volume control casing and the black wire from the battery clip to the jackplate cavity.
- 7) Solder the green wire from Accessory 2 to lug 3 of the jack (tip).
- 8) Solder the black wire from the volume control casing to lug 2 of the jack (ring).
- 9) Solder the black wire from the battery clip to lug 1 of the jack (sleeve).
- 10) Connect a battery to the battery clip. Place it beneath Accessory 1 and the volume control. Wrap the battery in some foam or tape and be sure that no harness connections are in contact with the battery casing.
- 11) Before fastening the pickguard and jackplate to the body, use a screwdriver and tap lightly on each pickup while plugged into an amp. Check the accessory circuits at the same time. If everything is working correctly, screw down the pickguard and jackplate and restrung the guitar. Always unplug the guitar when not in use, this turns off the EMG system to avoid battery drain.

Diagram 6

