

Shure SLX Wireless

Smart, Hard-working Wireless

Congratulations! Welcome to Shure SLX Wireless. Your new system is rugged, reliable, easy to set up and operate, and produces outstanding audio clarity. Whether you're a vocalist, guitarist, or instrumentalist, your SLX Wireless system will show you how easy wireless can be, and how good wireless can sound.

This user guide and the Quick Setup guide included with your system will tell you all you need to know to get your system working right away.

Welcome to the world of SLX: smart, hard-working wireless.

Frequency Band Selection

Most countries closely regulate the radio frequencies used in the transmission of wireless information. These regulations state which devices can use which frequencies, and help to limit the amount of RF (radio frequency) interference in all wireless communications.

To be flexible enough to operate worldwide, SLX receivers are available in a number of models, each with a unique frequency range. Each frequency range, or band, spans up to 24 MHz of the wireless broadcast spectrum. Available bands are:

H5: 518–542 MHz	R5: 800–820 MHz
J3: 572–596 MHz	S6: 838–865 MHz
L4: 638–662 MHz	JB: 806–810 MHz
P4: 702–726 MHz	Q4: 740–752 MHz

To facilitate system setup and protect against RF interference, each system comes with multiple predefined frequency **groups** and **channels**.

When using a single SLX system, the operating frequency will generally not have to be changed. In an installation with multiple receiver/transmitter systems, each system must operate on a separate channel. The group and channel system provides an optimum frequency spread when using multiple systems.

Within a single frequency band, up to 12 individual transmitter/receiver systems may be used in a single installation. In regions where additional frequency bands are available, it is possible to operate up to 20 systems simultaneously. Check with your local Shure retailer for information on which bands are available in your area.

What Do You Want to Do Now?

Learn about your SLX4 Receiver

Power, lock/unlock, front and back panel features: See [“SLX4 Receiver Features”](#) on page 5 and [“SLX4 Receiver Programming”](#) on page 9.

Learn about your SLX2 Handheld Transmitter

Power, mute, gain, lock/unlock, other features: See [“SLX2 Handheld Transmitter”](#) on page 6 and [“SLX1 and SLX2 Transmitter Programming”](#) on page 10.

Learn about your SLX1 Bodypack Transmitter

Power, mute, gain, lock/unlock, other features: See [“SLX1 Bodypack Transmitter”](#) on page 7 and [“SLX1 and SLX2 Transmitter Programming”](#) on page 10.

Program your SLX Receiver and Transmitter

Frequency selection, LCD features, using the **select** and **menu** buttons: See [“SLX Programming”](#) on page 9.

Learn how to use multiple systems in a single installation

See [“Multiple System Setup”](#) on page 8.

Troubleshoot your SLX system

See [“Troubleshooting”](#) on page 12.

Table of Contents

System Components	4
SLX4 Receiver Features	5
SLX2 Handheld Transmitter	6
SLX1 Bodypack Transmitter	7
Single System Setup	8
Multiple System Setup	8
SLX Programming	9
SLX4 Receiver Programming	9
SLX1 and SLX2 Transmitter Programming	10
The Master Frequency List	10
Rack-Mounting SLX Receivers	11
Receiver Volume Control	12
Tips for Improving System Performance	12
Troubleshooting	12
Specifications	13
Replacement Parts and Accessories	14
Microphone Specification	132
Frequency Ranges	135
Regulatory Statements	138

System Components

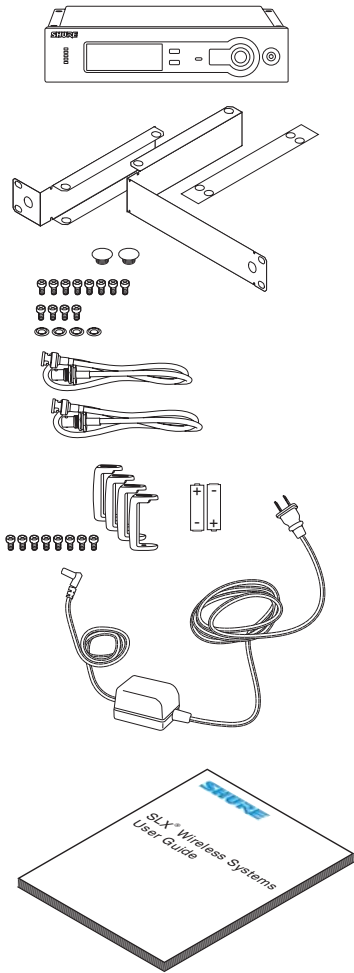

All systems include:

- SLX4 receiver
- Rack mount supplies
 - Short rack ear
 - Long rack ear
 - Link bar to mount to similar receiver
 - Extension cables and connectors for front-mounting antennas
 - 8 rack ear screws
 - 4 rack mount screws with washers
 - 2 antenna hole plugs
- Protective bumpers with 8 screws
- 2 AA batteries (4 in combo systems)
- Power supply
- User guide

Vocalist system includes:

- Microphone Head ① (choice of SM58®, SM86, Beta 58A®, Beta 87A™, or Beta 87C™)
- SLX2 handheld transmitter ②
- Microphone clip ③

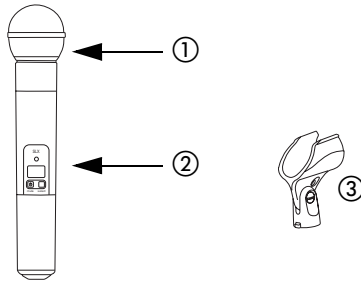

Lavalier, Headworn, and Instrument systems include:

- SLX1 bodypack transmitter
- Microphone (choice of WL93 ①, WL184 or WL185 ②, WH30 ③, or Beta 98H/C™ ④)

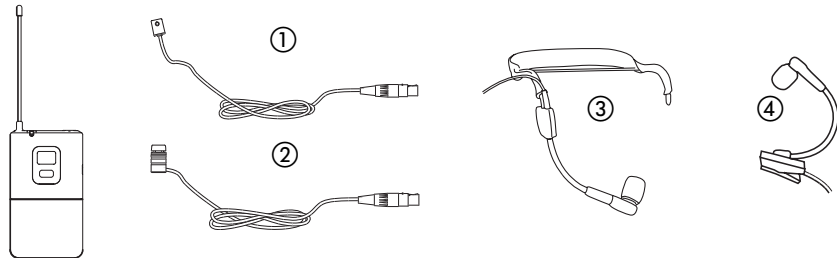

Guitar system includes:

- SLX1 bodypack transmitter
- 1/4" to mini 4-pin guitar cable

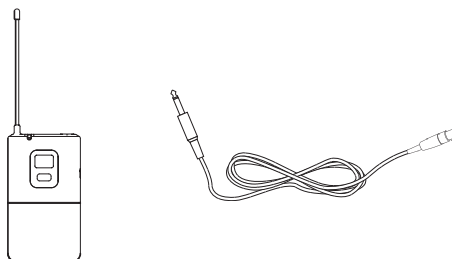

SLX4 Receiver Features

Front Panel

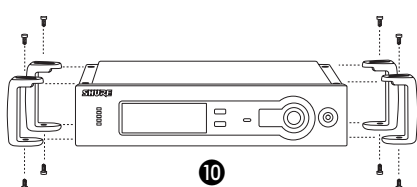
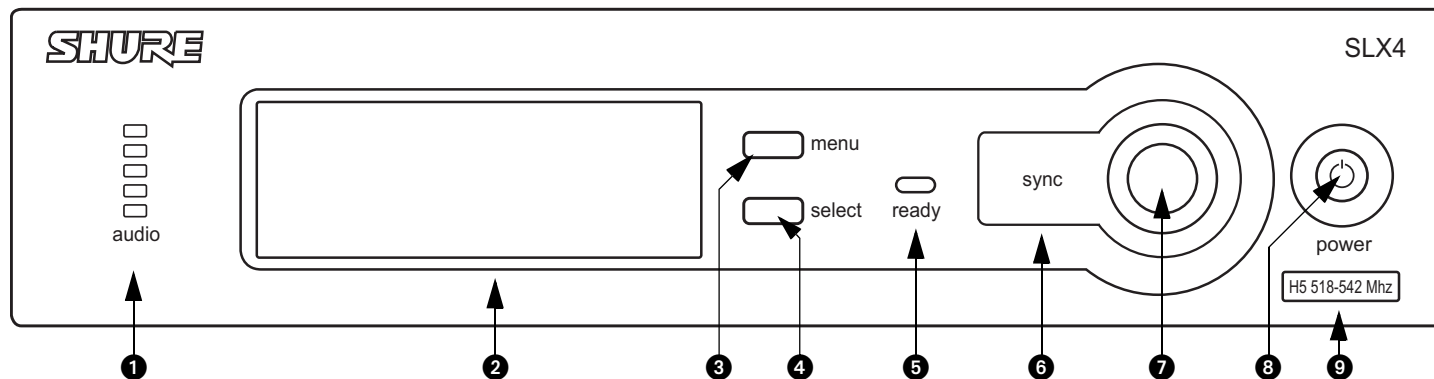

- 1** Audio LED
Indicates strength of incoming audio signal.
- 2** LCD panel
See "SLX Programming" on page 9.
- 3** Menu switch
Press to scroll through menu options. See "SLX Programming" on page 9.
- 4** Select switch
Press to select the currently displayed menu option. See "SLX Programming" on page 9.
- 5** Sync Ready Indicator
Illuminates when frequencies of receiver and transmitter are synchronized. See "SLX Programming" on page 9.
- 6** Infrared (IR) port
Broadcasts IR signal to transmitter to synchronize frequencies.
- 7** Sync Button
Press to initiate IR connection between receiver and transmitter. See "SLX Programming" on page 9.
- 8** On/Off switch
Tap to turn on, hold to turn off.
- 9** Frequency Band
Indicates the name and range of receiver frequency band.
- 10** Adding protective bumpers
Recommended if receiver is not rack mounted. Use supplied screws. For rack-mounting instructions, See "Rack-Mounting an SLX Receiver" on page 11.

Back Panel

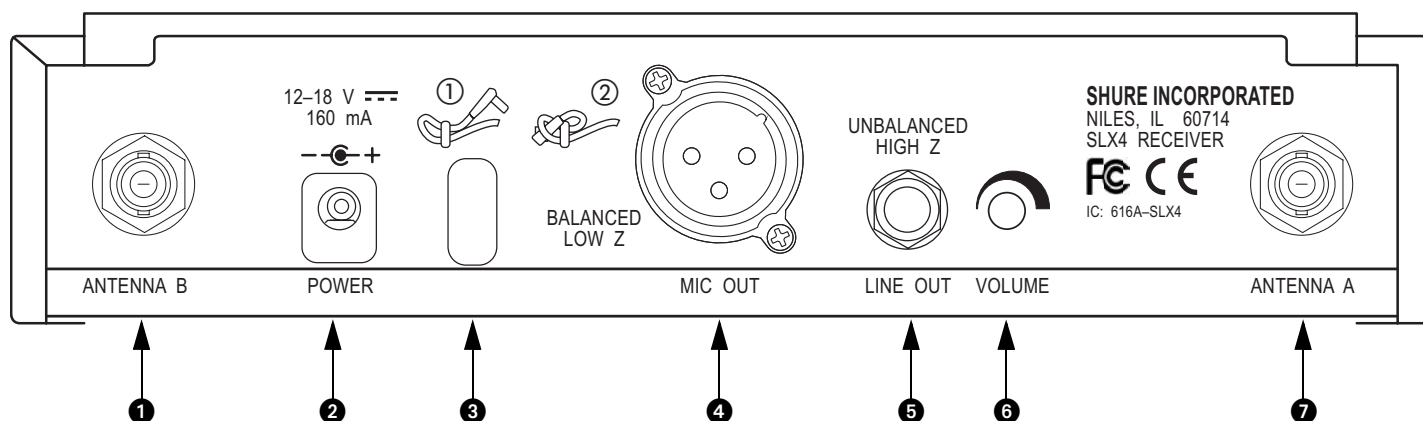

- 1** Antenna jack B
- 2** AC adapter jack
- 3** Adapter cord tie-off
Follow steps shown to secure cord to receiver body
- 4** XLR output jack
- 5** 1/4" output jack
- 6** Volume adjustment dial
Decreases receiver output level. See "Receiver Volume Control" on page 12.
- 7** Antenna jack A

SLX2 Handheld Transmitter

Features

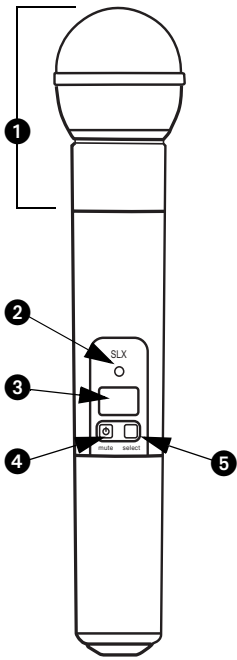

- ① Interchangeable microphone head (SM58 pictured)
- ② Power / Infrared (IR) / Mute indicator
Green: ready
Amber: mute on
Flashing red: IR transmission in process
Glowing red: battery power low
Pulsing red: battery dead (transmitter cannot be turned on until batteries are changed)
- ③ LCD screen
See "SLX1 and SLX2 Transmitter Programming" on page 10.
- ④ On-off / mute switch
Press and hold to turn on or off. Press and release to mute or unmute.

▶ **To avoid accidentally muting the microphone during a performance, lock the front panel while the microphone is in use.** See "Lock or Unlock Transmitter Settings" on page 10.

- ⑤ Select switch
See "SLX1 and SLX2 Transmitter Programming" on page 10.
- ⑥ IR port
Receives infrared beam to synchronize frequencies. **When using multiple systems, only one transmitter IR port should be exposed at a time.**

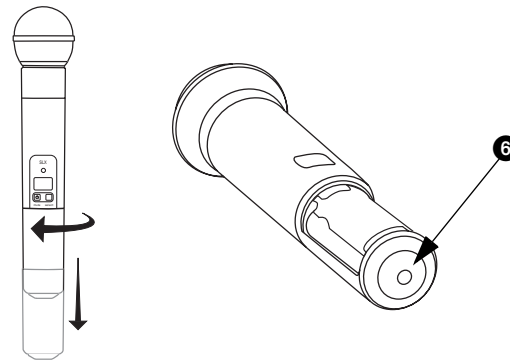
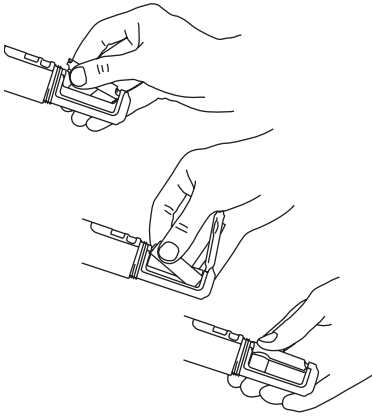

Changing Batteries

- Expected life for an Alkaline battery is approximately 8 hours.
- When the transmitter light glows red, the batteries should be changed immediately, as shown on the left.

Adjusting Gain

- Access the gain adjustment switch ① by unscrewing the head of the microphone.
- Two gain settings ② are available on the SLX2. Choose a setting appropriate for vocal volume and for the performing environment. Use the tip of a pen or a small screwdriver to move the switch.
 - **0dB:** For quiet to normal vocal performance.
 - **-10dB:** For loud vocal performance.

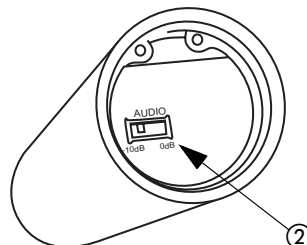
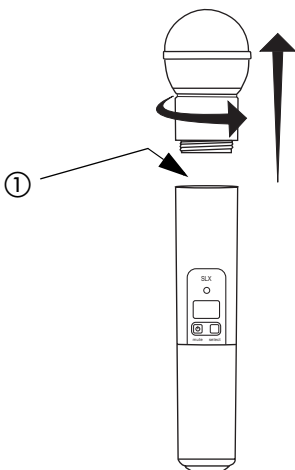

SLX1 Bodypack Transmitter

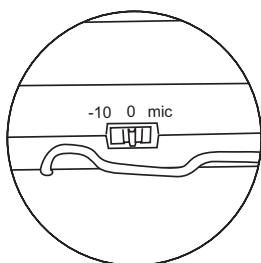
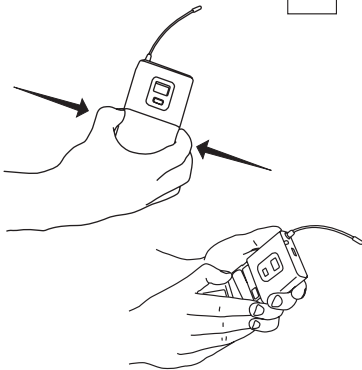
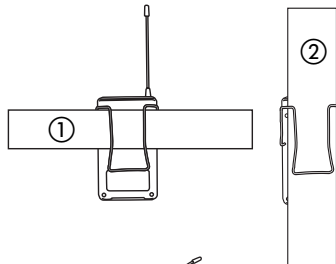
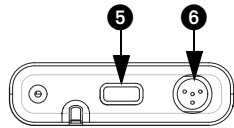
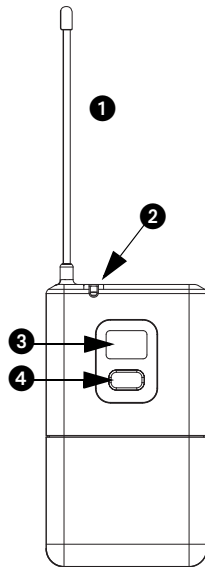

Features

- ❶ Antenna
- ❷ Power / Infrared (IR) / Mute indicator
 - Green: ready
 - Amber: mute on
 - Flashing red: IR transmission in process
 - Glowing red: battery power low
 - Pulsing red: battery dead (transmitter cannot be turned off until batteries are changed)
- ❸ LCD screen
 - See "SLX1 and SLX2 Transmitter Programming" on page 10.
- ❹ Select switch
 - See "SLX1 and SLX2 Transmitter Programming" on page 10.
- ❺ On-off / mute switch
 - Press and hold to turn on or off. Press and release to mute or unmute.
- ❻ 4-Pin Microphone Input Jack
- ❼ IR port
 - Receives infrared beam to synchronize frequencies. **When using multiple systems, only one transmitter IR port should be exposed at a time.**
- ❽ Gain adjustment switch (see below)

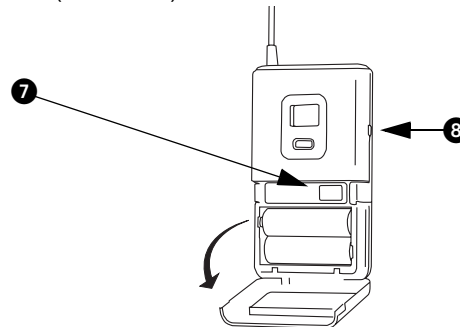

Wearing the Bodypack Transmitter

- Clip the transmitter to a belt ❶ or slide a guitar strap through the transmitter clip ❷ as shown.
- For best results, slide the transmitter until the belt ❶ is pressed against the base of the clip.

Changing Batteries

- Expected life for an Alkaline battery is approximately 8 hours.
- When the transmitter light glows red, the batteries should be changed immediately, as shown on the left.

Adjusting Gain

- Three gain settings are available on the SLX1. Choose the appropriate setting for your instrument.
 - **mic**: Microphone (higher amplification)
 - **0**: Guitar with passive pickups (medium amplification)
 - **-10**: Guitar with active pickups (lower amplification)
- If the receiver LED indicates the input volume is overloading the receiver, try switching the gain to a lower setting.

Single System Setup

Note: transmitting devices such as cellular phones and two-way radios may interfere with wireless audio transmissions. Keep your SLX transmitters and receivers away from these and other potential sources of interference.

Follow these steps when using a single SLX system:



1. Automatic Frequency Selection

Scans for an available channel and sets the receiver to that channel.

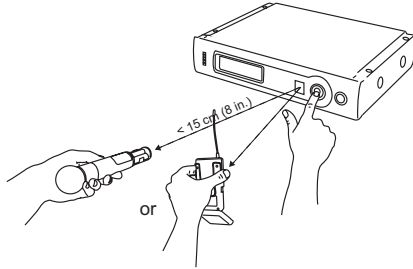

2. Automatic Transmitter Setup

Open the transmitter battery compartment to display the infrared (IR) port (see [page 6](#) and [page 7](#)).

With the IR port exposed to the receiver, press **sync**.

Multiple System Setup

Follow these steps when using multiple SLX systems in a single installation:

1. Turn all receivers **on** and all transmitters **off**.
2. Set all receivers to the same frequency group (see “[Group Selection](#)” on [page 9](#)).
3. Perform **Automatic Frequency Selection** from the Single System Setup section above.
4. Turn on the first transmitter.
5. Perform **Automatic Transmitter Setup** from the Single System Setup section above.

Repeat for each system.



Be sure that only one transmitter’s IR port is exposed when synchronizing a system.

SLX Programming

Any option displayed on screen will generally “time out” after five seconds.

SLX4 Receiver Programming



Group Selection ① **2x** ② ③

Allows manual selection of a frequency group. Pressing **select** increases the group number by one. When the correct frequency is displayed, either wait five seconds for the screen to time out, or press **sync**. For best results when operating multiple systems, set all systems to a single group; then set each system to a unique channel within that group.

For more information on frequency groups and channels, see “[Frequency Band Selection](#)” on [page 2](#).



Manual Channel Selection ① **3x** ② ③

Allows manual selection of a frequency channel. Pressing **select** increases the channel number by one. When the correct frequency is displayed, either wait five seconds for the screen to time out, or press **sync**.



Display Frequency ① **4x** ②

Displays the current frequency in MHz for approximately 5 seconds. Press and hold to increase display length.



Lock or Unlock Receiver Settings +

Hold down the **select** key and press **menu** to lock or unlock the receiver. When locked, the current receiver settings cannot be changed.



Antenna Status

Indicates RF activity. Only one antenna is active at any one time.



Transmitter Battery Status

Indicates a low transmitter battery charge.



Full Group Warning

The **FULL** warning indicates that all available channels in the currently selected group are in use. When this occurs, reprogram all systems to an alternate group.

Press either the **menu** or **select** button to exit the warning screen.

SLX1 and SLX2 Transmitter Programming

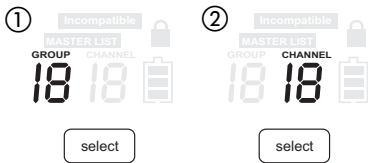

Manually Select a Group and/or Channel select 5

1. Press and hold the **select** button until the **GROUP** and **CHANNEL** displays begin to alternate.
2. To change the group setting, release the **select** button while **GROUP** is displayed ①. While **GROUP** is flashing, pressing **select** increases the group setting by one.
3. To change the channel setting, release the **select** button while **CHANNEL** is displayed ②. While **CHANNEL** is flashing, pressing **select** increases the channel setting by one.

Lock or Unlock Transmitter Settings select + 🔒

Press the **mute/🔇** and **select** buttons simultaneously to lock or unlock the transmitter settings. When locked, the current settings cannot be changed manually. **Locking the transmitter does not disable infrared synchronization.**

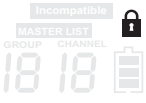

Battery Status

Indicates charge remaining in transmitter batteries.



Master List Indicator

Indicates that a master list frequency is currently in use. No group or channel information is displayed.

Note: the transmitter cannot be used to change master list settings.



INCOMPATIBLE Frequency Warning

The **INCOMPATIBLE** warning indicates that the receiver and transmitter are set to incompatible frequency bands. Contact your Shure retailer for assistance.



The Master Frequency List

Using the Master List menu + 🔒

The “Master List” of frequencies should be accessed only by experienced users in situations which call for precise frequency selection. The “Master List” is a comprehensive index of all available frequencies in 25 kHz increments. (125 kHz increments in the JB band.)

To access the Master List, hold down the **menu** button while powering on the SLX receiver.



Select Frequencies in the Master List ① menu ② select ③ select menu ④ sync

While **FREQUENCY SELECT** is flashing, the **select** button scrolls down through all available frequencies; the **menu** button scrolls up. Press and release to change the frequency in 25 kHz increments; press and hold to scroll quickly.

When the correct frequency is displayed, either wait five seconds for the screen to time out, or press **sync**.



Exit the Master List ① 2x menu ② select

To exit the Master List and return to normal system operations, press **menu**, then **select**.



Rack-Mounting an SLX Receiver

The supplied mounting hardware allows an SLX receiver to be mounted in any standard 19" audio equipment rack.

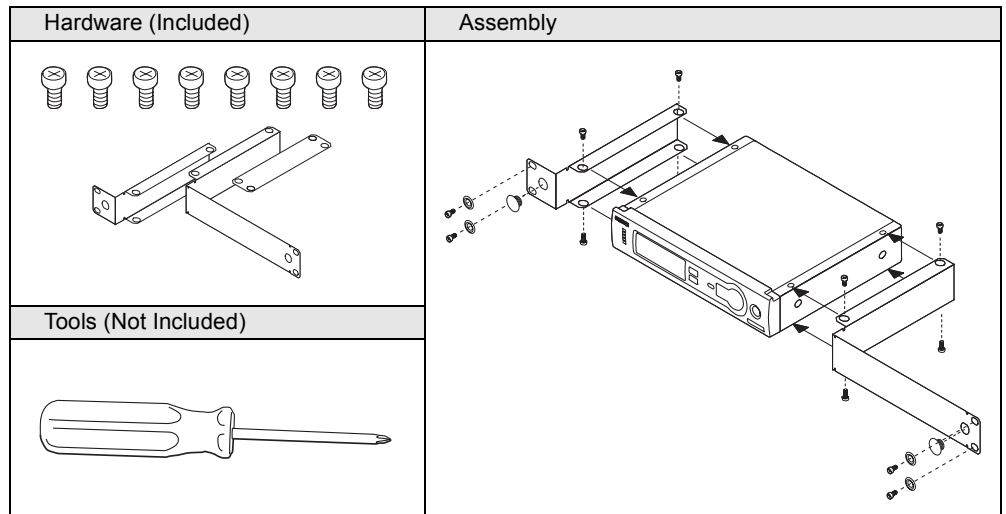

Rack-Mounting SLX Receivers

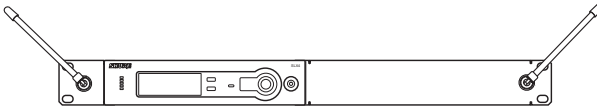
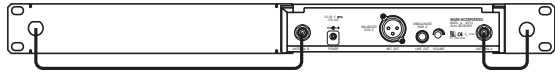
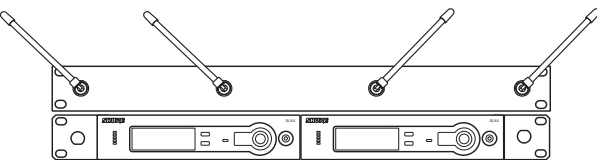
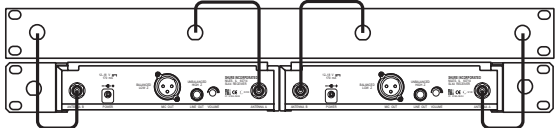
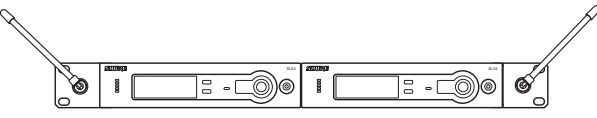
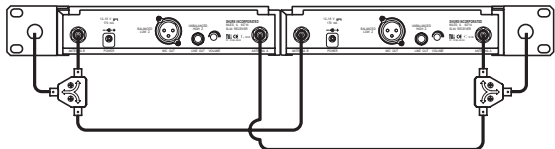
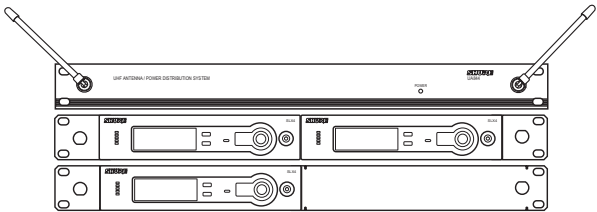
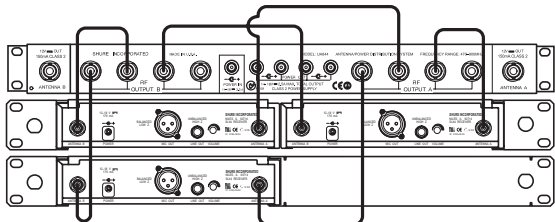
One Receiver	Wiring	Required Accessories
		<ul style="list-style-type: none"> All accessories supplied
<p>Two Receivers</p> 		<ul style="list-style-type: none"> 1 x UA440
<p>Two Receivers with UA221 Antenna Splitter/Combiner Kit</p> 		<ul style="list-style-type: none"> 1 x UA221
<p>Three or Four Receivers</p> 		<ul style="list-style-type: none"> 1 x UA844

Receiver Volume Control

The volume control dial should generally be left in the clockwise position. Turning the dial counter-clockwise decreases receiver output level.

If adjustments are necessary, use a small screwdriver to turn the dial.

Tips for Improving System Performance

- Maintain a line of sight between transmitter and antenna
- Avoid placing the receiver near metal surfaces or any digital equipment (CD players, computers, etc.)
- Secure the AC adapter cable to the receiver using the cable retainer loop
- If rack-mounting the receiver, front-mount the antennas as shown on [page 11](#).

Troubleshooting

Issue	Indicator Status	Solution
No sound or faint sound	Transmitter power light off	<ul style="list-style-type: none"> • Turn transmitter on (see pages 6 and 7) • Make sure the +/- indicators on battery match the transmitter terminals • Insert a fresh battery
	Receiver LCD off	<ul style="list-style-type: none"> • Make sure AC adapter is securely plugged into electrical outlet and into DC input connector on rear panel of receiver • Make sure AC electrical outlet works and is supplying proper voltage
	Receiver display indicates antenna activity	<ul style="list-style-type: none"> • Press mute switch on transmitter (see pages 6 and 7) • Turn up receiver volume control (see page 5) • Increase transmitter gain switch setting (see pages 6 and 7) • Check cable connection between receiver and amplifier or mixer
	Receiver display indicates no antenna activity; transmitter and receiver power lights glowing	<ul style="list-style-type: none"> • Extend receiver antennas vertically • Move receiver away from metal objects • Check for line of sight between transmitter and receiver • Move transmitter closer to receiver • Check that receiver and transmitter are using the same frequency
	Transmitter power light glowing or flashing red	<ul style="list-style-type: none"> • Replace transmitter batteries
	INCOMPATIBLE warning on transmitter	<ul style="list-style-type: none"> • The INCOMPATIBLE warning indicates that the receiver and transmitter are set to incompatible frequency bands. Contact your Shure retailer for assistance.
Distortion or unwanted noise bursts	Receiver display indicates antenna activity	<ul style="list-style-type: none"> • Remove nearby sources of RF interference (CD players, computers, digital effects, in-ear monitor systems, etc.) • Change receiver and transmitter to a different frequency (see page 9) • Reduce transmitter gain (see pages 6 and 7) • Replace transmitter battery • If using multiple systems, increase the frequency spread between systems (see page 9).
Distortion level increases gradually	Transmitter power light glowing or flashing red	<ul style="list-style-type: none"> • Replace transmitter batteries
Sound level different from cabled guitar or microphone, or when using different guitars		<ul style="list-style-type: none"> • Adjust transmitter gain (see pages 6 and 7) and receiver volume (see page 5) as necessary
FULL warning displays on receiver		<ul style="list-style-type: none"> • The FULL warning indicates that all available channels in the currently selected group are in use. When this occurs, reprogram all systems to an alternate group.
Cannot turn transmitter off	Transmitter light flashing red	<ul style="list-style-type: none"> • Replace transmitter batteries

Specifications

System

Frequency Range and Transmitter Output Level

Band	Range	Transmitter output
H5	518–542 MHz	30 mW
J3	572–596 MHz	30 mW
L4	638–662 MHz	30 mW
P4	702–726 MHz	30 mW
R5	800–820 MHz	20 mW
S6	838–865 MHz	10 mW
JB	806–810 MHz	10 mW
Q4	740–752 MHz	10 mW

NOTE: This Radio apparatus may be capable of operating on some frequencies not authorized in your region. Please contact your national authority to obtain information on authorized frequencies for wireless microphone products in your region.

Operating Range Under Typical Conditions

100m (300 ft.)

Note: actual range depends on RF signal absorption, reflection, and interference

Audio Frequency Response (+/- 2 dB)

Minimum: 45 Hz

Maximum: 15 kHz

(Overall system frequency depends on microphone element.)

Total Harmonic Distortion (ref. +/- 38 kHz deviation, 1 kHz tone)

0.5%, typical

Dynamic Range

>100 dB A-weighted

Operating Temperature Range

-18°C (0°F) to +57°C (+135°F)

Note: battery characteristics may limit this range

Transmitter Audio Polarity

Positive pressure on microphone diaphragm (or positive voltage applied to tip of WA302 phone plug) produces positive voltage on pin 2 (with respect to pin 3 of low impedance output) and the tip of the high impedance 1/4-inch output.

SLX1 Bodypack Transmitter

Audio Input Level

-10 dBV maximum at mic gain position

+10 dBV maximum at 0 dB gain position

+20 dBV maximum at -10 dB gain position

Gain Adjustment Range

30dB

Input Impedance

1 M Ω

RF Transmitter Output

30 mW maximum (dependent on applicable country regulations)

Dimensions

108 mm H x 64 mm W x 19 mm D (4.25 x 2.50 x 0.75 in.)

Weight

81 grams (3 oz.) without batteries

Housing

Molded ABS case

Power Requirements

2 "AA" size alkaline or rechargeable batteries

Battery Life

>8 hours (alkaline)

SLX2 Handheld Transmitter

Audio Input Level

+2 dBV maximum at -10dB position

-8 dBV maximum at 0dB position

Gain Adjustment Range

10dB

RF Transmitter Output

30 mW maximum (dependent on applicable country regulations)

Dimensions (including SM58 cartridge)

254 mm x 51 mm dia. (10 x 2 in.)

Weight

290 grams (10.2 oz.) without batteries

Housing

Molded PC/ABS handle and battery cup

Power Requirements

2 "AA" size alkaline or rechargeable batteries

Battery Life

>8 hours (alkaline)

SLX4 Receiver

Dimensions

42 mm H x 197 mm W x 134 mm D (1.65 x 7.76 x 5.28 in.)

Weight

816 g (1 lb. 13 oz.)

Housing

Galvanized steel

Audio Output Level (ref. +/- 38 kHz deviation with 1 kHz tone)

XLR connector (into 600 Ω load): -13 dBV

1/4 inch connector (into 3000 Ω load): -2 dBV

Output Impedance

XLR connector: 200 Ω

1/4 inch connector: 1k Ω

XLR output

Impedance balanced

Pin 1: Ground (cable shield)

Pin 2: Audio

Pin 3: No Audio

Sensitivity

-105 dBm for 12 dB SINAD, typical

Image Rejection

>70 dB, typical

Power Requirements

12–18 Vdc at 150 mA, supplied by external power supply

Replacement Parts and Accessories

Replacement Parts (all systems)

Microphone Stand Adapter (SLX2)	WA371
Zipper Bag (SLX1)	26A13
Zipper Bag (SLX2)	26A14
Short Rack Bar	53A8611
Long Rack Bar	53A8612
Link Bar	53B8443
Antenna extension cables (2)	95A9023
Protective Bumpers (SLX4 Receiver) (4)	90A8977

Replacement Parts (system-specific)

AC Adapter (120 VAC, 60 Hz)	PS20
AC Adapter (230 VAC, 50/60 Hz, Europlug)	PS20E
AC Adapter (230 VAC, 50/60 Hz, UK)	PS20UK
AC Adapter (100 VAC, 50/60 Hz)	PS20J
SM58 Head with Grille (SLX2/SM58)	RPW112
SM86 Head with Grille (SLX2/SM86)	RPW114
BETA 58 Head with Grille (SLX2/BETA 58)	RPW118
BETA 87A Head with Grille (SLX2/BETA 87A)	RPW120
Beta 87C™ Head with Grille (SLX2/Beta 87C™)	RPW122
Matte Silver Grille (SLX2/SM58)	RK143G
Matte Silver Grille (SLX2/SM86)	RPM226
Matte Silver Grille (SLX2/BETA 58)	RK265G
Matte Silver Grille (SLX2/BETA 87A)	RK313
Matte Silver Grille (SLX2/Beta 87C™)	RK312
Belt Clip	44A8030
1/4-Wave Antenna (518–752 MHz)	UA400B
1/4-Wave Antenna (748–865 MHz)	UA400

Optional Accessories

Carrying Case	WA610
Black Grille (SLX2/BETA 58)	RK323G
Black Grille (SLX2/BETA 87A)	RK324G

Antenna Combiners and Accessories

Antennas and receivers must be from the same band.

The supplied 1/4 wave antennas can be used when mounted directly to the UA844. If antennas are remote mounted, 1/2 wave antennas must be used.

Antennas and cables are for use with UA844, and cannot be used with stand-alone SLX receivers.

Passive Antenna/Splitter Combiner Kit (recommended for 2 receivers)	UA221
UHF Antenna Power Distribution Amplifier (recommended for 3 or more receivers)	
U.S.A.	UA844US
Europe	UA844E
UK	UA844UK
1/2 Wave Antenna Remote Mount Kit	UA500
1/2 wave antennas (2)	
H5 Band	UA820H
J3 Band	UA820F
L4 Band	UA820L
P4, Q4 Bands	UA820B
R5, S6, JB Bands	UA820A
25' Antenna Cable	UA825
50' Antenna Cable	UA850
100' Antenna Cable	UA100