

# ALLEN & HEATH



# XONE:DB4

## USER GUIDE

Publication AP7977

## **Limited One Year Manufacturers Warranty**

This product is warranted to be free from defects in materials or workmanship for period of one year from the date of purchase by the original owner.

To ensure a high level of performance and reliability for which this equipment has been designed and manufactured, read this User Guide before operating.

In the event of a failure, notify and return the defective unit to the place of purchase.

If this is not possible then please contact the authorised ALLEN & HEATH distributor or agent in your country as soon as possible for repair under warranty subject to the following conditions.

### **Conditions of Warranty**

The equipment has been installed and operated in accordance with the instructions in this User Guide.

The equipment has not been subject to misuse either intended or accidental, neglect, or alteration other than as described in the User Guide or Service Manual, or approved by ALLEN & HEATH.

Any necessary adjustment, alteration or repair has been carried out by an authorised ALLEN & HEATH distributor or agent.

This warranty does not cover fader wear and tear.

The defective unit is to be returned carriage prepaid to the place of purchase, an authorised ALLEN & HEATH distributor or agent with proof of purchase.

Please discuss this with the distributor or the agent before shipping.

If the unit is to be repaired in a different country to that of its purchase the repair may take longer than normal, whilst the warranty is confirmed and parts are sourced.

Units returned should be packed to avoid transit damage.

In certain territories the terms may vary. Check with your ALLEN & HEATH distributor or agent for any additional warranty which may apply.

If further assistance is required please contact Allen & Heath Ltd.

### **IMPORTANT- PLEASE READ CAREFULLY:**

**By using this Allen & Heath product and the software within it, you agree to be bound by the terms of the relevant End User Licence Agreement (EULA), a copy of which can be found on the Allen & Heath website in the product's pages. You agree to be bound by the terms of the EULA by installing, copying, or otherwise using the software.**

This product complies with the European Electromagnetic Compatibility directive 2004/108/EC and the European Low Voltage Directive 2006/95/EC.

This product has been tested to EN55103 Parts 1 & 2 1996 for use in Environments E1, E2, E3, and E4 to demonstrate compliance with the protection requirements in the European EMC directive 2004/108/EC. During some tests the specified performance figures of the product were affected. This is considered permissible and the product has been passed as acceptable for its intended use. Allen & Heath has a strict policy of ensuring all products are tested to the latest safety and EMC standards. Customers requiring more information about EMC and safety issues can contact Allen & Heath.

NOTE: Any changes or modifications to the console not approved by Allen & Heath could void the compliance of the console and therefore the users authority to operate it.

XONE:DB4 User Guide AP7977

Copyright © 2010 Allen & Heath Limited. All rights reserved

Allen & Heath Limited

Kernick Industrial Estate, Penryn, Cornwall, TR10 9LU, UK

<http://www.allen-heath.com> <http://www.XONE.co.uk>

# PACKED ITEMS

Check that you have received the following:

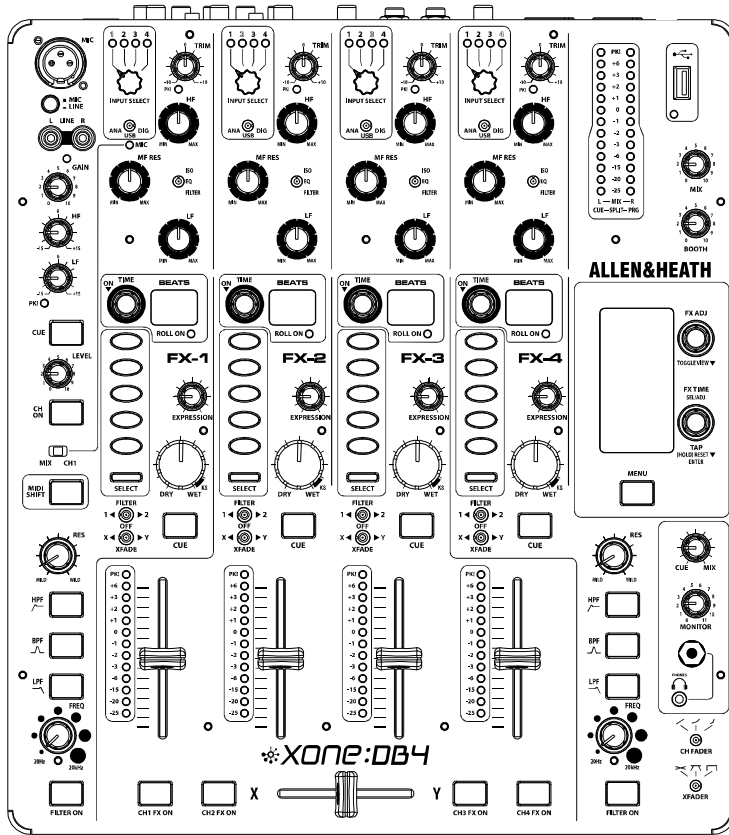

XONE:DB4 mixer.

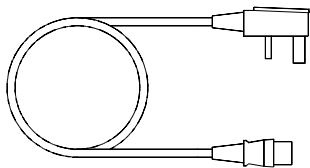

Mains Lead

Check that the correct mains plug is fitted.

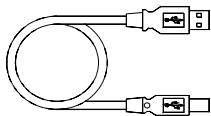

Type A-B USB Lead.

To connect the XONE:DB4 to your com-

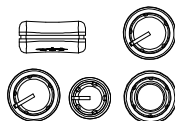

Spare knobs.

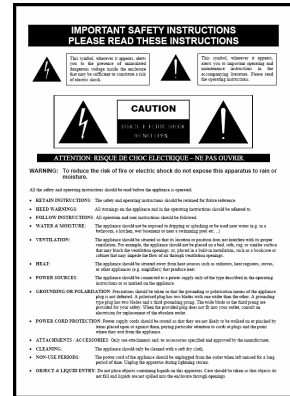

Safety Sheet.

**Important !** Read this sheet before starting.

Retain for future reference.

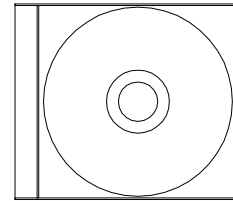

XONE:DB4 resource CD-ROM.



Carry Case.

Custom Allen & Heath protective soft bag for the XONE:DB4.

**NOTE** Always pack the mixer with the rear connector at the handle end to prevent damage if the bag is dropped heavily.

# PANEL DRAWINGS

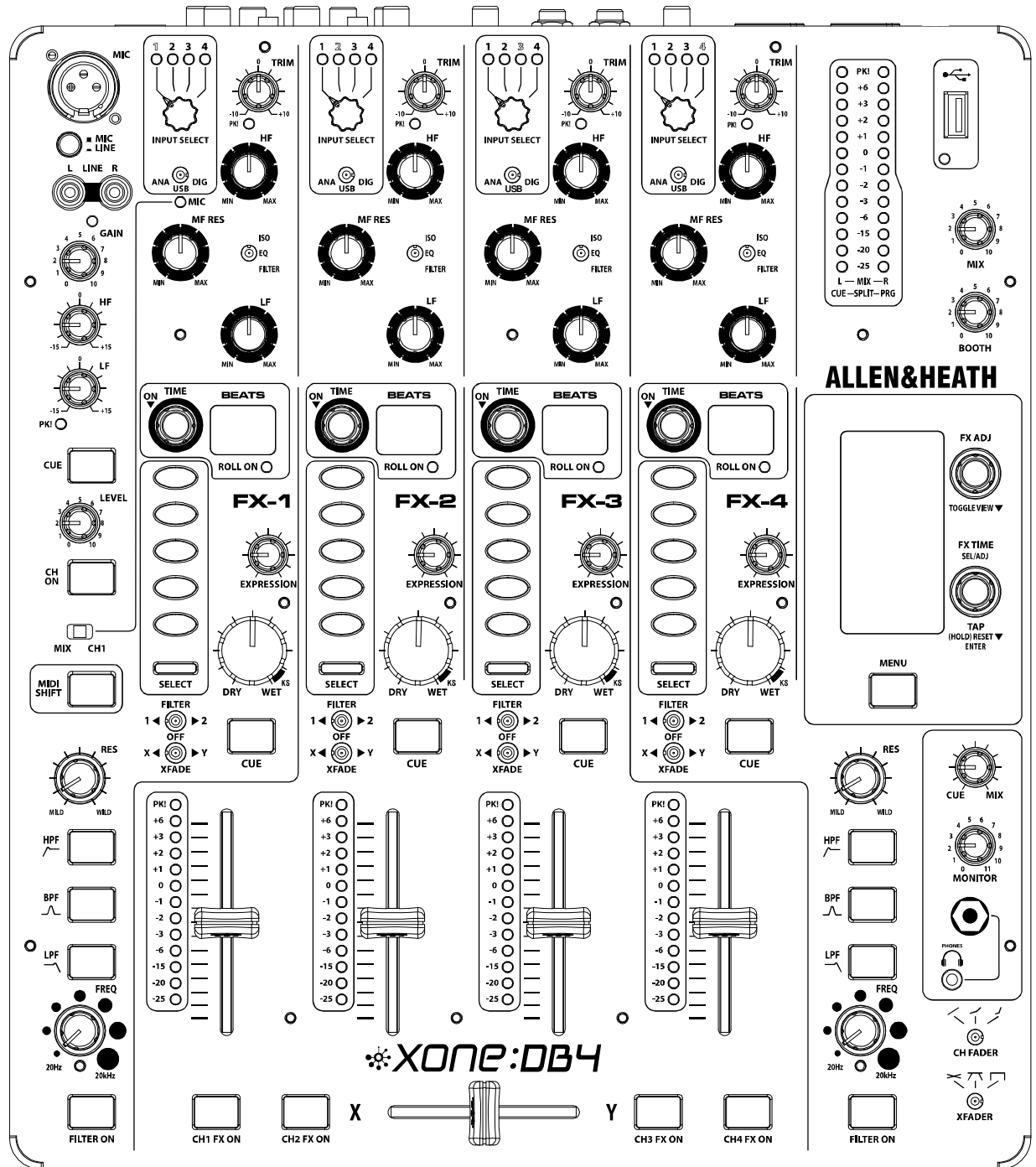
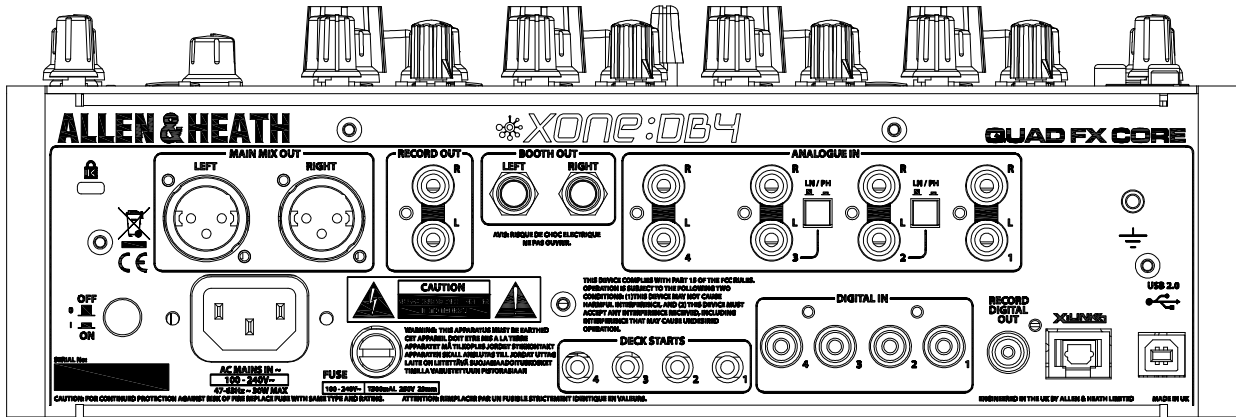

# APPLICATION DIAGRAM

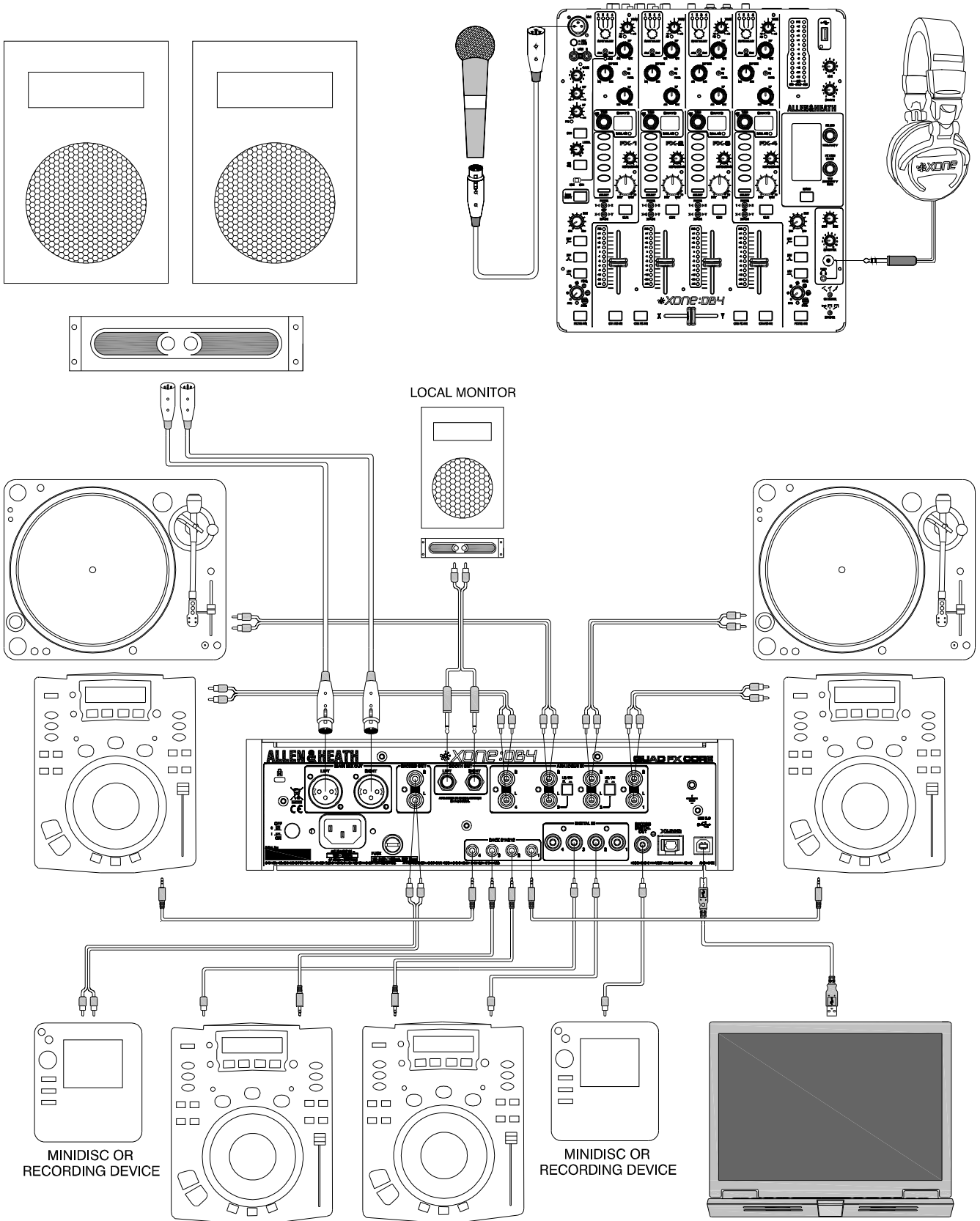

# INTRODUCTION TO THE XONE:DB4

Congratulations on the purchase of your new XONE:DB4

The XONE:DB4 is a ground-breaking mixer featuring studio quality effects and performance features that blur the boundary between DJ'ing and live production. Every feature has been meticulously researched with a view to providing you, the DJ, with the ultimate creative tool.

The DB4's quad FX core is based on the Allen & Heath iLive pro-touring console, but with FX algorithms further developed for BPM conscious parameters and tight spectral control. Many of the FX are new and unique to the DB4, and have been specifically designed to perfectly fit the DJ environment.

All the loops and FX are automatically synchronised to the tempo of the song, so it is very easy to build some amazing grooves and soundscapes without the problems of latency, low fidelity and general hassle often associated with using software and laptops.

With the flexible input matrix, any audio source can be selected on any or all of the channels; this allows for different processing to be applied to the same track on separate channels, or a phrase sampled in the looper on one channel can be added to the mix later in the track.

The XONE:DB4 is more than a mixer with an effects unit; many parameters of each effect can be altered and, along with the built in library of effects, this means that the scope for audio manipulation is almost unlimited, allowing you to develop a totally unique sound in your mixes. It is also perfectly at home in your production studio, where it can be used as a stereo multi-channel effects processor, digitally inserted into your chosen DAW, using the flexible routing options available on the built in 16 channel USB2.0 soundcard.

The XONE:DB4 is designed to be intuitive and easy to use. However, it is worth spending time reading this manual to ensure you get the maximum from it.

We have had a lot of fun designing the DB4, and we are sure you will have even more fun using it.

Best wishes

The XONE:DB4 design team

# CONTENTS

To ensure that you get the maximum benefit from your XONE:DB4 please spare a few minutes familiarising yourself with the controls and setup procedures outlined in this user guide. For further information please refer to the additional content available on our web site, or contact our technical support team.

<http://www.XONE.co.uk>

Warranty.....	2
Packed Items .....	3
Panel Drawings .....	4
Application Diagram.....	5
Introduction to the DB4.....	6
Mic/Line Channel.....	8
Music Channels .....	10
Filter System.....	12
Master Section.....	13
The Input Matrix .....	15
The Music Channel EQ Section .....	16
The Looper Section.....	17
The Channel FX Section.....	18
Loading alternative FX .....	19
The FX Display and Focus.....	20
Kill Send and Delay Millisecond .....	21
BPM Engines .....	22
Mixer Setup Menu.....	23
Firmware Updating .....	26
USB Audio System.....	27
PC Driver Installation.....	30
Mac Driver Installation.....	33
MIDI Control .....	36
MIDI Control Messages .....	37
Digital In/Out and X-Link.....	40
Information on System Earthing.....	41
Specifications.....	42
Registration Card.....	43

# MIC / LINE CHANNEL

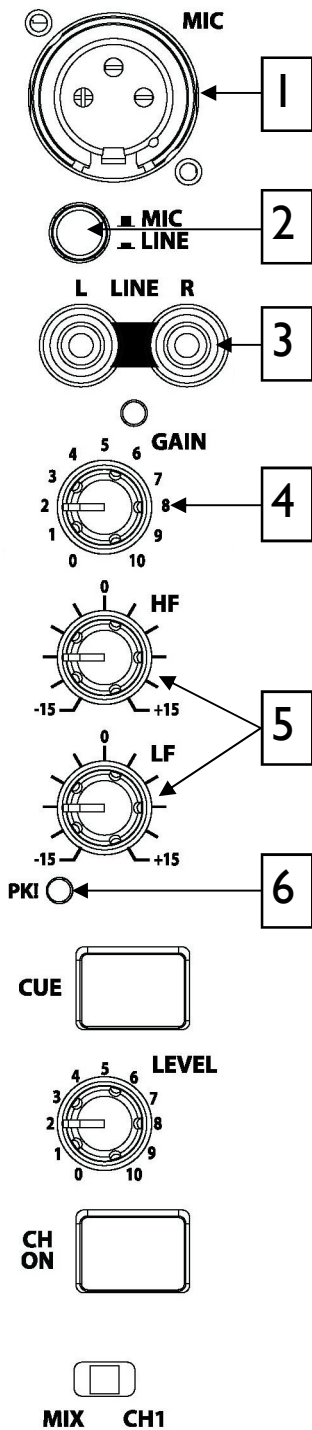

1

## MICROPHONE INPUT CONNECTOR

Balanced XLR. Plug in a DJ, guest or announcement microphone here. Use a good quality low impedance dynamic mic such as those specifically designed for vocals. Do not use high impedance or unbalanced microphones, or condenser types which require phantom power.

Use the best professional grade balanced cables and connectors you can afford, as these are typically subject to intense use and abuse in the club environment.

2

## MIC / LINE SELECTOR SWITCH

Selects the channel source between MONO Microphone and STEREO Line input connectors

3

## LINE INPUT CONNECTOR

Dual RCA sockets for connecting an external line level source.

4

## GAIN CONTROL

Sets the level of the source signal to the channel.

5

## MIC EQ Controls

The MIC equaliser provides a tool to adjust the tonal quality of the sound to correct source problems such as microphone response, proximity effect, noise and feedback, to help the voice cut through the mix, or to adjust the overall 'feel'. Start with the EQ controls set to their mid (flat) position, then adjust to achieve the desired sound.

6

## CHANNEL PEAK LED

Illuminates if the channel signal is within 3dB of clipping.



# MIC / LINE CHANNEL

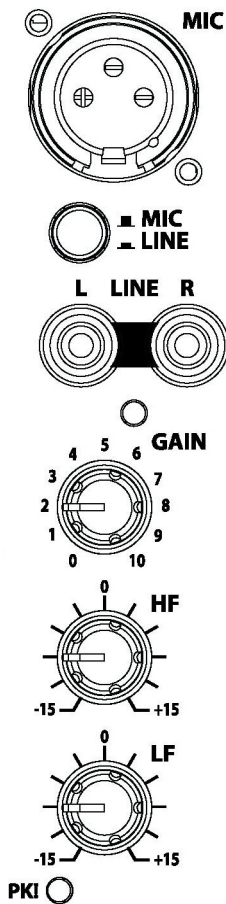

7

## CHANNEL CUE SWITCH

Press the Cue switch to listen to the channel pre-fade signal in the headphones and view its level on the main meters. The backlit switch lights red when selected. Press the switch again to deselect cue.

8

## CHANNEL LEVEL CONTROL

Sets the level of the channel signal in the main mix.

9

## CHANNEL ON SWITCH

Turns the channel on, allowing the channel signal to be routed to the main mix. This feature is very useful if a microphone is being used as it can be switched in and out of the mix.

10

## MIX / CH1 SWITCH

Selects where the channel output will be routed:

MIX - Routes the signal directly to the mix

CH1 - Routes the signal to the input of Channel 1

If the switch is set to CH1, the 'MIC' LED will illuminate in Channel 1, overriding the matrix input to that channel. This will enable loops and effects to be applied to the microphone input.

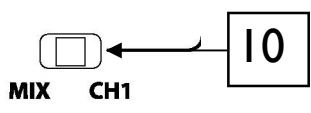
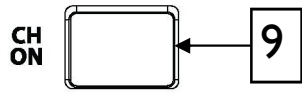
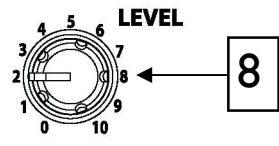
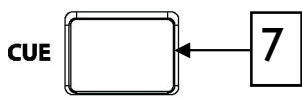

# MUSIC CHANNEL

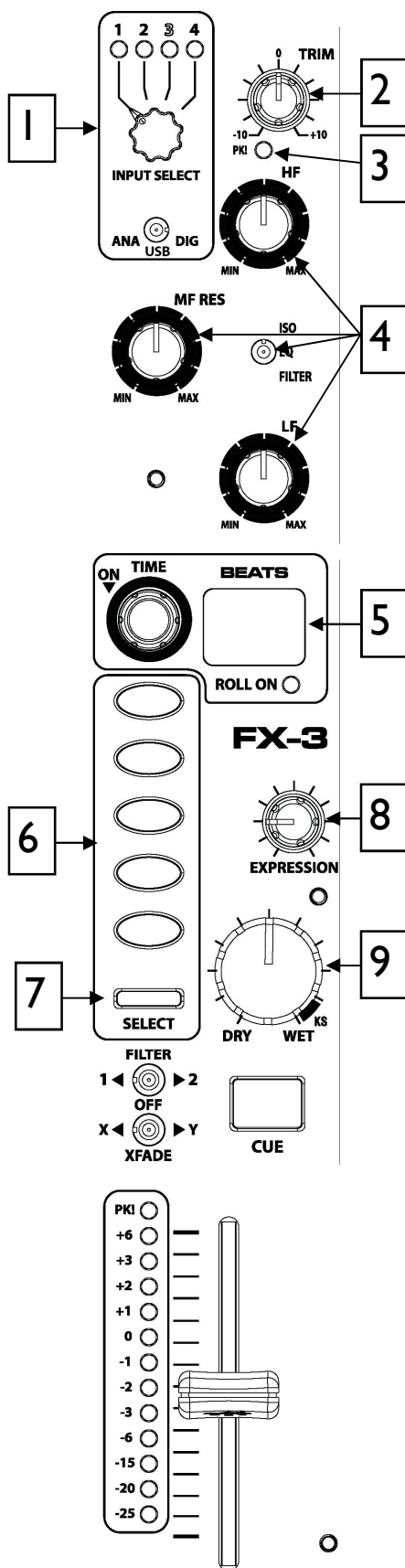

- 1 MATRIX INPUT SELECTOR**

Please refer to Page 15 for further information on how to use this feature.
- 2 INPUT TRIM**

Amplifies or attenuates the input signal by up to  $\pm 10$  dB.
- 3 INPUT PEAK LED**

Illuminates if input signal is within 3dB of clipping. If this happens lower the Trim level.
- 4 EQ SECTION**

Configured as either Three band EQ or High-Pass/Low-Pass filter depending on switch position. Please refer to Page 16 for further details on this feature.
- 5 LOOP RECORDER**

Records and automatically loops input source when activated. Display shows loop length, and beat detection activity. Please refer to Page 17 for further details on this feature.
- 6 FX TYPE SELECT BUTTONS**

Selects one of the five basic effects types. Each selection overrides the previous one. Buttons will illuminate green to show effect selected or orange when channel is in focus. Please refer to Page 18 for further details on this feature.
- 7 FX SELECT**

Press to move focus to channel. If the channel has focus then press to open FX library Please refer to Page 18 for further details on this feature.
- 8 FX EXPRESSION CONTROL**

Changes one parameter of selected FX, e.g. regeneration if delay selected. Please refer to Page 18 for further details on this feature.
- 9 FX WET/DRY CONTROL**

The WET/DRY control sets the level of the effect from no effect (DRY) when fully anticlockwise to maximum effect (WET) when fully clockwise. Please refer to Page 18 for further details on this feature.

# MUSIC CHANNEL

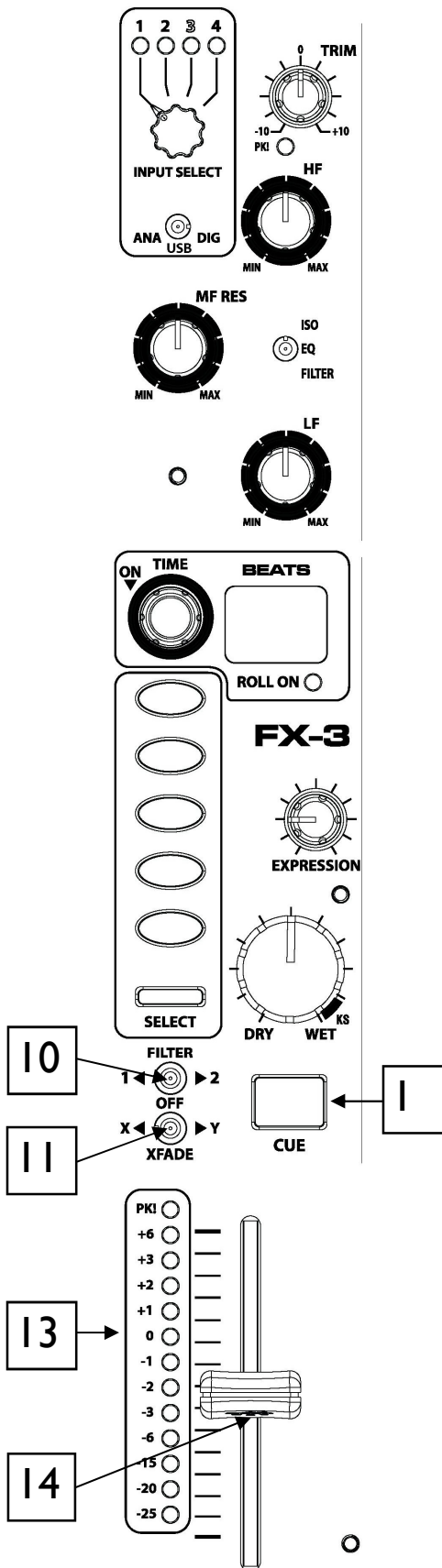

## 10 FILTER ASSIGN SWITCH

Set the 3-position switch to its mid position to route the signal direct to the mix, or to its left or right positions to route the signal to Filter-1 or Filter-2 respectively. See page 12 for more information on the filter system.

## 11 X-FADE ASSIGN SWITCH

Set the 3-position switch to its mid position to route the signal direct to the mix, or to its left or right positions to route the signal to Crossfade-X or Crossfade-Y respectively.

## 12 CHANNEL CUE SWITCH

Press the cue switch to listen to the channel pre-fade signal in the headphones and see its level on the main meters. The button will illuminate when selected.

Press the switch to deselect cue. The switches are interlocked; pressing another one turns off the previous selection.

Multiple cueing may be achieved in one of two ways:

1. Pressing two or more cues simultaneously.
2. Holding down an active cue allows momentary activation of any other cue when pressed.

## 13 CHANNEL METER

Displays the channel signal level. It is post-EQ, post-FX, and pre-fader.

The channel level control should be set so that the channel meter averages around '0', with loudest peaks no higher than '+6'. Turn down the Trim control if the **PK!** indicator lights.

## 14 CHANNEL FADER

A high quality, smooth travel, dual-rail fader adjusts the channel signal level from fully off to fully on.

# FILTERS

The XONE:DB4 is equipped with a dual, swept filter system, that emulates the analogue filters that have been a key feature on most XONE products. The filters can be used as a mix tool, or to create dynamic effects. Each music channel has a 3-position toggle switch allowing the channel to be routed to either one of the two filter systems, or directly to the mix.

On power up the filters always default to Low-Pass, but any combination of the three filters types can be achieved by simultaneously pressing the filter type buttons. The frequency sweep control sets the cut-off point of the filter, and the resonance alters the Q. A flat frequency response is achieved when the Frequency Sweep control is fully clockwise (LPF) or fully anticlockwise (HPF), with the Resonance control set to its midpoint.

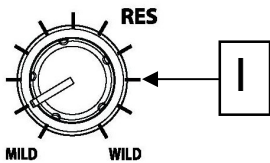

1

## Resonance Control

This produces the classic analogue VCF sound by feeding some of the filter output back to its input. The control ranges from 'mild' producing a very subtle effect, to 'wild' producing a dramatic phase effect.

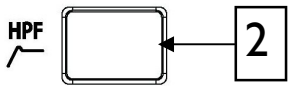

2

## HPF Button

Turns on the high pass (bass cut) filter slope. The button will illuminate when selected.

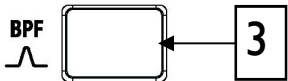

3

## BPF Button

Turns on the band pass (bell shaped) filter slope. The button will illuminate when selected.

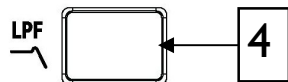

4

## LPF Button

Turns on the low pass (treble cut) filter slope. The button will illuminate when selected.

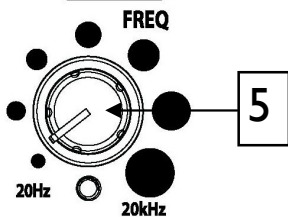

5

## Frequency Sweep Control

This control sets the cut-off frequency of the filter. It ranges from very low frequency (20Hz) to very high (20kHz).

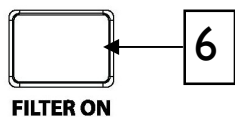

6

## Filter On Switch

Switches the filter on and off. The button will illuminate when selected.

## ADVANCED BUTTON MODES

Any frequency band select button ([2], [3] and [4]) can be momentarily selected along with the currently active band. To do this, hold down the button of the band that is currently active and then press the button of the band to be momentarily selected. Multiple filter bands may be selected by pressing the band buttons simultaneously. Releasing the band buttons simultaneously will store the selection.

To turn on the filter, press the relevant FILTER ON switch [6]. This switch has two modes of operation, latching and momentary. To latch the switch ON, tap once. To briefly switch ON a filter, press and hold the button; the filter will turn off on release. This function also works the other way, so if a filter is ON, pressing and holding the button will turn the filter off until the button is released.

# MASTER SECTION

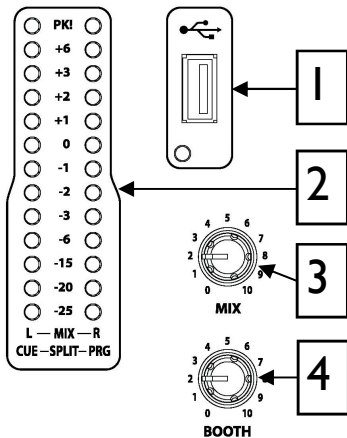

1

## USB A TYPE SOCKET

Allows insertion of a USB memory stick for the purposes of loading and saving settings and for Firmware updates. See Page 26 for information on Firmware updating.

**We strongly recommend that you use a dedicated USB flash drive for loading and saving settings.**

2

## MIX / MONITOR METERS

The main meters follow the selected monitor source. The meter reads '0' for an XLR output of +4dBu. The mixer should be operated with these meters averaging around '0' with loudest peaks no higher than '+6'.

In SPLIT CUE mode, whilst a channel cue button is pressed, the left meter will display the CUE level and the right meter will display the PROGRAM (PRG) level. For more about CUE modes please see "Headphone Setup" on Page 24.

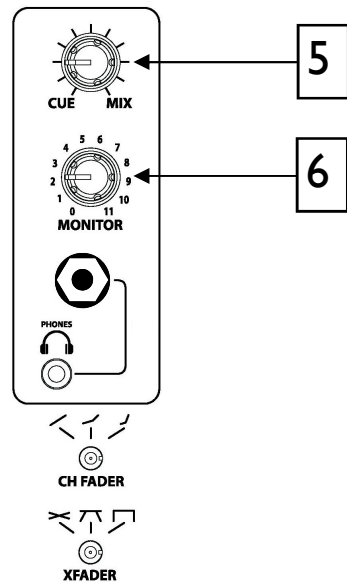

3

## MIX MASTER LEVEL CONTROL

A rotary master control adjusts the level of the main mix XLR outputs feeding the house sound system. This does not affect the monitor output or the meter reading.

4

## BOOTH MASTER LEVEL CONTROL

Adjusts the level of the signal to the stereo monitor RCA output. This does not affect the headphones. The monitor output could be used for a booth monitor, recording or an additional zone feed.

5

## CUE / ADD MIX CONTROL

Pans between Cue signal and the Main Mix output. Turned fully anti-clockwise, only the active Cue signal is heard through the headphones when a Cue is selected. Gradually turning clockwise introduces the Main Mix output to the Cue signal until, fully clockwise, only the Mix is heard. This does not affect the meters. Split Mode pans Left (Cue) to Right (Mix), see Page 24.

6

## MONITOR LEVEL CONTROL

Adjusts the level of the headphone signal. The headphone level can be further trimmed up or down in level in the Setup Menu: see Page 24.



**Warning !** To avoid damage to your hearing do not operate the headphones or sound system at excessively high volume. Continued exposure to high volume sound can cause frequency selective or wide range hearing loss.

# MASTER SECTION

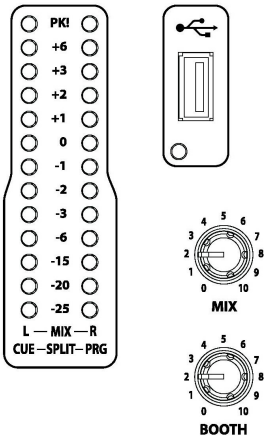

## 7 HEADPHONES OUTPUTS

Stereo 1/4" TRS jack and 3.5mm mini-jack. Plug in good quality stereo headphones intended for DJ monitoring. Use closed-ear headphones that provide maximum acoustic isolation when cueing your sources. We recommend that you use high quality headphones rated between 30 to 100 ohms impedance. 8 ohm headphones are not recommended as their very low impedance may cause damage to the headphone amplifier.

## 8 CHANNEL FADER CURVE SELECT

Sets the response of the Channel Up faders. Choose a setting that best suits the style of music you play.

## 9 CROSSFADER CURVE SELECT

Sets the response of the Crossfader curve, from dipped, dipless, and fast-cut, better suited to scratching.

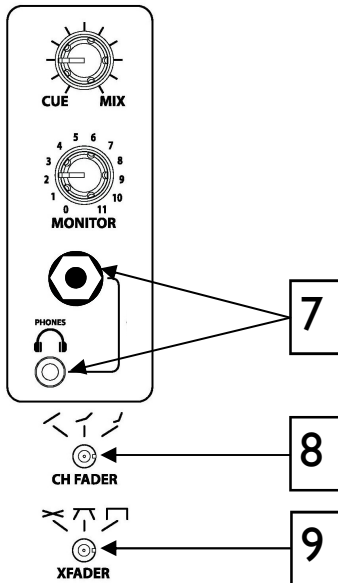

# THE INPUT MATRIX

Each music channel on the XONE:DB4 features an input matrix system, making it possible to select from any of the twelve available sources no matter which input socket they are physically connected to.

Each channel can accept inputs in three formats:

**ANALOGUE**      *Channel 1* - Line or Microphone (Microphone selected on front panel)  
*Channel 2* - Line or Phono (Selector switch on rear panel)  
*Channel 3* - Line or Phono (Selector switch on rear panel)  
*Channel 4* - Line only

**USB**              *Channel 1* - ASIO Soundcard Output 1-2  
*Channel 2* - ASIO Soundcard Output 3-4  
*Channel 3* - ASIO Soundcard Output 5-6  
*Channel 4* - ASIO Soundcard Output 7-8

**DIGITAL**         S/PDIF Input 1 - 4 via RCA on rear panel.

## Example Usage

Using the matrix, a CD player plugged into Analogue Input 4 of your mixer can be routed to Channel 1 by setting the Toggle Switch to 'ANA' and the Input Select Rotary to '4', or can be assigned to all four channels simultaneously by repeating the process on all input channels.

Alternatively, if you wish to select your source to be DAW Soundcard Outputs 5-6, set the Toggle Switch to 'USB' and the Input Select Rotary to '3'.

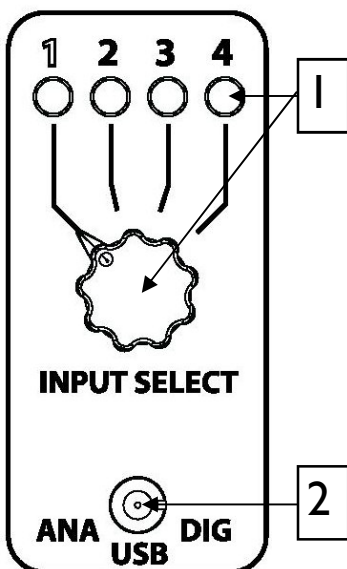

### INPUT SELECTION

Turn the 4-position rotary switch to select one of the four available input sources.

The green LED will illuminate to show which is the currently selected source.

### INPUT SOURCE SELECT SWITCH

Toggle switch allowing selection between Analogue (ANA), USB and DIGITAL (DIG) sources.

# THE EQ SECTION

The music channel EQ Section on the XONE:DB4 can operate in one of three different modes. Each mode is indicated by the colour of the illuminated control knob pointers.

## ISOLATOR MODE

In this mode, the EQ provides full attenuation when fully anti-clockwise and a safe +6dB of boost when fully clockwise. This EQ offers a steep 24dB/octave slope for tight frequency isolation. In isolator mode the EQ knob pointers are illuminated BLUE.

## EQ MODE

In this mode, the EQ provides -26dB of attenuation and +6dB of boost. This EQ has a gentler 12dB/octave slope better suited to certain styles of music. In EQ mode the knob pointers are illuminated RED.

## FILTER MODE

In FILTER MODE, the EQ section becomes a high and low pass filter system with adjustable resonance, offering precise control over the frequency spectrum. The filters have a 12dB/octave slope. The HF and LF knob pointers illuminate BLUE, and the MF RED. The MF pot controls the resonance, or “sharpness” (Q) of the filter.

### 1 HF CONTROL

Adjusts the high frequency content of the channel audio. In **ISO** or **EQ** mode the centre-detent position will give a flat frequency response, fully clockwise will boost the high frequencies by 6dB, and anticlockwise will attenuate them.

In **FILTER** mode this control becomes a low-pass filter, and must be rotated fully clockwise for a flat frequency response. Rotating anticlockwise will progressively lower the cut-off frequency of the filter.

### 2 MF/RES CONTROL

Adjusts the mid range frequency content of the channel audio. In **ISO** or **EQ** mode the centre-detent position will give a flat frequency response, fully clockwise will boost the mid frequencies by 6dB, and anticlockwise will attenuate them.

In **FILTER** mode this control sets the sharpness (Q) or resonance of the two filters. Rotate fully anticlockwise for low resonance, and fully clockwise for high resonance. Use this control with care as a high resonance will boost the signal level at the Filter cut-off point which could cause the signal to clip.

### 3 LF CONTROL

Adjusts the low frequency content of the channel audio. In **ISO** or **EQ** mode the centre-detent position will give a flat frequency response, fully clockwise will boost the low frequencies by 6dB, and anticlockwise will attenuate them.

In **FILTER** mode this control becomes a high-pass filter, and must be rotated fully anticlockwise for a flat frequency response. Rotating clockwise will progressively raise the cut-off frequency of the filter.

### 4 MODE SELECT SWITCH

Use to select the desired EQ mode. As each mode is selected the illuminated pointer on the control knobs will change colour:

All Blue in **ISOLATOR** mode

All Red in **EQ** Mode

Two Blue, one Red (RES control) in **FILTER** mode

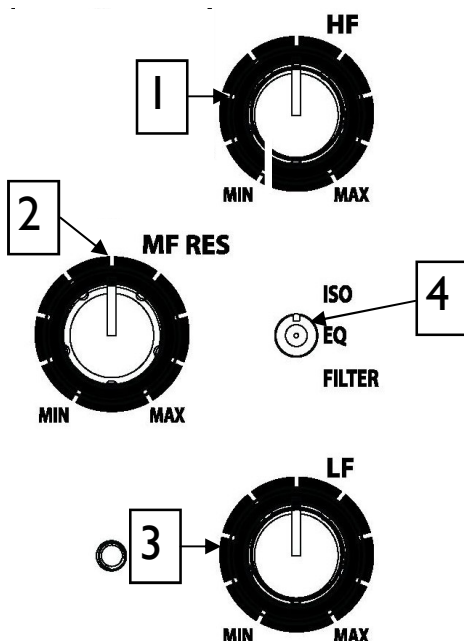



# LOOPER SECTION

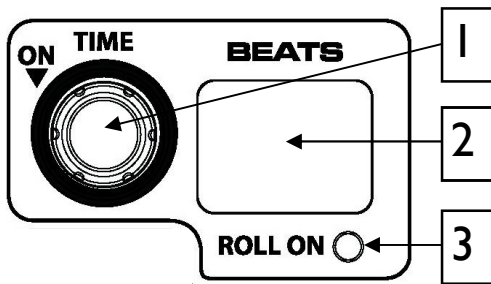

The LOOP section of the XONE:DB4 provides automatic looping of the source audio for up to FOUR bars at 60BPM or above. Even if the loop length is set to loop after one bar for instance, the audio will continue to be recorded for the maximum four bars, allowing you to expand the loop if desired. The loop length is non-destructive and can be expanded or contracted at will. Loops are not stored in memory so turning the looper off, or powering down the mixer will erase the current loop.

The looper on the XONE:DB4 operates in ROLL mode, meaning that the source material will continue playing even though you will only hear the loop.

1

## ◀▶ LOOP TIME ADJUST CONTROL

Adjusts the length of the loop according to the value shown in the loop display window. The loop can be adjusted from 4 bars to 1/16th of a beat (displayed as “-1”). Clockwise rotation of the control doubles the loop length, anti-clockwise rotation of the control halves the loop length.

### ▼ LOOP ON

Pressing the top of the encoder will turn the looper on. When the looper is active the input source and channel Trim control are by-passed, however the loop can be further processed by the EQ, and the channel FX unit.

The loop switch has two modes of operation:

**LATCHING ACTIVATION** - A short tap on the switch latches the loop on. The loop is turned off by the same action.

**MOMENTARY ACTIVATION** - Pushing and holding the switch will turn the loop on, releasing the switch will automatically turn the loop off.

2

## LOOP DISPLAY

The Loop Display is comprised of two seven-segment displays. The display shows the loop length that is currently selected.

4-	= 4 bars	21	= 2 beats	14	= 1/4 beat
2-	= 2 bars	11	= 1 beat	18	= 1/8 beat
1-	= 1 bar	12	= 1/2 beat	-1	= 1/16th beat

The decimal point of the right hand seven-segment display shows current BPM activity. The beat detection process is automatic and is discussed in greater detail on Page 22.

3

## ROLL ON LED

Illuminates whilst the loop is active. A small “L” will also appear in the main mixer BPM display window when a loop is active.

# THE FX SECTION

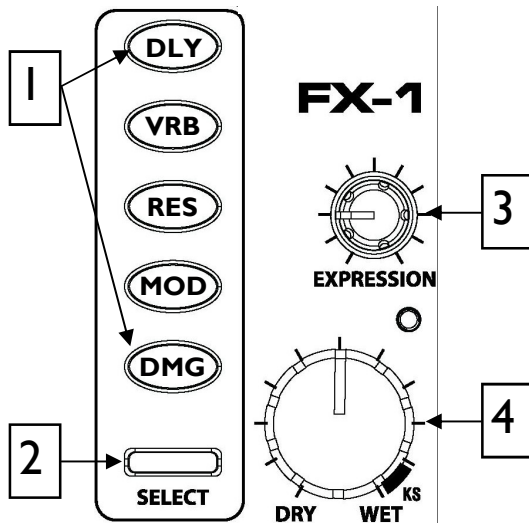

The intuitive layout of the XONE:DB4 FX section enables easy selection of any one of the five different effect types:

**(DLY) DELAY**

**(VRB) REVERB**

**(RES) RESONATOR**

**(MOD) MODULATOR**

**(DMG) DAMAGE**

The WET/DRY control [4] sets the level from no effect (DRY) when fully anticlockwise to maximum effect (WET) when fully clockwise. The EXPRESSION [3] controls a further parameter; for instance, regeneration when DELAY is selected.

All time related effects are automatically synchronised to the music by the BPM detection system which operates independently for each music channel.

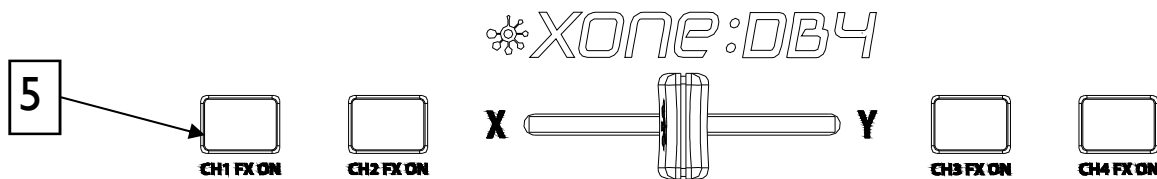

## FX Operation

Pressing any of the five effects buttons [1] will select that effect. Each time an effect button is pressed it will illuminate orange to show it is in "focus". Selecting a different effect button will override the previous selection. Only one effect per channel can be selected.

Pressing an effect button on a different channel will move the focus to that channel and cause the previous channels effect button to turn green; green shows the effect is selected, but that it is not in focus.

When an effect is in focus further parameters can be adjusted using the global control encoders next to the display screen; see Page 20 for details. Focus moves every time a CH FX ON [5], CUE or SELECT [2] button is pressed. The display screen will also highlight which channel effect is in focus.

Each basic effect type, DLY, VRB, RES, MOD, and DMG has a library of alternative effects within the same category. These are accessed using the SELECT button [2]. Press the SELECT button once to move the focus to that channel. When the channel is in focus, press the SELECT button to open up the effect library list on the display screen. See page 19 for details.

To turn ON the selected effect, press the relevant CH FX ON switch [5]. This switch has two modes of operation, latching and momentary. To latch the switch ON, tap once. To briefly switch ON an effect, press and hold the button; the effect will turn off on release. This function also works the other way, so if an effect is ON, pressing and holding the button will turn the effect off until the button is released.

# LOADING IN ALTERNATIVE EFFECTS PRESETS

## Loading Alternative Effects from the Internal Library

Each basic effect type, DLY, VRB, RES, MOD and DMG has a library of alternative presets within the same category. These are accessed using the SELECT button. To view or load a preset, press an FX button, then press the SELECT button - this will display the selected effect library. Use the SEL/ADJ encoder next to the display screen to scroll through the list, then press the encoder to load the chosen preset. New or updated effects will be made available from time to time and can be added to the mixer via the firmware update, see Page 26 for details on how to do this. Check our website, [www.XONE.co.uk/db4](http://www.XONE.co.uk/db4) for in-depth information on the effects types and their use.

Press one of the FX types you want to load the new preset into.

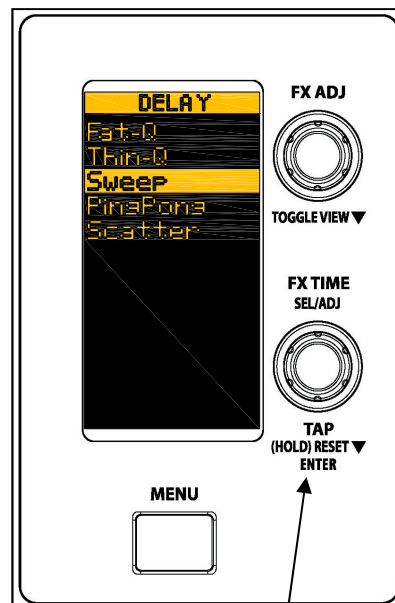
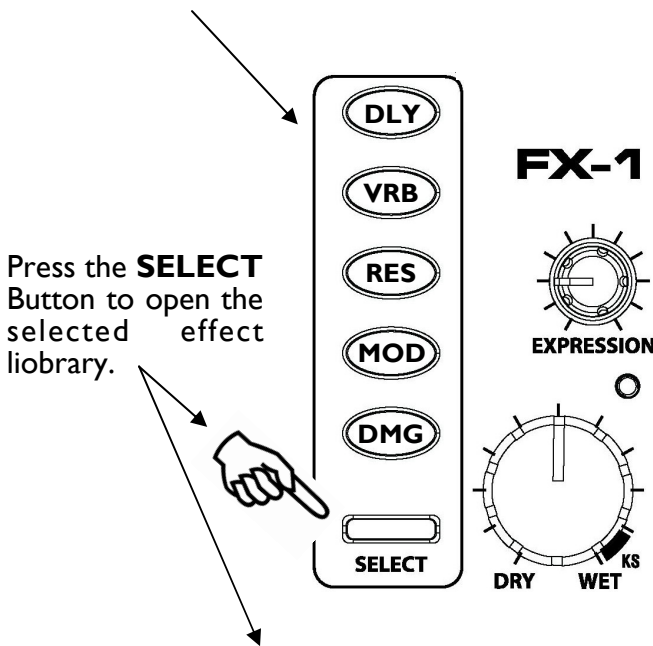

The effect list illustrated may differ depending on the firmware version running on your XONE:DB4.

# THE FX DISPLAY WINDOW AND FOCUS CONTROLS

The effects display screen is divided vertically into four segments numbered 1- 4, which represent the four Channel FX units. The highlighted section shows which channel is in Focus. The illustration below shows the display for channel 1, 2 - 4 follow the same layout.

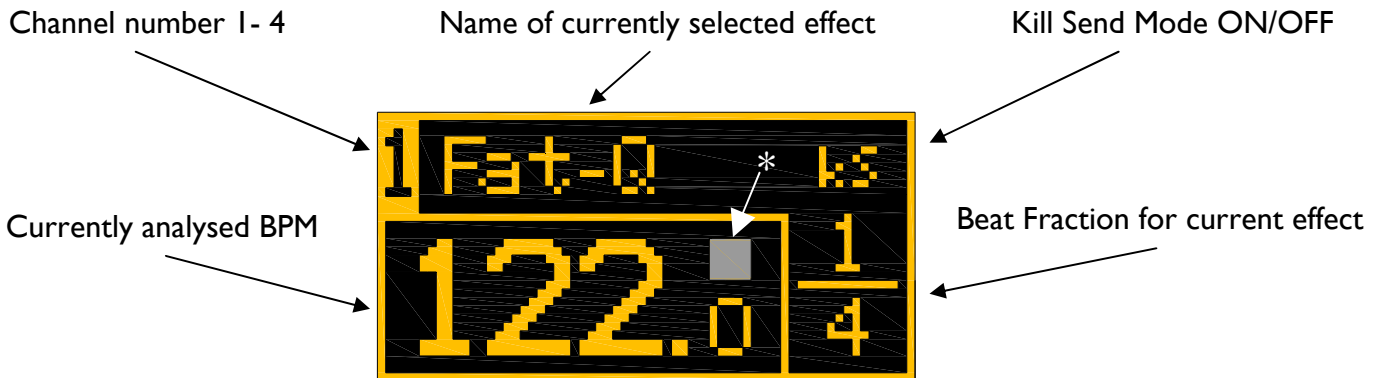

\* This section of the screen can display the following symbols:



T for tapped tempo



L for Loop Active



Padlock to show BPM Locked

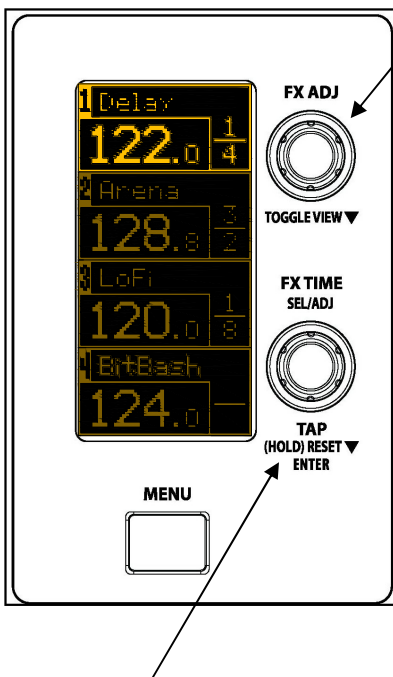

## FX ADJ/TOGGLE VIEW

Adjusts the second effects parameter (e.g. the filter of a Delay). Pressing this encoder will toggle the view between BPM or the second parameter of the currently focused effect.

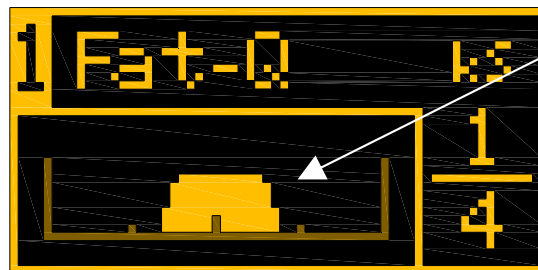

This is the toggled view of the Delay effect “Fat-Q”. It represents a frequency graph, with the low frequencies on the left, high on the right. The shaded area is the frequency response of the output filter of the delay.

Rotating the FX ADJ control will move the centre frequency of this filter, and the shaded area will move left or right.

## FX TIME/TAP

This encoder sets the beat fraction for each effect. Rotating anticlockwise will decrease the time, and rotating clockwise will increase it. The time defaults to fractions of the detected BPM, but for delays this can be switched to absolute time in milliseconds, see Page 21.

Pressing and holding this control for approximately 1/4 second will lock or unlock the BPM at the currently detected setting.

Pressing and holding this control for a further second will reset the BPM detection engine for fresh analyses.

You can also tap in a tempo using this control. You need to tap a minimum of six times before it will be registered.

# KILL SEND AND BPM/mS MODE

## KILL SEND EFFECTS

All Delays and Reverbs can be set to “Kill Send” mode. In this mode, rotating the Wet/Dry control into the orange area labelled “KS” will mute the send to the effects unit, leaving only the processed output to decay into the mix. This can be used as a dramatic way to mix into a new track, or as an entry to a breakdown.

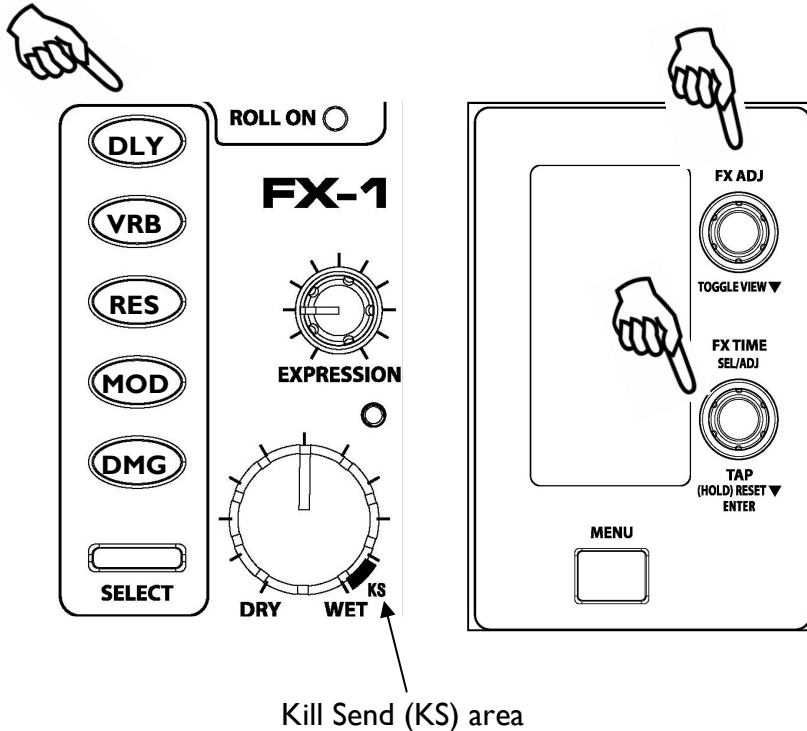

## SWITCHING EFFECTS TO KILL SEND MODE

To switch the Reverbs or Delays to Kill Send mode, hold down the effect button, and at the same time press the FX ADJ encoder. The display will show when kill send is active with a small “ks” above the beat fraction.

## KILL SEND INTERLOCK

When an effect is in kill send mode and the Wet/Dry control turned fully clockwise, the effect ON/OFF button changes colour from Green to Orange, and the effected signal decays into the mix. If the FX is turned OFF the button will change colour to RED to warn that the safety interlock is active. The FX cannot be turned back ON until the Wet/Dry control is moved away from the KS area. Without the safety interlock, turning the FX back ON would result in silence as the audio send to the FX processor has been muted (killed).

## BPM / mS MODE

The delay time defaults to fractions of the detected BPM, set by the FX TIME encoder, however it is possible to manually set the delay time in milliseconds by switching to mS MODE. To do this press and hold the effect DLY button, and at the same time press the FX TIME encoder. The display will switch from the current beat fraction to show that time in milliseconds. Rotating the FX TIME encoder will increase or decrease the time in milliseconds, at the same time the beat fraction display will change to show the nearest equivalent fraction.



Whilst adjusting the delay time in milliseconds, the beat fraction will increase or decrease accordingly. This is represented by the fraction numbers shifting along the fraction dividing line.

When switching back to BPM from mS mode, the tempo will snap to the nearest beat fraction.

# BPM ENGINES

The XONE:DB4 has four independent BPM detection engines, one per channel. Tempo analysis is complex, what might seem an obvious beat to a human requires sophisticated algorithms for a micro-processor to interpret.

Unlike a DAW (digital audio workstation) the DB4 doesn't have the complete song file to analyse, it has to do it real time by "listening" to the audio. To improve the speed and accuracy of tempo analyses the beat detection engines can be guided to look for a tempo within a given range. This is selected in the setup menu, under "BPM RANGE".

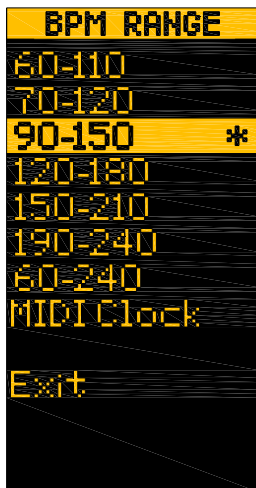

The range options are shown below; choose one that nearest matches the style of music you normally play. If you tend to play songs with a wide variety of different tempos, set the detection system to 60 to 240, but be prepared for the occasional misreading, usually a direct harmonic of the real tempo, especially where there is syncopation.

If the BPM is obviously incorrect, tap the beat using the FX TIME/TAP control; this will guide the detection system to trigger off the correct percussive elements within the track, and assist accurate beat analysis.

## EXTERNAL MIDI CLOCK

If your playback source is a DAW running through the built-in USB2.0 multi-channel soundcard, you can use MIDI clock as the timing source for the DB4, this will override normal BPM detection and affects all channels. If you select this mode make sure that your DAW supports sending MIDI clocks, and that this feature is enabled.

## TEMPO RESET

The BPM detection system can be forced into a reset by holding down the FX TIME encoder until the tempo display changes to "- - -.". The BPM is automatically reset when a new audio source is selected, or the range changed in the menu. The BPM cannot be reset whilst a loop is active on that channel, until the looper is cleared (ROLL LED OFF).

## TAP TEMPO

In addition to the previously discussed detection and synchronising systems, a BPM can be 'tapped' using the FX TIME encoder. You need to tap a minimum of six times before the tempo will be displayed. The tap function can be used to force the BPM detection system to lock onto a harmonic of the beat, useful for creating odd time signatures.

Tap tempo can also be used to extend the Loop length for tempos over 120BPM. For instance, tapping every second beat of a 128BPM track will force the BPM engine to sync to 64BPM, thus doubling the loop time from 4 bars to 8. Note that the displayed beat fractions will be out by a factor of 2.

## TEMPO LOCK

Current Tempo can be locked at any time by pressing and holding the FX TIME encoder until the padlock symbol comes up in the display. When a tempo is locked it will not change when switching to an alternative audio source.

# SETUP MENU

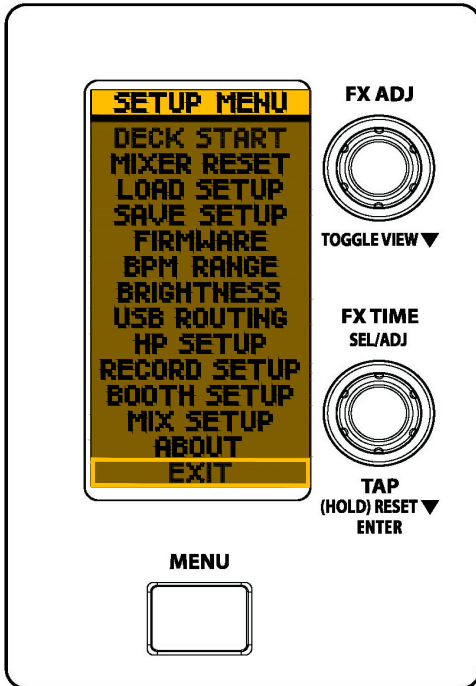

The setup menu lists various settings that can be altered, enabling you to fine tune the DB4 to better suit your application. To enter the setup menu; press the MENU button, then use the 'SEL/ADJ' encoder to scroll up or down through the list. Press the encoder to select an item.

To return to the previous menu or the front screen, select EXIT, or press the MENU button again.

The options are listed below.

## METER MODE

**BAR**—Peak reading VU display

**DOT**—Single dot display showing peak level.

**PEAK**—As BAR, but the highest signal level LED will remain lit for a short period to provide a clearer indication of maximum signal level.

## DECK START

This function allows the DB4 to remotely control the PLAY/CUE function fitted to many DJ CD players. To use this function you will need to connect a 3.5mm TS jack plug from the deck start outputs on the DB4 to the remote inputs on the player.

Each Channel Fader and the Crossfader can be set to 'On' or 'Off'.

## MIXER RESET

Will force a hard reset of the mixer, returning all user options to the default factory setting.

## LOAD SETUP

Enables you to load previously saved mixer settings via a USB key (see SAVE SETUP below).

## SAVE SETUP

Allows you to store the following parameters to a USB key for later recall:

BPM Range, FX Settings (Kill Sends, Presets, Scroll Parameters), Headphone Settings, Meter Mode, Record Source, Surface Brightness and USB Routing.

## FIRMWARE

Use this function to load new firmware to the DB4, see Page 26 for details.

## BPM RANGE

Selects the most appropriate tempo range for the style of music you play. You can also select external MIDI clock as the synchronisation source.

## BRIGHTNESS

Allows you to adjust the brightness of the front panel LEDs to better suit the ambient lighting conditions.

# SETUP MENU

## USB ROUTING



This menu selects the routing options for the upstream USB. Send 1 corresponds to USB 1-2, send 2 to USB 3-4 etc. The options are:

**CHI-4 Analog:** Routes the selected converted analogue input to the soundcard input.

**CHI-4 Digital:** Routes the selected digital input to the soundcard input.

**CHI-4 PFL:** Routes the selected pre-fade channel audio to the soundcard input.

**Record:** Routes the record output to the soundcard input.

**Booth:** Routes the booth output to the soundcard input.

**Mix:** Routes the mix output to the soundcard input.

**Phones:** Routes the headphone (CUE) signal to the soundcard input.

To view the Soundcard Input Block Diagram, please see Page 28.

## HP SETUP

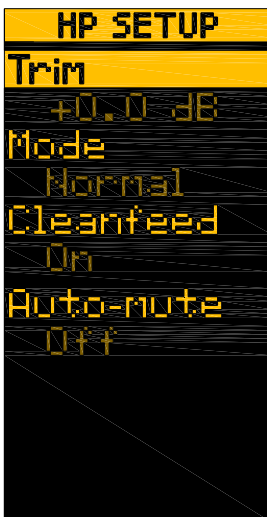

This menu enables you to set the sensitivity, audio source and mode of the headphone cue system

**Trim:** Adjusts the operating level of the headphone amplifier to match the sensitivity of your headphones. The trim ranges from  $-28$  to  $+12$  dB.

**Mode:** Toggles between **Split** and **Normal**. In **Split** mode a mono sum of the main mix is sent to the right headphone and the cue signal in the left. Use the CUE/MIX control to pan between the two. The main meters will display cue level on the left and mix level on the right.

**Normal** mode will provide a stereo cue or main mix signal to the headphone output, dependant of the position of the CUE/MIX control. The meters will display a stereo signal level of the main mix, or the channel pre-fade signal level when a Cue is activated.

**Cleanfeed:** Selects whether or not the signal from the Microphone input is routed to the headphones when the CUE/MIX control is set to Mix; for instance, if you don't want to hear the MC's microphone when beat-matching to the main mix set this to On. The options are On/Off.

**Auto-mute:** Selects the non-cue'd audio source. If this is set to On, the headphone output will be muted until a channel Cue is activated. If set to Off, the headphone output will default to the main mix or clean feed when all channels cues are off.



# SETUP MENU

## RECORD SETUP



**Trim:** Sets the signal level of the analogue record outputs *and* the Digital Output. 0.0dB corresponds to a nominal output level of +4dBu when the main meters read 0VU. This is an ideal level to feed power amplifiers or interface with pro audio equipment, but is too high for most recording devices, (minidisks etc) so use this control to attenuate the output level by up to 40dB.

**Source:** There are three options available; Mix, Cleanfeed, or Phones. Mix will send the same signal to the record out as to the main mixer outputs, Cleanfeed will send the Mix output less the signal from the Mic channel, and Phones will send the headphone monitor signal. The Digital output will also be affected by any routing changes made here.

## BOOTH SETUP



**Trim:** Sets the signal level of the Booth outputs. 0.0dB corresponds to a nominal output level of +4dBu when the main meters read 0vU. This is an ideal level to feed power amplifiers or interface with pro audio equipment. If the Booth level is too high, it can be attenuated by up to 40dB.

**Phase:** Allows you to reverse the signal Phase of the Booth output. The DB4 is phase coherent, i.e. the signal phase of the output is the same as the input, however in some installations acoustic reflections can create a phase cancellation between the booth monitors and the main PA. This often results in loss of bass frequencies, so try reversing the Booth phase to see if it improves the fidelity of the system.

**Source:** There are three options available, Mix, Cleanfeed, or Phones. Mix will send the same signal to the record out as to the main mixer outputs, Cleanfeed will send the Mix output less the signal from the Mic channel, and Phones will send the headphone monitor signal.

## MIX SETUP

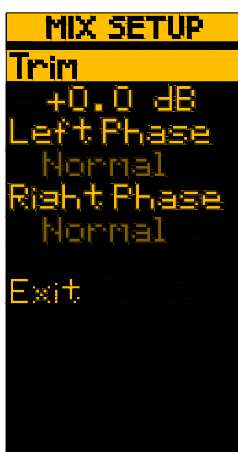

**Trim:** Sets the signal level of the Main Mix outputs. 0.0dB corresponds to a nominal output level of +4dBu when the main meters read 0vU. This is an ideal level to feed power amplifiers or interface with pro audio equipment. If the Mix level is too high, it can be attenuated by up to 40dB.

**Phase:** Allows you to reverse the individual left/right signal Phase of the Main Mix outputs. This control can also be used as a temporary fix for wrongly wired balanced cables or speaker systems

Normal means that the mixer is Phase coherent, i.e. the output signal is the same phase as the input.

# FIRMWARE UPDATING

## FIRMWARE

When new effects or hardware interfaces are made available for the XONE:DB4 it is possible that the mixer will require new firmware.

New firmware will be made available for download from the website:

[www.XONE.co.uk/DB4](http://www.XONE.co.uk/DB4)

Check the website from time to time to check if new firmware is available.

The current version of installed firmware (Code Version) can be found by selecting the “About” screen in the Menu. This screen will also display the unique eID number for your DB4.

Installing new firmware will not overwrite your saved mixer settings.

To install the firmware after you have downloaded it, follows these instructions carefully:

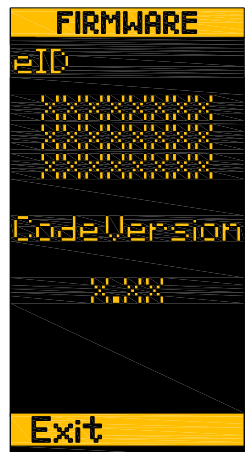

Use a good quality USB key of between 32MB and 4GB. Copy any files that you need to keep, then format the key using FAT32. Unzip the new firmware file to this key, and plug the key into the USB socket on the mixers front panel.

Open the Menu and scroll down to FIRMWARE, and select this option.

Select “Load File”, and the screen will ask you to confirm that you want to continue.

Select “YES” and firmware updating will begin. The screen will change to show a progress bar.

When the update is complete, the mixer will automatically reboot. Avoid powering the mixer off whilst the update is in progress.

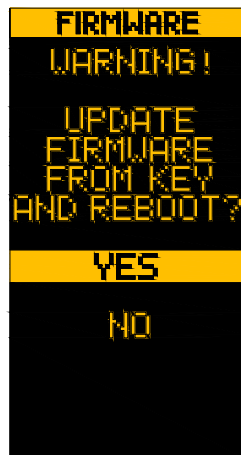

If the mixer freezes during the update or after the reboot, it can be forced into a hard reset by turning the mixer Off at the power switch, then pressing and holding down the Menu button whilst turning the mixer back On. Hold the MENU button down for six to eight seconds and then release.



# USB AUDIO SYSTEM

The 16-channel USB2.0, 96kHz/24bit audio system built into the XONE:DB4 makes it the perfect interface for use with Digital Audio Workstation software. The mixer deals with the processor intensive effects work, leaving the computer lightly loaded to better stream the audio data. Another advantage is that all processing is kept in the digital domain, especially if the DAW is used to simultaneously record the mix. MIDI compatible DAWs can be controlled from the DB4 via MIDI.

**The supplied low-latency drivers must be installed before connecting the XONE:DB4 to a computer; see page 30 for PC installation, or page 33 for Mac installation.**

## SOUNDCARD NOMENCLATURE

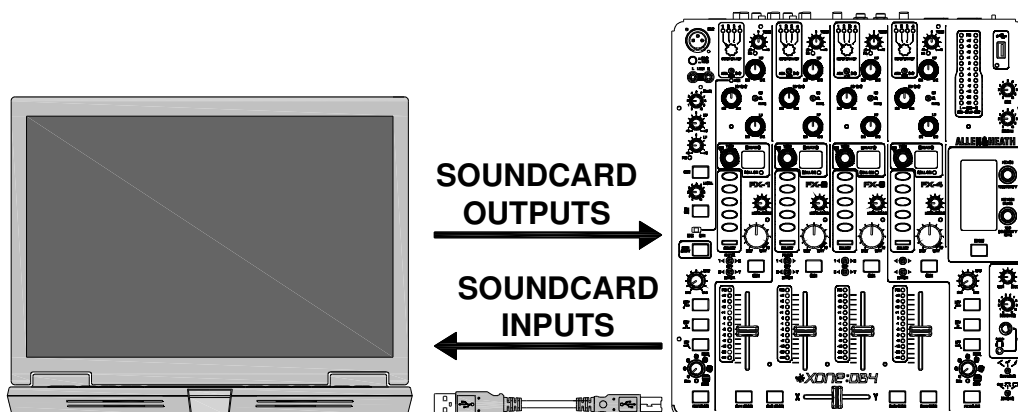

Referencing the above diagram, Soundcard Inputs are from the XONE:DB4 to the PC/MAC and Soundcard Outputs are from the PC/MAC to the XONE:DB4.

## SOUNDCARD OUTPUTS

The XONE:DB4 has eight (four stereo) soundcard outputs that will appear in your chosen DAW application. The outputs are arranged as follows:

DAW	XONE:DB4
SOUNDCARD OUTPUT 1-2	USB 1
SOUNDCARD OUTPUT 3-4	USB 2
SOUNDCARD OUTPUT 5-6	USB 3
SOUNDCARD OUTPUT 7-8	USB 4

## SELECTING A USB AUDIO CHANNEL

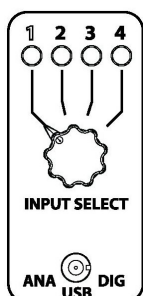

To select USB audio on one of the XONE:DB4 input channels, set the source switch to USB and then use the Input Select switch to choose which USB channel you wish to use.

# USB SOUND CARD ROUTING

## SOUNDCARD INPUTS

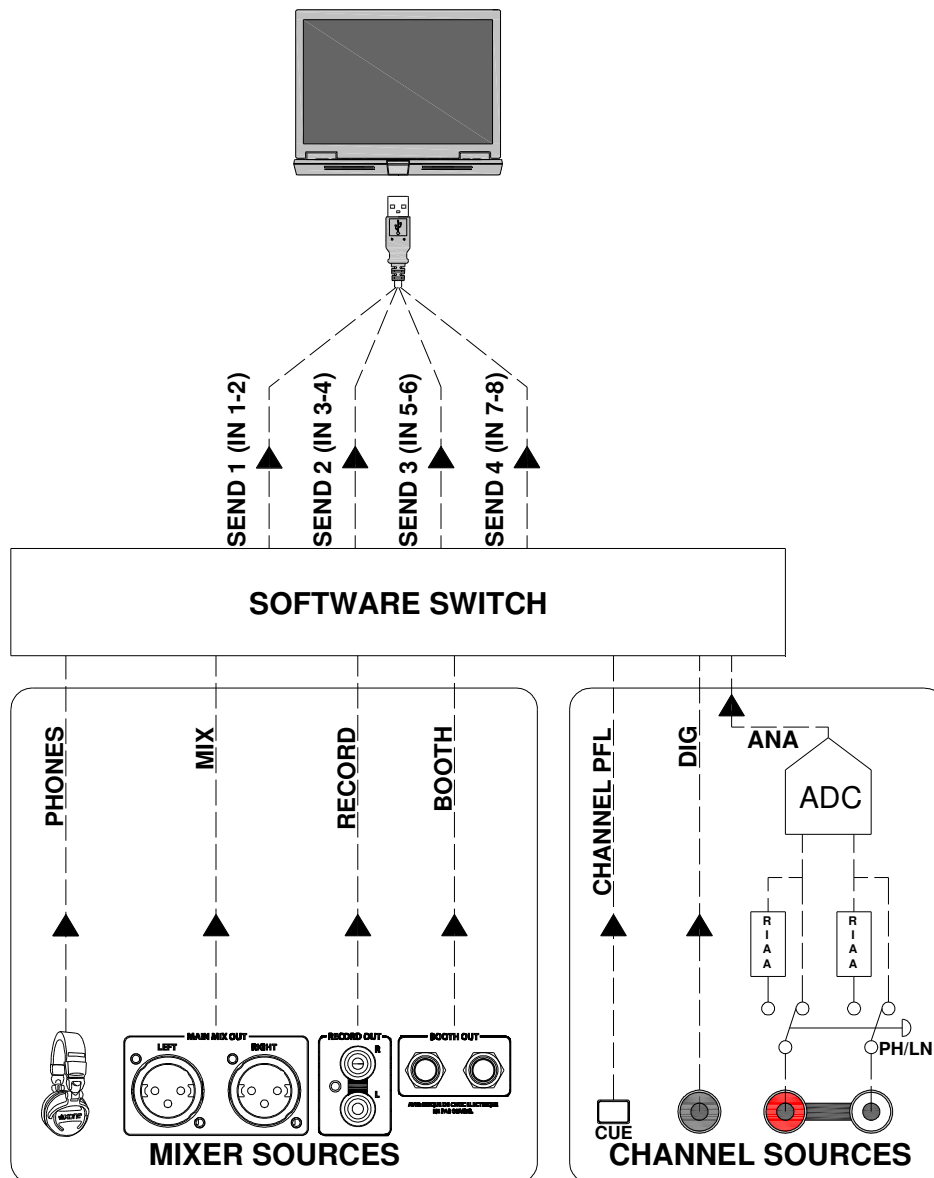

The XONE:DB4 provides eight (four stereo) soundcard inputs that will appear in your chosen DAW application. The inputs are arranged as follows:

DAW	XONE:DB4
SOUNDCARD INPUT 1-2	SEND 1
SOUNDCARD INPUT 3-4	SEND 2
SOUNDCARD INPUT 5-6	SEND 3
SOUNDCARD INPUT 7-8	SEND 4

The block diagram above shows the different sources that can be mapped to each of the stereo soundcard inputs (or Sends). The sources are split into two groups, MIXER and CHANNEL.

# USB SOUNDCARD ROUTING

## CHANNEL SOURCES

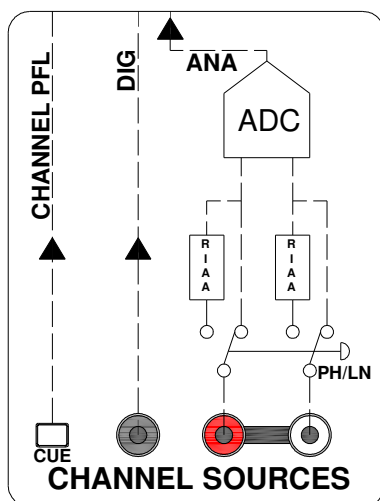

Each of the USB audio sends can source from various points within the XONE:DB4 Input Channels. From the diagram, the three options are Analogue In, Digital In and Channel PFL.

**ANALOGUE IN** - The analogue sources are arranged as follows:

CHANNELS 1 AND 4 - LINE INPUT ONLY  
CHANNELS 2 AND 3 - SWITCHABLE LINE /PHONO

**DIGITAL IN** - The source connected to the channel's digital input.

**CHANNEL PFL** - The channel PFL is the point in the signal path where monitoring is done using the channel CUE button. The Channel PFL is after the EQ, Loop and FX sections, so any manipulation of these areas will be audible.

## MICROPHONE INPUT

The microphone input can be recorded into software by setting its selector switch to 'CHI' (see Page 9) and setting one of the input sends to CHANNEL 1 PFL.

## MIXER SOURCES

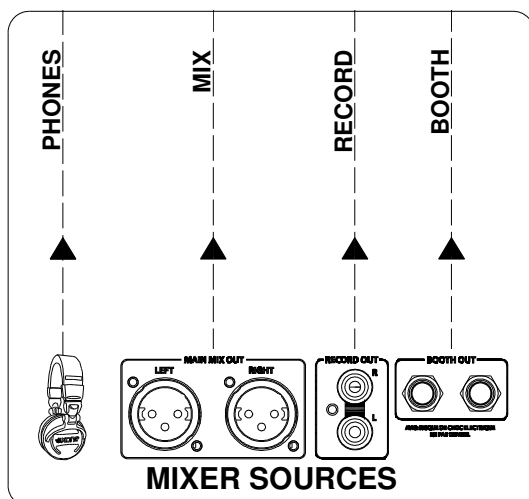

The USB audio sends can also source from any of the mixers outputs.

From the diagram, the four options are the Booth Output, Record Output, Mix Output and Headphone (CUE bus) Output.

**BOOTH OUTPUT** - Routes the Booth Output to the chosen send. For more information on Booth Output source options, please refer to Page 25.

**RECORD OUTPUT** - Routes the Record Output to the chosen send. For more information on Record Output source options, please refer to Page 25.

**MIX OUTPUT** - Routes the Mix Output to the chosen send. For more information on Mix Output source options, please refer to Page 25.

**PHONES OUTPUT** - Routes the Phones Output to the chosen send. For more information on Phones Output source options, please refer to Page 24.

## MAPPING A SOUNDCARD INPUT SEND

For details on selecting Soundcard Input Send sources please see "USB Routing" on Page 24.

# PC DRIVER INSTALLATION

## STOP!

BEFORE YOU CONNECT YOUR XONE:DB4 TO A COMPUTER PLEASE FOLLOW THESE INSTRUCTIONS ON INSTALLING THE CORRECT DRIVERS FOR THE USB SOUNDCARD.

CHECK [www.XONE.co.uk/db4](http://www.XONE.co.uk/db4) FOR NEWS ON THE LATEST DRIVER VERSIONS

## Software Installation (Windows XP, Vista and Windows 7)

Follow the procedure described below to install the USB audio and MIDI drivers:

1— Connect the XONE:DB4 to your mains electricity supply.

**Do not connect the DB4 to the PC at this time.**

2— Open the Drivers folder and run **Setup.exe**.

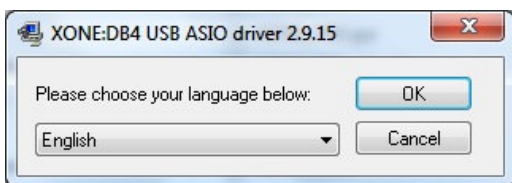

3— Select your preferred language

4— Select **Install the driver**

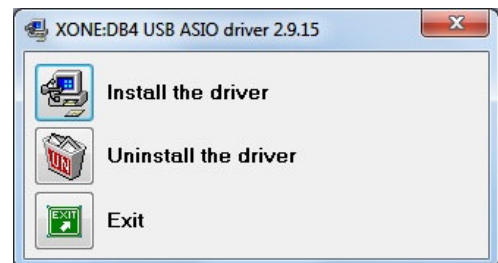

5— When prompted, connect the DB4 to the PC with the USB lead.

# PC DRIVER INSTALLATION



6—Select 'Install'.

7—The USB driver will now install.

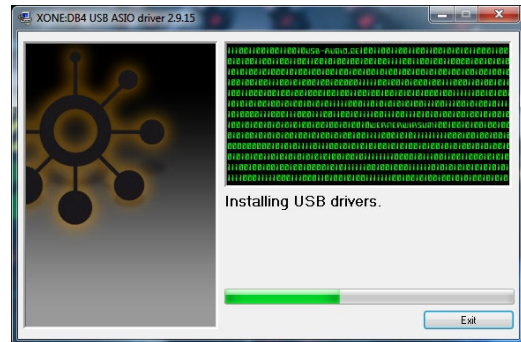

8— Select 'Install'.

9— Select 'Install'.

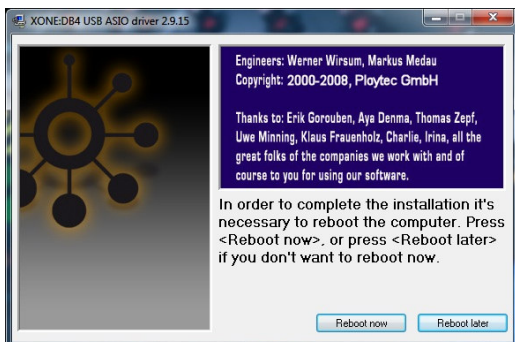

10— Reboot to complete installation.

The installation process may differ slightly dependant upon Operating System and Security Software.

**Note:** Always use the same USB port with your XONE:DB4. When installing on a MS Windows system, the drivers will be associated with the USB port that you are currently plugged into. If you attempt to use the DB4 with another USB port, or without installing the drivers at all, the system may work but with degraded performance (XP, Vista, Windows 7), or may not work at all (2000).

# PC DRIVER INSTALLATION

## Checking the Driver Installation

Once the driver installation is complete, you will need to check that the XONE:DB4 is being recognised. Connect the XONE:DB4 to your PC/laptop and then right click on **My Computer** and select **Manage**. Next select **Device Manager** in the left hand window.

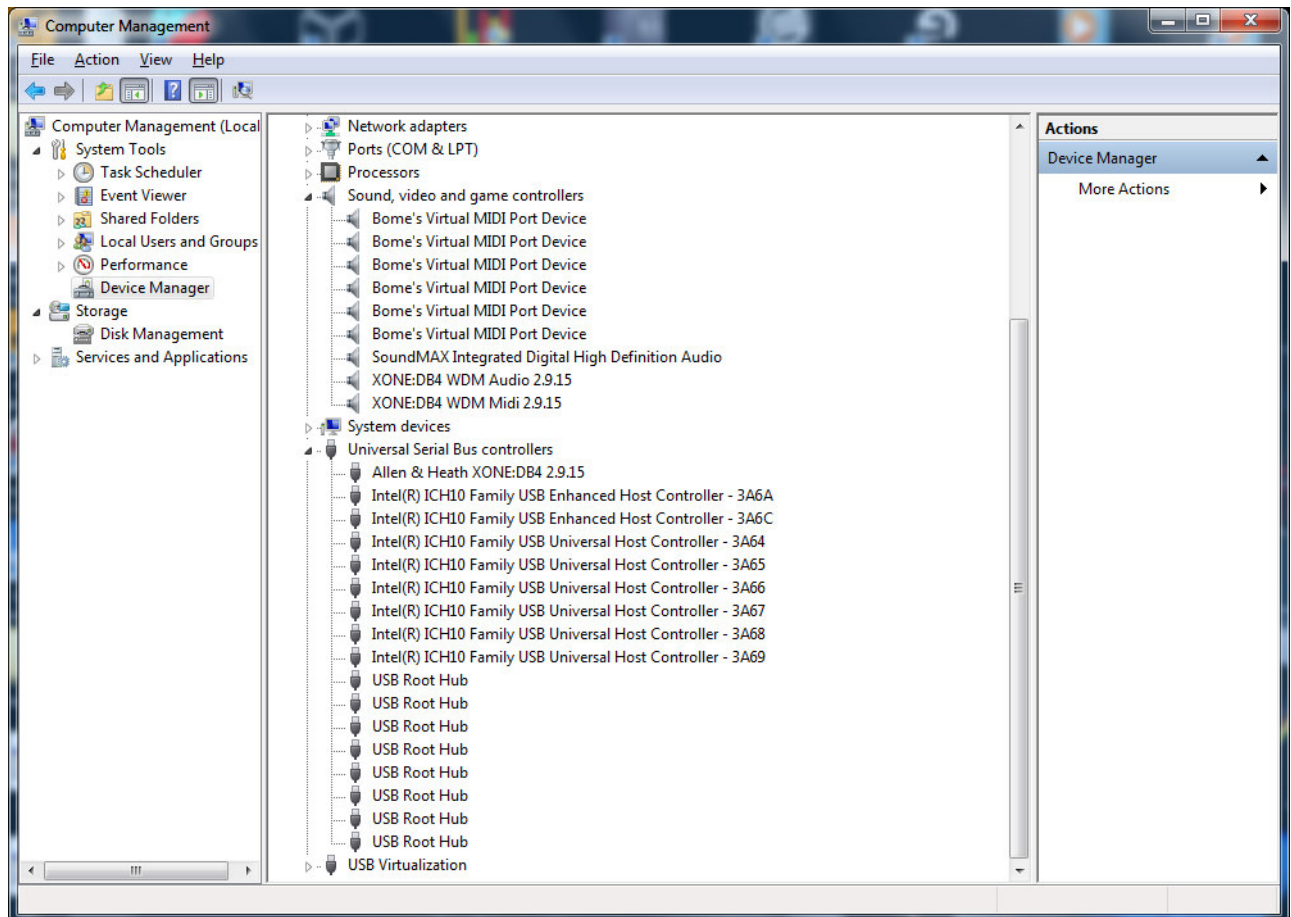

Expand the **Sound, Video and Game Controllers** section to reveal the WDM audio and MIDI drivers for the XONE:DB4.

Expand the **Universal Serial Bus Controllers** section to reveal the XONE:DB4 ASIO driver and its release (version) number—in this case V2.9.15.



# MAC DRIVER INSTALLATION

## STOP!

BEFORE YOU DO ANYTHING WITH YOUR XONE:DB4, PLEASE READ THE FOLLOWING CAREFULLY TO ENSURE YOUR MAC IS CORRECTLY SET UP TO BE USED WITH THE MIXER.

CHECK [www.XONE.co.uk/db4](http://www.XONE.co.uk/db4) FOR NEWS ON THE LATEST DRIVER VERSIONS

## Mac OSX

Open the XONE\_DB4\_Driver\_x.x.x.dmg to reveal the window shown.

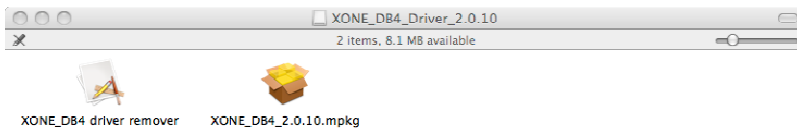

Click on the XONE:DB4 mpkg file to launch the driver installation.

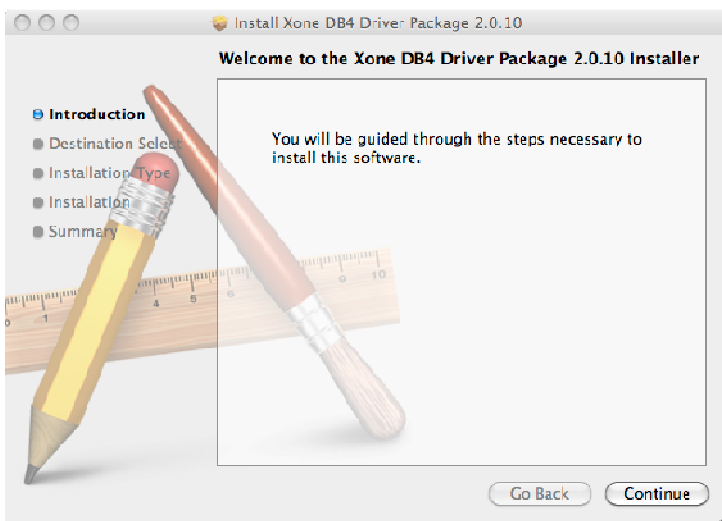

Click on "Continue".

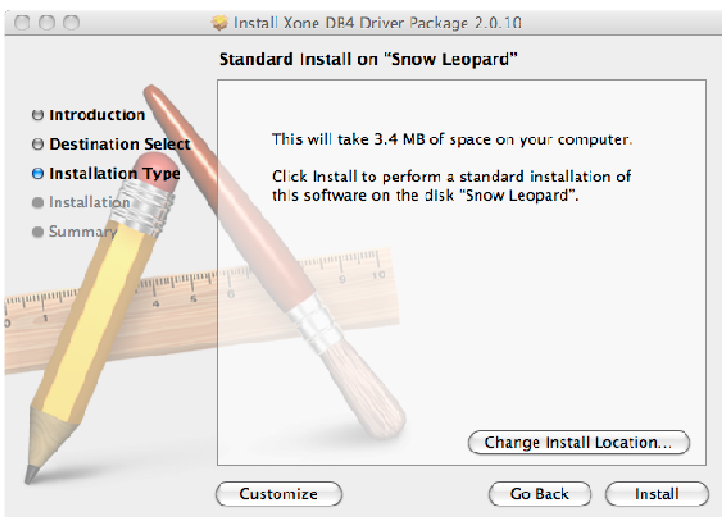

Select install location and then click "Install".

# MAC DRIVER INSTALLATION



Enter your system password.

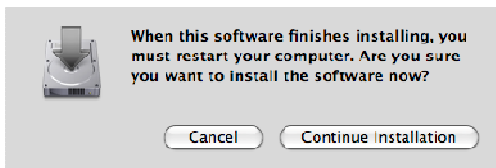

Click on "Continue Installation".

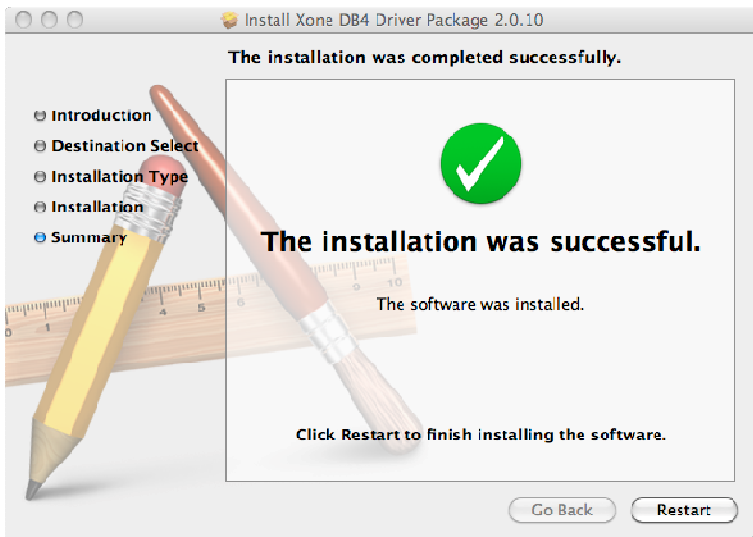

Restart your Mac.

# MAC DRIVER INSTALLATION

## Checking the Driver Installation

Once the driver installation is complete, you will need to check that the XONE:DB4 is being recognised. To do this, connect the XONE:DB4 to your Mac and then, from the file menu, select:

GO → Utilities → Audio MIDI Setup

The **Audio Devices** window will open automatically. To open the **MIDI Studio** window, from the File Menu, select:

Window → Show MIDI Window

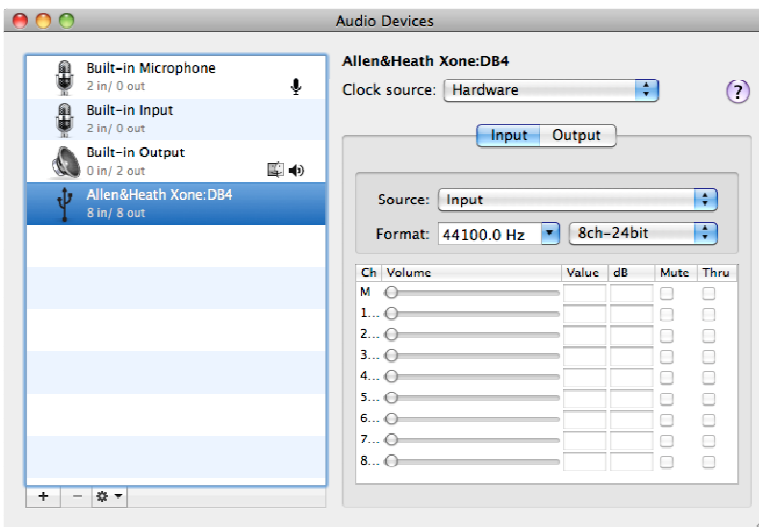

In the **Audio Input** section, the number of channels should be seen as 8, running at 24 bit.

In the **Audio Output** section, the number of channels should be seen as 8, running at 24 bit.

The sample rate is selectable from 44.1 to 96kHz.

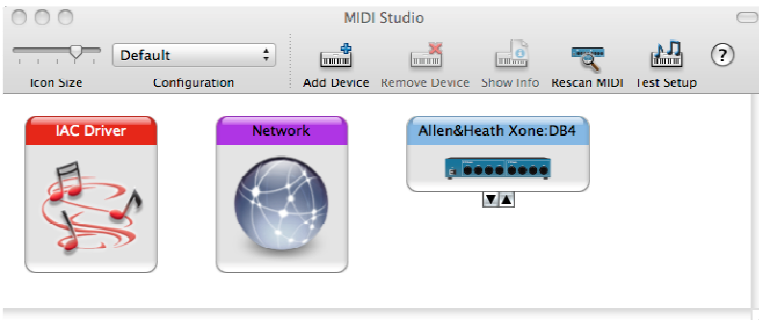

Now select the **MIDI Devices** tab and make sure that the XONE:DB4 is seen as a MIDI de-

# MIDI CONTROL

**MIDI** stands for Musical Instrument Digital Interface, and is an interface protocol from the nineteen eighties to enable different keyboards, sequencers, drum machines, etc. to communicate with each other.

MIDI is still a common interface used by most DAW software to allow remote control of various functions within the program.

Virtually all the front panel controls on the XONE:DB4 send MIDI data when operated, the only exception being the Mic/Line switch, Mic Level, and Headphone level as these are analogue controls.

All of the illuminated buttons on the DB4 can be activated remotely via MIDI.

## MIDI SHIFT MODE

The DB4 has a useful feature to enable easy remote control of DAWs without affecting the mixer, this is called “MIDI SHIFT”. MIDI shift is activated by pressing the button above the left Filter Resonance control, and is confirmed by the display panel changing to “MIDI SHIFT”.

When MIDI shift is active, the FX Type and Select buttons, Loop encoders, and Global encoders are disconnected from the Mixer, and only send MIDI data when operated. This provides a total of 36 independent MIDI controls that can be mapped to software. The illuminated buttons can also be remotely turned off/on by the DAW if it has the capability of sending output messages.

## MIDI SHIFT MODE

These are the independent controls available when the MIDI SHIFT function is activated:

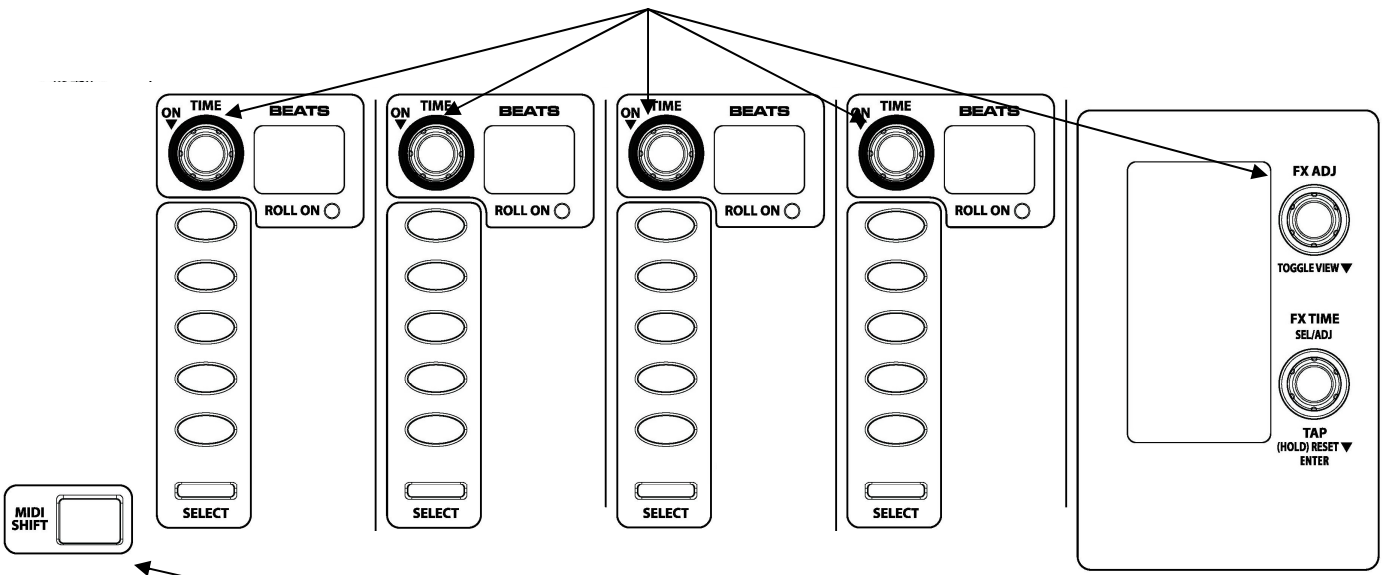

**Press to enter MIDI shift Mode**

Pressing once will latch the button, for momentary function, press and hold.

# MIDI CONTROL MESSAGES

## INPUT MATRIX

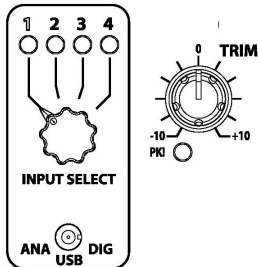

DB4 CHANNEL	INPUT SELECT				SOURCE			TRIM CONTROL
	1	2	3	4	ANA	USB	DIG	
1	Eb 6 CH 16	D 6 CH 16	C# 6 CH 16	C 6 CH 16	F 6 CH 16	OFF ◀▶	E 6 CH 16	CC 32 CH 16
2	G 4 CH 16	F# 4 CH 16	F 4 CH 16	E 4 CH 16	A 4 CH 16	OFF ◀▶	G# 4 CH 16	CC 6 CH 16
3	B 2 CH 16	Bb 2 CH 16	A 2 CH 16	G# 2 CH 16	C# 3 CH 16	OFF ◀▶	C 3 CH 16	CC 24 CH 16
4	Eb 1 CH 16	D 1 CH 16	C# 1 CH 16	C 1 CH 16	F 1 CH 16	OFF ◀▶	E 1 CH 16	CC 15 CH 16

## EQ SECTION

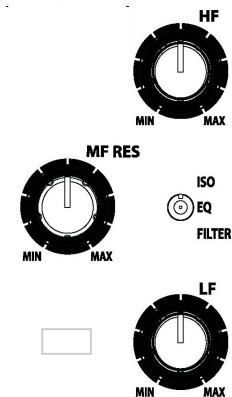

DB4 CHANNEL	EQ CONTROL			MODE SELECT		
	HF	MF	LF	ISO	EQ	FLT
1	CC 31 CH 16	CC 27 CH 16	CC 29 CH 16	G 6 CH 16	OFF ◀▶	F# 6 CH 16
2	CC 5 CH 16	CC 2 CH 16	CC 4 CH 16	B 4 CH 16	OFF ◀▶	Bb 4 CH 16
3	CC 23 CH 16	CC 19 CH 16	CC 21 CH 16	Eb 3 CH 16	OFF ◀▶	D 3 CH 16
4	CC 14 CH 16	CC 10 CH 16	CC 12 CH 16	G 1 CH 16	OFF ◀▶	F# 1 CH 16

## FX CONTROLS, FILTER & XFADE ASSIGN, CUE

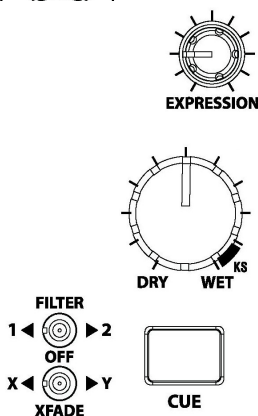

DB4 CHANNEL	EXP	DRY/ WET	FILTER			XFADE			CUE
			1	OFF	2	X	OFF	Y	
1	CC 9 CH 16	CC 33 CH 16	C# 5 CH 16	OFF ◀▶	D 5 CH 16	Eb 5 CH 16	OFF ◀▶	E 5 CH 16	F 5 CH 16
2	CC 11 CH 16	CC 7 CH 16	F 3 CH 16	OFF ◀▶	F# 3 CH 16	G 3 CH 16	OFF ◀▶	G# 3 CH 16	A 3 CH 16
3	CC 13 CH 16	CC 25 CH 16	A 1 CH 16	OFF ◀▶	Bb 1 CH 16	B 1 CH 16	OFF ◀▶	C 2 CH 16	C# 2 CH 16
4	CC 17 CH 16	CC 16 CH 16	C# 0 CH 16	OFF ◀▶	D 0 CH 16	Eb 0 CH 16	OFF ◀▶	E 0 CH 16	F 0 CH 16

# MIDI CONTROL MESSAGES

## CHANNEL FADER, FX ON SWITCH

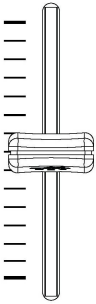

DB4 CHANNEL	FADER	FX ON
1	CC 37 CH 16	E8 CH 16
2	CC 35 CH 16	F8 CH 16
3	CC 38 CH 16	F#8 CH 16
4	CC 36 CH 16	G8 CH 16

## CHANNEL FADER CURVE, XFADER CURVE, XFADER



CHANNEL FADER CURVE			XFADER CURVE			XFADER
G-1 CH 16	OFF ◀▶	G#-1 CH 16	F#-1 CH 16	OFF ◀▶	F-1 CH 16	CC 39 CH 16

## FILTERS

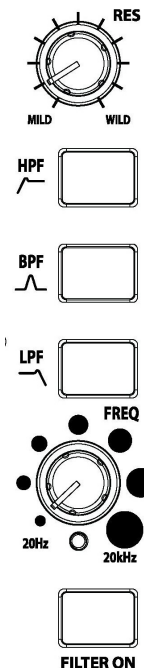

FILTER	RES	HPF	BPF	LPF	FREQ	ON
1(L)	CC 8 CH 16	B 6 CH 16	C 7 CH 16	C# 7 CH 16	CC 34 CH 16	D 7 CH 16
2(R)	CC 1 CH 16	C#-1 CH 16	D-1 CH 16	Eb-1 CH 16	CC 3 CH 16	E-1 CH 16

# MIDI CONTROL MESSAGES

## ADDITIONAL CONTROLS

CC 26, CH 16  
 CC 28, CH 16  
 PKI  
 CUE G# 6, CH 16  
 CC 30, CH 16  
 CH ON A 6, CH 16  
 MIX CH1 Eb 8, CH 16  
 BOOTH CC 20, CH 16  
 MIX CC 18, CH 16  
 CC 22, CH 16  
 B -1, CH 16

## MIDI SHIFT MODE

ON TIME  
 DLY  
 VRB  
 RES  
 MOD  
 DMG  
 SELECT

DB4 CHANNEL	ENC ROTARY	ENC SWITCH	DLY	VRB	RES	MOD	DMG	SELECT
1	CC 112 CH 16	F# 5 CH 16	G 5 CH 16	G# 5 CH 16	A 5 CH 16	Bb 5 CH 16	B 5 CH 16	C 5 CH 16
2	CC 113 CH 16	Bb 3 CH 16	B 3 CH 16	C 4 CH 16	C# 4 CH 16	D 4 CH 16	Eb 4 CH 16	E 3 CH 16
3	CC 114 CH 16	D 2 CH 16	Eb 2 CH 16	E 2 CH 16	F 2 CH 16	F# 2 CH 16	G 2 CH 16	G# 1 CH 16
4	CC 115 CH 16	F# 0 CH 16	G 0 CH 16	G# 0 CH 16	A 0 CH 16	Bb 0 CH 16	B 0 CH 16	C 0 CH 16

# DIGITAL IO - X-LINK

## DIGITAL INPUTS - DIGITAL OUTPUT

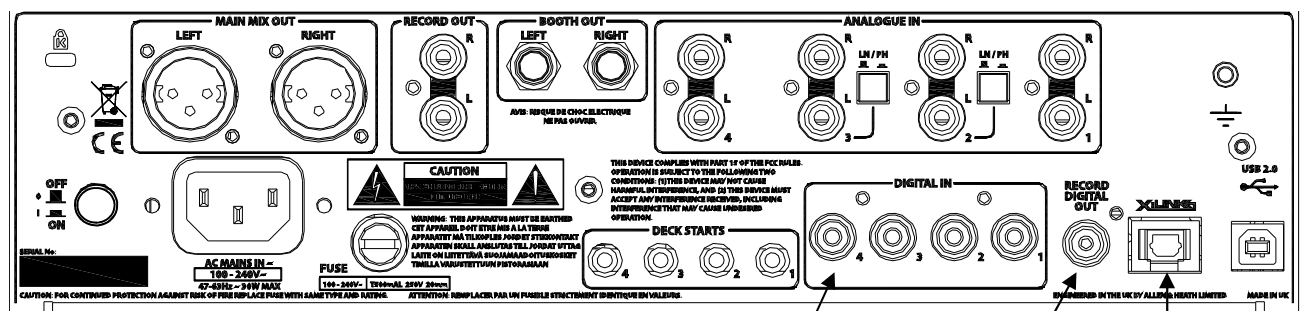

**DIGITAL INPUT:** The XONE:DB4 has four digital inputs on the rear panel designed for standard 75 Ohm RCA interface cables. These inputs are compatible with the following formats: AES3, IEC60958, S/PDIF (Sony/Phillips Digital Interconnect Format), EIAJ CP1201, all from 32kHz to 192kHz, and up to 24bits.

**Digital Output:** The digital output is fixed at 48kHz/24 bit, non copy protected, with a 75 Ohm impedance. The digital output source, and signal level is set in the Menu under “Record Setup”, see page 24 for details.

### X-LINK

**X-Link** is a proprietary interface protocol to enable future Allen & Heath accessories and controllers to be easily connected to the XONE:DB4. Visit [www.XONE.co.uk](http://www.XONE.co.uk) for the latest news on X-Link enabled products.

## DIGITAL ARCHITECTURE SPECIFICATION

Analogue/Digital conversion	24 bit
Analogue/Digital Line-up	+12dBu = 0dBFS
DSP processing	24 bit I/O + 48 bit EQ
DSP Mix Bus	56 bit Fixed Point
DSP core sampling frequency	48kHz
USB soundcard sampling frequency range	44.1kHz to 96kHz
SPDIF input sampling frequency range	32kHz to 192kHz
SPDIF Output sampling frequency	48kHz

QUAD FX Core DSP engine: 4 simultaneous FX engines with independent BPM calculation. 4 stereo Loopers with BPM conscious looping, 4 bars at 60BPM maximum sample time.



# SPECIFICATIONS

## Operating levels

Main outputs	0VU = +4dBu
Monitor	0VU = +4dBu
Record	0VU = +4dBu
Maximum output level	+16dBu balanced
Mic Sensitivity	-20dB - -50dB
RIAA input sensitivity 1kHz	70mV = 0VU (200mV max)
Frequency response Line in to Mix out	10Hz - 20kHz +0/-0.5dB
Distortion at 1kHz Line in at +0VU out	0.003% (-90dB) un-weighted
Main Mix noise 22Hz— 22KHz un-weighted	-88dBu (104dB dynamic range)
Residual Mix noise 22Hz— 22KHz un-weighted	-94dBu
Equalization	+6dB boost/-26dB or Total Kill 3 Band
Fader Shutoff	-110dB

See Page 40 for Digital Architecture Specification

## Dimensions and Weights

The console is fitted with rubber feet for desktop operation. A screw on rack ear kit is available for 19" rack or plinth mounting.

	Width	Height	Depth	Weight
Desktop	320 mm (12.6")	88 mm (3.5")	358 mm (14")	5.1 kg (11 lbs)
Rack ears fitted	483 mm (19")	88 mm (3.5")	358 mm (14")	
Packed	530 mm (20.9")	470 mm (18.5")	260 mm (10.2")	8.6 kg (19 lbs)

To order a rack ear kit for the XONE:DB4, please quote the part number X:DB4-RK19.

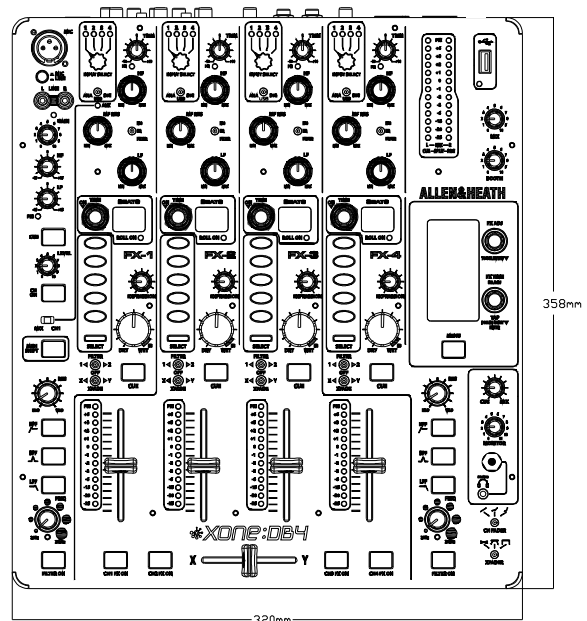
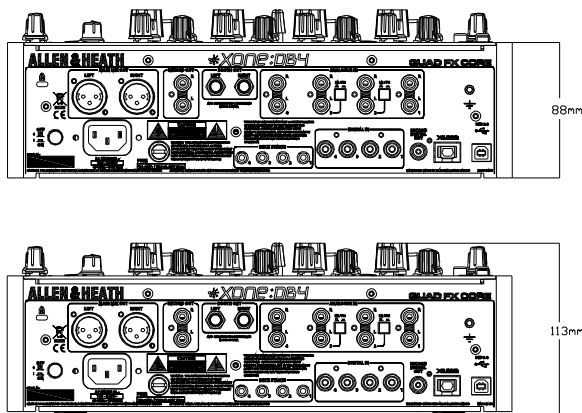

# NOTES

# PRODUCT REGISTRATION

## Registering your product

Please go to [www.allen-heath.com/register.asp](http://www.allen-heath.com/register.asp) and register your product's serial number and your details. By registering with us and becoming an official Registered User, you will ensure that any warranty claim you might make is actioned quickly and with the minimum delay.

Alternatively, you may either copy or cut off this section of the page, fill in the details, and return it by mail to:

Allen & Heath Ltd, Kernick Industrial Estate, Penryn, Cornwall TR10 9LU, UK

ALLEN&HEATH PRODUCT REGISTRATION	
Thankyou for buying an Allen & Heath product. We hope that you're happy with it and that you enjoy many years of faithful service with it.	
SERIAL NUMBER	
<b>Please return this section of the card by mail and retain the other part for your records. You can also register online at <a href="http://www.allen-heath.com">www.allen-heath.com</a>. Thanks for your help.</b>	
Your Name: _____	
Company Name: _____	
Address 1: _____	
Address 2: _____	
Town/City: _____	County/State: _____
Country: _____	Postcode/Zip: _____
Telephone: _____	
Email: _____	
Why did you choose this console? _____	
Which other products did you consider before choosing A&H? _____	
Is there any thing you would like to improve on this mixer? _____	
What audio magazines do you read? _____	
If you were going to design a mixer for your work, what are the 6 most important features it should have (in order of importance)	
1 _____	2 _____
3 _____	4 _____
5 _____	6 _____
We may use the information you provide to inform you of future product developments. We will not give or sell this data to third parties. Please indicate with an 'x' if you do not wish to receive any further communications from us. <input type="checkbox"/>	

