

*Egnater*TM
CUSTOM AMPLIFICATION

TOURMASTERTM 4100

TOURMASTERTM 4212

Owner's Manual

INSIDE THIS OWNER'S MANUAL

Greetings from Bruce Egnater.....	3
Important Information.....	4
Safety Precautions.....	5
4100 & 4212 Specifications.....	6
Quick Start Guide.....	7
Finding the Sound You Want	8-9
The Rear Panel Explained.....	10-11
Connecting Your Speakers	12
Power Cord / Main Fuse / Voltage Selector	13
The Channels.....	14
The Effects Loop	15-16
Tube Biasing	17-18
Warranty Information.....	19



Greetings.....

I would like to personally thank you for choosing Egnater as your “Tone Partner”. Our goal is to provide you with the best tools we can to help you express yourself to the fullest. Your amplifier is an integral piece in your never ending “Tone Quest”. Our commitment to helping you achieve that goal is our passion. Our hope is that you will take advantage of the years of innovative tube amp designs we offer and use it to find the sound that is “in your head”.

Thank you for putting your trust in Egnater.

Best Regards,

Bruce Egnater



IMPORTANT INFORMATION

Please keep this instruction manual for future reference and for the duration of owning this Egnater Tourmaster™ 4100 / 4212. Please carefully read and understand the instructions inside this user's manual before attempting to operate your new amp.

This instruction manual includes essential safety information regarding the use and maintenance of the Tourmaster™ 4100 / 4212. Take special care to heed all warning symbols and signs inside this manual and those printed on the amplifier itself.



WARNING

TO PREVENT FIRE OR SHOCK HAZARD, **DO NOT** EXPOSE THE AMPLIFIER TO WATER OR MOISTURE. DO NOT OPERATE NEAR ANY WATER SOURCE

- 1) Read these instructions.
- 2) Follow all instructions.
- 3) Keep these instructions.
- 4) Heed all warnings.
- 5) DO NOT turn on the amplifier before connecting all other external devices.
- 6) Do not use the amplifier near water. Be extra cautious when moving the amplifier during rain or while transporting it over wet surfaces as water might splash onto the unit.
- 6) Clean only with dry cloth.
- 7) Do not block any ventilation openings and operate in accordance with manufacturer's instructions.
- 8) Do not install near heat sources such as radiators, stoves or other devices that may produce heat.
- 9) Do not defeat the safety purpose of the polarization or grounding-type plug. A polarized plug has two blades with one wider than the other. A grounding-type plug has two blades and a third grounding prong. The wide blade or the third prong is provided for your safety. If the provided plug does not fit your outlet, consult an electrician for replacement of the obsolete outlet.
- 10) Protect the power cord from being walked on or pinched, particularly at the plug and the point where it exits the amplifier.
- 11) Only use attachments / accessories specified by Egnater Amps.
- 12) Unplug the amplifier before lightning storms and when not in use.
- 13) Refer all servicing to qualified personnel. Servicing may be required when the unit has been damaged in any way such as when power-cord or

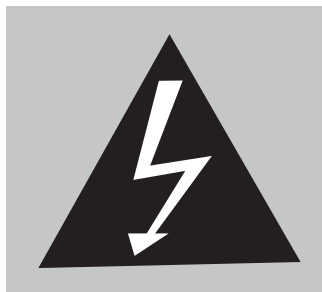

WHAT'S THE MEANING OF THIS?

The lightning flash with an arrow triangular symbol is intended to alert the user to the presence of non-insulated "dangerous voltage" within the products enclosure, and may be of sufficient magnitude to constitute a risk of electric shock



WHAT'S THE MEANING OF THIS?

The exclamation point triangular symbol is intended to alert the user to the presence of important operating and maintenance (servicing) instructions in the user manual accompanying this amplifier

- 14) Moisture can damage the amplifier and can cause corrosion of electrical contacts.
- 15) Keep the unit out of extended or intense direct sun light. No containers filled with any type of liquid should be placed on or near the amplifier.
- 16) Do not attempt to replace tubes or bias the amplifier by yourself. Refer to authorized service center.
- 17) Do not remove rear metal grill. No user serviceable parts inside.

WARNING

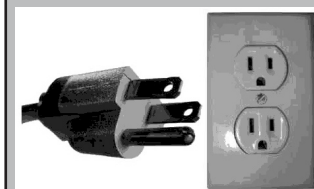

Handle the power supply cord with care. Do not damage or deform; it may cause electric shock or malfunction when used. Hold plug attachment when removing from wall outlet. Do not pull on the power cord.

FOLLOW THESE SAFETY PRECAUTIONS

1. **READ INSTRUCTIONS** – All the safety and operating instructions should be read before this product is operated.

2. **RETAIN INSTRUCTIONS** – The safety and operating instructions should be retained for future reference.

3. **HEED WARNINGS** – All warnings on the amplifier and in the operating instructions should be adhered to.

4. **FOLLOW INSTRUCTIONS** – All operating and use instructions should be followed.

5. **WATER AND MOISTURE** – The amplifier should not be used near water - for example, a bathtub, washbowl, kitchen sink, laundry tub, wet basement, or near a swimming pool, and the like.

6. **CARTS AND STANDS** – The amplifier should be used only with a cart or stand that is recommended by the manufacturer.



An amplifier and cart combination should be moved with care. Quick stops, excessive force, and uneven surfaces may cause the amplifier and cart combination to overturn.

7. **WALL OR CEILING MOUNTING** – The product should never be mounted to a wall or ceiling.

8. **HEAT** – Amplifier should be situated away from heat sources such as radiators, heat registers, stoves, or other amplifier (including amplifiers) that produce heat.

9. **POWER SOURCES** – This product should be operated only from the type of power source indicated on the rating label. If you are not sure of the type of power supply to your home, consult your product dealer or local power company.

10. **GROUNDING OR POLARIZATION** – This product may be equipped with a polarized alternation-current line plug (a plug having one blade wider than the other). This plug will fit into the power outlet only one way. This is a safety feature. If you are unable to insert the plug fully into the outlet, try reversing the plug. If the plug should still fail to fit, contact your electrician to replace your obsolete outlet. Do not defeat the safety purpose of the polarized plug.

11. **POWER-CORD PROTECTION** – Power-supply cords should be routed so that they are not likely to be walked on or pinched by items placed upon or against them, paying particular attention to the cord in correspondence of plugs, convenience receptacles, and the point where they exit from the amplifier.

12. **CLEANING** – The amplifier should



CAUTION
DO NOT OPEN
RISK OF ELECTRIC SHOCK



CAUTION: To reduce the risk of electric shock, do not remove any cover. No user-serviceable parts inside. Refer servicing to qualified service personnel only.



The lightning flash with arrowhead symbol within the equilateral triangle is intended to alert the user to the presence of un-insulated "dangerous voltage" within the product's enclosure that may be of sufficient magnitude to constitute a risk of electric shock.



The exclamation point within the equilateral triangle is intended to alert the user to the presence of important operation and maintenance (servicing) instructions in the literature accompanying this amplifier.

CAUTION

To prevent electric shock, do not use this polarized plug with an extension cord, receptacle or other outlet unless the blades can be fully inserted to prevent blade exposure.

be cleaned only as recommended by the manufacturer. Clean by wiping with a cloth slightly damp with water. Avoid getting water inside the amplifier.

14. **NON-USE PERIODS** – The power cord of the amplifier should be unplugged from the outlet when left unused for a long period of time.

15. **OBJECT AND LIQUID ENTRY** – Care should be taken so that objects do not fall and liquids are not spilled into the enclosure through openings.

16. **DAMAGE REQUIRING SERVICE** – The amplifier should be serviced by qualified service personnel when:

- A. The power-supply cord or the plug has been damaged; or
- B. Objects have fallen, or liquid has been spilled into the amplifier; or
- C. The amplifier has been exposed to rain; or
- D. The amplifier does not appear to operate normally or exhibits a marked change in performance; or
- E. The amplifier has been dropped, or the enclosure damaged.
- F. The amplifier needs tube replacement or biasing

17. **SERVICING** – The user should not attempt any service to the amplifier beyond that described in the operating instructions. All other servicing should be referred to qualified service personnel.

18. **VENTILATION** – Slots and openings in the cabinet are provided for ventilation and to ensure reliable operation of the product and to protect it from overheating, and these openings must not be blocked or covered. The openings should never be blocked by placing the product on a bed,

sofa, rug, or other similar surface. This product should not be placed in a built-in installation such as a bookcase or rack.

19. **ATTACHMENTS** – do not use attachments not recommended by the product manufacturer as they may cause hazards.

20. **ACCESSORIES** – Do not place this product on an unstable cart, stand, tripod, bracket, or table. The product may fall, causing serious injury to a child or adult, and serious damage to the product. Use only with a cart, stand, tripod, bracket, or table recommended by the manufacturer, or sold with the product.

21. **LIGHTNING** – For added protection for this product before a lightning storm, or when it is left unattended and unused for long periods of time, unplug it from the wall outlet. This will prevent damage to the product due to lightning and power-line surges.

22. **REPLACEMENT PARTS** – When replacement parts are required, be sure the service technician has used replacement parts specified by the manufacturer or have the same characteristics as the original part. Unauthorized substitutions may result in fire, electric shock, or other hazards.

23. **SAFETY CHECK** – Upon completion of any service or repairs to this product, ask the service technician to perform safety checks to determine that the product is in proper operating condition.

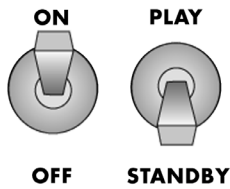

Egnater™
TOURMASTER
4100

MASTER



VOLUME REVERB



DENSITY PRESENCE

OVERDRIVE



VOLUME — CONTOUR TREBLE



OVERDRIVE

TOURMASTER™ 4100 / 4212 SPECIFICATIONS:

OUTPUT POWER:	10 to 100 Watts RMS Presettable
HIGH INPUT IMPEDANCE:	1meg Ohm
LOW INPUT IMPEDANCE:	94k Ohms
OUTPUT IMPEDANCE:	4 Ohms, 8 Ohms Or 16 Ohms - Selectable
EFFECTS LOOP SEND IMPEDANCE:	4k7 Ohms
EFFECTS LOOP RETURN IMPEDANCE:	250k Ohms
THD:	5% At Rated Output
PREAMP TUBES:	Eight Selected Groovetubes™ / Egnater 12AX7A / ECC83
OUTPUT TUBES:	Four Selected Groovetubes™ / Egnater 5881
DENSITY:	+6db @ 120hz
PRESENCE:	+8db @ 3.2khz
RECORD OUTPUT LEVEL:	-50dBv To 0dBv
DIMENSIONS:	4100 Head 27" (W) x 11" (D) x 10.5" (H) 4212 Combo 27" (W) x 11" (D) x 22" (H)
WEIGHT:	4100 Head 60 lbs 4212 Combo 95 lbs with 2x12" Egnater / Celestion™ Elite 80 Speakers

TOURMASTER™ QUICK START GUIDE

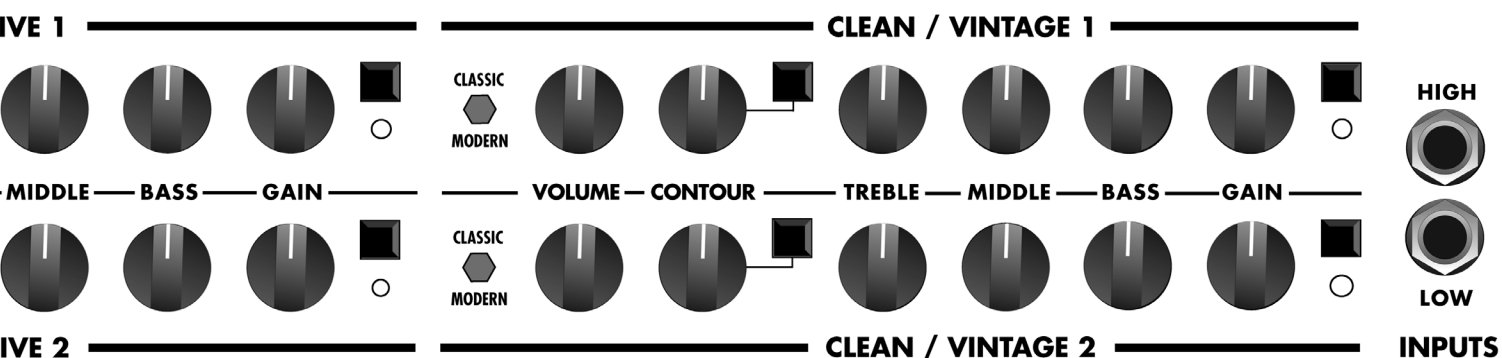

Not a manual reader?

.....please use this “Quick Start” guide. You can always refer to the manual later.

The Tourmaster™ 4100 (Head) and 4212 (Combo) represent the latest in tube guitar amp technology. Our aim in creating the Tourmaster™ models is to offer an extensive array of useable tones and features while keeping things easy to understand and operate. This “Quick Start” guide will help you start creating great tones right away. For more in depth descriptions of some of the cool features, simply read further in the manual. Please note the Tourmaster™ 4100 head and 4212 combo have all the same controls and features. The only difference between the two is that the panel layouts are reversed to read properly in their respective cabinets.

Admittedly the front panel is a bit daunting at first. Don’t be put off by it. Think of the Tourmaster™ as four separate amps in one box. Each channel has an identical set of controls that are simply repeated four times. That is where the similarity ends.

INPUTS: There are two instrument inputs. The HIGH input is the hotter of the two. Plugging in here will give you the maximum gain. If your guitar has very high output pickups, using the Low input may provide more clean headroom. Use the one that works best for your guitar and playing style.

CLEAN/VINTAGE 1 is the cleanest of the four. Within this channel lives a range of Classic tones ranging from pristine sparkle with the voicing switch set to MODERN to a punchy, aggressive drive (think clean JTM) in the CLASSIC mode. Pressing the button to activate the CONTOUR control opens an entire new range of beautiful clean, almost acoustic, tones not often found in a tube amplifier.

CLEAN/VINTAGE 2 has a very similar voicing to the Clean/Vintage 1 channel. We’ve added more gain so this channel can be “pushed” into mild overdrive. Sweet blues and classic rock tones are

easily coaxed out of this channel. Again, the contour knob adds another level of unique flavors.

OVERDRIVE 1: From AC/DC crunch to modern rock, this channel covers a lot of bases all by itself. Dial down the gain and the feel is pure classic rock. Push the gain and enter into more modern, saturated territory. Scoop the mids with the CONTOUR control for monstrous metal or set it for classic British rhythm.

OVERDRIVE 2: The Tourmaster’s most intense channel, you’ll find ferocious gain with a wide range of tones to suit the ‘80s shredder as well as the heaviest modern metal player. Scoop the mids with the powerful CONTOUR control for massive crunch or push the midrange for a solo tone that cuts through with serious authority.

MASTER SECTION: The controls here have an effect over all channels simultaneously. The MASTER VOLUME simply adjusts the overall volume of the amp. This allows you to turn everything up or down without upsetting the balance between the four channels. MASTER REVERB sets the overall level of the internal spring reverb. MASTER PRESENCE and DENSITY

provide BASS and TREBLE boost in the power amp section. By having these EQ circuits in the power amp, you can boost the depth and bite without losing pre-amp definition. At low volumes, fullness and clarity are enhanced. Be forewarned, these powerful controls should be used sparingly at higher volumes. If overused, the sound can get muddy and cause excessive speaker breakup or sound brittle and overly bright. Tighter, punchier bass will be achieved with the lowest possible settings of the DENSITY control.

BIG TOGGLE SWITCHES: Two of these. The one labeled OFF and ON turns the power OFF and ON. Pretty straight forward. The one next to it labeled STANDBY and PLAY has a specific important function. With the main POWER on and the switch in the STANDBY position, the tubes are warmed up and ready to go. When flipped to the PLAY position, the amp is fully on and ready to rock. When turning the Tourmaster™ on from a cold start, always have the switches in the OFF and STANDBY positions respectively. Turn the power on first and wait about a minute or so for the tubes to warm up. Then switch to the PLAY position.

FINDING THE SOUND YOU WANT!

Below are some suggested knob settings to get you started. Keep in mind these are merely suggestions. You are encouraged to experiment to find “your tone”.

ROCK RHYTHM (CONTOUR IN)

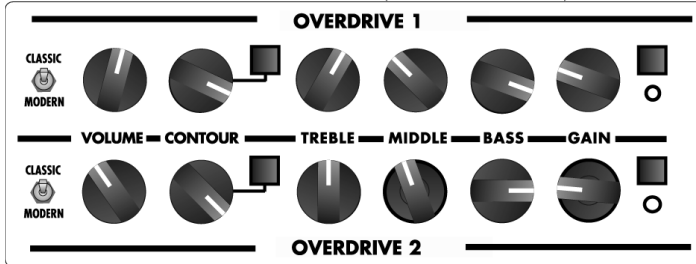

ROCK DRIVE (CONTOUR IN)

PRISTINE CLEAN (CONTOUR IN)

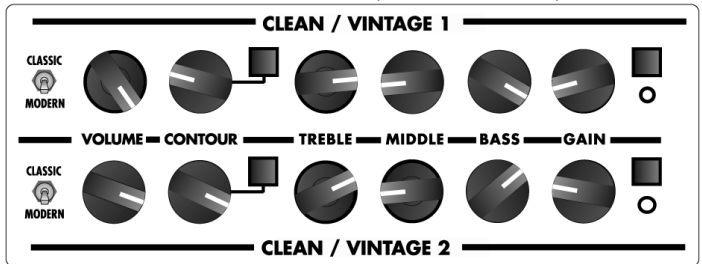

MODERN RHYTHM (CONTOUR IN)

BRIT DRIVE (CONTOUR IN)

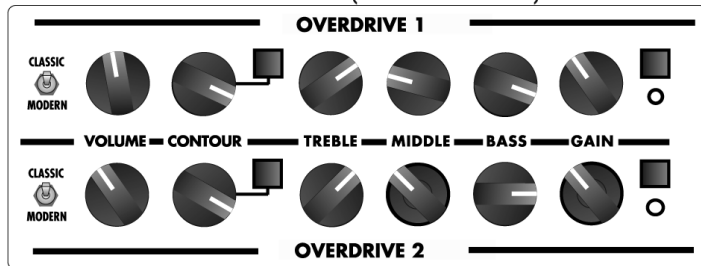

BRIT HIGH DRIVE (CONTOUR IN)

AMERICAN CLEAN (CONTOUR IN)

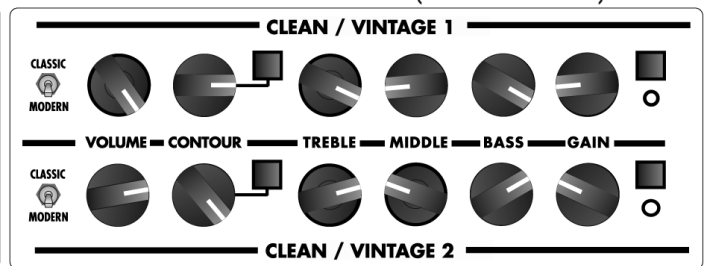

AMERICAN RHYTHM (CONTOUR IN)

BRIT GRIND (CONTOUR OUT)

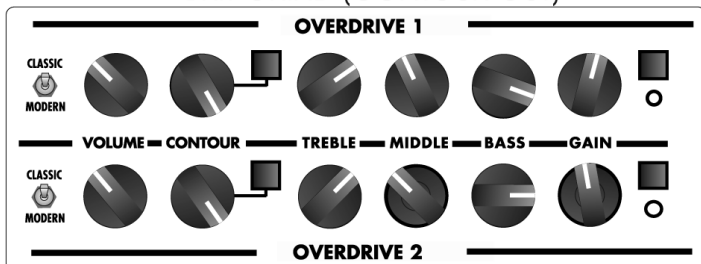

BRIT HOT (CONTOUR OUT)

JTM CLEAN (CONTOUR OUT)

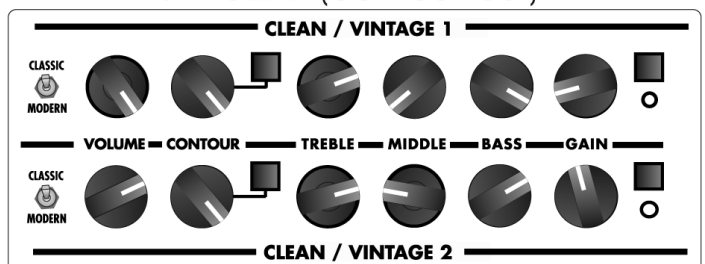

JTM PUSHED (CONTOUR OUT)

FINDING THE SOUND YOU WANT! con't

MODERN HIGH GAIN (CONTOUR IN)

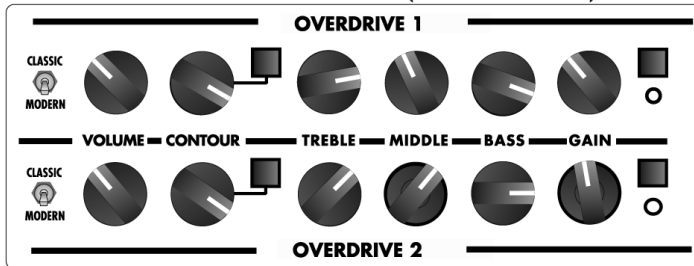

MODERN SOLO (CONTOUR OUT)

VINTAGE RHYTHM (CONTOUR OUT)

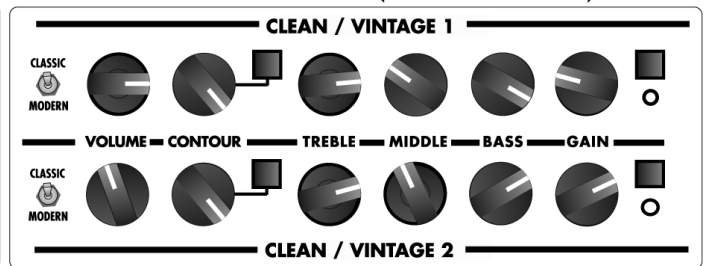

BLUES DELUXE (CONTOUR OUT)

MODERN METAL RHYTHM (CONTOUR IN)

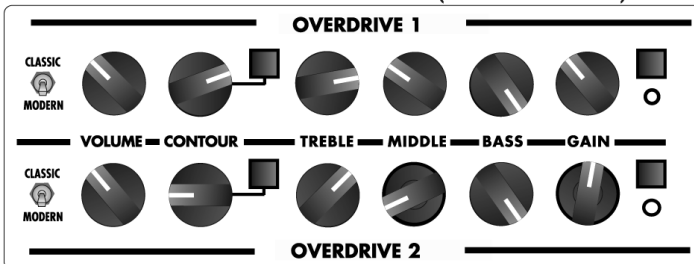

MODERN DEATH METAL (CONTOUR IN)

PUSHED RHYTHM (CONTOUR OUT)

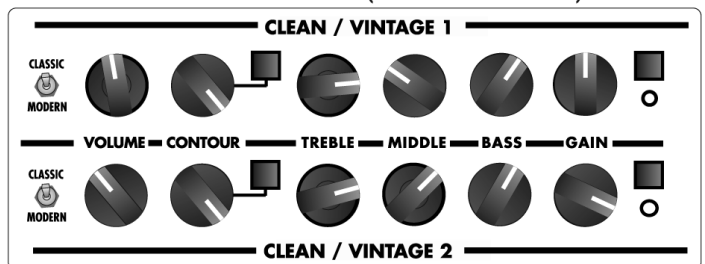

CRUNCH RHYTHM (CONTOUR OUT)

A FEW TIPS FOR FINDING YOUR SOUND

- 1) As a rule, the less gain you use the tighter and more defined your low end will sound and feel.
- 2) There should be a reasonably balance between the channel volume controls and the main master volume knob. This means, for example, you should not have all the individual channel volumes cranked way up and have the main volume control just “barely cracked open” or viceversa. Find a sensible balance between the volume knobs so you can make volume adjustments easily.
- 3) Use the master DENSITY and PRESENCE controls sparingly. Too much presence boost will tend to sound shrill and offensive to listeners directly in front of your speakers. Your tone will also tend to be excessively bright when mic'd through a PA. Too much DENSITY boost can make your low end overbearing. This is hard on your speakers. This may cause excessive speaker breakup / distortion that could lead to premature speaker burnout. Excessive DENSITY boost will also upset your bass player, which may be good or bad thing....

WARNING!

Do not open or attempt to service the TOURMASTER by yourself. Refer all service to an Egnater Authorized Dealer. Refer to instruction manual for additional warnings and precautions.

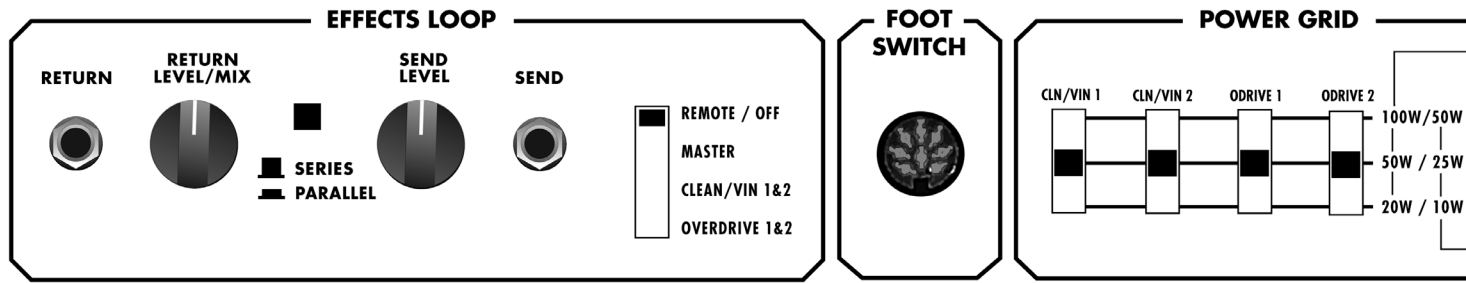

Looks like a lot of stuff doesn't it? Don't worry. It's really easy.

EFFECTS LOOP: This is where you can plug your external effects gadgets in. To use the loop, simply run a high quality shielded cable from the SEND jack to the input of your effects. Connect another high quality shielded cable from the effects unit out to the RETURN jack. For now, the simplest setup will be to use the loop in the SERIES mode so set the pushbutton switch to the OUT position. We will explain the PARALLEL mode in the EFFECTS LOOP section later in this manual. The loop can be activated a few different ways. One way is to simply set the slide switch to MASTER. The loop is now active on all channels and can not be turned on or off via the footswitch. You also have the option of presetting when the loop is on. You can set it up so that the loop only becomes active when you use the CLEAN channels by setting the slide switch to CLEAN/VIN 1&2. Conversely, you can have the loop only turn on with the OVERDRIVE channels by setting the slide switch to OVERDRIVE 1&2. If you prefer to control the loop "on the fly", simply set the slide switch to REMOTE/OFF. You can now use the EFFECTS

button on the footpedal to turn the loop on and off. Easy so far right? To set the loop SEND LEVEL and RETURN LEVEL/MIX, plug your effects unit in and activate the loop using one of the methods above. Set the SEND LEVEL to "0" and the RETURN LEVEL/MIX to 3:00. Now, while switching the loop on and off, adjust the send level until there is no volume change when switching the loop on and off. Also note that there is no noticeable increase in distortion or noise. If you hear distortion or noise, refer to the EFFECTS LOOP section on Page 15. NOTE: There are some effects that are not made to use in a loop. If you notice a severe loss of volume or treble, or an increase in distortion when activating the loop, this is an indication that the pedal is being overloaded and should not be used in the loop.

FOOTSWITCH: Plug in the Tourmaster™ footpedal controller using the special supplied 8-pin DIN cable. Note: A standard MIDI cable will not properly function with the pedal.

POWER GRID: This is a really cool feature your

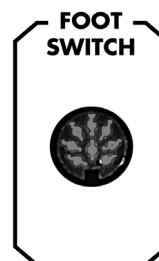

will only find on the Egnater Tourmaster™ amps. Using this group of 5 slide switches, you can set the power output for each channel individually. As you can see there is a 3 position slide switch corresponding to each channel and a single FULL POWER/ HALF POWER slide switch. We suggest starting with all the channel slide switches in the 100 watt position and the FULL/HALF power switch at full power. This will tell the POWER GRID circuit to produce the full 100 watts for each channel. The first thing to do is decide if 100 watts or 50 watts is what your maximum power will be and set the FULL/HALF power switch accordingly. Next is the cool stuff. Let's say you want channel one to be a big, full, beautiful, clean sound. You need lots of power for that so leave the CLN/VIN 1 slide in the highest power position. Now you decide you want channel 2 to be more like a little Fender Deluxe™. You can easily have the amp reduce the power (watts) automatically when you switch to channel two by selecting one of the lower power settings on the CLN/VIN slide switch. This will give you some power tube breakup and compression (sag) at just the right volume. Repeat these steps for the other channels. Now, not only

THE REAR PANEL

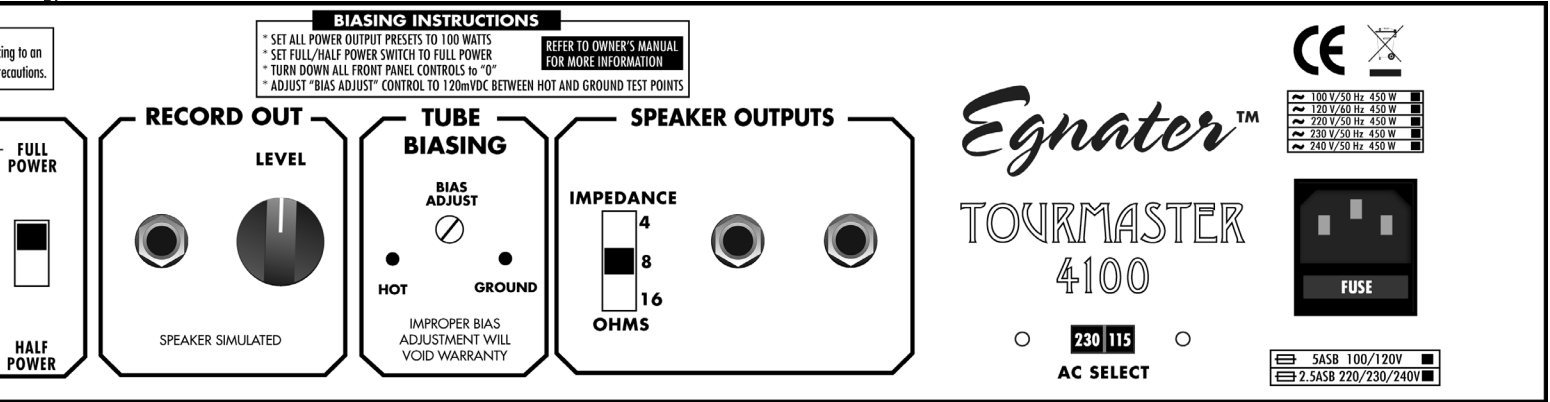

do you have a wide array of tones available from the preamp channels, but you can introduce any amount of power tube distortion you wish, all preset and automatic. One special note: The lower the power setting for any channel, the less preamp gain you will want to use. So reduce the channel GAIN control and increase the channel MASTER as you reduce the power. You will be much more pleased with the results, trust us.

RECORD OUT: This output is designed as a direct feed to a PA mixer or for recording. The output is specially filtered to simulate the response of a microphone placed at the edge of the cone of a 12" speaker. As we all know the ideal spot to mic a speaker is at the edge (not the center) of the cone, right?
TUBE BIASING: This neat feature allows setting the bias properly

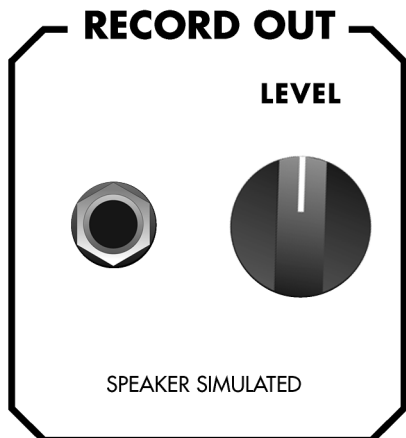

changes the power tubes. PLEASE read the detailed section on TUBE BIASING later in this manual to fully understand its function. This is important stuff for your safety and the life of your amp. Don't mess around until you understand how the Tube Biasing works and only have an authorized service center replace or check tubes.

SPEAKER OUTPUTS: This is where you connect your amp to your speakers. Let's start with a few really important precautions.
 1) NEVER, EVER operate your amp without speakers plugged in. This is a terrible thing to do to any tube amp and can cause severe damage to power tubes and transformers.
 2) Always set the rear panel imped-

total impedance of your cabinet(s). The correct setting for the 4212 combo using only the internal speakers is 8 ohms.
 3) Always use a good quality, heavy gauge speaker cable (not a shielded guitar cable) to connect your 4100 head to the cabinet(s).

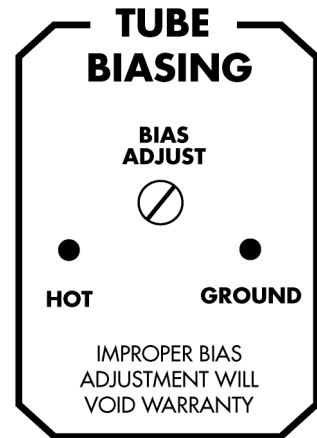
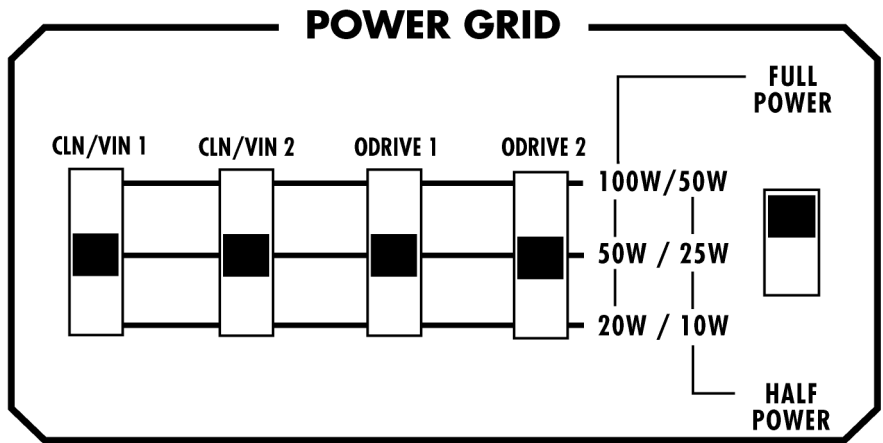

CONNECTING YOUR SPEAKERS

The two speaker outputs on the Tourmaster™ 4100 are wired in parallel. This means if you plug two cabinets into the amp (one per speaker output jack), the cabinets are effectively wired together (in parallel). See below for the proper impedance switch settings for different combinations of cabinets.

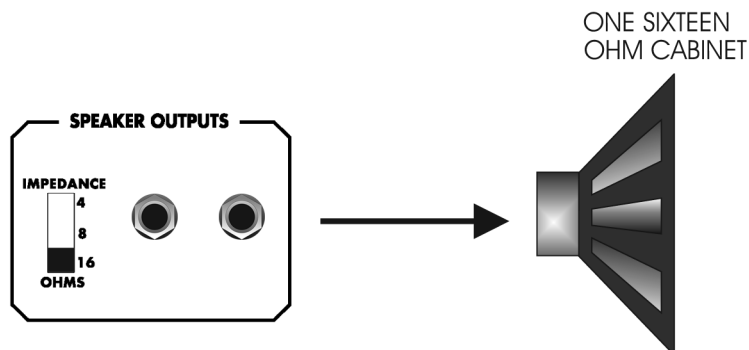
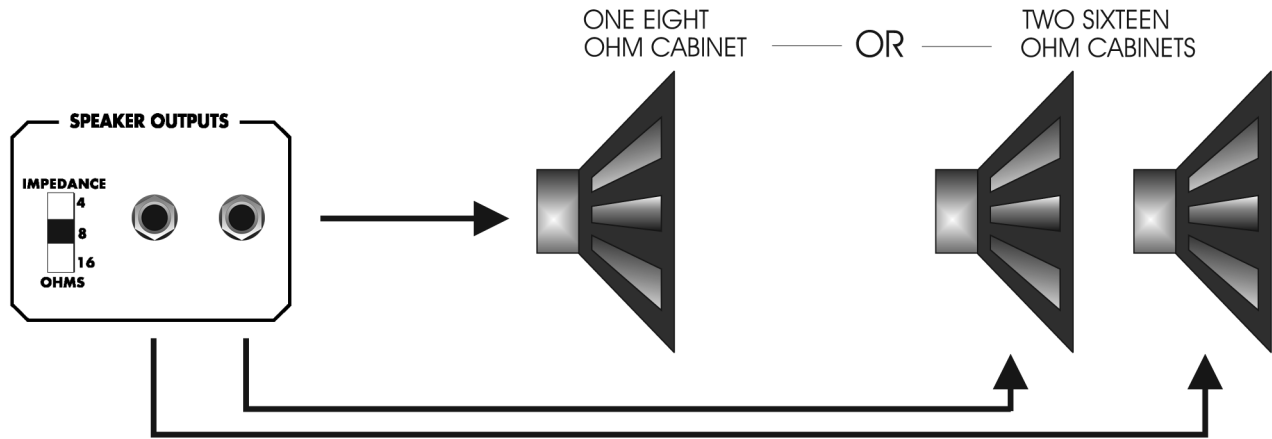
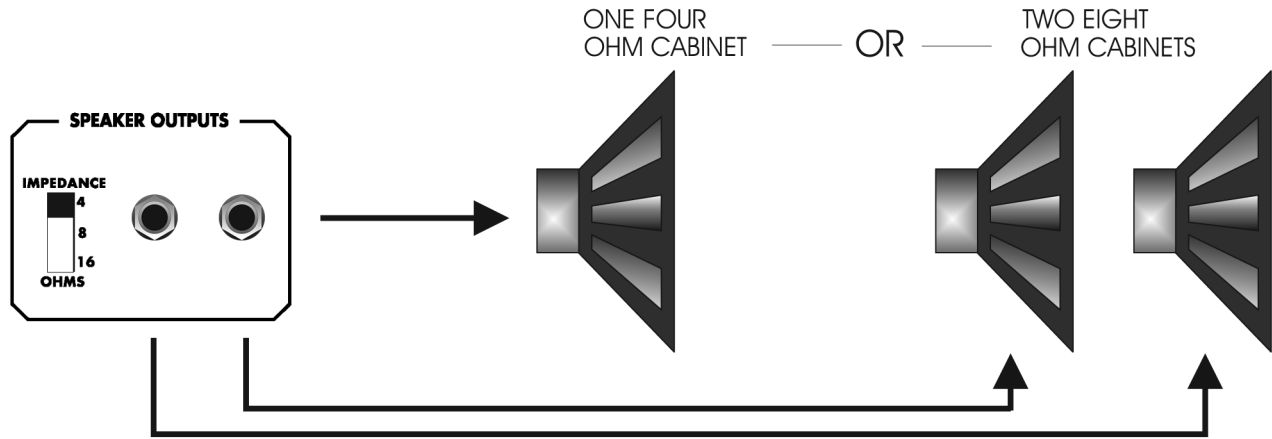

Power Cord / Main Fuse / Voltage Selector

AC Inlet Modules: Your Tourmaster™ head or combo have detachable IEC type grounded power cord that plugs into the AC inlet connector. Always use the appropriate type of power cord in your country or region. Below are a few precautions pertaining to this connection.

- 1) Always plug your amp into a properly grounded 3 prong AC outlet.
- 2) Never plug your amp into an ungrounded outlet.
- 3) Never remove or break off the 3rd prong safety ground pin from the power cord.
- 4) Never use a damaged or ungrounded power cord.
- 5) Always use the proper value and type fuse according to the rear panel markings.
- 6) Be sure the AC selector switch is set to the correct voltage in your country or region and replace the main fuse as specified below.



Egnater™

~ 100 V/50 Hz 450 W	■
~ 120 V/60 Hz 450 W	■
~ 220 V/50 Hz 450 W	■
~ 230 V/50 Hz 450 W	■
~ 240 V/50 Hz 450 W	■

TOURMASTER

4100

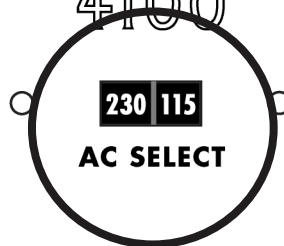

VOLTAGE
SELECTOR
SWITCH

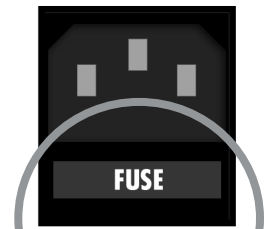

5ASB 100/120V	■
2.5ACR 220/230/240V	■

MAIN POWER
FUSE LOCATED
WITHIN THIS
HOLDER

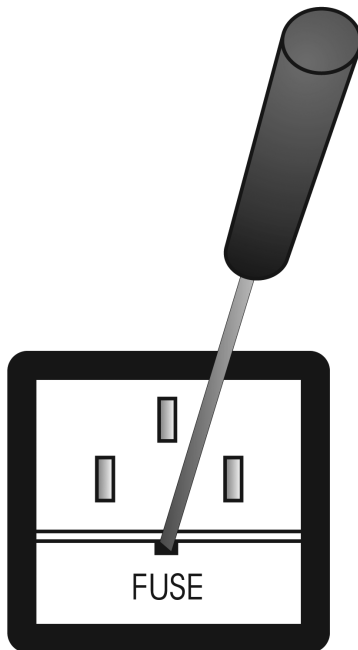

INSERT A SMALL SCREWDRIVER
INTO THE SLOT TO SLIDE THE
FUSE CAP OUT

THE CHANNELS

Earlier in this manual you found a brief description of the four individual channels. The following section will help explain the different features and how they affect your tone. Remember to take advantage of the master PRESENCE and DENSITY controls to enhance the depth and brightness of all the channels.

CLEAN / VINTAGE 1:

As we said earlier, this channel is the cleanest of the four. The BASS, MIDDLE and TREBLE controls are basically the familiar passive style tone controls found in 80% of guitar amps over the past few decades. We have chosen to voice them with a bit of a British flair to keep the low end more defined and provide tons of clean headroom. The most pristine tones are typically achieved by cutting the MIDRANGE and setting the VOICING switch to MODERN. Of course, you can turn down the MIDRANGE knob but often that is just not enough, especially with humbucking pickups. This is where the CONTOUR knob comes in. The additional control makes the Tourmaster™ tone circuit one of the most versatile around. To activate the CONTOUR control, depress the pushbutton next to the knob and turn the control to hear how effective the midrange cut can be for your clean sound. It can almost turn your humbuckings into single coils and your single coils into a more acoustic tone. For more of a Vintage style tone, flip the VOICING switch to CLASSIC. This revoices

the channel to have a bit more drive, more midrange and tighter low end much like the cool old amps from the 60's and 70's. The cleanest tones are achieved in either mode by setting the VOLUME knob full up (or close to it) and using the GAIN control to control the loudness. Even though the intent of this channel is for beautiful clean sounds, it can be pushed into mild overdrive by increasing the GAIN control and reducing the VOLUME accordingly. The breakup is quite raw and "in your face". Great for classic rock. Please refer to the SUGGESTED SETTINGS for a good starting point. These settings are merely just that... suggestions. They provide a good starting point to aim in the right direction.

CLEAN / VINTAGE 2:

This channel is voiced very much like the CLEAN / VINTAGE 1 channel except we've added more gain. It can play almost as clean as channel 1 but can also create some really cool overdrive tones. All of the control functions are basically the same as channel 1. Classic overdrive tones are best created with the VOICING switch set to CLASSIC and the CONTOUR control off. You'll get that great old midrange bark that was so much a part of the early British rock scene. If a more modern crunch is your style, try cutting the MID-RANGE or switching on the CONTOUR and backing down the CONTOUR knob. Keeping the BASS knob lower will help to tighten and define the low end. Your guitar

volume knob can be quite effective for cleaning up the tone. Classic Zep or even some sweet blues can be effortlessly coaxed out of this channel. You could probably play all night on this channel alone. Again, check out the SUGGESTED SETTINGS.

OVERDRIVE 1:

As we said, this channel covers a lot of bases all by itself. With the GAIN control set lower, VOICING set to CLASSIC and CONTOUR off, this channel is pure classic rock. British invasion revisited. See BRIT GRIND in the SUGGESTED SETTINGS. Brit grind not your thing? Switch in the CONTOUR, set the VOICING switch to MODERN, crank the GAIN and enter modern rock territory. Many great high gain tones are here - experiment to find yours. Cut the CONTOUR even more and enter the modern metal rhythm world.

OVERDRIVE 2:

High gain heaven (or hell). Depends on your point of view. In the CLASSIC mode you'll find the ultimate in aggressive drive. MIDRANGE up and CONTOUR off will produce the singing fluid sustain so prevalent in the days of hot rod solos. Switching to the MODERN mode pours on "over the top" gain and sustain for days. Try the MODERN SOLO setting in the SUGGESTED SETTINGS. Outrageous metal grind is simple to conjure up. Cut the MIDRANGE, activate the CONTOUR, turn up the BASS and TREBLE and prepare to crush the opposition.

THE EFFECTS LOOP OPERATION

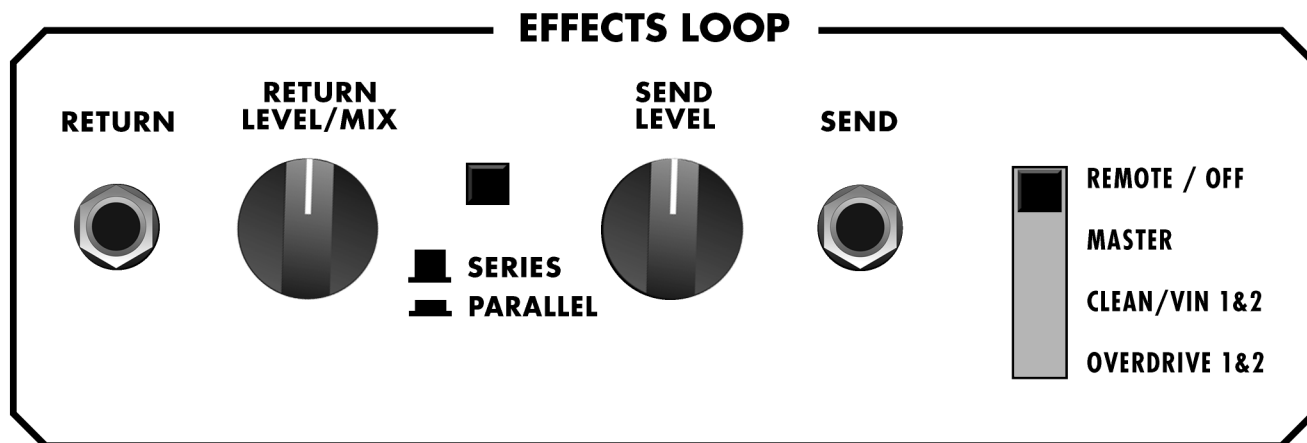

The Tourmaster™ effects interface allows you to connect and control your effects in a number of different ways.

1) You will need to make a few preliminary decisions on how you wish to use the loop. First you must select the SERIES or PARALLEL mode. Both are explained below. Each mode has its own advantages and disadvantages. Choose the one that best suits your effects gadgets.

1) SERIES LOOP MODE:

Basically an insert patch point. When an external effect is patched into the series send and return jacks, the path is interrupted and 100% of the signal is routed through the effect. This puts some special demands on the effects unit. It must be essentially transparent, meaning it shouldn't "mess" with your tone. The input and output levels must be properly set for maximum headroom and lowest noise and it needs to operate at line level. Proper setting of the levels can be achieved using the following method.

a) Set your amp/preamp volume levels for normal playing levels. Connect a high quality shielded cable from the series SEND jack to the EFFECT input.

b) Adjust the effects SEND level to "just peak" while playing your most aggressive licks.

c) Now connect another high quality shielded cable from the effect output to the return jack.

d) Adjust the effects unit output level and/or the loop RETURN level to match the volume you heard before connecting the return cable. You can check this by switching the loop in and out while playing and verifying there that is no substantial volume difference. This is called "unity gain". A cool "techie" phrase for "you get out what you put in".

e) If your effects unit does not have any sort of level indicators, try setting the return level to around 3:00 and adjust the send level until unity gain is achieved using the above method.

2) PARALLEL LOOP MODE:

This is a more specialized loop. It has the advantage of maintaining your dry signal (it doesn't mess with your tone), while allowing you to mix in the amount of effect you want. The Tourmaster™ parallel loop mode is a bit different than most guitar amp loops. Typically, parallel loops found on guitar amplifiers have a wet/dry mix control that turns down the dry signal (messing with your tone) while simultaneously turning up the effects level. The Tourmaster™ parallel loop is unique in that it never messes with your dry tone. It simply mixes in the amount

of effects using the RETURN LEVEL/MIX knob, much like the effects buss on a mixing console. The direct signal remains unaltered and the effects are simply mixed back in. There are a few basic rules that must be adhered to. This also puts some limitations on using the parallel loop.

a) Your effects unit must be set for 100% wet. This requires you to set the mix levels on the effect so that there is no dry signal passing through the unit. Think of the mixing console again. You would not want to have any dry signal going through the effects buss because you would then be mixing in not only the effect, but also the unwanted dry signal that comes out of the effects unit. This can even be detrimental to your tone because the dry output signal of many effects units are out of phase with the input. Consequently, as you turn up the effects return knob, you may actually be mixing the "icky" out of phase signal back in with your awesome dry signal and...you guessed it...messing with your tone. Often loops on guitar amps are said to "suck tone". This "tone sucking" is more likely caused by improperly setting the effects mix than the loop design.

3) Now let's address the specific

THE EFFECTS LOOP OPERATION *con't*

uses, advantages, disadvantages and limitations of each loop.

a) The series loop, by nature of the fact that it breaks the direct path and processes 100% of the signal, makes it so that essentially any line level gadget will work. You can use echo, reverb, noise reduction, tremolo, equalizers etc in this loop. Remember to follow the procedure for setting “unity gain”.

Advantages are: Works fine with just about any effect. No special requirements, other than the “unity gain” settings are needed.

Basically Plug and Play.

Disadvantage is that your entire signal passes through the effects unit and may mess with your tone.

b) The parallel loop, on the other hand, has more limited uses but has the distinct advantage of not messing with your tone. This loop is ideally suited for what are called “time based effects”. This includes echo, reverb, chorus, flanging. These types of effects work in parallel with your direct signal (think about the mixer again). Now the bad news...remember the dry signal is always present. You cannot use effects that require processing 100% such as equalizers, noise reduction/gates, tremolo or compressor/limiters.

Advantages are:

Doesn't mess with your tone.

Easy to adjust the effects level with the return level knob.

Disadvantage is limited use and may require reprogramming your effects unit.

4) Special Notes:

a) A concern is the fact that many multi-effects units have a combination of all of the different effects.

This means, using the parallel loop, you must be aware of which effects can and can't be used. For ease of operation, we recommend using the series loop if you intend to use a mix of different “time based” and non-time based effects in one unit.

b) The loop is designed for use with a professional level effects unit. Many guitar level effects pedals are not made to work in an effects loop. This is simply because they are made to plug a guitar into. The typical signal level in any effects loop is higher than what comes out of your guitar. You will know an effect is not made for pro level if, when you plug it into the loop, you notice distortion and a loss of volume. If you do experience a distortion problem with effects, this can often be remedied by reducing the master controls on the individual channels and increasing the main master setting.

Whew!!

Now that you have selected SERIES or PARALLEL, your final decision is how and when you want the loop to turn on or off. You have four options for controlling the loop.

1) Set the slide switch to REMOTE/OFF. This mode allows you to turn the loop on and off “on the fly” from the footpedal.

2) Setting the slide switch to MASTER simply turns the loop on full time and disables with the footswitch.

3) Placing the switch in the CLEAN/VIN 1&2 causes the loop to automatically turn on when you are using either one of the CLEAN/VINTAGE channels. This setting is useful when you have an effect such as a limiter or

compressor, or other effect, that typically sounds cool on clean sounds but doesn't work well on overdrive channels.

4) Setting the switch in the OVERDRIVE 1&2 position turns the loop on only when you play through either of the OVERDRIVE channels. This is an excellent way to have gate or noise reduction gadget on the OVERDRIVE channels only when using really high gain.

IMPORTANT NOTE:

When the slide switch is in the REMOTE/OFF position, the EFFECTS button on the footpedal is active and can be used to turn the loop on and off “on the fly” regardless of which channel you are playing through. When the slide switch is set to MASTER, the loop is always on and the EFFECTS button on the pedal is not active. Placing the slide switch in the CLEAN/VIN 1&2 position will automatically turn on the loop whenever either one of the CLEAN/VINTAGE channels is on. In this mode, the EFFECTS button on the footswitch will be inactive when playing through either CLEAN/VINTAGE channel. When the slide switch is set to OVERDRIVE 1&2, the loop will automatically switch on when playing through either of the OVERDRIVE channels. In this mode, the EFFECTS pushbutton will not be active when playing through either of the OVERDRIVE channels. So, from this explanation we see that the EFFECTS pushbutton on the pedal can be used to turn the loop on and off only in the modes where the loop is not preprogrammed to turn on automatically.

POWER TUBE BIAS

TOURMASTER TUBE LAYOUT

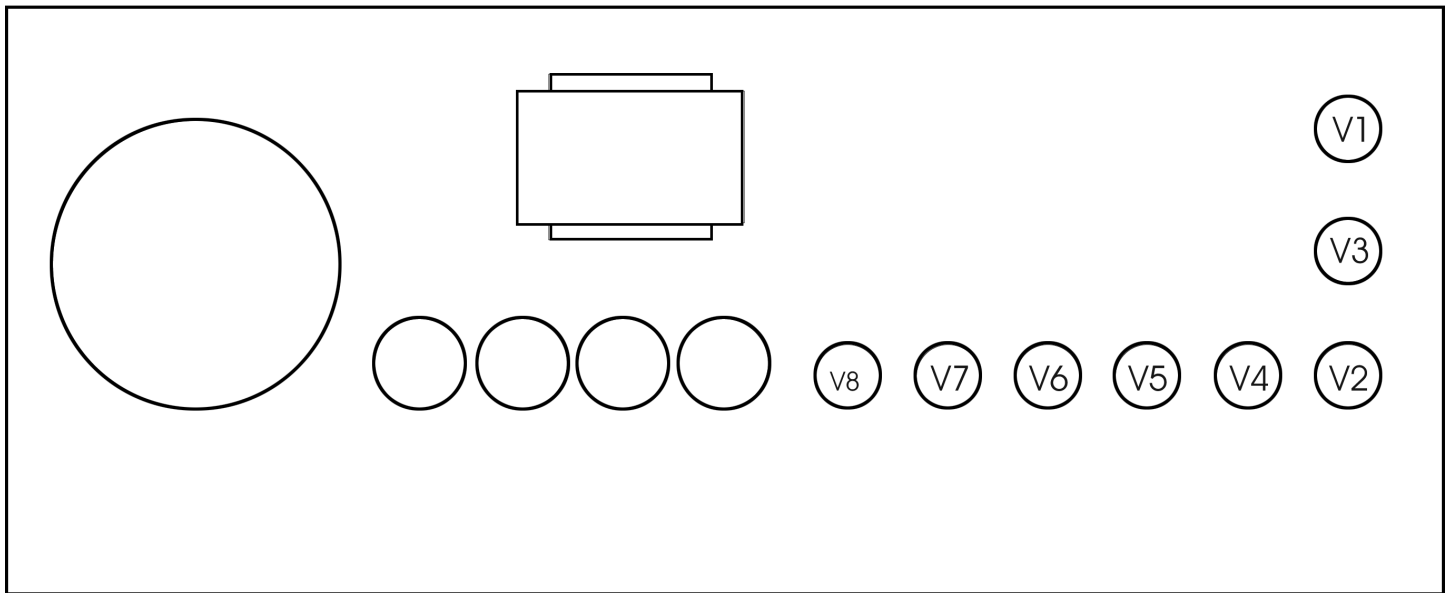

GROOVETUBES™ 12AX7 / ECC83 TUBE LOCATIONS AND FUNCTIONS

V1 - INPUT GAIN STAGE TO ALL CHANNELS AND FIRST GAIN STAGE OF CLEAN/VINTAGE CHANNELS

V2 - FIRST AND SECOND GAIN STAGES OF OVERDRIVE CHANNELS

V3 - SECOND AND THIRD GAIN STAGES OF OVERDRIVE CHANNELS

V4 - THIRD GAIN STAGE AND CATHODE FOLLOWER OF OVERDRIVE CHANNELS

V5 - CONTOUR CIRCUIT BUFFERS FOR OVERDRIVE CHANNELS

V6 - REVERB DRIVE AND RETURN

V7 - EFFECTS SEND BUFFER AND EFFECTS RETURN MIXER

V8 - PHASE SPLITTER

WHAT IS BIAS?

Simply put, it is a circuit inside the power amplifier section that controls the “idle current” that flows through the power tubes, much like the idle speed on a car. There is an optimum setting where the engine (amplifier) is running (idling) fast (hot) enough to keep it from stalling (distorting) but not too fast (hot) to cause excessive wear and overheating. Get it?

WHY DON'T ALL AMPLIFIERS HAVE BIAS OR IDLE CURRENT ADJUSTMENTS?

Most do have some provision for that but typically involve remov-

ing the amp chassis from the box, exposing you to very dangerous high voltage. Special test equipment and knowledge of amp circuits and tubes is also needed. Not a skill most musicians possess and shouldn't need to.

WHY WOULD I WANT TO ADJUST THE BIAS?

Your Tourmaster™ comes with specially tested and graded high performance 5881s from Groove Tubes. You are welcome to try other types of tubes though, for reliability, we recommend staying with a 5881/6L6/KT66 tube type. Each type has unique sonic and

electrical characteristics. Because they are all different, each requires a correct bias setting for safety, reliability and optimum performance. **The following instructions are for authorized technicians only, do not attempt yourself:**

You will need a decent quality digital voltmeter capable of measuring in the 100 to 200 millivolts DC range. .

You will also need a small, flat blade screwdriver to turn the adjustment control that is recessed inside the grommet on the rear panel.

1) Turn the amp on, standby switch in the play position. All con-

trols all the way down. POWER GRID slide switches to 100 watts and the FULL/HALF power switch to FULL power. Turn the meter on and set for reading DC millivolts. Consult the meter instructions for how to do this properly. Since all meters are different it is extremely important that you thoroughly understand what you are looking at on the meter display.

- a) Insert the black (negative) test lead into the panel hole labeled GROUND.
- b) Insert the red (positive) test lead into the panel hole labeled HOT.
- c) With your flat blade screw driver, turn the BIAS ADJUST control to obtain a reading between 115mVDC and 130mVDC.

IMPORTANT: The bias adjustment control is active **ONLY** with the POWER GRID switches in the 100 watt settings and the FULL/HALF power switch in the FULL position.

4) When making these measurements, be aware you are seeing the sum current of all four power tubes. It is recommended that power tubes be replaced in matched sets. Let's say you have a set of new tubes and you set the BIAS control for a reading of 120mVDC. If all the tubes are matched and drawing the same current, each one is idling at 30mADC, which is quite comfortable. Now consider if your tubes are very mismatched. One tube could be drawing a very low 10mADC for example, while another might be idling at

50mADC, which will not make for a long lasting, happy tube. In addition, your tone will suffer because your amp can only perform as well as the weakest link. It's kind of like having one low tire on your car. Of course it will still drive but the performance will be adversely affected.

Displays differ from one meter to the next. Some may indicate, for example, 120.0 for 120 millivolts. Others may show .120 for 120 millivolts. Knowing how your meter works is of the utmost importance. You should always check the bias readings whenever you replace output tubes and readjust if needed.

ADVANCED THEORY (FOR THOSE WHO CARE):

Those authorized service technicians with electronic knowledge may notice we are referring to current draw but are making measurements in millivolts. Ohms law states that $I=E/R$ or current (I) equals voltage (E) divided by resistance (R). Inside the amp is a one ohm resistor in the cathodes of the output tubes. The external test point allows access to this resistor. When you measure across the resistor at the rear panel test points, you are reading the DC voltage drop across a one ohm resistor. Referring to ohms law, if $R=1$ in the formula, then $I = E$ or current equals voltage. So when you read for example, 120mV you are also seeing the equivalent value of current or 120mA.

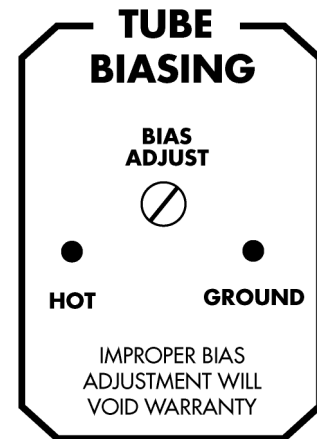

WARNING: DO NOT be tempted to run your tubes hotter than the maximum recommended value. You may find it sounds really cool as you destroy your expensive tubes and possibly damage your amp, of course voiding your warranty! Also, in case you haven't found out the hard way yet, power tubes get extremely hot (as high as 800 degrees)!!!!

WARNING: Do not remove rear metal grill.

WARNING: Do not attempt to check or replace tubes by yourself. Refer to authorized service center.

WARNING: Never touch the tubes while the amplifier is turned ON. You can severely burn your fingers and hands!

LIMITED WARRANTY

Thank you for choosing Egnater. Egnater manufactures some of the world's most innovative all-tube amplifier, combos and speaker cabinets. Egnater takes great pride in thoroughly testing each product prior to shipment.

AMPLIFIERS, COMBOS AND SPEAKER

CABINETS: Egnater offers a three (3) year warranty to the original purchaser that an Egnater product will be free from defects in material and workmanship. A dated sales receipt will establish coverage under this warranty. This warranty does not cover service or parts to repair damage caused by accident, neglect, abuse, normal & wear, disaster, misuse, abuse, over-powering, negligence, inadequate packing or shipping procedures and service, repair or modifications to the product which have not been authorized or approved by Egnater. If this product is defective in materials or workmanship as warranted above, your sole remedy shall be repair or replacement as provided below.

TUBES: Egnater warrants the original purchaser that the tubes used in an Egnater amplifier/combo will be free from defects in material and workmanship for a period of 90 days from the original date of purchase. A dated sales receipt will establish coverage under this warranty. This warranty will automatically terminate 90 days after the original retail sales date. This warranty is in lieu of all other expressed warranties. If tubes fail within the 90 day warrant period your sole remedy shall be replacement of tubes as provided below.

RETURN PROCEDURES: In the unlikely event that a defect should occur, follow the procedure outlined below. Defective products must be shipped, together with proof of purchase, freight pre-paid and insured to the Authorized Egnater Service Center or directly to Egnater. If a product must be returned to Egnater for warranty replacement/repair, a Return Authorization Number must be obtained from our Customer Service Department prior to shipping the product.

Please contact our Customer Service Department for the Authorized Egnater Service Center nearest you. Products

must be shipped in their original packaging or its equivalent; in any case, the risk of loss or damage in transit is to be borne by the purchaser. The Return Authorization Number must appear in large print directly below the shipping address. Always include a brief description of the defect, along with your correct return address and telephone number.

When calling to inquire about a returned product, always refer to the Return Authorization Number. If Egnater determines that the unit was defective in materials or workmanship at any time during the warranty period, Egnater has the option of repairing or replacing the product at no additional charge, except as set forth below. All replaced parts become a property of Egnater. Products replaced or repaired under this warranty will be returned via ground shipping within the United States-freight prepaid. Egnater is not responsible for costs associated with expedited shipping, either to Egnater or the return of the product to the customer.

INCIDENTAL OR CONSEQUENTIAL DAMAGE:

In no event will Egnater be liable for any incidental or consequential damages arising out of the use or inability to use of any Egnater product, even if an Egnater dealer has been advised of the possibility of such damages, or any other claim by any other party. Some states do not allow the exclusion or limitation of consequential damages, so the above limitation and exclusion may not apply to you. This warranty gives you specific legal rights and you may also have other rights which may vary from state to state.

FOR YOUR PROTECTION: Please complete and mail the Purchase Information Card within (10) ten days of the date of purchase so that we may contact you directly in the event a safety notification issued in accordance with the 1972 Consumer Product Safety Act.

CUSTOMER SUPPORT: Our dedicated staff is ready to help you with any warranty or product questions you may have. Please call 323-277-4119 (9:00AM to 4:00PM Pacific Standard Time).

*Egnater*TM
CUSTOM AMPLIFICATION

Egnater Custom Amplification
Boutique Amps Distribution
3402 Slauson Ave., Maywood, CA 90270
Phone: 323-277-4119
Fax: 323-277-4110
www.EgnaterAmps.com