

e 609 silver



Bedienungsanleitung
Instruction manual
Notice d'emploi
Istruzioni per l'uso
Instrucciones de uso
Manual de utilização
Gebruiksaanwijzing
Инструкция по эксплуатации
使用说明

evolution
Stage Microphones

SENNHEISER
The Pursuit of Perfect Sound

A



B

1



2



3



C

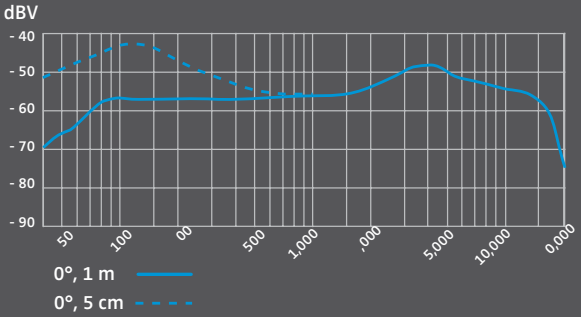
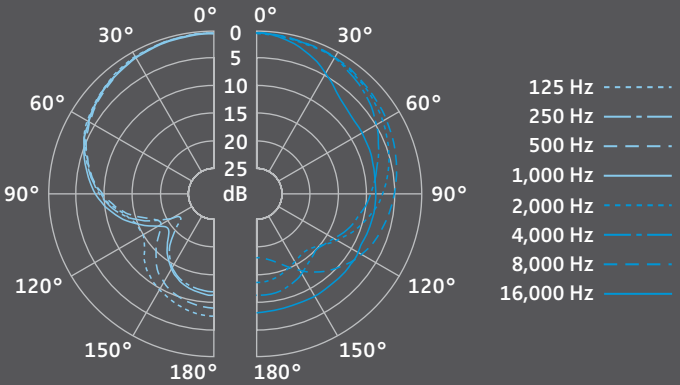

Important safety information

- Please read this instruction manual carefully and completely before using the product.
- Make this instruction manual easily accessible to all users at all times.
- Always include this instruction manual when passing the product on to third parties.

Before operation

- Never open the housing of the product. If products are opened by customers in breach of this instruction, the warranty becomes null and void.
- Only use attachments, accessories or spare parts specified by Sennheiser.

During operation

- Liquids entering the product can short-circuit the electronics or damage the mechanics. Keep all liquids away from the product.
- Solvents or cleansing agents can damage the surface of the product. Only use a soft, slightly damp cloth to clean the product.
- Do not expose the product to extreme temperatures.

After operation

- Handle the product with care and store it in a clean, dust-free environment.

Intended use

Intended use includes:

- having read this instruction manual, especially the chapter "Important safety information",
- using the product within the operating conditions and limitations described in this instruction manual.

"Improper use" means using the product other than as described in this instruction manual, or under operating conditions which differ from those described herein.

The e 609 silver

The e 609 silver is a dynamic microphone with super-cardioid pick-up pattern, offering a particularly direct sound when miking guitars amps. The lightweight voice coil construction and rigid dome provide an extended high frequency performance.

Its laterally mounted capsule has been specially developed for miking guitars amps face-on and extremely close to the signal source. The super-cardioid pick-up pattern provides good isolation from other on-stage signals.

Due to its flat design, the e 609 silver is easy to position.

Features

- rugged metal body
- shock-mounted capsule
- super-cardioid pick-up pattern
- humbucking coil

Delivery includes

- 1 microphone e 609 silver
- 1 pouch
- 1 instruction manual

Product overview A*

- 1 sound inlet basket
- 2 XLR-3 connector

Using the microphone

Positioning the microphone B

In order to prevent interference due to crosstalk between adjacent sound sources, try to position the microphone so that the interfering sound source is located in the angle area of the highest cancellation of the microphone (approx. 135°; see polar diagram).

* Diagrams can be found on the cover pages.

Pos.	Resulting sound	Commentary
B.1	<ul style="list-style-type: none"> • many trebles • aggressive sound 	microphone directed towards the dome of the loudspeaker
B.2	<ul style="list-style-type: none"> • less trebles, more lower mids, smoother sound • balanced, natural sound 	good starting position: <ul style="list-style-type: none"> • microphone directed towards the middle between dome and edge of the loudspeaker • If necessary, turn the microphone by approx. 30° towards the edge.
B.3	less trebles, more lower mids, smoother sound	microphone directed towards the edge of the loudspeaker

Cleaning and maintaining the e 609 silver

Caution Liquids can damage the electronics of the product!
 Liquids entering the housing of the product can cause a short-circuit and damage the electronics.

- ▶ Keep all liquids away from the product.
- ▶ Do not use any solvents or cleansing agents.

▶ Only use a soft, slightly damp cloth to clean the product.

Specifications

Transducer principle	dynamic
Frequency response	40 ... 15.000 Hz
Pick-up pattern	super-cardioid
Sensitivity (free field, no load at 1 kHz)	1,5 mV/Pa
Nominal impedance (at 1 kHz)	350 Ω
Min. terminating impedance	1 kΩ
Connector	XLR-3
Dimensions	h: 55 mm, l: 134 mm, w: 135mm
Weight	140 g

The polar diagram and the frequency response curve C can be found on the cover pages.

Connector assignment

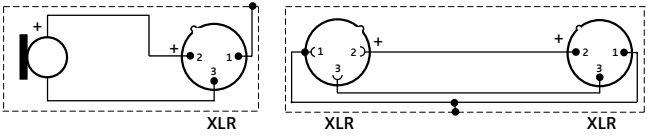

Manufacturer Declarations

Warranty

Sennheiser electronic GmbH & Co. KG gives a warranty of 24 months on this product.

For the current warranty conditions, please visit our website at www.sennheiser.com or contact your Sennheiser partner.

FOR AUSTRALIA ONLY

Sennheiser goods come with guarantees that cannot be excluded under the Australian Consumer Law. You are entitled to a replacement or refund for a major failure and compensation for any other reasonably foreseeable loss or damage. You are also entitled to have the goods repaired or replaced if the goods fail to be of acceptable quality and the failure does not amount to a major failure.

This warranty is in addition to other rights or remedies under law. Nothing in this warranty excludes, limits or modifies any liability of Sennheiser which is imposed by law, or limits or modifies any remedy available to the consumer which is granted by law.

To make a claim under this warranty, contact Sennheiser Australia Pty Ltd, Unit 3, 31 Gibbes Street Chatswood NSW 2067, AUSTRALIA.

Phone: (02) 9910 6700, email: service@sennheiser.com.au.

All expenses of claiming the warranty will be borne by the person making the claim.

The Sennheiser International Warranty is provided by Sennheiser Australia Pty Ltd (ABN 68 165 388 312), Unit 3, 31 Gibbes Street Chatswood NSW 2067 Australia.

In compliance with the following requirements



















- WEEE Directive (2012/19/EU)

Please dispose of this product at the end of its operational lifetime by taking it to your local collection point or recycling center for such equipment.

CE Declaration of Conformity

- RoHS Directive (2011/65/EU)
- EMC Directive (2004/108/EC)

The declaration is available at www.sennheiser.com.

	e 602-II	e 604	e 608	e 609 silver	e 614	e 835	e 845	e 865
						•	•	•
						•	•	•
					•		•	
					•			
	•	•	•					
					•			
	•				•			
				•				
	•							
	•							
					•			
	•							
		•	•	•				
		•	•	•				
	•	•		•				
		•	•	•	•			
					•			
	•	•				•		
			•	•	•		•	•

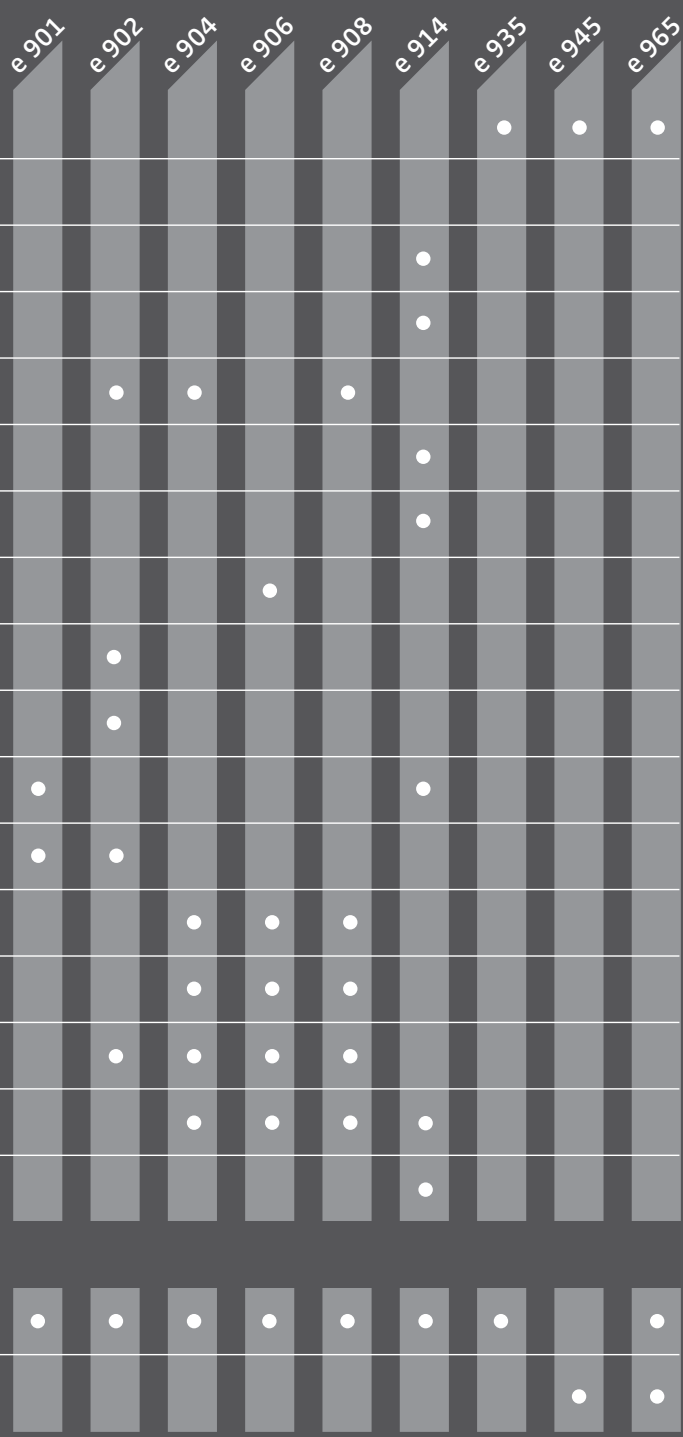



Sennheiser electronic GmbH & Co. KG

Am Labor 1, 30900 Wedemark, Germany
www.sennheiser.com

Printed in Germany, Publ. 08/15, 511653/A01