



Digital Percussion

DD-75

Owner's Manual



Before using the instrument, be sure to read "PRECAUTIONS" on page 5–6.



SPECIAL MESSAGE SECTION

This product utilizes batteries or an external power supply (adapter). DO NOT connect this product to any power supply or adapter other than one described in the manual, on the name plate, or specifically recommended by Yamaha.

WARNING: Do not place this product in a position where anyone could walk on, trip over, or roll anything over power or connecting cords of any kind. The use of an extension cord is not recommended! If you must use an extension cord, the minimum wire size for a 25' cord (or less) is 18 AWG. NOTE: The smaller the AWG number, the larger the current handling capacity. For longer extension cords, consult a local electrician.

This product should be used only with the components supplied or; a cart, rack, or stand that is recommended by Yamaha. If a cart, etc., is used, please observe all safety markings and instructions that accompany the accessory product.

SPECIFICATIONS SUBJECT TO CHANGE:

The information contained in this manual is believed to be correct at the time of printing. However, Yamaha reserves the right to change or modify any of the specifications without notice or obligation to update existing units.

This product, either alone or in combination with an amplifier and headphones or speaker/s, may be capable of producing sound levels that could cause permanent hearing loss. DO NOT operate for long periods of time at a high volume level or at a level that is uncomfortable. If you experience any hearing loss or ringing in the ears, you should consult an audiologist.

IMPORTANT: The louder the sound, the shorter the time period before damage occurs.

Some Yamaha products may have benches and / or accessory mounting fixtures that are either supplied with the product or as optional accessories. Some of these items are designed to be dealer assembled or installed. Please make sure that benches are stable and any optional fixtures (where applicable) are well secured **BEFORE** using.

Benches supplied by Yamaha are designed for seating only. No other uses are recommended.

NOTICE:

Service charges incurred due to a lack of knowledge relating to how a function or effect works (when the unit is operating as designed) are not covered by the manufacturer's warranty, and are therefore the owners responsibility. Please study this manual carefully and consult your dealer before requesting service.

ENVIRONMENTAL ISSUES:

Yamaha strives to produce products that are both user safe and environmentally friendly. We sincerely believe that our products and the production methods used to produce them, meet these goals. In keeping with both the letter and the spirit of the law, we want you to be aware of the following:

Battery Notice:

This product **MAY** contain a small non-rechargeable battery which (if applicable) is soldered in place. The average life span of this type of battery is approximately five years. When replacement becomes necessary, contact a qualified service representative to perform the replacement.

This product may also use "household" type batteries. Some of these may be rechargeable. Make sure that the battery being charged is a rechargeable type and that the charger is intended for the battery being charged.

When installing batteries, never mix old batteries with new ones, and never mix different types of batteries. Batteries **MUST** be installed correctly. Mismatches or incorrect installation may result in overheating and battery case rupture.

Warning:

Do not attempt to disassemble, or incinerate any battery. Keep all batteries away from children. Dispose of used batteries promptly and as regulated by the laws in your area. Note: Check with any retailer of household type batteries in your area for battery disposal information.

Disposal Notice:

Should this product become damaged beyond repair, or for some reason its useful life is considered to be at an end, please observe all local, state, and federal regulations that relate to the disposal of products that contain lead, batteries, plastics, etc. If your dealer is unable to assist you, please contact Yamaha directly.

NAME PLATE LOCATION:

The name plate is located on the bottom of the product. The model number, serial number, power requirements, etc., are located on this plate. You should record the model number, serial number, and the date of purchase in the spaces provided below and retain this manual as a permanent record of your purchase.

Model

Serial No.

Purchase Date

PLEASE KEEP THIS MANUAL

92-BP (bottom)

For AC adaptor and DD-75

FCC INFORMATION (U.S.A.)

1. IMPORTANT NOTICE: DO NOT MODIFY THIS UNIT!

This product, when installed as indicated in the instructions contained in this manual, meets FCC requirements. Modifications not expressly approved by Yamaha may void your authority, granted by the FCC, to use the product.

2. IMPORTANT: When connecting this product to accessories and/or another product use only high quality shielded cables. Cable/s supplied with this product **MUST** be used. Follow all installation instructions. Failure to follow instructions could void your FCC authorization to use this product in the USA.

3. NOTE: This product has been tested and found to comply with the requirements listed in FCC Regulations, Part 15 for Class "B" digital devices. Compliance with these requirements provides a reasonable level of assurance that your use of this product in a residential environment will not result in harmful interference with other electronic devices. This equipment generates/uses radio frequencies and, if not installed and used according to the instructions found in the users manual, may cause interference harmful to the operation of other electronic devices. Compliance with FCC regulations does not guarantee

that interference will not occur in all installations. If this product is found to be the source of interference, which can be determined by turning the unit "OFF" and "ON", please try to eliminate the problem by using one of the following measures:

Relocate either this product or the device that is being affected by the interference.

Utilize power outlets that are on different branch (circuit breaker or fuse) circuits or install AC line filter/s.

In the case of radio or TV interference, relocate/reorient the antenna. If the antenna lead-in is 300 ohm ribbon lead, change the lead-in to co-axial type cable.

If these corrective measures do not produce satisfactory results, please contact the local retailer authorized to distribute this type of product. If you can not locate the appropriate retailer, please contact Yamaha Corporation of America, Electronic Service Division, 6600 Orangethorpe Ave, Buena Park, CA90620

The above statements apply **ONLY** to those products distributed by Yamaha Corporation of America or its subsidiaries.

* This applies only to products distributed by YAMAHA CORPORATION OF AMERICA.

(class B)

OBSERVERA!

Apparaten kopplas inte ur växelströmskällan (nätet) så länge som den är ansluten till vägguttaget, även om själva apparaten har stängts av.

ADVARSEL: Netspændingen til dette apparat er IKKE afbrudt, så længe netledningen sidder i en stikkontakt, som er tændt — også selvom der er slukket på apparatets afbryder.

VAROITUS: Laitteen toisiopiiriin kytketty käyttökytin ei irroita koko laitetta verkosta.

(standby)

The model number, serial number, power requirements, etc., may be found on or near the name plate, which is at the bottom of the unit. You should note this serial number in the space provided below and retain this manual as a permanent record of your purchase to aid identification in the event of theft.

Model No. _____

Serial No. _____

(bottom_en_01)

For AC adaptor

This device complies with Part 15 of the FCC Rules. Operation is subject to the following two conditions: (1) this device may not cause harmful interference, and (2) this device must accept any interference received, including interference that may cause undesired operation.

(fcc_sengen_C)

CAN ICES-3 (B)/NMB-3(B)

(can_b_02)

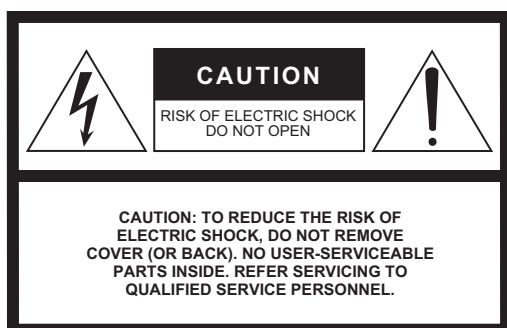

Explanation of Graphical Symbols



The lightning flash with arrowhead symbol within an equilateral triangle is intended to alert the user to the presence of uninsulated “dangerous voltage” within the product’s enclosure that may be of sufficient magnitude to constitute a risk of electric shock to persons.



The exclamation point within an equilateral triangle is intended to alert the user to the presence of important operating and maintenance (servicing) instructions in the literature accompanying the product.

IMPORTANT SAFETY INSTRUCTIONS

- 1 Read these instructions.
- 2 Keep these instructions.
- 3 Heed all warnings.
- 4 Follow all instructions.
- 5 Do not use this apparatus near water.
- 6 Clean only with dry cloth.
- 7 Do not block any ventilation openings. Install in accordance with the manufacturer’s instructions.
- 8 Do not install near any heat sources such as radiators, heat registers, stoves, or other apparatus (including amplifiers) that produce heat.
- 9 Do not defeat the safety purpose of the polarized or grounding-type plug. A polarized plug has two blades with one wider than the other. A grounding type plug has two blades and a third grounding prong. The wide blade or the third prong are provided for your safety. If the provided plug does not fit into your outlet, consult an electrician for replacement of the obsolete outlet.
- 10 Protect the power cord from being walked on or pinched particularly at plugs, convenience receptacles, and the point where they exit from the apparatus.
- 11 Only use attachments/accessories specified by the manufacturer.
- 12 Use only with the cart, stand, tripod, bracket, or table specified by the manufacturer, or sold with the apparatus. When a cart is used, use caution when moving the cart/apparatus combination to avoid injury from tip-over.
- 13 Unplug this apparatus during lightning storms or when unused for long periods of time.
- 14 Refer all servicing to qualified service personnel. Servicing is required when the apparatus has been damaged in any way, such as power-supply cord or plug is damaged, liquid has been spilled or objects have fallen into the apparatus, the apparatus has been exposed to rain or moisture, does not operate normally, or has been dropped.



WARNING

TO REDUCE THE RISK OF FIRE OR ELECTRIC SHOCK, DO NOT EXPOSE THIS APPARATUS TO RAIN OR MOISTURE.

(UL60065_03)

PRECAUTIONS

PLEASE READ CAREFULLY BEFORE PROCEEDING

Please keep this manual in a safe and handy place for future reference.

For AC adaptor



WARNING

- This AC adaptor is designed for use with only Yamaha electronic instruments. Do not use for any other purpose.
- Indoor use only. Do not use in any wet environments.
- Do not put burning items, such as candles, on the unit. A burning item may fall over and cause a fire.



CAUTION

- When setting up, make sure that the AC outlet is easily accessible. If some trouble or malfunction occurs, immediately turn off the power switch of the instrument and disconnect the AC adaptor from the outlet. When the AC adaptor is connected to the AC outlet, keep in mind that electricity is flowing at the minimum level, even if the power switch is turned off. When you are not using the instrument for a long time, make sure to unplug the power cord from the wall AC outlet.

For DD-75



WARNING

Always follow the basic precautions listed below to avoid the possibility of serious injury or even death from electrical shock, short-circuiting, damages, fire or other hazards. These precautions include, but are not limited to, the following:

Power supply/AC adaptor

- Do not place the power cord near heat sources such as heaters or radiators. Also, do not excessively bend or otherwise damage the cord, or place heavy objects on it.
- Only use the voltage specified as correct for the instrument. The required voltage is printed on the name plate of the instrument.
- Use the specified adaptor (page 54) only. Using the wrong adaptor can result in damage to the instrument or overheating.
- Check the electric plug periodically and remove any dirt or dust which may have accumulated on it.

Do not open

- This instrument contains no user-serviceable parts. Do not open the instrument or attempt to disassemble or modify the internal components in any way. If it should appear to be malfunctioning, discontinue use immediately and have it inspected by qualified Yamaha service personnel.

Water warning

- Do not expose the instrument to rain, use it near water or in damp or wet conditions, or place on it any containers (such as vases, bottles or glasses) containing liquids which might spill into any openings. If any liquid such as water seeps into the instrument, turn off the power immediately and unplug the power cord from the AC outlet. Then have the instrument inspected by qualified Yamaha service personnel.
- Never insert or remove an electric plug with wet hands.

Fire warning

- Do not put burning items, such as candles, on the unit. A burning item may fall over and cause a fire.

Battery

- Follow the precautions below. Failure to do so might result in explosion, fire, overheating or battery fluid leakage.
 - Do not tamper with or disassemble batteries.
 - Do not dispose of batteries in fire.
 - Do not attempt to recharge batteries that are not designed to be charged.
 - Keep the batteries separate from metallic objects such as necklaces, hairpins, coins, and keys.
 - Use the specified battery type (page 54) only.
 - Use new batteries, all of which are the same type, same model, and made by the same manufacturer.
 - Always make sure all batteries are inserted in conformity with the +/- polarity markings.
 - When the batteries run out, or if the instrument is not to be used for a long time, remove the batteries from the instrument.
 - When using Ni-MH batteries, follow the instructions that came with the batteries. Use only the specified charger device when charging.
- Keep batteries away from small children who might accidentally swallow them.
- If the batteries do leak, avoid contact with the leaked fluid. If the battery fluid should come in contact with your eyes, mouth, or skin, wash immediately with water and consult a doctor. Battery fluid is corrosive and may possibly cause loss of sight or chemical burns.

If you notice any abnormality

- When one of the following problems occur, immediately turn off the power switch and disconnect the electric plug from the outlet. (If you are using batteries, remove all batteries from the instrument.) Then have the device inspected by Yamaha service personnel.
 - The power cord or plug becomes frayed or damaged.
 - It emits unusual smells or smoke.
 - Some object has been dropped into the instrument.
 - There is a sudden loss of sound during use of the instrument.

CAUTION

Always follow the basic precautions listed below to avoid the possibility of physical injury to you or others, or damage to the instrument or other property. These precautions include, but are not limited to, the following:

Power supply/AC adaptor

- Do not connect the instrument to an electrical outlet using a multiple-connector. Doing so can result in lower sound quality, or possibly cause overheating in the outlet.
- When removing the electric plug from the instrument or an outlet, always hold the plug itself and not the cord. Pulling by the cord can damage it.
- Remove the electric plug from the outlet when the instrument is not to be used for extended periods of time, or during electrical storms.

Location

- Do not place the instrument in an unstable position where it might accidentally fall over.
- Before moving the instrument, remove all connected cables, to prevent damage to the cables or injury to anyone who might trip over them.
- When setting up the product, make sure that the AC outlet you are using is easily accessible. If some trouble or malfunction occurs, immediately turn off the power switch and disconnect the plug from the outlet. Even when the power switch is turned off, electricity is still flowing to the product at the minimum level. When you are not using the product for a long time, make sure to unplug the power cord from the wall AC outlet.

Connections

- Before connecting the instrument to other electronic components, turn off the power for all components. Before turning the power on or off for all components, set all volume levels to minimum.
- Be sure to set the volumes of all components at their minimum levels and gradually raise the volume controls while playing the instrument to set the desired listening level.

Handling caution

- Do not insert a finger or hand in any gaps on the instrument.
- Never insert or drop paper, metallic, or other objects into the gaps on the panel. This could cause physical injury to you or others, damage to the instrument or other property, or operational failure.
- Do not rest your weight on, or place heavy objects on the instrument, and do not use excessive force on the buttons, switches or connectors.
- Do not use the instrument/device or headphones for a long period of time at a high or uncomfortable volume level, since this can cause permanent hearing loss. If you experience any hearing loss or ringing in the ears, consult a physician.

Yamaha cannot be held responsible for damage caused by improper use or modifications to the instrument, or data that is lost or destroyed.

Always turn the power off when the instrument is not in use.

Even when the [] (Standby/On) switch is in standby status (display is off), electricity is still flowing to the instrument at the minimum level.

When you are not using the instrument for a long time, make sure you unplug the power cord from the wall AC outlet.

Make sure to discard used batteries according to local regulations.

NOTICE

To avoid the possibility of malfunction/ damage to the product, damage to data, or damage to other property, follow the notices below.

■ Handling

- Do not use the instrument in the vicinity of a TV, radio, stereo equipment, mobile phone, or other electric devices. Otherwise, the instrument, TV, or radio may generate noise. When you use the instrument along with an application on your iPad, iPhone or iPod touch, we recommend that you set "Airplane Mode" to "ON" on that device in order to avoid noise caused by communication.
- Do not expose the instrument to excessive dust or vibrations, or extreme cold or heat (such as in direct sunlight, near a heater, or in a car during the day) to prevent the possibility of panel discoloration, damage to the internal components or unstable operation. (Verified operating temperature range: 5° – 40°C, or 41° – 104°F.)
- Do not place vinyl, plastic or rubber objects on the instrument, since this might discolor the panel or pads.

■ Maintenance

- When cleaning the instrument, use a soft cloth. Do not use paint thinners, solvents, alcohol, cleaning fluids, or chemical-impregnated wiping cloths.

■ Saving data

- The saved data may be lost due to some failure, an operation mistake, etc. Save your important data onto an external device such as a computer (page 38).

Information

■ About copyrights

- Copying of the commercially available musical data including but not limited to MIDI data and/or audio data is strictly prohibited except for your personal use.
- This product incorporates and bundles contents in which Yamaha owns copyrights or with respect to which Yamaha has license to use others' copyrights. Due to copyright laws and other relevant laws, you are NOT allowed to distribute media in which these contents are saved or recorded and remain virtually the same or very similar to those in the product.
 - * The contents described above include a computer program, Accompaniment Style data, MIDI data, WAVE data, voice recording data, a score, score data, etc.
 - * You are allowed to distribute medium in which your performance or music production using these contents is recorded, and the permission of Yamaha Corporation is not required in such cases.

■ About this manual

- The illustrations as shown in this manual are for instructional purposes only, and may appear somewhat different from those on your instrument.
- iPhone, iPad, iPod touch are trademarks of Apple Inc., registered in the U.S. and other countries.
- The company names and product names in this manual are the trademarks or registered trademarks of their respective companies.

Thank you for purchasing this Yamaha Digital Percussion!
We recommend that you read this manual carefully so that you can fully take advantage of the advanced and convenient functions of the instrument. We also recommend that you keep this manual in a safe and handy place for future reference.

About the Manuals

This instrument has the following documents and instructional materials.

■ Included Documents



Owner's Manual (this book)

This document explains how to use the instrument.

■ Online Materials (downloadable from the Internet)



iPhone/iPad Connection Manual

Explains how to connect the instrument to smart devices, such as iPhone, iPad, etc.



Computer-related Operations

Includes instructions on connecting this instrument to a computer, and operations related to transferring song data.



MIDI Reference

Contains MIDI-related information.

To obtain these manuals, access the Yamaha Downloads, and then the model name for searching the desired files.

Yamaha Downloads

<http://download.yamaha.com/>

Included Accessories

- Owner's Manual (this book)
- Drum stick (1 pair)
- Foot Pedal 1 & 2
- AC adaptor
- Warranty^{*1}
- Online Member Product Registration^{*2}

^{*1}: May not be included depending on your particular locale. Check with your Yamaha dealer.

^{*2}: The PRODUCT ID on the sheet will be needed when you fill out the User Registration form.

Main Features

■ Designed for comfortable playing

Each of the drum pads are angled and positioned on the panel for optimum playability and comfort. The pads and pedal 1 can be adjusted independently over four levels, allowing for expressive drumming—not only with the supplied sticks, but also for playing with your hands, by simply setting it to Hand Percussion mode (page 18).

■ Realistic drum sound – Stereo Sampling

You can choose and play with 570 Voices, which provide for a variety of percussion sounds, from realistic drum sounds (created with Stereo Sampling) to ethnic percussion sound of Japanese drum, Asia, Latin America and beyond.

■ 75 Drum kits

The instrument contains 75 drum kits of different genres for you to choose from. Moreover, the Voices can be assigned to each drum pads and pedals to create your own original drum kits.

■ 105 Songs

The instrument features 22 Songs including the Demos, and 83 Patterns that cover a wide variety of music genres. You can play along with the full playback, or mute tracks and play the missing parts.

■ AUX IN Jack

This jack is for connection to an external audio source, letting you play the instrument with music and accompaniment.

Compatible Formats and Functions



GM System Level 1

“GM System Level 1” is an addition to the MIDI standard which ensures that any GM-compatible music data can be accurately played by any GM-compatible tone generator, regardless of manufacturer. The GM mark is affixed to all software and hardware products that support GM System Level.



XGlite

As its name implies, “XGlite” is a simplified version of Yamaha’s high-quality XG tone generation format. Naturally, you can play back any XG song data using an XGlite tone generator. However, keep in mind that some songs may play back differently compared to the original data, due to the reduced set of control parameters and effects.

Contents

PRECAUTIONS	5
NOTICE	6
Information	6
About the Manuals	7
Included Accessories	7
Main Features	8
Panel Controls	10

Setting Up

Setting Up	12
Power Requirements	12
Connecting Pedals 1 and 2	13
Turning the Power On/Off	13
Setting the Battery Type	13
Adjusting the Master Volume	14
Setting the Auto Power Off function	14
Setting the Master EQ Type	14
Connecting Headphones or External Speaker	14
Using a Snare Drum Stand	15

Basic Operations

Playing the Demo Song	16
Play the Pads/Pedals	17
Pad Names	17
Setting the Hand Percussion ON/OFF	18
Hand Percussion Lock	18
Selecting and Playing a Drum Kit	19
Assigning Voices to Individual Pads and Pedals and Saving to a Custom Kit (“C0 1”-“C 10”) ...	20
Setting the Reverb type	21
Setting the Pad Sensitivity	22
Setting the Click ON/OFF	25
Click Settings	25
Playing a Song	28
Selecting and Playing a Song	28
Tap Start	29
Pad Start	30
Setting the Auto Kit Select ON/OFF	31
Adjusting the Tempo	32

Play along with a Song	33
Setting the Track ON/OFF	33
Break	33
Using A-B Repeat	34
Recording a Song	35
Recording	35
Playing the recorded song	36
Song Clear	37
Connecting to External Devices ...	38
Connecting to External MIDI Devices	38
Connecting to a Computer	38
Playing an External Audio Device with the Built-in Speakers	39

Appendix

The Functions	40
Backup and Initialization	41
Troubleshooting	42
Drum Voice List	43
Song List	47
Drum Kit List	48
Drum Score	52
Specifications	54
Index	55

Panel Controls

Front Panel

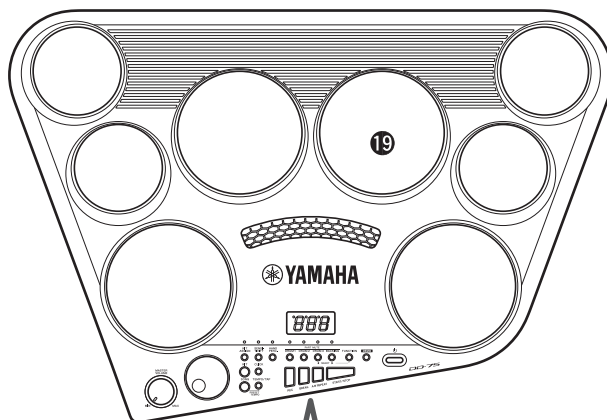

Indicates the song number when power is turned on.

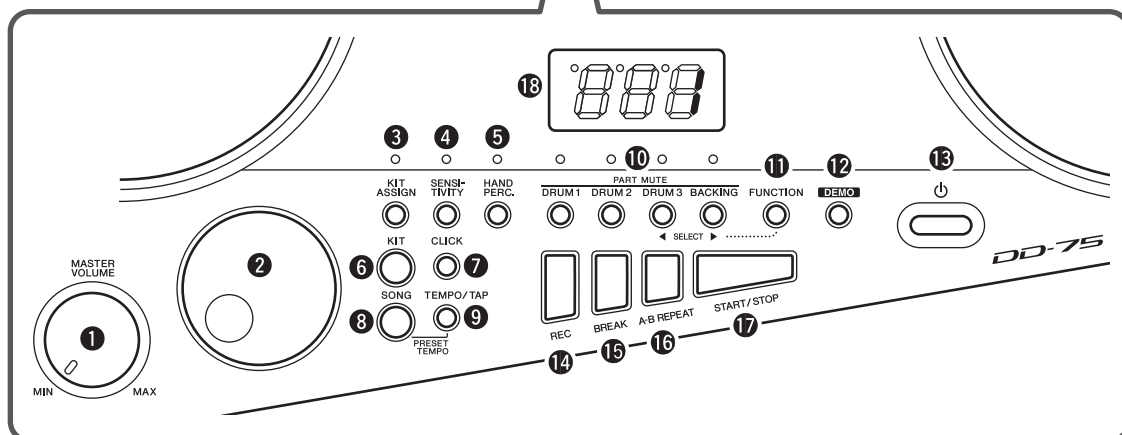

Front Panel

① MASTER VOLUME control.....	14	⑪ FUNCTION button	40
② Dial	13	⑫ DEMO button	16
③ KIT ASSIGN button.....	20	⑬ [] (Standby/On) switch	13
④ SENSITIVITY button	22	⑭ REC button	35
⑤ HAND PERC. button.....	18	⑮ BREAK button	33
⑥ KIT button	19	⑯ A-B REPEAT button	34
⑦ CLICK button	25	⑰ START/STOP button.....	28
⑧ SONG button	28	⑱ Display	13
⑨ TEMPO/TAP button	29	⑲ Drum pads (8).....	17
⑩ PART MUTE DRUM 1-3, BACKING	33		

Rear Panel

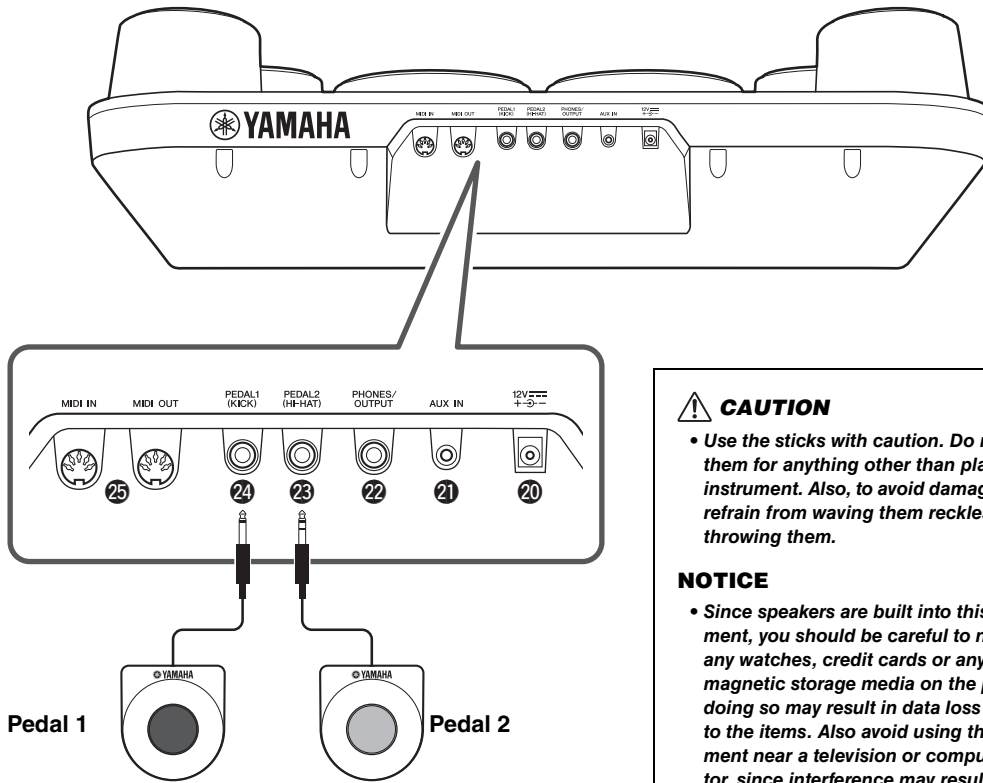

CAUTION

- Use the sticks with caution. Do not use them for anything other than playing the instrument. Also, to avoid damage or injury, refrain from waving them recklessly or throwing them.

NOTICE

- Since speakers are built into this instrument, you should be careful to never leave any watches, credit cards or any kind of magnetic storage media on the panel—doing so may result in data loss or damage to the items. Also avoid using this instrument near a television or computer monitor, since interference may result.

Drum Sticks

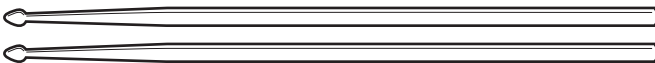

Rear Panel

②① DC IN 12V (AC Adaptor) jack..... 12	②③ PEDAL 2 • HI-HAT jack..... 13
②② AUX IN jack 39	②④ PEDAL 1 • KICK jack..... 13
②② PHONES/OUTPUT jack 14	②⑤ MIDI IN/OUT terminals 38

Setting Up

Be sure to do the following operations **BEFORE** turning on the power.

Power Requirements

Although the instrument will run either from an AC adaptor or batteries, Yamaha recommends use of an AC adaptor whenever possible. An AC adaptor is more environmentally friendly than batteries and does not deplete resources.

Using an AC Adaptor

Make sure that the [] (Standby/On) switch is off, then connect the AC adaptor in the order shown in the illustration.

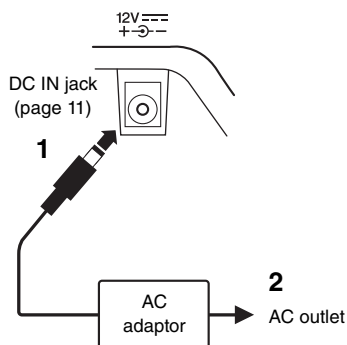

WARNING

- Use only the specified AC adaptor (page 54). Using the wrong AC adaptor can result in damage to the instrument or overheating.
- When using the AC adaptor with a removable plug, make sure to keep the plug attached to the AC adaptor. Using the plug alone can cause electric shock or fire.
- Never touch the metallic section when attaching the plug. To avoid electric shock, short circuit or damage, also be careful that there is no dust between the AC adaptor and plug.

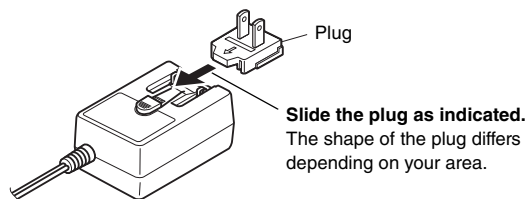

CAUTION

- When setting up the product, make sure that the AC outlet you are using is easily accessible. If some trouble or malfunction occurs, immediately turn the power off and disconnect the plug from the outlet.

NOTE

- Follow the order shown above in reverse when disconnecting the AC adaptor/power cord.

Using Batteries

This instrument requires C size, Alkaline (LR14)/Manganese (R14) batteries, or rechargeable nickel-metal hydride batteries (rechargeable Ni-MH batteries). The Alkaline batteries or rechargeable Ni-MH batteries are recommended for this instrument, since other types may result in poorer battery performance.

- 1 Make sure that the power of the instrument is off.
- 2 Open the battery compartment cover located on the instrument's bottom panel.

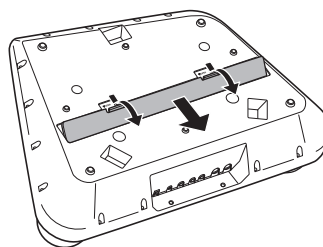

- 3 Insert the six new batteries, being careful to follow the polarity markings on the inside of the compartment.

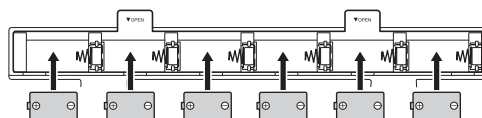

- 4 Replace the compartment cover, making sure that it locks firmly in place.

NOTICE

- Connecting or disconnecting the power adaptor with batteries installed may turn the power off, resulting in loss of data being recorded or transferred at the time.
- Make sure to set the battery type correctly (page 13).
- When battery power becomes too low for proper operation, the volume may be reduced, the sound may be distorted, and other problems may occur. When this happens, make sure to replace all batteries with new ones or already recharged ones.

NOTE

- This instrument cannot charge the batteries. Use only an appropriate charger device when charging.
- Power will be automatically drawn from the AC adaptor if an AC adaptor is connected while batteries are installed in the instrument.

Connecting Pedals 1 and 2

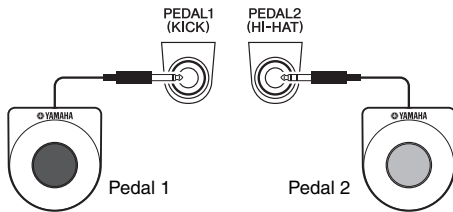

Connect the supplied Pedal 1 to the [PEDAL 1 (KICK)] jack and Pedal 2 to the [PEDAL 2 (HI-HAT)] jack.

CAUTION

- Avoid getting caught in or tripping over the pedal cords; this may cause the instrument to fall and result in damage or injury.

NOTICE

- Avoid using the pedals directly on a soft floor, since they may scratch the surface of the floor.

NOTE

- Make sure that the pedal plugs are properly connected to the PEDAL jacks before turning on the power.
- Do not press the pedals while turning the power on. Doing this changes the recognized polarity of the pedal, resulting in reversed pedal operation.
- You can use an Electronic drum pad KP65 (sold separately) or an Electronic kick unit KU100 (sold separately) and hi-hat controller HH65 or HH40 (sold separately) plugging into the [PEDAL 1 (KICK)] jack and [PEDAL 2(HI-HAT)].

Turning the Power On/Off

- 1 Turn down the [MASTER VOLUME] dial to “MIN.”



- 2 Press the [⏻] (Standby/On) switch to turn the power on.

The display lights up. Adjust the volume as desired while striking the pads.



When the power is turned on, Drum Kit number will appear after the “dd” item appears. Drum Kit number “1” is normally selected.

- 3 Press and hold the [⏻] (Standby/On) switch for about a second to turn the power off.

CAUTION

- Even when the power switch is turned off, electricity is still flowing to the product at the minimum level. When you are not using the product for a long time, make sure to unplug the power cord from the wall AC outlet.

NOTICE

- Do not attempt any other operations, such as pressing buttons or the pedal. Doing so may cause the instrument to malfunction.
- Do not turn off the power while saving data (a “-” mark appears and moves from left to right on the display). Doing so can result in loss of data.

Setting the Battery Type

Depending on the battery type to be used, you may need to change the battery type setting on this instrument. To change the setting, first turn on the power to the instrument, then choose the battery type you would like to use. Alkaline (and manganese) batteries are chosen by default.

- 1 Press the [FUNCTION] button.

Press the [DRUM 3] or [FUNCTION] button a number of times until the “btt” item appears. The currently selected battery type appears next to the “btt” indication.

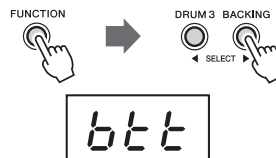

- 2 Change the battery type by turning the dial.

To select Ni-MH, turn the dial to the right (clockwise) until the “n-H” item appears, and to select Alkaline/Manganese, turn the dial to the left (counter-clockwise) until the “ALn” item appears.

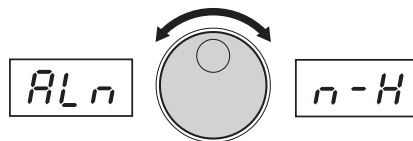

- 3 Press the [FUNCTION] button to exit.



NOTICE

- Failure to set the appropriate battery type may shorten the battery life. Make sure to set the battery type correctly.

Adjusting the Master Volume

To adjust the volume of the entire pad/pedal sound, use the [MASTER VOLUME] dial while striking the pads or pressing the pedals.

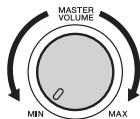

CAUTION

- Do not use the instrument for a long period of time at a high or uncomfortable volume level, since this can cause permanent hearing loss.

Setting the Auto Power Off function

To prevent unnecessary power consumption, this instrument features an Auto Power Off function that automatically turns the power off if the instrument is not operated for a specified period of time. The amount of time that elapses before the power is automatically turned off is 30 minutes by default; however, you can change the setting as desired (page 40).

Disabling Auto Power Off (simple method)

While holding down the [SONG] button, press the [⏻] (Standby/On) switch to turn the instrument on. The “P_oF” item appears after the “d” to indicate the Auto Power Off function has been disabled.



Setting the Master EQ Type

Master equalizer (EQ) settings give you the best possible sound when listening through different reproduction systems—the instrument’s internal speakers, headphones, or an external speaker system.

1 Enter the master EQ type setting function.

Press the [FUNCTION] button once, then press the [DRUM 3] or [BACKING] button a number of times until the “E 9L” item appears.

After a while, the current master EQ type appears next to the “E 9L” indication.

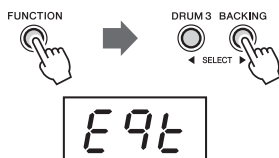

2 Select the desired master EQ type.

Turn the dial clockwise to set to “HP” (Headphone), and turn it counter-clockwise to set to “SP” (Speaker).

Display	Master EQ type
HP	for headphones or external speakers
SP (Default)	for internal speakers

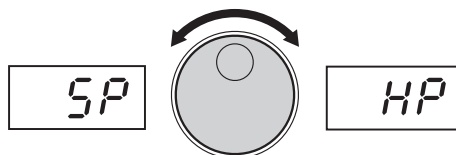

3 Press the [FUNCTION] button to exit from the Function mode.

FUNCTION



Connecting Headphones or External Speaker

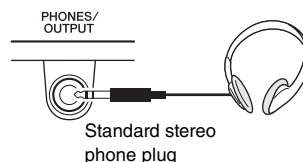

Connect a pair of headphones to the [PHONES/OUTPUT] jack. This jack also functions as an external output. By connecting to a computer, recorder, or other audio device, you can output the audio signal of this instrument to that external device. The speakers of this instrument are automatically shut off when a plug is inserted into this jack. You may also want to change the master EQ type setting to enjoy the optimum sound for either way of listening.

CAUTION

- Do not use the instrument/device or headphones for a long period of time at a high or uncomfortable volume level, since this can cause permanent hearing loss.
- Before connecting the instrument to other electronic components, turn off the power of all the components. Also, before turning any components on or off, make sure to set all volume levels to minimum. Otherwise, damage to the components or electrical shock may occur.

NOTICE

- To avoid possible damage to the external device, first turn on the power to the instrument, then to the external device. When turning off the power, do so in reverse order: first turn off the power to the external device, then to the instrument.

Using a Snare Drum Stand

This instrument can be installed on a snare drum stand (sold separately) for convenience and ease in playing.

Snare drum stand (sold separately): SS662, SS740A

■ Setting Up

- Open the legs wide enough so that the snare drum stand is stable, but not so much that the pipe touches the floor. Tighten the wing nut **E**.
- As shown in the illustration, make sure to always position the snare drum stand so that one of the legs extends toward the player.
- Use wing nut **D** to adjust the height, and turn **B** so that it faces the player.
- Use wing nut **C** to adjust the angle of **B** so that the instrument is installed horizontally.
- Use rotary nut **A** to loosen the three arm basket to fit the three indentations on the bottom of the instrument.
- Make sure all the nuts are securely tightened.

■ To install the snare drum stand

Put the arm covers into the indentations on the bottom of the instrument, and tighten rotary nut **A** until the arms are secured. Make sure all the nuts are securely tightened.

⚠ CAUTION

Be sure to handle the snare drum stand with care. Follow the important precautions below. If not, the snare drum stand may overturn, causing the instrument to drop and damage, possibly resulting in personal injury.

- Always place the snare drum stand on a flat, stable surface.
- Do not apply excessive force to the instrument.
- Do not adjust the height of snare drum stand with the instrument installed.
- Remove the snare drum stand from the instrument before moving the instrument.
- Do not use the snare drum stand other than designated ones (page 54).

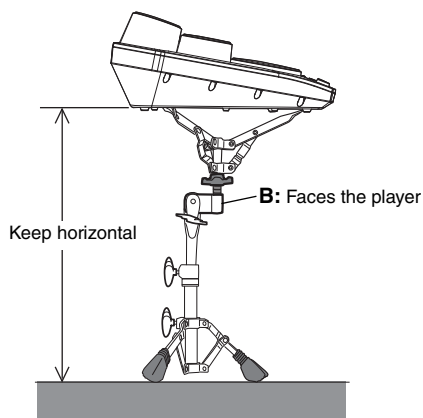
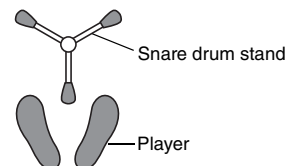
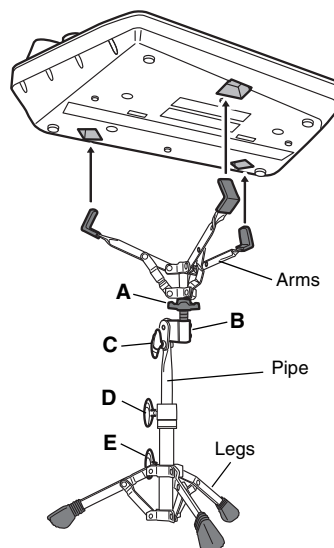

Playing the Demo Song

This instrument features several demonstration songs (“001”–“005”), specially created to show you the dynamic possibilities of the instrument.

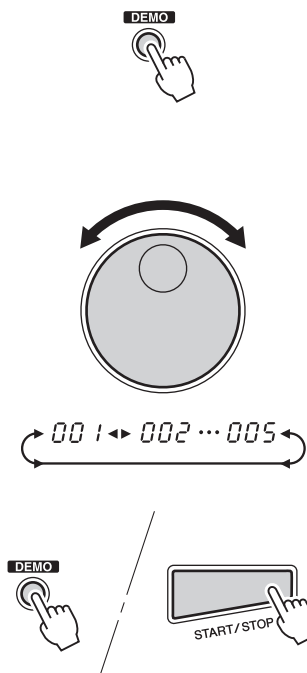

1 Start the Demo Song.

Press the [DEMO] button and the demo song starts playing.

NOTE

- With the Auto Kit Select feature turned on, the best suited Drum Kit for the song will automatically be selected. (See the “Setting the Auto Kit Select ON/OFF” on page 31.)

2 Select a Demo Song Number.

Use the dial to select a demo song number. Demo song numbers will increase as the dial is turned to the right (clockwise), and decrease as the dial is turned to the left (counter-clockwise).

3 Stop the Demo Song.

To stop playback, press the [DEMO] button again or press the [START/STOP] button.

NOTE

- Song volume cannot be adjusted during demo song playback.

Play the Pads/Pedals

Strike the pad with the supplied drum sticks or your hands to play the drum voices. When playing the pads with your hands, turn the Hand Percussion feature on by pressing the [HAND PERC.] button (the lamp lights).

The sound volume of the pads responds to your playing; when you play soft the volume is soft, and when you play strongly the volume is loud.

Pad Names

● Ex. shown, Drum Kit 1

A hi-hat sound is assigned to Pad 6 (Drum Kit 1). Striking Pad 6 while pressing Pedal 2 produces a closed hi-hat sound. Striking Pad 2 without pressing the pedal produces an open hi-hat sound. Pressing Pedal 2 produces a hi-hit pedal sound.

Pad 5
211: Crash
Cymbal Dark

Pad 6
179: Hi-Hat
Closed
Bright

Pad 2
102: Maple Tom 5

Pad 3
103: Maple Tom 4

Pad 7
210: Ride
Cymbal Cup
Warm

Pad 8
208: Ride
Cymbal
Warm 1

Pad 1
40: Maple Snare
Open Rim

Pad 4
105: Maple Tom 2



Pedal 2
180: Hi-Hat Pedal Bright

Press Pedal 2 to control the Hi-hat.
(This is in the case of Drum Kit 1; for other kits, this may control a different sound.)

NOTE

- When using Pedal 2, touch response does not function.



Pedal 1
3: Maple Bass Drum 3

Pedal 1 features touch response; the volume responds to how hard you press the pedal.

NOTE

- If your pressing of the pedal is too slow or soft, there may be no sound.



Setting the Hand Percussion ON/OFF

You can play the pads of the instrument either with the supplied sticks or with your hands. Press and set the following button when you play the instrument with your hands.



1 Press the [HAND PERC.] button.

When you press the [HAND PERC.] button, the button's lamp lights, and the pad sensitivity is automatically adjusted for optimum playing by hand. At the same time, an appropriate song (057) and drum kit (51) are automatically called up.

NOTE

- Be sure to strike the pads only with your hands when HAND PERCUSSION is on.

Hand Percussion Lock

If you perform on the instrument solely with your hands, we recommend that you use this operation to lock the Hand Percussion so that it is always on. This protects the instrument from being inadvertently changed during your performance.



Press and hold

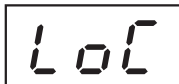

1 Make sure that Hand Percussion is set to on (the lamp is lit).

2 Set the Hand Percussion Lock to ON.

Press and hold the [HAND PERC.] button until "LoL" appears on the display.

3 To turn off Hand Percussion Lock, press and hold the [HAND PERC.] button until the "LoL" is no longer shown on the display.

Selecting and Playing a Drum Kit

The instrument allows you to choose from 75 different Drum Kits, which are preset voice combinations set to the the eight pads and two pedals. (See “Drum Kit List” on page 48.)

The instrument also has ten Custom Drum Kits allowing you to assign the desired voices to the pads or pedals. (See “Assigning Voices to Individual Pads and Pedals and Saving to a Custom Kit (“[KIT] 1”–“[KIT] 10”)” on page 20.)



1 Press the [KIT] button.

When you press the [KIT] button, the currently selected Drum Kit number appears on the display.

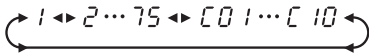
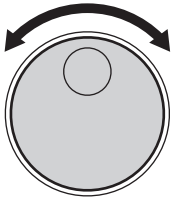

2 Select a Drum Kit Number.

Turn the dial to select a Drum Kit number. Drum Kit numbers will increase as the dial is turned to the right (clockwise), and decrease as the dial is turned to the left (counter-clockwise).

NOTE

- Drum Kit number “1” is normally selected when the power is turned on.
- Drum Kits “[KIT] 1”–“[KIT] 10” are Custom Kits.

* Custom Kits are those that you’ve assigned the desired voices to each pad and pedal, then saved the entire assignments as a Kit. The initial settings of “[KIT] 1”–“[KIT] 10” are Drum Kit number 1. (See “Assigning Voices to Individual Pads and Pedals and Saving to a Custom Kit (“[KIT] 1”–“[KIT] 10”)” on page 20.)

Assigning Voices to Individual Pads and Pedals and Saving to a Custom Kit ("C01"–"C10")

Drum Kit Voices can be changed and saved as a Custom Kit "C01"–"C10." The instrument contains a total of 570 high quality drum sounds plus 30 drum phrases (see the "Drum Voice List" on page 43)—and you can assign these freely to each of the 8 drum pads and 2 pedals. To call up the saved Custom Kit, press the [KIT] button and use the dial to select a Custom Kit number.

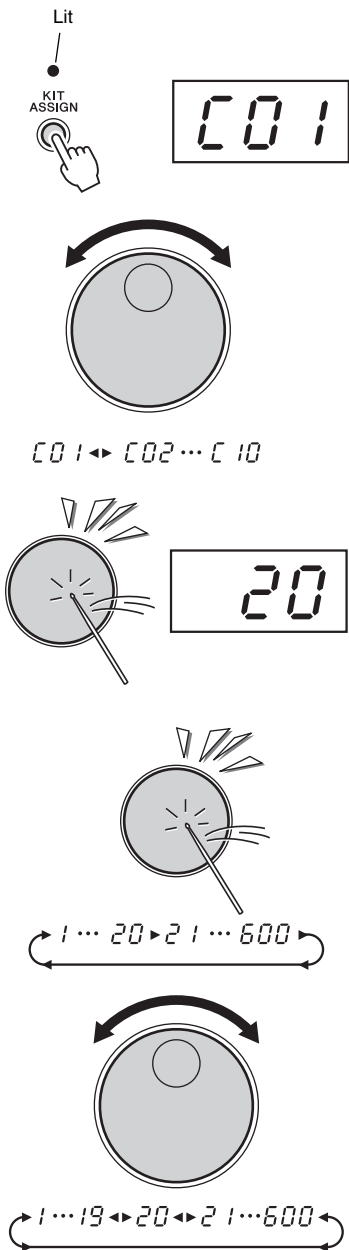

- 1 Select a Drum Kit ("1"–"75") you desired to change, then press the [KIT ASSIGN] button.**

When you press the [KIT ASSIGN] button, the button's lamp lights, and "C01" appears on the display.

- 2 Turn the dial and select a Custom Kit "C01"–"C10" for saving.**

- 3 Select a pad or pedal to be assigned.**

Strike any pad one time (or press a pedal), and the voice number of currently assigned Drum Kit is shown in the display.

- 4 Select a Voice Number.**

You can select the voice by repeatedly striking the pad or repeatedly pressing the pedal (while listening to the voice), or by turning the dial.

- **Striking the pad or pressing the pedal to select a voice.**

Every time the pad is struck or a pedal is pressed, voice numbers will increase by a value of one (1). In this method, you can hear and select an assigned voice.

- **Using the dial to select a voice.**

Turn the dial to the right (clockwise), and voice numbers will increase. Turn the dial to the left (counter-clockwise), and voice numbers will decrease.

To cancel, simply press the [KIT] button. See the "Drum Voice List" on page 43.

Repeat the previous steps **3** and **4** for any or all of the pads and pedals.

Unlit



5 Save to a Custom kit.

Press the [KIT ASSIGN] button to save to a Custom Kit (the lamp turns off).

You can now play the voice you have assigned to the pad/pedal. To call up the saved Custom Kit, press the [KIT] button and use the dial to select a Custom Kit number.

NOTE

- The Reverb Type of the currently assigned Drum Kit will be carried over. To change the Reverb type, please refer to “Setting the Reverb type.”

Setting the Reverb type

This control adds reverberation to the sound by simulating the natural reverberation of a concert hall. The ideal Reverb type is automatically selected whenever you select a Kit, but you can change to any of the available Reverb types, if desired.

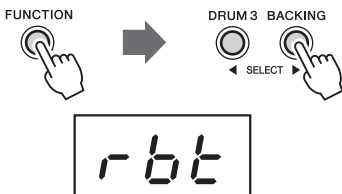

1 Enter the Reverb type setting function.

Press the [FUNCTION] button once, then press the [DRUM 3] or [BACKING] button a number of times until the “r b t” item appears. The currently selected Reverb type appears next to the “r b t” indication.

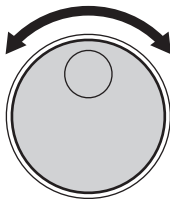

2 Change the reverb type by turning the dial.

Display	Reverb Type
o f f	Off
H R 1	Hall 1
H R 2	Hall 2
H R 3	Hall 3
r o 1	Room 1

Display	Reverb Type
r o 2	Room 2
S t 1	Stage 1
S t 2	Stage 2
P L 1	Plate 1
P L 2	Plate 2

3 Press the [FUNCTION] button to exit from the Function mode.



Setting the Pad Sensitivity

The instrument allows you to custom-set the sensitivity of the pads and pedal 1 (excluding pedal 2).

- **Setting all pads and pedal to the same value** page 22
- **Setting each pad and pedal to different values** page 23

■ **Setting All Pads and Pedal to the Same Value**.....

The sensitivity value of pads and pedal can be set from F (Fix) and 1 to 4. The sensitivity value of pad 2 cannot be adjusted. The sensitivity increase according as the number. When you set to F, the sensitivity is stable, and is not affected by strength of your drumming. The default setting is 2.

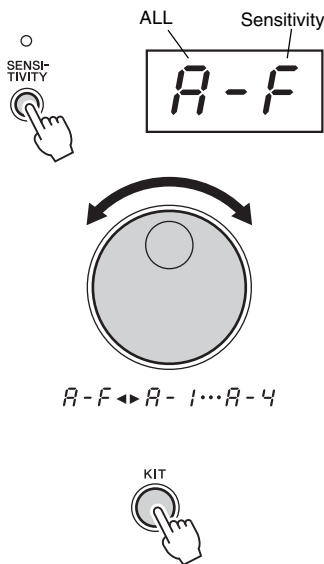

1 Press the [SENSITIVITY] button.

When you press the [SENSITIVITY] button, the current sensitivity value appears in the display.

2 Turn the dial and select a sensitivity value.

NOTE

- Default value is "R-2" (2).
- The settings "S0 1" to "S 10" let you set the sensitivity for each of the pads and pedal.

3 Press the [KIT] button to exit from the Sensitivity setting mode.

■ Setting each pad and pedal to different values.....

The instrument allows you to custom-set the sensitivity of the pads and pedal. The sensitivity value of pad 2 can not be adjusted.

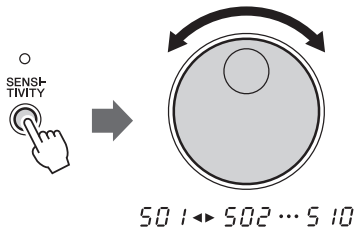

1 Press the [SENSITIVITY] button.

Turn the dial to select the destination to save from "50 1" to "5 10".

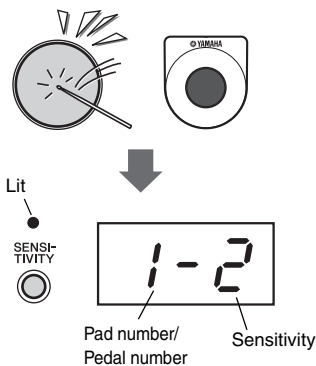

2 Strike a pad or press pedal 1.

To display the currently assigned sensitivity value for the pad or pedal 1. Make sure that the Pad number or Pedal number for which you wish to change the sensitivity value is shown on the display.

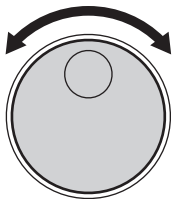
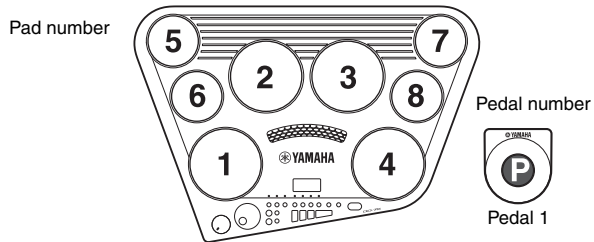

(Pad number/ Pedal number) - F ↔ (Pad number/ Pedal number) - 4

3 Turn the dial to change the value.

Value range is from F (Fix) and 1 to 4.
To cancel the setting, press the [KIT] button.



4 Press the [SENSITIVITY] button to save the setting.

5 Press the [KIT] button to exit from the Sensitivity setting mode.



About the Sensitivity Setting

For beginning percussionists, we recommend setting the sensitivity level higher, in order to give a more consistent sound volume, even if the pads are hit weakly. For experienced percussionists, we recommend setting it to lower levels. The strength at which pads are hit is reflected directly, and more intense power is required to make a larger sound.

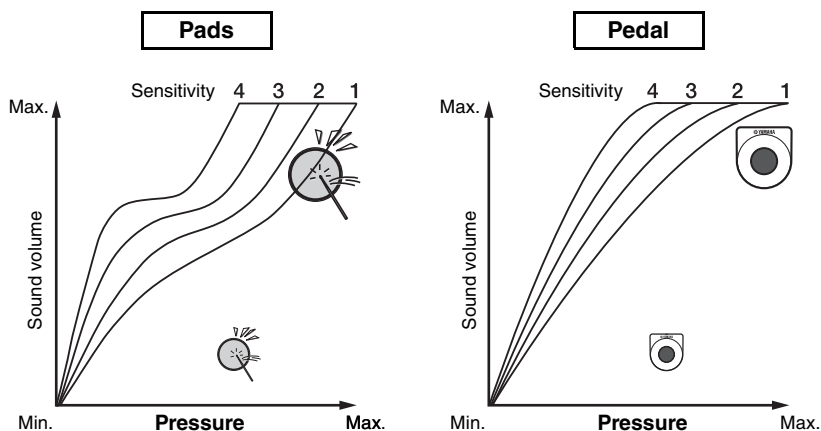

NOTE

- If the pedal sound volume is unstable, we recommend that you set the value to “P - F.”
- With an Electronic drum pad KP65 (sold separately) or Electronic kick unit KU100 (sold separately), the sound volume might seem low. Try increasing the volume setting sensitivity value.



About the Pad Sound Mechanism

Each time you strike a pad, the sensor which is located at the bottom of the pad triggers an electronic signal and makes a drum sound.

If you strike a pad too strongly, nearby sensors may also respond to the hit and trigger unwanted sounds. This instrument is set to ignore weak signals from the pads in order to prevent inadvertent, unwanted sounds. However, this may result in problems when intentionally striking two pads simultaneously. If one pad is struck strongly and the other weakly, the pad struck weakly may not sound (even though you want it to).

To solve this, you can change the settings or alter your playing technique (as described below).

- **Striking two pads simultaneously results in one of the pads not sounding.**
 - Increase the pad sensitivity level. This may solve the problem if you strike one of the pads weakly.
 - Better yet, take care to strike both pads with equal force.
- **Striking one pad results in other pads also sounding, even though they were not struck.**
 - Lower the pad sensitivity level. With this setting, pads that are not struck are effectively kept from responding to strong hits on nearby pads.

Setting the Click ON/OFF

The instrument includes a click sound with adjustable tempo and time signature.



Press the [CLICK] button.
The click sounds in rhythm at the current tempo.
To turn the click off, press the button once again.

Click Settings

■ Setting the numerator of the time signature

The range is 0 to 16. (The numerator is the top value; for example, in the time signature 6/8, "6" is the numerator.)

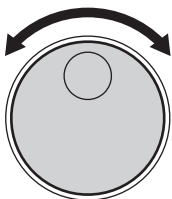
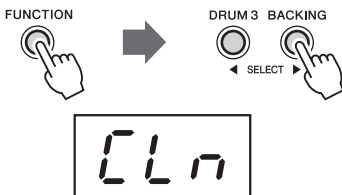

0 ◀▶ 1 ... 15 ▶◀ 16



1 Enter the numerator value setting function.

Press the [FUNCTION] button once, then press the [DRUM 3] or [BACKING] button a number of times until the "CLn" indication appears.

After a while, the current numerator value appears next to the "CLn" indication.

2 Set the numerator value of the time signature.

To raise the value, turn the dial to the right (clockwise), and to lower it, turn the dial to the left (counter-clockwise).

3 Press the [FUNCTION] button to exit from the Function mode.

■ Setting the denominator of the time signature

Determines the basic note value for each measure; for example, in the time signature 6/8, “8” is the denominator, or basic note value.

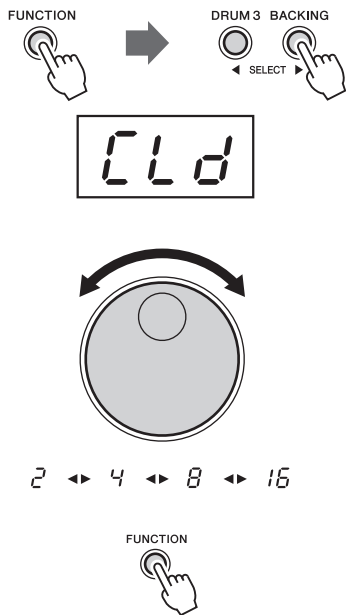

1 Enter the denominator value setting function.

Press the [FUNCTION] button once, then press the [DRUM 3] or [BACKING] button a number of times until the “CLd” indication appears.

After a while, the current denominator value appears next to the “CLd” indication.

2 Set the denominator value of the time signature.

Set the denominator value to one of the values 2 (♩), 4 (♩), 8 (♩), 16 (♩) by using the dial.

NOTE

- Default value is 4.

3 Press the [FUNCTION] button to exit from the Function mode.

■ Setting the click volume

Sets the click volume (range: 0–127).

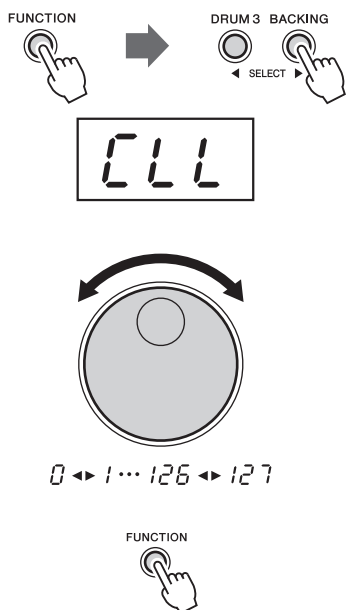

1 Enter the click volume setting function.

Press the [FUNCTION] button once, then press the [DRUM 3] or [BACKING] button a number of times until the “CLL” indication appears.

After a while, the current click volume will appear next to the “CLL” indication.

2 Set the click volume by using the dial.

3 Press the [FUNCTION] button to exit from the Function mode.

■ Setting the click voice

Set the click voice to Metronome, Cowbell, Stick or Human voice.

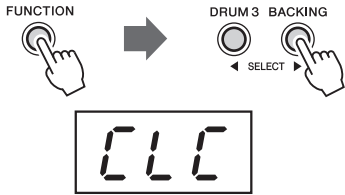

1 Enter the click voice setting function.

Press the [FUNCTION] button once, then press the [DRUM 3] or [BACKING] button a number of time until the “CLL” indication appears.

After a while, the current click voice appears next to the “CLL” indication.

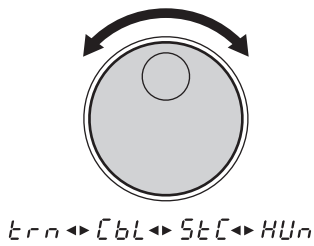

2 Turn the dial and select a click voice.

Item	Click Voice
<i>t r n</i>	Metronome
<i>C b L</i>	Cowbell
<i>S t C</i>	Stick (default)
<i>H U n</i>	Human voice (one, two, three, four...)

3 Press the [FUNCTION] button to exit from the function mode.



Press the [CLICK] button to listen to the click voice.



Playing a Song

This instrument features a wide variety of songs to choose and play: 105 songs, including 5 demos, 83 rhythm/fill-in patterns and 17 full songs. (See the “Song List” on page 47.)

Selections “UD 1”–“UD5” can also be used to playback songs you’ve recorded yourself and/or loaded from computer. Refer to the section “Transferring song files between the computer and instrument” on page 38 for details. Select one of the songs and listen to it.

Selecting and Playing a Song



1 Press the [SONG] button.

When you press the [SONG] button, the current song number appears in the display.

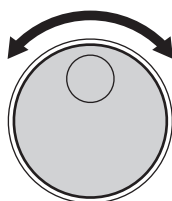

2 Select a Song Number.

Use the dial to select a song number. Song numbers will increase as the dial is turned to the right (clockwise), and decrease as the dial is turned to the left (counter-clockwise).

NOTE

- Song number “00 1” is automatically selected whenever the power is turned ON.
- With the Auto Kit Select feature turned on, selecting a song will also automatically select the best suited Drum Kit for that song. (See “Setting the Auto Kit Select ON/OFF” on page 31.)



“UD 1”–“UD5” are User Songs which you’ve recorded yourself and/or loaded from computer.

Note that when you press [START/STOP] button, no sounds are played or LED lamps beneath the display remain unlit, if there is no data.

3 Press the [START/STOP] button.

When you press the [START/STOP] button, a one- or two-measure lead-in plays, and the song starts playing.

As the song is playing, the Song’s current measure will be shown in the display. Try playing the pads and pedals along with the song.

To stop playback of the song, press the [START/STOP] button once again.

NOTE

- Songs “00 1”–“005” have no lead-ins.
- You can also use the Tap Start function to start songs (page 29).



● **Song Volume**

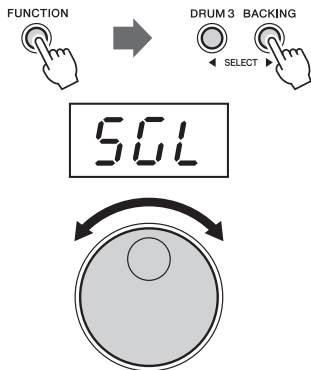

The Song Volume can be used to adjust the balance between the song accompaniment and your own performance.

Enter the Function mode by pressing the [FUNCTION] button, then press the [DRUM 3] or [BACKING] button a number of times until the “50L” item appears. The current Song volume value appears when it is released.

To raise the value, turn the dial to the right (clockwise), and to lower it, turn the dial to the left (counter-clockwise). Volume range is from 0 to 127.

Exit from the Function mode by pressing the [FUNCTION] button.

● **About the Beat Indicator**

During song playback, the three beat lamps in the display will flash in a specific pattern to help you in keeping the beat.

For a song in 4/4 time at a tempo of 120 bpm (page 32):

1st beat	2nd beat	3rd beat	4th beat

Tap Start

The Tap Start function allows you to set the song’s overall tempo as well as start the accompaniment—simply by tapping out the rhythm.

The accompaniment will playback at the tempo with which the pads are struck or the pedals are pressed. The song tempo can be set anywhere from 32 to 320 beats per minute.



Tempo: 125

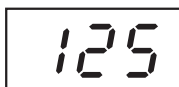

1 Press the [TEMPO/TAP] button.

While song playback is stopped, press the [TEMPO/TAP] button. All three of the beat lamps flash, indicating the instrument is set to Tap Start standby.

To cancel the Tap Start mode, simply press the [SONG] button once again.

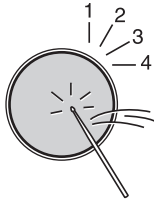

2 Play an appropriate Tap Start.

In the case of a song in 4/4, strike any pad or press any pedal (or the [TEMPO/TAP] button) four times, at a constant tempo, and the accompaniment will start at the desired tempo.

NOTE

- The number of times needed to strike the pad will change according to the following time signatures; 5/4, 5 times; 4/4, 4 times; 3/4, 3 times; 6/8, 2 times.

3 Stop the Song playback.

Press the [START/STOP] button and the song accompaniment will stop.

NOTE

- If External Clock is ON, Tap Start is not effective.
- External Clock On/Off can be set from the [FUNCTION] button (page 40).

Pad Start

The Pad Start function allows you to start the song simply by striking a pad or pressing a pedal.

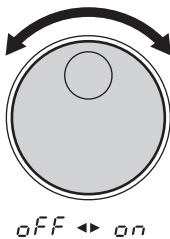

1 Enter the Pad Start setting function.

Press the [FUNCTION] button once, then press the [DRUM 3] or [BACKING] button a number of times until the “Pd5” item appears. After a while, the current On/Off status appears next to the “Pd5” indication.

2 Turn Pad Start On/Off.

Turn the dial clockwise to set to ON, and turn it counter-clockwise to set it to OFF.

NOTE

- Default setting is OFF.

3 Press the [FUNCTION] button to exit from the Function mode.

The dot flashes, indicating Pad Start is enabled.

NOTE

- To stop the song, press the [START/STOP] button.

Setting the Auto Kit Select ON/OFF

With the Auto Kit Select feature turned on, the best suited Drum Kit for the song will automatically be selected. If Auto Kit Select is OFF, the Drum Kit does not change even if the song number is changed.

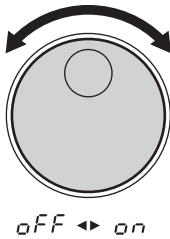
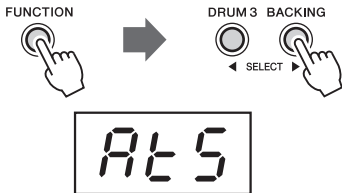

FUNCTION



1 Enter the Auto Kit Select function.

Press the [FUNCTION] button once, then press the [DRUM 3] or [BACKING] button a number of times until the "ALS" item appears. After a while, the current On/Off status will appear next to the "ALS" indication.

2 Turn Auto Kit Select On/Off.

Turn the dial clockwise to set to ON, and turn it counter-clockwise to set it to OFF.



NOTE

- Default setting is ON.

3 Press the [FUNCTION] button to exit from the Function mode.

Adjusting the Tempo

The song tempo and Click tempo can be set by using the dial or the [TEMPO/TAP] button. The higher the tempo value, the faster the tempo.

Tempo value range

- dial : 11–320 beats per minute
- [TEMPO/TAP] button : 32–320 beats per minute

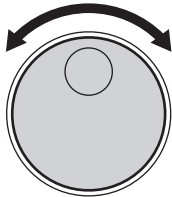
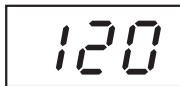

11 ◀ 12 ... 3 19 ▶ 320



1 Press the [TEMPO/TAP] button.

The current tempo value (11–320) appears in the display.

2 Set the Tempo.

When you use the dial to select the TEMPO, turn the dial to the right (clockwise) to increase the Tempo value, and turn it to the left (counter-clockwise) to decrease the value.

When you use the [TEMPO/TAP] button to change the TEMPO in the case of a song in 4/4, press the [TEMPO/TAP] button four times, and the accompaniment will start at the desired tempo.

NOTE

- To reset the tempo to the original preset setting, simultaneously press both the [SONG] and [TEMPO/TAP] buttons.

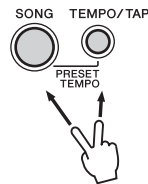

NOTE

- The tempo value cannot be changed during demo playback, recording, or when external clock is set to on.

Play along with a Song

Use the pads and pedals to play along with the song accompaniment.

NOTE

- The instrument can play a total of 32 notes simultaneously. That includes notes produced by song accompaniment, pads, foot pedals, and note data received through the [MIDI IN] jack.

Setting the Track ON/OFF

The instrument's song accompaniment consists of 4 tracks: Drum tracks 1, 2, and 3, and the Backing track.

DRUM 1	Bass Drum*
DRUM 2	Snare Drum*
DRUM 3	Cymbal*
BACKING	Backing

* Includes sounds other than bass drum, snare drum, or cymbal, depending on the selected song.

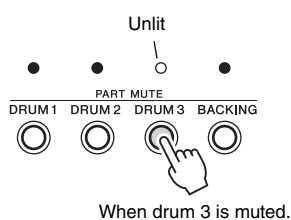

Pressing a Track button ([DRUM 1], [DRUM 2], [DRUM 3], [BACKING]) will mute (turn off the sound) the corresponding track and its indicator lamp will turn off.

Muting DRUM 1, DRUM 2 and DRUM 3 tracks allows you to play along with the song and practice the missing part.

Break

With the Break function, you can liven up songs by adding your own solos or fills, whenever you want. Striking a pad while in the Break mode, the song's accompaniment will be muted until the end of the measure you have finished your fill or solo.



1 During song playback or while song playback is stopped, press the [BREAK] button.

The three beat lamps in the display flash, indicating the instrument is in Break standby mode. To cancel the Break mode, simply press the [BREAK] button once again.

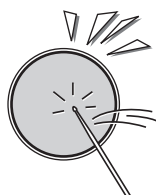

2 Play the Break.

Strike any pad or pedal during song playback, and the accompaniment will mute until the end of the measure you played in. You can play a drum fill or drum solo during this break. The instrument plays back the song from the next measure when the Break measure is completed.



3 Exit the Break mode.

To exit the Break mode, press the [BREAK] button.
The Break mode is also exited when the song is stopped.

NOTE

- The Break does not function if DEMO is started.

Using A-B Repeat

If you want to practice a particular section of a song, you can specify that section's "A" (start repeat) and "B" (end repeat) points. The accompaniment will continuously repeat between points "A" and "B" allowing you to practice between those points for as long as you like.



1 Set the "A" (start repeat) point.

When the song playback has reached the start of the section you want to practice, press the [A-B REPEAT] button and the "A" repeat point is set. An "A" will appear in the display.



2 Set the "B" (end repeat) point.

When the song playback has reached the end point of the section you want to practice, press the [A-B REPEAT] button once again to set the "B" point ("b" appears in the display). A one-measure count-in plays ("A - b" appears in the display), then the specified section plays back repeatedly. The current measure number will appear in the display during repeat playback.

NOTE

- The A-B Repeat start and end points can only be set in measure steps.

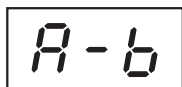

3 Stop the A-B REPEAT.

Press the [START/STOP] button and the song accompaniment will stop.
Press the [START/STOP] button once again and the accompaniment will again repeat between the set points.

NOTE

- Repeat is canceled when a different song is selected.

● Exit the Repeat

To exit the A-B Repeat function, press the [A-B REPEAT] button during playback, and the A-B Repeat mode will be canceled (the A-B Repeat points will also be canceled) and normal playback of the accompaniment will continue.

When the song is stopped, pressing the [A-B REPEAT] button cancels the A-B Repeat points.

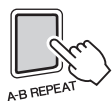

Recording a Song

The User Songs feature (song numbers “U0 1”–“U0 5”) allows you to record and play-back five original songs. The data capacity is approximately 7,000 notes per song. The recording will automatically stop when it reaches the capacity.

Data that can be recorded in the User Song Mode

- Drum pad and pedal played data
- Song data (the number cannot be changed while in the RECORD Mode)
- Track On/Off settings
- Tempo setting (the tempo cannot be changed while in the RECORD mode)
- Song Volume setting

Recording

1 Prepare to Record.



Select a desired song (“U0 1”–“U0 5”), drum kit and tempo setting. Select one of the User Songs (“U0 1”–“U0 5”) when you want to record your performance from scratch, without using a preset song. When you select a previously recorded User Song, all the track indicator lamps will light up. When you select an unrecorded User Song, all the track indicator lamps will light off.

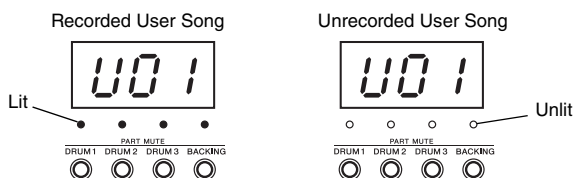

NOTICE

- Note that if you select a User Song which has been recorded or contains data, it will be overwritten with your newly recorded data.



2 Press the [RECORD] button to enter the recording mode.

The dots flash, indicating recording is set to standby. When you select a preset song or a recorded User Song, the track indicator lamps of DRUM 1/DRUM 2/DRUM 3 will light off.

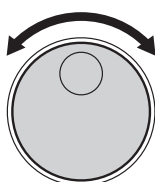

U0 1 → U0 2 ... U0 5

3 Turn the dial and select a User song “U0 1”–“U0 5” for saving.

Go to step 4 if you have selected a User Song at step 1. To cancel the recording, press the [REC] button.



4 Start recording.

Press the [START/STOP] button or simply play your performance to start recording.

5 Stop Recording.

To stop recording, press the [START/STOP] button.

NOTE

- If the memory becomes full while recording is in progress, a "FUL" indication appears in the display and recording will automatically stop.

NOTICE

- While the data is being recorded (a "-" mark appears and moves from left to right on the display), never interrupt the power supply (e.g., remove the batteries or unplug the AC adaptor). Doing so can result in a loss of data.

Playing the recorded song

The recorded User Songs ("U01"-"U05") can be played back in the same manner as any song (song numbers "001"-"100").



The user songs ("U01"-"U05") are located to next to the number "105" (before "001").

Song Clear

The Song clear operation completely erases all recorded data on all tracks of a selected user song.

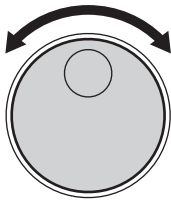

U01 ◀▶ U02 ... U05

Unlit



BACKING



Press twice

1 Press the [REC] button.

2 Turn the dial to select the desired song (“U01”–“U05”) to be cleared.

To cancel the Clear operation, press the [REC] button again.

3 Press the [BACKING] button to mute the track.

4 Press the [START/STOP] button two times in quick succession.

The Clear operation will be executed.

NOTICE

- While the data is being cleared (a “–” mark appears and moves from left to right on the display), never interrupt the power supply (e.g., by removing the batteries or unplugging the AC adaptor). Doing so can result in loss of data.

Connecting to External Devices

Connecting to External MIDI Devices

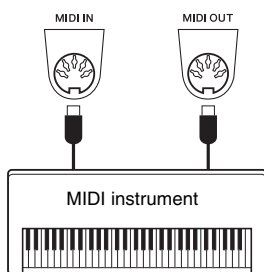

Use the [MIDI] terminals and standard MIDI cables to connect external MIDI devices (keyboard, sequencer, etc.). The MIDI related settings can be configured using the corresponding Function parameter. For details, refer to the “MIDI Reference.”

Connecting to a Computer

By connecting this instrument to other MIDI devices or a computer via commercially available USB-MIDI interface, the performance data of the instrument can be used on those other MIDI devices or computer, and also the performance data from other MIDI devices and computer can be received and sounded with this instrument.

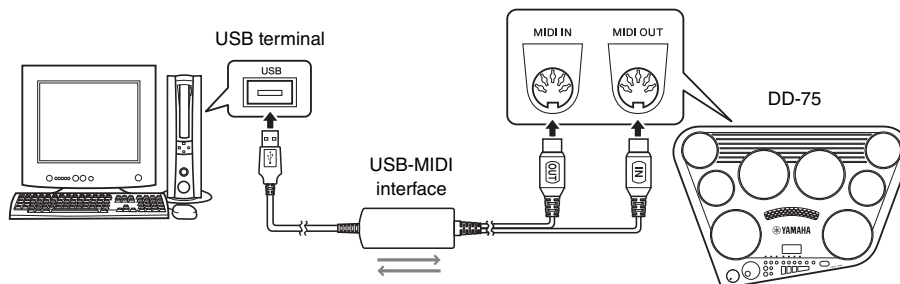

■ Transferring song files between the computer and instrument

You can transmit song files from your computer to this instrument's flash memory. Since the area in flash memory is shared between User songs (“U01”–“U05”) and loaded songs, you may need to erase some User songs to load the data. Files of SMF format 0 that you've loaded to the instrument can be played.

For details about how to transmit the data using the Musicsoft Downloader application, refer to the Online help topic “Transferring Data Between the Computer and Instrument (for unprotected data)” of the Musicsoft Downloader.

- **Data that can be loaded to the instrument from a computer**
 - Songs: 5 Songs max (“U01”–“U05”)
 - Data: 7,000 notes per song
 - Song data Format: SMF Format 0 (Extension: mid)
- **Data that can be transferred to a computer from the instrument**
 - User songs (“U01”(SONG001.mid)–“U05”(SONG005.mid))

Playing an External Audio Device with the Built-in Speakers

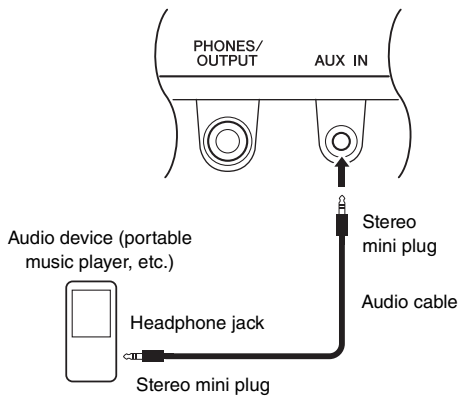

By connecting an audio device such as a portable music player to the instrument's [AUX IN] jack, you can output the sound of the audio device through the built-in speakers of this instrument. This lets you play the instrument along with the playback of your audio player.

NOTICE

- *To avoid damage to the devices, first turn on the power to the external device, and then to the instrument. When turning off the power, first turn off the power to the instrument, and then to the external device.*

The Functions

The “Functions” provide access to a range of detailed instrument parameters. Find the desired item in this Function List.

- 1 Press the [FUNCTION] button.
- 2 Press the [DRUM 3] or [BACKING] button a number of times until desired item appears.
- 3 Use the dial to set.
- 4 Press the [FUNCTION] button to exit from the mode.

Display	Function	Range/Settings	Default Value	Description	Page
Click					
<i>CLn</i>	Time Signature Numerator	0–16	*	Determines the numerator for the time signature of the Click.	25
<i>CLd</i>	Time Signature Denominator	2/4/8/16	*	Determines the basic note value for each measure.	26
<i>CLL</i>	Click Volume	0–127	100	Determines the volume of the Click.	26
<i>CLC</i>	Click Voice	Metronome (<i>CLn</i>)/ Cowbell (<i>CLd</i>)/ Stick (<i>CLL</i>)/ Human voice (<i>CLn</i>)	Stick (<i>CLL</i>)	Determines the Click sound.	27
Kit					
<i>rbt</i>	Reverb Type	Off (<i>OFF</i>)/ Hall 1 (<i>HR1</i>)/ Hall 2 (<i>HR2</i>)/ Hall 3 (<i>HR3</i>)/ Room 1 (<i>ro1</i>)/ Room 2 (<i>ro2</i>)/ Stage 1 (<i>St1</i>)/ Stage 2 (<i>St2</i>)/ Plate 1 (<i>PL1</i>)/ Plate 2 (<i>PL2</i>)	*	Selects a Reverb type.	21
<i>ATS</i>	Auto Kit Select	ON (<i>ON</i>) OFF (<i>OFF</i>)	ON (<i>ON</i>)	Determines whether the Auto Kit Select function is on or off.	31
Song					
<i>SVL</i>	Song Volume	0–127	100	Determines the volume of Songs.	29
<i>PS</i>	Pad Start	ON (<i>ON</i>) OFF (<i>OFF</i>)	OFF (<i>OFF</i>)	Determines whether the Pad Start function is on or off.	30
MIDI					
<i>LC</i>	Local Control	ON (<i>ON</i>) OFF (<i>OFF</i>)	ON (<i>ON</i>)	Determines whether the instrument's pads and pedals controls the internal tone generator (ON) or not (OFF).	Refer to “MIDI Reference Manual”
<i>EC</i>	External Clock	ON (<i>ON</i>) OFF (<i>OFF</i>)	OFF (<i>OFF</i>)	Determines whether the instrument synchronizes to the internal clock (OFF) or an external clock (ON).	
<i>ANS</i>	MIDI Note Number Auto Selection	ON (<i>ON</i>) OFF (<i>OFF</i>)	ON (<i>ON</i>)	Determines whether to assign MIDI note number automatically (ON) or manually (OFF).	
<i>not</i>	MIDI Note Number	-C2–G8 (0–127)	-	Assigns MIDI note numbers for each pads and pedals.	
Others					
<i>EQ</i>	Master EQ Type	Speaker (<i>SP</i>)/ Headphone (<i>HP</i>)	Speaker (<i>SP</i>)	Determines whether the sound is heard through internal speakers (<i>SP</i>), or headphones or an external speaker system (<i>HP</i>).	14
<i>APT</i>	Auto Power Off Time	OFF/5/10/15/30/60/120 (min.)	30 (min.)	Specifies the time that will elapse before the instrument's power is automatically turned off.	14
<i>bt</i>	Battery Type	Alkaline-manganese (<i>RLn</i>)/Nickel hydride (<i>n-H</i>)	Alkaline-manganese (<i>RLn</i>)	Selects the type of batteries you have installed to this instrument.	13

* The appropriate value is automatically set for each song or kit.

Backup and Initialization

Backup

Some internal parameters will be backed up to internal memory even if the power is turned off. You can initialize all internal memory to the default settings or initialize the memory with the exception of the Songs.

Following parameters remain in memory

- User Songs (including songs loaded from computer)
- Custom Kit “ $\text{C } 0 \text{ 1}$ ”–“ $\text{C } 10$ ”
- Pad/Pedal Sensitivity*
- Click Volume
- Click Voice
- Auto Kit Select ON/OFF
- Song Volume
- Pad Start ON/OFF
- MIDI Note Number Auto Selection ON/OFF
- MIDI Note Number
- Master EQ Type
- Auto Power Off Time
- Battery Type

* Value selected when the power is turned off and values assigned to Custom Kit “ $\text{S } 0 \text{ 1}$ ”–“ $\text{S } 10$ ”

Initialization

This function erases all backup data in the instrument's flash memory and restores the initial default settings. The following initialization procedures are provided.

■ Initial Clear

To clear all data backed up to the internal flash memory (described above), turn the power on by pressing the [⏻] (Standby/On) switch while holding the [DEMO] button. The backed up data will be erased and the default values restored.

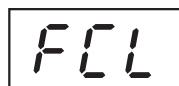

"FCL" appears, followed by song number "00 1"

NOTICE

- When you execute the Initial Clear operation, all backup data will be cleared. You can save the data of the five built-in User Songs to a computer by using Musicsoft Downloader.

■ Back Up Clear

To clear all backed up data that has been memorized to the internal flash memory (with the exception of song data), turn the power on by pressing the [⏻] (Standby/On) switch while holding the [FUNCTION] button.

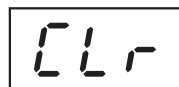

" $\text{C } 1 \text{ r}$ " appears, followed by song number "00 1"

Troubleshooting

Problem	Cause/Solution
Power suddenly and unexpectedly turns off.	This is normal and the Auto Power Off function may have been activated (page 14). If desired, disable the Auto Power Off function.
When the instrument is turned on, power is turned off suddenly and unexpectedly.	The protection circuit has been activated due to over current. This may occur when an AC adaptor other than the one specified is used, or an AC adaptor is damaged. Use the specified adaptor (page 54) only. If it should appear to be malfunctioning, discontinue use immediately and have it inspected by qualified Yamaha service personnel.
A buzz or click occurs momentarily when the instrument is turned ON or OFF	This is a normal power surge noise that occurs when the POWER switch is operated.
The LED display is completely dark. When the pads are struck (or pedals are pressed), the display is dark and returns to “!” The Custom Kit voice assignments or sensitivity settings of each pads and pedals have disappeared or defaulted.	The batteries are low and should be replaced with a complete set of six new batteries immediately. Ideally, an optional AC adaptor should be used to power the instrument.
When using a mobile phone, noise is produced.	Using a mobile phone in close proximity to the instrument may produce interference. To prevent this, turn off the mobile phone or use it further away from the instrument.
Noise is heard from the instrument’s speakers or headphones when using the instrument with the application on iPhone/iPad.	When you use the instrument along with the application on your iPhone/iPad, we recommend that you set “Airplane Mode” to “ON” on your iPhone/iPad in order to avoid noise caused by communication.
No sound comes from the instrument.	<ul style="list-style-type: none"> • The volume is set too low. Adjust the volume (page 29). • A plug is inserted into the [PHONES/OUTPUT] jack and should be taken out (page 14). • The LOCAL ON/OFF is set to OFF. Set the LOCAL ON/OFF to ON (page 40).
Suddenly “FULL” appears and recording is stopped.	The amount of recorded data has exceeded the limit of 7,000 notes per song.
Song is automatically started when pad is struck (or pedal is pressed).	Pad Start is set to ON. Set Pad Start to OFF (page 30).

Drum Voice List

● Panel Voice List

Vocie No.	Voice name	Vocie No.	Voice name	Vocie No.	Voice name
1	Maple Bass Drum 1	56	Snare Tight	111	Oak Tom 2
2	Maple Bass Drum 2	57	Open Rim Shot	112	Oak Tom 1
3	Maple Bass Drum 3	58	Snare Soft 2	113	Tom Hard Rock 6
4	Oak Bass Drum	59	Snare 2	114	Tom Hard Rock 5
5	Bass Drum Hard Rock 1	60	Snare Tight 2	115	Tom Hard Rock 4
6	Bass Drum Hard Rock 2	61	Open Rim Shot 2	116	Tom Hard Rock 3
7	Bass Drum Hard Rock 3	62	Snare Room L	117	Tom Hard Rock 2
♦ 8	Bass Drum Ambient+	63	Snare Room H	118	Tom Hard Rock 1
♦ 9	Bass Drum Open Power	64	Snare Noisy	♦119	Tom Power 6
♦10	Bass Drum Close Power	65	Snare Rock	♦120	Tom Power 5
11	Bass Drum Soft	66	Snare Rock Rim	♦121	Tom Power 4
12	Bass Drum Hard	67	Snare Snappy Electronic	♦122	Tom Power 3
13	Bass Drum	68	Snare Noisy 2	♦123	Tom Power 2
14	Bass Drum 2	69	Snare Analog 1	♦124	Tom Power 1
15	Bass Drum H	70	Snare Techno	125	High Tom
16	Bass Drum Rock	71	Snare Clap	126	Mid Tom H
17	Bass Drum Gate	72	Snare Dry	127	Mid Tom L
18	Bass Drum Analog L	73	Rim Gate	128	Low Tom
19	Bass Drum Analog H	74	Snare Jazz L	129	Floor Tom H
20	Kick Techno Q	75	Snare Jazz M	130	Floor Tom L
21	Kick Techno L	76	Band Snare 1	131	Tom Room 6
22	Kick Techno	77	Band Snare 2	132	Tom Room 5
23	Bass Drum Jazz	78	Orchestra Snare Left Hand	133	Tom Room 4
24	Bass Drum Soft L	79	Orchestra Snare Right Hand	134	Tom Room 3
25	Kick T8 1	80	Brush Tap	135	Tom Room 2
26	Kick T8 2	81	Brush Slap	136	Tom Room 1
27	Kick T8 3	82	Snare T8 1	137	Tom Rock 6
28	Kick T8 4	83	Snare T8 2	138	Tom Rock 5
29	Kick Tek Power	84	Snare T8 3	139	Tom Rock 4
30	Kick Zap Hard	85	Snare T8 4	140	Tom Rock 3
31	T8 Kick Bass	86	Snare T8 5	141	Tom Rock 2
32	Kick Blip	87	Snare T8 6	142	Tom Rock 1
33	Kick Fx Hammer	88	Snare T8 7	143	Tom Electronic 6
34	Bass Drum Vox 1	89	Snare Garage L	144	Tom Electronic 5
35	Bass Drum Vox 2	90	Snare Hammer	145	Tom Electronic 4
36	Kick Slimy	91	Snare Clap Analog	146	Tom Electronic 3
37	Gran Cassa	92	Snare T8 Rim	147	Tom Electronic 2
38	Gran Cassa Mute	93	Snare Analog CR	148	Tom Electronic 1
39	Maple Snare Head	94	Snare Hip 1	149	Tom Analog 6
40	Maple Snare Open Rim	95	Snare Hip 2	150	Tom Analog 5
41	Maple Side Stick	96	Snare Hip Gate	151	Tom Analog 4
42	Oak Snare Head	97	Snare Break 1	152	Tom Analog 3
43	Oak Snare Open Rim	98	Snare Fx 1	153	Tom Analog 2
44	Oak Side Stick	99	Snare Vox	154	Tom Analog 1
45	Snare Head Hard Rock	100	Snare Open Rim Vox	155	Tom Jazz 6
46	Snare Open Rim Hard Rock	101	Maple Tom 6	156	Tom Jazz 5
47	Side Stick Hard Rock	102	Maple Tom 5	157	Tom Jazz 4
♦48	Snare Soft Power	103	Maple Tom 4	158	Tom Jazz 3
♦49	Snare Power	104	Maple Tom 3	159	Tom Jazz 2
♦50	Snare Rough	105	Maple Tom 2	160	Tom Jazz 1
♦51	Open Rim Shot Power	106	Maple Tom 1	161	Tom Brush 6
♦52	Snare Power 2	107	Oak Tom 6	162	Tom Brush 5
♦53	Snare Rough 2	108	Oak Tom 5	163	Tom Brush 4
54	Snare Soft	109	Oak Tom 4	164	Tom Brush 3
55	Snare	110	Oak Tom 3	165	Tom Brush 2

Vocie No.	Voice name	Vocie No.	Voice name	Vocie No.	Voice name
166	Tom Brush 1	♦222	Crash Cymbal Power 1	278	Timpani F#2
167	Tom T8 7	♦223	Crash Cymbal Power 2	279	Timpani G2
168	Tom T8 6	♦224	Ride Cymbal Power 1	280	Timpani G#2
169	Tom T8 4	♦225	Ride Cymbal Power 2	281	Conga H Open
170	Tom T8 3	♦226	Ride Cymbal Cup Power	282	Conga H Mute
171	Tom T8 2	♦227	Chinese Cymbal Power	283	Conga H Slap Open
172	Tom T8 1	♦228	Splash Cymbal Power	284	Conga H Slap
173	Tom Vox 6	229	Crash Cymbal 1	285	Conga H Slap Mute
174	Tom Vox 5	230	Crash Cymbal 2	286	Conga H Tip
175	Tom Vox 4	231	Ride Cymbal 1	287	Conga H Heel
176	Tom Vox 3	232	Ride Cymbal 2	288	Conga L Open
177	Tom Vox 2	233	Ride Cymbal Cup	289	Conga L Mute
178	Tom Vox 1	234	Chinese Cymbal	290	Conga L Slap Open
*179	Hi-Hat Closed Bright	235	Splash Cymbal	291	Conga L Slap
*180	Hi-Hat Pedal Bright	236	Cymbal Analog	292	Conga L Tip
*181	Hi-Hat Open Bright	237	Hand Cymbal 1	293	Conga L Heel
*182	Hi-Hat Closed Dark	238	Hand Cymbal 1 Short	294	Conga L Slide
*183	Hi-Hat Pedal Dark	239	Hand Cymbal 2	295	Conga Open
*184	Hi-Hat Open Dark	240	Hand Cymbal 2 Short	296	Conga Mute
*185	Hi-Hat Closed Dark 2	241	Crash Cymbal T8	297	Conga Slap
*186	Hi-Hat Pedal Dark 2	242	Crash Cymbal Vox 1	298	Conga Tip
*187	Hi-Hat Open Dark 2	243	Ride Cymbal Vox	299	Conga Heel
**188	Hi-Hat Closed Power	244	Ride Cymbal Cup Vox	300	Conga Open-Slap
**189	Hi-Hat Pedal Power	245	Crash Cymbal Vox 2	301	Conga 2 H Open
**190	Hi-Hat Open Power	♦246	Side Stick Power	302	Conga 2 H Mute
**191	Hi-Hat Closed Power 2	247	Side Stick	303	Conga 2 H Slap
*192	Hi-Hat Closed	248	Side Stick Analog	304	Conga 2 H Tip
*193	Hi-Hat Pedal	249	Hand Clap	305	Conga 2 H Heel
*194	Hi-Hat Open	250	Hand Clap 2	306	Conga 2 H Open-Slap
*195	Hi-Hat Closed Analog 1	251	Clap T9	307	Conga 2 L Slap
*196	Hi-Hat Closed Analog 2	252	Khaligi Clap 1	308	Conga 2 L Open
*197	Hi-Hat Open Analog	253	Hand Clap Vox	309	Conga 2 L Mute
*198	Hi-Hat Closed Analog 3	254	Sticks	310	Conga 2 L Tip
*199	Hi-Hat Closed Analog 4	255	Castanet	311	Conga 2 L Heel
*200	Hi-Hat Open Analog 2	256	Tambourine 2	312	Conga T8 1
*201	Hi-Hat Closed T8	257	Tambourine	313	Conga T8 2
*202	Hi-Hat Pedal T8	258	Finger Snap	314	Conga T8 3
*203	Hi-Hat Open T8	259	Vibraslap	315	Bongo H Open 1 Finger
*204	Hi-Hat Closed Vox	260	Metronome Click	316	Bongo H Open 3 Fingers
*205	Hi-Hat Pedal Vox	261	Metronome Bell	317	Bongo H Rim
*206	Hi-Hat Open Vox	262	Timpani D1	318	Bongo H Slap
207	Crash Cymbal Warm	263	Timpani D#1	319	Bongo H Tip
208	Ride Cymbal Warm 1	264	Timpani E1	320	Bongo H Heel
209	Ride Cymbal Warm 2	265	Timpani F1	321	Bongo L Open 1 Finger
210	Ride Cymbal Cup Warm	266	Timpani F#1	322	Bongo L Open 3 Fingers
211	Crash Cymbal Dark	267	Timpani G1	323	Bongo L Rim
212	Chinese Cymbal 2	268	Timpani G#1	324	Bongo L Slap
213	Splash Cymbal 2	269	Timpani A1	325	Bongo L Tip
214	Crash Cymbal Bright	270	Timpani A#1	326	Bongo L Heel
215	Ride Cymbal Bright	271	Timpani B1	327	Bongo 2 H Mute
216	Ride Cymbal Cup Bright	272	Timpani C2	328	Bongo 2 L Open 1 Finger
217	Crash Cymbal Dark 2	273	Timpani C#2	329	Quinto Slap
218	Crash Cymbal Warm 2	274	Timpani D2	330	Quinto Open
219	Ride Cymbal Warm 3	275	Timpani D#2	331	Quinto Mute
220	Ride Cymbal Cup Warm 2	276	Timpani E2	332	Quinto Heel
221	Crash Cymbal Dark 3	277	Timpani F2	333	Quinto Tip

Vocie No.	Voice name	Vocie No.	Voice name	Vocie No.	Voice name
334	Quinto Open-Slap	390	Tamborim 1 Mute	445	Daholla Tak 1
335	Tumba Open	391	Zabumba Open Right Hand	446	Daholla Dom
336	Tumba Mute	392	Zabumba Mute Right Hand	447	Daholla Tak 2
337	Tumba Slap	393	Zabumba Stick Left Hand	448	Katem Tak Doff
338	Timbale H Open	394	Timbau Open	449	Katem Dom
339	Timbale L Open	395	Timbau Mute	450	Katem Sak 1
340	Paila H	396	Whistle Short	451	Katem Tak 1
341	Paila L	397	Whistle Long	452	Katem Sak 2
342	Timbale 2 H Rim	398	Tan Tan 1 Closed Right Hand	453	Katem Tak 2
343	Timbale 2 L Rim	399	Tan Tan 1 Open Right Hand	454	Zarb Back mf
344	Timbale H Rim	400	Tan Tan 1 Slap Right Hand	455	Zarb Tom f
345	Timbale L Rim	401	Tan Tan 1 Body Left Hand	456	Zarb Eshareh
346	Timbale 2 H	402	Pandeiro L Thumb Closed	457	Zarb Whipping
347	Timbale 2 L	403	Pandeiro L Thumb Open	458	Tombak Tom f
348	Cowbell Top	404	Pandeiro L Toe Rim	459	Tombak Back f
349	Cowbell 2	405	Pandeiro L Heel	460	Tombak Snap f
350	Cowbell T8	406	Pandeiro L Slap	461	Neghareh Tom f
351	Mambo Cowbell	407	Pandeiro Open	462	Neghareh Back f
352	Agogo H	408	Pandeiro Tip	463	Neghareh Pelang f
353	Agogo L	409	Pandeiro Slap	464	Riq Snouj 2
354	Cabasa	410	Repique Anel Thumb Rim Left Hand	465	Riq Snouj 1
355	Maracas	411	Repique Anel Thumb Rim Right Hand	466	Riq Sak
356	Guiro Short	412	Repique Anel Mute	467	Riq Snouj 3
357	Guiro Long	413	Repique Anel Open	468	Riq Snouj 4
358	Metal Guiro Short	414	Repique de Mao Slap	469	Riq Tak 1
359	Metal Guiro Long	415	Repique de Mao Thmb Rim	470	Riq Brass 1
360	Claves	416	Repique de Mao Open	471	Riq Tak 2
361	African Claves	417	Caixa Open Rim	472	Riq Brass 2
362	Wood Block H	418	Caxixi Shake	473	Riq Dom
363	Wood Block L	419	Cabasa Roll	474	Sagat 1
364	Cuica Mute	420	Caixa	475	Sagat 2
365	Cuica Open	421	Chajchas	476	Sagat 3
366	Cuica H Short	422	Agogo Bell 1	477	Baya ge
367	Cuica M Short	423	Agogo Bell 2	478	Baya ke
368	Cuica L Short	424	Agogo Click 1	479	Baya ghe
369	Triangle Mute	425	Agogo Click 2	480	Baya ka
370	Triangle Open	426	Ganza	481	Tabla na
371	Shaker	427	Reco-Reco	482	Tabla tin
372	Jingle Bells	428	Darbuka Open	483	Tablabaya dha
373	Wind Chime	429	Darbuka Mute	484	Chipri
374	Cajon 2 L	430	Darbuka Slap	485	Khanjira Open
375	Cajon 2 Mute	431	Tablah Tak 3	486	Khanjira Slap
376	Cajon 2 Slap	432	Tablah Tak 1	487	Khanjira Mute
377	Surdo 2 Mute	433	Tablah Tak 4	488	Khanjira Bend Up
378	Surdo 2 Open	434	Tablah Tak 2	489	Khanjira Bend Down
379	Surdo 2 Stop	435	Tablah Sak 2	490	Hatheli Long
380	Surdo 2 Side Stick	436	Tablah Sak 1	491	Hatheli Short
381	Surdo 1 Mute	437	Tablah Dom 1	492	Manjira Open
382	Surdo 1 Open	438	Tablah Tak Finger 4	493	Manjira Closed
383	Surdo 1 Stop	439	Tablah Tak Trill 1	494	Jhanji Open
384	Tamborim 2 Rim	440	Tablah Tak Finger 3	495	Jhanji Closed
385	Tamborim 2 Open	441	Tablah Tak Trill 2	496	Mondira Open
386	Tamborim 2 Finger Back	442	Tablah Prok	497	Mondira Closed
387	Tamborim 3 Down	443	Daholla Sak 2	498	Dafli Open
388	Tamborim 3 Up	444	Daholla Sak 1	499	Dafli Rim
389	Tamborim 1 Open			500	Dhol 1 Open

Vocie No.	Voice name	Vocie No.	Voice name
501	Dhol 1 Slap	536	Muyu M
502	Dhol 2 Open	537	Djembe L
503	Dhol 2 Slap	538	Djembe Mute
504	Dhol 2 Rim	539	Djembe Slap
505	Dholak 1 Open	540	Pot Drum Open
506	Dholak 1 Mute	541	Pot Drum Closed
507	Dholak 1 Slap	542	Talking Drum Open
508	Dholak 2 Open	543	Talking Drum Bend Up
509	Dholak 2 Slide	544	Talking Drum Slap
510	Dholak 2 Rim 1	545	Talking Drum Left Hand Open
511	Dholak 2 Rim 2	546	Oodaiko
512	Dholki H Open	547	Oodaiko Rim
513	Dholki H Mute	548	Yaguradaiko
514	Dholki L Open	549	Yaguradaiko Rim
515	Dholki H Slap	550	Atarigane
516	Dholki L Slide	551	Shimedaiko
517	Mridangam na	552	Tsudumi
518	Mridangam din	553	Ainote
519	Mridangam ki	554	Scratch H
520	Mridangam ta	555	Scratch L
521	Mridangam Chapu	556	Yo!
522	Mridangam L Closed	557	Go!
523	Mridangam L Open	558	Get up!
524	Dandia Short	559	Whoow!
525	Dandia Long	560	Huaaah!
526	Bangu	561	Uh!+Hit
527	Paigu M	562	Footsteps
528	Dagu Heavy	563	Frog
529	Zhongcha Open	564	Rooster
530	Zhongcha Mute	565	Dog
531	Luo Big	566	Cat
532	Luo H	567	Owl
533	Zhongluo Open	568	Horse Neigh
534	Xiaoluo Open	569	Cow
535	Xiaocha Mute	570	Lion

● **Phrase List/**

Voice No.	Voice Name
571	Rock 1
572	Rock 2
573	Rock 3
574	Rock 4
575	Rock'n Roll
576	16 beat
577	Hard Shuffles
578	Blues Shuffle
579	Contemporary 1
580	Contemporary 2
581	Soul
582	ClubMix
583	House
584	Jazz Funk
585	Ballad
586	R & B
587	Motown
588	Urban Funk
589	Jazz
590	Samba 1
591	Samba 2
592	Samba 3
593	Arabic 1
594	Arabic 2
595	Indian 1
596	Indian 2
597	African
598	Conga
599	Bongo
600	Timbal

◆ *The voice is recorded in stereo.*

* *By assigning Closed and Open Hi-Hat voices to both the Pad and Foot Pedal 2, those voices can be controlled with the Foot Pedal 2 as follows:*

- *Strike the pad while pressing the Foot Pedal 2, the "Closed" Hi- Hat voice will sound.*
- *Strike the pad without pressing the Foot Pedal 2, the "Open" Hi- Hat voice will sound.*
- *Press the Foot Pedal 2 without striking the pad, the Hi-Hat "Pedal" voice will sound.*

NOTE:

- *Phrase data cannot be transmitted.*
- *The pan data for each voice is fixed and cannot be changed, regardless of the pad assignments. For example, if a voice containing a "left" pan setting is assigned to a right pad, the actual sound will come from the left.*

Song List

Song No.	Song Name
Demo	
001	Rockadelic
002	16 Beat Ballad
003	Latin Pop
004	DD Funk
005	World Beat
Pattern	
006	Hard Rock 1
007	Hard Rock 2
008	Hard Rock 3
009	Hard Rock 4
010	Hard Rock 5
011	Heavy Metal 1
012	Heavy Metal 2
013	Heavy Metal 3
014	Southern Rock
015	Latin Rock
016	Groovy Rock
017	8 Beat 1
018	8 Beat 2
019	8 Beat 3
020	8 Beat 4
021	8 Beat Pop
022	8 Beat Rock'n Roll
023	16 Beat 1
024	16 Beat 2
025	16 Beat Dance
026	8 Beat Ballad 1
027	8 Beat Ballad 2
028	16 Beat Ballad 1
029	16 Beat Ballad 2
030	16 Beat Ballad 3
031	16 Beat Shuffle
032	6/8 Ballad
033	6/8 Slow Rock
034	Pop Shuffle 1

Song No.	Song Name
035	Pop Shuffle 2
036	Rock'n Roll Shuffle
037	Electro Dance
038	Dance Soul
039	Dance Beat
040	Hip Hop Shuffle 1
041	Hip Hop Shuffle 2
042	Techno Pop
043	Disco 1
044	Disco 2
045	4 Beat
046	Swing Jazz
047	5/4 Jazz
048	7/8 Jazz
049	Funky NYC
050	Soul
051	Soul Funk
052	Rock'n Roll
053	6/8 Blues
054	Country
055	Samba
056	Bossa Nova
057	Conga Bossa Nova
058	Soul Bossa Nova
059	Mambo
060	Cha Cha Cha
061	Rumba
062	Salsa
063	Beguine
064	Reggae
065	Waltz
066	Jazz Waltz
067	March
068	6/8 March
069	Saeidy
070	Maksoum

Song No.	Song Name
071	Baladi
072	Laff
073	Ayoub
074	Brazilian Samba
075	Chorinho
076	Partido Alto
077	Forro
078	Baiao
079	Bhangra
080	Bhajan
081	Bollywood Mix
082	Rajasthan
083	Dandiya
084	African
085	Folklore
086	Japanese 1
087	Japanese 2
088	Chinese
Song	
089	Hard Rock
090	8 Beat Pop
091	8 Beat Rock
092	16 Beat Pop
093	16 Beat Ballad
094	6/8 Ballad
095	Pop Rock
096	Pop Shuffle
097	Fusion Shuffle
098	Rock'n Roll
099	Club Mix
100	Disco
101	Jazz Funk
102	Blues Shuffle
103	Funk
104	Bossa Nova
105	Latin Fusion

Demo: These songs demonstrate the drum sounds and rhythms.

Pattern: These are special loop-repeating patterns for drum practice.

Song: These include drum and fill-in patterns. There is no loop playback.

Drum Kit List

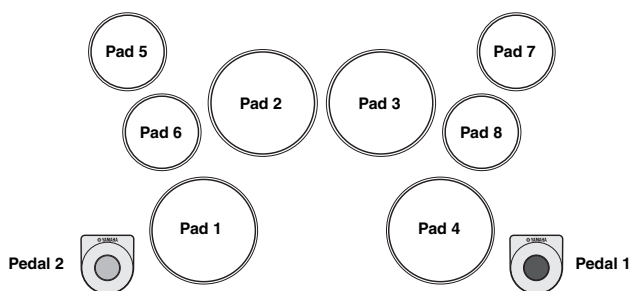

Kit No.	Kit Name	Voice No.	Pedal 1	Voice No.	Pedal 2	Voice No.	Pad 1	Voice No.	Pad 2	Voice No.	Pad 3
1	Maple Kit 1	3	Maple Bass Drum 3	180	Hi-Hat Pedal Bright	40	Maple Snare Open Rim	102	Maple Tom 5	103	Maple Tom 4
2	Maple Kit 2	3	Maple Bass Drum 3	180	Hi-Hat Pedal Bright	40	Maple Snare Open Rim	102	Maple Tom 5	103	Maple Tom 4
3	Maple Kit 3	3	Maple Bass Drum 3	180	Hi-Hat Pedal Bright	40	Maple Snare Open Rim	102	Maple Tom 5	208	Ride Cymbal Warm 1
4	Maple Kit 4	3	Maple Bass Drum 3	180	Hi-Hat Pedal Bright	39	Maple Snare Head	103	Maple Tom 4	105	Maple Tom 2
5	Oak Kit 1	4	Oak Bass Drum	183	Hi-Hat Pedal Dark	43	Oak Snare Open Rim	108	Oak Tom 5	109	Oak Tom 4
6	Oak Kit 2	4	Oak Bass Drum	183	Hi-Hat Pedal Dark	43	Oak Snare Open Rim	108	Oak Tom 5	109	Oak Tom 4
7	Oak Kit 3	4	Oak Bass Drum	183	Hi-Hat Pedal Dark	43	Oak Snare Open Rim	108	Oak Tom 5	215	Ride Cymbal Bright
8	Oak Kit 4	4	Oak Bass Drum	183	Hi-Hat Pedal Dark	42	Oak Snare Head	108	Oak Tom 5	111	Oak Tom 2
9	Hard Rock Kit 1	7	Bass Drum Hard Rock 3	186	Hi-Hat Pedal Dark 2	46	Snare Open Rim Hard Rock	114	Tom Hard Rock 5	115	Tom Hard Rock 4
10	Hard Rock Kit 2	10	Bass Drum Close Power	189	Hi-Hat Pedal Power	45	Snare Head Hard Rock	115	Tom Hard Rock 4	219	Ride Cymbal Warm 3
11	Hard Rock Kit 3	8	Bass Drum Ambient+	189	Hi-Hat Pedal Power	46	Snare Open Rim Hard Rock	114	Tom Hard Rock 5	115	Tom Hard Rock 4
12	Hard Rock Kit 4	16	Bass Drum Rock	193	Hi-Hat Pedal	66	Snare Rock Rim	137	Tom Rock 6	139	Tom Rock 4
13	Hard Rock Kit 5	16	Bass Drum Rock	193	Hi-Hat Pedal	65	Snare Rock	132	Tom Room 5	134	Tom Room 3
14	Analog T8 Kit 1	28	Kick T8 4	202	Hi-Hat Pedal T8	87	Snare T8 6	168	Tom T8 6	170	Tom T8 3
15	Analog T8 Kit 2	36	Kick Slimy	202	Hi-Hat Pedal T8	91	Snare Clap Analog	167	Tom T8 7	169	Tom T8 4
16	Analog T8 Kit 3	25	Kick T8 1	202	Hi-Hat Pedal T8	84	Snare T8 3	314	Conga T8 3	313	Conga T8 2
17	Vox Kit	34	Bass Drum Vox 1	205	Hi-Hat Pedal Vox	100	Snare Open Rim Vox	176	Tom Vox 3	177	Tom Vox 2
18	Stereo Kit 1	10	Bass Drum Close Power	189	Hi-Hat Pedal Power	49	Snare Power	119	Tom Power 6	121	Tom Power 4
19	Stereo Kit 2	9	Bass Drum Open Power	189	Hi-Hat Pedal Power	52	Snare Power 2	120	Tom Power 5	122	Tom Power 3
20	Stereo Kit 3	8	Bass Drum Ambient+	189	Hi-Hat Pedal Power	53	Snare Rough 2	119	Tom Power 6	121	Tom Power 4
21	Stereo Kit 4	8	Bass Drum Ambient+	189	Hi-Hat Pedal Power	48	Snare Soft Power	121	Tom Power 4	123	Tom Power 2
22	Stereo Kit 5	10	Bass Drum Close Power	189	Hi-Hat Pedal Power	50	Snare Rough	119	Tom Power 6	121	Tom Power 4
23	Stereo Ballad Kit	8	Bass Drum Ambient+	189	Hi-Hat Pedal Power	49	Snare Power	120	Tom Power 5	122	Tom Power 3
24	Ballad Kit 1	13	Bass Drum	193	Hi-Hat Pedal	55	Snare	127	Mid Tom L	129	Floor Tom H
25	Ballad Kit 2	14	Bass Drum 2	193	Hi-Hat Pedal	58	Snare Soft 2	127	Mid Tom L	129	Floor Tom H
26	Analog Ballad Kit 1	19	Bass Drum Analog H	196	Hi-Hat Closed Analog 2	69	Snare Analog 1	149	Tom Analog 6	151	Tom Analog 4
27	Analog Ballad Kit 2	18	Bass Drum Analog L	196	Hi-Hat Closed Analog 2	69	Snare Analog 1	149	Tom Analog 6	151	Tom Analog 4
28	Stereo Shuffle Kit 1	9	Bass Drum Open Power	189	Hi-Hat Pedal Power	50	Snare Rough	119	Tom Power 6	121	Tom Power 4
29	Stereo Shuffle Kit 2	10	Bass Drum Close Power	189	Hi-Hat Pedal Power	53	Snare Rough 2	119	Tom Power 6	121	Tom Power 4
30	Stereo Shuffle Kit 3	10	Bass Drum Close Power	189	Hi-Hat Pedal Power	53	Snare Rough 2	119	Tom Power 6	121	Tom Power 4
31	Stereo Slow Rock Kit	10	Bass Drum Close Power	189	Hi-Hat Pedal Power	48	Snare Soft Power	119	Tom Power 6	121	Tom Power 4
32	Electric Kit 1	17	Bass Drum Gate	193	Hi-Hat Pedal	68	Snare Noisy 2	143	Tom Electronic 6	145	Tom Electronic 4
33	Electric Kit 2	17	Bass Drum Gate	193	Hi-Hat Pedal	67	Snare Snappy Electronic	143	Tom Electronic 6	145	Tom Electronic 4
34	Dance Kit 1	21	Kick Techno L	199	Hi-Hat Closed Analog 4	71	Snare Clap	149	Tom Analog 6	151	Tom Analog 4
35	Dance Kit 2	22	Kick Techno	199	Hi-Hat Closed Analog 4	70	Snare Techno	149	Tom Analog 6	151	Tom Analog 4

Kit No.	Voice No.	Pad 4	Voice No.	Pad 5	Voice No.	Pad 6	Voice No.	Pad 7	Voice No.	Pad 8
1	105	Maple Tom 2	211	Crash Cymbal Dark	179	Hi-Hat Closed Bright	210	Ride Cymbal Cup Warm	208	Ride Cymbal Warm 1
2	105	Maple Tom 2	211	Crash Cymbal Dark	179	Hi-Hat Closed Bright	213	Splash Cymbal 2	208	Ride Cymbal Warm 1
3	105	Maple Tom 2	211	Crash Cymbal Dark	179	Hi-Hat Closed Bright	212	Chinese Cymbal 2	210	Ride Cymbal Cup Warm
4	41	Maple Side Stick	211	Crash Cymbal Dark	179	Hi-Hat Closed Bright	210	Ride Cymbal Cup Warm	208	Ride Cymbal Warm 1
5	111	Oak Tom 2	217	Crash Cymbal Dark 2	182	Hi-Hat Closed Dark	216	Ride Cymbal Cup Bright	215	Ride Cymbal Bright
6	111	Oak Tom 2	217	Crash Cymbal Dark 2	182	Hi-Hat Closed Dark	213	Splash Cymbal 2	215	Ride Cymbal Bright
7	111	Oak Tom 2	217	Crash Cymbal Dark 2	182	Hi-Hat Closed Dark	212	Chinese Cymbal 2	216	Ride Cymbal Cup Bright
8	44	Oak Side Stick	217	Crash Cymbal Dark 2	107	Oak Tom 6	215	Ride Cymbal Bright	182	Hi-Hat Closed Dark
9	117	Tom Hard Rock 2	221	Crash Cymbal Dark 3	185	Hi-Hat Closed Dark 2	220	Ride Cymbal Cup Warm 2	219	Ride Cymbal Warm 3
10	117	Tom Hard Rock 2	222	Crash Cymbal Power 1	185	Hi-Hat Closed Dark 2	220	Ride Cymbal Cup Warm 2	218	Crash Cymbal Warm 2
11	117	Tom Hard Rock 2	222	Crash Cymbal Power 1	185	Hi-Hat Closed Dark 2	234	Chinese Cymbal	225	Ride Cymbal Power 2
12	141	Tom Rock 2	229	Crash Cymbal 1	192	Hi-Hat Closed	348	Cowbell Top	231	Ride Cymbal 1
13	136	Tom Room 1	229	Crash Cymbal 1	192	Hi-Hat Closed	234	Chinese Cymbal	231	Ride Cymbal 1
14	172	Tom T8 1	241	Crash Cymbal T8	201	Hi-Hat Closed T8	350	Cowbell T8	251	Clap T9
15	171	Tom T8 2	241	Crash Cymbal T8	201	Hi-Hat Closed T8	92	Snare T8 Rim	93	Snare Analog CR
16	312	Conga T8 1	241	Crash Cymbal T8	201	Hi-Hat Closed T8	92	Snare T8 Rim	251	Clap T9
17	178	Tom Vox 1	242	Crash Cymbal Vox 1	204	Hi-Hat Closed Vox	244	Ride Cymbal Cup Vox	245	Crash Cymbal Vox 2
18	123	Tom Power 2	222	Crash Cymbal Power 1	188	Hi-Hat Closed Power	228	Splash Cymbal Power	225	Ride Cymbal Power 2
19	124	Tom Power 1	222	Crash Cymbal Power 1	191	Hi-Hat Closed Power 2	228	Splash Cymbal Power	225	Ride Cymbal Power 2
20	123	Tom Power 2	222	Crash Cymbal Power 1	191	Hi-Hat Closed Power 2	228	Splash Cymbal Power	225	Ride Cymbal Power 2
21	246	Side Stick Power	228	Splash Cymbal Power	256	Tambourine 2	222	Crash Cymbal Power 1	188	Hi-Hat Closed Power
22	123	Tom Power 2	222	Crash Cymbal Power 1	188	Hi-Hat Closed Power	228	Splash Cymbal Power	225	Ride Cymbal Power 2
23	124	Tom Power 1	222	Crash Cymbal Power 1	188	Hi-Hat Closed Power	228	Splash Cymbal Power	225	Ride Cymbal Power 2
24	247	Side Stick	230	Crash Cymbal 2	192	Hi-Hat Closed	233	Ride Cymbal Cup	231	Ride Cymbal 1
25	247	Side Stick	229	Crash Cymbal 1	192	Hi-Hat Closed	257	Tambourine	231	Ride Cymbal 1
26	153	Tom Analog 2	236	Cymbal Analog	195	Hi-Hat Closed Analog 1	360	Claves	232	Ride Cymbal 2
27	153	Tom Analog 2	236	Cymbal Analog	195	Hi-Hat Closed Analog 1	360	Claves	232	Ride Cymbal 2
28	123	Tom Power 2	222	Crash Cymbal Power 1	188	Hi-Hat Closed Power	228	Splash Cymbal Power	225	Ride Cymbal Power 2
29	123	Tom Power 2	222	Crash Cymbal Power 1	191	Hi-Hat Closed Power 2	228	Splash Cymbal Power	225	Ride Cymbal Power 2
30	123	Tom Power 2	222	Crash Cymbal Power 1	191	Hi-Hat Closed Power 2	256	Tambourine 2	225	Ride Cymbal Power 2
31	123	Tom Power 2	222	Crash Cymbal Power 1	188	Hi-Hat Closed Power	228	Splash Cymbal Power	225	Ride Cymbal Power 2
32	147	Tom Electronic 2	229	Crash Cymbal 1	192	Hi-Hat Closed	234	Chinese Cymbal	231	Ride Cymbal 1
33	147	Tom Electronic 2	229	Crash Cymbal 1	192	Hi-Hat Closed	234	Chinese Cymbal	231	Ride Cymbal 1
34	153	Tom Analog 2	236	Cymbal Analog	198	Hi-Hat Closed Analog 3	370	Triangle Open	369	Triangle Mute
35	153	Tom Analog 2	236	Cymbal Analog	198	Hi-Hat Closed Analog 3	249	Hand Clap	257	Tambourine

Drum Kit List

Kit No.	Kit Name	Voice No.	Pedal 1	Voice No.	Pedal 2	Voice No.	Pad 1	Voice No.	Pad 2	Voice No.	Pad 3
36	Analog Kit	19	Bass Drum Analog H	196	Hi-Hat Closed Analog 2	69	Snare Analog 1	249	Hand Clap	151	Tom Analog 4
37	DJ Kit	20	Kick Techno Q	199	Hi-Hat Closed Analog 4	73	Rim Gate	556	Yo!	557	Go!
38	Disco Kit 1	13	Bass Drum	193	Hi-Hat Pedal	56	Snare Tight	126	Mid Tom H	128	Low Tom
39	Disco Kit 2	21	Kick Techno L	199	Hi-Hat Closed Analog 4	70	Snare Techno	249	Hand Clap	151	Tom Analog 4
40	Jazz Kit	23	Bass Drum Jazz	193	Hi-Hat Pedal	74	Snare Jazz L	155	Tom Jazz 6	157	Tom Jazz 4
41	Brush Kit	12	Bass Drum Hard	193	Hi-Hat Pedal	81	Brush Slap	161	Tom Brush 6	163	Tom Brush 4
42	5/4 Jazz Kit	11	Bass Drum Soft	193	Hi-Hat Pedal	58	Snare Soft 2	125	High Tom	127	Mid Tom L
43	Dixieland Kit	12	Bass Drum Hard	193	Hi-Hat Pedal	58	Snare Soft 2	80	Brush Tap	81	Brush Slap
44	Soul Kit	9	Bass Drum Open Power	189	Hi-Hat Pedal Power	53	Snare Rough 2	120	Tom Power 5	122	Tom Power 3
45	R & R Kit	13	Bass Drum	193	Hi-Hat Pedal	54	Snare Soft	125	High Tom	127	Mid Tom L
46	6/8 Blues Kit	8	Bass Drum Ambient+	189	Hi-Hat Pedal Power	48	Snare Soft Power	120	Tom Power 5	122	Tom Power 3
47	Country Kit	13	Bass Drum	193	Hi-Hat Pedal	62	Snare Room L	133	Tom Room 4	135	Tom Room 2
48	Samba Kit	13	Bass Drum	355	Maracas	364	Cuica Mute	352	Agogo H	353	Agogo L
49	Bossa Nova Kit 1	12	Bass Drum Hard	193	Hi-Hat Pedal	247	Side Stick	162	Tom Brush 5	164	Tom Brush 3
50	Bossa Nova Kit 2	4	Oak Bass Drum	183	Hi-Hat Pedal Dark	42	Oak Snare Head	108	Oak Tom 5	111	Oak Tom 2
51	Conga Kit	294	Conga L Slide	348	Cowbell Top	285	Conga H Slap Mute	281	Conga H Open	288	Conga L Open
52	Conga & Bongo Kit 1	14	Bass Drum 2	348	Cowbell Top	281	Conga H Open	288	Conga L Open	315	Bongo H Open 1 Finger
53	Conga & Bongo Kit 2	14	Bass Drum 2	348	Cowbell Top	301	Conga 2 H Open	308	Conga 2 L Open	327	Bongo 2 H Mute
54	Salsa Kit	13	Bass Drum	362	Wood Block H	322	Bongo L Open 3 Fingers	339	Timbale L Open	338	Timbale H Open
55	Beguine Kit	12	Bass Drum Hard	193	Hi-Hat Pedal	247	Side Stick	126	Mid Tom H	128	Low Tom
56	Reggae Kit	8	Bass Drum Ambient+	189	Hi-Hat Pedal Power	50	Snare Rough	339	Timbale L Open	338	Timbale H Open
57	Waltz Kit	23	Bass Drum Jazz	193	Hi-Hat Pedal	80	Brush Tap	81	Brush Slap	162	Tom Brush 5
58	March Kit	37	Gran Cassa	193	Hi-Hat Pedal	76	Band Snare 1	362	Wood Block H	363	Wood Block L
59	Timpani Kit	37	Gran Cassa	193	Hi-Hat Pedal	264	Timpani E1	269	Timpani A1	274	Timpani D2
60	Arabic Kit 1	449	Katem Dom	451	Katem Tak 1	437	Tablah Dom 1	436	Tablah Sak 1	433	Tablah Tak 4
61	Arabic Kit 2	449	Katem Dom	451	Katem Tak 1	446	Daholla Dom	444	Daholla Sak 1	447	Daholla Tak 2
62	Arabic Kit 3	474	Sagat 1	476	Sagat 3	449	Katem Dom	450	Katem Sak 1	451	Katem Tak 1
63	Brazil Kit 1	399	Tan Tan 1 Open Right Hand	398	Tan Tan 1 Closed Right Hand	402	Pandeiro L Thumb Closed	404	Pandeiro L Toe Rim	405	Pandeiro L Heel
64	Brazil Kit 2	378	Surdo 2 Open	377	Surdo 2 Mute	402	Pandeiro L Thumb Closed	404	Pandeiro L Toe Rim	405	Pandeiro L Heel
65	Brazil Kit 3	391	Zabumba Open Right Hand	392	Zabumba Mute Right Hand	402	Pandeiro L Thumb Closed	404	Pandeiro L Toe Rim	405	Pandeiro L Heel
66	Indian Kit 1	510	Dholak 2 Rim 1	491	Hatheli Short	479	Baya ghe	477	Baya ge	481	Tabla na
67	Indian Kit 2	502	Dhol 2 Open	504	Dhol 2 Rim	508	Dholak 2 Open	510	Dholak 2 Rim 1	511	Dholak 2 Rim 2
68	Indian Kit 3	498	Dafli Open	499	Dafli Rim	502	Dhol 2 Open	504	Dhol 2 Rim	513	Dholki H Mute
69	Indian Kit 4	498	Dafli Open	499	Dafli Rim	500	Dhol 1 Open	501	Dhol 1 Slap	503	Dhol 2 Slap
70	African Kit	13	Bass Drum	354	Cabasa	539	Djembe Slap	537	Djembe L	545	Talking Drum Left Hand Open
71	Folklore Kit	13	Bass Drum	372	Jingle Bells	376	Cajon 2 Slap	374	Cajon 2 L	373	Wind Chime
72	Japanese Kit	548	Yaguradaiko	549	Yaguradaiko Rim	546	Oodaiko	551	Shimedaiko	550	Atarigane
73	Chinese Kit	528	Dagu Heavy	530	Zhongcha Mute	527	Paigu M	526	Bangu	535	Xiaocha Mute
74	SE Kit 1	562	Footsteps	562	Footsteps	564	Rooster	568	Horse Neigh	569	Cow
75	SE Kit 2	557	Go!	562	Footsteps	556	Yo!	560	Huuuah!	561	Uh!+Hit

Kit No.	Voice No.	Pad 4	Voice No.	Pad 5	Voice No.	Pad 6	Voice No.	Pad 7	Voice No.	Pad 8
36	153	Tom Analog 2	236	Cymbal Analog	195	Hi-Hat Closed Analog 1	348	Cowbell Top	257	Tambourine
37	558	Get up!	236	Cymbal Analog	198	Hi-Hat Closed Analog 3	554	Scratch H	555	Scratch L
38	130	Floor Tom L	229	Crash Cymbal 1	192	Hi-Hat Closed	235	Splash Cymbal	231	Ride Cymbal 1
39	153	Tom Analog 2	236	Cymbal Analog	198	Hi-Hat Closed Analog 3	257	Tambourine	230	Crash Cymbal 2
40	159	Tom Jazz 2	229	Crash Cymbal 1	192	Hi-Hat Closed	233	Ride Cymbal Cup	231	Ride Cymbal 1
41	165	Tom Brush 2	229	Crash Cymbal 1	192	Hi-Hat Closed	233	Ride Cymbal Cup	232	Ride Cymbal 2
42	129	Floor Tom H	229	Crash Cymbal 1	192	Hi-Hat Closed	257	Tambourine	231	Ride Cymbal 1
43	130	Floor Tom L	229	Crash Cymbal 1	192	Hi-Hat Closed	235	Splash Cymbal	231	Ride Cymbal 1
44	124	Tom Power 1	222	Crash Cymbal Power 1	188	Hi-Hat Closed Power	249	Hand Clap	225	Ride Cymbal Power 2
45	129	Floor Tom H	229	Crash Cymbal 1	192	Hi-Hat Closed	235	Splash Cymbal	231	Ride Cymbal 1
46	124	Tom Power 1	222	Crash Cymbal Power 1	188	Hi-Hat Closed Power	249	Hand Clap	225	Ride Cymbal Power 2
47	247	Side Stick	229	Crash Cymbal 1	192	Hi-Hat Closed	235	Splash Cymbal	231	Ride Cymbal 1
48	365	Cuica Open	390	Tamborim 1 Mute	389	Tamborim 1 Open	397	Whistle Long	396	Whistle Short
49	81	Brush Slap	229	Crash Cymbal 1	192	Hi-Hat Closed	373	Wind Chime	231	Ride Cymbal 1
50	247	Side Stick	217	Crash Cymbal Dark 2	182	Hi-Hat Closed Dark	235	Splash Cymbal	215	Ride Cymbal Bright
51	289	Conga L Mute	287	Conga H Heel	286	Conga H Tip	356	Guiro Short	357	Guiro Long
52	322	Bongo L Open 3 Fingers	287	Conga H Heel	285	Conga H Slap Mute	356	Guiro Short	357	Guiro Long
53	328	Bongo 2 L Open 1 Finger	299	Conga Heel	297	Conga Slap	356	Guiro Short	357	Guiro Long
54	288	Conga L Open	360	Claves	315	Bongo H Open 1 Finger	373	Wind Chime	281	Conga H Open
55	130	Floor Tom L	229	Crash Cymbal 1	192	Hi-Hat Closed	231	Ride Cymbal 1	360	Claves
56	122	Tom Power 3	222	Crash Cymbal Power 1	188	Hi-Hat Closed Power	230	Crash Cymbal 2	231	Ride Cymbal 1
57	165	Tom Brush 2	229	Crash Cymbal 1	192	Hi-Hat Closed	233	Ride Cymbal Cup	232	Ride Cymbal 2
58	77	Band Snare 2	229	Crash Cymbal 1	192	Hi-Hat Closed	257	Tambourine	231	Ride Cymbal 1
59	279	Timpani G2	222	Crash Cymbal Power 1	192	Hi-Hat Closed	373	Wind Chime	231	Ride Cymbal 1
60	432	Tablah Tak 1	474	Sagat 1	476	Sagat 3	471	Riq Tak 2	473	Riq Dom
61	445	Daholla Tak 1	474	Sagat 1	476	Sagat 3	471	Riq Tak 2	473	Riq Dom
62	453	Katem Tak 2	471	Riq Tak 2	473	Riq Dom	472	Riq Brass 2	470	Riq Brass 1
63	403	Pandeiro L Thumb Open	414	Repique de Mao Slap	415	Repique de Mao Thmb Rim	426	Ganza	406	Pandeiro L Slap
64	403	Pandeiro L Thumb Open	422	Agogo Bell 1	423	Agogo Bell 2	366	Cuica H Short	368	Cuica L Short
65	403	Pandeiro L Thumb Open	422	Agogo Bell 1	424	Agogo Click 1	426	Ganza	406	Pandeiro L Slap
66	482	Tabla tin	480	Baya ka	478	Baya ke	497	Mondira Closed	496	Mondira Open
67	509	Dholak 2 Slide	513	Dholki H Mute	515	Dholki H Slap	495	Jhanji Closed	494	Jhanji Open
68	512	Dholki H Open	510	Dholak 2 Rim 1	511	Dholak 2 Rim 2	490	Hatheli Long	491	Hatheli Short
69	504	Dhol 2 Rim	524	Dandia Short	525	Dandia Long	490	Hatheli Long	491	Hatheli Short
70	543	Talking Drum Bend Up	229	Crash Cymbal 1	538	Djembe Mute	544	Talking Drum Slap	542	Talking Drum Open
71	258	Finger Snap	371	Shaker	375	Cajon 2 Mute	256	Tambourine 2	235	Splash Cymbal
72	372	Jingle Bells	552	Tsudumi	547	Oodaiko Rim	553	Ainote	360	Claves
73	531	Luo Big	533	Zhongluo Open	529	Zhongcha Open	532	Luo H	534	Xiaoluo Open
74	570	Lion	566	Cat	565	Dog	563	Frog	567	Owl
75	559	Whoow!	249	Hand Clap	558	Get up!	554	Scratch H	555	Scratch L

Drum Score

There are many different types of drum score commercially available, but we've chosen the following common format for the examples below.

Hi-Hat Cymbal (H.H.)
Ride Cymbal (RIDE)

Hi-Hat (H.H.)
Open Close

Crash Cymbal

Snare Drum

Snare Drum
(Brush Slap)

High Tom

Mid Tom

Low Tom

Hi-Hat Cymbal (PEDAL)

Bass Drum

High Low

The following is an actual rhythm pattern using the notation.

■ 8 Beat (song No.021)

■ 16 Beat (song No.023)

■ **4 Beat** (song No.045)

In the notation above, eighth notes are to be played with a triplet feel (as shown in the notation below). For swing and shuffle rhythms, this straight notation is preferable to the triplet indication since it is easier to read.

■ **Shuffle** (song No.034)

Play the above pattern with a swing feel.

Specifications

Product Name		Digital Percussion	
Size/Weight	Dimensions (W x D x H)	602mm x 411mm x 180mm (23-11/16" x 16-3/16" x 7-1/16")	
	Weight	4.2kg (9 lb 4 oz) (not including batteries)	
Pads/Pedals	Number of Pads	8	
	Number of Pedals	2	
	Hand Percussion Mode	Yes	
	Pad/Pedal Sensitivity	Preset: 5 types (Fix, 1-4) Custom Setting: 10	
Display	Type	7-Segment LED	
Panel	Language	English	
Voices	Tone Generation Technology		AWM Stereo Sampling
	Polyphony		32 (max.)
	Compatibility		GM, XGlite
	Number of Voices		570 Voices + 30 Phrases
	Number of Drum Kits	Preset Kit	75
Custom Kit		10	
Effects	Types	Reverb	9 types
		Master EQ	2 types
Song	Preset	Number of Preset Songs	105
		Number of Songs	5
	Recording	Number of Tracks	4 (DRUM 1/DRUM 2/DRUM 3/BACKING)
		Data Capacity	Approx. 7,000 notes per song
	Format	Playback	SMF (Format 0), (MIDI data only; audio not supported.)
		Recording	SMF (Format 0), (MIDI data only; audio not supported.)
	Other Features	Auto Kit Select	Yes
		Tap Start	Yes
Break		Yes	
Click	Tempo Range	11–320	
	Click Voice	4 types (Metronome/Cowbell/Stick/Human Voice)	
Storage and Connectivity	Storage	Internal Memory	Approx. 370KB
	Connections	DC IN	12V
		Headphones	Standard stereo phone jack
		AUX IN	Stereo mini jack
		PEDAL	1, 2
		MIDI	IN, OUT
Amplifiers/ Speakers	Amplifiers	5W + 5W	
	Speakers	8cm x 2	
Power Supply	Adaptor	PA-150	
	Battery	Size C battery (alkaline dry cell/manganese-by-cell/ rechargeable Ni-MH battery) x 6	
	Power Consumption	18W	
	Auto Power Off	Yes	
Included Accessories		<ul style="list-style-type: none"> • Owner's Manual • AC adaptor x 1 (PA-150 or an equivalent recommended by Yamaha) • Drum Sticks • Foot Pedal 1 & 2 • Online Member Product Registration x 1 	
Separately Sold Accessories (May not be available depending on your locale.)		<ul style="list-style-type: none"> • AC adaptor: Users within U.S or Europe: PA-150 or an equivalent recommended by Yamaha Others: PA-150 or an equivalent • Headphones: HPH-50/HPH-100/HPH-150 • Wireless MIDI adaptor: MD-BT01 • Hi-hat controller: HH40/HH65 • Electronic kick unit: KU100 • Electronic drum pad: KP65 • Snare drum stand: SS662/SS740A 	

* The contents of this manual apply to the latest specifications as of the publishing date. To obtain the latest manual, access the Yamaha website then download the manual file. Since specifications, equipment or separately sold accessories may not be the same in every locale, please check with your Yamaha dealer.

Index

A	
A-B Repeat	34
AC Adaptor	12
Auto Kit Select	31
Auto Power Off	14
B	
Backup	41
Battery	12, 13
Beat Indicator	29
Break	33
C	
Click	25
Click Voice	27
Click Volume	26
Compatible Formats and Functions	8
Computer	38
Computer-related Operations	7
Custom Kit	20
D	
Demo Song	16
Drum Kit	19
Drum Kit List	48
Drum Score	52
Drum Voice List	43
E	
External Audio Device	39
F	
Function	40
H	
Hand Percussion	18
Headphone	14
I	
Initialization	41
iPhone/iPad Connection Manual	7
M	
Master EQ Type	14
Master Volume	14
MIDI Device	38
MIDI Reference	7, 38
Musicsoft Downloader	38
O	
Online Member Product Registration	7
P	
Pad	17
Pad Start	30
Pedal	13, 17
R	
Recording	35
Reverb type	21
S	
Sensitivity	22
Song Clear	37
Song List	47
Song Volume	29
Specifications	54
T	
Tap Start	29
Tempo	32
Time Signature	25
Track	33
Troubleshooting	42

Information for users on collection and disposal of old equipment and used batteries:



These symbols on the products, packaging, and/or accompanying documents mean that used electrical and electronic products and batteries should not be mixed with general household waste.

For proper treatment, recovery and recycling of old products and used batteries, please take them to applicable collection points, in accordance with your national legislation.



By disposing of these products and batteries correctly, you will help to save valuable resources and prevent any potential negative effects on human health and the environment which could otherwise arise from inappropriate waste handling.



For more information about collection and recycling of old products and batteries, please contact your local municipality, your waste disposal service or the point of sale where you purchased the items.

For business users in the European Union:

If you wish to discard electrical and electronic equipment, please contact your dealer or supplier for further information.



Information on Disposal in other Countries outside the European Union:

These symbols are only valid in the European Union. If you wish to discard these items, please contact your local authorities or dealer and ask for the correct method of disposal.

Note for the battery symbol (bottom two symbol examples):

This symbol might be used in combination with a chemical symbol. In this case it complies with the requirement set by the EU Battery Directive for the chemical involved.

Cd

(weee_battery_eu_en_02)



LIMITED 1-YEAR WARRANTY ON PORTABLE DIGITAL DRUMS

Thank you for selecting a Yamaha product. Yamaha products are designed and manufactured to provide a high level of defect-free performance. Yamaha Corporation of America ("Yamaha") is proud of the experience and craftsmanship that goes into each and every Yamaha product. Yamaha sells its products through a network of reputable, specially authorized dealers and is pleased to offer you, the Original Owner, the following Limited Warranty, which applies only to products that have been (1) directly purchased from Yamaha's authorized dealers in the fifty states of the USA and District of Columbia (the "Warranted Area") and (2) used exclusively in the Warranted Area. Yamaha suggests that you read the Limited Warranty thoroughly, and invites you to contact your authorized Yamaha dealer or Yamaha Customer Service if you have any questions.

Coverage: Yamaha will, at its option, repair or replace the product covered by this warranty if it becomes defective, malfunctions or otherwise fails to conform with this warranty under normal use and service during the term of this warranty, without charge for labor or materials. Repairs may be performed using new or refurbished parts that meet or exceed Yamaha specifications for new parts. If Yamaha elects to replace the product, the replacement may be a reconditioned unit. You will be responsible for any installation or removal charges and for any initial shipping charges if the product(s) must be shipped for warranty service. However, Yamaha will pay the return shipping charges to any destination within the USA if the repairs are covered by the warranty. This warranty does not cover (a) damage, deterioration or malfunction resulting from accident, negligence, misuse, abuse, improper installation or operation or failure to follow instructions according to the Owner's Manual for this product; any shipment of the product (claims must be presented to the carrier); repair or attempted repair by anyone other than Yamaha or an authorized Yamaha Service Center; (b) any unit which has been altered or on which the serial number has been defaced, modified or removed; (c) normal wear and any periodic maintenance; (d) deterioration due to perspiration, corrosive atmosphere or other external causes such as extremes in temperature or humidity; (e) damages attributable to power line surge or related electrical abnormalities, lightning damage or acts of God; or (f) RFI/EMI (Interference/noise) caused by improper grounding or the improper use of either certified or uncertified equipment, if applicable or (g) drum sticks. Any evidence of alteration, erasing or forgery of proof-of-purchase documents will cause this warranty to be void. This warranty covers only the Original Owner and is not transferable.

In Order to Obtain Warranty Service: Warranty service will only be provided for defective products within the Warranted Area. Contact your local authorized Yamaha dealer who will advise you of the procedures to be followed. If this is not successful, contact Yamaha at the address, telephone number or website shown below. Yamaha may request that you send the defective product to a local authorized Yamaha Servicer or authorize return of the defective product to Yamaha for repair. If you are uncertain as to whether a dealer has been authorized by Yamaha, please contact Yamaha's Service Department at the number shown below, or check Yamaha's website at www.Yamaha.com. Product(s) shipped for service should be packed securely and must be accompanied by a detailed explanation of the problem(s) requiring service, together with the original or a machine reproduction of the bill of sale or other dated, proof-of-purchase document describing the product, as evidence of warranty coverage. Should any product submitted for warranty service be found ineligible therefore, an estimate of repair cost will be furnished and the repair will be accomplished only if requested by you and upon receipt of payment or acceptable arrangement for payment.

Limitation of Implied Warranties and Exclusion of Damages: ANY IMPLIED WARRANTIES, INCLUDING WARRANTIES OF MERCHANTABILITY AND FITNESS FOR A PARTICULAR PURPOSE SHALL BE LIMITED IN DURATION TO THE APPLICABLE PERIOD OF TIME SET FORTH ABOVE. YAMAHA SHALL NOT BE RESPONSIBLE FOR INCIDENTAL OR CONSEQUENTIAL DAMAGES OR FOR DAMAGES BASED UPON INCONVENIENCE, LOSS OF USE, DAMAGE TO ANY OTHER EQUIPMENT OR OTHER ITEMS AT THE SITE OF USE OR INTERRUPTION OF PERFORMANCES OR ANY CONSEQUENCES. YAMAHA'S LIABILITY FOR ANY DEFECTIVE PRODUCT IS LIMITED TO REPAIR OR REPLACEMENT OF THE PRODUCT, AT YAMAHA'S OPTION. SOME STATES DO NOT ALLOW LIMITATIONS ON HOW LONG AN IMPLIED WARRANTY LASTS OR THE EXCLUSION OR LIMITATION OF INCIDENTAL OR CONSEQUENTIAL DAMAGES, SO THE ABOVE LIMITATION OR EXCLUSION MAY NOT APPLY TO YOU. This Warranty gives you specific legal rights, and you may also have other rights which vary from state to state. This is the only express warranty applicable to the product specified herein; Yamaha neither assumes nor authorizes anyone to assume for it any other express warranty.

If you have any questions about service received or if you need assistance in locating an authorized Yamaha Servicer, please contact:



CUSTOMER SERVICE
Yamaha Corporation of America
6600 Orangethorpe Avenue, Buena Park, California 90620-1373
Telephone: 800-854-1569
www.yamaha.com

Do not return any product to the above address without a written Return Authorization issued by YAMAHA.

©2009 Yamaha Corporation of America. Effective: 11/01/09

Important Notice: Guarantee Information for customers in EEA* and Switzerland (EEA) and Switzerland

English	Important Notice: Guarantee Information for customers in EEA* and Switzerland For detailed guarantee information about this Yamaha product, and Pan-EEA* and Switzerland warranty service, please either visit the website address below (Printable file is available at our website) or contact the Yamaha representative office for your country. * EEA: European Economic Area
Deutsch	Wichtiger Hinweis: Garantie-Information für Kunden in der EWR* und der Schweiz Für nähere Garantie-Information über dieses Produkt von Yamaha, sowie über den Pan-EWR*- und Schweizer Garantieservice, besuchen Sie bitte entweder die folgende angegebene Internetadresse (eine druckfähige Version befindet sich auch auf unserer Webseite), oder wenden Sie sich an den für Ihr Land zuständigen Yamaha-Vertrieb. *EWR: Europäischer Wirtschaftsraum
Français	Remarque importante: informations de garantie pour les clients de l'EEE et la Suisse Pour des informations détaillées sur la garantie de ce produit Yamaha et sur le service de garantie applicable dans l'ensemble de l'EEE ainsi qu'en Suisse, consultez notre site Web à l'adresse ci-dessous (le fichier imprimable est disponible sur notre site Web) ou contactez directement Yamaha dans votre pays de résidence. * EEE : Espace Economique Européen
Nederlands	Belangrijke mededeling: Garantie-informatie voor klanten in de EER* en Zwitserland Voor gedetailleerde garantie-informatie over dit Yamaha-product en de garantieservice in heel de EER* en Zwitserland, gaat u naar de onderstaande website (u vindt een afprintbaar bestand op onze website) of neemt u contact op met de vertegenwoordiging van Yamaha in uw land. * EER: Europese Economische Ruimte
Español	Aviso importante: Información sobre la garantía para los clientes del EEE* y Suiza Para una información detallada sobre este producto Yamaha y sobre el soporte de garantía en la zona EEE* y Suiza, visite la dirección web que se incluye más abajo (la versión del archivo para imprimir está disponible en nuestro sitio web) o póngase en contacto con el representante de Yamaha en su país. * EEE: Espacio Económico Europeo
Italiano	Aviso importante: informazioni sulla garanzia per i clienti residenti nell'EEA* e in Svizzera Per informazioni dettagliate sulla garanzia relativa a questo prodotto Yamaha e l'assistenza in garanzia nei paesi EEA* e in Svizzera, potete consultare il sito Web all'indirizzo riportato di seguito (è disponibile il file in formato stampabile) oppure contattate l'ufficio di rappresentanza locale della Yamaha. * EEA: Area Economica Europea
Português	Aviso importante: informações sobre as garantias para clientes da AEE* e da Suíça Para obter uma informação pormenorizada sobre este produto da Yamaha e sobre o serviço de garantia na AEE* e na Suíça, visite o site a seguir (o arquivo para impressão está disponível no nosso site) ou entre em contato com o escritório de representação da Yamaha no seu país. * AEE: Área Económica Europeia
Ελληνικά	Σημαντική σημείωση: Πληροφορίες εγγύησης για τους πελάτες στον ΕΟΧ* και Ελλάδα Για λεπτομερείς πληροφορίες εγγύησης σχετικά με το παρόν προϊόν της Yamaha και την κάλυψη εγγύησης σε όλη τη χώρας του ΕΟΧ* και την Ελλάδα, επισκεψτείτε την παρακάτω ιστοσελίδα (εγκριμένο αντίγραφο που είναι διαθέσιμο στην ιστοσελίδα μας) ή απευθείας στην αντιπροσωπεία της Yamaha στην χώρα σας. * ΕΟΧ: Ευρωπαϊκό Οικονομικό Χώρο
Svenska	Viktig: Garantierinformation för kunder i EES-området* och Schweiz För detaljerad information om denna Yamaha-produkt samt garantier i hela EES-området* och Schweiz kan du antingen besöka nedanstående webbadress (en utskriftsvärdig fil finns på webbplatsen) eller kontakta Yamahas officiella representant i ditt land. * EES: Europeiska Ekonomiska Samarbetsområdet
Norsk	Viktig merknad: Garantierinformasjon for kunder i EØS* og Sveits Detaljert garantierinformasjon om dette Yamaha-produktet og garantier i hele EØS-området* og Sveits kan fås enten ved å besøke nettstedene nedenfor (utskriftsversjon finnes på våre nettsider) eller kontakte Yamahas-kontoret i landet der du bor. *EØS: Det europeiske økonomiske samarbeidsområdet
Dansk	Vigtig oplysning: Garantiplysninger til kunder i EØO* og Schweiz De kan finde detaljerede garantiplysninger om dette Yamaha-produkt og den fælles garantieserviceordning for EØO* (og Schweiz) ved at besøge det websted, der er angivet nedenfor (der findes en fil, som kan udskrives, på vores websted), eller ved at kontakte Yamahas nationale repræsentationskontor i det land, hvor De bor. * EØO: Det Europæiske Økonomiske Område

Suomi	Tärkeä ilmoitus: Takuutiedot Euroopan talousalueen (ETA) ja Sveitsin asiakkaille Tämän Yamaha-tuotteen sekä ETA-alueen ja Sveitsin takuuta koskevat yksityiskohtaiset tiedot saatte alla olevasta nettosoitteesta. (Tulostettava tiedosto saatavissa suositollamme.) Voitte myös ottaa yhteyttä paikalliseen Yamaha-edustajaan. *ETA: Euroopan talousalue
Polski	Ważne: Warunki gwarancyjne obowiązujące w EOG* i Szwajcarii Aby dowiedzieć się więcej na temat warunków gwarancyjnych tego produktu firmy Yamaha i serwisu gwarancyjnego w całym EOG* i Szwajcarii, należy odwiedzić wskazaną poniżej stronę internetową (plik gotowy do wydruku znajduje się na naszej stronie internetowej) lub skontaktować się z przedstawicielstwem firmy Yamaha w swoim kraju. * EOG — Europejski Obszar Gospodarczy
Česky	Důležité oznámení: Zaruční informace pro zákazníky v EHS* a ve Švýcarsku Podrobné zaruční informace o tomto produktu Yamaha a záruční servis u celém EHS* a ve Švýcarsku naleznete na níže uvedené webové adrese (soubor k tisku je dostupný na našich webových stránkách) nebo se můžete obrátit na zastoupení firmy Yamaha ve své zemi. * EHS: Evropský hospodářský prostor
Magyar	Fontos figyelmeztetés: Garancia-információk az EGT* területén és Svájcban élő vásárlók számára A jelen Yamaha termékre vonatkozó részletes garancia-információk, valamint az EGT*-re és Svájcra, kiterjedő garanciális szolgáltatás tekintetében keressék fel webhelyünket az alábbi címen (a webhelyen nyomtatható fájl is talál), vagy pedig lépjen kapcsolatba az országában működő Yamaha képviselői iróddal. * EGT: Európai Gazdasági Térség
Eesti keel	Oluline märkus: Garantiteave Euroopa Majanduspiirkonna (EMP) ja Šveitsi Klientidele Täpsemat teavet saameks selle Yamaha toote garantii ning kogu Euroopa Majanduspiirkonna ja Šveitsi garantiteeninduse kohta, külastage palun veebisaiti alljärgneval aadressil (meie saitil on saadaval printitav fail) või pöörduge Teie regiooni Yamaha esinduse poole. * EMP: Euroopa Majanduspiirkond
Latviešu	Svarīgs paziņojums: garantijas informācija klientiem EEZ* un Šveicē Lai saņemtu detaļizētā garantijas informāciju par šo Yamaha produktu, kā arī garantijas apkalpošanu EEZ* un Šveicē, lūdzam apmeklētiet zemāk norādīto tīmekļa vietnes adresi (tīmekļa vietnē ir pieejams drukājams fails) vai sazināties ar jūsu valstī apkalpojošo Yamaha pārstāvniecību. * EEZ: Eiropas Ekonomikas zona
Lietuvių kalba	Dėmesio: informacija dėl garantijos priekšams EEE* ir Šveicarijoje Jei reikia išsamios informacijos apie šį „Yamaha“ produktą ir jo techninę priežiūrą visoje EEE* ir Šveicarijoje, apsilankykite mūsų svetainėje toliau nurodytu adresu (svetainėje yra spausdinamas failas) arba kreipkitės į „Yamaha“ atšlyvę savo šalyje. *EEE — Europos ekonominė erdvė
Slovenčina	Dôležité upozornenie: Informácie o záruke pre zákazníkov v EHP* a Švajčiarsku Podrobné informácie o záruke týkajúcej sa tohto produktu od spoločnosti Yamaha a garancijného servisu v EHP* a Švajčiarsku nájdete na webovej stránke uvedenej nižšie (na našej webovej stránke je k dispozícii súbor na tlač) alebo sa obráťte na zástupcu spoločnosti Yamaha vo vašej krajine. * EHP: Európsky hospodársky priestor
Slovensščina	Pomembno obvestilo: Informacije o garanciji za kupce v EGP* in Švici Za podrobnejše informacije o tem Yamahinih izdelkih ter garancijskem servisu v celotnem EGP in Švici, obiščite spletno mesto, ki je navedeno spodaj (našeljva datoteka je na voljo na našem spletnem mestu), ali se obrnite na Yamahinega predstavništva v svoji državi. * EGP: Evropski gospodarski prostor
Български език	Важно съобщение: Информация за гаранцията за клиентите в ЕИП* и Швейцария За подробна информация за гаранцията за този продукт на Yamaha и гаранционното обслужване в паневропейската зона на ЕИП* и Швейцария или посетете посочения по-долу уеб сайт (на нашия уеб сайт има файл за печат), или се свържете с представителния офис на Yamaha във вашата страна. * ЕИП: Европейско икономическо пространство
Limba română	Notificare importantă: Informații despre garanție pentru clienții din SEE* și Elveția Pentru informații detaliate privind acest produs Yamaha și serviciul de garanție Pan-SEE* și Elveția, vizitați site-ul la adresa de mai jos (fișierul imprimabil este disponibil pe site-ul nostru) sau contactați biroul reprezentanței Yamaha din țara dumneavoastră. * SEE: Spațiul Economic European

<http://europe.yamaha.com/warranty/>

For details of products, please contact your nearest Yamaha representative or the authorized distributor listed below.

NORTH AMERICA

CANADA

Yamaha Canada Music Ltd.
135 Milner Avenue, Toronto, Ontario M1S 3R1,
Canada
Tel: +1-416-298-1311

U.S.A.

Yamaha Corporation of America
6600 Orangethorpe Avenue, Buena Park, CA 90620,
U.S.A.
Tel: +1-714-522-9011

CENTRAL & SOUTH AMERICA

MEXICO

Yamaha de México, S.A. de C.V.
Av. Insurgentes Sur 1647 Piso 9, Col. San José
Insurgentes, Delegación Benito Juárez, México,
D.F., C.P. 03900, México
Tel: +52-55-5804-0600

BRAZIL

Yamaha Musical do Brasil Ltda.
Rua Fidéncio Ramos, 302 – Cj 52 e 54 – Torre B –
Vila Olímpia – CEP 04551-010 – São Paulo/SP,
Brazil
Tel: +55-11-3704-1377

ARGENTINA

**Yamaha Music Latin America, S.A.,
Sucursal Argentina**
Olga Cossetini 1553, Piso 4 Norte,
Madero Este-C1107CEK,
Buenos Aires, Argentina
Tel: +54-11-4119-7000

PANAMA AND OTHER LATIN AMERICAN COUNTRIES/ CARIBBEAN COUNTRIES

Yamaha Music Latin America, S.A.
Edif. Torre Banco General, F7, Urb. Marbella,
Calle 47 y Aquilino de la Guardia, Panama,
P.O.Box 0823-05863, Panama, Rep. de Panama
Tel: +507-269-5311

EUROPE

THE UNITED KINGDOM/IRELAND

Yamaha Music Europe GmbH (UK)
Sherbourne Drive, Tilbrook, Milton Keynes,
MK7 8BL, U.K.
Tel: +44-1908-366700

GERMANY

Yamaha Music Europe GmbH
Siemensstrasse 22-34, 25462 Rellingen, Germany
Tel: +49-4101-303-0

SWITZERLAND/LIECHTENSTEIN

**Yamaha Music Europe GmbH, Branch
Switzerland in Thalwil**
Seestrasse 18a, 8800 Thalwil, Switzerland
Tel: +41-44-3878080

AUSTRIA/CZECH REPUBLIC/ HUNGARY/ROMANIA/SLOVAKIA/ SLOVENIA

Yamaha Music Europe GmbH, Branch Austria
Schleiergasse 20, 1100 Wien, Austria
Tel: +43-1-60203900

POLAND

Yamaha Music Europe GmbH
Sp.z o.o. Oddzial w Polsce
ul. Wielicka 52, 02-657 Warszawa, Poland
Tel: +48-22-880-08-88

BULGARIA

Dinacord Bulgaria LTD.
Bul. Iskarsko Schose 7 Targowski Zentar Ewropa
1528 Sofia, Bulgaria
Tel: +359-2-978-20-25

MALTA

Olimpus Music Ltd.
Valletta Road, Mosta MST9010, Malta
Tel: +356-2133-2093

NETHERLANDS/BELGIUM/ LUXEMBOURG

Yamaha Music Europe, Branch Benelux
Clarissenhof 5b, 4133 AB Vianen, The Netherlands
Tel: +31-347-358040

FRANCE

Yamaha Music Europe
7 rue Ambroise Croizat, Zone d'activités de Pariest,
77183 Croissy-Beaubourg, France
Tel: +33-1-6461-4000

ITALY

Yamaha Music Europe GmbH, Branch Italy
Via Tinelli N.67/69 20855 Gerno di Lesmo (MB),
Italy
Tel: +39-039-9065-1

SPAIN/PORTUGAL

**Yamaha Music Europe GmbH Ibérica, Sucursal
en España**
Ctra. de la Coruna km. 17,200, 28231
Las Rozas de Madrid, Spain
Tel: +34-91-639-88-88

GREECE

Philippos Nakas S.A. The Music House
19th klm. Leof. Lavriou 190 02 Peania – Attiki,
Greece
Tel: +30-210-6686260

SWEDEN

**Yamaha Music Europe GmbH Germany filial
Scandinavia**
JA Wettergrensgata 1, 400 43 Göteborg, Sweden
Tel: +46-31-89-34-00

DENMARK

**Yamaha Music Denmark,
Filial of Yamaha Music Europe GmbH, Tyskland**
Generatorvej 8C, ST. TH., 2860 Søborg, Denmark
Tel: +45-44-92-49-00

FINLAND

F-Musiikki Oy
Antaksentie 4
FI-01510 Vantaa, Finland
Tel: +358 (0)96185111

NORWAY

**Yamaha Music Europe GmbH Germany -
Norwegian Branch**
Grini Næringspark 1, 1332 Østerås, Norway
Tel: +47-6716-7800

ICELAND

Hjodfaerahusid Ehf.
Sidumula 20
IS-108 Reykjavik, Iceland
Tel: +354-525-5050

CROATIA

Euro Unit D.O.O.
Slakovce 73
40305 Nedelisce
Tel: +38540829400

RUSSIA

Yamaha Music (Russia) LLC.
Room 37, entrance 7, bld. 7, Kievskaya street,
Moscow, 121059, Russia
Tel: +7-495-626-5005

OTHER EUROPEAN COUNTRIES

Yamaha Music Europe GmbH
Siemensstrasse 22-34, 25462 Rellingen, Germany
Tel: +49-4101-303-0

AFRICA

Yamaha Music Gulf FZE
JAFZA-16, Office 512, P.O.Box 17328,
Jebel Ali FZE, Dubai, UAE
Tel: +971-4-801-1500

MIDDLE EAST

TURKEY

**Yamaha Music Europe GmbH
Merkezi Almany Türkiye Istanbul Şubesi**
Maslak Meydanı Sokak, Spring Giz Plaza Bagimsiz
Böl. No:3, Şariyer Istanbul, Turkey
Tel: +90-212-999-8010

CYPRUS

Nakas Music Cyprus Ltd.
Nikis Ave 2k
1086 Nicosia
Tel: +357-22-511080
Major Music Center
21 Ali Rizza Ave. Ortakoy
P.O.Box 475 Nicosia, Cyprus
Tel: (392) 227 9213

OTHER COUNTRIES

Yamaha Music Gulf FZE
JAFZA-16, Office 512, P.O.Box 17328,
Jebel Ali FZE, Dubai, UAE
Tel: +971-4-801-1500

ASIA

THE PEOPLE'S REPUBLIC OF CHINA

Yamaha Music & Electronics (China) Co., Ltd.
2F, Yunhedasha, 1818 Xinzha-lu, Jingan-qu,
Shanghai, China
Tel: +86-400-051-7700

HONG KONG

Tom Lee Music Co., Ltd.
11/F., Silvercord Tower 1, 30 Canton Road,
Tsimshatsui, Kowloon, Hong Kong
Tel: +282-2737-7688

INDIA

Yamaha Music India Private Limited
P-401, JMD Megapolis, Sector-48, Sohna Road,
Gurgaon-122018, Haryana, India
Tel: +91-124-485-3300

INDONESIA

PT. Yamaha Musik Indonesia (Distributor)
Yamaha Music Center Bldg. Jalan Jend. Gatot
Subroto Kav. 4, Jakarta 12930, Indonesia
Tel: +62-21-520-2577

KOREA

Yamaha Music Korea Ltd.
8F, Dongsung Bldg. 21, Teheran-ro 87-gil,
Gangnam-gu, Seoul, 06169, Korea
Tel: +82-2-3467-3300

MALAYSIA

Yamaha Music (Malaysia) Sdn. Bhd.
No.8, Jalan Perbandaran, Kelana Jaya, 47301
Petaling Jaya, Selangor, Malaysia
Tel: +60-3-7803900

SINGAPORE

Yamaha Music (Asia) Private Limited
Block 202 Hougang Street 21, #02-00,
Singapore 530202, Singapore
Tel: +65-6740-9200

TAIWAN

Yamaha Music & Electronics Taiwan Co., Ltd.
2F., No.1, Yuanfong Rd., Banqiao Dist.,
New Taipei City 22063, Taiwan (R.O.C.)
Tel: +886-2-7741-8888

THAILAND

Siam Music Yamaha Co., Ltd.
3, 4, 15, 16th Fl., Siam Motors Building,
891/1 Rama 1 Road, Wangmai,
Pathumwan, Bangkok 10330, Thailand
Tel: +66-2215-2622

VIETNAM

Yamaha Music Vietnam Company Limited
15th Floor, Nam A Bank Tower, 201-203 Cach
Mang Thang Tam St., Ward 4, Dist.3,
Ho Chi Minh City, Vietnam
Tel: +84-8-3818-1122

OTHER ASIAN COUNTRIES

<http://asia.yamaha.com>

OCEANIA

AUSTRALIA

Yamaha Music Australia Pty. Ltd.
Level 1, 99 Queensbridge Street, Southbank,
VIC 3006, Australia
Tel: +61-3-9693-5111

NEW ZEALAND

Music Works LTD
P.O.BOX 6246 Wellesley, Auckland 4680,
New Zealand
Tel: +64-9-634-0099

COUNTRIES AND TRUST TERRITORIES IN PACIFIC OCEAN

<http://asia.yamaha.com>

Yamaha Global Site
<https://www.yamaha.com/>

Yamaha Downloads
<http://download.yamaha.com/>

Manual Development Group
© 2017 Yamaha Corporation

Published 1/2017 POZC*-*-A0
Printed in Indonesia

ZW55120