

asp
880



USER MANUAL v1.3

connect with us.



facebook.com/audient
twitter.com/audientworld
youtube.com/audienthampshire

www.audient.com

Thank you for purchasing this *audient* product!

ASP880 can be seen as the natural progression of our classic ASP008 eight channel microphone preamplifier.

Using the same proven discrete class-a 8-transistor input stage with extended bandwidth and a noise floor close to the theoretical Johnson noise limit, ASP880 provides a world-class recording front end in a convenient 1RU package.

The microphone preamplifier has been refined over 15 years by design legend [David Dearden](#) and is the same tried & tested topology as featured in our consoles and recording interfaces (iD22, ASP8024, ASP4816).

However we did not stop there with ASP880 - after months of refinement and an entirely new PSU design, we have been able to lower the noise floor in the unit and have reduced the 50Hz mains component to vanishingly low levels and the unit is completely silent (fanless operation) - impressive!

On top of this we have used the cutting edge top-of-the-line Burr-Brown converters from our iD22 interface to heavily upgrade the digital card which now comes as standard!

The unit is built like a tank and now features our custom, solid aluminium control knobs which feel great and provide excellent visual feedback. ASP880 will last for years to come!

Features include:

- 8 x superb class-a mic preamplifiers & 2 x discrete JFET instrument inputs
- Clean & stable P48 phantom power
- 60dB of clean gain with -10dB pads on channels 1 & 2 for kick, snare etc
- Polarity reverse to enable phase coherent recording across all tracks
- Variable input impedance providing a "triangle-of-tone". Lo, med and hi settings allow you to voice your mic collection at the flip of a switch!
- Super smooth 12dB/octave sweepable high pass filter (25 to 250Hz) to clean up low end rumble and mess!
- New A-D insert switch provides line level direct access to converters for integrating outboard processing between the mic pres and ADC
- Integrated Burr-Brown 115dB ADC with AES and SMUX ADAT outputs
- Integrated fanless, low noise PSU with global operation

Box Contents	1
ASP880 Overview	3
Safety Information	5
Declaration of Conformities	7
Hardware Features:	9
Microphone & Line Inputs	9
Instrument Inputs	10
Gain & Setting Levels	11
Input Signal Conditioning	12
Sweepable High Pass Filter	12
Variable Input Impedance	13
Analogue Line Outputs	15
Direct ADC Access & Inserts	15
AES Output	16
ADAT SMUX Output	16
Clocking - Setup and Wiring	17
ASP880 Block Diagram	19
Troubleshooting	20
FAQ	21
Specifications	22
Dimensions	23
Warranty & Contact	24
Service	25
Glossary	26



In your ASP880 packaging you should find the following items:

- ASP880
- Mains IEC Cable (in rear protection tube)
- Quick Start Guide

Please visit:

www.audient.com/products/asp880/downloads to get the latest version of the quick start guide and this manual. Watch/listen to our example video content and grab useful things like a session recall sheet etc.

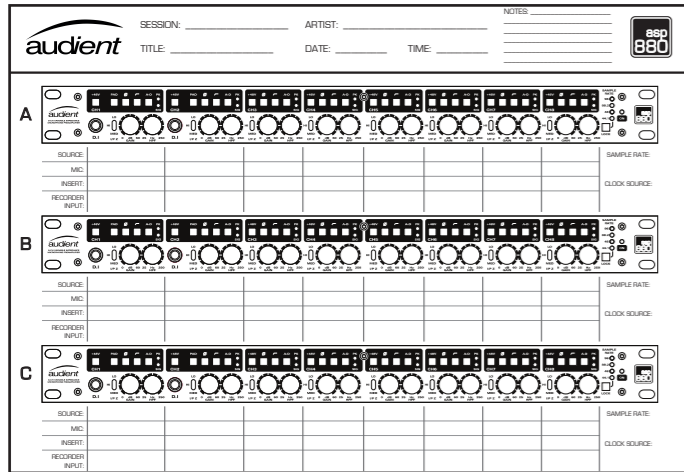

The integrated power supply in ASP880 will accept line voltages from 90 - 264V and can operate anywhere in the world without re-configuration - just use the appropriate mains IEC cable.

We hope that you enjoy using ASP880 wherever you are and may it aid you in making great sounding music!

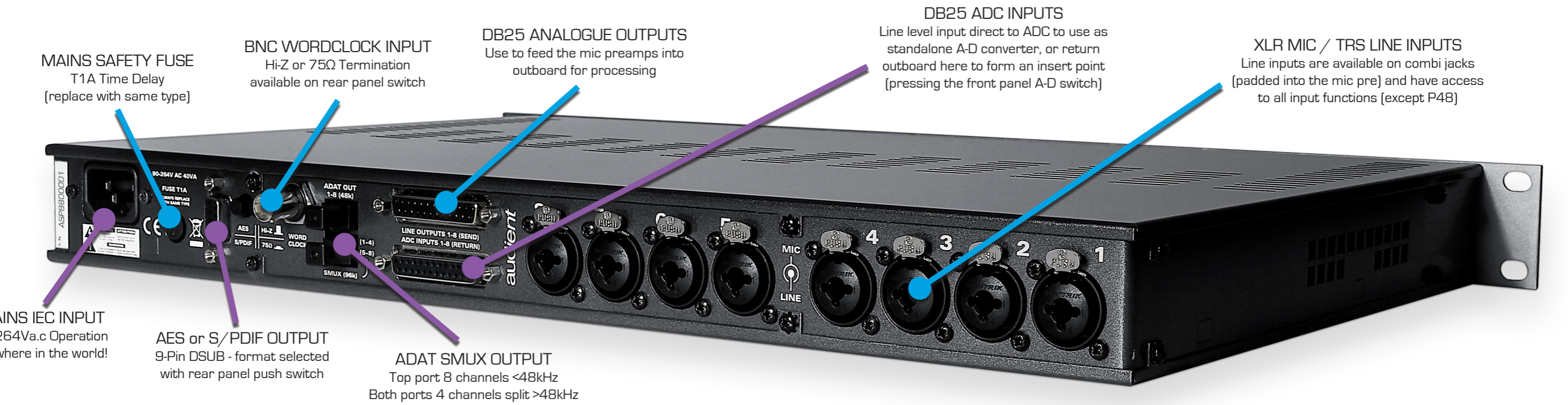
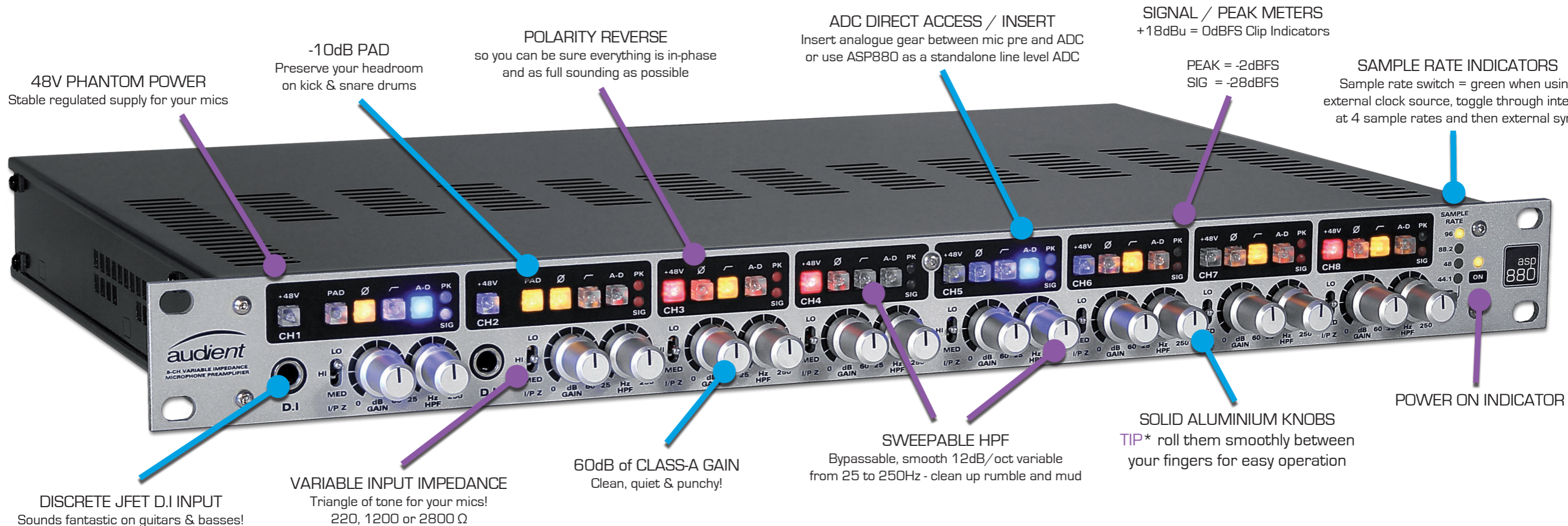

Important Safety Instructions

Please read all of these instructions and save them for later reference before connecting the mains IEC power cable and powering up ASP880. To prevent electrical shock and fire hazard follow all instructions on the rear of the ASP880.



ASP880 does not contain any user serviceable parts inside the internal power supply and in the event of a power supply failure, please contact *audient* support so that we can arrange suitable service.

www.audient.com/support

A 1RU ventilation space above the unit is recommended and it is not advised to run the unit in a rack above hot units such as valve outboard and multichannel AD/DA converters without suitable ventilation space around the unit.

The internal switch-mode power supply design will accept any A.C line voltage from 90v to 264v @ 47-63Hz. Therefore the unit will work happily anywhere in the world but please ensure your A.C mains line voltage is within this specification and you use an appropriate cable for the region. Consult a qualified technician if you suspect difficulties. Do not attempt to tamper with the power supply or mains voltages - **HAZARDOUS TO HEALTH.**

! WARNING !

TO REDUCE RISK OF FIRE OR ELECTRIC SHOCK, DO NOT EXPOSE THIS APPARATUS TO RAIN OR MOISTURE.

NO USER SERVICEABLE PARTS INSIDE.
PLEASE REFER SERVICING TO QUALIFIED SERVICE PERSONNEL.

Important Safety Instructions

1. Read these instructions
2. Keep these instructions
3. Heed all warnings
4. Follow all instructions
5. Do not use this equipment near water
6. Clean only with dry cloth
7. Do not block any ventilation openings. Install in accordance with the manufacturer's instructions
8. Do not install near any heat sources such as radiators, heat registers, stoves, or other equipment (including amplifiers) that produce heat
9. Do not defeat the safety purpose of the polarized or grounding-type plug. A polarized plug has two blades with one wider than the other. A grounding type plug has two blades and a third grounding prong. The wide blade or the third prong are provided for your safety. If the provided plug does not fit into your outlet, consult an electrician for replacement of the obsolete outlet
10. Protect power cords from being walked on or pinched particularly at plugs, convenience receptacles, and the point where they exit from the equipment
11. Only use attachments/accessories specified by the manufacturer
12. For products that are not rack-mountable: Use only with a cart, stand, tripod, bracket, or table specified by the manufacturer, or sold with the equipment. When a cart is used, use caution when moving the cart/equipment combination to avoid injury from tip-over
13. Unplug this equipment during lightning storms or when unused for long periods of time
14. Refer all servicing to qualified service personnel. Servicing is required when the equipment has been damaged in any way, such as power-supply cord or plug is damaged, liquid has been spilled or objects have fallen into the equipment, the equipment has been exposed to rain or moisture, does not operate normally, or has been dropped
15. For products that are a mains powered device: The equipment shall not be exposed to dripping or splashing and no objects filled with liquids (such as vases) shall be placed on the equipment



We, Audient Ltd, declare that the product, the ASP880, to which this declaration relates, is in material conformity with the appropriate CE standards and directives for an audio product designed for consumer use.



Audient Ltd has conformed where applicable, to the European Union's Directive 2002/95/EC on Restrictions of Hazardous Substances (RoHS) as well as the following sections of California law which refer to RoHS, namely sections 25214.10, 25214.10.2, and 58012, Health and Safety Code; Section 42475.2, Public Resources

FEATURES
in depth

Microphone Preamplifiers & Line Inputs

ASP880 features eight impeccably optimised class-a microphone preamplifiers.

Featuring a discrete 8-transistor front end, the mic pre is optimised for 0 to 60dB gain with an EIN (equivalent input noise) of -127.5 dB. The frontend has high-input headroom and will be happy to accept any level from your microphone collection, however for situations where you reach very hot signal levels such as drum recording, a switchable -10dB pad is included on channels 1 & 2 to provide a -10 to +50dB padded gain range.

Microphone inputs are provided on the rear panel using Combi XLR connectors - here the 1/4" Combi Jack connector provides a padded balanced line input (input impedance >6kΩ) directly into the mic pre stage.

These Combi Jack line inputs run through the mic preamp, providing a slightly sweeter tone (due to the 2nd and 3rd harmonic distortion in the mic pre) and have access to all input conditioning functions apart from phantom power.

Please be aware that the input impedance switch functions as a variable pad for any line input signal (a secondary benefit!).

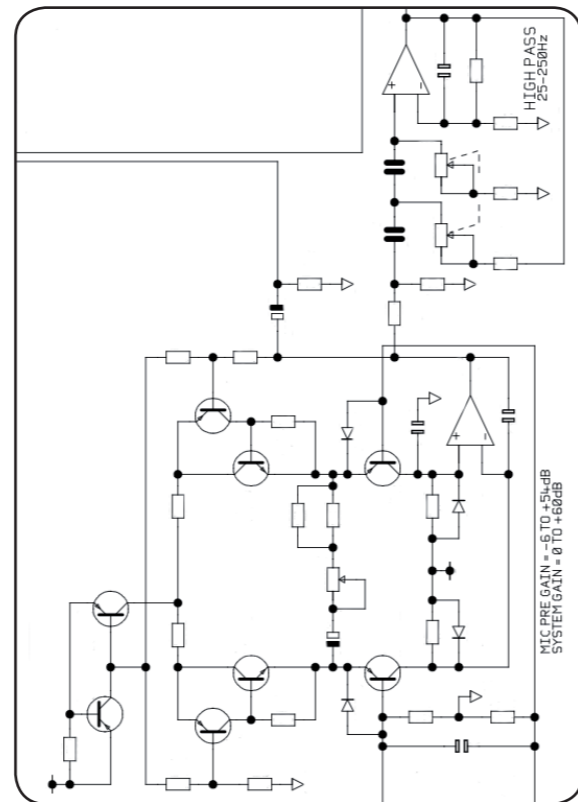

Discrete JFET D.I (Instrument) Inputs

ASP880 features two discrete class-a JFET D.I inputs (Channels 1 & 2). Plugging into these jacks will automatically select the D.I signal over the signals present at the rear.

Why JFET?

Junction Field Effect Transistors are known for their sweet tone and tube-like properties when overdriven. You will often find JFETs used in guitar pedals and such for this very reason. They sound good and “can” provide just a touch of sweetness and larger than life tone. JFETs also have a very high input impedance (often approx. $10^{12} \Omega$) and this makes them ideal for buffer circuits that do not load down the source device.

In the case of electric guitars or basses with vintage style passive pickups, the output impedance of the instrument can often be 6,000 to 40,000Ω, depending upon volume and tone pot positions. Typically we should provide a load that is 10 times the source to create a true bridging system. Therefore we need at least a 400kΩ load to get the most signal and tone from our instruments. It should then come as no surprise that most classic valve guitar amplifiers have a very high input impedance - 1MegΩ!



CAPTURE GREAT TONE JUST BY PLUGGING IN DIRECT!



We designed the JFET input on ASP880 to have a 1MegΩ input impedance and thus match the loading effect found on classic guitar amplifiers.

This ensures you get the most tone from your instrument and when pushed the JFET circuit will provide plenty of 2nd and 3rd harmonic distortion (minimum 0.03% to lots!) ensuring that your instrument has a rich sound and some colour!

Setting Levels & Gain

ASP880 has plenty of analogue headroom, running internally on +/-18V DC rails.

The unit can deliver up to +27.5dBu at the analogue output DB25 on the rear of the unit.

However it would be typical in modern digital recording situations that ASP880 is using our own internal pristine 115dB ADC converters to produce a digital output for recording via AES or ADAT digital output.

In this case, the ASP880 has a digital line-up reference of +18dBu = 0dBFS (full scale), therefore the analogue circuitry will have anywhere from 4 to 9.5dB headroom above digital maximum (don't worry about it!).

As a target guide, we would recommend that you turn up the ASP880 gain pots to produce a -10dBFS peak signal level in your DAW when recording. This will maintain plenty of headroom and things often sound better in the DAW if you record with lots of headroom.

To do this, adjust the gain knob on ASP880 whilst observing the metering in your interface or DAW application.

Aim for -10dBFS peaks on the loudest sections when setting gain & recording levels in the DAW!



The LED metering on the ASP880 will show signal present at -48dBFS (-30dBu), slowly ramping to -28dBFS (-10dBu) with a peak LED warning of potential overloads at -2dBFS (+16dBu). However please rely upon the recording destination for accurate metering.

Input Conditioning

In order to correctly condition input signals, ASP880 provides the following functions:

- +48V Phantom Power
- -10dB Pad (channels 1 & 2)
- Polarity Reverse
- Sweepable High Pass Filter

P48 Phantom Power

Phantom power can be supplied on a per channel basis by pressing the +48V switch (1). This is supplied at 48V +/-4v @ 10mA per channel and is fully compliant with the DIN45596 specification. This is suitable for any phantom powered condenser mics, or ribbons with on-board active head amps etc.

-10dB Pad

The 10dB pad (2) can be used in conjunction with the gain control to adjust any hot signals on channels 1 & 2. Please note that the actual attenuation value of this pad will vary with micpre input impedance (lo, med or hi) and therefore using your ears and eyes is the best policy here!

Ø Polarity Reverse

Polarity reverse (180 degrees) can be applied to any channel to ensure that multi-mic setups sound as full as possible. **ALWAYS REMEMBER TO CHECK PHASE.**



To check phase coherency on multi-mic setups, first always use careful microphone placement and then press the Ø switch (3) on various combinations of channels to find the fullest, most solid low frequency representation of the source.

On drum kit recordings typically you may find either the kick drum out of phase with the overheads, or the underneath snare mic out of phase with the top snare mic etc. Sometimes, one overhead is out of phase with the kick drum, so move mics first and then use the polarity reverse switch to find the best compromise.

Sweepable High Pass Filter

The sweepable HPF is 2nd order 12dB per octave and can be used to increase headroom and clean up low frequency rumble etc. Engage this by pressing the  switch (4) and adjusting the frequency control (5).

Variable Input Impedance

One stand-out feature of the ASP880 is the **variable input impedance** [Z] control.

There are three impedance load settings on the unit, and these can be used to extract various voicings from your mic collection by loading the mic's output stage differently.

Notably mics with transformer outputs such as SM57 / SM7 dynamic mics or Coles 4038 ribbon microphones often provide quite noticeable changes in tone when operated into various loads.

The three settings on ASP880 are:

- LO 220 Ω
- MED 1200 Ω
- HI 2800 Ω

Take the dynamic output impedance of an SM57 for example (illustration only):

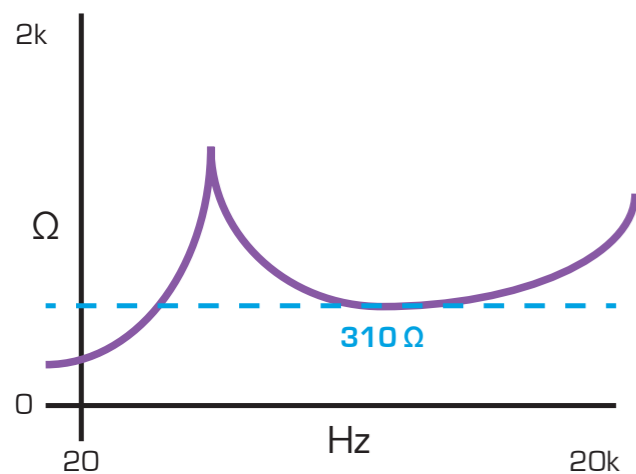

The source (microphone) and load (mic pre-amplifier) form a bridging voltage divider, that contain different values of resistance for the source at different frequencies - thus creating a varying frequency response (or different output levels for each part of the SM57 impedance curve) and thus a change in tone can be perceived.

MIC - SOURCE
310 Ω @ 1kHz
Varying at all frequencies

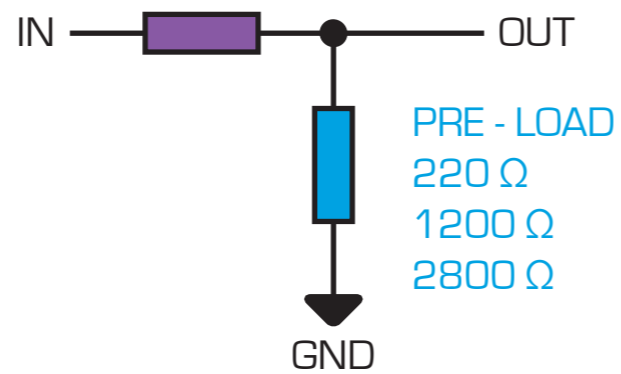

Typically there is some change in level, timbre, punch and tone when changing Z. Ribbon mics are known for liking HI-Z inputs.

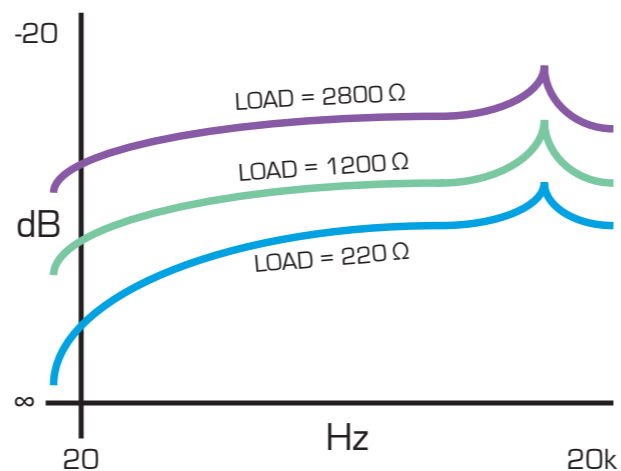

Variable Input Impedance - Listening

When listening, this diagram may come in helpful if trying to train your ear to hear the differences.

Listen for the following:

1. Change in Level
2. Change in Speed (Transient Response)
3. Change in Tone (Frequency Response)
4. Change in Detail

Please be aware that some microphone types (transformerless condenser types) may not produce audible changes due to their electronically buffered output stages which have linear output impedances with regards to frequency and therefore are less susceptible to changes in loading.

If in doubt, consult your microphone datasheet & manufacturer.

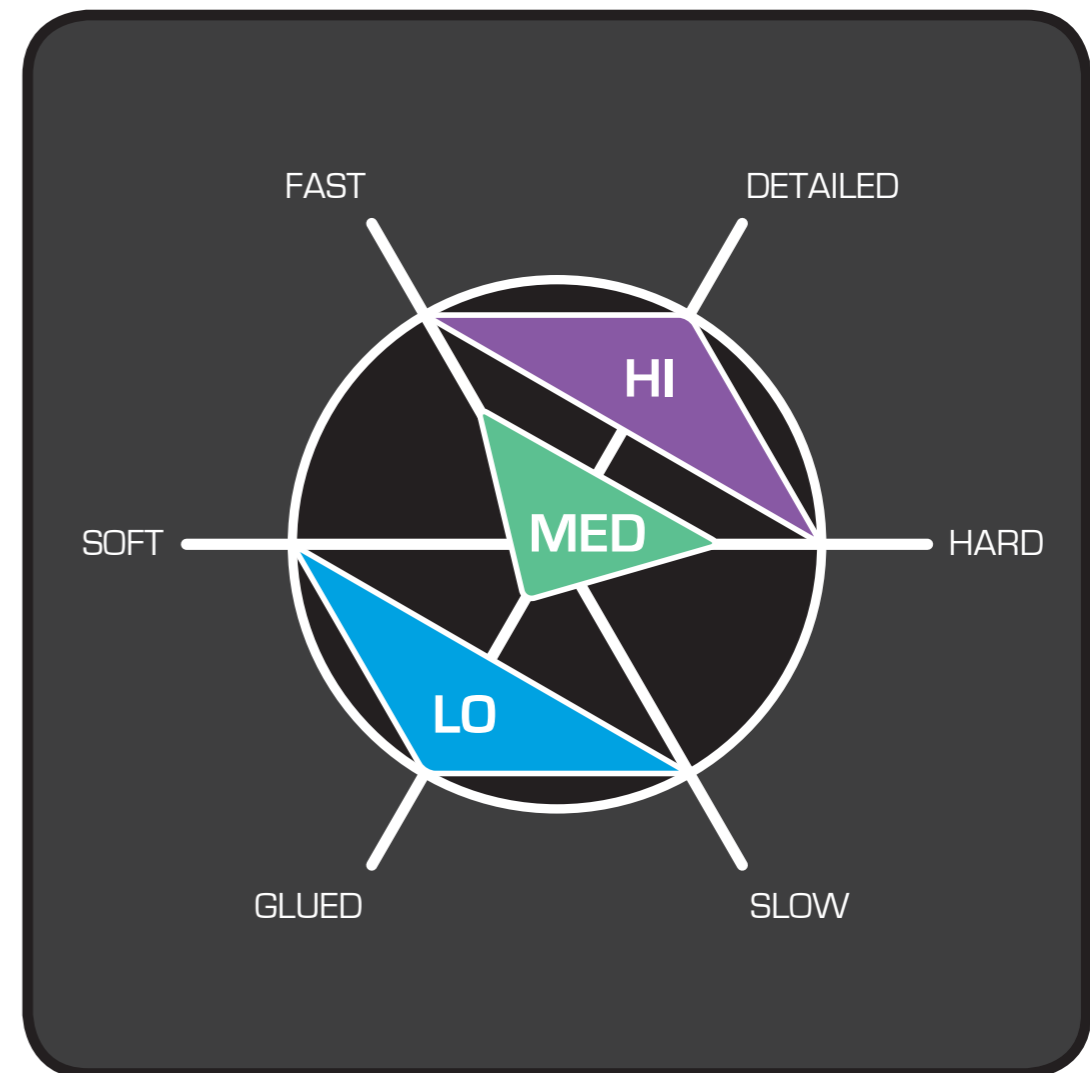

Analogue Line Outputs

ASP880 features 8 analogue, cross-coupled line driver outputs on DB25. These fully balanced outputs use the same circuitry as our proven ASP8024 flagship console and provide “transformer-like” differential line drive and high headroom with a sturdy, transparent pair of operational amplifiers.

Use these outputs to use ASP880 as a standalone eight channel analogue mic pre.

These outputs are wired as Tascam DB25 standard with 100Ω output impedance and +27.5dBu maximum level.

AD Converter Direct Access / Inserts

ADC balanced line inputs are available on a rear panel DB25 connector (also Tascam format). You can use these to directly access the AD converter with +18dBu input headroom (0dBFS = +18dBu) for line level signals, allowing you to feed the ADC from other sources such as alternative mic pres etc. However this also provides a path in which you can insert processing outboard such as EQ & compression between the mic pres and ADC - useful!!

To activate the direct AD access press the front panel A-D switch on each channel.

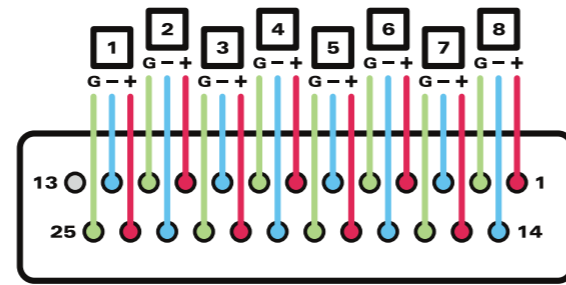

Analogue DB25 Pinout

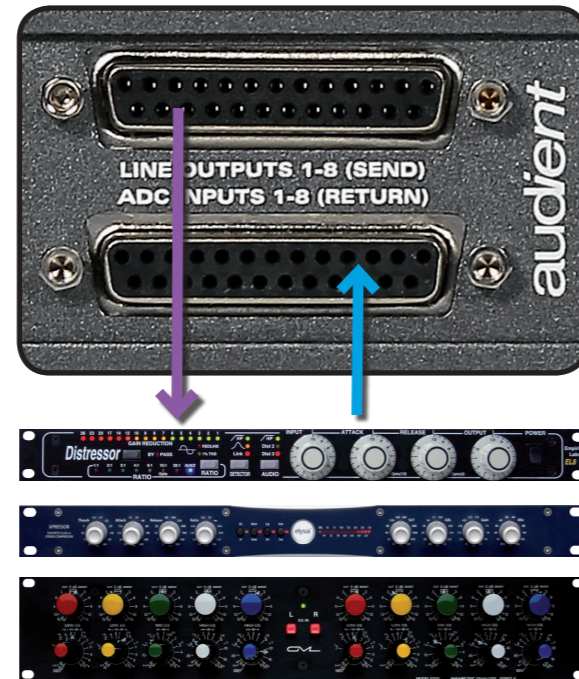

Digital Outputs - AES - S/PDIF

The on-board digital card in ASP880 can provide both double speed [96kHz] AES and ADAT output signals.

The AES output is available on a 9-pin DSUB connector and is fully transformer balanced according to the AES specification. The 9-pin DB9 connector provides eight channels of balanced AES digital output and the wiring pinout is as shown to the right.

Pressing the AES - S/PDIF switch (1) will switch the DB9 output stage into consumer format (lower signal amplitude etc) for S/PDIF operation. In most cases, you will likely be using the AES professional output so this switch can remain in the out position until required.

Digital Outputs - ADAT SMUX

The digital card also provides simultaneous ADAT optical output on the rear of the unit with full SMUX double speed capability.

For <48kHz operation, a single optical cable should be connected from the top (1-4) ADAT port. This will provide 8-channels @ 48kHz. For >48kHz operation, two optical cables should be used, with four channels carried on each for full 8ch 98kHz operation.

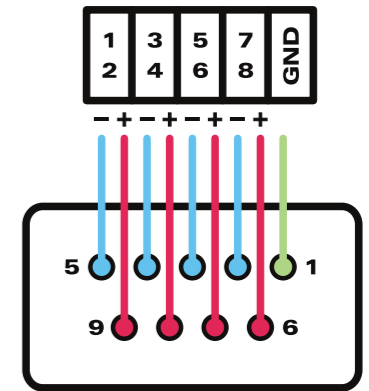

Digital DB9 Pinout

ASP880 & iD22 - Perfect Harmony

Combining ASP880 with our iD22 USB recording interface via ADAT - you get 10 audient mic preamps, 10 top-of-the-range Burr-Brown AD converters and 6 pristine DAC outputs for monitoring! Nice!



Clocking with the ASP880

There are two ways to integrate ASP880 into your system digitally:

- As a **MASTER** clock source - internal clock
- As a **SLAVE** device - external clock

Master Clock Operation - INTERNAL

Assuming that you are connecting the ASP880 digital output to a DAW/recording interface with either AES or ADAT inputs, the ASP880 can be set as **MASTER** clock source as follows:

Select the appropriate sample rate on the front of ASP880 by pressing the **SAMPLE RATE** switch (1).

Ensure that your DAW/recorder session is set to the same sample rate and that clock source is set to external digital input (either AES or ADAT).

Your DAW/recorder should automatically follow the sample rate set on the front of the ASP880. Note that both the AES and ADAT output simultaneously so you can feed a backup recorder at the same time on location gigs!

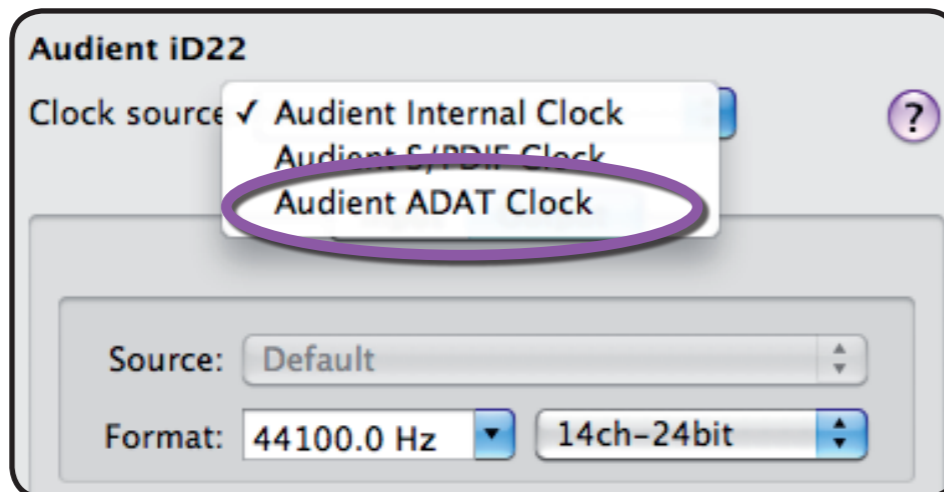
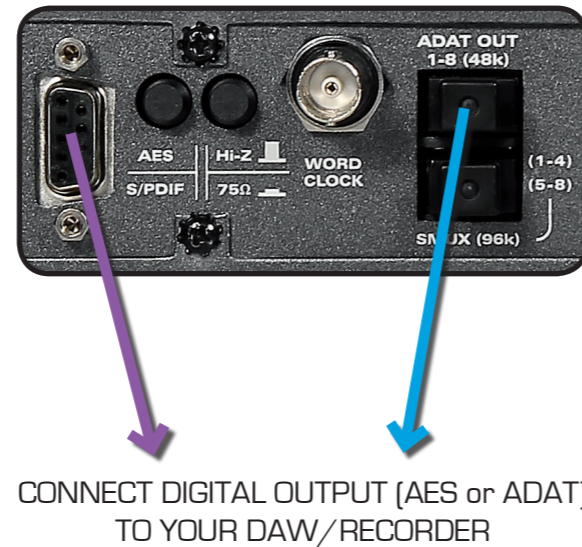

Slave Clock Operation - EXTERNAL

You may have a studio master clock source such that all digital devices synchronise to your session sample rate, or perhaps you would like the ASP880 to follow your DAW/recorder session sample rate so that you do not have to reconfigure the unit when you flip between sessions at different sample rates.

In order to do this, you must set the ASP880 digital card to **SLAVE** to an external clock source.

Press the **SAMPLE RATE** switch (1) until it is flashing green (external clock mode).

Ensure that your master clock source is connected via a 75Ω coaxial BNC cable to the Word Clock input on ASP880 (3) - with a valid clock signal present here, the green LED in the **SAMPLE RATE** switch should become solidly lit, indicating external lock.

If ASP880 is the only or last device in the clock chain fed from the master clock, go ahead and press the 75Ω termination switch (2) to ensure that the clock line is loaded properly to stop any transmission line effects.

If using a BNC T-Bar to distribute clock signals to various devices - please ensure the last device in the chain is terminated (75Ω).

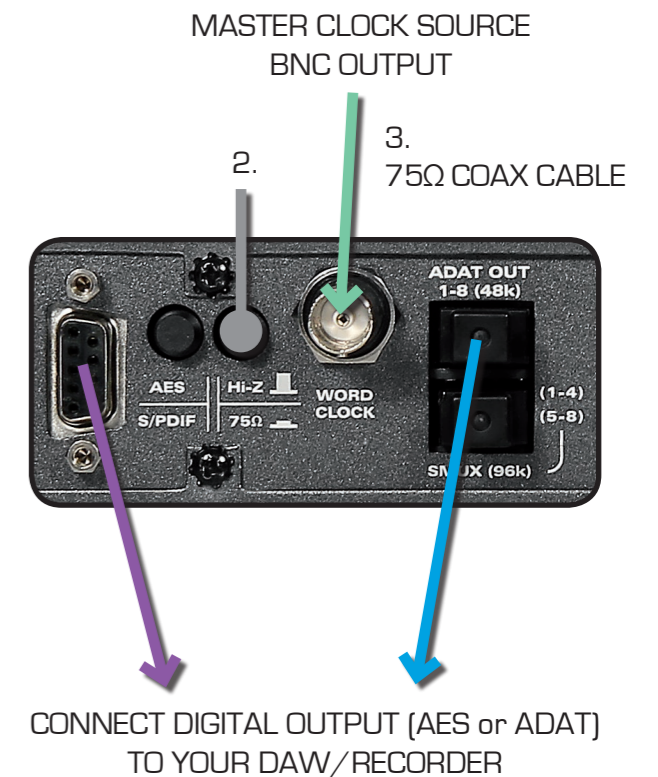

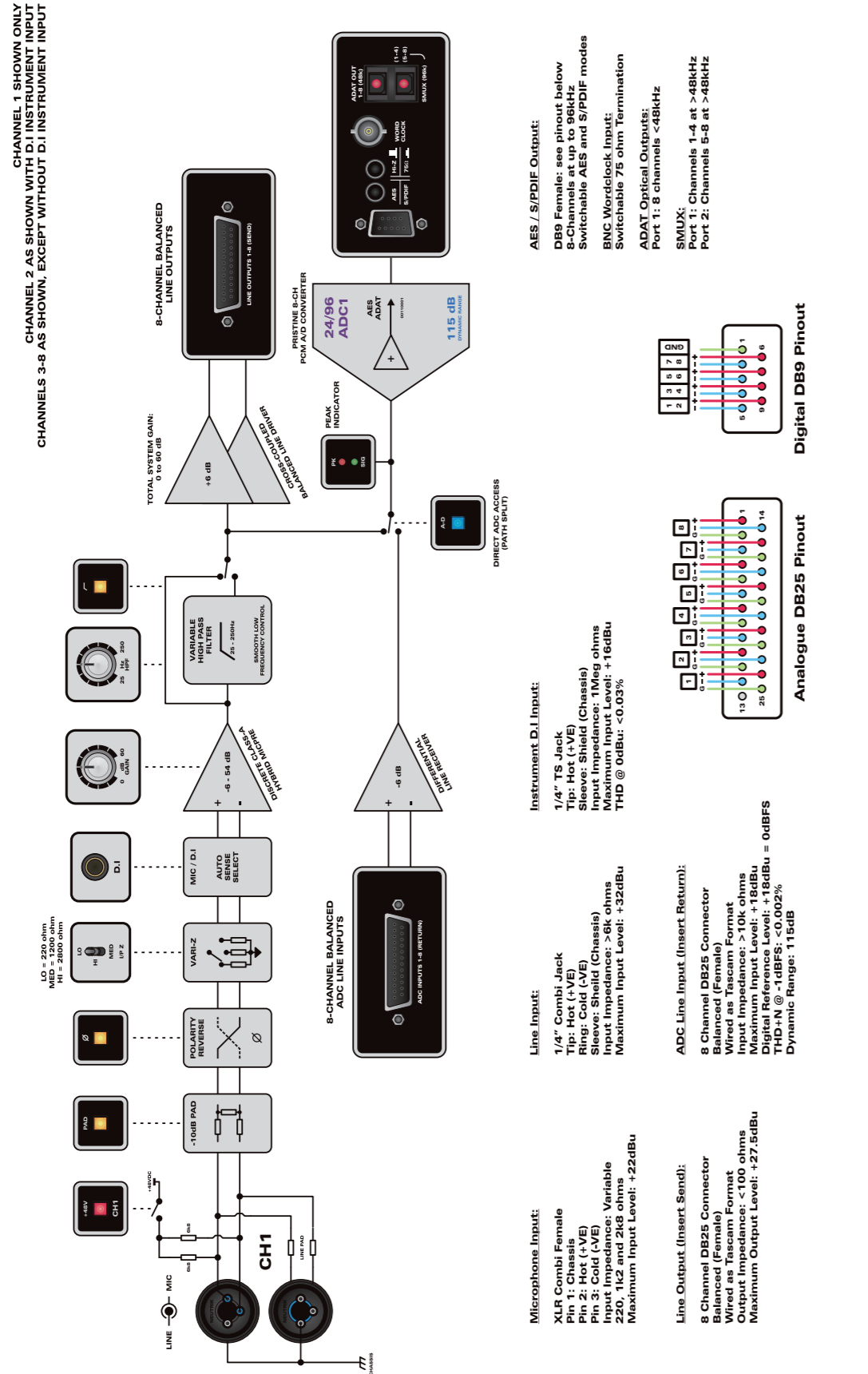

ASP880 BLOCK DIAGRAM

Troubleshooting

- My microphones are not producing signal?

Double check that phantom power is turned on via the front panel switch, try swapping XLR cables, then double check all connections to the recorder.

- I cannot clock the ASP880 from an external clock source, or you are experiencing clicks & pops?

Double check that you have set the clock source to external by using the front panel **SAMPLE RATE** switch, press it until it is flashing green. This selects external clock mode.

From here, double check your master clock source, and ensure it is connected via a 75Ω BNC coaxial cable to the ASP880 BNC wordclock input.

Providing that you have a valid clock source, ASP880 should sync to it without issue and the **SAMPLE RATE** led in the switch will turn to solid illumination. This shows that the unit is locked. If you experience pops & clicks - double check any master/slave device configurations and cabling. A system should only have one master clock.

FAQs

For more information and service information / support, please search our online [Knowledge Base](#) which can be found here:

www.audient.com/support

Knowledge Base

For technical support please create a ticket in our online support system, Zendesk which can also be found in the support section of our website (see link above).

audient Audient Help Desk

[home](#) [knowledge base](#) [submit a request](#) [check your existing requests](#)

Submit a request

Your email address *

Product *

Serial Number

To help us quickly identify your unit please enter the serial number. It can be found on the back of most units, or the side of ASP008.

Subject *

Description *

Please enter the details of your request. A member of our support staff will respond as soon as possible.

Please consult the warranty statement on page 23 for further information regarding service requirements and our policies.



MICROPHONE PREAMPLIFIERS:
(measured to insert send)

MIC GAIN:	-10 to +60dB [-10dB Pad]
LINE GAIN:	-16 to +44dB [-10dB Pad]*
PHANTOM POWER:	48v +/-4v @ 10mA/ Channel
MIC EIN:	<-127.5dBu
CMRR:	>80dB @ 100 to 10kHz
MAXIMUM INPUT LEVEL:	+22dBu [+32dBu with Pad]
INPUT IMPEDANCE	
Mic LO:	220Ω Balanced
Mic MED:	1kΩ Balanced
Mic HI:	2k8Ω Balanced
Line (All i/p Z):	>6kΩ Balanced
FREQUENCY RESPONSE:	+/-0.5dB 10Hz to 100kHz
CROSSTALK:	<85dBu @ 1kHz & 10kHz
THD+N @ 0dBu (1kHz):	0.003% [-90.5dBu]
SNR:	>90dB
HPF:	Sweepable from 25Hz to 250 Hz 2nd Order [12dB/Octave]

XLR: Pin 2 (Hot), Pin 3 (Cold) & Pin 1 (Shield)
1/4" JACK: TIP (Hot), RING (Cold) & SLEEVE (Shield)

*Line input level at the combi jacks will be affected by the input impedance switch position, this can be used as a second pad control to adjust line input ranges on all channels.

DISCRETE JFET D.I (Channels 1 & 2):
(measured to line outputs / insert send)

D.I GAIN:	-10 to +60 dB [-10dB Pad]
MAXIMUM INPUT LEVEL:	+16dBu (typical), +22dBu
INPUT IMPEDANCE:	1MegΩ Unbalanced
FREQUENCY RESPONSE:	+/-0.5dB 10Hz to 50kHz
THD+N @ 0dBu (1kHz):	<0.03% [-70dBu]
SNR:	89dB

1/4" JACK: TIP (Hot) & SLEEVE (Shield)

LINE OUTPUTS (Insert Sends):

MAXIMUM OUTPUT LEVEL:	+27.5dBu
OUTPUT IMPEDANCE:	<100Ω Balanced

ADC LINE INPUTS (Insert Returns):
(measured at AES output under AES-17)

MAXIMUM INPUT LEVEL:	+18dBu
DIGITAL REFERENCE LEVEL:	0dBFS = +18dBu
INPUT IMPEDANCE:	>10kΩ Balanced
FREQUENCY RESPONSE:	+/-0.5dB 10Hz to Fs/2
CROSSTALK:	<80dBu @ 1kHz & 10kHz
THD+N @ -1dBFS (1kHz):	<0.002% [-94dB]
THD+N @ -6dBFS (1kHz):	<0.002% [-94dB]
DYNAMIC RANGE:	113dB un-weighted 115dB A-weighted
PEAK LED LINEUP:	+16dBu [-2dBFS]
SIGNAL LED LINEUP:	-10dBu [-28dBFS]

DIGITAL i/o:

ADAT 8 CHANNELS SMUX:	44.1 - 96kHz
AES S/PDIF 8 CHANNELS:	44.1 - 96kHz
CLOCK:	Internal or External
WORDCLOCK INPUT:	75Ω BNC Optional 75Ω Termination

POWER SUPPLY:

High stability, low noise internal SMPS
Fanless, quiet operation
Works anywhere in the world without reconfiguring

LINE VOLTAGES:	90 to 264V (a.c)
INTERNAL RAILS:	+/-18VDC, +48VDC & +5VDC
FUSE:	T1A (1Amp Time Delay)
CONSUMPTION:	Maximum 40 Watts

WEIGHT: 4.0 kg

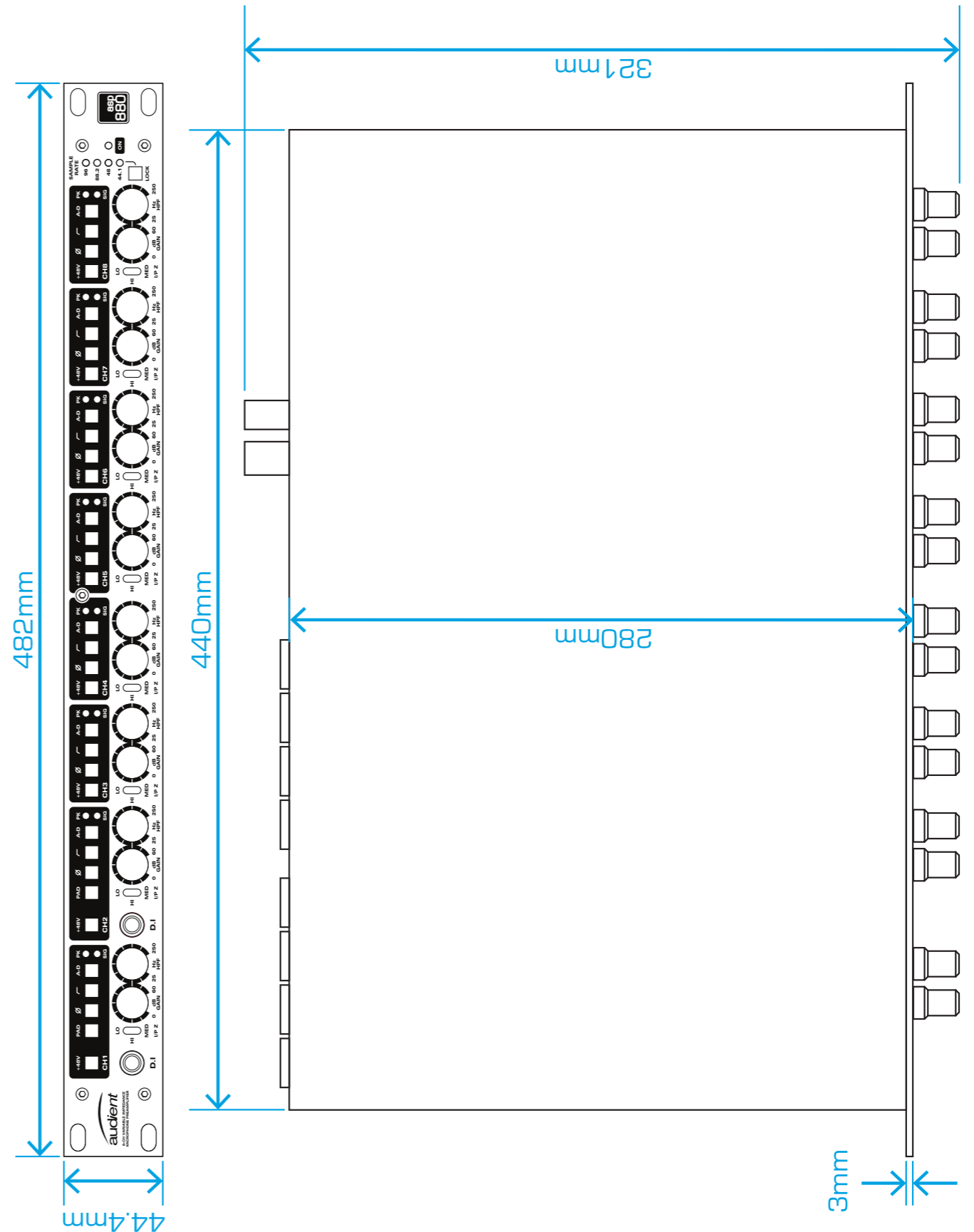

Warranty Statement

Your ASP880 comes with a manufacturer’s warranty for one year (12 months) from the date of despatch to the end user.

The warranty covers faults due to defective materials used in manufacture and faulty workmanship only.

During the warranty period *audient* will repair at its discretion or replace the faulty unit provided it is returned carriage paid to an authorised *audient* service centre. We will not provide warranty repair if in our opinion the has resulted from unauthorised modification, misuse, negligence or accident.

We accept liability to repair or replace your ASP880 as described above. We do not accept any additional liability. This warranty does not affect any legal rights you may have against the person who supplied this product - it is additional to those rights.

Warranty Limitations

This warranty does not cover damage resulting from accident or misuse. The warranty is void unless repairs are carried out by an authorised service centre. The warranty is void if the unit has been modified other than at the manufacturer’s instruction. The warranty does not cover components which have a limited life, and which are expected to be periodically replaced for optimal performance. We do not warrant that the unit shall operate in any other way than as described in this manual.

Audient Ltd
Aspect House
Herriard
Hampshire
RG25 2PN
United Kingdom

Tel: 0044 1256 381944
www.audient.com

Service Information

ASP880 contains no user-serviceable components, please refer to qualified service personnel for diagnosis and repair. Your warranty will be void if you tamper with the device at component level. If you have any questions with regard to the repair, please contact Audient Ltd.

In the event your ASP880 needs to be repaired, it is necessary to contact Audient Ltd prior to shipping, and a [Return Materials Authorization](#) (RMA) number will be assigned. This number will serve as a reference for you and helps facilitate and expedite the return process. When the unit is returned please include this RMA number along with a description of the fault inside the packaging box. Audient requires that shipments be pre-paid (for in-warranty repairs we will cover the return shipping).

To request an RMA, access technical support & FAQs, ask for troubleshooting assistance or make an enquiry, please visit: www.audient.com/support

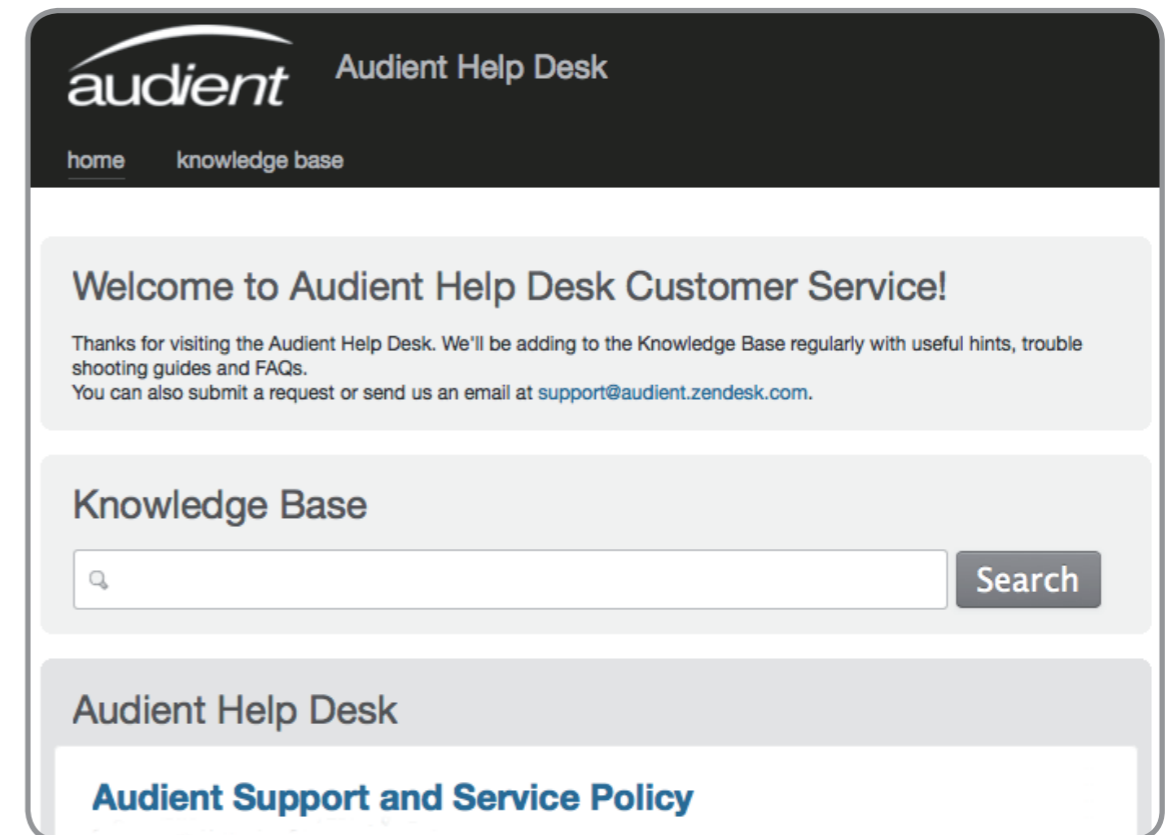

A	Amperes
ADAT	Alesis Digital Audio Tape
ADC	Analogue to Digital Converter
AES	Audio Engineering Society - AES Digital Audio Format
ASP	Analogue Signal Processing
DAW	Digital Audio Workstation
DAC	Digital to Analogue Converter
dB	Decibel
dBu	Decibel referenced to 0.775Vrms = 0 dBu
dBFS	Decibel Full Scale
DB9	9-Pin DSUB Connector - Digital AES Format If you make it to the top then this automatically becomes the connector for your Aston Martin key fob!
DB25	25-Pin DSUB Connector - Analogue Tascam Format
DC	Direct Current
D.I	Direct Injection (Instrument Input)
DoC	Declaration of Conformity
EIN	Equivalent Input Noise
FAQ	Frequently Asked Questions
HPF	High Pass Filter
HV	High Voltage
Hz	Hertz, cycles per second - measurement unit of frequency
i/o	Input / Output
JFET	Junction Field Effect Transistor
LED	Light Emitting Diode
Ohm	Ω , Unit of Resistance
RoHS	Restriction of Hazardous Substances
S/PDIF	Sony Philips Digital Interconnect Format
SMUX	Sample Multiplexing
THD+N	Total Harmonic Distortion + Noise
TRS	Tip Ring Sleeve (1/4" Jack Balanced)
TS	Tip Sleeve (1/4" Jack Unbalanced)
USB	Universal Serial Bus
V	Volts
XLR	Extra Live Return, Extremely Low Resistance, Canon X Series, Latching, Resilient Rubber Compound... or make up your own!
Z	Ohms, Ω , Input Impedance - can be varied by adjusting Z switch



USER MANUAL v1.3
April 2014