

Temblor™ T8

Active Studio Subwoofer

Owner's Manual

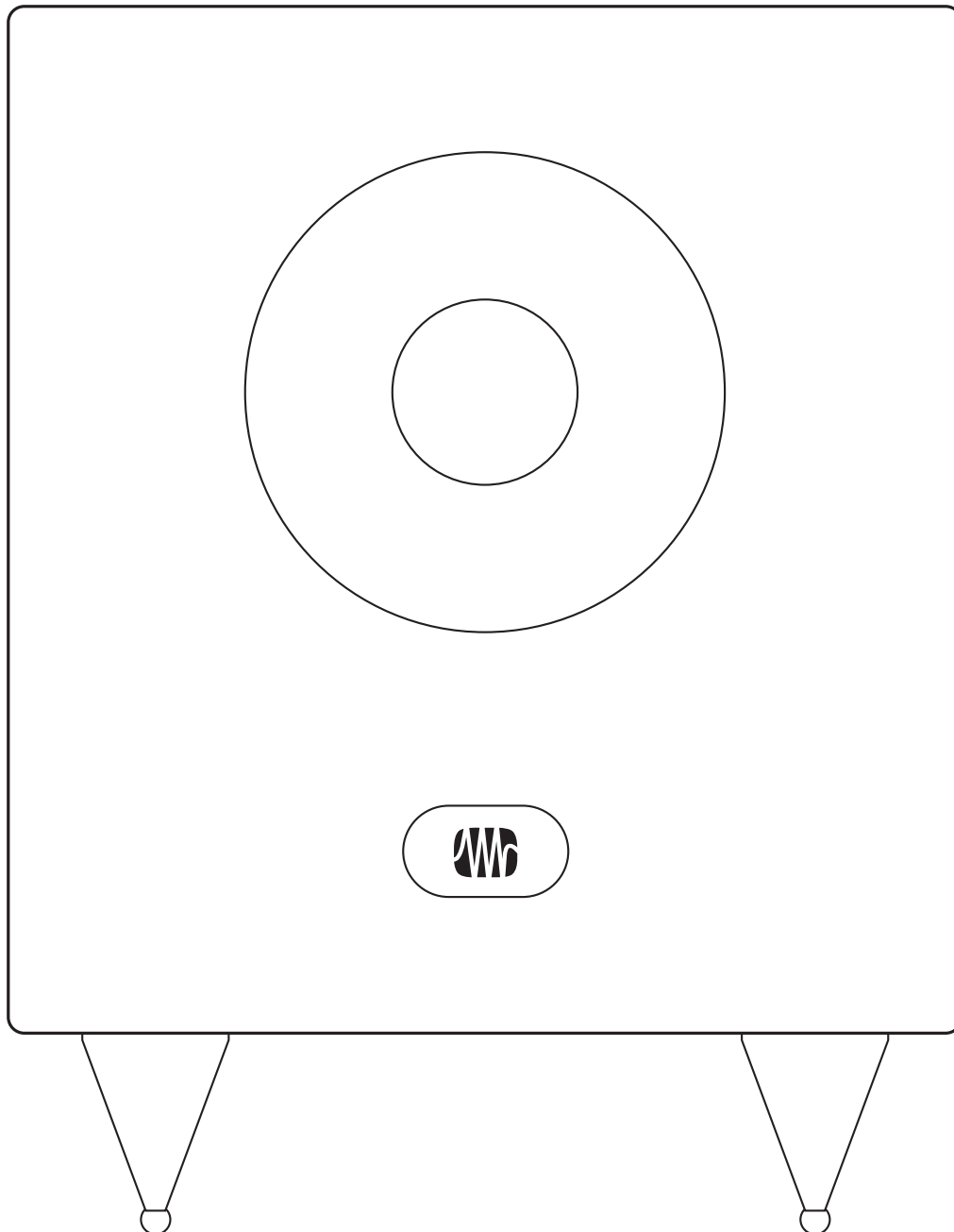

Table of Contents

1 Overview — 1

- 1.1 Introduction — 1
- 1.2 Summary of Temblor T8 Features — 1

2 Hookup — 2

- 2.1 What is in the Box — 2
- 2.2 Rear-Panel Connections and Controls — 2
 - 2.2.1 Inputs — 2
 - 2.2.2 Outputs — 2
 - 2.2.3 Power — 3
 - 2.2.4 User Controls — 3
- 2.2 Hookup Diagrams — 4
 - 2.2.1 Basic Setup — 4
 - 2.2.2 Advanced Setup — 5
 - 2.2.3 Home Theater Setup — 6

3 Tutorials — 7

- 3.1 Subwoofer Placement — 7
- 3.2 Level Calibration — 7

4 Resources — 9

- 4.1 Technical Specifications — 9
- 4.3 Troubleshooting — 10
- 4.4 PreSonus Limited Warranty — 10

1 Overview

1.1 Introduction

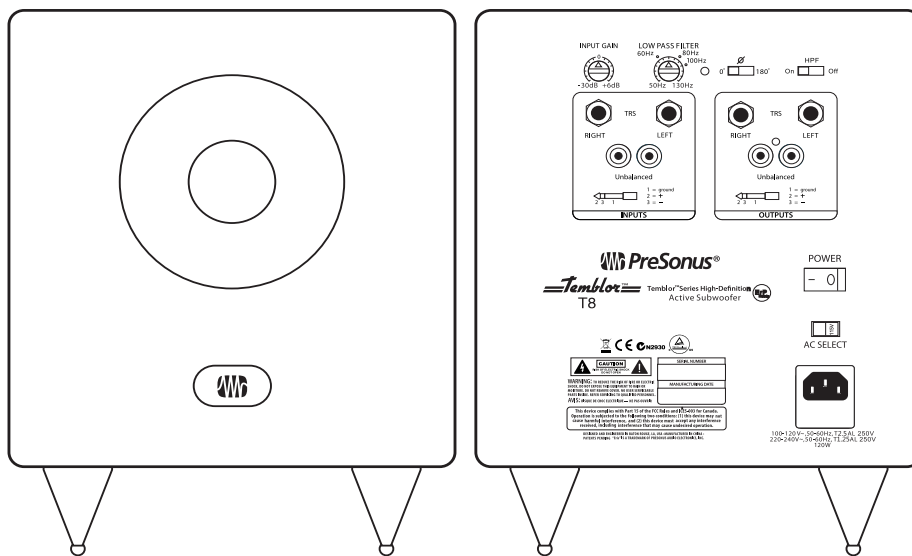

Thank you for purchasing the PreSonus® Temblor™ T8 active studio subwoofer. PreSonus Audio Electronics has designed the T8 utilizing high-grade components to ensure optimum performance that will last.

The Temblor T8 is an active subwoofer featuring a down-firing 8-inch glass-composite driver with a high-density rubber surround in a front-ported cabinet. This configuration provides responsive, defined bass with low distortion. The result is a natural and musical sound that enhances full-range speakers without overshadowing them. The variable (50 to 130 Hz) lowpass filter lets you dial in the Temblor T8 to pair perfectly with your full-range system, making it the ideal solution for 2.1 and surround sound applications.

PreSonus Audio Electronics is committed to constant product improvement, and we value your suggestions highly. We believe the best way to achieve our goal of constant product improvement is by listening to the real experts: our valued customers. We encourage you to visit My.PreSonus.com with any questions or comments regarding your PreSonus Temblor T8. We appreciate the support you have shown us through the purchase of this product and are confident that you will enjoy your Temblor T8!

ABOUT THIS MANUAL: We suggest that you use this manual to familiarize yourself with the features, applications, and correct connection procedures for your Temblor T8 before connecting it. This will help you avoid problems during installation and setup.

In addition to all the basic info you'll need to connect and operate your Temblor T8, this manual also provides several tutorials that cover subwoofer placement, connections, and calibration.

1.2 Summary of Temblor T8 Features

- Down-firing active subwoofer with 200 watt, Class AB amplifier
- 8-inch glass-composite woofer with high-density rubber surround
- Frequency response: 30-200 Hz
- Variable lowpass filter control: 50-130 Hz
- 80 Hz highpass filter (with defeat switch) for satellite connections
- Front-ported cabinet
- Power-down / Standby mode

2 Hookup

2.1 What is in the Box

In addition to this manual, your Temblor T8 package contains the following:

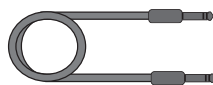
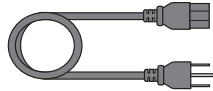
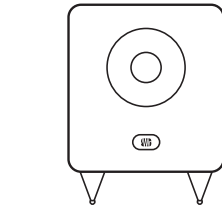

- (1) PreSonus Temblor T8 powered subwoofer
- (1) IEC power cable
- (1) 2M 1/4" TRS to TRS cable

2.2 Rear-Panel Connections and Controls

2.1.1 Inputs

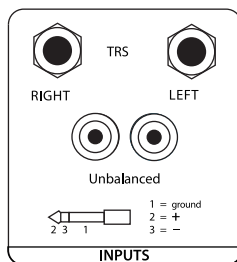

Line-level Inputs: The Temblor T8 provides a choice of two input pairs: a pair of balanced 1/4" TRS inputs and one pair of RCA unbalanced inputs. When both connections are in use, the RCA inputs will sum into the TRS connections.

Power User Tip: Connect both the left and right inputs if you are connecting your full-range monitors to the T8's outputs, or if you're running your Temblor T8 independently from a stereo source (such as the PreSonus Monitor Station). This will ensure that your Temblor T8 receives the low-frequency content from both the left and right sides of a stereo audio signal. If your audio source provides a mono or LFE output, you only need to connect one input—either L or R.



Input Gain: Sets the level of the input signal before it is amplified.

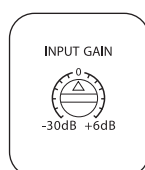

2.1.2 Outputs

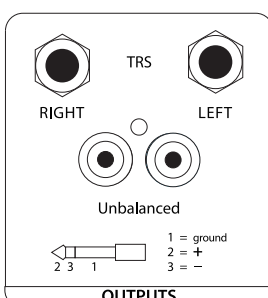

Outputs: The Temblor T8 provides two pairs of outputs: a pair of balanced 1/4" TRS outputs and a pair of RCA unbalanced outputs. The full-range signal connected to the stereo inputs on the T8 is passed through to these outputs. Use these outputs to connect your main left and right studio monitors.

If the High Pass Filter switch is engaged, frequencies below 80 Hz are not sent from these outputs.

2.1.3 Power

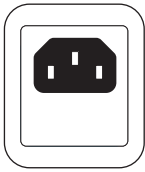

IEC Power Connection: Your Temblor T8 accepts a standard IEC power cord.

Warning: Do not remove the center grounding prong or use a separate ground-lift adapter, as this could result in electric shock.

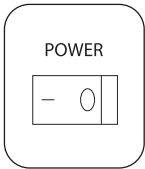

Power Switch: This is the On/Off switch. The power status is indicated by the illuminated logo on the front of the cabinet.

Power User Tip: Your Temblor T8 features a Standby mode. When no signal is present for longer than ten minutes, your T8 will lower its power consumption to less than 0.5W until signal is present again. The lighted logo on the front of your T8 will turn white when Standby mode is active

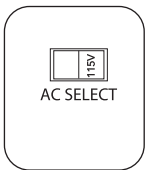

AC Select Switch: The input-power voltage is set at the factory to correspond with the country to which it was shipped. Use this switch only if you are using your Temblor T8 in a country that uses a different standard voltage than is used in the country where you purchased your T8.

2.1.4 User Controls

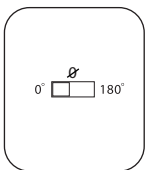

Polarity: The Polarity button reverses the polarity of the input signals.

Power User Tip: Once you have connected your T8 to your system, try experimenting with each setting while listening to your favorite music. Leave this switch in the position where the bass was the loudest.

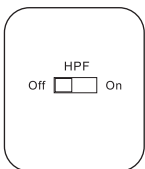

High Pass Filter: Removes frequency content below 80 Hz from the full-range signal sent from the T8 outputs. This is useful if your main studio monitors do not have their own highpass filter.

Power User Tip: Leaving frequency content below 80 Hz in full-range monitors can cancel out or reinforce the highest frequencies that are reproduced by the Temblor T8. This can make the bass response of the overall system muddy and ill-defined. By rolling off your full-range speakers, you will create a more linear frequency response between the subwoofer and full-range content.

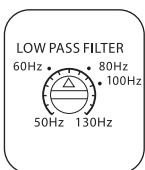

Low Pass Filter: This control determines the upper end of the frequency range reproduced by the Temblor T8. If you have enabled the onboard highpass filter, set the Low Pass Filter control to 80 Hz. Otherwise, set the Low Pass Filter control to the lowest frequency that your main monitors can reliably reproduce.

2.2 Hookup Diagrams

2.2.1 Basic Setup

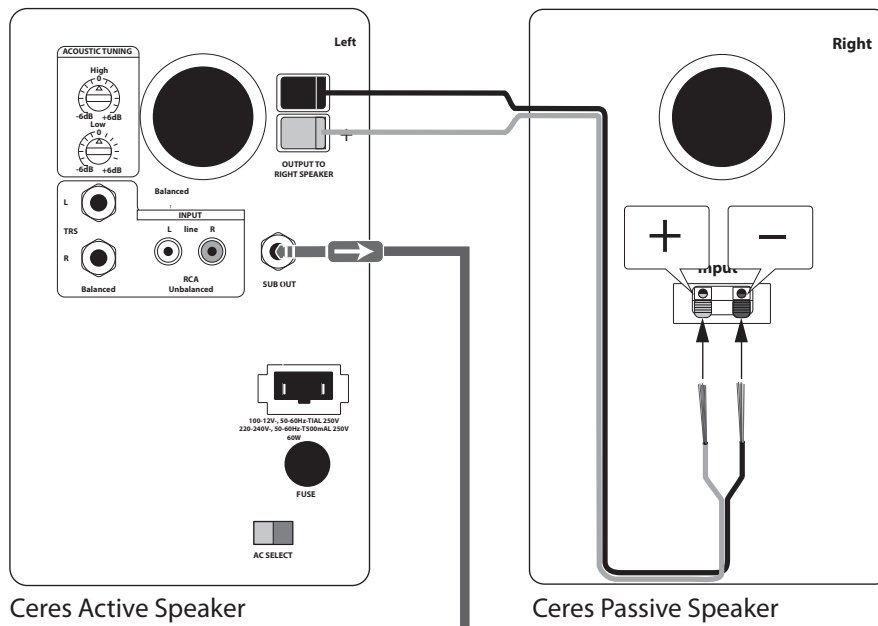

Ceres Active Speaker

Ceres Passive Speaker

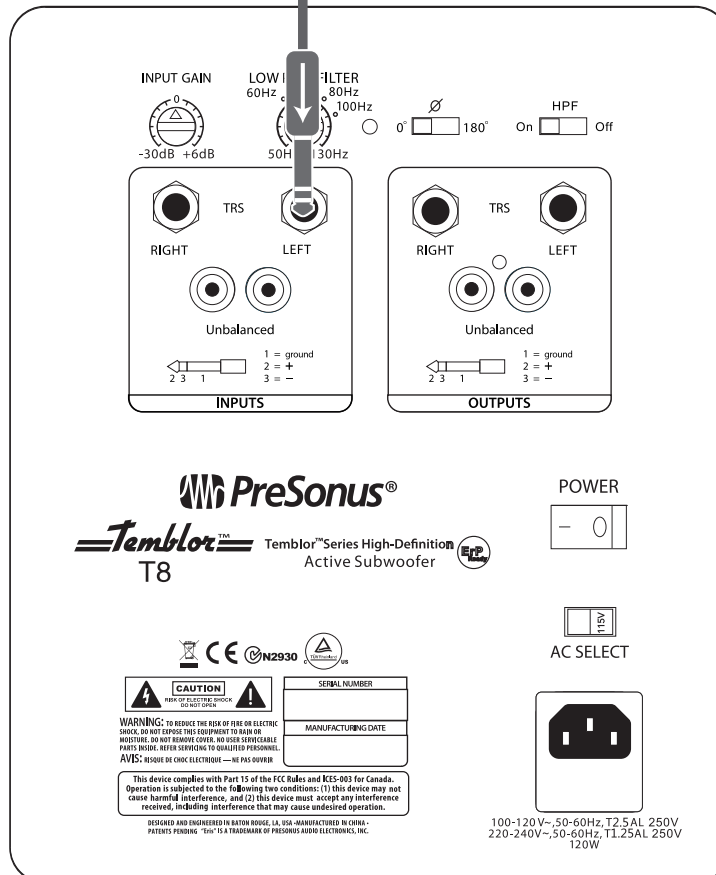

Temblor T8

2.2.2 Advanced Setup

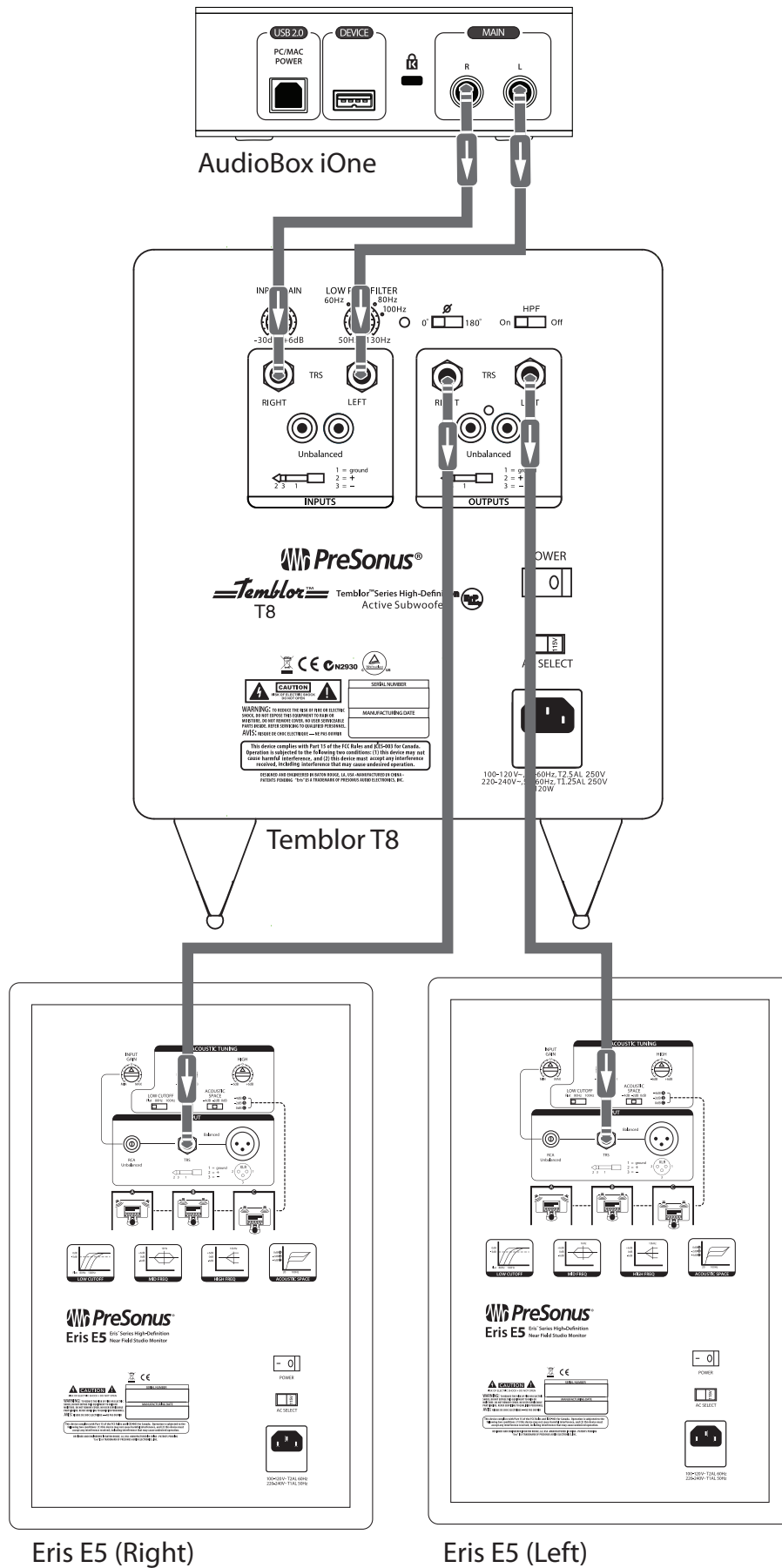

2.2.3 Home Theater Setup

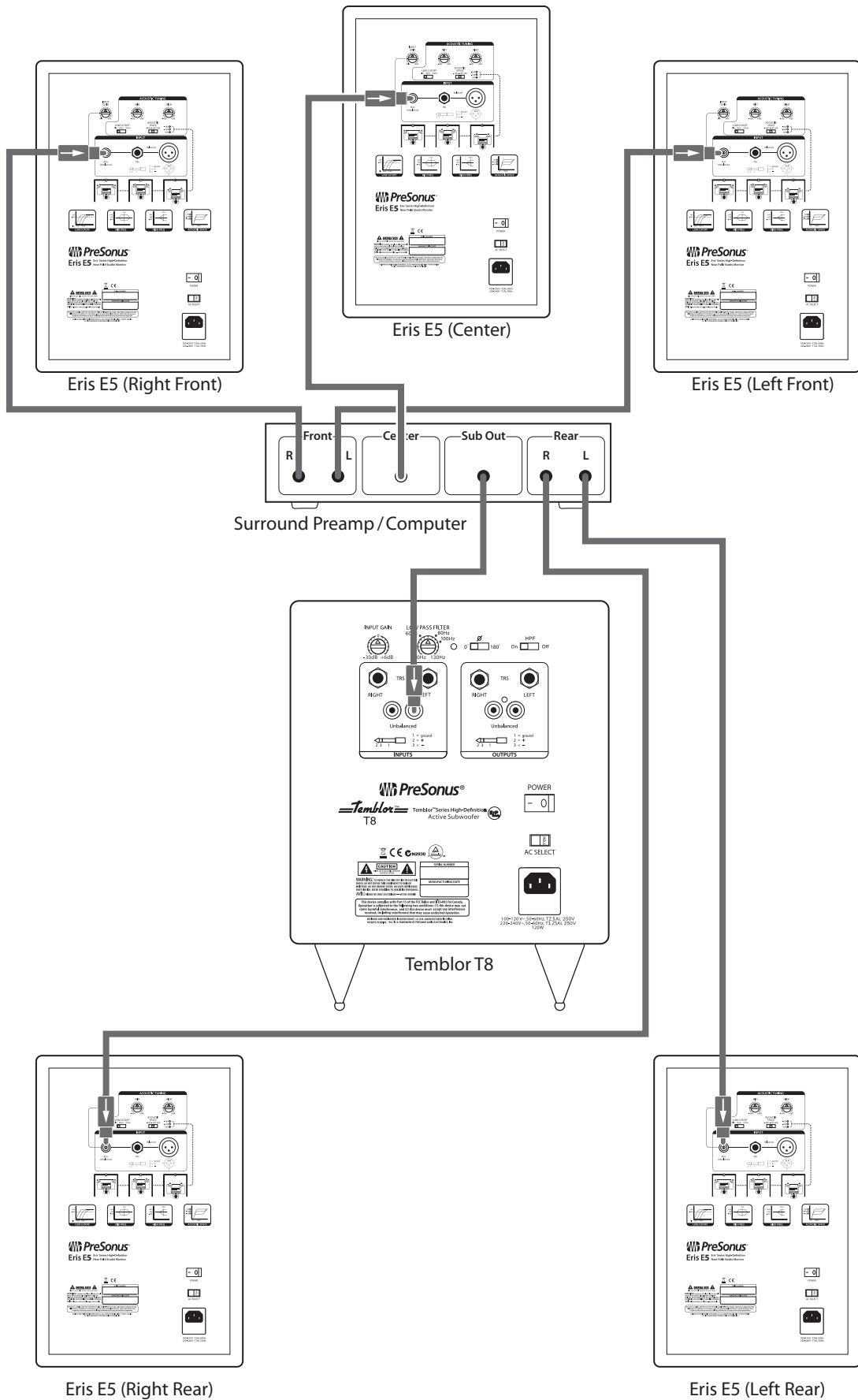

3 Tutorials

3.1 Subwoofer Placement

The goal of proper subwoofer placement is to set up your system so that your subwoofer acts as a natural extension of your full-range monitors without boosting the overall bass response of your room or exaggerating any one frequency or frequency range. Because low frequencies are not directional—that is, humans cannot perceive the direction from which low frequencies are coming—you aren't limited to placing it near your full-range monitors. However, placing your T8 in the same side of the room as your full-range monitors will typically provide the best listening experience.

A quick way to find the best location for your subwoofer is to temporarily place it on the ground where you would normally be listening to your system, then play some music that contains a lot of bass. Walk around the half of the room where you have placed your full-range monitors until you find the spot where the bass sounds its best. In general, you will want to avoid placing your subwoofer too near to reflective surfaces, like a wall or in a corner as this will exaggerate the bass energy and make your T8 sound "boomy."

Once you find the place in the room where the bass sounds the smoothest, place your T8 in that spot, return to the listening position and listen to it again. You may need to adjust the location; just keep making small adjustment (a foot or so at a time) until the bass response sounds as even as possible.

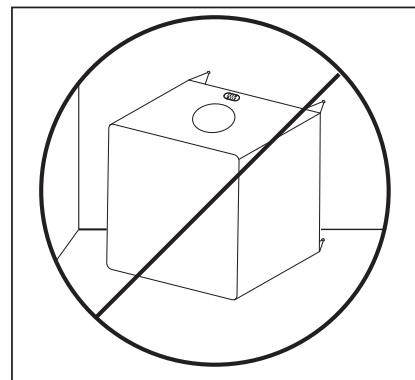
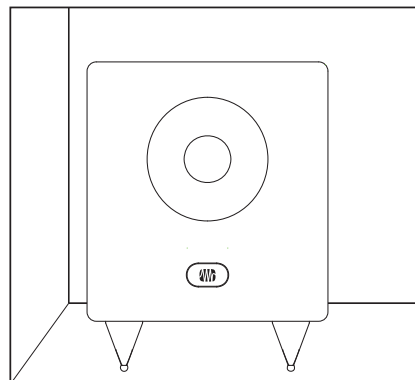

3.2 Level Calibration

Matching the levels of the monitors in your system with your subwoofer is an easy extra step that will help you to achieve a consistent listening environment. This will ensure that your subwoofer won't be too loud with some types of music and not nearly loud enough with others. You will need an SPL meter and some pink noise to do this; luckily, there are many inexpensive and free SPL meter apps for just about every type of smartphone, as well as a variety of free pink noise samples online that will do the job nicely.

Below is a brief tutorial on how to level match your monitors:

1. Connect your monitors and Temblor T8 as shown either of the hookup diagrams in **Section 2.2**.

Power User Tip: If your system has an EQ in it, turn it off. You can EQ your complete system to taste once the levels are evenly matched.

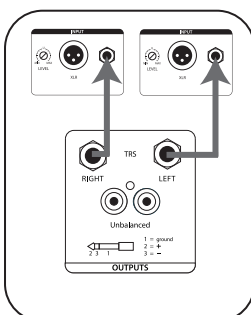

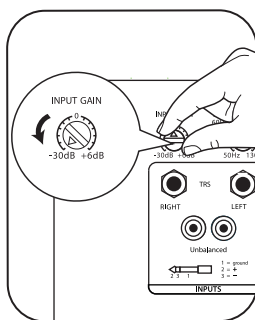

- Turn your Temblor T8 and your full-range monitors' input levels to their lowest setting.

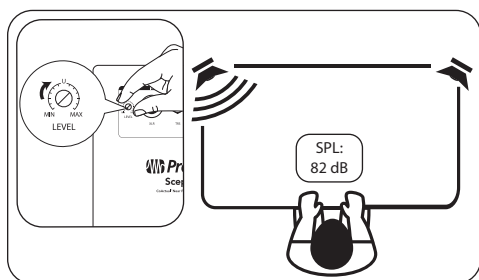

- Play pink noise through your speakers. You should not hear anything yet.
- Begin slowly increasing the volume of your left monitor until the acoustic level of the pink noise reaches 82 dB SPL on your SPL meter when measured at your listening position. Turn off your left monitor and repeat with your right monitor.

If you're using monitors that provide a single level control for both the left and right side, like the Ceres™ C3.5BT, C4.5BT or Eris 4.5BT, play pink noise through both monitors, increase the volume until your SPL meter reads 85 dB.

Power User Tip: If 82 dB or 85 dB is too loud or too quiet for your room, set the level to one that is more comfortable for your listening requirements. Just be sure to set the same level for both the left and the right monitor.

- Turn your full-range monitors off. If your T8 is connected to the Sub Out on a Ceres C3.5BT or C4.5BT, set the input volume of your Temblor T8 to "0" and skip to Step 7.

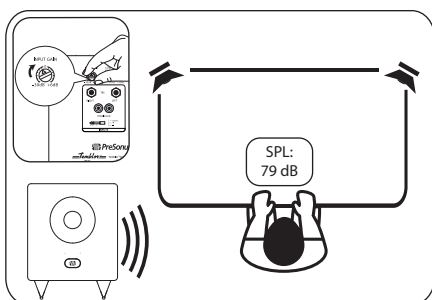

- Begin slowly increasing the input volume on your Temblor T8 until the acoustic level of the pink noise reaches 79 dB SPL on your SPL meter when measured at your listening position.

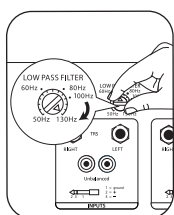

- Set the lowpass filter on your T8 to 130 Hz. This will create a frequency overlap between your T8 and your full-range system.

- Play pink noise through your full system and experiment with the polarity switch on your Temblor T8 to see which position provides the best bass response. Leave the polarity switch where the bass is the loudest.
- Now play some music through your system and experiment with the lowpass filter on your T8 until you find the most natural transition between your full-range monitors and your subwoofer. If your full-range monitors are connected to the outputs of your T8, you may want to try turning on the 80 Hz highpass filter on the T8 and setting the lowpass filter to 80 Hz.

Power User Tip: Once you have matched the levels of your full-range monitors and T8, don't use their volume controls to adjust the overall level; instead, use the volume on your audio device (computer, iPad, TV, etc.). This will ensure that your speaker levels remain matched.

4 Resources

4.1 Technical Specifications

INPUTS

	2- Balanced ¼"TRS
	2- Unbalanced RCA

OUTPUTS

	2- Balanced ¼"TRS (full range with 80 Hz HPF option)
	2- Unbalanced RCA (full range with 80 Hz HPF option)

PERFORMANCE

Frequency Response	30 Hz – 200 Hz
Low Pass Filter Frequency	50 – 130 Hz (variable)
Signal-to-Noise Ratio	>98 dB (A-weighted)
THD	0.05%
Amplifier Power	100W RMS / 200W Peak
Power Consumption	120W
Standby Power Consumption	<0.5W
Amplifier Type	Class AB
Woofers	8" glass-composite with high-density rubber surround

USER CONTROLS

Input Gain Control	-30 to +6 dB
Polarity Switch	0° or 180°
Low Pass Filter Control	50 Hz to 130 Hz
High Pass Filter Switch	On/Off

PROTECTION

	RF interference
	Output-current limiting
	Over-temperature
	Turn-on/off transient
	Subsonic filter
	External mains fuse

POWER

	100-120V ~50/60 Hz or 220-240V ~50/60 Hz
--	--

CABINET

	Vinyl-laminated MDF
--	---------------------

PHYSICAL

Width	10.2" (260 mm)
Depth	12.6" (320 mm)
Height	11" (280 mm)
Weight	21.2 lbs (9.6 kg)

4.3 Troubleshooting

No power. First ensure that your Temblor T8 is plugged in. If it's connected to a power conditioner, verify that the power conditioner is turned on and functioning. If it is, yet there is still no power to the T8, contact PreSonus for a repair.

No audio. If your Temblor T8 appears to power on but you hear no sound when playing audio (the lights are on but nobody's home), first make sure that the cables connected to the subwoofer are working correctly. Also, verify that the Input Level control is set to provide high enough gain.

Hum. Usually, hum is caused by a ground loop. Verify that all audio equipment is connected to the same power source. If you are not using a power conditioner, we highly recommend that you add one. Not only will this help to minimize hum, it will better protect your equipment from power surges, brownouts, etc.

Use balanced cables whenever possible. If your audio device does not offer a balanced output, you can connect it to a DI (direct-injection) box, which will provide a ground-lift switch and a balanced output.

Finally, make sure that your audio cables are not run near power cables, and use cables that are the appropriate length for your application. Using cables that are too long not only increases the risk of noise, it increases the likelihood that the cables are coiled, which will essentially create an antenna that picks up all kinds of audio interference.

4.4 Warranty

PreSonus's warranty obligations for this hardware product are limited to the terms set forth below:

How Consumer Law Relates To This Warranty:

THIS WARRANTY GIVES YOU SPECIFIC LEGAL RIGHTS, AND YOU MAY HAVE OTHER RIGHTS THAT VARY FROM STATE TO STATE (OR BY COUNTRY OR PROVINCE). OTHER THAN AS PERMITTED BY LAW, PRESONUS DOES NOT EXCLUDE, LIMIT OR SUSPEND OTHER RIGHTS YOU MAY HAVE, INCLUDING THOSE THAT MAY ARISE FROM THE NONCONFORMITY OF A SALES CONTRACT. FOR A FULL UNDERSTANDING OF YOUR RIGHTS YOU SHOULD CONSULT THE LAWS OF YOUR COUNTRY PROVINCE OR STATE.

PreSonus Products And EU Statutory Warranty:

When you purchase PreSonus products, European Union consumer law provides statutory warranty rights in addition to the coverage you receive from the PreSonus limited warranty. A summary of the EU Statutory Warranty and the PreSonus Limited Warranty is below:

	EU Consumer Law	PreSonus Limited Warranty
Repair or Replacement Coverage For	Defects present when customer takes delivery	Defects arising after customer takes delivery
Warranty Period	2 years (minimum) from original date of purchase (unless superseded by PreSonus)	1 year from original date of purchase (unless superseded by PreSonus)
Cost of Coverage	Provided at no additional cost	Included at no additional cost
Who to contact to make a claim	The seller	PreSonus technical support for your region

What This Warranty Covers:

PreSonus Audio Electronics, Inc., ("PreSonus") warrants defects in material and workmanship in PreSonus-branded products under normal use. This Limited Warranty applies only to hardware products manufactured by or for PreSonus that can be identified by the PreSonus trademark, trade name, or logo affixed to them.

Exclusions and Limitations:

This warranty does not cover the following:

1. Damage caused by accident, abuse, improper installation, failure to follow instructions in the applicable owner's manual or improper operation, rental, product modification, alteration, or neglect.
2. Damage from improper grounding, faulty wiring (AC and signal), faulty equipment, or connection to a voltage range outside published specifications (see applicable owner's manual).
3. Damage to drivers or diaphragm assemblies found to have burnt voice coils from over/under driving or signal surge from another device.
4. Damage occurring during shipment or improper handling.
5. Damage caused by repair or service performed by persons not authorized by PreSonus.
6. Products on which the serial number has been altered, defaced, or removed.
7. Products purchased from an un-authorized PreSonus dealer (products that have transferable warranties are excluded from this provision provided the customer and the product are registered with PreSonus).

Who This Warranty Protects:

This Warranty protects only the original retail purchaser of the product (products that have transferable warranties are excluded from this provision provided the customer and the product are registered with PreSonus)

How Long This Warranty Lasts:

The Warranty begins on the original date of purchase from the retail purchaser and the duration is as follows:

1-Year Limited Warranty		
Product Category	Model	Transferable
Recording Interfaces	AudioBox iOne, AudioBox iTwo, AudioBox Stereo, AudioBox Studio, AudioBox USB, AudioBox VSL (1818, 44, 22), FireStudio Project, FireStudio Mobile, FireStudio Mobile Studio, Music Creation Suite	No
Pre-amplifiers	ADL600, ADL700, BlueTube DP V2, DigiMax D8, Eureka, RC500, StudioChannel, TubePre V2	No
StudioLive Mixers	SL-1642, SL-2442, SL-1602, SLM16.4.2 AI, SLM24.4.2 AI, SLM32.4.2AI	No
Monitoring & Controlling	Eris, Central Station Plus, FaderPort, HP4, HP60, Monitor Station, Monitor Station V2, Sceptre, Temblor	No
Signal Processing	ACP88	No
Accessories	Covers, Dolly, PRM1 mic, Sub Pole, Breakout Cables, Power Supplies, M10 Kit	No
3-Years Limited Warranty		
Product Category	Model	Transferable
Live Sound	StudioLive AI 328, 312, 315, S18	Yes

What PreSonus Will Do:

PreSonus will repair or replace, at our sole and absolute option, products covered by this warranty at no charge for labor or materials. If the product must be shipped to PreSonus for warranty service, the customer must pay the initial shipping charges. PreSonus will pay the return shipping charges.

How to Get Warranty Service (USA):

1. You must have an active user account with PreSonus and your hardware must be on file with your account. If you do not have an account, please go to: <http://www.presonus.com/registration> and complete the registration process.
2. Contact our Technical Support Department at (225) 216-7887 or log a support ticket at: <http://support.presonus.com>. TO AVOID THE POSSIBILITY OF SENDING IN A PRODUCT THAT DOES NOT HAVE A PROBLEM, ALL SERVICE REQUESTS SHALL BE CONFIRMED BY OUR TECH SUPPORT DEPARTMENT.
3. The return authorization number as well as shipping instructions shall be provided after your service request is reviewed and confirmed.
4. The product should be returned for service in the original product packaging. Products may be shipped in a manufactured "flight" or "road" style cases but PreSonus will NOT cover any shipping damage to these cases. Products that are not shipped in the original product package or a manufactured case may not receive a warranty repair, at PreSonus's sole discretion. Depending on the product model and the condition of your original packaging, your product may not be returned to you in the original packaging. The return shipping box may be a generic box that has been fitted for that model tested if the original gift box is not available.

How to Get Warranty Service (outside of USA):

1. You must have an active user account with PreSonus and your hardware must be on file with your account. If you do not have an account, please go to: <http://www.presonus.com/registration> and complete the registration process.
2. Contact the Technical Support/Service Department for your region at http://www.presonus.com/buy/international_distributors and follow procedures provided by your PreSonus contact.

Limitation of Implied Warranties:

ANY IMPLIED WARRANTIES, INCLUDING WARRANTIES OF MERCHANTABILITY AND FITNESS FOR A PARTICULAR PURPOSE, ARE LIMITED IN DURATION TO THE LENGTH OF THIS WARRANTY.

Some states, countries, or provinces do not allow limitations on how long an implied warranty lasts, so the above limitation may not apply to you.

Exclusion of Damages:

PRESONUS'S LIABILITY FOR ANY DEFECTIVE PRODUCT IS LIMITED TO THE REPAIR OR REPLACEMENT OF THE PRODUCT, AT PRESONUS'S SOLE OPTION. IF PRESONUS ELECTS TO REPLACE THE PRODUCT, THE REPLACEMENT MAY BE A RECONDITIONED UNIT. IN NO EVENT WILL PRESONUS BE LIABLE FOR DAMAGES BASED ON INCONVENIENCE, LOSS OF USE, LOST PROFITS, LOST SAVINGS, DAMAGE TO ANY OTHER EQUIPMENT OR OTHER ITEMS AT THE SITE OF USE, AND, TO THE EXTENT PERMITTED BY LAW, DAMAGES FOR PERSONAL INJURY, OR ANY OTHER DAMAGES WHETHER INCIDENTAL, CONSEQUENTIAL OR OTHERWISE, EVEN IF PRESONUS HAS BEEN ADVISED OF THE POSSIBILITY OF SUCH DAMAGES.

Some states, countries, or provinces do not allow limitations on how long an implied warranty lasts, so the above limitation may not apply to you.

If you have any questions about this warranty or service received, please contact PreSonus (USA) at (225) 216-7887 or one of our authorized international distributors at: http://www.presonus.com/buy/international_distributors.

Product features, design, and specifications are subject to change without notice.

Added bonus: PreSonus' previously Top Secret recipe for...

Rice Dressing

Ingredients:

- 1lb ground beef
- 1 lb chopped chicken liver
- 1 onion (diced)
- 2 green peppers (diced)
- 4-6 celery stalks (diced)
- 2 garlic cloves (minced)
- ¼ C. chopped fresh parsley
- 3 C. chicken stock
- 6 C. cooked rice
- 1 Tbs. oil
- Salt and pepper to taste
- Cayenne pepper to taste

Cooking Instructions:

1. In a large pot, heat oil on medium high and add meat, salt, and pepper to taste. Stir until meat begins to brown.
2. Lower heat and add all vegetables. Cook until onions are transparent and celery is very tender. Add stock as necessary to prevent burning.
3. Stir in cooked rice. Add remaining stock and simmer on low until ready to serve.

Temblor™ T8

Active Studio Subwoofer

Owner's Manual

