



124™

DIGITAL LIVE
CONSOLE

OWNER'S MANUAL

Important Safety Instructions

1. Read these instructions.
2. Keep these instructions.
3. Heed all warnings.
4. Follow all instructions.
5. Do not use this apparatus near water.
6. Clean only with dry cloth.
7. Do not block any ventilation openings. Install in accordance with the manufacturer's instructions.
8. Do not install near any heat sources such as radiators, heat registers, stoves, or other apparatus (including amplifiers) that produce heat.
9. Do not defeat the safety purpose of the polarized or grounding-type plug. A polarized plug has two blades with one wider than the other. A grounding-type plug has two blades and a third grounding prong. The wide blade or the third prong are provided for your safety. If the provided plug does not fit into your outlet, consult an electrician for replacement of the obsolete outlet.
10. Protect the power cord from being walked on or pinched particularly at plugs, convenience receptacles, and the point where they exit from the apparatus.
11. Only use attachments/accessories specified by the manufacturer.
12. Use only with a cart, stand, tripod, bracket, or table specified by the manufacturer, or sold with the apparatus. When a cart is used, use caution when moving the cart/apparatus combination to avoid injury from tip-over.
13. Unplug this apparatus during lightning storms or when unused for long periods of time.
14. Refer all servicing to qualified service personnel. Servicing is required when the apparatus has been damaged in any way, such as power-supply cord or plug is damaged, liquid has been spilled or objects have fallen into the apparatus, the apparatus has been exposed to rain or moisture, does not operate normally, or has been dropped.
15. This mixer has been designed with Class-I construction and must be connected to a mains socket outlet with a protective earthing connection (the third grounding prong).
16. This mixer has been equipped with an all-pole, rocker-style AC mains power switch. This switch is located on the rear panel and should remain readily accessible to the user.
17. This apparatus does not exceed the Class A/Class B (whichever is applicable) limits for radio noise emissions from digital apparatus as set out in the radio interference regulations of the Canadian Department of Communications.
ATTENTION — Le présent appareil numérique n'émet pas de bruits radioélectriques dépassant les limites applicables aux appareils numériques de class A/de class B (selon le cas) prescrites dans le règlement sur le brouillage radioélectrique édicté par les ministere des communications du Canada.
18. Exposure to extremely high noise levels may cause permanent hearing loss. Individuals vary considerably in susceptibility to noise-induced hearing loss, but nearly everyone will lose some hearing if exposed to sufficiently intense noise for a period of time. The U.S. Government's Occupational Safety and Health Administration (OSHA) has specified the permissible noise level exposures shown in the following chart.

PORTABLE CART WARNING



Carts and stands - The Component should be used only with a cart or stand that is recommended by the manufacturer. A Component and cart combination should be moved with care. Quick stops, excessive force, and uneven surfaces may cause the Component and cart combination to overturn.



CAUTION AVIS

RISK OF ELECTRIC SHOCK
DO NOT OPEN

RISQUE DE CHOC ELECTRIQUE
NE PAS OUVRIR



CAUTION: TO REDUCE THE RISK OF ELECTRIC SHOCK DO NOT REMOVE COVER (OR BACK) NO USER-SERVICEABLE PARTS INSIDE REFER SERVICING TO QUALIFIED PERSONNEL

ATTENTION: POUR EVITER LES RISQUES DE CHOC ELECTRIQUE, NE PAS ENLEVER LE COUVERCLE. AUCUN ENTRETIEN DE PIECES INTERIEURES PAR L'USAGER. CONFIEZ L'ENTRETIEN AU PERSONNEL QUALIFIE.

AVIS: POUR EVITER LES RISQUES D'INCENDIE OU D'ELECTROCUTION, N'EXPOSEZ PAS CET ARTICLE A LA PLUIE OU A L'HUMIDITE

 The lightning flash with arrowhead symbol within an equilateral triangle is intended to alert the user to the presence of uninsulated "dangerous voltage" within the product's enclosure, that may be of sufficient magnitude to constitute a risk of electric shock to persons.

Le symbole éclair avec point de flèche à l'intérieur d'un triangle équilatéral est utilisé pour alerter l'utilisateur de la présence à l'intérieur du coffret de "voltage dangereux" non isolé d'ampleur suffisante pour constituer un risque d'électrocution.

 The exclamation point within an equilateral triangle is intended to alert the user of the presence of important operating and maintenance (servicing) instructions in the literature accompanying the appliance.

Le point d'exclamation à l'intérieur d'un triangle équilatéral est employé pour alerter les utilisateurs de la présence d'instructions importantes pour le fonctionnement et l'entretien (service) dans le livret d'instruction accompagnant l'appareil.

According to OSHA, any exposure in excess of these permissible limits could result in some hearing loss. To ensure against potentially dangerous exposure to high sound pressure levels, it is recommended that all persons exposed to equipment capable of producing high sound pressure levels use hearing protectors while the equipment is in operation. Ear plugs or protectors in the ear canals or over the ears must be worn when operating the equipment in order to prevent permanent hearing loss if exposure is in excess of the limits set forth here.

Duration Per Day In Hours	Sound Level dBA, Slow Response	Typical Example
8	90	Duo in small club
6	92	
4	95	Subway Train
3	97	
2	100	Very loud classical music
1.5	102	
1	105	Tami screaming at Adrian about deadlines
0.5	110	
0.25 or less	115	Loudest parts at a rock concert

WARNING — To reduce the risk of fire or electric shock, do not expose this apparatus to rain or moisture.

Table of Contents

Chapter 1: Introduction	9
1.1 Evolution of the TT24 Console	9
1.2 Summary of Features	10
1.2.1 DSP Functionality.....	10
1.3 Terminology and Conventions.....	12
Chapter 2: Quickstart Tutorial	13
2.1 Connect Amplifier/Speakers.....	13
2.2 Connect a Mic.....	13
2.3 Connect a CD/Tape Device	17
2.4 Aux Functions	19
2.5 Effects	21
Chapter 3: Console Surface Controls	23
3.1 Channel Strip	23
3.1.1 LINE	24
3.1.2 48 V Phantom Power.....	24
3.1.3 GAIN.....	25
3.1.4 OL and SIG.....	25
3.1.5 V-Pot	25
3.1.6 MUTE	26
3.1.7 Bank/Channel Description Area	26
3.1.8 SELECT.....	26
3.1.9 SOLO	27
3.1.10 Channel Fader.....	27
3.2 Bank Select Area.....	28
3.2.1 ANALOG.....	28
3.2.2 DIGITAL.....	28
3.2.3 RETURNS	28
3.2.4 MASTER.....	29

3.3	V-Pot Control Area.....	29
3.3.1	TRIM.....	29
3.3.2	PAN.....	30
3.3.3	HPF.....	30
3.3.4	METERS.....	31
3.3.5	AUX SENDS 1–12.....	31
3.3.6	AUX PAN.....	31
3.3.7	AUX MODE.....	32
3.4	QuickMix Area	32
3.4.1	FAT	34
3.4.2	EQ	34
3.4.3	DYN	34
3.4.4	GRP/AUX.....	34
3.4.5	AUX MSTR.....	35
3.4.6	SNAP.....	35
3.4.7	EFX	35
3.4.8	MATRIX.....	35
3.4.9	Engineer's Utility	35
3.4.10	Main Meters and RUDE SOLO LED	37
3.5	UTILITY Area.....	38
3.5.1	TALKBACK.....	38
3.5.2	MONITOR	38
3.5.3	PHONES.....	39
3.6	Snapshots	39
3.7	Group and Master Controls.....	40
3.7.1	Changing the Group Bank.....	40
3.7.2	Group Assignment	41
3.7.3	Group Parameter Control.....	41
3.8	Solo Area.....	41
3.8.1	CLEAR SOLO.....	41
3.8.2	PFL.....	41

Chapter 4: Rear Panel Connectors	43
4.1 Analog I/O.....	43
4.1.1 MIC Inputs 1–24	43
4.1.2 LINE Inputs 1–24	44
4.1.3 INSERTS 1–24	44
4.1.4 AUX SENDS 1–12.....	45
4.1.5 LINE INPUTS 1–8 (RETURNS)	45
4.1.6 MONITOR	46
4.1.7 CD/TAPE A IN/OUT	46
4.1.8 CD/TAPE B Input	46
4.1.9 TALKBACK MIC Input	47
4.1.10 MAINS OUT	47
4.1.11 GROUP/MATRIX OUT	47
4.2 Digital I/O.....	48
4.2.1 ADAT DIGITAL I/O	48
4.2.2 AES/EBU IN/OUT.....	49
4.2.3 SPDIF IN/OUT.....	49
4.2.4 WORD CLOCK IN/OUT	50
4.2.5 MIDI IN/OUT	50
4.2.6 USB.....	50
4.3 IEC Power Receptacle.....	50
4.4 POWER Switch	50
Chapter 5: DSP and Internal Effect Allocation	51
5.1 Analog, Digital, and Line Inputs.....	51
5.2 Master L/R and C/Mono.....	52
5.2.1 L/R+Mono and LCR Modes.....	52
5.2.2 Six-Band EQ	53
5.2.3 Compressor	53
5.2.4 Fader Position in Signal Path	53
5.3 Aux Send	53
5.3.1 Six-Band Parametric EQ	54
5.3.2 Compressor	54

5.4	Flex-Group DSP	54
5.4.1	Flex-Group Modes	54
5.4.2	Group DSP Allocation	56
5.5	Matrix Output	57
5.5.1	Delay	57
5.6	Internal Effects Processors.....	57
5.7	Tabular Summary of DSP and Effects.....	58

Chapter 6: Touchscreen and TT Control..... 63

6.1	TT Control Conventions	63
6.1.1	TT Control Knob.....	64
6.1.2	TT Control Buttons	65
6.1.3	TT Control Menus	65
6.1.4	TT Control Graphs	65
6.2	Touchscreen Conventions	66
6.2.1	Touchscreen Knobs	66
6.2.2	Touchscreen Buttons.....	67
6.2.3	Touchscreen Name and Channel/Function.....	67
6.2.4	Sub Screens	68
6.3	Overview Touchscreens	68
6.3.1	Analog	68
6.3.2	Digital	69
6.3.3	Effect Return	70
6.3.4	Line	72
6.3.5	Aux	73
6.3.6	Group	74
6.3.7	Master.....	75
6.4	Four-Band Equalizer	76
6.5	Six-Band Equalizer	78
6.5.1	Four-Band EQ	78
6.5.2	Kill Filters	78
6.6	Dynamics	79
6.6.1	Compressor.....	79
6.6.2	Gate/Expander	81

- 6.7 Snapshots 82
 - 6.7.1 PROTECT 83
 - 6.7.2 CLEAR 84
 - 6.7.3 STORE 84
 - 6.7.4 RECALL..... 84
 - 6.7.5 Snapshot Filtering 84
- 6.8 Aux Master 85
- 6.9 Groups/Auxes 86
 - 6.9.1 GROUPS 86
 - 6.9.2 AUXES 86
- 6.10 Matrix Mix..... 87
 - 6.10.1 Delay 89
- 6.11 Effects 90
- 6.12 Setup..... 90
 - 6.12.1 Operation 91
 - 6.12.2 General 91
 - 6.12.3 Digital 92
- 6.13 Utility 93
 - 6.13.1 MONITOR SOURCE..... 94
 - 6.13.2 TALKBACK..... 95
 - 6.13.3 STEREO INPUT ASSIGN 95
 - 6.13.4 METERING 96
- 6.14 File Management 97
 - 6.14.1 Load and Save Venue..... 97
 - 6.14.2 DSP Preset Management..... 98

Appendix A: Specifications 99

Appendix B: Configurations and Block Diagrams 103

Appendix C: Service Information 107

Appendix D: Warranty Information 111

This manual is based on Build 41 so some screenshots and functions may differ from the version you are using. Regular updates to the manual will be available from www.mackie.com.

Web Version: SW0135 Rev. A 01/05
©2005 LOUD Technologies Inc.
All Rights Reserved.

Chapter 1: Introduction

1.1 Evolution of the TT24 Console

The professional live sound industry has been revolutionized over the past few years by high-end digital consoles. However, mid-size digital consoles have tended to emphasize studio applications with user interfaces encumbered by features (i.e., DAW control) not essential for live applications. Some of these consoles conceal their real cost by requiring the purchase of additional cards to supplement their limited physical I/O.

The *TT24 Digital Live Console* is a mid-size digital mixer with an intuitive interface optimized for live sound applications. We have used our extensive expertise and experience designing analog mixers to produce a powerful, easy-to-use digital console for a wide range of applications and budgets:

- theaters and houses of worship
- permanent concert installations
- professional live music touring companies

TT24 maintains an “analog mentality,” utilizing the engineer’s experience, while providing all the advantages of digital functionality. With all the features of high-end consoles, the TT24 is extremely cost effective.

The design mandate for the TT24 console user interface is simply stated:

Provide quick, intuitive access to any primary live mixing function with no more than two button presses, both within easy reach of the engineer’s two hands.

Make the Touchscreen menu structure flat: no “forward” and “back” buttons or menus to wade through to access the desired function.

1.2 Summary of Features

- 24-bit/96 kHz mixing console designed for live applications
- 24 mic/line inputs with 4-band EQ/comp/gate/HPF/polarity invert (can be stereo linked)
- Eight line inputs with 4-band EQ (can be stereo linked)
- Instant recall of 99 snapshots with filtering
- Rear panel connections: **36x28 analog I/O** (24 Mic/Line Inputs, 8 Line Inputs, 4 Tape Inputs) x (8 Matrix Outputs, 3 Main Outputs, 3 Monitor Outputs, 12 Aux Sends); **28x28 digital I/O** (24 ADAT optical I/O, 2 AES/EBU I/O, 2 S/PDIF I/O)
- QuickMix section with 5.5-inch touch LCD, 12 push-button rotary encoders, and QuickMix buttons
- 29 100-mm motorized faders
- 28 multi-function V-Pots
- 12 Aux sends with 6-band parametric EQ (includes dual kill filters) and compressor/limiter
- Left-Right and CTR/Mono outputs with 6-band parametric EQ (includes dual kill filters) and compressor/limiter
- Aux Mode enables instant monitor mixing
- 11x8 Matrix-Plus with patchable inputs
- Eight user-definable flex-groups
- Dual-console linking for a maximum 96 input console (coming soon!)
- TT control software to control and view console parameters via PC

1.2.1 DSP Functionality

The TT24 is loaded with DSP horsepower that is distributed on inputs and outputs in an optimal manner for live sound. The TT24 design team spent a great deal of time implementing and allocating the TT24's DSP to satisfy the rigorous, real-time demands of live concert applications:

24 Mic/Line Inputs

- Polarity invert
- Variable High-Pass Filter
- Gate/Expander
- Compressor/Limiter
- 4-band parametric EQ
- Stereo linking

8 Line Inputs

- 4-band parametric EQ
- Stereo linking

Main Outputs (LEFT, RIGHT, CTR/MONO)

- Compressor/Limiter
- 6-band parametric EQ (includes dual kill filters)
- **L/R + Mono** or **LCR** modes of operation

12 Aux Sends

- Compressor/Limiter
- 6-band parametric EQ (includes dual kill filters)
- Stereo linking

8 Flex-Groups with 8 Assignable DSP Blocks

- Compressor/Limiter
- 4-band parametric EQ
- Mono, Stereo, LCR, and VCA modes of operation

8 Matrix Outputs

- 600 ms delay is available to matrix outputs

4 Internal Stereo Effects

- Reverb
- Gated Reverb
- Mono/Stereo/Ping-Pong Delay
- Chorus
- Flanger

1.3 Terminology and Conventions

The following terms and conventions are used throughout this manual.

- Touchscreen and console controls are represented in bold type using their exact spelling and capitalization (i.e., press the **ANLG** bank button).
- Touchscreen and console areas are represented by capital letters in plain type (i.e., press the **PAN** button in the V-POT CONTROL area).
- *Activate* pertains to switches/buttons that toggle between two values and means “press the button until it lights.”
- *Deactivate* pertains to switches/buttons that toggle between two values and means “press the button until it is not lit.”
- *ADC* means analog-to-digital converter
- *DAC* means digital-to-analog converter
- *Intercancel* means that pushing one button simultaneously selects that button and automatically deselects the previously selected button. One button is always active. For example, the Bank Select buttons intercancel. *Radio button* is another term often used to describe this behavior, originating from the push buttons that selected radio stations in pre-1960s cars.

The Touchscreen is a new interface to most audio engineers that requires some new terminology.

- *Touch* pertains to selection on the Touchscreen (i.e., Touch the **EQ** button).
- *Select* describes touching a button or checkbox such that it is *activated*. This allows a single instruction to describe this action without knowing the control's previous state. For example, if the control is *not* selected, touching the control once selects it. If it is already selected, no action is required.

Chapter 2: Quickstart Tutorial

This Quickstart Tutorial will help you begin using the TT24 quickly and easily by providing step-by-step instructions for its most commonly utilized tasks. Rest assured that our team of design engineers has verified these instructions!

It may be helpful to refer to Appendix B: *Configurations and Block Diagrams* to see how several useful complete systems are interconnected.

2.1 Connect Amplifier/Speakers

1. Plug in a pair of amps/speakers into the **MAINS OUT LEFT** and **RIGHT** XLR connectors (Figure 2-1).
2. Connect an amp/speaker to **AUX SEND 1**.
3. Plug in headphones.

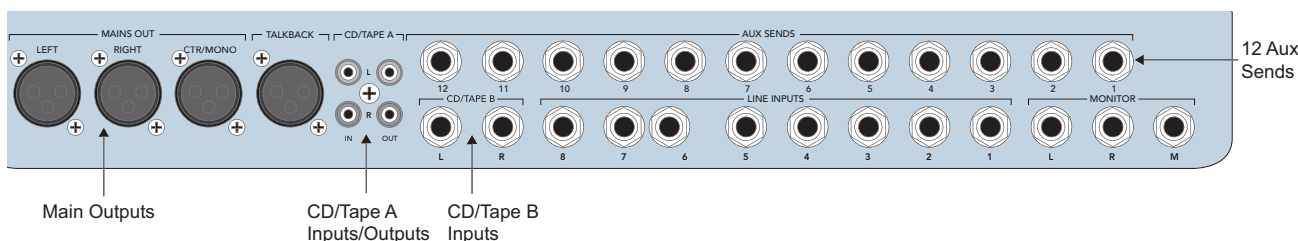

Figure 2-1 Mains and Aux Sends Outputs

2.2 Connect a Mic

This section describes how to connect a mic to channel 1, set the gain, route to groups/auxes, and engage/adjust the variable high-pass filter.

Connect mic to channel 1

1. Plug a mic into channel 1's XLR input (top-right of rear panel).
2. Press the **ANLG** bank select button (right of Figure 2-2).
3. Set the **LINE** switch to the up (mic) position.

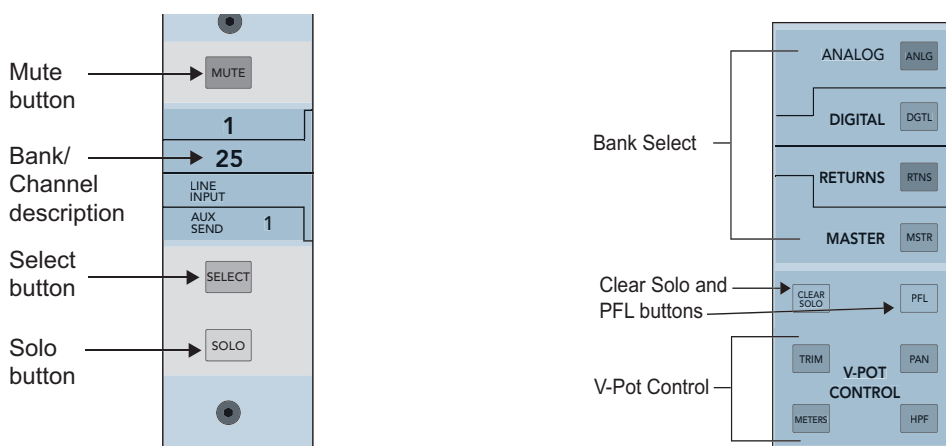

Figure 2-2 Top of channel strip (left); Bank Select, Clear Solo, PFL, V-Pot control (right)

4. Set the **48V** switch to the *down* position if the mic uses phantom power; set it to the *up* position otherwise.

Set the channel gain

5. Activate the **PFL** button (right of Figure 2-2).
6. Activate channel 1's **SOLO** button (above fader) to solo the channel.
7. Provide a representative signal to the mic, watch the meters to the right of the Touchscreen, and listen in phones (the phones level is in the **UTILITY** area).

The solo level should be between -7 and -10 dBFS.

8. Press channel 1's **SOLO** button again or **CLEAR SOLO** (left of **PFL**) to unsolo.

Route channel 1 to Main output, Group 1, and Aux 1

9. Press and hold the **L/R** button in the **GROUP ASSIGN** area (Figure 2-3) and activate channel 1's **SELECT** button.

All the channel **SELECT** buttons light, indicating that all channels are routed to the Main output. You should hear your mic in the speakers connected to **MAINS OUT** via the master fader.

Let's route the mic through Group 1 instead of directly to **MAINS OUT**:

10. Press and hold the **L/R** button in the **GROUP ASSIGN** area and deactivate channel 1's **SELECT** button (so it is *not* lit).

Channel 1 no longer sends signal to **MAINS OUT**.

11. Press and hold the **Group 1** button in the GROUP ASSIGN area and activate channel 1's **SELECT** button.

The mic is now routed to Group 1.

12. Press and hold the **L/R** button in the GROUP ASSIGN area and activate Group 1's **SELECT** button.

Group 1 is now assigned to **LEFT** and **RIGHT MAINS OUT**.

Use the channel, Group, and Master fader to listen to the mic signal in the speakers connected to **MAINS OUT**.

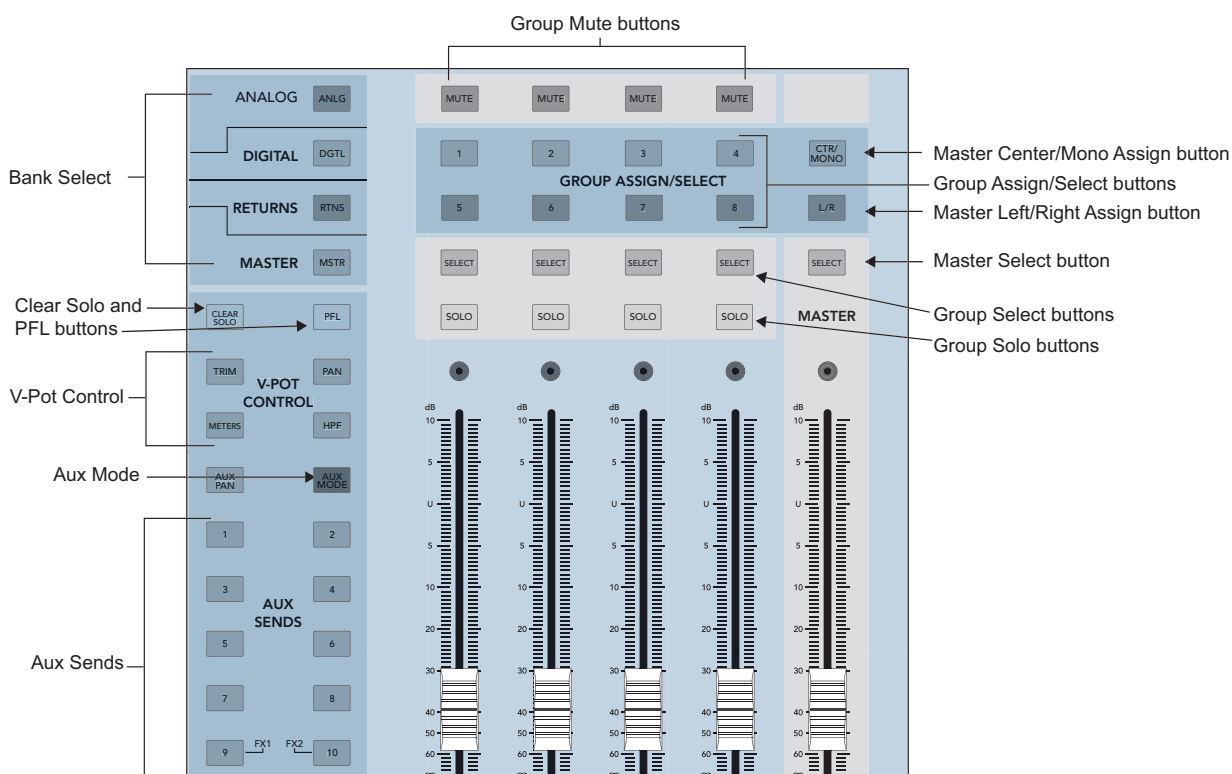

Figure 2-3 Aux, Group, and Master areas

13. Press **AUX SENDS 1** in the V-POT CONTROL area (Figure 2-3).
14. Increase the Aux 1 level on channel 1 using the V-Pot.
15. Press the **AUX MSTR** QuickMix button (Figure 2-4).
16. Adjust Aux 1's master level with its corresponding QuickMix knob (see the Aux Master screen in Figure 2-5).

You should hear your mic in the monitor speaker attached to Aux 1.



Figure 2-4 QuickMix area

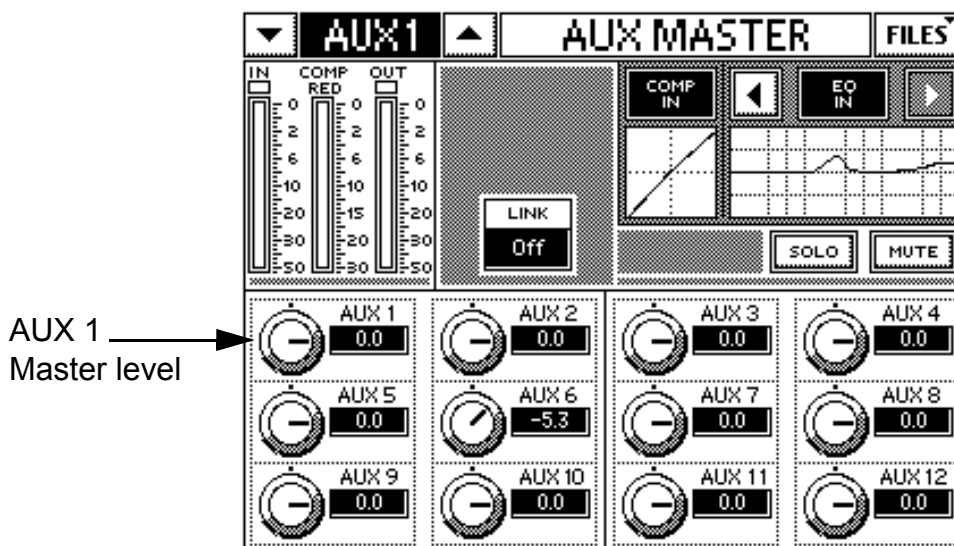

Figure 2-5 AUX MASTER Touchscreen

Engage and adjust the variable high-pass filter

17. Press **HPF** in the V-POT CONTROL area (Figure 2-2).

This assigns the high-pass filter to the channel V-Pots.

18. Engage the high-pass filter for channel 1 by pressing its V-Pot knob so the bottom red LED lights.
19. Rotate the V-Pot to adjust the filter in the range 20–400 Hz to remove unwanted low frequencies.
20. To view the frequency range, select channel 1 and press the QuickMix **EQ** button.
The Touchscreen now displays the HPF frequency range.

2.3 Connect a CD/Tape Device

This section illustrates how to connect a CD/tape device to the dedicated **CD/TAPE A** or **B** connectors (A = RCA, B = TRS), and to channels 23/24 to demonstrate stereo linking and channel strip processing.

Connect CD to CD/Tape input

1. Connect the CD player into CD/TAPE A or B (Figure 2-1).
2. Press the **UTIL** button (Figure 2-4).

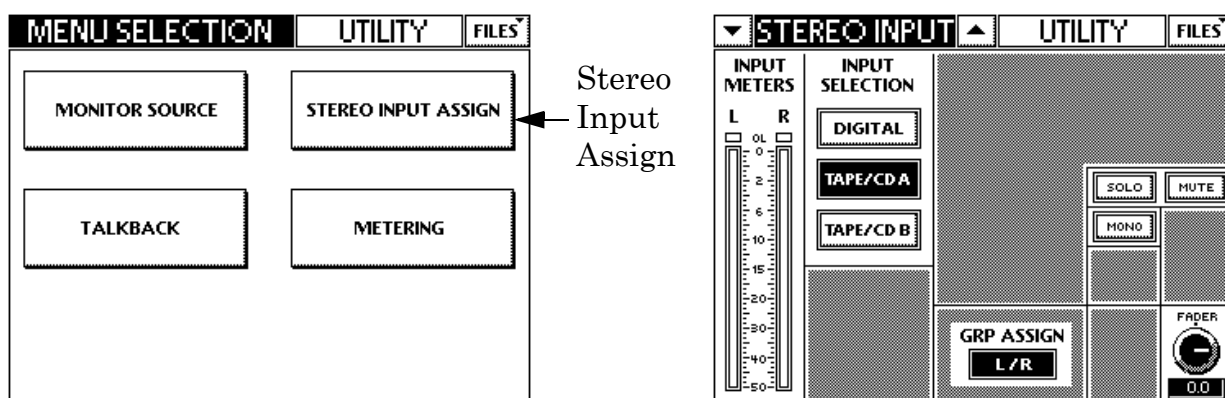

Figure 2-6 Stereo Input Assign

3. Touch **STEREO INPUT ASSIGN** on the Touchscreen (Figure 2-6).
4. Touch **TAPE/CD A** or **TAPE/CD B** in the **INPUT SELECTION** area (Figure 2-6).
5. Select **L/R** in the **GRP ASSIGN** area to route the stereo source to the **LEFT** and **RIGHT MAINS** outputs.
6. Adjust **MUTE** and **SOLO** from the Touchscreen.
7. Adjust the stereo input fader to desired level from its QuickMix knob.

Connect CD to channels 23 and 24

1. Move the CD to the channel 23 and 24 **LINE** connectors.
2. Set the **LINE** switch to the down position (line level).
3. Press and hold channel 23 *and* 24's **SELECT** switches until the **Link Channels** dialog appears in the Touchscreen.
4. Touch **OK** to approve the channel linking.
5. Press the **PAN** button in the V-POT CONTROL area (Figure 2-3).

6. Turn channel 23's V-Pot hard left.
Channel 24 automatically pans in the opposite direction. Pretty cool!
7. Activate the **SOLO** button above the fader on either channel to solo.
Because PFL is engaged, the linked channel *does not* also solo.
8. Adjust the channel's **GAIN** knob and watch the meters to the right of the Touchscreen.
The level should be between -7 and -10 dBFS.
9. Repeat steps 7 and 8 for the other channel in the linked pair.

NOTE: Stereo linking always operates on a consecutive odd/even channel pair. The odd channel's parameters are copied to the even channel except Pan, which is inversely linked (i.e., hard left on odd channel translates to hard right on even channel).

Adjust EQ, Dynamics, and channel routing

1. With channel 23 and 24 selected, press the **EQ** button in the QuickMix area to display the 4-BAND EQ Touchscreen (Figure 2-7).
2. Select the **EQ IN** toggle switch to enable EQ.
3. Use the 12 QuickMix knobs to adjust the EQ parameters.

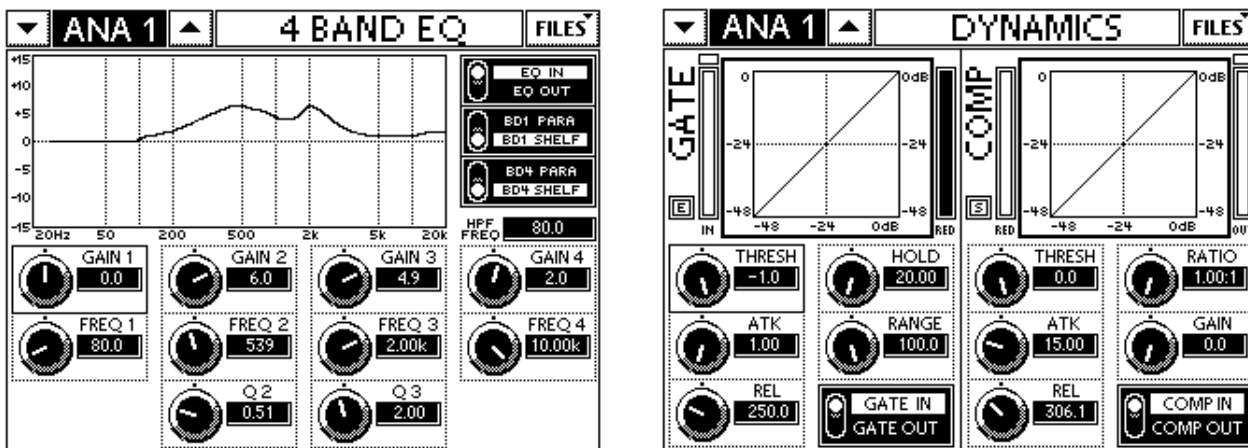

Figure 2-7 4-BAND EQ (left) and Dynamics Touchscreens

4. Press the **DYN** QuickMix button to display the DYNAMICS Touchscreen (Figure 2-7).
5. Select the **GATE IN** and **COMP IN** toggle switches on the Touchscreen to engage the processors.

6. Use the 12 QuickMix knobs to adjust the dynamics parameters.
Touch the Gate or Compressor Touchscreen graph to display their more detailed Touchscreen.
7. Press the **GRP/AUX** QuickMix button to display the GRPS/AUXES Touchscreen (Figure 2-8).
8. Route the selected channel to Groups 1–8, L/R, and C/Mono by selecting their buttons from the GROUPS area in the top-half of the Touchscreen.
9. Adjust the selected channel's Aux send levels using the QuickMix knobs.

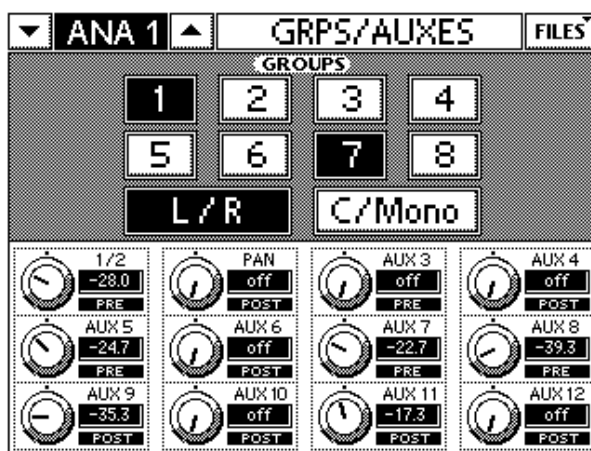

Figure 2-8 GRPS/AUXES Touchscreens

10. Push the QuickMix knobs to toggle each Aux send between pre- and post-fader.

2.4 Aux Functions

This section discusses how to setup, route, and mix the Aux buses. Each of the 12 Aux masters have their own EQ and compressor/limiter.

1. Press the **AUX MSTR** button (Figure 2-4) to display the AUX MASTER Touchscreen.
2. Select Aux master 1 by pressing the top-left QuickMix knob.
Figure 2-9 (left) shows Aux 1 selected.
3. Touch the EQ graph or press the **EQ** QuickMix button to display the 6-BAND EQ for the selected Aux send 1 (right of Figure 2-9).

The **EQ IN/OUT** button is located on the top-right of the Touchscreen.

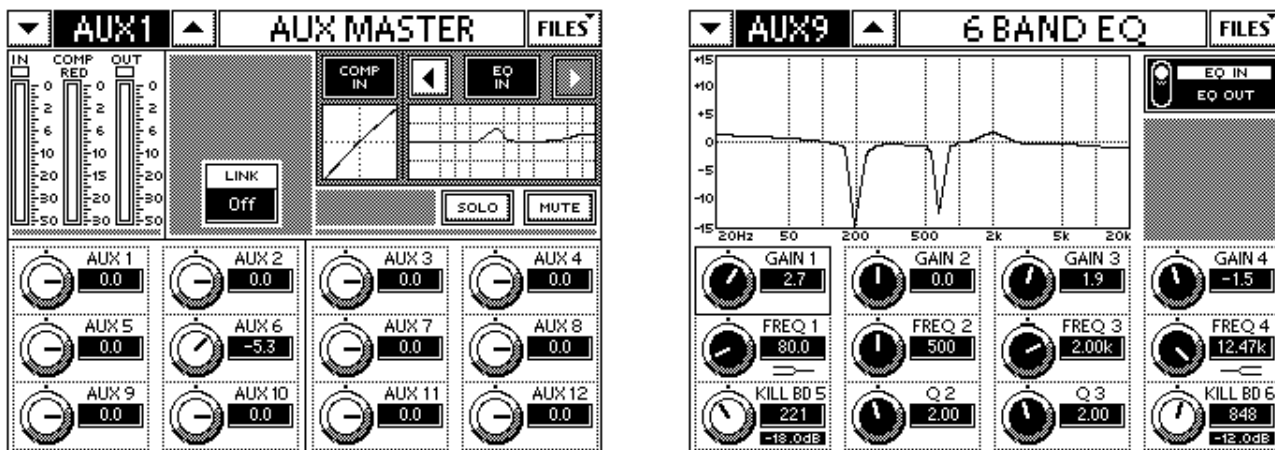

Figure 2-9 AUX MASTER (left) and 6-BAND EQ (right) Touchscreens

The six bands have the following format:

- bands 2 and 3 are full parametric filters (GAIN, FREQ, Q);
- bands 1 and 4 are high- and low-shelf filters, respectively;
- bands 5 and 6 are kill filters to remove narrow bands of unwanted frequencies. Push the kill filter’s QuickMix knob to cycle through -6, -12, or -18 dB settings. As the amount of cut increases, the filter Q increases (i.e., bandwidth narrows). Turn the knob to adjust the frequency.

Press the desired Aux number in the V-POT CONTROL area and use the channel V-Pots to set the channel Aux send levels. All 12 Aux levels for a selected channel can be set using the Touchscreen and QuickMix knobs by pressing the GRP/AUX QuickMix button.

Aux Routing Examples

To send mic channel 1 to all monitors:

1. Press channel 1’s **SELECT** button.
2. Press the **GRP/AUX** QuickMix button.
3. Adjust the QuickMix knobs to set each Aux level.

To set one monitor mix:

1. Press the desired Aux number button in the AUX SENDS area.
2. Use each channel’s V-Pots to set the mix.

2.5 Effects

Four effects processors can each use one of the following effects: reverb, reverb through gate, mono/stereo/ping pong delay, chorus, and flange. The default effect sends are Aux sends 9–12 but any Aux or Matrix sends can be used. The effect returns are on the Returns bank.

1. Press the **ANLG** bank button.
2. Press **AUX SENDS 9** in the V-POT CONTROL area.
3. Turn channel 1’s V-Pot to 3:00 to set channel 1’s level to Aux 9.
4. Press the **EFX** QuickMix button.

The INTERNAL EFX Touchscreen opens (left of Figure 2-10).

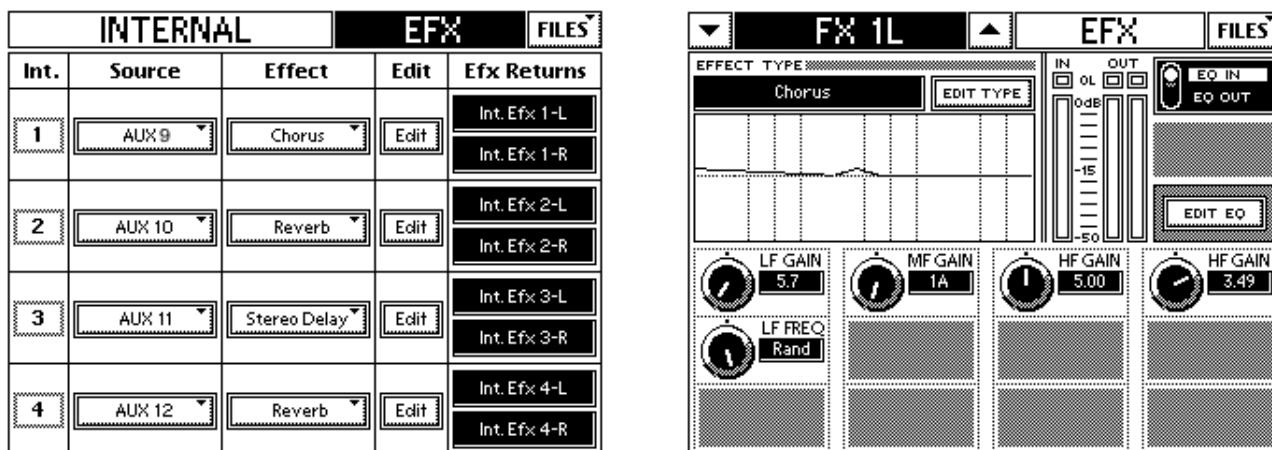

Figure 2-10 Internal Effects and Chorus screens

5. Touch the **Edit** button next to Chorus to edit its parameters on its own screen (right of Figure 2-10).
6. Press the **RTRNS** bank button.
7. Speak into the mic and increase the Returns levels (INT EFX 1L and INT EFX 1R) to set the desired amount of effect.

Chapter 3: Console Surface Controls

The TT24 console surface is organized into the following areas, each of which is discussed in this chapter:

- Channel Strips
- QuickMix
- Bank Select
- V-Pot Control
- Utility
- Flex-Groups and Master
- Solo

3.1 Channel Strip

The TT24 has 24 *channel strips* bounded at the bottom by a fader and at the top by a **LINE** switch. Each channel strip can control one input at a time from one of four banks.

The top section of each channel strip (left of Figure 3-1) has the following analog controls that apply only to the Analog bank: **LINE** mic/line input switch, **48V** phantom power switch, **GAIN** mic/line gain control, and **OL** (overload) and **SIG** signal LEDs.

Below that, each channel has a virtual potentiometer (V-Pot), **MUTE**, **SELECT**, and **SOLO** buttons, and a 100-mm motorized fader (right of Figure 3-1).

The V-Pot knob, which performs multiple channel functions one at a time, consists of a push-button rotary encoder surrounded by a 15-segment LED ring (see *V-Pot Control Area* on page 29).

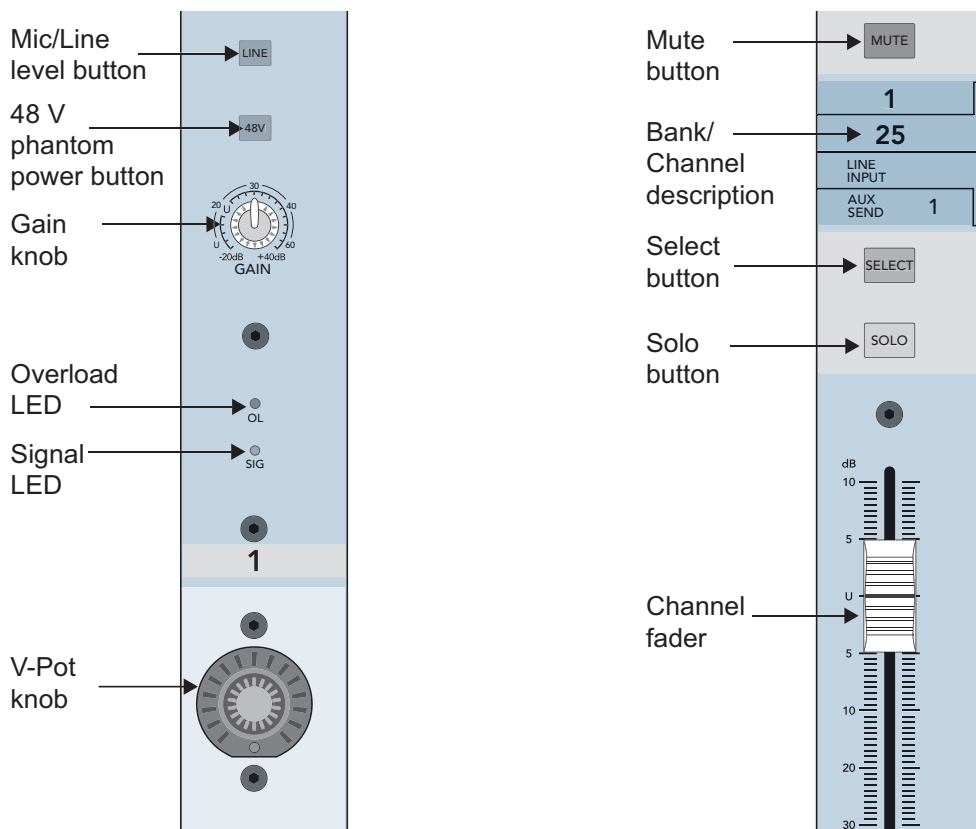

Figure 3-1 Channel strip: top-half (left), bottom-half (right)

3.1.1 LINE

Push the **LINE** button *down* to access the 1/4-inch line input and *up* for the XLR mic input. For permanent installations that require alternate access to mic and line inputs in the same channel, connect both inputs and toggle between them via the **LINE** button.

3.1.2 48 V Phantom Power

Push the **48V** button *down* to supply 48 VDC phantom power, required by most condenser mics, to the channel's XLR mic input. The TT24 can provide phantom power to all 24 mic inputs simultaneously. Push the button *up* for dynamic mics that do not require phantom power. The line input is not affected by the **48V** phantom power switch.

3.1.3 GAIN

The **GAIN** knob controls the analog amplifier that adjusts the input sensitivity of the mic or line input signal. The gain range of the mic input is 0–60 dB; the line's range is -20 to +40 dB. A unity gain indication for the line input appears at the 10:00 position (unity gain for the mic input is fully counterclockwise). Dual-concentric labels surround the knob indicating the appropriate levels (mic outside, line inside).

3.1.4 OL and SIG

The green **SIG** LED lights when the selected mic/line signal exceeds -15 dBu. The red **OL** LED lights when the signal is 3 dB below clipping the ADC. The **SIG** and **OL** LEDs remain lit only while the signal level is above their corresponding thresholds.

3.1.5 V-Pot

The V-Pot displays and controls one of the following functions at a time: pan, HPF, Aux send levels, Aux pan (for linked Aux sends), digital trim, and channel metering. The function is assigned from the V-POT CONTROL area.

The V-Pot has 15 LEDs in a ring from 7:00 to 5:00. They light clockwise as the signal level increases unless otherwise noted. The V-Pot also has a bottom red LED used to indicate different functions including meter clip, default settings, on/off, etc. The 12:00 LED is also sometimes used to indicate a nominal setting (i.e., pan set to center). Each function's specific behavior is discussed in *V-Pot Control Area* on page 29.

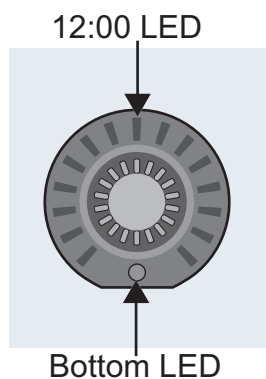

Figure 3-2 V-Pot

3.1.6 MUTE

Push the **MUTE** button to toggle the channel between muted (button lights) and enabled (not lit).

NOTE: *Pre-fader Aux sends can be globally changed to pre- or post-mute from the SETUP-GENERAL Touchscreen (see page 91).*

3.1.7 Bank/Channel Description Area

This area indicates the audio signal currently controlled by the channel strip. Each channel strip can control one channel from one of the four banks at any given time. For example, Figure 3-1 illustrates channel strip 1. Four channel names are listed in the Bank/Channel Description Area:

- If the ANALOG bank is selected, strip 1 controls analog Channel 1.
- If the DIGITAL bank is selected, strip 1 controls digital Channel 25.
- If the RETURNS bank is selected, strip 1 controls Line Input 1.
- If the MASTERS bank is selected, strip 1 controls Aux Send 1.

3.1.8 SELECT

When lit, the **SELECT** button indicates this channel is selected for:

- display and control of its parameters on the Touchscreen.
- assignment to groups in conjunction with the GROUP ASSIGN/SELECT controls (see *Group and Master Controls* on page 40).

Channel Linking

Pressing and holding the **SELECT** buttons on an odd/even pair of *adjacent* channels for two seconds links their functions. A Touchscreen window requests confirmation: “Link Channel X and Y?” Touch **YES** to link the channels or **CANCEL** to abort the process. To unlink channels, press and hold both **SELECT** buttons for two seconds again. A Touchscreen window requests confirmation: “Unlink Channel X and Y?” Touch **YES** to unlink them or **CANCEL** to leave them linked.

After linking, the odd channel's settings are copied to the even channel; adjusting a setting on either channel duplicates the setting on the other. The only exception to this rule is panning. The pans are *inversely* related between linked channels: Panning one channel fully left pans the other fully right; panning one channel to 10:00 pans the other to 2:00.

True stereo compression applies to linked channels so the summed signal is delivered to the stereo compressor.

3.1.9 SOLO

Press the **SOLO** button to solo the channel. This yellow backlit button lights when the channel is soloed. The PFL/AFL global selection is done in the Solo master section (see *Solo Area* on page 41).

The default Solo behavior is to allow multiple soloed channels. However, enable **EXCLUSIVE SOLO** mode (in the SETUP-GENERAL Touchscreen) to have each Solo selection deactivate the previous one. In **EXCLUSIVE SOLO** mode, pressing **CTRL+SOLO** solos additional channels.

3.1.10 Channel Fader

The motorized 100-mm fader controls the channel level. Its function depends on the selected Bank (see *Bank Select Area* on page 28).

In Aux Mode (page 32), the fader controls the level of the channel Aux sends 1–12 and depends on the Aux selection in the V-POT CONTROL area (see page 29). It is variable from $-\infty$ to +10 dB in logarithmically scaled steps.

3.2 Bank Select Area

The four Bank Select buttons (**ANLG**, **DGTL**, **RTNS**, **MSTR**) change the mapping to the 24 channel strips (Figure 3-3). The four buttons intercancel and one is always active. All channels retain their settings between Bank changes.

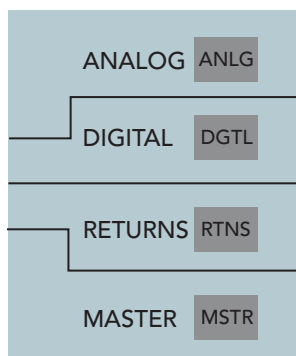

Figure 3-3 Bank Select buttons

3.2.1 ANALOG

Press the **ANLG** button to select the ANALOG bank. The button lights red and the 24 analog mic/line inputs are assigned to channel strips 1–24.

3.2.2 DIGITAL

Press the **DGTL** button to select the DIGITAL bank. The button lights green and the DIGITAL inputs are assigned to the channel strips 1–24.

At 44.1/48 kHz, there are 24 digital inputs from three ADAT optical connectors on the rear panel. At 96 kHz, there are 12 digital inputs from the three built-in ADAT optical connectors.

3.2.3 RETURNS

Press the **RTRN** button to select the RETURNS bank. The button lights red and the following inputs are controlled on the channel strips:

- 1–8: Eight analog line inputs (TRS connectors on rear panel)
- 9–16: Four internal stereo effects returns
- 17–24: Return channels from expansion cards

3.2.4 MASTER

Press the **MSTR** button to select the MASTERS bank. The button lights green and the following inputs are controlled on the channel strips:

- 1–12: Twelve Aux send masters
- 13–20: Eight Group masters
- 22–24: Left, Right, and Center/Mono Main outputs

NOTE: *The Left and Right faders are always linked. The Left-Right and Center/Mono faders may be linked as needed.*

3.3 V-Pot Control Area

The buttons to the right of the channel faders assign the current function to the channel V-Pots. These include the four V-POT CONTROL buttons (**PAN**, **TRIM**, **METERS**, **HPF**), **AUX SENDS 1–12**, and **AUX PAN** (see Figure 3-4). These buttons all intercancel so only one can be active at a time.

AUX PAN operates for stereo-linked Aux sends only, and does not deselect the selected Aux send button. When selected, a single LED illuminates around the V-Pot to indicate the pan position.

The **AUX MODE** button is discussed in this section because of its relevance to the other Aux buttons. *However, it does not intercancel with the other buttons.*

3.3.1 TRIM

Digital Trim, available only to the ANALOG bank, is used to adjust the input level just after the ADC, and channel meter, and before the channel DSP. This allows setting the analog gain for the optimal A/D conversion while still having an adjustable input level to the channel DSP. This also provides a method to lower the level of all channel outputs and sends at once: Digital Trim is before the Aux and Group sends in the signal flow.

The Digital Trim provides ± 15 dB of attenuation or gain, adjustable in 0.1 dB increments and is indicated by a single, lit LED. When the Digital Trim is set to unity, the top LED (12:00 position) and the bottom V-Pot LED illuminate.

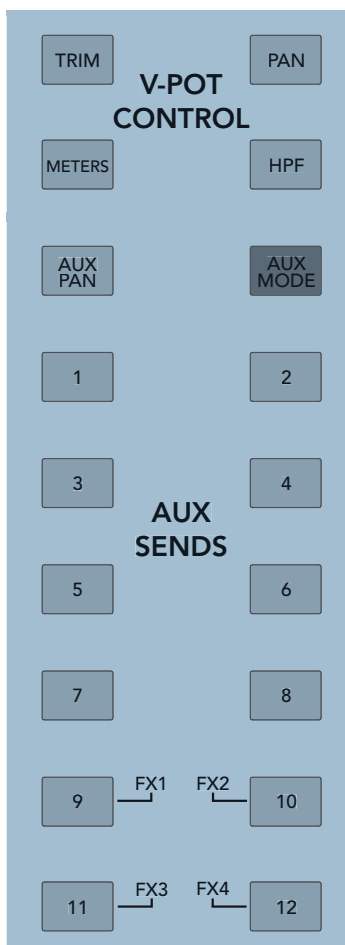

Figure 3-4 V-Pot Control Area

3.3.2 PAN

Pan position is indicated by a single, lit LED. When the pan is exactly centered, the top LED (12:00 position) *and* the bottom V-Pot LED illuminate.

LR or LCR panning is available on the ANALOG, DIGITAL, and RETURNS banks and the eight groups (mode dependent) of the MASTER bank.

3.3.3 HPF

The high-pass filter can remove unwanted low frequencies from an input channel. The filter cutoff frequency range is 20–400 Hz; the default frequency is 80 Hz. The HPF has a fixed slope of 18 dB/octave. The approximate frequency is indicated by a single lit V-Pot LED (frequency increases clockwise). Push the V-Pot to toggle the HPF on/off; the bottom red LED lights when the HPF is on. Press the **SELECT** button on an individual channel, then press the **EQ Quick-Mix** button to see the HPF frequency range as you turn the V-Pot.

3.3.4 METERS

The V-Pot LEDs serve as a meter (indicating left to right) for the channel's signal level. The bottom, red LED illuminates to indicate digital clipping (0 dBFS).

Push the V-Pot knob to toggle the meter to show compressor reduction: the LEDs now illuminate *counterclockwise* (the knob controls the compressor threshold setting). The bottom, red LED lights continuously to indicate the compressor reduction mode of the meter. This can be activated individually per channel. Press and hold the **METERS** button in the V-POT CONTROL area for two seconds to toggle the meter modes for all channels between channel level and compressor gain reduction.

3.3.5 AUX SENDS 1–12

The Aux send level for the channel is indicated by multiple, lit LEDs. The level is variable from $-\infty$ to +10 dB in logarithmically scaled steps. LEDs light from left to right as the Aux send level increases. The maximum Aux send level is indicated by all the V-Pot LEDs lit. When the Aux send is set to unity (approximately 3:00), the bottom V-Pot LED illuminates.

Rotate the V-Pot to control the selected send level for that channel. Push the V-Pot to toggle the send pre-/post-fader.

Press and hold consecutive Aux buttons in the V-Pot Control area to link them for stereo operation. For example, press and hold Aux 1 and 2, and the Touchscreen displays "Link Aux Sends Aux 1 and Aux 2?" Touch **OK** to complete the operation. Aux levels are copied from odd to even Auxes when linking Aux sends. After linking, adjusting one aux also adjusts the other. Pressing either **AUX SENDS** button of a linked pair controls the stereo level from the V-Pots and both **AUX SENDS** buttons light. All Aux send DSP is also linked.

3.3.6 AUX PAN

Aux pan is indicated for stereo-linked Aux sends by a single LED lit to illustrate the pan position. When the Aux pan is set to center, the top (12:00 position) and bottom V-Pot LEDs light.

Rotate the V-Pot to control the panning of stereo linked Aux sends. **AUX PAN** does not intercancel with the other V-Pot control knobs. When **AUX PAN** is selected, the panning function corresponds with the selected stereo Aux Sends. The pan for linked Aux sends varies inversely: setting one to 9:00 automatically sets the other to 3:00. If a mono Aux send is selected along with **AUX PAN**, then no stereo position is displayed on the V-Pot LEDs. Press **AUX PAN** again to return to normal Aux send level operation.

3.3.7 AUX MODE

AUX MODE, the only blue button on the console, effectively turns the TT24 into a powerful, dedicated monitor mixer by using the 24 channel faders as channel Aux sends and the four Group faders as Aux masters. Select an **AUX SENDS** button (it flashes) and each channel fader is then used to control that channel’s Aux send level.

In **AUX MODE**, the Group faders represent Aux Send masters 1–12 in three banks:

Table 3-1 Group Faders control Aux Master Sends in AUX MODE

	Group Fader 1	Group Fader 2	Group Fader 3	Group Fader 4
AUX SENDS 1–4	1	2	3	4
AUX SENDS 5–8	5	6	7	8
AUX SENDS 9–12	9	10	11	12

For example, if **AUX SENDS 3** is selected, it flashes while **AUX SENDS 1, 2,** and **4** are lit solid to show their masters are assigned to the Group faders. For linked Aux sends, both **AUX SENDS** buttons flash when either button is pressed while the other two in that bank are lit solid.

The **TRIM, METERS, HPF, PAN,** and **AUX PAN** buttons operate normally and still change the function of the V-Pots.

GROUP ASSIGN buttons do not light in banks of four in **AUX MODE**. However, pressing and holding a GROUP ASSIGN button still allows Group assignment.

NOTE: See *Group and Master Controls* on page 40 for information on the normal operation of the Group faders.

3.4 QuickMix Area

The QuickMix area (Figure 3-5) consists of the Touchscreen, 12 push-button rotary encoders and eight buttons. It also includes Snapshot control buttons, **RUDE SOLO LED, L/R** and **C/MONO** meters, and the Engineer’s Utilities area.

It is important to note:

- The only adjustable controls on the Touchscreen are buttons that toggle a value on/off and dropdown menus that allow a selection. All knobs represented on the Touchscreen are controlled by corresponding QuickMix knobs. If any of the 12 knobs are missing from the Touchscreen, the corresponding QuickMix knob has no function.
- Any Touchscreen knob colored white instead of black denotes a dual function available by pushing the corresponding QuickMix knob. The function varies with the control.

The QuickMix buttons on the left are: **FAT**, **EQ**, **DYN**, and **GRP/AUX**.

The QuickMix buttons on the right are: **AUX MSTR**, **SNAP**, **EFX**, and **MATRIX**.

Each QuickMix button displays a Touchscreen for the selected channel. If the selected channel does not contain the selected function (i.e., Digital Inputs have no EQ), the Touchscreen displays “This Channel Does Not Contain XX” until another Touchscreen is accessed. The Touchscreens are discussed in Chapter 6: *Touchscreen and TT Control*.

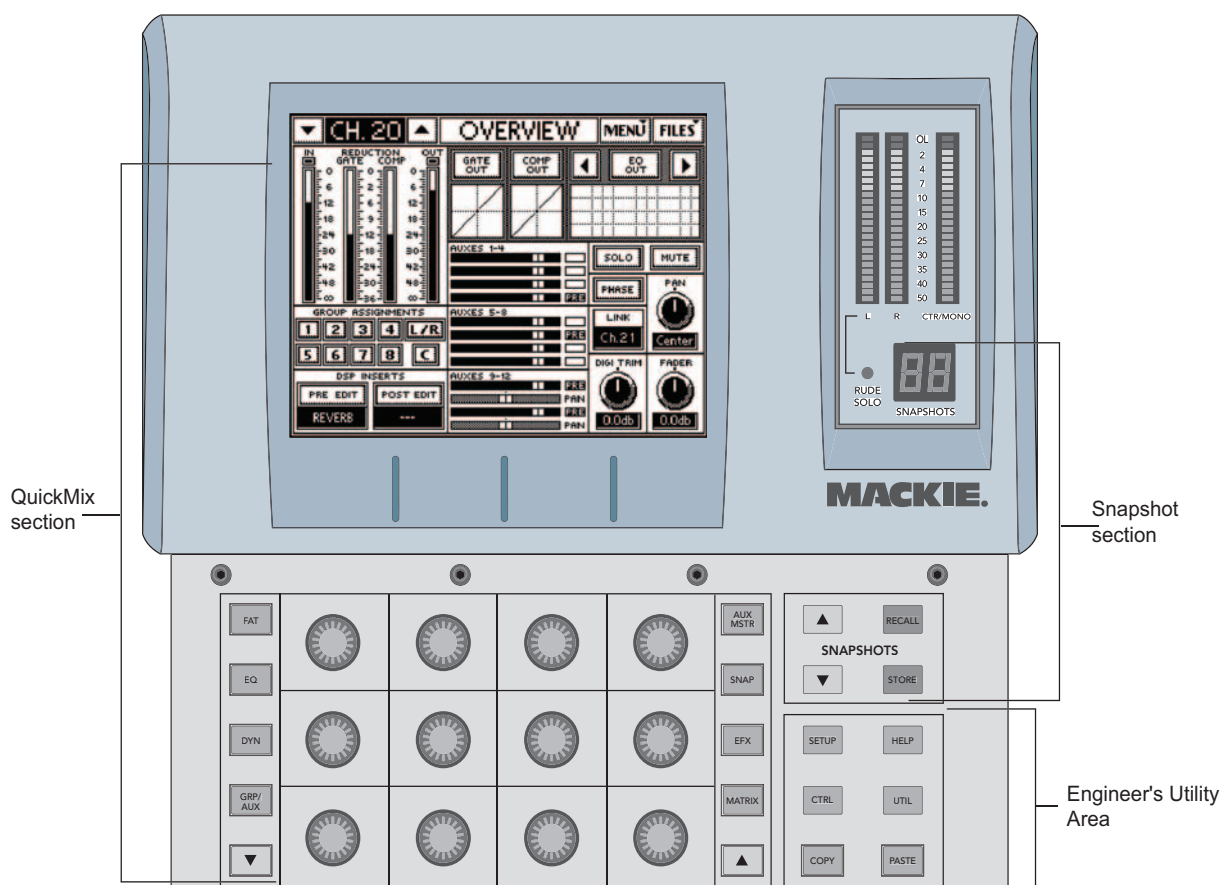

Figure 3-5 QuickMix Section

3.4.1 FAT

Press the **FAT** button to display the selected channel's OVERVIEW Touchscreen with all channel settings and meters. Although not all parameters can be adjusted from the OVERVIEW screen, touching a non-adjustable parameter opens its dedicated screen (i.e., touch the EQ graph to open the EQ Touchscreen).

The specific information displayed and adjusted from the OVERVIEW screen depends on the selected channel type: Analog, Digital, Line, Effect Return, Group, Master, and Aux (see *Overview Touchscreens* on page 68).

3.4.2 EQ

Press the **EQ** button to display the selected channel's EQ Touchscreen. Depending on the channel type, it will be either:

- 4-BAND EQ: Four parametric EQ filters for Input Channels and Group Masters.

See *Four-Band Equalizer* on page 76 for more information.

- 6-BAND EQ: Two parametric EQ filters, high- and low-shelf filters, and two narrow-band kill filters for Aux Masters and Main Outputs (L/R and C/Mono).

See *Six-Band Equalizer* on page 78 for more information.

3.4.3 DYN

Press the **DYN** button to display the selected channel's DYNAMICS (Analog channel) or COMPRESSOR (Aux Send Masters, Groups, and Main Outputs) Touchscreens. The DYNAMICS Touchscreen has the Gate/Expander and Compressor settings and their associated meters. Touch the Gate or Dynamics graphs to open their dedicated Touchscreens (although most parameters can be accessed from the DYNAMICS Touchscreen).

See *Dynamics* on page 79 for complete details.

3.4.4 GRP/AUX

Press the **GRP/AUX** button to display the GRPS/AUXES Touchscreen. Touch a GROUPS assignment button to assign the selected channel to that Group. The QuickMix knobs adjust the selected channel's level to the 12 Aux Sends. Push a QuickMix knob to toggle that Aux Send pre- or post-fader.

See *Groups/Auxes* on page 86 for more information.

3.4.5 AUX MSTR

Press the **AUX MSTR** button to display the AUX MASTER Touchscreen. The 12 Aux Master Sends can be adjusted using the QuickMix knobs. The selected Aux Master is listed in the top left of the screen. Change the selected Aux Master by pressing the desired Aux's QuickMix knob.

The top-half of the AUX MASTER Touchscreen displays the overview information for the selected Aux Master: metering, compression and EQ curves. Touch the EQ or Compression displays to open their associated Touchscreens (or press the **EQ** or **DYN** QuickMix buttons).

Each Aux Send Master also has an OVERVIEW Touchscreen that can be displayed by selecting an Aux Master and pressing the **FAT** button (see page 73).

See *Aux Master* on page 85 for more information.

3.4.6 SNAP

Press the **SNAP** button to display and edit the settings on the SNAPSHOTS TT control software screen. See *Snapshots* on page 82 for a complete discussion.

See *Snapshots* on page 39 to learn about the console's Snapshot controls.

3.4.7 EFX

Press the **EFX** button to display effects settings on the EFX Touchscreen. There are four internal EFX processors.

See *Effects* on page 90 for more information about the EFX Touchscreen.

Also see *Internal Effects Processors* on page 57 and *Tabular Summary of DSP and Effects* on page 58.

3.4.8 MATRIX

Press the **MATRIX** button to display the MATRIX Touchscreen. See *Matrix Mix* on page 87 and *Matrix Output* on page 57 for more information.

3.4.9 Engineer's Utility

The Engineer's Utilities area consists of the clipboard buttons (**COPY** and **PASTE**) and four green backlit buttons: **HELP**, **SETUP**, **UTIL**, and **CTRL**.

HELP

This button is reserved for future use.

SETUP

Press the **SETUP** button to open the SETUP Touchscreen, which accesses global console parameters from the following categories: Operation, General, and Digital. See page 90 for details.

UTIL

Press the **UTIL** button to open the UTIL Touchscreen, which accesses useful console configuration functions: Monitor Source, Stereo Input Assign, Talkback, and Meters. See page 93 for details.

CTRL

Pressing and holding the **CTRL** button while accessing some console controls provides alternate functions:

- **Default Values:** Press and hold the **CTRL** button and touch any console parameter to restore its default value.

For example, press and hold **CTRL** and turn a Pan V-Pot to return it to its center position or turn an EQ Gain knob to return the setting to 0.

- **Multiple Solo:** Press and hold the **CTRL** button to select multiple **SOLO** buttons. This works even when **EXCLUSIVE SOLO** mode is active in the GENERAL SETUP Touchscreen (see page 91).
- **Special TT Control Screens:** CTRL+METERS, CTRL+BANK (ANLG, DGTL, RTNS, or MSTR), CTRL+MATRIX

COPY

Press the **COPY** button to copy the selected channel's parameters to the clipboard (can only contain one channel's parameters).

PASTE

Press the **PASTE** button to paste the clipboard contents onto the selected channel(s). The **PASTE** button has no effect until a channel is copied to the clipboard.

The parameters copied and pasted can be restricted depending on the current Touchscreen:

- 4- and 6-BAND EQ Touchscreens: only EQ parameters
- COMPRESSOR Touchscreen: only compressor parameters
- GATE/EXP Touchscreen: only gate/expander parameters
- DYNAMICS Touchscreen: *both* compressor and gate/expander parameters
- GRPS/AUXES Touchscreen: only Group and Aux assignments
- FAT OVERVIEW Touchscreen: all parameters

3.4.10 Main Meters and RUDE SOLO LED

The main meters display the Left, Right, and Center/Mono outputs, depending on the console configuration. The meters receive the same signal as the Main outputs. The first red Clip LED at the top of the meter lights when the signal reaches -2 dBFS.

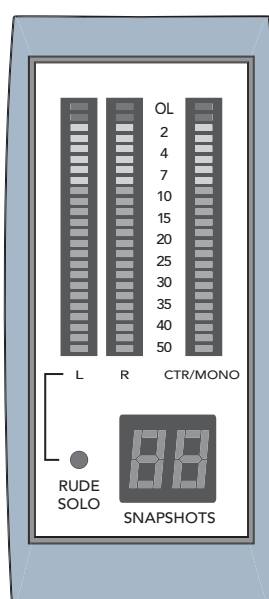

Figure 3-6 Main Meters and RUDE SOLO

If any channel is soloed, the **RUDE SOLO** LED flashes red. The **L** and **R** meters now display the stereo solo signal instead of the main output. If the solo signal is mono, it appears on both the **L** and **R** meters.

The **CTR/MONO** meter does not display anything when viewing solo levels. This, along with the **RUDE SOLO** LED, indicates that the meter is displaying a soloed signal.

When all solos are cleared either individually or by pressing the global **CLEAR SOLO** button, the **RUDE SOLO** LED stops flashing and the three meters return to their normal operation.

3.5 UTILITY Area

At the top of the console, the **UTILITY** area contains **TALKBACK**, **MONITOR**, and **PHONES** controls.

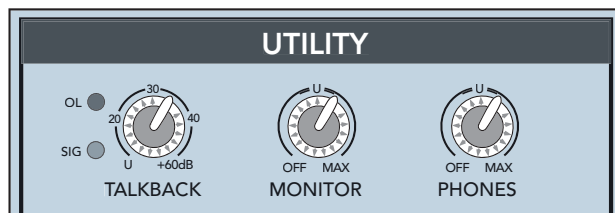

Figure 3-7 UTILITY area

3.5.1 TALKBACK

The **TALKBACK** gain knob controls the input gain of the rear panel **TALKBACK** microphone input. The gain range is 0–60 dB. A green **SIG** (signal) LED and a red **OL** (overload) LED behave identically to those on the channel strips (see page 25). The talkback signal is routed via the **TALKBACK** Touchscreen, accessed by pressing **UTIL** and then touching the **TALKBACK** button. The Talkback signal can be routed to any Matrix or Aux bus.

3.5.2 MONITOR

The **MONITOR** gain knob controls the level of the **Left**, **Right**, and **Mono** monitor outputs. The gain range is from *off* to +10 dB. These outputs contain the left, right, and monitor signal selected in the **MON. SOURCE** Touchscreen, accessed by pressing **UTIL** and then touching the **MONITOR SOURCE** button. When a solo button is pressed, the solo signal is sent to the monitor outputs instead.

3.5.3 PHONES

The **PHONES** gain knob controls the headphone output level, a stereo output identical to the Monitor **L/R** outputs. The **PHONES** level is independent of the **MONITOR** gain control.

3.6 Snapshots

The TT24 includes a robust snapshot feature that captures and restores the state of the console. The console snapshot controls are in the top-right of the console beside the QuickMix buttons (Figure 3-5). These fast and intuitive surface controls can store/recall up to 99 snapshots.

More elaborate snapshot functionality is available on the **SNAPSHOTS** Touchscreen (i.e., channel and parameter filtering; see page 82). This section discusses only the console's surface controls.

The **SNAPSHOTS** LCD displays the selected snapshot (bottom-right in Figure 3-6). Use the up/down arrow buttons to scroll through existing snapshots. The current snapshot's number is displayed in the **SNAPSHOTS** LCD field next to the Touchscreen. The snapshot number blinks in the **SNAPSHOTS** display before being recalled.

Press **RECALL** to recall the blinking snapshot number displayed in the LCD. When the **RECALL** button is pressed, the snapshot parameters are loaded into the TT24 and the LCD lights continuously. Press **STORE** to save the state of the console to the current snapshot (the last snapshot recalled).

3.7 Group and Master Controls

The TT24 has four Group strips and one Master strip (Figure 3-8). Each Group has a V-Pot to control group pan and the Group Mode, **MUTE**, **SELECT**, **SOLO** buttons, and a fader. The four Group strips control either Groups 1–4 or 5–8. The currently selected Group bank is indicated by the lit **GROUP ASSIGN/SELECT** buttons.

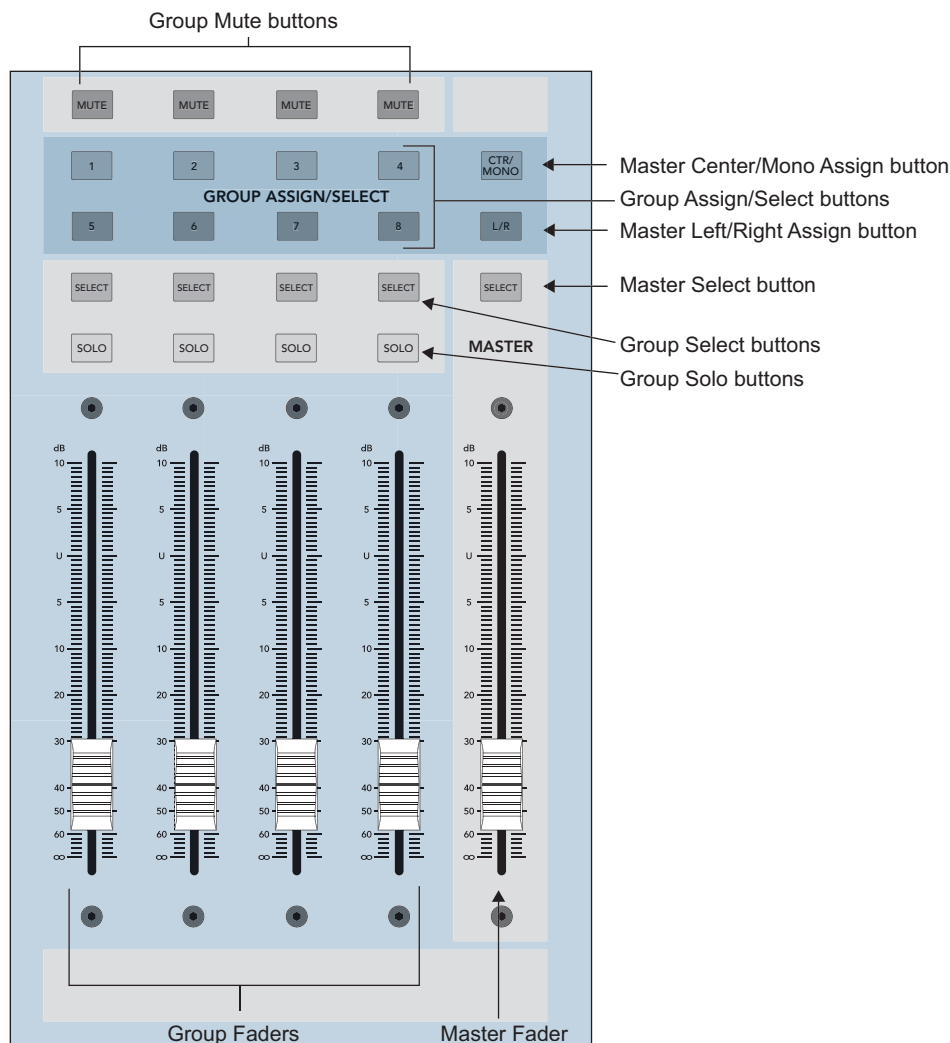

Figure 3-8 Bank Select, Group, Aux and Master sections

3.7.1 Changing the Group Bank

Press any of the **GROUP ASSIGN/SELECT** buttons to select that Group bank. The **GROUP ASSIGN/SELECT** buttons illuminate 1–4 or 5–8 and cause the faders and buttons to snap to their previous Group bank settings.

3.7.2 Group Assignment

Press and hold a **GROUP ASSIGN/SELECT** button and press the channel **SELECT** buttons to add/subtract channels from that Group. This method is used for all of the **GROUP ASSIGN/SELECT** buttons: Groups 1–8, L/R and CTR/Mono.

The **SELECT** button for channels assigned to a group light when a **GROUP ASSIGN/SELECT** button is held down.

A selected channel can also be assigned to groups by selecting **GRP/AUX** in the QuickMix area to view the Group/Aux parameters on the Touchscreen.

3.7.3 Group Parameter Control

Press a **GROUP SELECT** button to access that Group's settings and controls from the QuickMix section just like an input channel.

3.8 Solo Area

The Solo area (Figure 3-9) has two buttons: **CLEAR SOLO** and **PFL**.

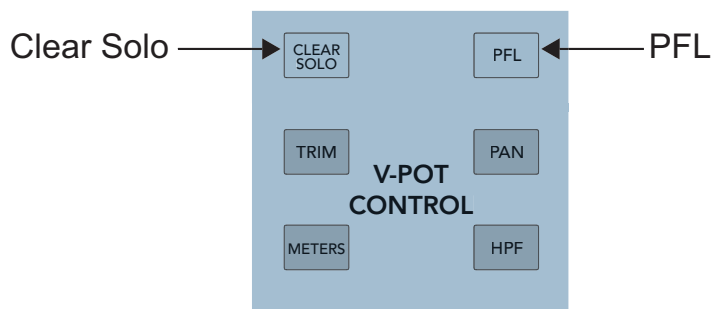

Figure 3-9 Solo area

3.8.1 CLEAR SOLO

Press this momentary button to clear any soloed channels. It lights yellow when any solo buttons are active as does the **RUDE SOLO** LED (Figure 3-5).

3.8.2 PFL

Activate this yellow backlit button so all soloed channels are PFL (pre-fader listen). Solo selections are AFL (after-fader listen) when the button is not lit.

Chapter 4: Rear Panel Connectors

4.1 Analog I/O

Figure 4-1 shows the rear panel analog I/O connectors except for the Group/Matrix outputs, which are shown in Figure 4-3.

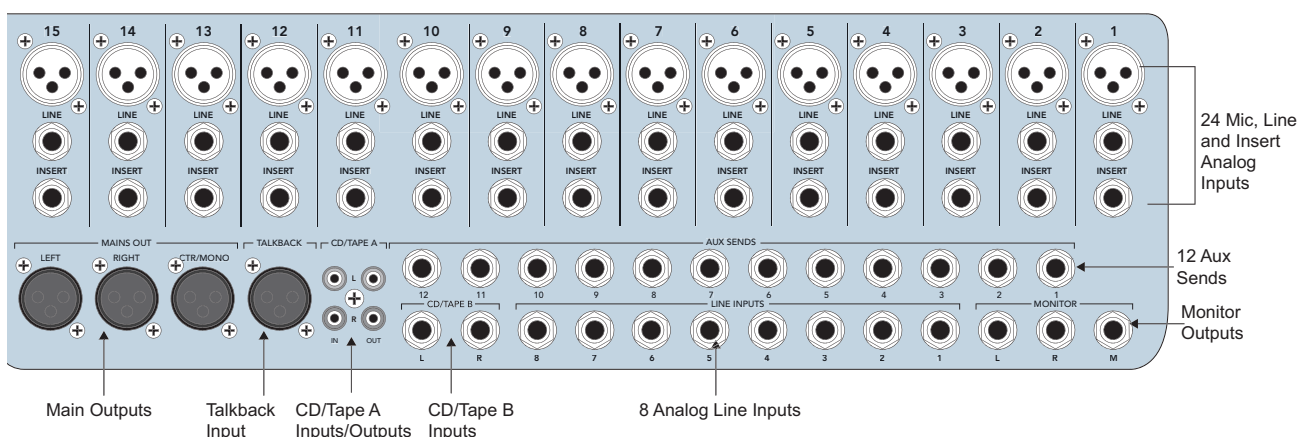

Figure 4-1 Analog I/O

4.1.1 MIC Inputs 1–24

The TT24 microphone preamp was based on our extensive knowledge and experience with those used in the Digital 8• Bus, VLZ Pro, and Onyx Series mixers, but optimized for a digital mixer.

These female XLR connectors accept a balanced microphone input from almost any type of microphone. The **LINE** button on the channel strip should be in the *up* position when using these connectors. The MIC inputs appear on the ANALOG fader bank. Phantom power (48 VDC) can be switched on for condenser mics setting the **48V** button to the *down* position.

The XLR inputs are wired according to the AES standard:

- Pin 1 = Shield or ground
- Pin 2 = Positive (+ or hot)
- Pin 3 = Negative (- or cold)

4.1.2 LINE Inputs 1–24

These ¼-in TRS connectors accept a balanced or unbalanced line level input signal from almost any source. The **LINE** button on the console surface should be in the *down* position when using these connectors. The LINE inputs appear on the ANALOG bank.

A balanced line level signal must be wired as follows:

- Tip = Positive (+ or hot)
- Ring = Negative (- or cold)
- Sleeve = Shield or ground

An unbalanced signal must be wired as follows:

- Tip = Positive (+ or hot)
- Sleeve = Shield or ground

4.1.3 INSERTS 1–24

These ¼-in TRS connectors provide each channel an analog send and return point. Use the INSERT jacks to connect external serial effects devices (i.e., compressors, equalizers) to an individual channel. These connectors can also be used as post gain control, unbalanced channel direct outputs.

The INSERT points are after the **GAIN** control, and just before the ADC. The send (tip) is low-impedance and the return (ring) is high-impedance, allowing connection to virtually any device.

Cables for this type of insert send/return function must be wired as follows:

- Tip = Send (output to effects device)
- Ring = Return (input from effects device)
- Sleeve = Common ground (connect shield to all three sleeves)

The figure below shows three ways to use the INSERT jacks:

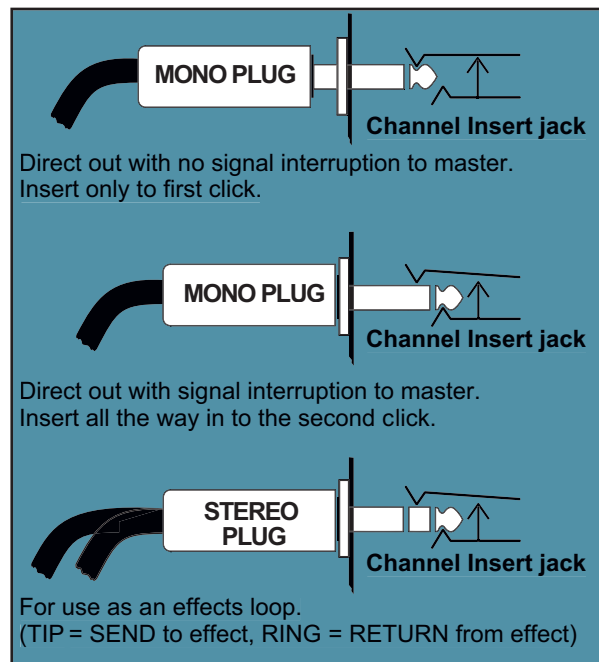

Figure 4-2 Insert Jack

4.1.4 AUX SENDS 1–12

These 1/4-in TRS output connectors provide 12 balanced or unbalanced line-level signals for effects devices or stage monitor amplifiers.

4.1.5 LINE INPUTS 1–8 (RETURNS)

These 1/4-in TRS input connectors accept eight balanced or unbalanced line-level signals from an external processor or other device. They can be used as additional line inputs or as aux returns. The LINE INPUTS appear on channels 1–8 on the RETURNS bank.

4.1.6 MONITOR

These ¼-in TRS output connectors provide three balanced line-level signals that can be used to provide another stereo (**L**, **R** outputs) or mono (**M** output) main mix output or to monitor the **CD/TAPE A** or **CD/TAPE B** inputs. See *MONITOR SOURCE* on page 94 for more information.

Connect these outputs to the inputs of an amplifier, powered speaker, or recording device. Typically, the **L** and **R** outputs are connected to active studio monitors and the **M** output to an active floor wedge.

4.1.7 CD/TAPE A IN/OUT

These RCA jacks connect to the inputs and outputs of a CD/tape device. The TAPE IN jacks accept an unbalanced signal from a tape recorder or other signal source using standard consumer audio RCA cables. The signal can be routed to the MONITOR outputs with **CD/TAPE A** selected as the source in the MON. SOURCE Touchscreen (see page 94). This allows cueing intermission music through the MONITOR or PHONES outputs.

The **CD/TAPE A** inputs can also be routed to the **MAINS OUT** from the STEREO INPUT Touchscreen. This allows playing music between sets over the main PA speakers. When engaged, the QuickMix Area provides input level adjustment for CD/TAPE A on a rotary encoder.

WARNING: Selecting **L/R** in the STEREO INPUT Touchscreen for the **CD/TAPE A** input can create a feedback path between TAPE IN and TAPE OUT. Make sure your tape deck is not in record, record pause, or input monitor mode, and turn the tape level control all the way down.

The **CD/TAPE A** outputs produce an unbalanced signal that is tapped off the **MAINS OUT**. Normally, these are connected to the inputs of a recorder, but they can be used as two additional main outputs (i.e., for another zone).

4.1.8 CD/TAPE B Input

These ¼-in TRS input connectors accept balanced or unbalanced line level signals from the outputs of a CD/tape player or virtually any stereo line-level source.

The **CD/TAPE B** input can be routed to the **MAINS OUT** from the STEREO INPUT Touchscreen (see page 95). This allows adding the signal to the **MAINS OUT** or just playing music between sets over the main PA speakers.

4.1.9 TALKBACK MIC Input

This female XLR connector accepts an external talkback mic input. It requires a dynamic microphone because it does not supply phantom power. Use the Talkback UTILITY Touchscreen to route the signal to the desired outputs (see page 95).

4.1.10 MAINS OUT

These male XLR connectors provide balanced, line-level signals representing the end of the processing chain, where the fully mixed music is sent to the amps and speakers. **LEFT** and **RIGHT** connectors output the left and right stereo signals, respectively, while the **CTR/MONO** connector outputs the center signal (in LCR mode) or the mono signal (in L/R+MONO mode).

4.1.11 GROUP/MATRIX OUT

By default, these eight male XLR connectors provide balanced, line-level outputs for Groups 1–8. However, when the **MATRIX** mixer is active, each output can provide a separate mix of virtually any input source. See *Matrix Mix* on page 87 for details.

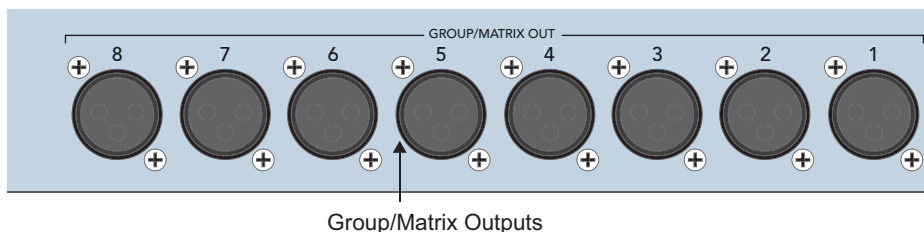

Figure 4-3 Group/Matrix connectors

4.2 Digital I/O

This section discusses the rear panel digital I/O (Figure 4-4).

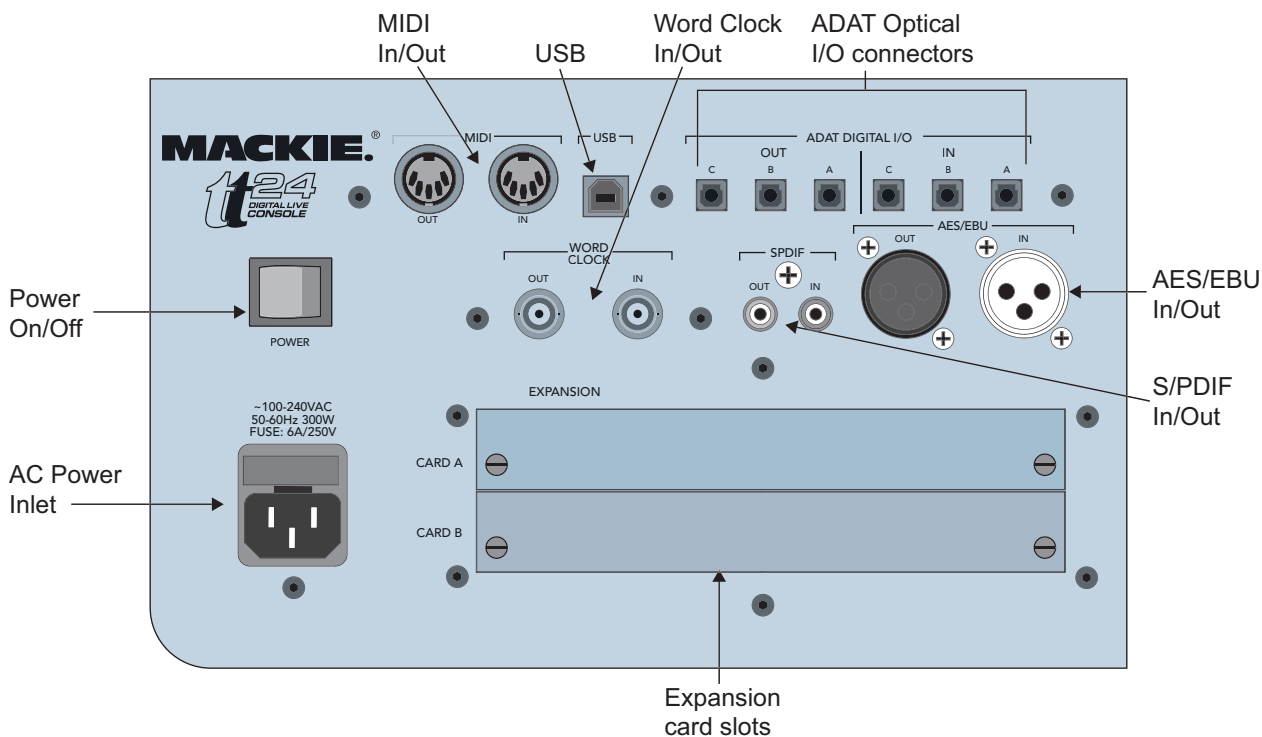

Figure 4-4 Digital I/O and expansion card slots

4.2.1 ADAT DIGITAL I/O

Six built-in Toslink connectors (INPUTS A–C, OUTPUTS A–C) provide 24 channels of 24-bit digital, ADAT optical lightpipe I/O at 44.1/48 kHz sample rates. At 88.2/96 kHz, the signal is multiplexed (SMUX format), which reduces the number of I/O channels to 12.

The optional ADAT I/O Expansion Card provides additional Toslink connectors (Expansion INPUTS A–C, Expansion OUTPUTS A–C) for channels 13–24 when operating at 88.2/96 kHz. The following table summarizes the channels allocated under each sample rate, with and without the expansion card.

NOTE: Expansion cards are not yet available.

Table 4-1 ADAT Digital I/O Channels at 44.1/48 and 88.2/96 kHz Sample Rates

	44.1/48 kHz	88.2/96 kHz
INPUT A	1–8	1–4
INPUT B	9–16	5–8
INPUT C	17–24	9–12
OUTPUT A	1–8	1–4
OUTPUT B	9–16	5–8
OUTPUT C	17–24	9–12
Expansion INPUT A	N/A	13–16
Expansion INPUT B	N/A	17–20
Expansion INPUT C	N/A	21–24
Expansion OUTPUT A	N/A	13–16
Expansion OUTPUT B	N/A	17–20
Expansion OUTPUT C	N/A	21–24

4.2.2 AES/EBU IN/OUT

AES/EBU IN is a female XLR connector that accepts a stereo AES/EBU digital input. A sample-rate converter can be enabled at the AES/EBU input to convert the incoming signal to the TT24's current sample rate. The signal can be routed from the STEREO INPUT Touchscreen (see page 95).

AES/EBU OUT is a male XLR connector that produces a stereo AES/EBU digital output of the **LEFT** and **RIGHT MAINS** outputs. At 88.2/96 kHz sample rates, the AES/EBU port uses the double-fast method, so the digital I/O port is clocked at twice the speed to double the transmission rate (see page 92 for more information on Digital Setup options).

4.2.3 SPDIF IN/OUT

SPDIF IN is an unbalanced RCA connector that accepts a stereo S/PDIF digital signal. A sample-rate converter can be enabled at **SPDIF IN** to convert the incoming digital signal to the TT24's current sample rate. The signal is then routed to the main L/R output from the STEREO INPUT Touchscreen as needed.

SPDIF OUT is an unbalanced RCA connector that produces a stereo S/PDIF digital signal of the **LEFT** and **RIGHT MAINS** outputs.

4.2.4 WORD CLOCK IN/OUT

WORD CLOCK IN is a BNC connector that receives a word clock signal from another device when the Clock Source is set to **Word** in the DIGITAL SETUP Touchscreen. Use this connector when multiple devices must all operate from an external master word clock. Use 75 Ω coaxial cable to connect a word clock signal to **WORD CLOCK IN**.

WORD CLOCK OUT is a BNC connector that produces a word clock signal at the TT24's current sample rate. Use this connector to transmit the word clock to other devices when the TT24 is operating as the system's master word clock.

4.2.5 MIDI IN/OUT

MIDI IN/OUT are standard 5-pin DIN connectors to connect to other MIDI devices. **MIDI IN** can receive MIDI Time Code (MTC) to synchronize with another device, and MIDI Program Changes to recall snapshots. **MIDI OUT** can send MIDI Machine Control (MMC) and MIDI Program Changes from snapshot recall.

NOTE: *MIDI functionality is not yet implemented.*

4.2.6 USB

This standard Universal Serial Bus connector allows a PC to run the TT control software, install firmware upgrades, share files between PCs, and backup files.

4.3 IEC Power Receptacle

This is a standard three-prong IEC power connector. Connect the detachable cord included in the TT24 shipping box to the power receptacle. Plug the other end of the cord into an AC outlet.

The TT24 has a universal power supply that can accept any AC voltage in the range 100–240 VAC. This feature, which alleviates the need for voltage select switches (and setting them correctly!), allows the TT24 to operate safely virtually anywhere in the world. Fondly nicknamed “Planet-Earth power supply,” it is also less susceptible to voltage sags or spikes, and provides better electromagnetic isolation and protection against AC line noise.

4.4 POWER Switch

When the **POWER** switch is turned *on*, AC power is supplied to the TT24. It exercises its faders while the firmware loads and the self-test routine executes.

Chapter 5: DSP and Internal Effect Allocation

TECH NOTE: The TT24 uses 12 SHARC DSP chips with embedded algorithms. This DSP approach differs from conventional digital audio workstations in that the algorithms are programmed as firmware on the DSP chips. The incoming audio signal is digitized by its ADC and then routed through the DSP chip whether or not processing is engaged. This ensures equal latency for all incoming audio sources.

This chapter discusses how the TT24 allocates its DSP and Internal Effects resources.

See Chapter 6: *Touchscreen and TT Control* for specific information about the DSP and Effects Touchscreens.

See *Tabular Summary of DSP and Effects* on page 58 for parameter reference.

5.1 Analog, Digital, and Line Inputs

Analog Inputs

Analog input channels 1–24 route to their DSP block immediately after the ADC and before routing to outputs, groups, and auxes. The signal flow is: variable-frequency high-pass filter, adjustable gate, EQ and compressor (the EQ and compressor order can be switched for each channel), channel fader, pan and assign sections.

Digital Inputs

The ADAT Optical digital input channels 25–48 have no DSP. Their signals enter the board, pass through the channel meter and can be routed to the Mains, Aux Sends, and Groups/Matrix as needed.

NOTE: The UFX II expansion card provides additional DSP for these inputs.

Line Inputs

Each Line Input can access a four-band parametric EQ. Odd/even adjacent inputs can be stereo linked (see page 27).

5.2 Master L/R and C/Mono

The Master L/R and C/Mono bus has the following signal path: six-band parametric EQ, compressor, and master fader.

5.2.1 L/R+Mono and LCR Modes

The TT24 has two master mix operating modes:

L/R+Mono: Stereo with an independent mono output.

LCR: True LCR panning from the channels and busses.

L/R+Mono

In L/R+Mono mode, the left and right stereo signals are available at the **LEFT** and **RIGHT** outputs, the mono signal from the **CTR/MONO** output. Channels can be assigned to both outputs. The channel sends to **CTR/MONO** are pre-pan, so the channel pan setting has no effect.

The L/R and Mono master levels and processing are linked by default, but they can be independent (see page 27). When unlinked, the **MASTER** fader controls the **LR** output and the **C/Mono** fader (channel 24 on the **MASTERS** bank) controls the mono output (which can also be controlled on the Master **OVERVIEW** Touchscreen). When linked, all processing is linked and the Master fader controls all levels. A relative offset between **LR** and **CTR/MONO** may be set using the Master **OVERVIEW** Touchscreen faders or the faders for channel strips 22–24 in the **MASTERS** bank.

LCR

In LCR mode, the **LEFT**, **CTR/MONO**, and **RIGHT** outputs present the LCR signal. Channels can be assigned to LR, Center, or LCR. A channel assigned to Center only is routed pre-pan, so the channel pan does not affect the Center signal. Channels assigned to LR only are routed to the **LEFT** and **RIGHT** outputs using stereo pan positioning. Channels assigned to LCR are routed to **LEFT**, **CTR/MONO**, and **RIGHT** outputs using true LCR panning.

The LCR master levels and processing are linked by default but can be unlinked and processed independently by pressing the **LINK** button in the Master **OVERVIEW** Touchscreen. When unlinked, the **MASTER** fader controls the **LEFT** and **RIGHT** outputs and the **C/Mono** fader (channel 24 on the **MASTERS** bank) controls the Center output (which can also be controlled on the Master **OVERVIEW** Touchscreen). When linked, all processing is linked and the **MASTER** fader controls all levels. A relative offset between the **LEFT-RIGHT** and **CTR** may be set using the Master **OVERVIEW** Touchscreen or by using the faders for channel strips 22–24 in the **MASTERS** bank.

5.2.2 Six-Band EQ

The Master outputs can each access a six-band EQ comprised of a four-band EQ and two *kill filters* (see page 78).

EQ Linking

The Master LR and C/Mono is actually three EQs: LR is stereo linked (two EQs) while the Mono EQ (one EQ) can also be linked with LR. To link, hold down the LR and C/Mono channel **SELECT** buttons for two seconds (see *Channel Linking* on page 27).

When the Master **LR** or **C/Mono** fader's **SELECT** button is pressed with the EQ or OVERVIEW Touchscreen displayed, the EQ (and compressor) displayed on the Touchscreen is LR. If the LR and C/Mono are linked, changing the LR EQ also affects the Mono EQ. If they are not linked, the C/Mono EQ is independent.

5.2.3 Compressor

The Master compressor operates identically to the channel compressor (see page 79).

The Master LR and C/Mono compressor is actually three compressors: the LR compressors are stereo linked while the C/Mono compressor can be linked, if desired (see page 53).

The Master compressor can be viewed from the Master OVERVIEW Touchscreen and adjusted on the COMPRESSOR Touchscreen.

5.2.4 Fader Position in Signal Path

The Master LR or LCR fader position is adjustable from post- to pre-compressor. In the pre-compressor position, the user can ride the master fader while maintaining the output level protection of the compressor. The master fader position can be adjusted from the Master OVERVIEW Touchscreen.

5.3 Aux Send

Each Aux Send has the following signal path: six-band parametric EQ, and compressor. The position of the EQ and compressor can be reversed.

5.3.1 Six-Band Parametric EQ

The Master Aux Send EQs operate identically to the Master LR and C/Mono EQs (see page 53).

If a pair of Aux sends is linked, their EQs are also linked: adjusting the EQ of one aux of a linked pair adjusts the other's EQ.

The Aux Send EQ can be viewed from the AUX MASTER and Aux OVERVIEW Touchscreens. The EQ is adjusted from the 6 BAND EQ Touchscreen.

5.3.2 Compressor

The Master Aux Send compressors operate identically to the channel compressors. See page 53 for operational details.

If a pair of Aux sends is linked, their compressors are also linked: adjusting one aux's compressor parameters also adjusts those of the other aux.

The compressor for the selected Aux Send Master is displayed from the AUX MASTER and the Aux OVERVIEW Touchscreens. Its settings are adjusted on the Aux Master COMPRESSOR Touchscreen.

5.4 Flex-Group DSP

There are a total of eight DSP blocks available for the Flex-Groups so each of the eight groups can use a block of DSP except VCA types (see page 56). Not all groups can use DSP at once if they are in multichannel group mode. The Group DSP contains a four-band EQ and compressor. The default order is EQ into the compressor but they can be reversed.

5.4.1 Flex-Group Modes

Each group can be configured as mono, stereo, LCR (if in LCR Mode), or VCA. The group type is set by a toggle button in the Group OVERVIEW Touchscreen. Each group's mode can be configured independently.

Mono Mode

If the TT24 is in L/R+Mono mode, all groups are mono by default. Mono groups operate similarly to groups on a typical analog console: pre-pan mono signals are routed from the channels to the Groups using the **GROUP ASSIGN** switches. After group processing, the signal passes through the group **MUTE** switch, fader, and can then be routed to the Mono or LR Master outputs. A group pan is available for L/R positioning. Group signals are available to the Matrix (if enabled).

Stereo Mode

Stereo groups do not have a pan control. Signals are routed from channels to stereo groups using the **GROUP ASSIGN** switches but the signal is post-pan and the stereo image is maintained throughout the group signal path. After any group processing, the stereo group signal can be routed to the main **L/R** output after the Group's **MUTE** switch and fader. Stereo groups can also be routed to the **C/Mono** output but the stereo signal is summed to mono.

LCR Mode

In LCR mode, the same three group modes are available along with LCR group mode, but they operate slightly differently. A mono group still receives its mono signal from the assigned channel, and can be routed to Center or L/R. However, it can also be routed to LCR by assigning it to both Center and L/R simultaneously, resulting in a true LCR pan.

In LCR mode, a stereo group receives its stereo signal such that channel pan is interpreted as left-right. This results in a true LR group, maintaining the stereo image throughout the signal path. After processing, the Group's **MUTE** switch, and fader, the group can only be routed to the **LEFT** and **RIGHT** or **MATRIX** outputs.

If a group is configured as LCR, it receives a post-pan channel signal, such that the pan is interpreted as LCR. The group maintains a true LCR image through the signal path: assignable DSP, **MUTE** switch, and fader. The LCR group can be routed to the **LEFT**, **RIGHT**, and **CTR/MONO** outputs.

NOTE: Assigning the group to LR or C automatically assigns it to the other; it cannot be routed to just LR or C or Matrix.

VCA Mode

A VCA group allows assigning channels, each at its own relative level, to a group whose overall level is controlled by a single fader. Any input channel can be assigned to a VCA group.

The VCA group fader modifies the level of assigned channels *at the channel fader*. This means that all post-fader sends for these channels are also affected by the VCA group fader. Both the VCA and channel faders modify the channel's output. For example, if the channel fader is set to +5 dB and the VCA fader is set to -15 dB, the cumulative output of the channel is -10 dB.

However, any fader at negative infinity or muted is not affected by a VCA fader. For example, if channel 1 is set to negative infinity, the output of the channel is muted regardless of the VCA fader setting. Likewise, if the VCA fader is at negative infinity or muted, the assigned channels are muted, regardless of their fader position.

A single input can be assigned to multiple VCA groups and it will be affected by all VCA faders. The resultant signal is the sum of the channel and its VCA faders. The maximum gain from summation is 10 dB.

The VCA group fader has **MUTE**, **SOLO**, and **SELECT** buttons. When the VCA Group is muted or soloed, the channels assigned to the VCA group are also muted or soloed. The channel's **MUTE** and **SOLO** buttons blink and the VCA Group's **MUTE** and **SOLO** buttons are lit solid.

5.4.2 Group DSP Allocation

Mono, stereo, and LCR groups can access DSP but VCA groups cannot. Eight units of group DSP are available and each Group mode requires a different number of units: Mono = 1, Stereo = 2, LCR = 3. Since the TT24 can have up to 8 LCR groups, there is not enough DSP to cover all group routing in all cases.

The Group OVERVIEW Touchscreen has a **GRP DSP AVAILABLE** meter that displays the group DSP (in 1 unit increments) available (see page 74 for more information).

When a group's mode is changed, the DSP is automatically updated if necessary. If there is insufficient DSP available to make the adjustment, a warning appears: "There is not enough DSP to change the mode of the selected group. Change the mode and remove group processing?" Touch **REMOVE** to remove group processing and change the group mode, or touch **CANCEL** to leave the group in its current mode and DSP allocation.

Four-Band Parametric EQ

The Group's four-band parametric EQ operates identically to the channel's (see *Four-Band Equalizer* on page 76).

The Group mode setting determines the number of EQ sections: Mono = 1, Stereo = 2, LCR = 3. Stereo and LCR groups have linked EQ sections to implement their multichannel format. The Group EQ applies to all group channels.

The Group Parametric EQ can be viewed from the Group OVERVIEW Touchscreen and is adjustable from the Group's 4 BAND EQ Touchscreen.

Compressor

The Group's compressor operates identically to the channel's (see *Compressor* on page 53).

The Group mode setting determines the number of Compressor sections and DSP units required: Mono = 1, Stereo = 2, LCR = 3. Stereo and LCR groups have linked Compressor sections to implement their multichannel format. The Group Compressor applies to all group channels.

The Group Compressor can be viewed from the Group OVERVIEW Touchscreen and adjusted from the COMPRESSOR Touchscreen.

5.5 Matrix Output

Each Matrix output has an adjustable delay.

5.5.1 Delay

Each Matrix output has a 600 ms delay to allow time alignment of multiple speaker groups in a large venue (see *Delay* on page 89).

5.6 Internal Effects Processors

The internal EFX have four independent mono input/stereo output effects processors that are adjusted from the EFX Touchscreens, accessed by pressing the **EFX** button or from their associated returns OVERVIEW Touchscreens. Each processor can utilize one of the following effects: Reverb, Mono Delay, Stereo Delay, Ping Pong Delay, Chorus, or Flange. Each effect has a post-effect EQ with high- and low-shelf filter, and one parametric mid-band filter.

The internal effects can be fed from any of the Aux Sends or the Matrix Outputs. By default, the four effects processors are fed by Aux Sends 9–12. Routing is accomplished on the EFX Touchscreen (see *Effects* on page 90).

5.7 Tabular Summary of DSP and Effects

Table 5-1 DSP Functions and Allocation

Function	Channels	Parameter	Value Range/Increments	Default Value
Digital Trim	Analog 1-24, Analog Returns 1-8	Digital Trim	+15 dB to -15 dB (0.1 dB steps)	0 dB
High Pass Filter	Analog 1-24	On/Off	On or Off	Off
		Frequency	20–400 Hz (scaled Steps)	80 Hz
Phase	Analog 1-24	Phase	Normal/Invert	Normal
Gate	Analog 1-24	Threshold	-60 dBFS to -1 dBFS (0.2 dBFS steps)	-60 dBFS
		Range	-100 dB to -1 dB (0.5 dB steps)	-100 dB
		Ratio (when Expander enabled)	1:20 to 1:1 (scaled steps)	1:20
		Attack	0.1 ms to 2500 ms (scaled steps)	0.1 ms
		Release	10 ms to 2500 ms (scaled steps)	100 ms
		Hold	0 ms to 2500 ms (scaled steps)	0 ms
		Gate On/Off	On or Off	Off
		Mode	Gate or Expander	Gate
Compressor	Analog 1-24, Aux Sends 1-12, Assignable Bus DSP, L/R-C/Mono	Threshold	60 dBFS to -1 dBFS (0.2 dBFS steps)	-1 dBFS
		Ratio	1:1 to 20:1 (scaled steps)	2.2:1
		Attack	0.1 ms to 2500 ms (scaled steps)	4.1 ms
		Release	10 ms to 2500 ms (scaled steps)	100 ms
		Gain	0 dB to 20 dB (0.1 dB steps)	0 dB
		Compressor On/Off	On or Off	Off
		Knee Mode	Hard or Soft	Hard

Function	Channels	Parameter	Value Range/Increments	Default Value
4 Band EQ	Analog 1-24, Assignable Bus DSP	Gain 1	-15 dB to +15 dB (0.1 dB steps) -not available when Band 1 is HP	0 dB
		Freq 1	20 Hz to 20 kHz (scaled steps)	80 Hz
		Bandwidth 1	2 octaves to 1/30 octave (scaled steps) -not available when Band 1 is Shelf	1/2
		Gain 2	-15 dB to +15 dB (0.1 dB steps)	0 dB
		Freq 2	20 Hz to 20 kHz (scaled steps)	500 Hz
		Bandwidth 2	2 octaves to 1/30 octave (scaled steps)	1/2
		Gain 3	-15 dB to +15 dB (0.1 dB steps)	0 dB
		Freq 3	20 Hz to 20 kHz (scaled steps)	2 kHz
		Bandwidth 3	2 octaves to 1/30 octave (scaled steps)	1/2
		Gain 4	-15 dB to +15 dB (0.1 dB steps)	0 dB
		Freq 4	20 Hz to 20 kHz (scaled steps)	10 kHz
		Bandwidth 4	2 octaves to 1/30 octave (scaled steps) -not available when Band 4 is Shelf	1/2
		EQ On/Off	On or Off	On
		Band 1 Mode	Para, Shelf	Shelf
Band 4 Mode	Para, Shelf	Shelf		
6-Band EQ with 2 Kill Filters	Aux Sends 1-12, L/R, C/Mono	Gain 1	-15 dB to +15 dB (0.1 dB steps)	0 dB
		Freq 1	20 Hz to 20 kHz (scaled steps)	80 Hz
		Gain 2	-15 dB to +15 dB (0.1 dB steps)	0 dB
		Freq 2	20 Hz to 20 kHz (scaled steps)	500 Hz
		Bandwidth 2	2 octaves to 1/30 octave (scaled steps)	1/2
		Gain 3	-15 dB to +15 dB (0.1 dB steps)	0 dB
		Freq 3	20 Hz to 20 kHz (scaled steps)	2 kHz
		Bandwidth 3	2 octaves to 1/30 octave (scaled steps)	1/2
		Gain 4	-15 dB to +15 dB (0.1 dB steps)	0 dB
		Freq 4	20 Hz to 20 kHz (scaled steps)	10 kHz
		Gain 5	0 dB, -6 dB, -12 dB, -18 dB	0 dB
		Freq 5	20 Hz to 20 kHz (scaled steps)	1 kHz
		Bandwidth 5	1/10 octave, 1/20 octave, 1/30 octave	1/10 octave
		Gain 6	0 dB, -6 dB, -12 dB, -18 dB	0 dB
		Freq 6	20 Hz to 20 kHz (scaled steps)	1 kHz
		Bandwidth 6	1/10 octave, 1/20 octave, 1/30 octave	1/10 octave
		EQ On/Off	On or Off	On
Delay	Matrix Outputs	Delay	0 ms to 600 ms (0.5 ms steps)	0 ms
		Temperature	20–120°F (-10° to 50°C) 1° increments	77°F 25°C
		Delay On/Off	On or Off	Off

Table 5-2 Internal Effects Parameters and Values

Function	Parameter	Value Range/Increments	Default Value
Reverb	Size	3–40 m (1 m steps)	10 m
	Decay	0.1–10 s (0.1 s steps)	1.6 s
	Pre Delay	0– 300 ms (1 ms steps)	0 ms
	Diffusion	0–10 (1 steps)	5
	Damping	0–10 (1 steps)	5
	Roll Off	Flat to 500 Hz (scaled steps)	Flat
	EQ On/Off	On/Off	Off
	Low Shelf Gain	-15 dB to +15 dB (0.1 dB steps)	0 dB
	Mid Gain	-15 dB to +15 dB (0.1 dB steps)	0 dB
	Mid Frequency	20 Hz – 20 kHz (scaled steps)	2 kHz
	Mid Bandwidth	2 octaves to 1/30 octave (scaled steps)	1/2
	High Shelf Gain	-15 dB to +15 dB (0.1 dB steps)	0 dB
Gated Reverb	Size	3–40 m (1 m steps)	10 m
	Pre Delay	0–300 ms (1 ms steps)	0 ms
	Diffusion	0–10 (1 steps)	5
	Roll Off	Flat to 500 Hz (scaled steps)	Flat
	Type	Hall, Plate, Random, Reverse	Hall
	Damping	0–10 (1 steps)	5
	Roll Off	Flat to 500 Hz (scaled steps)	Flat
	EQ On/Off	On/Off	Off
	Low Shelf Gain	-15 dB to +15 dB (0.1 dB steps)	0 dB
	Mid Gain	-15 dB to +15 dB (0.1 dB steps)	0 dB
	Mid Frequency	20 Hz – 20 kHz (scaled steps)	2 kHz
	Mid Bandwidth	2 octaves to 1/30 octave (scaled steps)	1/2
	High Shelf Gain	-15 dB to +15 dB (0.1 dB steps)	0 dB

Function	Parameter	Value Range/Increments	Default Value
Reverb Through Gate	Size	3–40 m (1 m steps)	10 m
	Decay	0.1–10 s (0.1 s steps)	1.6 s
	Pre Delay	0–300 ms (1 ms steps)	0 ms
	Diffusion	0–10 (1 steps)	5
	Damping	0–10 (1 steps)	5
	Roll Off	Flat to 500 Hz (scaled steps)	Flat
	Threshold	-60 dBFS to -1 dBFS (0.2 dBFS steps)	-60 dBFS
	Release	10–2500 ms (scaled steps)	100 ms
	Hold	0–2500 ms (scaled steps)	0 ms
	EQ On/Off	On/Off	Off
	Low Shelf Gain	-15 dB to +15 dB (0.1 dB steps)	0 dB
	Mid Gain	-15 dB to +15 dB (0.1 dB steps)	0 dB
	Mid Frequency	20 Hz – 20 kHz (scaled steps)	2 kHz
	Mid Bandwidth	2 octaves to 1/30 octave (scaled steps)	1/2
High Shelf Gain	-15 dB to +15 dB (0.1 dB steps)	0 dB	
Mono Delay	Delay	0–1600 ms (scaled steps)	250 ms
	Feedback	0% to 100% (1% steps)	20%
	Damping	Flat to 500 Hz (scaled steps)	Flat
	EQ On/Off	On/Off	Off
	Low Shelf Gain	-15 dB to +15 dB (0.1 dB steps)	0 dB
	Mid Gain	-15 dB to +15 dB (0.1 dB steps)	0 dB
	Mid Frequency	20 Hz – 20 kHz (scaled steps)	2 kHz
	Mid Bandwidth	2 octaves to 1/30 octave (scaled steps)	1/2
	High Shelf Gain	-15 dB to +15 dB (0.1 dB steps)	0 dB
Stereo Delay	Delay Left	0–1600 ms (scaled steps)	250 ms
	Delay Right	0 –1600 ms (scaled steps)	250 ms
	Feedback Left	0% to 100% (1% steps)	20%
	Feedback Right	0% to 100% (1% steps)	0.2
	Damping Left	Flat to 500 Hz (scaled steps)	Flat
	Damping Right	Flat to 500 Hz (scaled steps)	Flat
	EQ On/Off	On/Off	Off
	Low Shelf Gain	-15 dB to +15 dB (0.1 dB steps)	0 dB
	Mid Gain	-15 dB to +15 dB (0.1 dB steps)	0 dB
	Mid Frequency	20 Hz – 20 kHz (scaled steps)	2 kHz
	Mid Bandwidth	2 octaves to 1/30 octave (scaled steps)	1/2
	High Shelf Gain	-15 dB to +15 dB (0.1 dB steps)	0 dB

Function	Parameter	Value Range/Increments	Default Value
Ping Pong Delay	Delay Left	0–1600 ms (scaled steps)	250 ms
	Delay Right	0 –1600 ms (scaled steps)	250 ms
	Feedback Left	0% to 100% (1% steps)	20%
	Feedback Right	0% to 100% (1% steps)	0.2
	Damping Left	Flat to 500 Hz (scaled steps)	Flat
	Damping Right	Flat to 500 Hz (scaled steps)	Flat
	EQ On/Off	On/Off	Off
	Low Shelf Gain	-15 dB to +15 dB (0.1 dB steps)	0 dB
	Mid Gain	-15 dB to +15 dB (0.1 dB steps)	0 dB
	Mid Frequency	20 Hz – 20 kHz (scaled steps)	2 kHz
	Mid Bandwidth	2 octaves to 1/30 octave (scaled steps)	1/2
High Shelf Gain	-15 dB to +15 dB (0.1 dB steps)	0 dB	
Chorus	Depth	0–10 ms (0.1 ms steps)	3 ms
	Delay	0–100 ms (1 ms steps)	0 ms
	Thicken	0, 1, 2, 3	1
	Speed	0.05–5 Hz (scaled steps)	1 Hz
	Waveform	Sine, Triangle, Random	Sine
	EQ On/Off	On/Off	Off
	Low Shelf Gain	-15 dB to +15 dB (0.1 dB steps)	0 dB
	Mid Gain	-15 dB to +15 dB (0.1 dB steps)	0 dB
	Mid Frequency	20 Hz – 20 kHz (scaled steps)	2 kHz
	Mid Bandwidth	2 octaves to 1/30 octave (scaled steps)	1/2
	High Shelf Gain	-15 dB to +15 dB (0.1 dB steps)	0 dB
Flange	Depth	0 ms to 10 ms (0.1 ms steps)	3 ms
	Delay	0 ms to 100 ms (1 ms steps)	0 ms
	Manual Sweep	20 Hz to 20 kHz (scaled steps)	1 kHz
	Thicken	0, 1, 2, 3	1
	Speed	0.05 Hz to 5 Hz (scaled steps)	1 Hz
	Waveform	Sine, Triangle, Random	Sine
	EQ On/Off	On/Off	Off
	Low Shelf Gain	-15 dB to +15 dB (0.1 dB steps)	0 dB
	Mid Gain	-15 dB to +15 dB (0.1 dB steps)	0 dB
	Mid Frequency	20 Hz – 20 kHz (scaled steps)	2 kHz
	Mid Bandwidth	2 octaves to 1/30 octave (scaled steps)	1/2
High Shelf Gain	-15 dB to +15 dB (0.1 dB steps)	0 dB	

Chapter 6: Touchscreen and TT Control

Most of the TT24's configuration occurs on the Touchscreen and/or the TT control software. This section discusses the general conventions for both interfaces. Since the TT control software screens mirror and elaborate the Touchscreens, they will not be discussed except to define their functional differences.

In both the Touchscreen and TT control, the **Ctrl** key has a useful function: Press and hold the **Ctrl** key and adjust any TT control parameter to restore its default value. For example, press and hold **Ctrl** and adjust a Pan knob to set it to the center position, or adjust an EQ Gain knob to set it to 0 dB.

NOTE: *The Touchscreen and TT control screens can be synchronized, so displaying a new screen on one displays the corresponding screen on the other, or independent, allowing two engineers simultaneous access to the console. They are synchronized by default. See page 91 to toggle this setting.*

6.1 TT Control Conventions

The TT control software expands the TT24's control possibilities by providing:

- Remote control of all functions from a PC connected via USB
- Improved metering and graphics than can be displayed on the Touchscreen
- Remote Venue/Preset management and console→console backup/restore
- Console firmware upgrade capability
- Detailed Snapshot management

The TT24 connects to the PC via a USB cable (six-ft cable supplied). The minimum PC requirements are summarized below.

Table 6-1 Minimum PC Requirements

Screen Resolution	Processor Speed	Operating System
1024 x 768	600 MHz	Windows 2000 or XP

The TT control interface has knobs, buttons, graphs, and drop down menus, each described in the following sections.

6.1.1 TT Control Knob

The parameter value for each knob can be adjusted using two methods:

- Click on the knob, hold, and drag up/down to increase/decrease the value, respectively.

In Figure 6-1, the **Trim**, **HPF**, **Fader**, and **Pan** knobs can be adjusted by this method.

- Double-click the value below the knob to highlight the field and enter a new value from the keyboard.

The HPF field is highlighted in Figure 6-1. High and low limits are automatically enforced for each parameter.



Figure 6-1 TT Control software screen

6.1.2 TT Control Buttons

The TT control software has two types of buttons:

- **On/off or selected/unselected**

An on/selected button has black letters over a light blue background (**L/R** in the **GROUPS** area of Figure 6-3). An off/unselected button has light gray letters over a dark blue background (**GROUPS 1–8** in Figure 6-1). Click the button to toggle its setting.

- **Light switch**

A light switch toggles between two or more values located to the right of the switch. The selected value appears with black letters on a light blue background (**GATE** in Figure 6-1). The unselected value(s) has gray letters on a black background (**EXPANDER** in Figure 6-1). The switch position aligns with the selected value. Click anywhere on the light switch to toggle through the values (circular if more than two).

6.1.3 TT Control Menus

At the top of Figure 6-1, the **Ch. 1 Analog**, **Overview**, **Menu**, and **Files** menus all have a small downward pointing arrow indicating menu items. Click anywhere on the name or arrow to open a standard Windows menu.

In addition, the **Ch. 1 Analog** menu has larger up/down arrows on either side. Click on these arrows, or press the console up/down arrow keys, to increment/decrement through the list without opening the menu.

6.1.4 TT Control Graphs

Graphs with numbers or letters in small diamonds indicate that they can be adjusted by clicking, holding, and dragging the points (the EQ, GATE, and Compressor graphs in Figure 6-1).

In the EQ graph, each point behaves according to its EQ type. Since Band 1 is a shelf filter, its point (1 in Figure 6-1) can be dragged sideways to set the cutoff filter frequency and up/down to set the filter gain. The parametric filters can be dragged up/down to set the filter gain and sideways to set the center frequency. Hold the **Alt** key down, click on the point, and drag sideways to adjust the Q (left widens, right narrows).

Each point also corresponds to numerical fields below the graph that display their current values. These fields can be set by double-clicking and typing in a number from the keyboard. Upper and lower bounds are automatically enforced.

6.2 Touchscreen Conventions

The Touchscreen uses knobs, buttons, and sub screens, each described in the following sections. The **FILES** menu is the same for all Touchscreens.

6.2.1 Touchscreen Knobs

NOTE: *The Touchscreen knobs cannot be touched and adjusted directly! They correspond to the QuickMix rotary encoders below the Touchscreen.*

Up to 12 Touchscreen knobs each with a function label and value field are available depending on the Touchscreen. The layout of these knobs corresponds to the QuickMix rotary encoders below the Touchscreen. Adjusting a QuickMix knob adjusts the corresponding knob's parameter. If the Touchscreen has less than 12 parameters, the bottom row of QuickMix knobs is used first, followed by the middle and top rows. Figure 6-2 shows all three rows in use.

Each QuickMix knob can also activate a push button to toggle between two values related to its primary parameter. For example, the push button for a channel Aux Send toggles it between pre- and post-fader. The knob's push button capability (not active for all encoders) is indicated by a white Touchscreen knob instead of the usual black (the bottom-left and right knobs in Figure 6-2).

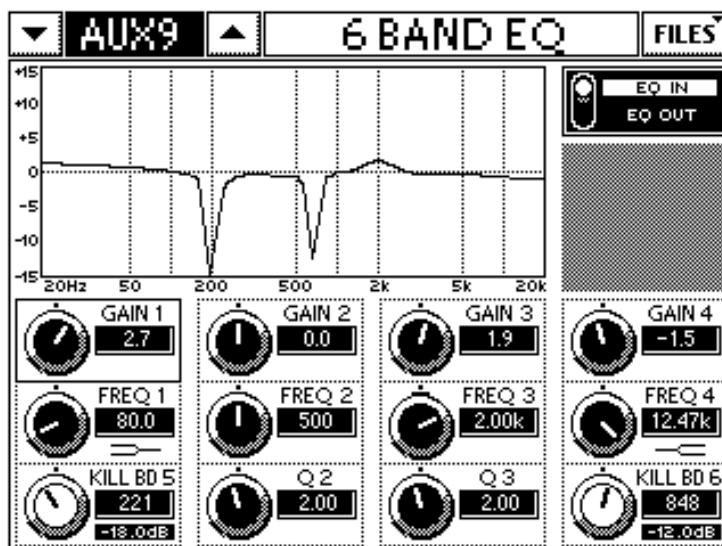

Figure 6-2 6-Band EQ Touchscreen

6.2.2 Touchscreen Buttons

There are two types of Touchscreen buttons:

- **On/off or selected/unselected**

An off/unselected button has black letters over a white background (**SOLO** in Figure 6-3). An on/selected button has white letters over a black background. Touch the button to toggle its setting.

- **Light switch**

A light switch toggles between the values located to the right of the switch. The selected value appears with black letters over a white background (**ALL ACTIVE** in Figure 6-3). The unselected value has white letters over a black background (**ALL OUT**). The switch position aligns with the selected value. Touch the switch to toggle the value.

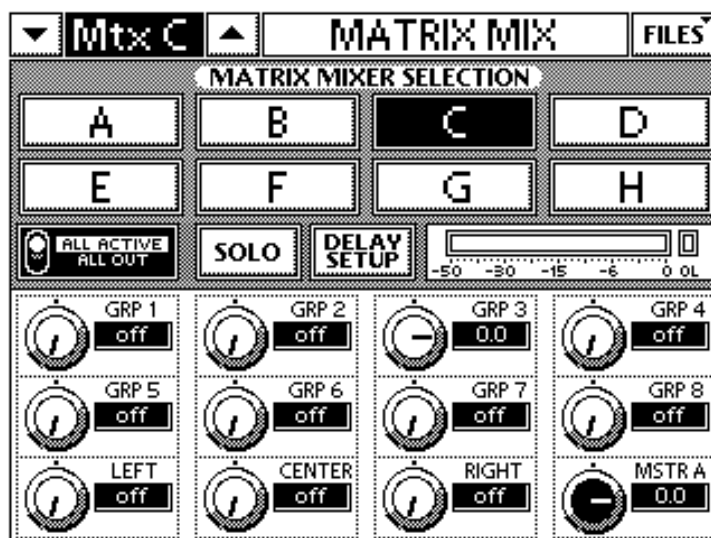

Figure 6-3 MATRIX MIX Touchscreen

6.2.3 Touchscreen Name and Channel/Function

The name of the current Touchscreen is displayed in the top-center of the screen (**MATRIX MIX** in Figure 6-3). Some screens are specific to the selected channel or function. For example, the Analog and Effect Return **OVERVIEW** screens are different. The currently selected channel/function appears in the upper-left of the Touchscreen (**MtX C** in Figure 6-3). Up and down arrows appear on either side of the selected channel that can be touched to increment or decrement the selected channel. Pressing the up/down QuickMix arrows also increments/decrements the field.

6.2.4 Sub Screens

Some functions require one or more sub screens to adjust all parameters. These screens are accessed by touching a button or an area, such as an EQ graph. After viewing and adjusting parameters on the sub screen, return to the previous screen by pressing the hardware button that displayed the original Touchscreen.

6.3 Overview Touchscreens

There are seven variations on the OVERVIEW Touchscreen: Analog, Digital, Line, Effect Return, Aux, Group, and Master. To display these screens, press the **FAT** QuickMix button and:

- select the desired channel's bank and press its **SELECT** button;
OR
- touch the up/down arrows next to the channel menu field to find the desired channel.

6.3.1 Analog

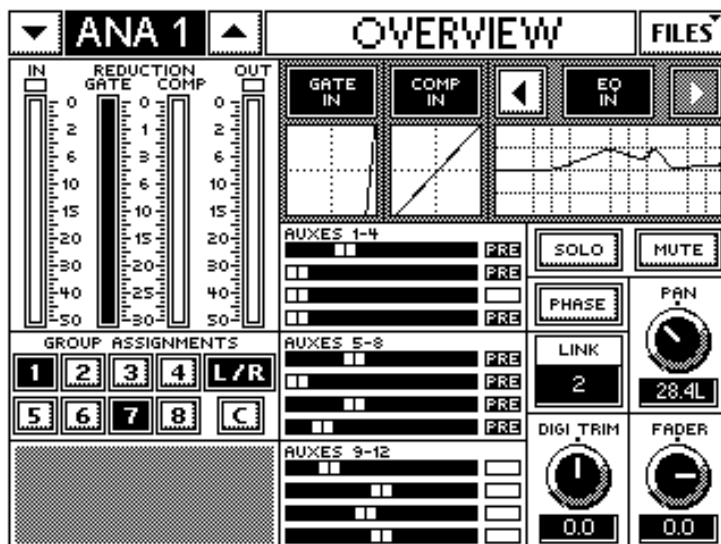

Figure 6-4 Analog OVERVIEW

GROUP/AUX ASSIGNMENTS

The AUXES area displays the selected channel's assignments, level settings, pan settings (if Auxes are stereo linked), and pre-/post-fader status (blank = POST). The GROUP ASSIGNMENTS area displays the selected channel's group assignments. Touch anywhere in the AUXES area to open the GRPS/AUXES Touchscreen (see page 86).

EQ, GATE, and COMP

Touch any of the graphs to open its specific Touchscreen. Touch the arrows to toggle the order of the EQ and compressor. Touch the **EQ OUT**, **COMP OUT**, **GATE OUT** buttons to toggle their processors in/out.

DIGI TRIM

This knob adjusts Digital Trim (see page 29).

PHASE

When active, the **PHASE** control inverts the polarity of the incoming signal. This is used to compensate for the distance between microphone positions (i.e., miking a drum set or stereo sources).

LINK

If a channel is listed below **LINK**, this channel has been stereo linked with the selected channel.

6.3.2 Digital

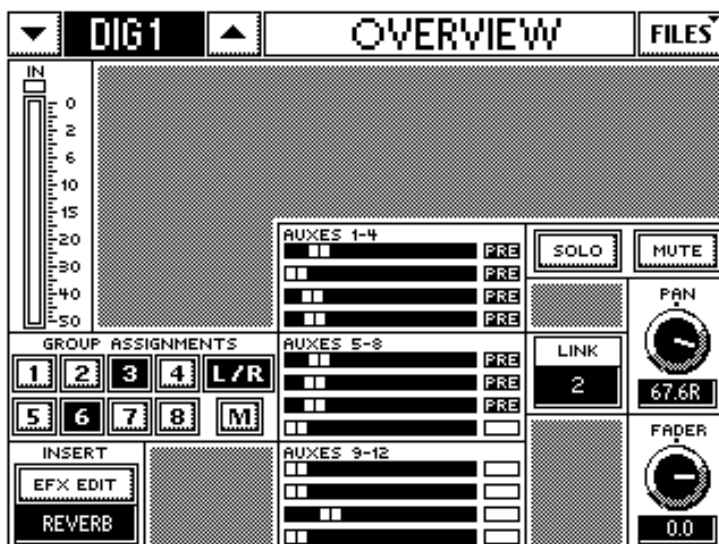

Figure 6-5 Digital OVERVIEW

GROUP/AUX ASSIGNMENTS

The AUXES area displays the selected channel's assignments, level settings, pan settings (if Auxes are stereo linked), and pre-/post-fader status (blank = POST). The GROUP ASSIGNMENTS area displays the selected channel's group assignments. Touch anywhere in the AUXES area to open the GRPS/AUXES Touchscreen (see page 86).

LINK

If a channel is listed below **LINK**, this channel has been stereo linked with the selected channel.

6.3.3 Effect Return

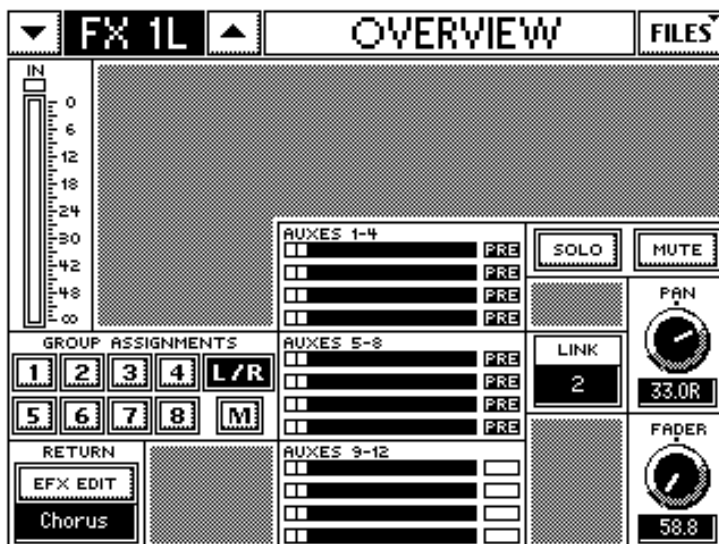

Figure 6-6 Effect Return OVERVIEW

GROUP/AUX ASSIGNMENTS

The AUXES area displays the selected channel's assignments, level settings, pan settings (if Auxes are stereo linked), and pre-/post-fader status (blank = POST). The GROUP ASSIGNMENTS area displays the selected channel's group assignments. Touch anywhere in the AUXES area to open the GRPS/AUXES Touchscreen (see page 86).

LINK

If a channel is listed below **LINK**, this channel has been stereo linked with the selected channel.

RETURN

The bottom of this section lists the effect name (Chorus in Figure 6-6). Touch the **EFX EDIT** button to edit and change the effect in its own Touchscreen (Figure 6-7).

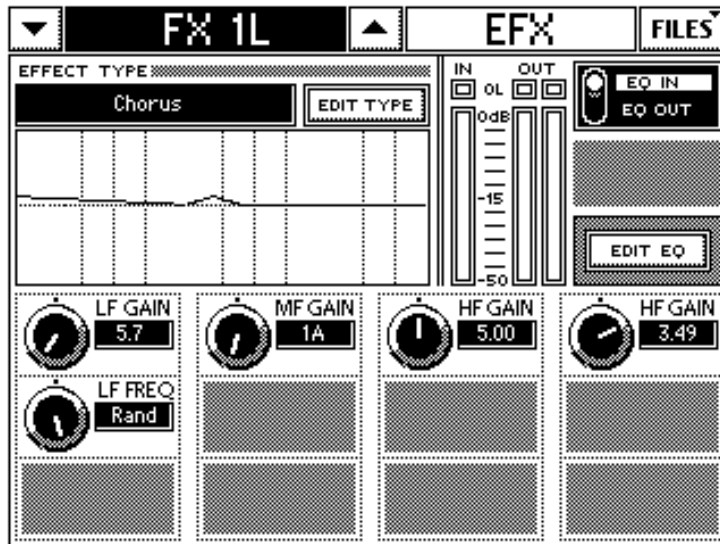

Figure 6-7 EFX Edit Touchscreen

This screen contains the editable effect parameters, **IN/OUT** meters, **EQ IN/OUT** button, and a graph showing the EQ curve associated with this effect. Touch the **EDIT EQ** button to display the EQ controls (low- and high-shelf filters and one parametric band) instead of the effect's.

6.3.4 Line

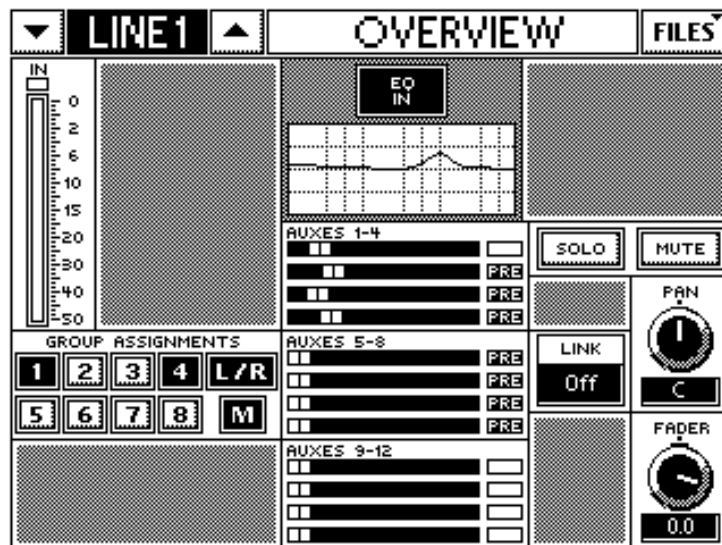

Figure 6-8 Line OVERVIEW

GROUP/AUX ASSIGNMENTS

The AUXES area displays the selected channel's assignments, level settings, pan settings (if Auxes are stereo linked), and pre-/post-fader status (blank = POST). The GROUP ASSIGNMENTS area displays the selected channel's group assignments. Touch anywhere in the AUXES area to open the GRPS/AUXES Touchscreen (see page 86).

EQ

Touch the EQ graph to open its Touchscreen. Touch the **EQ IN** button to toggle it in/out.

LINK

If a channel is listed below **LINK**, this channel has been stereo linked with the selected channel.

6.3.5 Aux

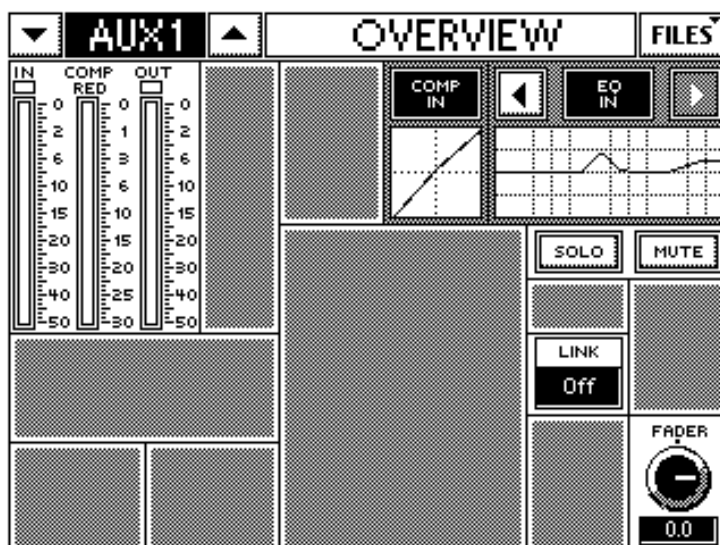

Figure 6-9 Aux OVERVIEW

EQ and COMP

Touch the EQ or compressor graphs to open their specific Touchscreens. Touch the arrows to toggle the processor order. Touch the **EQ IN**, **COMP IN** buttons to toggle their processors in/out.

LINK

If a channel is listed below **LINK**, this Aux has been stereo linked with the selected Aux.

6.3.6 Group

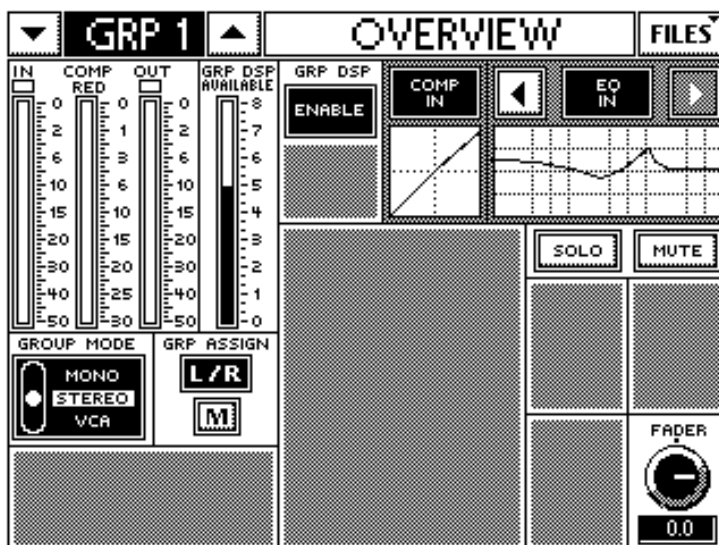

Figure 6-10 Group OVERVIEW

GRP DSP ENABLE/DISABLE

This button enables/disables the group DSP. Use this button in conjunction with the **GRP DSP AVAILABLE** meter to conserve DSP for where it is most needed. This button will only enable if DSP resources are available. When disabled, the Compressor and EQ graphs are absent.

If there is insufficient DSP to add to the selected group, a warning message appears stating there is not enough DSP to add to the selected group. If this instance of DSP is deemed essential, deactivate Group DSP elsewhere to free resources.

To remove DSP:

1. Touch the **DISABLE** button in the GRP DSP area.
A warning message appears: “Are you sure? This will remove DSP and all associated DSP settings from the selected group.”
2. Touch **OK** to confirm the removal of group DSP or **CANCEL** to leave the DSP active on that group.

GRP DSP AVAILABLE

This meter indicates the DSP resources still available. In Figure 6-10, five of the eight units of DSP are still available.

EQ and COMP

Touch the graphs to open their specific Touchscreens. Touch the arrows to toggle the processor order. Touch the **EQ IN**, **COMP IN** buttons to toggle their processors in/out.

GROUP MODE

Select **MONO**, **STEREO**, or **VCA** as the group mode from the light switch button. See page 54 for a complete discussion of Group modes.

GRP ASSIGN

Touch the **L/R** and **M** buttons to assign the group to the Left-Right and Center/Mono outputs, respectively.

6.3.7 Master

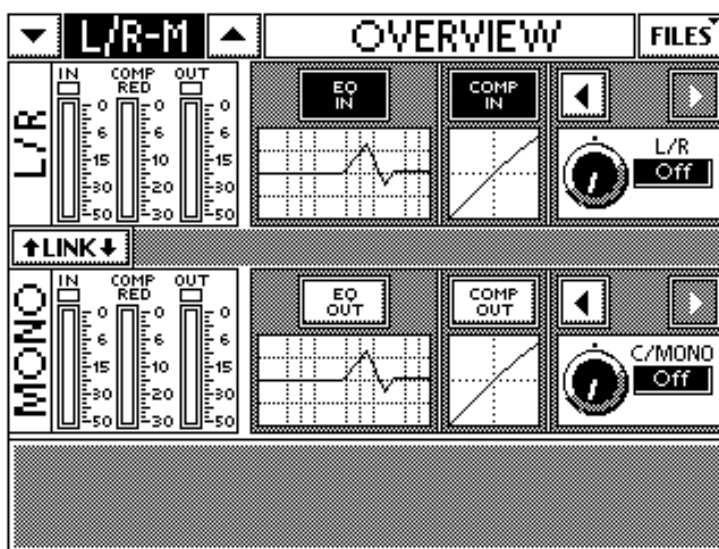

Figure 6-11 Master OVERVIEW

If the L/R and MONO outputs are linked, they share the same EQ and compressor settings. If unlinked, they have independent settings. If they are unlinked and then linked, the MONO output inherits the L/R settings.

EQ and COMP

Touch the EQ or compressor graphs to open their specific Touchscreens. Touch the arrows to toggle the processor order. Touch the **EQ IN**, **COMP IN** buttons to toggle their processors in/out.

6.4 Four-Band Equalizer

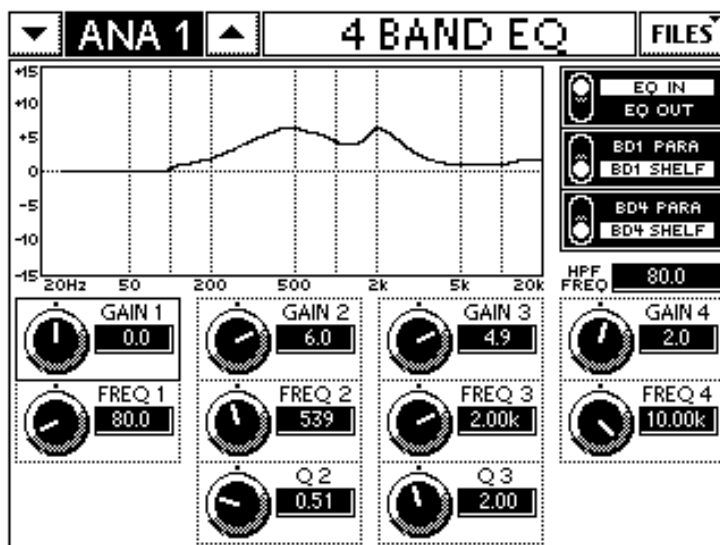

Figure 6-12 Analog Channel 4 BAND EQ

The 24 Mic/Line inputs, eight additional Line Inputs, and eight Flex-Groups can each access a four-band EQ. The four bands can be configured in two ways:

- Bands 1–4 are identical with standard parametric controls: Gain, Frequency, and Q.
- Bands 2 and 3 are standard parametric filters while bands 1 and 4 can be individually set to be low- and high-shelf filters, respectively. This configuration is common on many analog consoles.

The entire EQ function can be switched in/out of the DSP chain from the Touchscreen, allowing an A/B signal comparison.

Select an analog channel and press the **EQ QuickMix** button to display the 4 BAND EQ Touchscreen. The Band 1 and 4 types are toggled from light switch buttons. The graph summarizes the EQ settings.

Gain

Each of the four filter's GAIN is adjustable ± 15 dB in 0.1 dB increments. Each band defaults to zero gain.

Frequency

The **FREQ** parameter determines the filter's center frequency, at which the gain setting is applied. **FREQ** is adjustable from 20 Hz to 20 kHz in scaled steps. For shelf-filter bands, the **FREQ** setting designates the half-power frequency: the frequency at which the power has decreased to half its maximum.

The default frequencies for each band are:

- Band 1: 80 Hz
- Band 2: 500 Hz
- Band 3: 2 kHz
- Band 4: 10 kHz

HPF Freq

The **HPF FREQ** field displays the value of the HPF set from the V-POT CONTROL area.

Q (Bandwidth)

The **Q** control adjusts the *width* of a parametric filter band and allows a wide or narrow boost and cut. **Q** is measured from the half-power points of the filter on both sides and is adjustable in the range 0.1–2.0 octaves in scaled steps.

NOTE: *Bandwidth and Q are often used as synonyms but are a source of frequent confusion because their values are inversely related. As the bandwidth widens and increases in value, the Q value decreases.*

6.5 Six-Band Equalizer

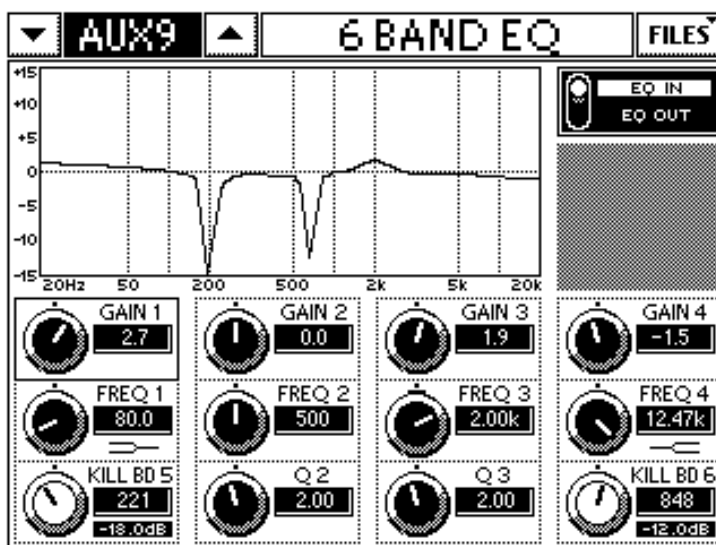

Figure 6-13 6 BAND EQ

The Master LR and C/Mono outputs can each access a six-band EQ comprised of a four-band EQ and two *kill filters*.

6.5.1 Four-Band EQ

Bands 1–4 are identical to the four-band EQ (page 76), except bands 1 and 4 are set to low- and high-shelf filters, respectively.

6.5.2 Kill Filters

Kill filters are specialized parametric EQ bands designed to eliminate feedback at a specific frequency without using up an entire EQ filter. Bands 5 and 6 control the kill filter frequency. The default frequency of both kill filters is 1 kHz.

Push the bottom-left and right QuickMix knobs to cycle through the four *kill filter states* shown in Table 6-2. Each state increases in gain reduction and decreases (narrows) the bandwidth. The filters default to the *off* setting. Pressing and holding **CTRL** while adjusting the kill filter QuickMix knob resets the kill filter to the off position. The kill filter setting is displayed beneath its frequency field.

Table 6-2 Kill Filter States

	Off	State 1	State 2	State 3
Gain Reduction (dB)	0	6	12	18
Bandwidth (octaves)	NA	1/10	1/20	1/30

6.6 Dynamics

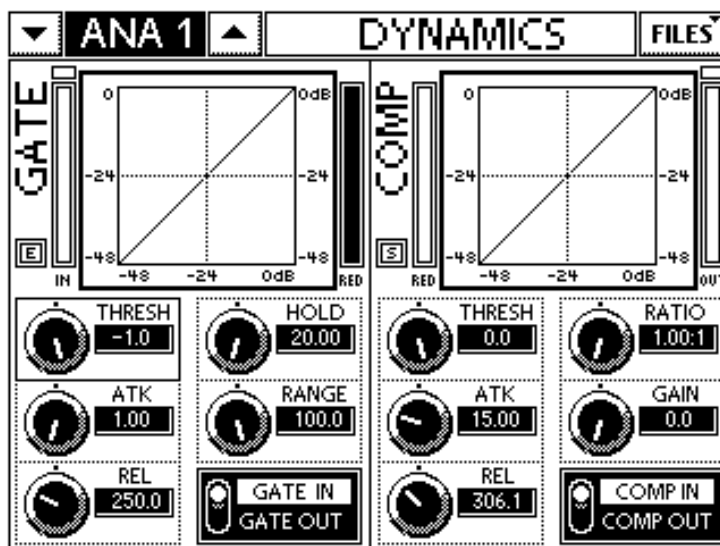

Figure 6-14 DYNAMICS

Press the **DYN** QuickMix button to display the **DYNAMICS** Touchscreen. Touch the **GATE** or **COMP** graphs to display their respective Touchscreens.

6.6.1 Compressor

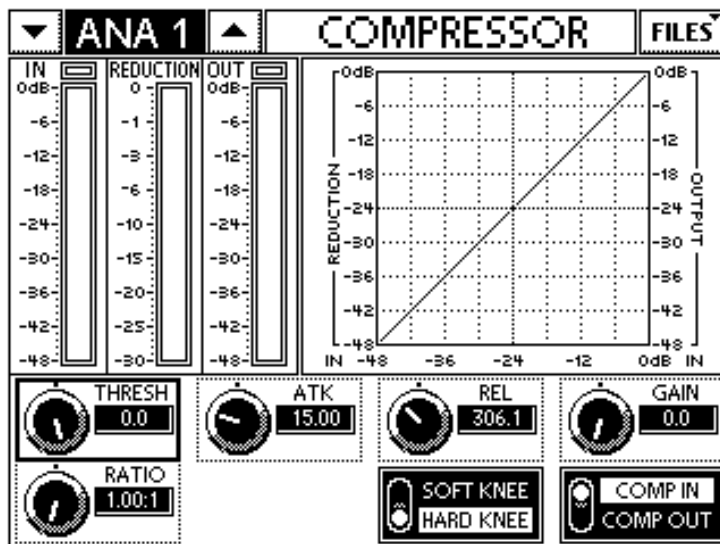

Figure 6-15 COMPRESSOR Touchscreen

The **IN/OUT** meters show the levels coming in/out of the compressor. The inverted **REDUCTION** meter displays the compressor's gain reduction.

The graph summarizes the compressor's parameter settings.

Threshold

The **THRESH** control adjusts the level above which attenuation begins. It is adjustable in the range -60 to 0 dBFS in increments of 0.1 dBFS; the default value is 0 dB.

Ratio

The **RATIO** control sets the rate of gain reduction applied to the signal as it exceeds the threshold. The ratio can vary between gentle compression and peak limiting. The ratio range is 1:1 (no gain reduction) to the maximum of ∞ :1 (peak limiting). The default setting is 1:1.

Attack

The **ATK** control varies the time the compressor takes to begin gain reduction after the signal exceeds the threshold. The **ATK** time range is 1–300 ms and the increments are scaled such that the faster attack settings have finer adjustments. The default setting is 15 ms.

Release

The **REL** controls the time the compressor takes to stop applying gain reduction after the signal decreases below the threshold. The **REL** time range is 50 ms to 3 s. The default setting is 200 ms. **REL** is scaled such that the faster release settings have finer adjustments.

Gain

The **GAIN** control sets the gain applied to the signal after the compressor. This allows *makeup* gain to compensate for the compressor's level reduction. The **GAIN** range is 0–20 dB in increments of 0.1 dB. The default setting is 0 dB.

Hard/Soft Knee

The **HARD/SOFT KNEE** switch toggles the compressor *knee* characteristic. It is accessible only from the COMPRESSOR Touchscreen (not from DYNAMICS).

HARD KNEE: As the signal exceeds the threshold, gain reduction is immediately applied at the full ratio setting.

SOFT KNEE: As the signal approaches the threshold, gain reduction is gradually applied up to the full ratio setting.

6.6.2 Gate/Expander

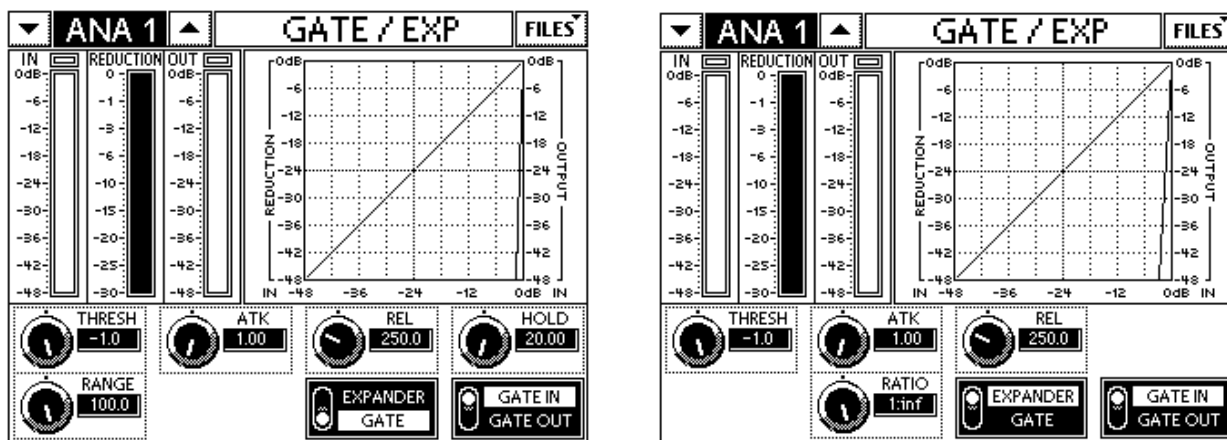

Figure 6-16 GATE (left) and EXP Touchscreens

The Gate/expander has five controls and an on/off switch. There is a mode button to switch between the gate and downward expander.

The **IN/OUT** meters show the levels coming in/out of the gate/expander. The inverted **REDUCTION** meter displays the gain reduction.

The graph summarizes the gate/expander's parameter settings.

Threshold

The **THRESH** control adjusts the level below which attenuation begins. It is adjustable in the range -60 to -1 dBFS in increments of 0.1 dBFS. The default threshold value is -1 dBFS.

Range/Ratio

In Gate mode, the **RANGE** control sets the amount of attenuation that occurs when the signal drops below the Threshold. The **RANGE** is variable from -100 dB to -1 dB in increments of 0.1 dB. The default is -100 dB.

In Expander mode, this setting is called **RATIO** and sets the expansion gain reduction ratio from 1:1 to 1:∞. The default is 1:∞.

Hold

The **HOLD** control adjusts the time the Gate/Expander stays open after the signal drops below the threshold before gain reduction begins. **HOLD** is adjustable in the range 0–5 s; the default is 0 s.

Attack

The **ATK** control adjusts the time for the gate to open and pass the signal through once the signal exceeds the threshold after reduction has occurred. **ATK** is adjustable in the range 1–30 ms. **ATK** is scaled such that the faster settings can have finer adjustments. The default **ATK** is 1 ms.

Release

The **REL** control adjusts the time for the gate to close and begin gain reduction after the signal drops below the threshold and the hold time has passed. **REL** is adjustable from 50 ms to 3 s and is scaled such that faster settings can have finer the adjustments. The default **REL** time is 250 ms.

Expander/Gate Mode

The **EXPANDER/GATE** switch toggles from Gate to Expander. It is accessible only from the GATE/EXP Touchscreen, not from DYNAMICS. In Expander mode, the, **HOLD**, **ATK** and **REL** controls operate the same as in Gate mode but the **RANGE** control is displayed as **RATIO**. This can produce smoother sounding gain reduction in many situations.

In Expander Mode, **RANGE** is replaced by **RATIO** that sets the rate of gain reduction as the signal drops below the Threshold. Ratio is variable between 1:20 (maximum gain reduction) to 1:1 (no gain reduction). As **RATIO** approaches to 1:1, the resolution between values increases.

6.7 Snapshots

Snapshots are not presently available from the Touchscreen but can be edited from the TT control software. This section presents the TT control screens and instructions for their use.

Press the **SNAP** QuickMix button to open the SNAPSHOTS window in TT control (or choose **Snapshots** from the main TT control menu). The left side of the window displays a vertical list of all snapshots with **PROTECT**, **CLEAR**, **STORE**, and **RECALL** buttons below (Figure 6-17).

Touch a snapshot name in the SNAPSHOT TITLE field to select it. An empty snapshot slot displays *Empty* while a used snapshot displays *Snapshot n* where *n* is the automatically incremented snapshot number.



Figure 6-17 Snapshots main screen

6.7.1 PROTECT

The **PROTECT** button allows the user to prevent a snapshot from being cleared or overwritten. To protect a snapshot:

- select a snapshot then click the **PROTECT** button;
- *OR*
- click in the LOCK column next to the desired snapshot.

When protected, a lock icon appears in the LOCK column to the right of the snapshot name. The absence of an icon next to a snapshot denotes that it can be deleted or overwritten. In Figure 6-17, snapshots 1, 2, and 5 are locked and the rest are unlocked.

To edit or clear a locked snapshot:

- select it and click the **PROTECT** button;
- *OR*
- click the lock icon.

6.7.2 CLEAR

Click the **CLEAR** button to clear the selected snapshot. The snapshot is deleted and the name returns to *Empty*. Attempting to clear a protected snapshot produces a warning message.

6.7.3 STORE

Click the **STORE** button to store the current console state (with filtering if active) in the selected snapshot. Attempting to store over a protected snapshot produces a warning message.

6.7.4 RECALL

Click the **RECALL** button to recall the selected snapshot (with filtering if active).

6.7.5 Snapshot Filtering

Snapshots can be filtered so only the desired channels and/or parameters are stored and recalled. Snapshot filtering can be useful in a variety of situations:

- recall Fader, and Mute settings while leaving DSP settings unaffected
- recall settings on a few channels leaving the rest unchanged
- change internal effects presets through a specific order while leaving every other console setting for live use

The Snapshots window has the following areas relevant to filtering:

- **SNAPSHOT PARAMETER FILTERING**

The **ACTIVE** button at the top of this area must be selected or filtering will not occur. Only the selected parameters are included in the Snapshot. The **OTHERS** button refers to DSP functions other than those listed. **INT 1–4** are the internal effects.

- **CHANNEL FILTERING SELECT**

Click on the **BANK 1–4** or **MATRIX A–H** buttons and select the desired channels for that bank from the list on the right. Only the selected channels are included in the Snapshot.

- **CHANNELS FILTERED**

Displays the selected channels for the current Snapshot.

6.8 Aux Master

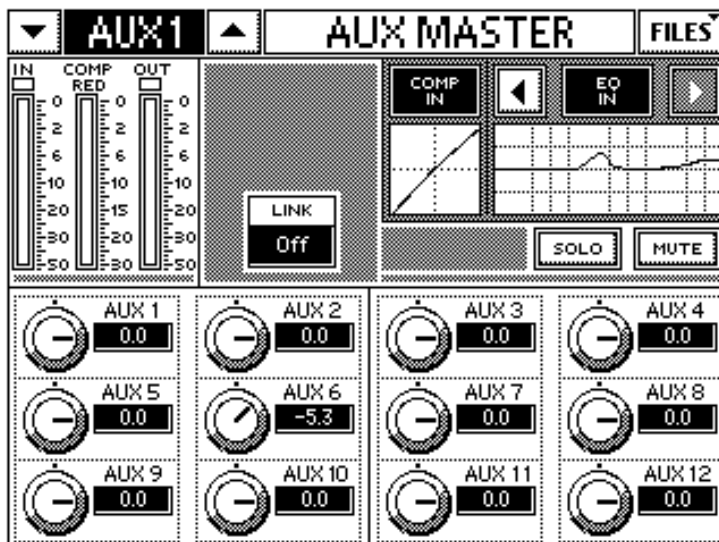

Figure 6-18 AUX MASTER

Press the **AUX MSTR** QuickMix button to display the AUX MASTER Touchscreen. The 12 Master Aux Send levels are controlled by their corresponding QuickMix knobs. Change the selected Aux Master by pressing the desired knob. The active Aux Master is displayed on the top-left of the Touchscreen.

The overview information for the selected Aux Master is displayed on the top-half of the Touchscreen: metering, link status, compression and EQ.

Each Aux Send Master also has its own OVERVIEW Touchscreen (see page 73), which can be displayed by pressing the **FAT** QuickMix button.

EQ and Comp

Touch the EQ or compressor areas (or press the **EQ** or **DYN** QuickMix buttons) to open their respective Touchscreens. See *Six-Band Equalizer* on page 78 and *Compressor* on page 79.

LINK

If the selected Aux Master is stereo linked, the linked Aux number is listed below **LINK**; it displays OFF otherwise.

6.9 Groups/Auxes

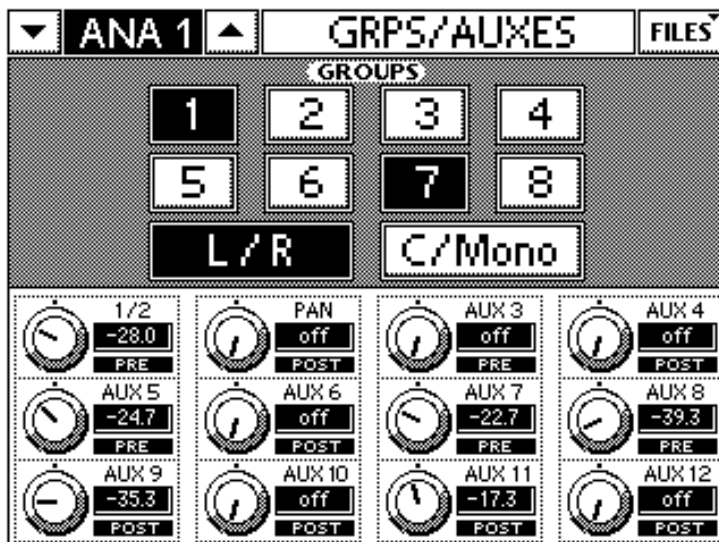

Figure 6-19 GRPS/AUXES

From the Group or Aux OVERVIEW screen, touch in the AUXES area to open the GRPS/AUXES Touchscreen.

6.9.1 GROUPS

Touch a GROUPS button to assign the selected channel to that Group. The highlighted buttons indicate assignments (in Figure 6-19, no Group is assigned).

6.9.2 AUXES

Adjust the QuickMix knob corresponding to an Aux number or pair to set the selected channel's level to that Aux. An Aux labeled with two numbers indicates a stereo-linked Aux, which have a **PAN** control to position the selected channel in the stereo Aux field. Push the QuickMix knob associated with an Aux level to toggle it between pre- and post-fader.

6.10 Matrix Mix

Display the MATRIX MIX Touchscreen by pressing the **MATRIX** QuickMix button. Activate the matrix by selecting **ALL ACTIVE** which sends the Matrix signals to the Group outputs.

Matrix-Plus delivers extremely flexible 11 x 8 matrix mixing. Although the default inputs to each matrix are Groups 1–8, Left, Right, and Center, virtually any other signal can be patched into the Matrix.

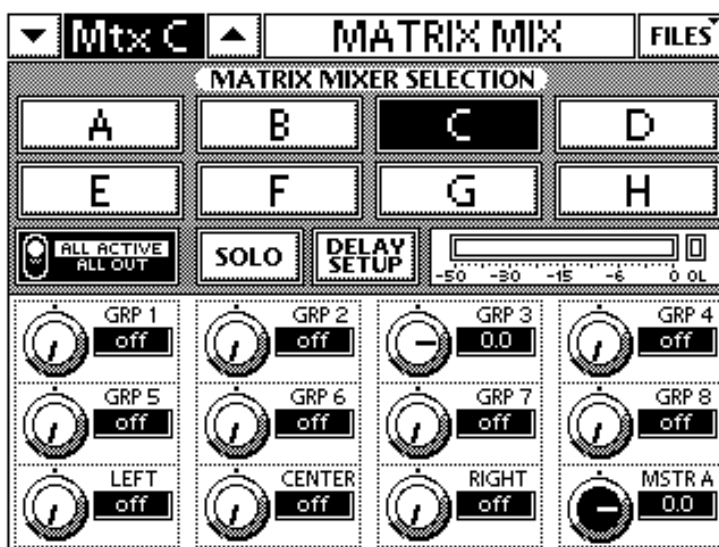

Figure 6-20 MATRIX MIX

Press one of the **MATRIX MIXER SELECTION** buttons **A–H** to select a Matrix for editing. The knobs control the input levels to the selected Matrix. The bottom-right knob controls the master output level for the selected Matrix, which is reflected on the meter.

Press the desired QuickMix knob to display the screen in Figure 6-21 to select the Matrix input signals.

MATRIX MIX		FILES
CATEGORY	CHANNEL	SIGNAL TYPE
Analog 1-24	1	Post
Digital 1-24	2	Pre
Line Inputs	3	
Groups	4	
Main	5	
Stereo Input	6	OK
Internal Effects	7	CANCEL
	8	

Figure 6-21 MATRIX MIX Selection/Assignment

The following input signals are available to the matrix:

- Analog inputs 1–24 pre/post fader
- Digital inputs 25–48 pre/post fader
- Line inputs 1–8 pre/post fader
- Groups 1–8 Mono, Left/Right, Center (if available)
- Main Left, Right or CTR/Mono post fader
- Stereo inputs Left and Right pre/post fader
- Internal effects returns pre/post fader

6.10.1 Delay

Each Matrix output has a 600 ms delay to allow time alignment of multiple speaker groups in a large venue. The Matrix Output Delay is adjusted by touching **DELAY SETUP** from the **MATRIX MIX** Touchscreen.

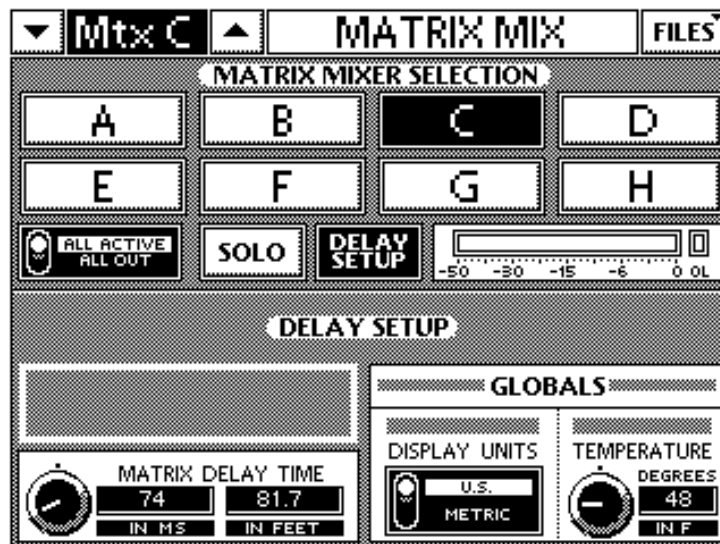

Figure 6-22 MATRIX MIX DELAY SETUP Touchscreens

MATRIX DELAY TIME: 0–600 ms in 0.5 ms increments

This parameter converts a distance to a delay time. The units of measurements for distance depend on those selected in **DISPLAY UNITS**.

DISPLAY UNITS: U.S. or METRIC

TEMPERATURE: Enter the present temperature.

The temperature affects the conversion between delay time and distance. The range is 20–120°F (-10° to 50°C) in 1° increments.

6.11 Effects

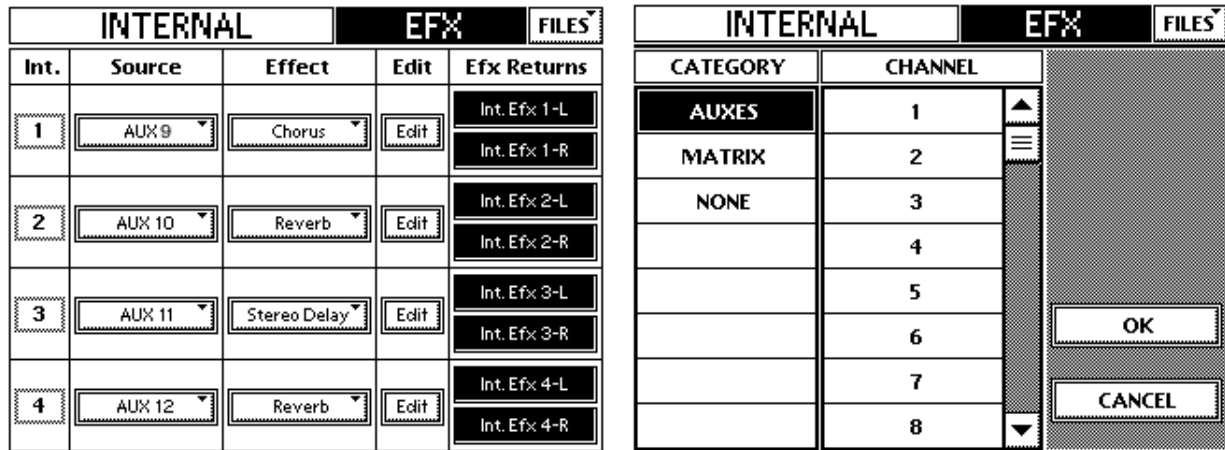

Figure 6-23 INTERNAL EFX Touchscreens

Press the **EFX** QuickMix button to display the INTERNAL EFX Touchscreen (left of Figure 6-23). Touch an Effect to change the effect. Touch an **Edit** button to edit the selected effect. Touch a Source to change the source feeding the Effect; this displays the Touchscreen on the right of Figure 6-23.

6.12 Setup

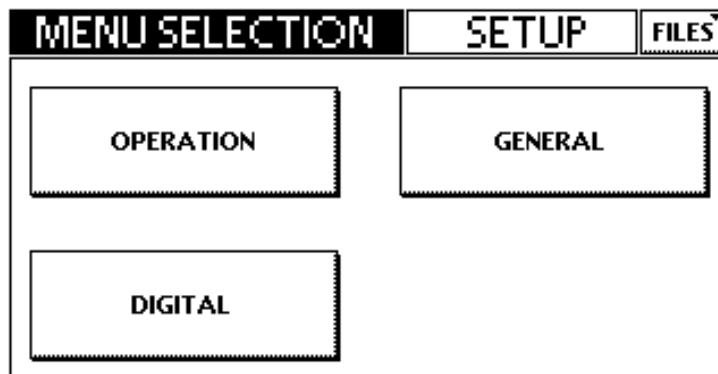

Figure 6-24 SETUP MENU SELECTION

Press the **SETUP** QuickMix button to display the SETUP MENU SELECTION Touchscreen. Touch the **OPERATION**, **GENERAL**, and **DIGITAL** buttons to configure those attributes.

6.12.1 Operation



Figure 6-25 OPERATION SETUP

Choose between the two CENTER MODE options: **L/R + MONO** and **LCR**. See *L/R+Mono and LCR Modes* on page 52 for an explanation of these modes.

6.12.2 General

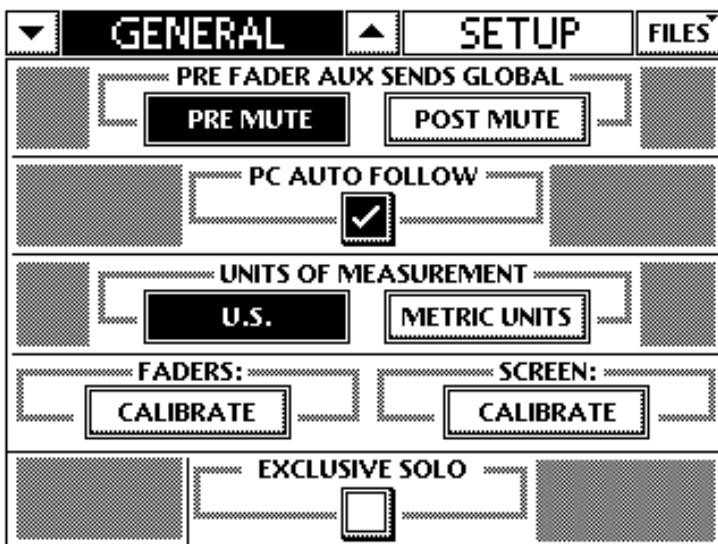

Figure 6-26 GENERAL SETUP

PRE FADER AUX SENDS GLOBAL

Pre-fader Aux sends can be globally changed to pre- or post-mute. This feature facilitates using the TT24 for both FOH and monitors. For example, the monitors are normally fed by pre-fader Aux sends. During a set change, to reset the mics for the next band, they must be muted in the monitors. This requires the pre-fader Aux sends to be pre-mute.

PC AUTO FOLLOW

The TT control software can be set to operate independently from the Touchscreen or to *follow* it. When independent, two users may simultaneously control the TT24, one from the Touchscreen and one from the PC.

UNITS OF MEASUREMENT

This allows U.S. or metric units of measurement to be used for console settings.

FADERS and SCREEN CALIBRATE

Touch either of these **CALIBRATE** buttons to follow simple instructions to calibrate the faders and Touchscreen.

EXCLUSIVE SOLO

Select **EXCLUSIVE SOLO** to deactivate previous SOLO selections upon a new one. For example, if channel 1 is soloed, pressing channel 2's **SOLO** button automatically unsolos channel 1. Even with **EXCLUSIVE SOLO** selected, multiple channels can be soloed by holding down the **Ctrl** key while pressing a **SOLO** button. When not selected, multiple channels can be soloed simultaneously.

6.12.3 Digital

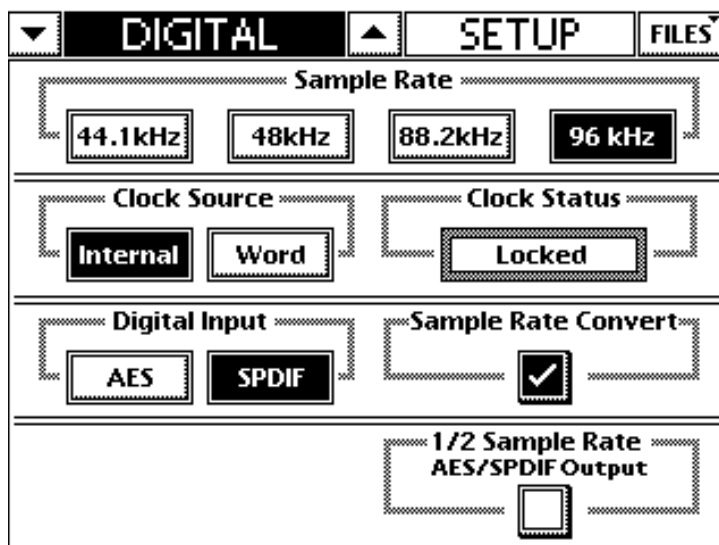

Figure 6-27 DIGITAL SETUP

Sample Rate

Select the desired sample rate: 44.1kHz, 48kHz, 88.2kHz, or 96kHz.

Clock Source

Select the desired clock source: **Internal** or **Word**.

Clock Status

This field highlights **Locked** if the TT24 has successfully locked onto its external **Word** Clock Source. It is not highlighted if the Clock Source is set to **Internal** or it has not locked to a Word Clock Source.

Digital Input

Select the desired Digital Input: **AES** or **SPDIF**. Only one of these can be active at a time.

Sample Rate Convert

Select this field to activate automatic sample rate conversion for the selected Digital Input.

1/2 Sample Rate AES/SPDIF Output

Select this field to output a signal with half the selected sample rate to the selected Digital Input.

6.13 Utility

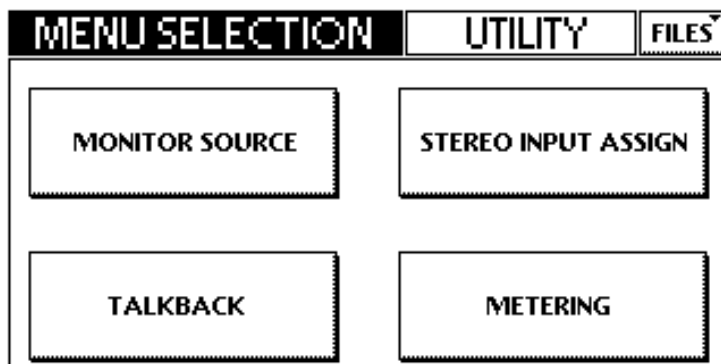

Figure 6-28 UTILITY MENU SELECTION

Press the **UTIL** QuickMix button to open the **UTILITY MENU SELECTION** Touchscreen. Touch the **MONITOR SOURCE**, **STEREO INPUT ASSIGN**, **TALKBACK**, and **METERING** buttons to configure those attributes.

6.13.1 MONITOR SOURCE

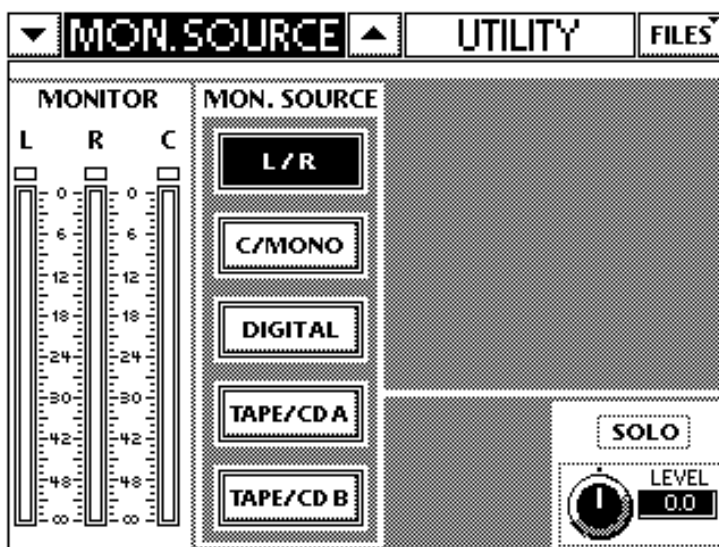

Figure 6-29 UTILITY MONITOR SOURCE

The MONITOR SOURCE Touchscreen assigns a source for the monitor outputs and the headphones. The monitor analog gain controls are located in the UTILITY area (see page 38). Choose among these sources: **L/R**, **C/MONO**, **DIGITAL**, **TAPE/CD A**, or **TAPE/CD B**.

The **L**, **R**, and **C** meters mirror the hardware meters and display the **L**, **R**, and **C/M** Monitor outputs. Each meter has an overload LED at the top.

The **SOLO LEVEL** adjusts the level of the solo group. It varies ± 15 dB in 0.1 dB increments and its default level is 0 dB. The **RUDE SOLO** LED lights when a channel is soloed.

6.13.2 TALKBACK

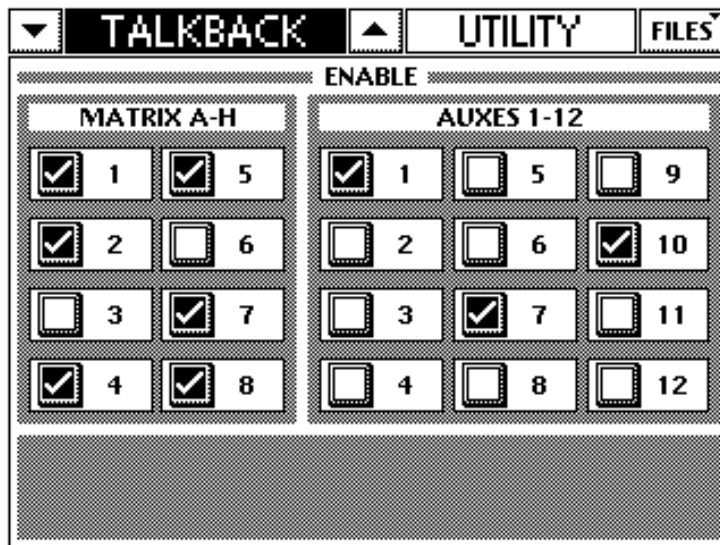

Figure 6-30 UTILITY TALKBACK

Select the desired Matrix and Aux channels to enable for Talkback.

6.13.3 STEREO INPUT ASSIGN

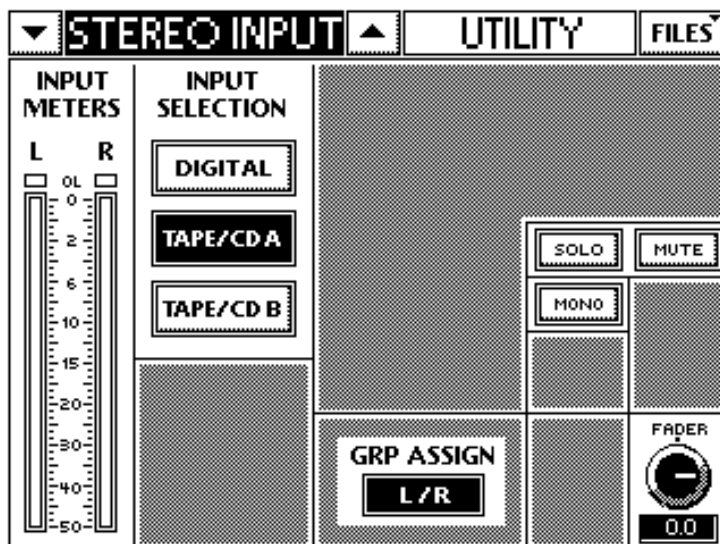

Figure 6-31 UTILITY STEREO INPUT ASSIGN

This screen routes the selected stereo input (**DIGITAL**, **TAPE/CD A**, or **TAPE/CD B**) to the main mix.

SOLO

Activate the **SOLO** button to cue the signal prior to routing to the speakers.

MONO

Activate the **MONO** button to send the summed mono signal to *both* the **LEFT** and **RIGHT** outputs.

GRP ASSIGN

Select **L/R** in the GRP ASSIGN area to route to stereo source to the **LEFT** and **RIGHT MAINS** outputs.

INPUT METERS

The meters show the pre-fader, pre-L/R assign level of the stereo input.

6.13.4 METERING

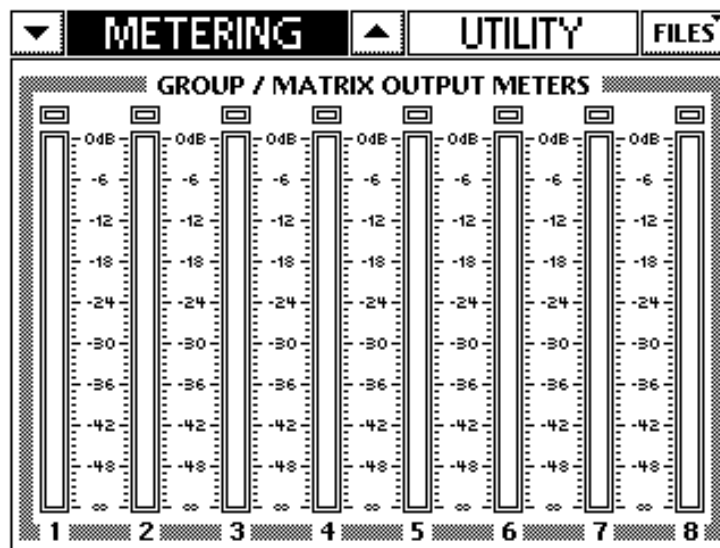

Figure 6-32 UTILITY METERING

These meters show the levels for the Group/Matrix outputs.

6.14 File Management

The TT24 parameters related to the physical/acoustical space and equipment can be saved to a Venue. These parameters are from the SETUP Touchscreens: Operation, General, and Digital. See page 90.

6.14.1 Load and Save Venue

The FILE MGMT SELECT MENU allows loading and saving a Venue.

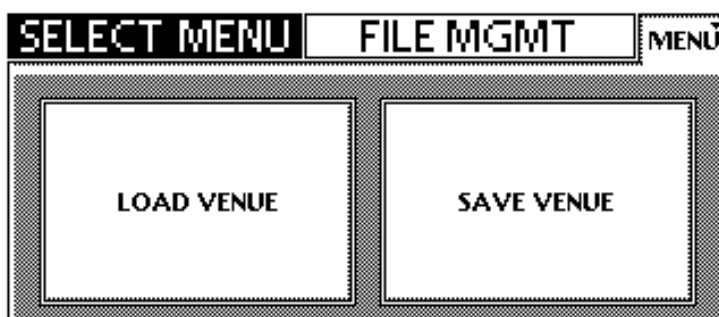

Figure 6-33 FILE MGMT SELECT MENU

Touch **LOAD VENUE** to select a venue from a list of all venues on the console.

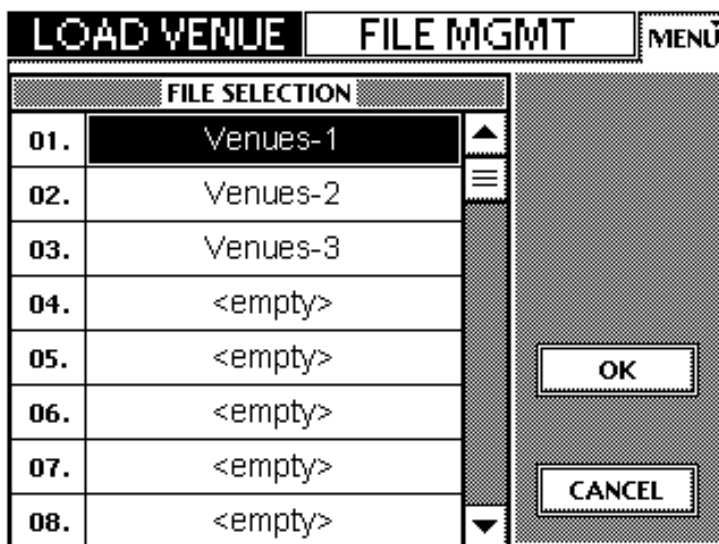

Figure 6-34 FILE MGMT LOAD VENUE

Use the up and down Touchscreen arrows to scroll if the list is too large to fit. Touch the name of the desired venue and touch the **OK** button.

Touch **SAVE VENUE** from Figure 6-33 to save the current venue.

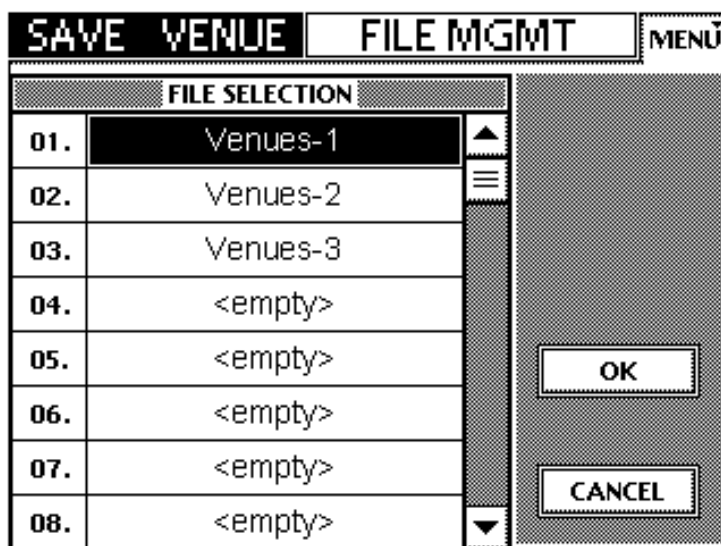

Figure 6-35 FILE MGMT SAVE VENUE

Touch an existing name to save over this Venue or <empty> to save to a new Venue. Touch **OK** to exit.

6.14.2 DSP Preset Management

Preset management is not presently available from the Touchscreen but can be accessed from the TT control software.

The TT24 DSP settings can be saved and restored to a file by choosing **Save Preset** and **Load Preset**, respectively, from the **Files** menu.

Appendix A: Specifications

Analog	
Mic Preamp	
Frequency response	+0, -2 dB, 10 Hz to 20 kHz (Mic In to Insert Out)
Distortion (THD + N)	< 0.003% @ +20 dBu output, 20 Hz to 20 kHz (Mic In to Insert Out)
Noise	
Equivalent Input Noise (EIN)	-128 dBu
Residual Noise	-103 dBu (Mic In to Insert Out @ 0 dB gain)
Common Mode Rejection Ratio (CMRR)	>60 dB @ 1 kHz, gain @ maximum (Mic In to Insert Out)
Rise Time	< 3 μ s
Slew Rate	3.6 V/ μ s
Input Gain Control Range	
Mic In	0 dB to +60 dB
Line In	-20 dB to +40 dB
Phantom Power	48 VDC
Input Impedance	
Mic Input	2 k Ω , balanced
Line Input	10 k Ω
Aux Returns, CD/Tape A and B	10 k Ω
Maximum Input Level	
Mic Input	+22 dBu
Line Input	+22 dBu
Aux Returns, CD/Tape A and B	+22 dBu
Output Impedance	
L/R/C-Mono, Group/Matrix Out	150 Ω
Aux Send, Monitor Out	150 Ω
CD/Tape A and B Out	600 Ω

Maximum Output Level	
Insert Out	+22 dBu
L/R/C-Mono, Group/Matrix Out	+26 dBu
Aux Send, Monitor Out	+21 dBu
CD/Tape A and B Out	+22 dBu
Phones Out	500 mW into 100 Ω
System	
Frequency Response (Gain at unity) Mic Input to Main Output	+0, -1 dB, 10 Hz to 20 kHz @ 44.1 kHz +0, -2 dB, 10 Hz to 40 kHz @ 96 kHz +0, -0.5 dB, 14 Hz to 27.5 kHz @ 96 kHz
Distortion (THD + N)	
Mic Input to Main Output	< 0.02% @ +4 dBu input, 44.1 kHz, 10 Hz to 20 kHz < 0.03% @ +4 dBu input, 96 kHz, 10 Hz to 20 kHz
AES Input with SRC to AES Output	< 0.0002% @ -10 dBFS input, 44.1 kHz, 10 Hz to 22.05 kHz < 0.0006% @ -10 dBFS input, 96 kHz, 10 Hz to 48 kHz
Signal to Noise Ratio	-78 dBu (ref. +4 dBu Mic In to Main Out)
Dynamic Range	101 dB (Mic In to Main Out)
Maximum Voltage Gain	96 dB (Mic In to Main Out)
Crosstalk	
Adjacent Inputs	-110 dB @ 1 kHz
Adjacent Main Outputs	-95 dB @ 1 kHz
Adjacent Aux Outputs	-115 dB @ 1 kHz
Digital	
Faders	
Type	100 mm motorized, movement sensitive
Resolution	128 steps
Sampling Frequency	44.1, 48, 88.2, 96 kHz (Internal and External)
Digital Signal Processing	32-bit floating point resolution
Propagation Delay (Mic In to Main Out)	< 3.8 ms @ 44.1 kHz < 1.7 ms @ 96 kHz

Word Clock Input	
Minimum Level	0.4 V p-p
Duty Cycle	50%
Impedance	75 Ω
External Word Clock Lock Range	44.1 kHz = 42.5 kHz – 45.8 kHz 48 kHz = 46.4 kHz – 49.4 kHz 88.2 kHz = 85.0 kHz – 90.7 kHz 96 kHz = 92.2 kHz – 98.2 kHz
Word Clock Output	
Open Circuit Level	5 V p-p
Duty Cycle	50%
Impedance	75 Ω
AES Input (IEC-60958-3)	
Sample Rate with SRC	32 kHz – 96 kHz
Sample Rate without SRC	System sample rate exactly
Maximum Level	0.4 V p-p
Impedance	110 Ω , transformer coupled
AES Output (IEC-60958-3)	
Sample Rate	System rate or switchable half system rate
Level into 110 Ω	5 V p-p
Impedance	110 Ω , transformer coupled
S/PDIF Input	
Sample Rate with SRC	32 kHz – 96 kHz
Sample Rate without SRC	System sample rate exactly
Minimum Level	0.4 V p-p
Impedance	75 Ω
S/PDIF Output	
Sample Rate	System rate or switchable half system rate
Level into 75 Ω	0.5 V p-p
Impedance	75 Ω , transformer coupled

General	
AC Power Requirements	100–240 VAC, 50–60 Hz, auto-switching
Fuse	6 A/250 V
Operating Temperature	10°C–40°C (50°F–104°F)
Physical Dimensions	
Height	10.4 in/265 mm
Width	42.6 in/1083 mm (including handles)
Depth	25.0 in/636 mm
Weight	71.0 lb/32.2 kg

Disclaimer

Since we are always striving to make our products better by incorporating new and improved materials, components, and manufacturing methods, we reserve the right to change these specifications at any time without notice.

Appendix B: Configurations and Block Diagrams

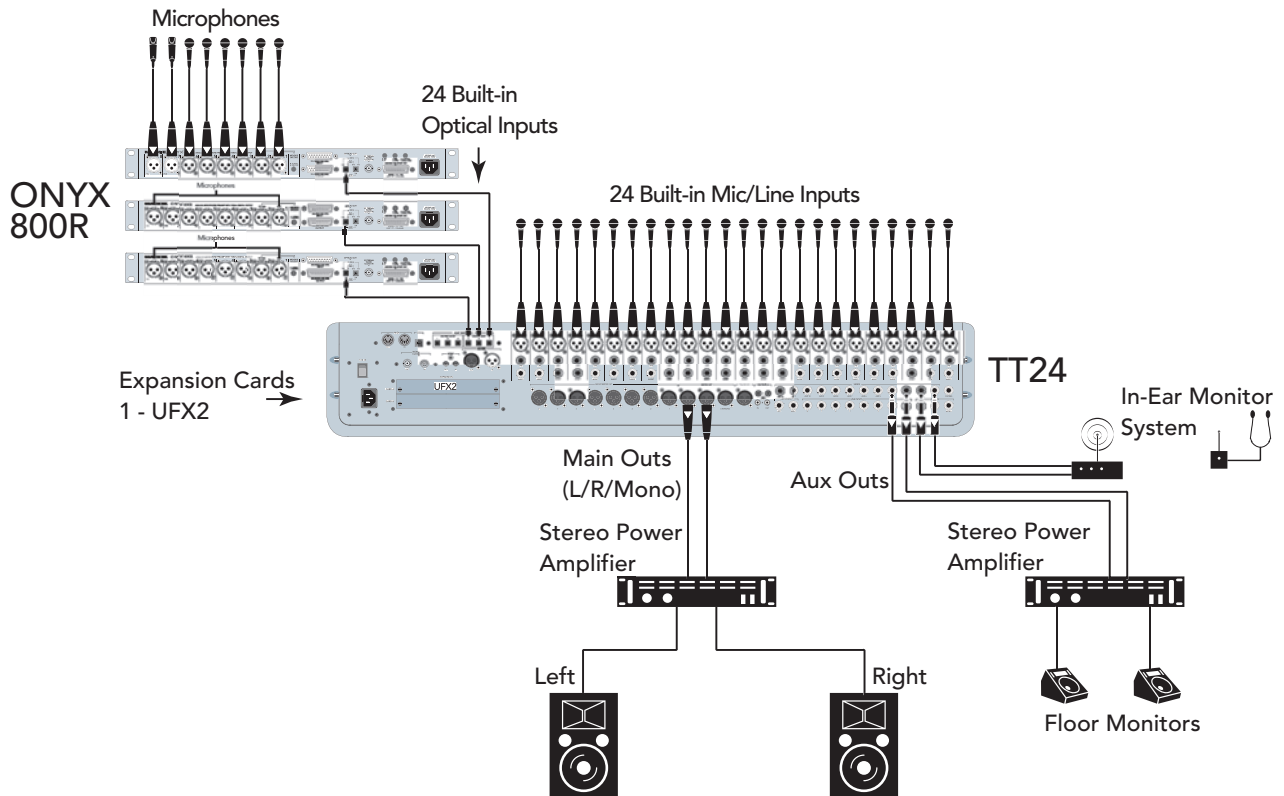

Figure B-1 48-channel TT24 system

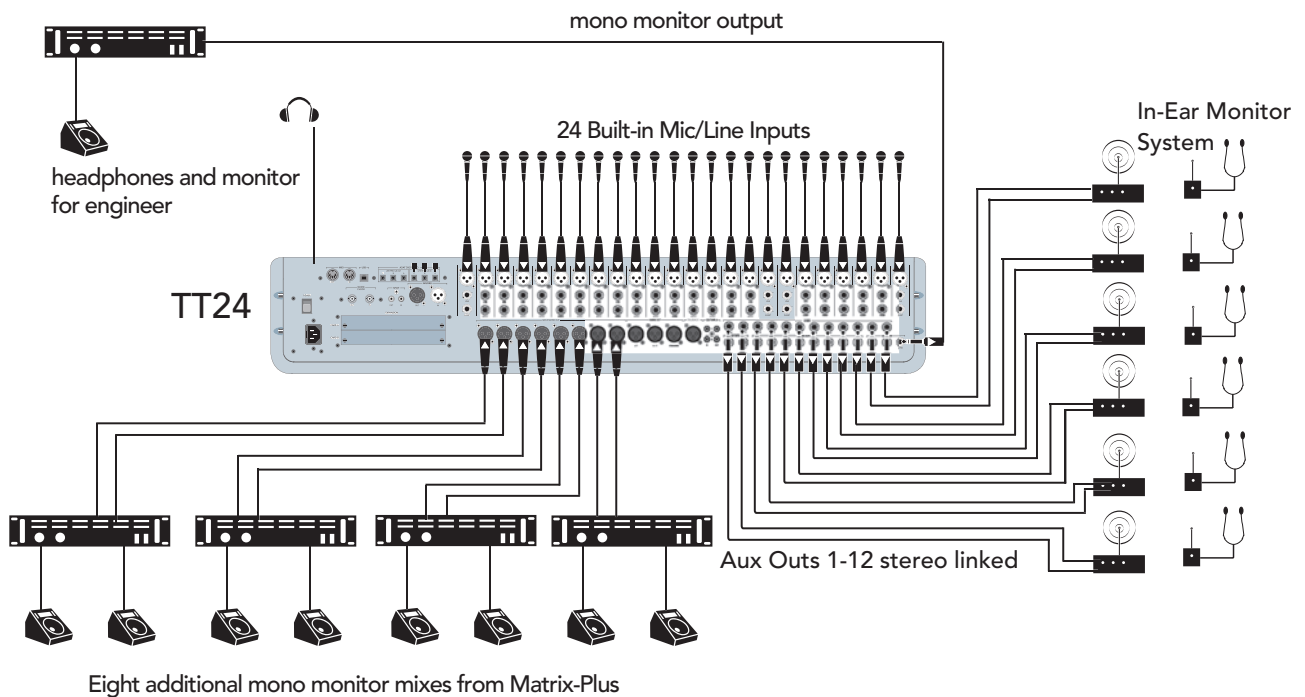

Figure B-2 TT24 system with in-ear monitors

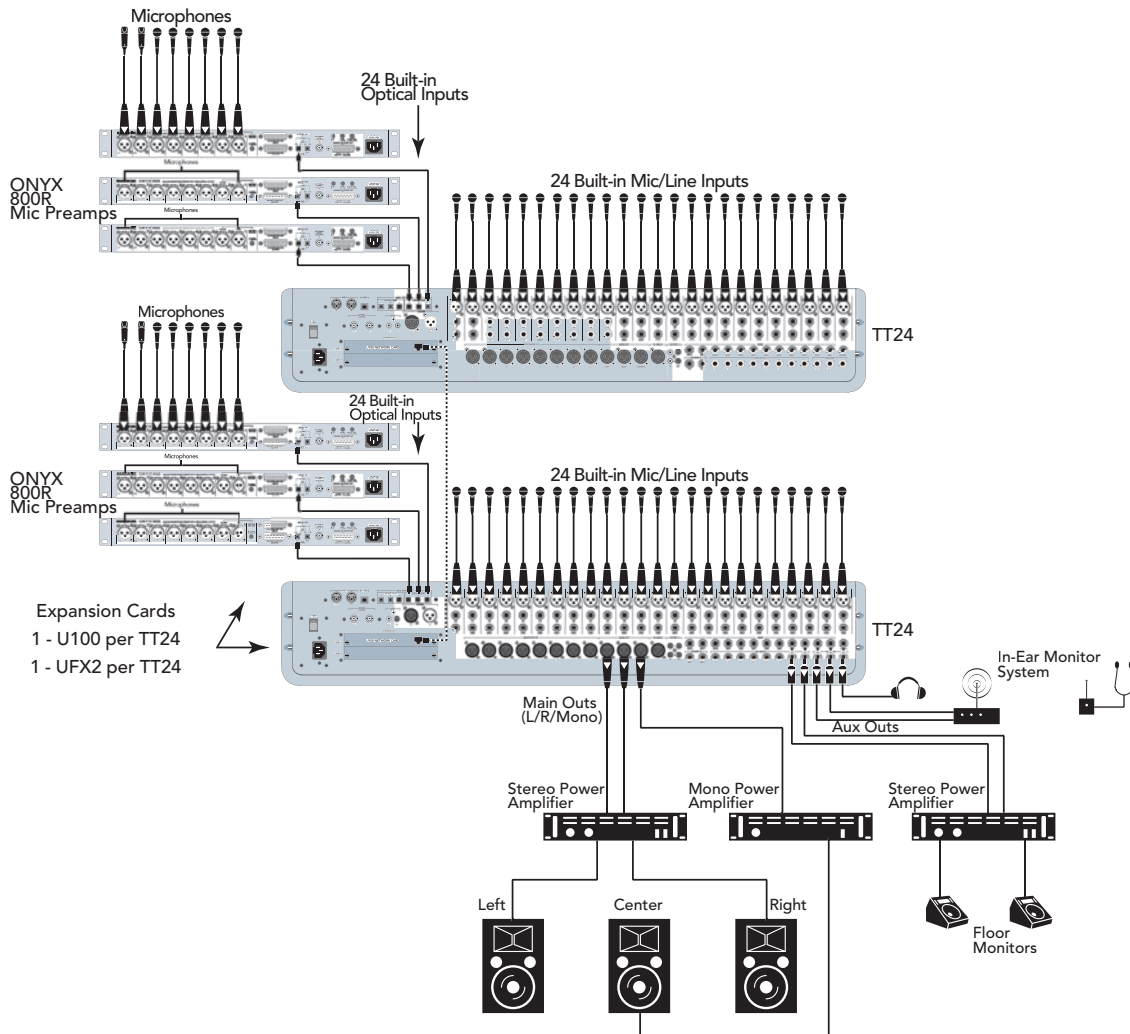

Figure B-3 96-channel system with two TT24s

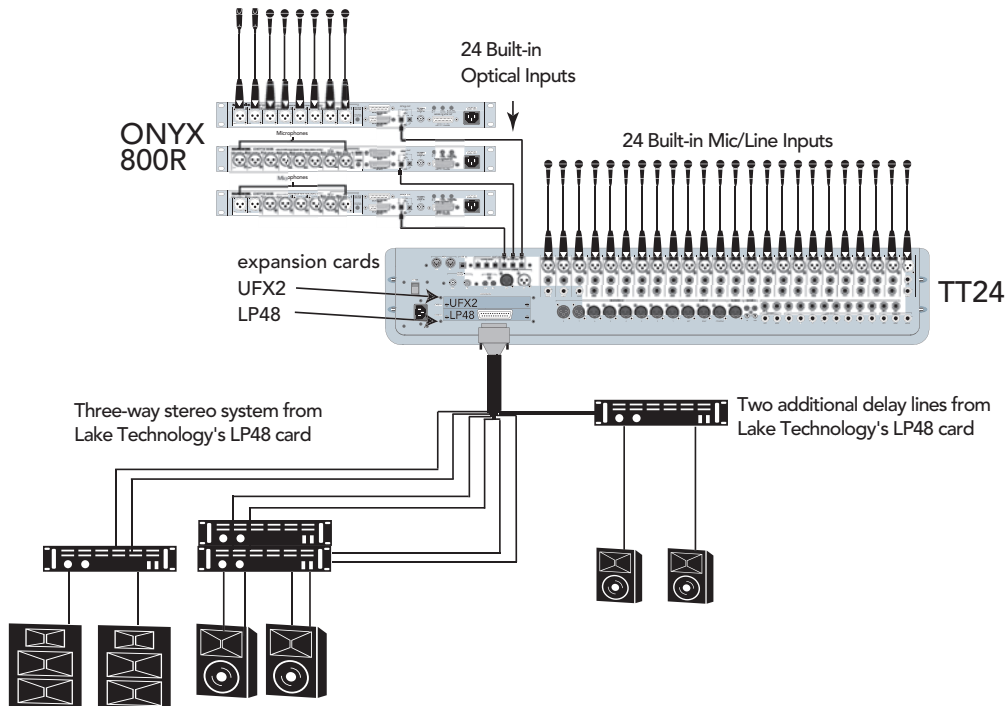

Figure B-4 Three-way stereo system using Lake Technology's LP48 expansion card

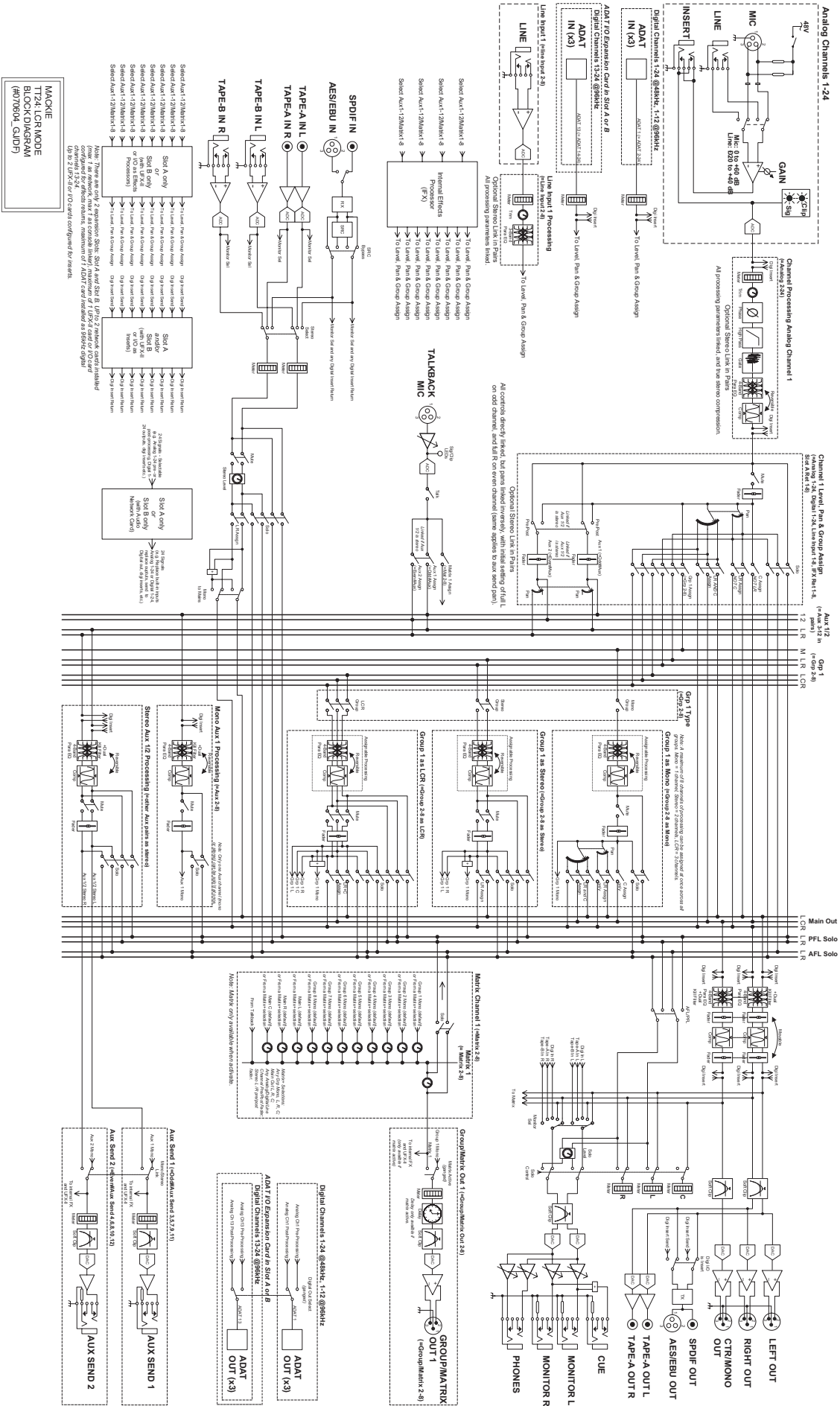

Figure B-6 TT24 in LCR mode

Warranty Service

Details concerning Warranty Service are spelled out in Appendix D: *Warranty Information*.

If you think your TT24 has a problem, please do everything you can to confirm it before calling for service. Doing so might save you from the deprivation of your TT24 and the associated suffering.

These may sound obvious to you, but the following are things you can check.

Troubleshooting

No Power

- Our favorite question: Is it plugged in?
- Make sure the power cord is securely seated in the IEC socket and plugged all the way into the AC outlet.
- Make sure the AC outlet is live (check with a tester or lamp).
- Is the POWER switch on? Make sure the POWER switch on the rear panel is in the ON position (up).
- Is the Touchscreen on the front panel illuminated? If not, make sure the AC outlet is live.
- Are all the lights out in your building? If so, contact your local power company to get power restored.
- If the Touchscreen is not illuminated, and you are certain that the AC outlet is live, it will be necessary to have your TT24 serviced. There are no user serviceable parts inside. See *Repair* on page 108 to find out how to proceed.

Bad Channel

- Is the MUTE button pushed in?
- Is the input GAIN control for the channel turned up?
- Is the fader turned up?
- Is the signal source turned up? Make sure the signal level from the selected input source is high enough to light up the Signal LED just above the channel's V-Pot.
- Is the channel assigned to a Group? Make sure the Group is assigned to the Left and Right MAINS OUT.

- Is there something plugged into the CHANNEL INSERT jack? Try unplugging any INSERT devices.
- Try the same source signal in another channel, set up exactly like the suspect channel.

Bad Output

- Is the associated level control (if any) turned up?
- If it's a stereo pair, try switching them around. For example, if a left output is presumed dead, switch the left and right cords at the mixer end. If the problem stays on the left side, it's not the mixer.

Bad Sound

- Is the input connector plugged completely into the jack?
- Is it loud and distorted? Make sure the input GAIN control for the input is set correctly. Reduce the signal level on the input source if possible.
- If possible, listen to the signal with headphones plugged into the input source device. If it sounds bad there, it's not the Onyx causing the problem.

Noise/Hum

- Turn down all the faders on the RETURNS bank. If the noise disappears, it's coming from whatever is plugged into the RETURNS (LINE Inputs or EFX Returns).
- Turn down each channel, one by one. If the noise disappears, it's coming from whatever is plugged into that channel.
- Check the signal cables between the input sources and the TT24. Disconnect them one by one. When the noise goes away, you'll know which input source is causing the problem.
- Sometimes it helps to plug all the audio equipment into the same AC circuit so they share a common ground.

Repair

Service for Mackie products is available at one of our factory-authorized service centers. Service for Mackie products living outside the United States can be obtained through local dealers or distributors.

If your TT24 needs service, follow these instructions:

1. Review the preceding troubleshooting suggestions. Please.
2. Call Tech Support at 1-800-898-3211, 7 am to 5 pm PST, to explain the problem in detail. If it appears that the TT24 needs repair, you will be given a Service Request Number. Have your TT24's serial number ready. You must have a Service Request Number before you can obtain service at a factory-authorized service center.
3. Keep this user's manual and the detachable linecord. We don't need them to repair the mixer.

4. Pack the TT24 in its original packaging, including protective wrap, end-caps, and box. This is VERY IMPORTANT. When you call for the Service Request Number, please let Tech Support know if you need new packaging. Mackie is not responsible for any damage that occurs due to non-factory packaging.
5. Include a legible note stating your name, shipping address (no P.O. boxes), daytime phone number, Service Request Number, and a detailed description of the problem, including how we can duplicate it.
6. Write the Service Request Number in BIG PRINT on top of the box. Product shipped without the Service Request Number will be refused.
7. Tech Support will tell you where to ship the loudspeaker for repair. We suggest insurance for all forms of cartage.
8. We'll try to fix the TT24 within five business days. Once it is repaired, we'll ship it back the same way in which it was received. This paragraph does not necessarily apply to non-warranty service.

NOTE: *You must have a sales receipt from an Authorized Mackie Dealer to qualify for a warranty repair.*

Need Help?

You can reach a technical support representative Monday through Friday from 7 AM to 5 PM PST at: 1-800-898-3211

After hours, visit www.mackie.com and click Support, or email us at:

techmail@mackie.com

TT24 Limited Warranty

Please keep your sales receipt in a safe place.

A. LOUD Technologies Inc. warrants all materials, workmanship and proper operation of this product for a period of one year from the original date of purchase. If any defects are found in the materials or workmanship or if the product fails to function properly during the applicable warranty period, LOUD Technologies, at its option, will repair or replace the product. This warranty applies only to equipment sold and delivered within the U.S. by LOUD Technologies Inc. or its authorized dealers.

B. Failure to register online or return the product registration card will not void the one-year warranty.

C. Service and repairs of Mackie products are to be performed only at a factory-authorized facility (see D below). Unauthorized service, repairs, or modification will void this warranty. To obtain repairs under warranty, you must have a copy of your sales receipt from the authorized Mackie dealer where you purchased the product. It is necessary to establish purchase date and determine whether your Mackie product is within the warranty period.

D. To obtain factory-authorized service:

1. Call Mackie Technical Support at 800-898-3211, 7 AM to 5 PM Monday through Friday (Pacific Time) to get a Service Request Number. Products returned without a Service Request Number will be refused.
2. Pack the product in its original shipping carton. Also include a note explaining exactly how to duplicate the problem, a copy of the sales receipt with price and date showing, and your return street address (no P.O. boxes or route numbers, please!). If we cannot duplicate the problem or establish the starting date of your Limited Warranty, we may, at our option, charge for service time.
3. Ship the product in its original shipping carton, freight prepaid to the authorized service center. The address of your closest authorized service center will be given to you by Technical Support.

IMPORTANT: *Make sure that the Service Request Number is plainly written on the shipping carton.*

E. LOUD Technologies reserves the right to inspect any products that may be the subject of any warranty claims before repair or replacement is carried out. LOUD Technologies may, at our option, require proof of the original date of purchase in the form of a dated copy of the original dealer's invoice or sales receipt. Final determination of warranty coverage lies solely with LOUD Technologies.

F. Any products returned to one of the LOUD Technologies factory-authorized service centers and deemed eligible for repair or replacement under the terms of this warranty will be repaired or replaced within thirty days of receipt. LOUD Technologies and its authorized service centers may use refurbished parts for repair or replacement of any product. Products returned to LOUD Technologies that do not meet the terms of this Warranty will be not be repaired unless payment is received for labor, materials, return freight, and insurance. Products repaired under warranty will be returned freight prepaid by LOUD Technologies to any location within the boundaries of the USA.

G. LOUD Technologies warrants all repairs performed for 90 days or for the remainder of the warranty period. This warranty does not extend to damage resulting from improper installation, misuse, neglect or abuse, or to exterior appearance. This warranty is recognized only if the inspection seals and serial number on the unit have not been defaced or removed.

H. LOUD Technologies assumes no responsibility for the quality or timeliness of repairs performed by an authorized service center.

I. This warranty is extended to the original purchaser and to anyone who may subsequently purchase this product within the applicable warranty period. A copy of the original sales receipt is required to obtain warranty repairs.

J. This is your sole warranty. LOUD Technologies does not authorize any third party, including any dealer or sales representative, to assume any liability on behalf of LOUD Technologies or to make any warranty for LOUD Technologies Inc.

K. THE WARRANTY GIVEN ON THIS PAGE IS THE SOLE WARRANTY GIVEN BY LOUD TECHNOLOGIES INC. AND IS IN LIEU OF ALL OTHER WARRANTIES, EXPRESS AND IMPLIED, INCLUDING THE WARRANTIES OF MERCHANTABILITY AND FITNESS FOR A PARTICULAR PURPOSE. THE WARRANTY GIVEN ON THIS PAGE SHALL BE STRICTLY LIMITED IN DURATION TO ONE YEAR FROM THE DATE OF ORIGINAL PURCHASE FROM AN AUTHORIZED MACKIE DEALER. UPON EXPIRATION OF THE APPLICABLE WARRANTY PERIOD, LOUD TECHNOLOGIES INC. SHALL HAVE NO FURTHER WARRANTY OBLIGATION OF ANY KIND. LOUD TECHNOLOGIES INC. SHALL NOT BE LIABLE FOR ANY INCIDENTAL, SPECIAL, OR CONSEQUENTIAL DAMAGES THAT MAY RESULT FROM ANY DEFECT IN THE MACKIE PRODUCT OR ANY WARRANTY CLAIM. Some states do not allow exclusion or limitation of incidental, special, or consequential damages or a limitation on how long warranties last, so some of the above limitations and exclusions may not apply to you. This warranty provides specific legal rights and you may have other rights which vary from state to state.

MACKIE®

16220 Wood-Red Road NE • Woodinville, WA 98072 • USA
www.mackie.com • sales@mackie.com

United States and Canada: 800.898.3211
Fax: 425.487.4337

Europe, Asia, Central and South America: 425.487.4333
Middle East and Africa: 31.20.654.4000