

# RP70

# Modeling Guitar Processor



**Digitech**

# Owner's Manual



The symbols shown above are internationally accepted symbols that warn of potential hazards with electrical products. The lightning flash with arrowpoint in an equilateral triangle means that there are dangerous voltages present within the unit. The exclamation point in an equilateral triangle indicates that it is necessary for the user to refer to the owner's manual.

These symbols warn that there are no user serviceable parts inside the unit. Do not open the unit. Do not attempt to service the unit yourself. Refer all servicing to qualified personnel. Opening the chassis for any reason will void the manufacturer's warranty. Do not get the unit wet. If liquid is spilled on the unit, shut it off immediately and take it to a dealer for service. Disconnect the unit during storms to prevent damage.

## **ELECTROMAGNETIC COMPATIBILITY**

This unit conforms to the Product Specifications noted on the **Declaration of Conformity**. Operation is subject to the following two conditions:

- this device may not cause harmful interference, and
- this device must accept any interference received, including interference that may cause undesired operation.

Operation of this unit within significant electromagnetic fields should be avoided.

- use only shielded interconnecting cables.

## **WARNING FOR YOUR PROTECTION PLEASE READ THE FOLLOWING:**

KEEP THESE INSTRUCTIONS

HEED ALL WARNINGS

FOLLOW ALL INSTRUCTIONS

THE APPARATUS SHALL NOT BE EXPOSED TO DRIPPING OR SPLASHING LIQUID AND NO OBJECT FILLED WITH LIQUID, SUCH AS VASES, SHALL BE PLACED ON THE APPARATUS.

CLEAN ONLY WITH A DRY CLOTH.

DO NOT BLOCK ANY OF THE VENTILATION OPENINGS. INSTALL IN ACCORDANCE WITH THE MANUFACTURER'S INSTRUCTIONS.

DO NOT INSTALL NEAR ANY HEAT SOURCES SUCH AS RADIATORS, HEAT REGISTERS, STOVES, OR OTHER APPARATUS (INCLUDING AMPLIFIERS) THAT PRODUCE HEAT.

ONLY USE ATTACHMENTS/ACCESSORIES SPECIFIED BY THE MANUFACTURER.

UNPLUG THIS APPARATUS DURING LIGHTNING STORMS OR WHEN UNUSED FOR LONG PERIODS OF TIME.

Do not defeat the safety purpose of the polarized or grounding-type plug. A polarized plug has two blades with one wider than the other. A grounding type plug has two blades and a third grounding prong. The wide blade or third prong are provided for your safety. If the provided plug does not fit your outlet, consult an electrician for replacement of the obsolete outlet.

Protect the power cord from being walked on or pinched particularly at plugs, convenience receptacles, and the point where they exit from the apparatus.

Use only with the cart stand, tripod bracket, or table specified by the manufacturer, or sold with the apparatus. When a cart is used, use caution when moving the cart/apparatus combination to avoid injury from tip-over.



Refer all servicing to qualified service personnel. Servicing is required when the apparatus has been damaged in any way, such as power-supply cord or plug is damaged, liquid has been spilled or objects have fallen into the apparatus, the apparatus has been exposed to rain or moisture, does not operate normally, or has been dropped.

**POWER ON/OFF SWITCH:** The Power switch used in this piece of equipment DOES NOT break the connection from the mains.

**MAINS DISCONNECT:** The plug shall remain readily operable. For rack-mount or installation where plug is not accessible, an all-pole mains switch with a contact separation of at least 3 mm in each pole shall be incorporated into the electrical installation of the rack or building.

## DECLARATION OF CONFORMITY

Manufacturer's Name: DigiTech  
Manufacturer's Address: 8760 S. Sandy Parkway  
Sandy, Utah 84070, USA

declares that the product:  
Product name: RP 70

Product option: all (requires Class II power adapter that conforms to the requirements of EN60065, EN60742, or equivalent.)

conforms to the following Product Specifications:

Safety: IEC 60065 (7<sup>th</sup> ed. 2001)

EMC: EN 55013 (2001 + A1)  
EN 55020 (1991)

Supplementary Information:

The product herewith complies with the requirements of the Low Voltage Directive 72/23/EEC and the EMC Directive 89/336/EEC as amended by Directive 93/68/EEC.

Vice-President of Engineering-MI  
8760 S. Sandy Parkway  
Sandy, Utah 84070, USA  
Date: August 27, 2007

European Contact: Your local DigiTech Sales and Service Office or

Harman Music Group  
8760 South Sandy Parkway  
Sandy, Utah 84070 USA  
Ph: (801) 566-8800  
Fax: (801) 568-7583

## Warranty

We at **DigiTech®** are very proud of our products and back up each one we sell with the following warranty:

1. The warranty registration card must be mailed within ten days after purchase date to validate this warranty.
2. DigiTech warrants this product, when used solely within the U.S., to be free from defects in materials and workmanship under normal use and service.
3. DigiTech liability under this warranty is limited to repairing or replacing defective materials that show evidence of defect, provided the product is returned to DigiTech WITH RETURN AUTHORIZATION, where all parts and labor will be covered up to a period of one year. A Return Authorization number may be obtained from DigiTech by telephone. The company shall not be liable for any consequential damage as a result of the product's use in any circuit or assembly.
4. Proof-of-purchase is considered to be the burden of the consumer.
5. DigiTech reserves the right to make changes in design, or make additions to, or improvements upon this product without incurring any obligation to install the same on products previously manufactured.
6. The consumer forfeits the benefits of this warranty if the product's main assembly is opened and tampered with by anyone other than a certified DigiTech technician or, if the product is used with AC voltages outside of the range suggested by the manufacturer.
7. The foregoing is in lieu of all other warranties, expressed or implied, and DigiTech neither assumes nor authorizes any person to assume any obligation or liability in connection with the sale of this product. In no event shall DigiTech or its dealers be liable for special or consequential damages or from any delay in the performance of this warranty due to causes beyond their control.

**NOTE:** The information contained in this manual is subject to change at any time without notification. Some information contained in this manual may also be inaccurate due to undocumented changes in the product or operating system since this version of the manual was completed. The information contained in this version of the owner's manual supersedes all previous versions.

# Table of Contents

## Section One - Introduction

Getting Acquainted.....	1
Included Items .....	1
About the RP70 .....	2
Performance Mode.....	2
Edit Mode.....	2
Bypass Mode.....	2
Tuner Mode.....	2
Tone Library Button.....	4
Effects Library Button.....	4
Effects Level Button.....	4
Master Level Button.....	4
Presets .....	5
A Guided Tour of the RP70.....	6
Front Panel.....	6
Rear Panel.....	10
Getting Started.....	13
Making Connections.....	13
Mono Operation - Amplifier .....	13
Stereo Operation.....	14
Applying Power .....	16

## Section Two - Editing Functions

Editing/Creating Presets.....	17
Storing/Copying a Preset.....	18

## Section Three - Models and Effects

About the Models.....	20
Model Definitions .....	21
Pickup/Wah .....	21
Compressor .....	22
Amplifier/Distortion Models .....	23
EQ.....	25
Noise Gate.....	25
Chorus/FX.....	26
Chorus.....	26
Flanger .....	27
Phaser .....	27
Tremolo.....	27
Panner.....	27
Vibrato.....	27
Rotary Speaker .....	27
YaYa™ .....	28
Auto Ya™ .....	28
Step Filter.....	28
Envelope Filter .....	28
Detune.....	28
Pitch Shift .....	28
DigiTech Whammy™ .....	29
Delay .....	29
Reverb .....	31

## Section Four - Other Functions

Optional Expression Pedal.....	32
Drum Machine.....	34
Factory Reset.....	34

## Section Five - Appendix

Specifications.....	35
Tone Library.....	37
Effects Library.....	38
Preset List.....	39

**Disclaimer:** DigiTech, Production Modeling, Grunge, Death Metal, DOD, DigiTech Whammy, Multi-Chorus, Ya Ya, Johnson Amplification and AudioDNA2 are trademarks of Harman International Industries, Incorporated in the U.S. and other countries. Fender Tweed Deluxe, Fender Blackface Twin Reverb, Fender Twin Reverb, Marshall Super Lead, Marshall Slant, Marshall Master Volume, Marshall Straight, Vox AC30, Mesa Boogie, Dunlop Cry Baby, Vox Clyde McCoy Wah, Ibanez Tube Screamer, Boss DS-1, Electro-Harmonix Big Muff are products of DigiTech's competitors and trademarks of their respective companies in the U.S. and other countries and are not associated or affiliated with DigiTech or Harman International Industries, Incorporated. © 2007 Harman International Industries, Inc. All Rights Reserved.



## Section I - Introduction

### *Getting Acquainted*

Congratulations on your purchase of the RP70. You now have an incredibly advanced modeling guitar processor that can keep up with your creative impulses and even increase them. Armed with DigiTech®'s patented AudioDNA2® custom audio DSP chip, the RP70 gives you a huge selection of tones and effects, right at your fingertips. When you easily select an amp or distortion tone and an effects chain from the Tone Library or the Effects Library, you'll appreciate the accuracy in each model, and the dynamic interaction in each tone. Add a built-in drum machine, and you have the RP70: the key to unlock your creative potential.

### *Included Items*

Before you get started, please make sure that the following items have been included:

- **RP70**
- **PS200R Power Supply**
- **Warranty Card**

The utmost care was taken while your RP70 was being manufactured. Everything should be included and in perfect working order. If anything is missing, contact the factory at once. Please help us become acquainted with you and your needs by completing your warranty card or registering online at [www.digitech.com](http://www.digitech.com). It is your safeguard should a problem arise with your RP70.

---

## About the RP70

### Performance Mode

When you first apply power to the RP70, it powers up in Performance mode. Performance mode provides access to all of the presets within the RP70 via the **Up** and **Down Footswitches**. The **Edit Up/Down** buttons cycle through the effects in the matrix.

### Edit Mode

When you select an Effect with the **Edit Up/Down** buttons, you can adjust the Effect with the **Value Up/Down** buttons. (For descriptions of the Effects and their parameters, see page 20.) When you make changes to a preset's Effects, you must store the changes or they will be lost when you select a different preset or disconnect power to the RP70. See page 18 for a description of the Store procedure.

### Bypass Mode

The RP70 presets can be bypassed for a clean, unprocessed guitar signal. To bypass the RP70, press and release both **Footswitches** simultaneously. The Display reads  $b\text{Y}$  indicating the preset is bypassed. In Bypass mode, all buttons are disabled. Press either **Footswitch** to exit Bypass mode and return the RP70 to the last preset used.

### Tuner Mode

The Tuner in the RP70 allows you to quickly tune or check the tuning on your guitar. Enter Tuner mode by pressing and holding both **Footswitches** simultaneously. The Display briefly shows  $t\text{U}$  indicating that you are in Tuner mode. To begin tuning, play a note on your guitar (a harmonic at the 12th fret usually works best). The Display shows the note being played. The Matrix LEDs



indicate whether you are sharp or flat. The left 6 red LEDs indicate the note is flat and should be tuned up. The right 6 red LEDs indicate the note is sharp and should be tuned down. The center LED indicates the note is in tune. The output is muted in Tuner mode; rock the Expression Pedal to regain volume.

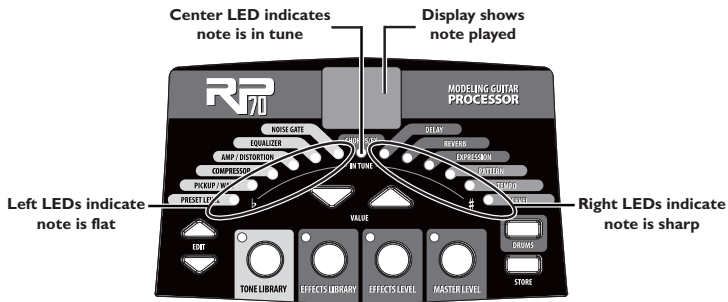

In Tuner mode, you can change your tuning reference with the **Value Up/Down** buttons. The default factory setting is A=440 Hz (displayed as 40). Other tuning references are A=A flat (displayed as  $\flat$ ), A=G (displayed as 9), and A=G flat (displayed as  $\flat$ ). The display window will briefly flash the currently selected tuning preference.

Exit Tuner mode by pressing either **Footswitch**.

### **Tone Library Button**

You can press this button at any time (except in Bypass or Tuner mode) to access the Tone Library, and then use the **Value Up/Down** buttons to select from a variety of genre-based amp tone defaults ranging from Blues to Metal to Country. Behind the scenes, the Compressor, Distortion, Pickup/Wah effects, Amp/Cabinet model, and EQ are configured to create a specified tone. You can further refine the sound by editing the preset (see *Editing/Creating Presets* on page 17). Changing between different Tone Library defaults does not change the Chorus/FX, Delay or Reverb, letting you experiment with different amp styles quickly in the context of the current effect chain.

### **Effects Library Button**

You can press this button at any time (except in Bypass or Tuner mode) to access the Effects Library and then use the **Value Up/Down** buttons to select from a variety of post-amplifier model effect chains (Chorus, Chorus + Delay, Delay + Reverb, etc.). You can further refine the sound by editing the preset (see *Editing/Creating Presets* on page 17). Changing between different Effects Library defaults does not change the Compressor, Distortion, Amp/Cabinet model, and EQ settings, letting you experiment with different effect chains quickly in the context of the current amp tone.

### **Effects Level Button**

You can press this button at any time (except in Bypass or Tuner mode) to access the Effects Level. This button changes the relative level of the post-amp effects (Chorus/FX, Delay, and Reverb). This can be thought of as an effects mix control, where increasing this button's value increases the level of these effects and decreasing its value decreases the level of these effects.

### **Master Level Button**

Press this button and use the **Value Up/Down** buttons to set the overall output level of the RP70.

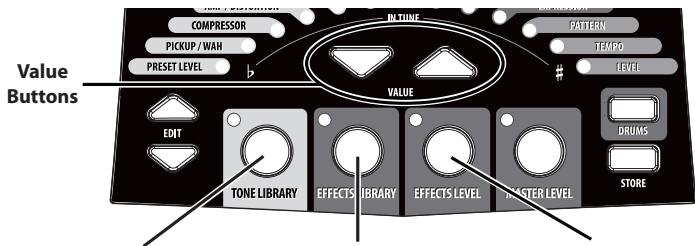

1. Access the Tone Library with this button and select a tone with the Value buttons.

2. Access the Effects Library with this button and select a tone with the Value buttons.

3. Access the effects level with this button and adjust the level with the Value buttons.

The **Tone Library** button, **Effects Library** button, and **Effects Level** button make it easy to quickly load preset tones, effects, and effects chains.

To learn about storing changes to presets, see page 18.

### Presets

Presets are numbered locations of programmed sounds which reside in the RP70. Presets are recalled with the Footswitches. The active effects in each preset are indicated by lighted LEDs in the Effect Matrix. The RP70 comes with 50 User presets (1-50) and 50 Factory presets (51-00). The User presets are locations where your creations may be stored. The Factory presets do not allow you to store any changes to them. From the factory, the 50 User presets are exact duplicates of the 50 Factory presets. This allows you to create your own presets without losing the sounds that came with the RP70.



## 1. **Footswitches**

These two Footswitches select presets, access the Tuner, or bypass the RP70. The Footswitch on the right will select the next preset up, and the Footswitch on the left will select the next preset down. Pressing both Footswitches together will bypass the currently selected preset. Pressing and holding both Footswitches for 2 seconds will access the Tuner. Press either Footswitch to exit Bypass or Tuner mode.

## 2. **Tone Library, Effects Library, Effects Level, and Master Level Buttons**

At the heart of creating presets in the RP70 are the Tone Library, Effects Library, and Effects Level buttons. By pressing one of these buttons and using the **Value Up/Down** buttons, you can select from 20 amp/distortion tones, 20 effects chains, or the overall post amp/distortion effects level respectively. The Master Level button accesses the master output volume parameter for the RP70. Each button is described in detail below.

### **Tone Library Button**

The Tone Library button accesses a library of preset amp tones. Press this button and then use the **Value Up/Down** buttons to select from a variety of genre-based amp tones ranging from Blues to Metal to Country (see page 37 for a list of available tones). Behind the scenes, the Pickup/Wah, Compressor, Amp/Distortion, and EQ are configured to create a specified tone. You can further refine the sound by editing the preset (see *Editing/Creating Presets* on page 17). Changing between different Tone Library selections does not change the Chorus/FX, Delay, or Reverb settings, allowing you to experiment with different amp styles quickly in the context of the current effect chain. The Display will read **CU** (for “custom”) when any of the associated effects have been changed from a default library setting.

### Effects Library Button

The Effects Library button accesses a library of preset effect configurations. Press this button and use the **Value Up/Down** buttons to select a variety of post-amplifier model effect chains (Chorus, Chorus + Delay, Delay + Reverb, etc...). You can further refine the sound by editing the preset (see *Editing/Creating Presets* on page 17). Changing between different Effects Library selections does not change the Pickup/Wah, Compressor, Amp/Distortion and EQ settings, allowing you to experiment with different effect chains quickly in the context of the current amp tone. The Display will read  $\overline{LU}$  (for “custom”) when any of the associated effects have been changed from a default library setting.

### Effects Level Button

The Effects Level button lets you adjust the levels of post-amp model effects (Chorus/FX, Delay, and Reverb). Press this button and use the **Value Up/Down** buttons to change the relative level of the post-amp effects (Chorus/FX, Delay, and Reverb). Think of it as an effects mix control where increasing this setting increases the level of these effects, while decreasing this setting decreases the level of these effects.

### Master Level Button

The Master Level button lets you adjust the output level of the RP70. Press this button and use the **Value Up/Down** buttons to change the output level of the RP70.

## 3. Edit Up/Down

The **Edit Up/Down** buttons select which effect is to be edited. As each effect is selected, the Display shows the effect setting. A decimal in the bottom right corner of the Display turns on when a preset has been modified. The **Edit Up/Down** buttons are also used to change the RP70 Drum Machine parameters (Note that Drum Machine settings are global for all presets and are not saved with the preset).

#### 4. **Value Up/Down**

The Value Up/Down buttons are used for editing effects, navigating Tone/Effects Libraries, adjusting Effects and Master Levels, and adjusting Drum Machine settings.

#### 5. **Display**

The Display provides information for different functions depending on the mode that has been selected. In Performance mode, the Display shows the currently selected preset number. In Edit mode, the Display shows the value of the effect being adjusted. A decimal in the bottom right corner of the Display turns on when a preset has been modified. In Tuner mode, the Display shows the note being played.

#### 6. **Matrix**

The matrix provides information regarding the current preset and Effect edit functions. In Performance mode, the LEDs next to each Effect provide a visual indication of which Effects are in use for the currently selected preset. While editing a preset, the LEDs indicate the Effect currently selected for editing. In Tuner mode, the LEDs indicate whether the note played is sharp, flat, or in tune.

#### 7. **Drums**

The Drums button is used to turn on and off the RP70's built-in drum machine. When the Drums button is turned on, the Drums button LED lights and the selected drum pattern plays continuously. Use the **Value Up/Down** buttons to change the pattern of the drum machine. See page 34 for more information about the drum machine.

#### 8. **Store**

The Store button is used to save your changes to the User presets. See page 18 for more information about storing presets.

## Rear Panel

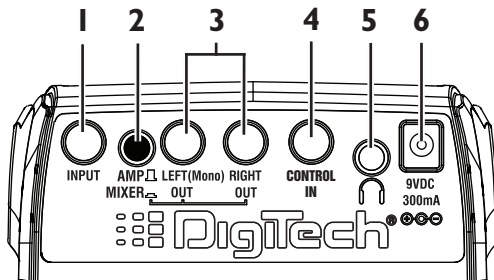

### 1. **Input**

Connect your instrument to this high-impedance TS input.

### 2. **Amp / Mixer**

This button optimizes the RP70's outputs for use when plugged into a guitar amp or a mixer/recording device. When set to Mixer ("In" position), the outputs are optimized for connecting to a mixer, recording device or headphones. When set to Amp ("Out" position), the outputs are optimized for running directly in to the input of a guitar amp.

### 3. **Left (Mono) and Right Outputs**

Connect the Left (Mono) output to the input of a single amplifier (or mixer input) for mono operation. Connect the Left and Right outputs to the inputs of 2 amplifiers (or 2 mixer channels) for stereo operation.



#### 4. **Control In**

Connect a passive volume pedal to this jack to control Volume, Wah, and DigiTech® Whammy™, or a variety of other effect parameters in the RP70.

#### 5. **Headphones**

Connect a pair of stereo headphones to this 1/8" jack. For proper frequency response, the Amp/Mixer switch should be set to Mixer ("in" position) when using headphones. Headphones with an impedance of 100 Ohms or less are recommended.

**Note:** The Headphones output can have either a mono or stereo signal, depending on what 1/4" outputs are connected. If neither (or both) 1/4" outputs are connected, the Headphones output will be in stereo. If a cable is connected to the Left (Mono) 1/4" output only, the Headphones output will be in mono.

#### 6. **Power Input**

Connect only the DigiTech PS200R power supply to this jack.



## Getting Started

### Making Connections

There are several different connection options available with the RP70. Before connecting the RP70, make sure that the power to your amplifier and the RP70 is turned off. There is no power switch on the RP70. To turn the RP70 on or off, connect or disconnect the included PS200R power supply from the **Power Input** jack.

### Mono Operation - Amplifier

Connect your guitar to the **Input** of the RP70. Connect a single mono instrument cable from the **Left (Mono) Output** of the RP70 to the instrument input or effect return on your amplifier. Set the **Amp/Mixer** switch to Amp.

**NOTE:** When using a guitar amp, it may be best to connect the Output of the RP70 to the effect return of the amplifier.

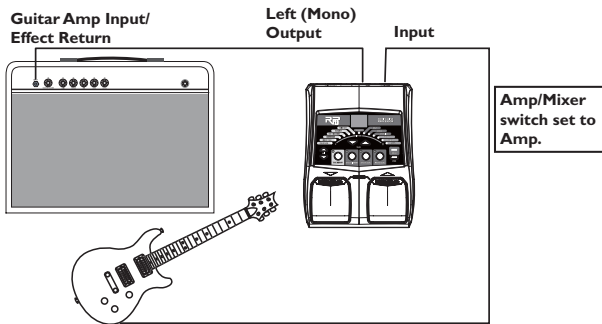

## Stereo Operation

For stereo operation connect the guitar to the **Input** of the RP70. Connect one cable to the RP70's **Left (Mono)** output, and another cable to the RP70's **Right** output. Connect one cable to the input of one amplifier, channel of a mixer, or power amp. Connect the second cable to a second amplifier, second channel of a mixer, or power amp. If connecting to a mixing console, set the pan controls of the mixer channels hard left and right in order to retain stereo separation. If connecting to a mixer, set the **Amp/Mixer** switch to Mixer. If connecting to two amplifiers, set the **Amp/Mixer** switch to Amp.

## Stereo Amp Setup

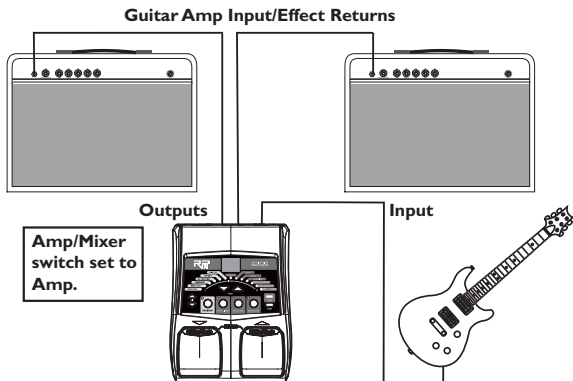

**NOTE:** When using a guitar amp, it may be best to connect the Output of the RP70 to the effect return of the amplifier.

## Stereo Mixer Setup

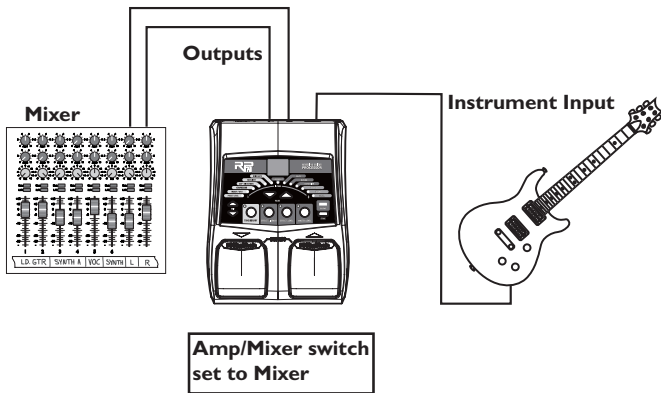

## Applying Power

Before applying power to anything, set your amp(s) to a clean tone and set the tone controls to a flat EQ response (on most amps, this would be 0 or 5 on the tone controls). Then follow the steps listed below.

1. Turn the amp volume all the way down.
2. Connect the plug of the PS200R power supply to the power jack on the rear panel of the RP70.
3. Connect the other end of the PS200R power supply to an AC outlet. Use the **Master Level** button and the **Value Up/Down** buttons to set the RP70's Master Level to "0".
4. Turn the power of your amplifier(s) to the on position and adjust the volume(s) to a normal playing level.
5. Use the **Master Level** button and the **Value Up/Down** buttons to gradually increase the RP70's Master Level to achieve the desired volume.

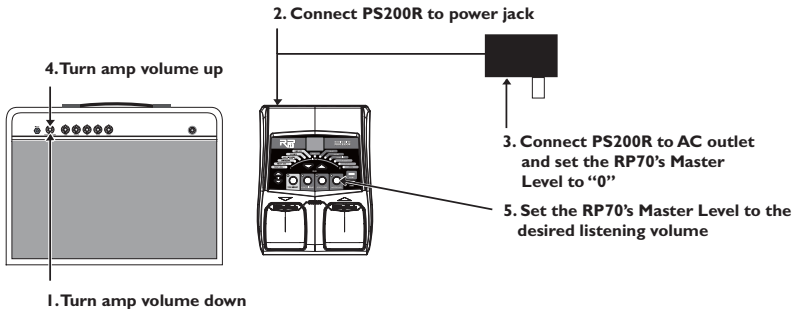

## Section Two - Editing Functions

### *Editing/Creating Presets*

The RP70 is designed to make preset editing and creation easy and intuitive. When creating your own sound, you must first start with an existing preset. Note that the preset you begin with doesn't have to be in the memory location you intend to have it reside, since you can store it to any User preset location during the store procedure.

The easiest way to start is by using the **Tone Library** and **Effects Library** buttons. The **Tone Library** button gives you access to a variety of pre-programmed amp/distortion tones (see page 37) based on different musical styles. The **Effects Library** button then lets you select from a palette of effects chains (see page 38), from simple delays to full multi-effect signals with modulation, delay and reverb. Use the **Effects Level Button** to easily increase or decrease the Chorus/FX, Delay and Reverb levels if desired. Using these three controls should get you close to a sound you are after. From there you can then use the **Edit** buttons to select individual Effects, and the **Value Up/Down** buttons to adjust their settings.

To edit and create a custom preset:

1. Use the **Footswitches** to select the preset you wish to edit. If you are trying to find something different from the existing presets, begin by using the **Tone Library**, **Effects Library**, **Effects Level** and **Value Up/Down** buttons to get close to a sound you want.
2. Once you have a sound close to what you are after, begin editing the Effects by pressing the **Edit Up/Down** buttons and selecting the Effect you want to adjust.
3. To turn an Effect on, select it with the **Edit Up/Down** buttons. Each Effect has multiple settings to select from. Use the **Value Up/Down** buttons to change the values for the selected Effect. To turn an Effect off, press and hold the **Value Down** button until **OFF** appears in the Display. (For EQs, **b5**, **d5**, and **e5** are the settings with no boost or cut.)

---

Anytime a stored value within a preset is changed, you need to store the changes (with the **Store** button), or the changes will be lost. Changing presets, or turning the power off before storing any changes erases any edits made and the RP70 will revert to the stored values for the preset.

### ***Storing/Copying a Preset***

Once the preset has been modified to your liking, you may store your settings to any of the 50 User preset locations (presets 1-50). The following steps outline the procedure for storing changes to a preset or copying a preset to a different location:

1. Press the **Store** button once and the current Preset location will flash in the **Display**. This is asking you to select a new User Preset location where your new sound will reside.
2. If desired, select a new User Preset location using the **Footswitches**.
3. Press the **Store** button again to save the changes.

The procedure for copying one Preset to another Preset location is the same. Simply use the **Footswitches** to select the Preset that you want to copy, then follow the steps listed above.





## Section Three - Models and Effects

### *About the Models*

The RP70 can be thought of as several different “virtual” amplifiers and individual, high-tech stompboxes in a single programmable package. With stompboxes, the order in which they are connected affects the overall sound. The RP70 has placed the Amp and Effect models in an order for optimum results. The following diagram shows the order in which they are connected.

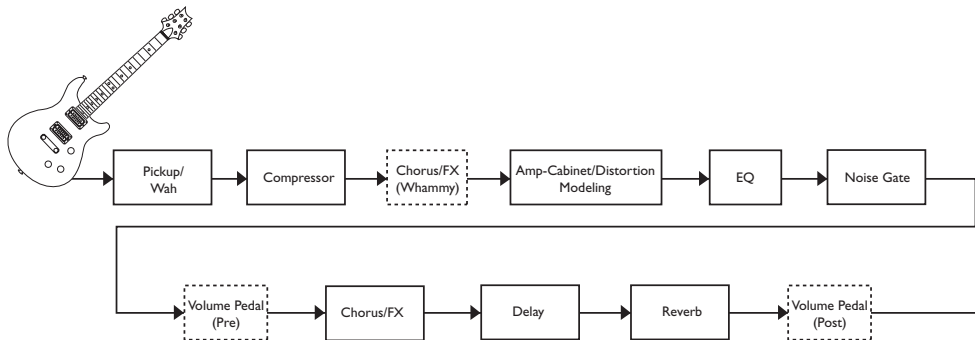

## **Model Definitions**

Each Amp and Effect model within the RP70 has multiple settings to select from. Use the **Value Up/Down** buttons to change the values for the selected Effect. The following overview of the RP70's Effects outlines the settings each Effect contains.

### **Pickup/Wah**

The **Pickup Simulator** provides the thick tone of a humbucker pickup to a guitar with single coil pickups, or the bright, edgy sound of a single coil pickup to a guitar with a humbucker. This gives you the best of both worlds without having to change guitars during a performance. **Wah** is an effect controlled by an optional Expression Pedal making the guitar sound as if it's saying "Wah." See page 32 for information on how to link the Wah effect to an Expression Pedal.

The Pickup/Wah settings are:

- Off** Pickup/Wah is turned off.
- SH** Makes a single coil pickup sound like a humbucker.
- HS** Makes a humbucker pickup sound like a single coil.
- Cb** Dunlop® Cry Baby™ wah model
- CY** Vox® Clyde McCoy™ wah
- Fr** Full range wah

## Compressor

A **Compressor** is used to increase sustain, tighten up guitars, and prevent the signal from clipping the input of other effects. It sets a maximum boundary for the strength of a signal.

The settings for the compressor effect are:

- OFF Compressor is turned off.
- 1-20 Level of compression and sustain. Ratio is set to infinity:1.

**Disclaimer:** DigiTech, Production Modeling, Grunge, Death Metal, DOD, DigiTech Whammy, Multi-Chorus, Ya Ya, Johnson Amplification and AudioDNA2 are trademarks of Harman International Industries, Incorporated in the U.S. and other countries. Fender Tweed Deluxe, Fender Blackface Twin Reverb, Fender Twin Reverb, Marshall Super Lead, Marshall Slant, Marshall Master Volume, Marshall Straight, Vox AC30, Mesa Boogie, Dunlop Cry Baby, Vox Clyde McCoy Wah, Ibanez Tube Screamer, Boss DS-1, Electro-Harmonix Big Muff are products of DigiTech's competitors and trademarks of their respective companies in the U.S. and other countries and are not associated or affiliated with DigiTech or Harman International Industries, Incorporated. © 2007 Harman International Industries, Inc. All Rights Reserved.



## **Amp/Distortion Models**

The RP70 has 12 amp and 6 distortion models to choose from. Each model is identified by a single letter and has nine settings (for example, *b 1* through *b 9*), except Acoustic Guitar Simulator and Direct, which only have one setting. As the setting increases, the amp/distortion gain increases. Each amp model has a cabinet model assigned to it as shown in the following list.

*0F* Amp/Distortion is turned off.

## **Amp/Cabinet Models**

- t 1-t 9* Based on a '57 Fender® Tweed Deluxe® amp with a Fender® Tweed Deluxe 1x12 cabinet
- b 1-b 9* Based on a '65 Fender Blackface Twin Reverb® amp with a Fender Twin Reverb 2x12 cabinet
- P 1-P 9* Based on a '68 Marshall® Super Lead (Plexi) amp with a Johnson® Straight Celestion® Vintage 30 4x12 cabinet
- H 1-H 9* Based on a '77 Marshall Master Volume amp with a Marshall Straight Celestion G12-T70 4x12 cabinet
- J 1-J 9* Based on an '83 Marshall JCM800 amp with a Johnson Straight Celestion Vintage 30 4x12 cabinet
- A 1-A 9* Based on a '63 Vox® AC30 Top Boost amp with an AC30 TB Jensen® Blue Back 2x12 cabinet
- r 1-r 9* Based on an '01 Mesa/Boogie® Dual Rectifier™ amp with a Johnson Straight Celestion Vintage 30 4x12 cabinet
- C 1-C 9* Based on a '96 Matchless® DC-30 amp with a Johnson Straight Celestion Vintage 30 4x12 cabinet
- Q 1-Q 9* DigiTech® Solo amp model with a DigiTech Solo 4x12 cabinet model
- E 1-E 9* DigiTech Metal amp model with a DigiTech Metal 4x12 cabinet model
- n 1-n 9* DigiTech Bright Clean amp model with a DigiTech Bright Clean 4x12 cabinet model
- u 1-u 9* DigiTech Clean Tube amp model with a cabinet model based on a Fender Twin Reverb 2x12 cabinet

## Distortion Models

- S 1-59* Based on Ibanez® TS-9 Tube Screamer™
- o 1-o9* Based on DOD® 250 Preamp/Overdrive
- d 1-d9* Based on Boss® DS-1™ Distortion
- g 1-g9* DigiTech® Grunge®
- L 1-L9* DigiTech Death Metal
- F 1-F9* Based on Electro Harmonix® Big Muff® Pi

## Other

- AC* Acoustic Guitar simulator

## EQ

The RP70's EQ helps further shape your tone with Bass, Midrange, and Treble controls. The EQ settings are:

- b 1-b9* Bass tone control. *b 1-b4* cut bass frequencies by  $-12\text{dB}$ ,  $-9\text{dB}$ ,  $-6\text{dB}$ , and  $-3\text{dB}$  respectively. *b5* has no boost or cut. *b6-b9* boost bass frequencies by  $3\text{dB}$ ,  $6\text{dB}$ ,  $9\text{dB}$ , and  $12\text{dB}$  respectively.
- d 1-d9* Midrange tone control. *d 1-d4* cut midrange frequencies by  $-12\text{dB}$ ,  $-9\text{dB}$ ,  $-6\text{dB}$ , and  $-3\text{dB}$  respectively. *d5* has no boost or cut. *b6-b9* boost midrange frequencies by  $3\text{dB}$ ,  $6\text{dB}$ ,  $9\text{dB}$ , and  $12\text{dB}$  respectively.
- t 1-t9* Treble tone control. *t 1-t4* cut treble frequencies by  $-12\text{dB}$ ,  $-9\text{dB}$ ,  $-6\text{dB}$ , and  $-3\text{dB}$  respectively. *t5* has no boost or cut. *t6-t9* boost treble frequencies by  $3\text{dB}$ ,  $6\text{dB}$ ,  $9\text{dB}$ , and  $12\text{dB}$  respectively.

## Noise Gate

The Noise Gate effect includes two models: a Silencer gate and an Auto Swell gate.

A silencer gate is designed to eliminate noise while you are not playing. The Silencer gate's nine settings (*9 1-99*) determine the threshold, which determines how loud a signal must be before it can be heard. The higher the setting, the louder a signal must be in order to be heard.

The Auto Swell provides an automatic volume swell effect. The auto swell's nine settings (*5 1-59*) determine the attack time (how quickly the swell grows from the note you play). The higher the setting, the faster the swell grows.

The noise gate settings are:

- 0F* Noise gate effect is turned off
- 9 1-99* Silencer gate. *9 1* is the lowest threshold, *99* is the highest threshold.

5 1-59 Auto Swell gate. 5 1 is the fastest attack time, 59 is the slowest attack time.

## Chorus/FX

The Chorus/FX model actually contains twelve different modulation and pitch effects (described on the following pages). Each effect includes nine settings which include a variety of configurations that generally range from more subtle (lower settings) to more extreme (higher settings). The Chorus/FX settings are:

0F	Chorus/FX effect is turned off	r 1-r9	Rotary Speaker
c 1-c9	Boss® CE-2 Chorus	y 1-y9	YaYa™
[ 1-[9	Dual Chorus	A 1-A9	AutoYa™
F 1-F9	Flanger	S 1-S9	Step Filter
P 1-P9	Phaser	E 1-E9	Envelope Filter
t 1-t9	Tremolo	d 1-d9	Detune
n 1-n9	Panner	h 1-h9	Pitch Shift
b 1-b9	Vibrato	H 1-H9	DigiTech® Whammy™

## Chorus

A Chorus adds a short delay to your signal. The delayed signal is modulated in and out of tune and then mixed back with the original signal to create a thicker sound. The RP70 Chorus effect includes a model based on the classic Boss® CE-2 Chorus and the DigiTech's Dual Chorus. Chorus settings are:

c 1-c9	Boss CE-2 Chorus.
[ 1-[9	Dual Chorus.



### **Flanger**

A Flanger uses the same principle as a Chorus but uses a shorter delay time and adds regeneration (or repeats) to the modulating delay. This results in an exaggerated up and down sweeping motion to the effect. Settings are *F 1-F9*.

### **Phaser**

A phaser splits the incoming signal, and then changes the phasing of the signal. This signal is then taken in and out of phase and mixed back in with the original signal. As the phasing changes, different frequencies get canceled resulting in a warm sort of twisting sound. Settings are *P 1-P9*.

### **Tremolo**

A Tremolo effect modulates the volume of the signal at an even rate. Settings are *t 1-t9*.

### **Panner**

A Panner modulates the sound from left to right at an even rate. Settings are *n 1-n9*.

### **Vibrato**

A Vibrato effect modulates the pitch of the incoming signal at an even rate. Settings are *b 1-b9*.

### **Rotary Speaker**

Rotary Speaker is an emulation of a device that included a spinning horn and woofer. The rotation of these two speakers produced an interesting combination of the sound panning from side to side. This produced a slight pitch change due to the speed of the sound coming towards, and then

going away from the listener. Settings are *r 1-r9*.

### **YaYa™**

AutoYa combines the characteristics of a Wah and a Flanger, creating an almost human vowel characteristic as if the guitar were saying “Yah.” Control the effect with an optional Expression Pedal.

Settings are *y 1-y9*.

### **AutoYa™**

Similar to the YaYa effect described above, AutoYa™ automatically provides this animation to the sound at an even rate. Settings are *A 1-A9*.

### **Step Filter**

The Step Filter is like an automatic “random wah” with a square waveform. Settings are *S 1-S9*.

### **Envelope Filter**

The Envelope Filter is a dynamic Wah effect that alters your sound based upon how hard you play. Settings are *E 1-E9*.

### **Detune**

A Detuner makes a copy of your incoming signal, takes the copied signal slightly out of tune from the original, then mixes the two signals together. The result is a doubling type of effect as if two guitars were playing the same part together. Settings are *d 1-d9*.

### **Pitch Shift**

A Pitch Shifter copies the incoming signal, then shifts the pitch of the copy to a different note. The shifted note is then mixed back with the original signal, sounding as if two guitars were playing dif-

ferent notes. Settings are  $H\ 1-H9$ .

### **DigiTech® Whammy™**

The DigiTech® Whammy™ is an effect that uses an optional Expression Pedal to bend the pitch of the incoming signal, or add a bendable harmony with the original signal. As the Pedal is moved, the note bends either up or down. When DigiTech Whammy is selected, it is automatically placed before the Amp modeling as shown in the block diagram on page 20. Settings are  $H\ 1-H9$ .

### **Delay**

Delay is an effect that will record a portion of the incoming signal, and then play it back a short time later. The recording can repeat just once or several times.

The RP70 offers four different delay models (Analog Delay, Digital Delay, Pong Delay, and Tape Delay), each with 5 seconds of delay time available. There are two different parameters used to program the delay: Delay Variation and Delay Time. The first parameter of the delay effect is Delay Model type and Variation, which varies the amount of feedback (number of repeats) and level. The second delay parameter is Delay Time. This is indicated by a value 1-99 (10ms-990ms), 1.0 - 5.0 (1 - 5 seconds respectively in 100ms increments) in the Preset Number display when the Delay LED is lit. Delay settings are listed on the following page.

## Delay Variation

**DF** Delay effect is turned off

### Analog Delay

A1	feedback=5%	level=15
A2	feedback=5%	level=30
A3	feedback=5%	level=50
A4	feedback=20%	level=15
A5	feedback=20%	level=30
A6	feedback=20%	level=50
A7	feedback=45%	level=15
A8	feedback=45%	level=30
A9	feedback=45%	level=50

### Digital Delay

d1	feedback=5%	level=15
d2	feedback=5%	level=30
d3	feedback=5%	level=50
d4	feedback=20%	level=15
d5	feedback=20%	level=30
d6	feedback=20%	level=50
d7	feedback=45%	level=15
d8	feedback=45%	level=30
d9	feedback=45%	level=50

### Delay Time

1-99 10ms-990ms in 10ms increments

1.0-5.0 1-5 seconds in 100ms increments

### Pong Delay

P1	feedback=5%	level=15
P2	feedback=5%	level=30
P3	feedback=5%	level=50
P4	feedback=20%	level=15
P5	feedback=20%	level=30
P6	feedback=20%	level=50
P7	feedback=45%	level=15
P8	feedback=45%	level=30
P9	feedback=45%	level=50

### Tape Delay

t1	feedback=5%	level=15
t2	feedback=5%	level=30
t3	feedback=5%	level=50
t4	feedback=20%	level=15
t5	feedback=20%	level=30
t6	feedback=20%	level=50
t7	feedback=45%	level=15
t8	feedback=45%	level=30
t9	feedback=45%	level=50

## **Reverb**

Using reverb in recorded program material gives the listener a sense that the material is being performed in an actual room or hall. It is this similarity to actual acoustic spaces that makes reverb a useful tool in recorded music. Settings are:

- OFF*      Reverb effect is turned off.
- S 1-59*    Based on a Fender® Twin Reverb® (Spring)
- r 1-r9*    Room reverb
- H 1-H9*    Hall reverb

## Section Four - Other Functions

### *Optional Expression Pedal*

The rear panel of the RP70 includes an input for an Expression Pedal. Any passive volume pedal can be used as an Expression Pedal with the RP70. Connect the output of a passive volume pedal to the **Control In** jack on the RP70. The Expression Pedal can be assigned in each preset to control the Volume, Wah, DigiTech® Whammy™, YaYa™, or one of several other parameters in real time with your foot. When a parameter has been assigned to the Expression Pedal, a program-mable minimum and maximum value can also be assigned. The procedure for assigning a parameter to the Expression Pedal is as follows:

1. Press either **Edit Up** button until the Expression LED lights up. An effect LED will also light indicating which effect the Expression Pedal is currently assigned to.
2. Press either **Value Up/Down** button until your desired effect's LED is lit in the matrix. The Expression LED will stay lit during your selection and the Display will show a two-digit character value to describe the effect parameter that the Expression Pedal is assigned to.
3. Once you have assigned a parameter, you can set the control range of that parameter. Press the **Edit Up** button again. The number value shown is the minimum parameter value – this is the value that will be reached when the Expression Pedal is rocked back (toe up).
4. Press the **Edit Up** button again. The number value shown is the maximum parameter value – this is the value that will be reached when the Expression Pedal is rocked forward (toe down).
5. Use the Store procedure (see page 18) to save your changes to the preset.



Expression assignments available are as follows:

No Assignment	$\square F$
Volume	$P_r$ (Output Level Pre Delay)
Volume	$P_s$ (Output Level Post Delay)
Wah	$RH$ (Expression Pedal acts as a Wah pedal)
Amp	$gR$ (Expression Pedal controls the Amp Gain)
Chorus	$SP$ (Speed) $LE$ (Level)
Flanger	$SP$ (Speed) $LE$ (Level)
Phaser	$SP$ (Speed) $LE$ (Level)
Tremolo	$SP$ (Speed) $dP$ (Depth)
Panner	$SP$ (Speed) $dP$ (Depth)
Vibrato	$SP$ (Speed) $dP$ (Depth)
Rotary	$SP$ (Speed) $dP$ (Depth)
YaYa	$Pd$ (Expression Pedal acts as a YaYa™ Effect when engaged)
AutoYa	$SP$ (Speed) $dP$ (Depth)
Envelope Filter	$ES$ (Sensitivity)
Detune	$LE$ (Level of the Detuned signal)
Pitch Shift	$LE$ (Level of the Pitch Shifted signal)
Whammy	$HY$ (Expression Pedal acts as a DigiTech® Whammy™ pedal)
Delay	$dL$ (Delay Level) $dF$ (Delay Feedback)
Reverb	$rL$ (Reverb Level)

## Drum Machine

The RP70 features a built-in drum machine, which is enabled by pressing the **Drums** button. Select patterns, tempo, and level with the **Edit Up/Down** buttons. Change their values with the **Value Up/Down** buttons. The drum machine has the following parameters

Drum Patterns	1-40
Drum Tempo	1-99 (equivalent of 40 – 240BPM)
Drum Level	0-99

Drum machine settings are globally set and not individually stored with each of the RP70's user presets.

## Factory Reset

This function resets the RP70 to its original factory settings. This procedure erases all custom User presets.

**ATTENTION: Performing this function will erase all user-programmed data. All such data will be lost forever! Be sure you want to erase the memory and return the RP70 to its factory default state before continuing with this procedure.**

The procedure for performing a Factory Reset is as follows:

1. Press and hold the **Store** button while powering up the RP70.
2. When the display prompts you with  $F_r$ , release the **Store** button.
3. Press and hold the **Store** button for 3 seconds until  $r_5$  appears in the display and release. **The Factory Reset procedure takes approximately 10 seconds.**





## Section 5 - Appendix

### *Specifications*

#### **General Specifications**

A/D/A Converter:	24-bit high performance audio
Sampling Frequency:	44.1 kHz
DSP Section:	AudioDNA2™ DSP Processor
Simultaneous Effects:	9
Preset Memory:	50 User Presets (1-50) / 50 Factory Presets (51-00)
Drum Machine:	40 Patterns
Dimensions:	6.5" Length x 5" Width x 2" Height
Unit Weight:	.86 lbs.

#### **Analog Input Connections:**

Guitar Input:	1/4" Unbalanced (TS)
Input Impedance:	500k Ohms
Control Input:	Use a passive expression controller with 250 kOhm or greater pot

---

**Analog Output Connections:**

Left/Right Outputs:	1/4" Unbalanced
Left/Right Output Impedance:	500 Ohms per side
Maximum Output:	+7.0 dBu
Headphones:	1/8" Stereo (TRS) – 17.4mW per channel @ 50 Ohms

**Power Requirements:**

US and Canada:	120 VAC, 60 Hz Adapter: PS200R-120
Japan:	100 VAC, 50/60 Hz Adapter: PS200R-100
Europe:	230 VAC, 50 Hz Adapter: PS200R-230
UK:	240 VAC, 50 Hz Adapter: PS200R-240



## ***Tone Library***

1	Overdrive	11	Rock Wah
2	Rock	12	Chunky
3	Blues	13	Smooth
4	Metal	14	Heavy
5	Country	15	Clean
6	Warm Drive	16	British
7	Crunch	17	Distortion
8	Texas Tone	18	Scooped
9	Rockabilly	19	Bright Clean
10	Solo	20	Acoustic

## Effects Library

1	Chorus	11	Hall Reverb
2	Flanger	12	Spring Reverb
3	Phaser	13	Chorus + Digital Delay
4	Pitch	14	Chorus + Delay + Reverb
5	Tremolo	15	Flanger + Analog Delay
6	Rotary	16	Phaser + Tape Delay
7	Envelope Filter	17	Digital Delay + Hall Reverb
8	Digital Delay	18	Analog Delay + Spring
9	Analog Delay	19	Pitch + Room Reverb
10	Tape Delay	20	Vibrato + Tape Delay



## Preset List (User/Factory)

1/5 1	RECTO	26/76	RETRO BILLY
2/52	CLEAN CHORUS	27/77	GOOD N' GREASY
3/53	BRITISH STACK	28/78	OCTAVED
4/54	TWEEDY	29/79	CLEAN DELAY
5/55	ANALOG BOY	30/80	TAPE DELAYS
6/56	FUNK IT	31/81	ACOUSTIC
7/57	WHAMMY	32/82	DA CRUSHER
8/58	OLD SCHOOL	33/83	SB - PURPLE FUZZ*
9/59	BIG SOLO	34/84	ISN'T IT SWELL
10/60	SB - OVERDRIVE*	35/85	BLUE DELUXE
11/61	BRITISH COMBO	36/86	CAPTAIN CRUNCH
12/62	WAHS HAPPENING	37/87	5THS
13/63	BLUES DRIVE	38/88	PHASE DELAY
14/64	JAZZY DRIVE	39/89	JAZZ BOX
15/65	SB - DISTORTION*	40/90	SARGENT D
16/66	YOU TOO	41/91	WARM DRIVE
17/67	COUNTRY PICKIN	42/92	SB - GOOD GRUNGE*
18/68	SB - FUZZ KING*	43/93	TREMOLO VERB
19/69	BIG BLUES	44/94	UNPLUGGED
20/70	HEAVY DUTY	45/95	MOSHIN'
21/71	PLEXI TIME	46/96	MR CLEAN
22/72	FLANGIST	47/97	ANGUS
23/73	DETUNED CLEAN	48/98	VIBRO
24/74	PHASE HEAD	49/99	WAHNABEE
25/75	COMPRESSED	50/00	PUNK

\* SB = Stompbox  
Distortion





DigiTech®  
8760 South Sandy Parkway  
Sandy, Utah 84070  
PH (801) 566-8800  
FAX (801) 566-7005  
<http://www.digitech.com>

Printed 8/2007  
RP70 Owner's Manual 18-0491-A

©2007 Harman International Industries, Incorporated, all rights reserved.

DigiTech, Production Modeling, Grunge, Death Metal, DOD, DigiTech Whammy, Multi-Chorus, Ya Ya, Johnson Amplification and AudioDNA2 are trademarks of Harman International Industries, Incorporated in the U.S. and other countries. Fender Tweed Deluxe, Fender Blackface Twin Reverb, Fender Twin Reverb, Marshall Super Lead, Marshall Slant, Marshall Master Volume, Marshall Straight, Vox AC30, Mesa Boogie, Dunlop Cry Baby, Vox Clyde McCoy Wah, Ibanez Tube Screamer, Boss DS-1, Electro-Harmonix Big Muff are products of DigiTech's competitors and trademarks of their respective companies in the U.S. and other countries and are not associated or affiliated with DigiTech or Harman International Industries, Incorporated. © 2007 Harman International Industries, Inc. All Rights Reserved.

 A Harman International Company