

EUROPOWER PMH660M/PMH880S

User's Manual

Version 1.3 November 2004

ENGLISH

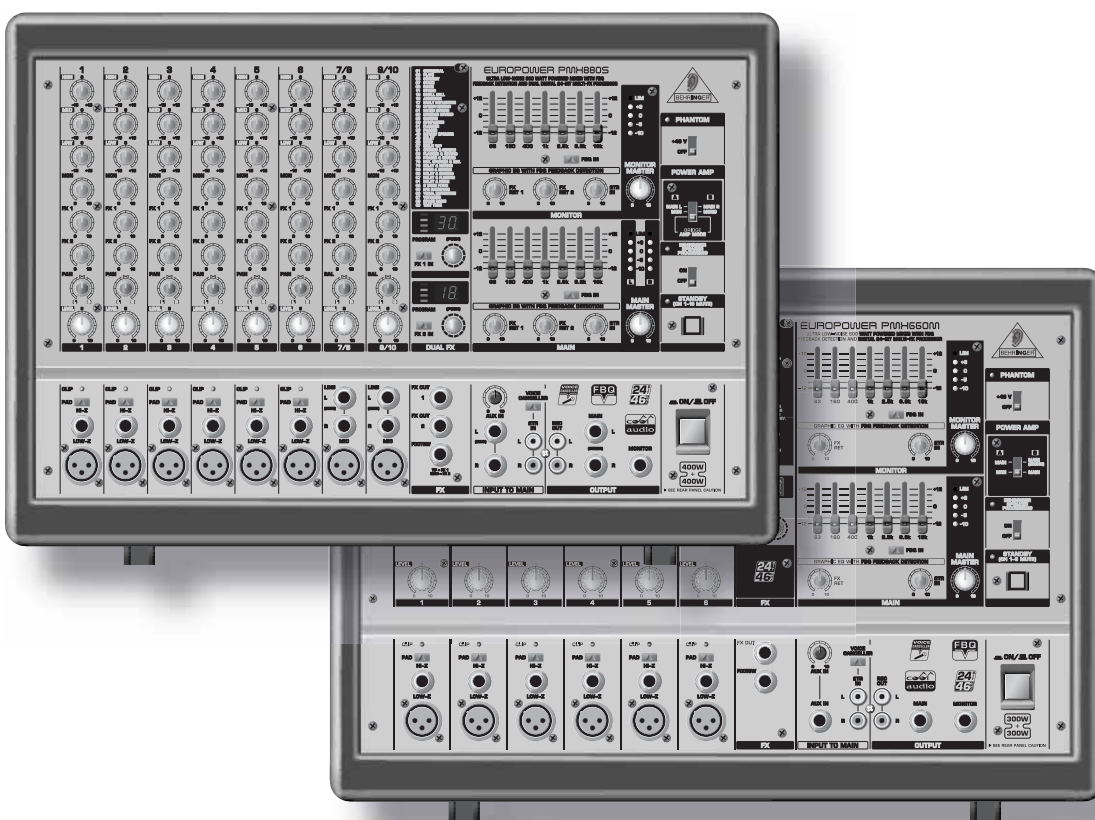

www.behringer.com



EUROPOWER PMH660M/PMH880S

IMPORTANT SAFETY INSTRUCTIONS



CAUTION: To reduce the risk of electric shock, do not remove the top cover (or the rear section). No user serviceable parts inside; refer servicing to qualified personnel.

WARNING: To reduce the risk of fire or electric shock, do not expose this appliance to rain and moisture. The apparatus shall not be exposed to dripping or splashing and no objects filled with liquids, such as vases, shall be placed on the apparatus.



This symbol, wherever it appears, alerts you to the presence of uninsulated dangerous voltage inside the enclosure—voltage that may be sufficient to constitute a risk of shock.



This symbol, wherever it appears, alerts you to important operating and maintenance instructions in the accompanying literature. Please read the manual.

DETAILED SAFETY INSTRUCTIONS:

- 1) Read these instructions.
 - 2) Keep these instructions.
 - 3) Heed all warnings.
 - 4) Follow all instructions.
 - 5) Do not use this apparatus near water.
 - 6) Clean only with dry cloth.
 - 7) Do not block any ventilation openings. Install in accordance with the manufacturer's instructions.
 - 8) Do not install near any heat sources such as radiators, heat registers, stoves, or other apparatus (including amplifiers) that produce heat.
 - 9) Do not defeat the safety purpose of the polarized or grounding-type plug. A polarized plug has two blades with one wider than the other. A grounding type plug has two blades and a third grounding prong. The wide blade or the third prong are provided for your safety. If the provided plug does not fit into your outlet, consult an electrician for replacement of the obsolete outlet.
 - 10) Protect the power cord from being walked on or pinched particularly at plugs, convenience receptacles, and the point where they exit from the apparatus.
 - 11) Only use attachments/accessories specified by the manufacturer.
 - 12) Use only with the cart, stand, tripod, bracket, or table specified by the manufacturer, or sold with the apparatus. When a cart is used, use caution when moving the cart/apparatus combination to avoid injury from tip-over.
- 
- 13) Unplug this apparatus during lightning storms or when unused for long periods of time.
 - 14) Refer all servicing to qualified service personnel. Servicing is required when the apparatus has been damaged in any way, such as power supply cord or plug is damaged, liquid has been spilled or objects have fallen into the apparatus, the apparatus has been exposed to rain or moisture, does not operate normally, or has been dropped.
 - 15) **CAUTION** - These service instructions are for use by qualified service personnel only. To reduce the risk of electric shock do not perform any servicing other than that contained in the operation instructions unless you are qualified to do so.

EUROPOWER PMH660M/PMH880S

FOREWORD



Dear Customer,

Welcome to the team of EUROPOWER users and thank you very much for expressing your confidence in BEHRINGER products by purchasing this power mixer.

It is one of my most pleasant tasks to write this letter to you, because it is the culmination of many months of hard work delivered by our engineering team to reach a very ambitious goal: to present you two outstanding power mixers that give you maximum flexibility and

performance with a unique sound character and broad range of striking functions.

The task to design the new PMH series certainly meant a great deal of responsibility, which we assumed by focusing on you, the discerning user and musician. It also meant a lot of work and night shifts to accomplish this goal. But it was fun, too. Developing a product usually brings a lot of people together, and what a great feeling it is when everybody who participated in such a project can be proud of what we've achieved.

It is our philosophy to share our joy with you, because you are the most important member of the BEHRINGER team. With your highly competent suggestions for new products you've greatly contributed to shaping our company and making it successful. In return, we guarantee you uncompromising quality as well as excellent technical and audio properties at an extremely favorable price. All of this will enable you to fully unfold your creativity without being hampered by budget constraints.

We are often asked how we can make it to produce such high-grade devices at such unbelievably low prices. The answer is quite simple: it's you, our customers! Many satisfied customers means large sales volumes enabling us to get better conditions of purchase for components, etc. Isn't it only fair to pass this benefit back to you? Because we know that your success is our success, too!

I would like to thank all people whose help on "Project PMH" has made it all possible. Everybody has made very personal contributions, starting from the designers of the unit to the many staff members in our company and finally to you, the user of BEHRINGER products.

My friends, it's been worth the trouble!

Thank you very much,

Uli Behringer

TABLE OF CONTENTS

1. INTRODUCTION	4
1.1 Before you get started	4
1.1.1 Shipment	4
1.1.2 Initial operation	4
1.1.3 Warranty	4
1.2 The manual	4
2. CONTROL ELEMENTS	4
2.1 Mono and stereo channels	4
2.1.1 Input section	5
2.2 Effects section	5
2.3 Main and monitor section	5
2.3.1 Connectors	6
2.4 Rear panel	6
3. DIGITAL EFFECTS PROCESSOR	7
4. INSTALLATION	8
4.1 Mains connection	8
4.2 Audio connections	8
4.3 Loudspeaker connection	9
5. WIRING EXAMPLES	10
6. SPECIFICATIONS	12
7. WARRANTY	13

CAUTION!

 We would like to point out that high volume levels may damage your hearing and/or your headphones. Please turn the MAIN MASTER and MONITOR MASTER controls fully counter-clockwise before switching on the device. Always make sure that the appropriate volume is set.

EUROPOWER PMH660M/PMH880S

1. INTRODUCTION

Congratulations! With the PMH660M/PMH880S you have acquired a state-of-the-art power mixer that sets new standards. Right from the very start it has been our goal to design a revolutionary unit that can be used for a wide variety of applications. And indeed, this overwhelming power mixer gives you plenty of functionality and a broad range of connection and expansion options.



Your power mixer features our revolutionary **COOLAUDIO** amplifier technology that reduces weight and size of your device and provides extreme high output power.

Further advantages are the integrated **Voice Canceller** that removes vocal tracks from a playback, the **FBQ** function for feedback detection and the **Speaker Processing** function for adjusting the frequency response of any loudspeaker—and everything with **24-bit/46 kHz** resolution.





The mixing consoles of the PMH series feature a state of the art, integrated switch-mode power supply (**SMPS**). One of the great advantages is that (compared to conventional circuits) a switch-mode power supply adapts to mains voltages between 100 and 240 volts automatically. Furthermore, due to its much greater efficiency, it consumes much less energy than a conventional power supply unit.

BEHRINGER is a company with its roots in professional recording studio technology. For many years we have been successful in developing products for studio and live use. These include microphones and 19" units of all types (compressors, enhancers, noise gates, tube processors, headphone amplifiers, digital effects, DI boxes, etc.), monitor and P.A. speakers as well as professional live and recording mixers. Our entire technical know-how has gone into your PMH power mixer.

1.1 Before you get started

1.1.1 Shipment

Your PMH was carefully packed at the factory and the packaging is designed to protect the unit from rough handling. Nevertheless, we recommend that you carefully examine the packaging and its contents for any signs of physical damage which may have occurred during transit.

-  **If the unit is damaged, please do NOT return it to BEHRINGER, but notify your dealer and the shipping company immediately. Otherwise, claims for damage or replacement may not be granted.**
-  **We recommend that you use a flight case, so as to give your power mixer optimum protection during use or transport.**
-  **Always use the original packing carton to prevent damage during storage or transport.**
-  **Make sure that children cannot play unsupervised with the device or its packaging.**
-  **Please ensure proper disposal of all packing materials.**

1.1.2 Initial operation

Be sure that there is enough air space around the unit for cooling and, to avoid overheating, please do not place the EUROPOWER near radiators, etc.

 **Blown fuses must be replaced by fuses of the same type and rating! Please refer to the "SPECIFICATIONS" for details.**

The mains connection is made using the enclosed power cord and a standard IEC receptacle. It meets all of the international safety certification requirements.

 **Please make sure that all units have proper ground connection. For your own safety, never remove or disable the ground conductor from the unit or on the AC power cord.**

1.1.3 Warranty

The EUROPOWER's serial number is located on the rear panel. Please take the time to fill in and return the warranty card within 14 days after the date of purchase, so as to benefit from our extended warranty. Or register online at www.behringer.com.









1.2 The manual

This manual is designed to give you both an overview of all control elements and to provide detail about how to use them. To provide you with a clear structure, we have grouped the control elements according to their function. They can easily be found on the enclosed numbered illustrations. If you need more detailed information on specific topics, please visit our web site www.behringer.com. The product-related information pages and the ULTRANET-based glossary explain the relevant audio engineering terminology in full detail.

2. CONTROL ELEMENTS

A detailed description of all functions of your power mixer can be found in the following chapters. Please also refer to the enclosed sheet with the numbered illustrations to get an overview of the control layout.

2.1 Mono and stereo channels

-  The *HI* control in the EQ section governs the high-frequency range of the respective channel.
-  Use the *MID* control to boost or cut the mid-range frequencies.
-  The *LOW* control allows you to boost/cut the low-frequency range.
-  With the *MON* control you can adjust the volume of each channel in the monitor mix.
-  The *FX* control determines the signal level sent from each channel to the built-in effects processor; this signal is also present at the *FX OUT* jack (see [32]). The PMH880S has two *FX* controls (*FX 1* and *FX 2*), so that you can use two effects simultaneously. Accordingly, it also provides two effect Aux paths (see [32]).
-  **Please note that the effects processor signal will be inaudible when the *FX RETURN* control ([21]) is set fully counter-clockwise.**
-  For the mono input channels, the PMH880S has a *PAN(ORAMA)* control which determines the position of the channel signal in the stereo main mix. The PMH660M has no *PAN* on the input channels, because it is a dual-mono power mixer.
-  The *BAL(ANCE)* control for the stereo channels of the PMH880S corresponds to the *PAN* control for the mono channels. It determines the relative volume of the left and right input signals before they are routed to the stereo main output. The PMH660M has no stereo channels and hence no *BAL* control, because it is a dual-mono power mixer.

EUROPOWER PMH660M/PMH880S

- [8] The *LEVEL* control adjusts the channel signal level in the main mix.

2.1.1 Input section

- [9] The *CLIP* LED is very useful to control the input gain. It should never be constantly illuminated (only with signal peaks).
- [10] The *PAD* switch reduces the input sensitivity of the channel by approx. 30 dB, to connect for example line-level signals.
- [11] The balanced *HI-Z* input (1/4" TRS) can be used for line-level signal sources, e.g. keyboards, electric guitars and basses.
- [12] Each channel has a balanced *LOW-Z* microphone input with XLR connectors, which also supply the +48 V phantom power for condenser microphones (see [27]).
- [13] Unbalanced stereo line inputs with 1/4" connectors for stereo channels 7 to 10 of the PMH880S. They can be used for connecting keyboards with stereo outputs or stereo drum machines.

 **Please remember to use either the microphone or the line input of a channel at a time, but never both at the same time!**

 **When you connect mono line-level signals to channels 7 to 10 of the PMH880S, always use the left input. The mono signal will then be reproduced by both stereo sides.**



2.2 Effects section

- [14] List of all multi-effects presets.
- [15] *LED* level meter of the effects processor. Since the PMH880S allows you to select two effects simultaneously, it also has two level meters (*DUAL FX*). Be sure that the clip LED illuminates for signal peaks only. If it is illuminated all the time, it is a sign that the effects processor is overloading and hence producing unpleasant distortion.
- [16] The *EFFECT* display (PMH880S: two displays) shows the currently selected preset.
- [17] Turn the *PROGRAM* control (PMH880S: one control each for FX 1 and FX 2) to select an effects preset (preset number starts flashing). Push the control briefly to confirm your selection.
- [18] Press the *FX IN* button (PMH880S: *FX 1 IN* and *FX 2 IN*) to activate the effects processor.

2.3 Main and monitor section

- [19] Your power mixer is equipped with two graphic 7-band equalizers. The upper one processes the monitor signal, the lower one the main signal. Use the EQs to adjust the sound to the room acoustics.
- [20] Press the *FBQ IN* switch to activate the FBQ Feedback Detection System. The frequencies causing feedback are shown by the brightly lit fader LEDs. Simply lower the level of the respective frequency range until feedback disappears and the LED goes out. Your power mixer offers this function both for the main and the monitor mix.





- [21] Turn the *FX RET* control to add the effect signal to the main mix (lower) or monitor mix (upper). The PMH880S allows you to use two effects at the same time, it also has two FX controls each for the main and monitor mixes: when the *FX RET 1* and *FX RET 2* controls are fully counter-clockwise, no effect signal is added.
- [22] The *2TR IN* control adjusts the volume of the 2 Track In signal (see [35]).
- [23] The *MONITOR MASTER* control adjusts the monitor output volume.
- [24] Use this 5-digit LED meter to control the output level of the monitor signal. The upper *LIM* LED illuminates when the internal amp protection circuit responds to output levels that are too high.
- [25] The *MAIN MASTER* control is used to adjust the main output volume.
- [26] Use this 5-digit LED meter to control the output level of the main signal. The PMH880S has two rows of LED meters (L/R), because the signal is stereo. The upper *LIM* LED illuminates when the internal amp protection circuit responds to output levels that are too high.
- [27] +48V phantom power is provided for condenser microphones. The phantom power supply is activated for all channels with the *PHANTOM* switch and the PHANTOM LED above the switch illuminates.
- [28] Use the *POWER AMP* switch to determine the operating mode of your power mixer.

The PMH880S has three different operating modes: In *MAIN L/MAIN R* mode it functions as a stereo amplifier, i.e. the left and right main stereo signals are sent to OUTPUT A (L) and OUTPUT B (R). In *MON/MONO* mode it functions as a dual mono amplifier. I. e. OUTPUT A sends the monitor signal, and OUTPUT B the main signal (mono). In *BRIDGE AMP MODE* the output power of outputs A and B are added and provided at OUTPUT B.

The PMH660M also has three operating modes, since it can be operated in two modes with the switch in its upper position (*MAIN/MAIN (BRIDGE)* mode), depending on the pin connections of the speaker cables. In *MAIN/MAIN (BRIDGE)* mode power of both outputs is added and provided at OUTPUT B (SPEAKON® cable, pins 1+/2+). With the normal pin connections (SPEAKON® cable, pins 1+/1-) a main signal is provided in this mode at OUTPUT A and B (not bridged). In *MON/MAIN* mode, the mixer can also be used as a dual mono amplifier, i.e. OUTPUT A provides the monitor signal, while the main signal is present at OUTPUT B.

Please refer to [44] and [45] as well as chapter 4.4 "Loudspeaker connectors".

 **In BRIDGE mode, always connect only one loudspeaker with an impedance of at least 8 Ω to OUTPUT B (pins 1+/2+)! Please note that OUTPUT A must NEVER be used in BRIDGE mode (with pin connections 1+/2+)!**

 **In all other operating modes, the minimum impedance of the speaker connected must not fall below 4 Ω.**

- [29] Use the *SPEAKER PROCESSING* switch to activate a filter that adapts the mixer to the specifications of your loudspeakers. If the speakers have a limited frequency response in the bass range, it allows you to adapt it optimally to the frequency response of the speakers.

EUROPOWER PMH660M/PMH880S

- [30] If *STANDBY* is pressed, all input channels are muted. During breaks you can thus prevent the microphones from picking up noise or interference, which would then be reproduced by the P.A. system. The advantage is that all faders can be left untouched while you play a CD via the CD/TAPE inputs (see [35]). There is also no need to move down the faders of muted channels and lose your mix.

2.3.1 Connectors

- [31] The *FOOTSWITCH* connector is for a standard footswitch. You can activate an "effect bypass" that mutes the effects processor. Please use a dual footswitch for the PMH880S, so that you can enable/disable FX1 and FX2 independently of each other. In this case, the tip of the 1/4" plug controls FX1, and the ring FX2.

- [32] The *FX OUT* connector is used to route the FX SEND signal from the input channels, for example, to the input of an external effects processor. The PMH880S has two FX controls per input signal (see [5]) and also two FX OUT connectors (*FX OUT 1* and *FX OUT 2*).

 **Please note: When you connect a mono plug to one of the FX OUT jacks, the signal path from the respective FX send to the built-in effects processor is interrupted. For each FX send you can either use the built-in effect or the corresponding FX OUT jack (for an external effect), but never both at the same time. When you use a stereo plug (tip and ring interconnected) you can use the built-in effects processor and the FX OUT jacks in parallel.**

- [33] Use the *AUX IN* 1/4" inputs to route an external stereo signal to the main mix. This can be the signal generated by an external effects processor. Use the left input for mono signals, which are then reproduced on both stereo sides. The PMH660S has only one mono AUX IN connector.

- [34] The *AUX IN* control adjusts the volume of the external signal in the main mix.

- [35] The *2TR IN* RCA input allows you to feed in external stereo signals, e.g. from a CD player, tape deck or other line-level source.

- [36]  The *VOICE CANCELLER* filters vocal-specific frequencies from the 2TR IN signal. This function can be used for karaoke, i.e. you can remove the vocals from a song and then sing along with the music yourself.

- [37] The *REC OUT* (RCA) provides line-level signals from the power mixer to a DAT recorder, for example. On the PMH880S the REC OUT signal is stereo and on the PMH660M two identical mono signals are provided.

 **If the REC OUT signal is connected to a recorder whose output signal is returned to the 2TR IN, feedback can occur when you activate the record function. So, disconnect the 2TR IN from the recorder, before you start recording!**

- [38] The MAIN 1/4" connectors allow you to send the main signal to an external amplifier, when you only wish to use the mixer and effects section. The signal is taken pre-power stage of the mixer. It is also possible to use only the left jack of the output. The PMH660M has only one mono output connector.

- [39] Connect your monitor power amps or active monitor speakers to the mono *MONITOR* output to monitor the signal mix created with the MON controls or to route it to the musicians on stage.

- [40] Use the *POWER* switch to put the unit into operation. The *POWER* switch should always be in the "Off" position when you are about to connect the unit to the mains.

 **Please note: The *POWER* switch does not fully disconnect the unit from the mains. Unplug the power cord completely when the unit is not used for prolonged periods of time.**

2.4 Rear panel

- [41] The mains connection is on a standard IEC receptacle. An appropriate power cord is supplied with the unit.

- [42] *FUSE HOLDER*. Before connecting the unit to the mains, ensure that the voltage setting matches your local voltage. Blown fuses should only be replaced by fuses of the same type and rating. Please also read the information given in chapter 6 "SPECIFICATIONS".

- [43] These are the two cooling fans of the unit.

- [44] Loudspeaker *OUTPUT A*.

PMH880S: Depending on the operating mode selected (see [28]) either the left main signal or the monitor signal is provided at OUTPUT A. NEVER use this output in bridged mono mode.

PMH660M: In MON/MAIN mode, the monitor signal is provided at OUTPUT A (see [28]). NEVER use this output in bridged mono mode, except when you use a cable with the normal pin connections (SPEAKON® cable: pins 1+/1-). In this case you can take the mono main signal from this output in MAIN/MAIN (BRIDGE) mode (not bridged). Please also refer to chapter 4.4 "Loudspeaker connection".

 **The impedance of the loudspeaker connected must not fall below 4 Ω.**

 **Please note that the power delivered to the speaker in bridged mono mode is considerably higher than in other operating modes. Please read the information given on the rear panel of the power mixer.**

- [45] Loudspeaker *OUTPUT B*.

PMH880S: Depending on the operating mode selected (see [28]) either the right main signal, the mono main signal or the bridged mono signal is provided at OUTPUT B.

PMH660M: Either the main or the bridged main mono signal is provided at OUTPUT B (see [28]). When you use a cable with the normal pin connections (SPEAKON® cable: pins 1+/1-), it is possible in MAIN/MAIN (BRIDGE) mode to take the mono main signal from this output (not bridged). Please also refer to chapter 4.4 "Loudspeaker connection".

 **In BRIDGE mode, always connect only one loudspeaker with an impedance of at least 8 Ω to OUTPUT B (pins 1+/2+)! Please note that OUTPUT A must NEVER be used in BRIDGE mode (with pin connections 1+/2+)!**

 **In all other operating modes, the minimum impedance of the speaker connected must not fall below 4 Ω.**

 **Information on how to properly connect your speaker with regard to polarity can be found on the rear of the mixer (PINOUTS).**

- [46] *SERIAL NUMBER*. Please take the time to fill in and return the warranty card within 14 days after the date of purchase, so as to benefit from our extended warranty. Or register online at www.behringer.com.

3. DIGITAL EFFECTS PROCESSOR

A special feature of your PMH880S and PMH660M is the built-in multi-effects processor that features the same audio quality as our renowned studio-grade VIRTUALIZER PRO DSP2024P. The PMH880S even has two effects processors, each of them with 99 different standard effects such as reverb, chorus, flanger, delay, vocal distortion as well as various effects combinations.



CATHEDRAL: Simulates the dense, long reverberation of a large cathedral, which is appropriate for solo instruments or vocals in slow pieces. Choose between two variations.

PLATE: Simulates the sound of plate reverberations and hence is a classic for drums (snare) and vocals. The second one features more high-end sparkle than the first.

CONCERT: Select between a small theater and a large hall. Although this program is similar to studio (see below) it features more presence, which adds to its "lively" character.

STAGE: Is well suited for dissipating the sound of a keyboard or an acoustic guitar.

ROOM: You can clearly hear the walls of the room. A useful program for reverb that isn't directly noticeable (rap, hip hop vocals) or to make dry recordings of instruments sound natural again.

STUDIO: This simulation of a middle to large-sized room is also available in two variations. Both variations sound very natural and can be used as all-purpose effects.

SMALL HALL: Simulates a small, lively (strongly reflecting) hall and is perfect for processing drums.

AMBIENCE: Reproduces a middle-sized room without late reflections.

EARLY REFLECTIONS: The initial reflections of this room are clearly audible. This effect is a classic for dynamic signals (drums, percussion, slap bass, etc.).

SPRING REVERB: Simulates classic spring reverberation.

GATED REVERB: This effect synthetically cuts off reverberation after a period of time. It is famous in the song "In the Air Tonight" by Phil Collins. The variations differ in the reverb length.

REVERSE REVERB: This is a reverberation in which the envelope is reversed, i.e. it slowly gets louder.



CHORUS: This effect slightly detunes the original signal. A very pleasant detune effect is created in connection with the pitch variation. The chorus effect is used often and quite extensively used for dispersing signals. The variations available range from slow to fast chorus effects.

SYMPHONIC: This effect creates the sound of an eight-voice (!) vocal chorus.

FLANGER: The word "flange" means "tape spool", and this explains the characteristics of the effect. Originally, the flanger effect was generated with two tape recorders which ran synchronously. The same audio signal was recorded on both machines. If you put a finger on the left spool of one of the machines, the spool and the playback speed are slowed down. The generated delay results in phase shifting of the signals. Please choose either "medium flanger" or one of the "bright flanger" programs, which feature an increase in presence.

PHASER: With the phaser, a second, phase-shifted signal is added to the original audio signal. The resulting sound is thicker and above all livelier. This effect is often used for guitar sounds and keyboards. In the 70s, it was also extensively used for other instruments like electric pianos. The PMH offers you four different phaser variations.

ROTARY SPEAKER: The simulation of a classic effect that is normally generated with a (slow or fast) rotating speaker.



DELAY: A delay of the input signal with various repetitions. Different tempo settings (ten variations in total) allow interesting delay effects.

ECHO: Similar to the stereo delay, with the difference being that the repetitions have less presence. This simulates the character of the original tape echo that was used before the digital era and can be thought of as a "Vintage Sound".

MULTI TAP: A delay effect with changing stereo positioning (left, center, right). Four variations are available.



CHORUS & REVERB: This algorithm combines the popular chorus with a reverb effect. Taking all variations into account, they differ in the length of reverb time.

FLANGER & REVERB: The combination of flanger and reverb effects.

PHASER & REVERB: The combination of a classic stereo phaser and a reverb effect. Here, too, the phaser is combined with different reverb types.

ROTARY SPEAKER & REVERB: The combination of a rotary speaker effect and reverb program.

DELAY & REVERB: Delay and reverb is the most common combination for vocals, solo guitars, etc.

PITCH & REVERB: The pitch shifter slightly detunes the audio signal, while the reverb adds ambience to the signal.

DELAY & CHORUS: Chorus can contribute to a wideness of the signal and interesting repetition effects can be adjusted with the delay. Vocals can be given a distinctive effect without making the voice sounding blurred.

DELAY & FLANGER: This effect is just right for creating a modern, slightly "spacy" vocal sound.

DELAY & PITCH: A repetition of the audio signal, with an oscillatory effect added by the pitch shifter.



3 VOICE PITCH: The pitch effect can be used to produce a cartoon-character type voice effect.

LFO BANDPASS: Filters, in general, influence the frequency response of a signal. A low-pass filter allows low frequencies to pass and suppresses high frequencies, while a high pass filter allows high frequencies to pass and suppresses low frequencies. This LFO bandpass effect is complemented by modulation from an LFO (Low Frequency Oscillator).

VOCAL DISTORTION: This effect is very hip when used on vocals and drum loops.

VINYLER: This effect adds clicks and noise to your audio signal, simulating old vinyl records.

EUROPOWER PMH660M/PMH880S

SPACE RADIO: Here, the typical sound of scanning an FM tuner is simulated. This can be a very interesting effect when sound-tracking radio plays.

TEST TONE: Use this 1-kHz test tone to facilitate P.A. level setting.

4. INSTALLATION

4.1 Mains connection

Blown fuses must be replaced by fuses of the same type and rating.

The mains connection is made using the enclosed power cord and a standard IEC receptacle. It meets all of the international safety certification requirements.

Please make sure that all units have a proper ground connection. For your own safety, never remove or disable the ground conductor from the unit or of the AC power cord.

4.2 Audio connections

The inputs and outputs of the BEHRINGER EUROPOWER are unbalanced 1/4" TS connectors—except for the balanced mono line inputs. Of course, all inputs and outputs work with both balanced and unbalanced connectors. The Tape Ins and Outs are on stereo RCA connectors.

Please ensure that only qualified personnel install and operate the power mixer. During installation and operation, the user must have sufficient electrical contact to earth. Electrostatic charges might affect the operation of the unit.

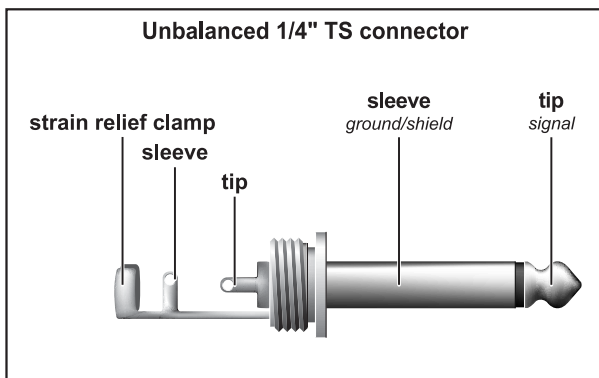
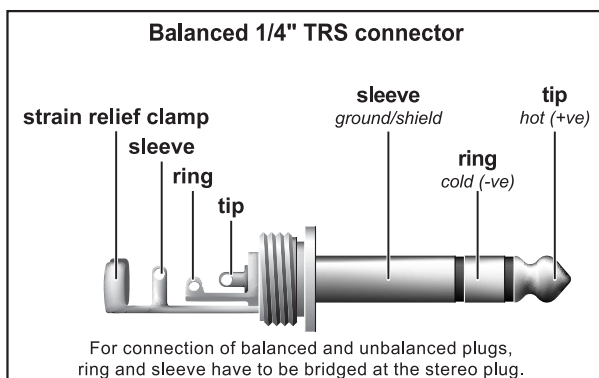

Fig. 4.1: 1/4" TS connector



For connection of balanced and unbalanced plugs, ring and sleeve have to be bridged at the stereo plug.

Fig. 4.2: 1/4" TRS connector

Balanced XLR connectors

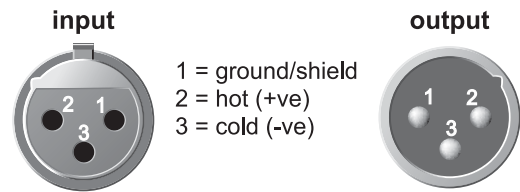

For unbalanced use pin 1 and pin 3 have to be bridged

Fig. 4.3: XLR connectors

1/4" TS footswitch connector

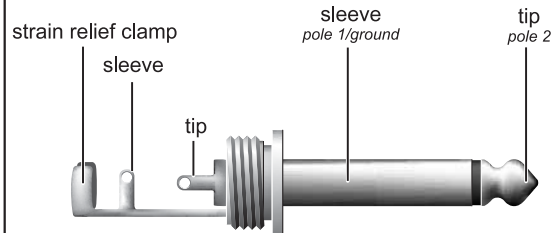

The footswitch connects both poles momentarily

Fig. 4.4: 1/4" TS connector for footswitch

Please use a dual footswitch for the PMH880S, so that you can enable/disable FX1 and FX2 independently of each other. In this case, the tip of the 1/4" plug controls FX1, and the ring controls FX2.

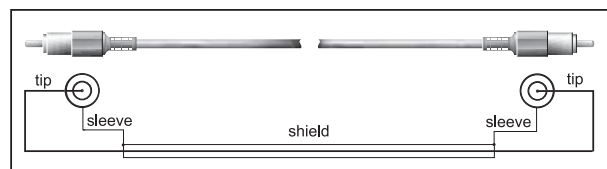

Fig. 4.5: RCA cable

4.3 Loudspeaker connection

Your EUROPOWER is equipped with high-quality NEUTRIK® SPEAKON®-compatible loudspeaker connectors, which ensure safe and trouble-free operation. The SPEAKON® connector was especially developed for high-power loudspeakers. Once it is plugged in, it safely locks into position and cannot be accidentally disengaged. It prevents the occurrence of electrical shock and ensures the correct polarity. Each of the connectors carries only the assigned single signal (see tab. 4.1/fig. 4.7 and the information on the rear panel of the power mixer).

EUROPOWER PMH660M/PMH880S

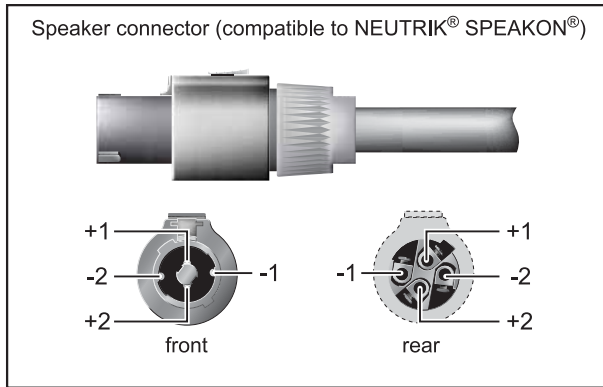

Fig. 4.6: Loudspeaker connector

Please be sure to only use commercial SPEAKON® cables (type NL4FC) for connecting your loudspeakers to the mixer. Please check the pin connections of your loudspeakers and cables depending on the EUROPOWER speaker output you choose.

EUROPOWER PMH880S				
OUTPUT A	1+	1-	2+	2-
MAIN L	POS	NEG	-	-
MON	POS	NEG	-	-
OUTPUT B	-	-	POS	NEG
OUTPUT B	1+	1-	2+	2-
MAIN R	POS	NEG	-	-
MONO	POS	NEG	-	-
BRIDGE	POS	-	NEG	-

EUROPOWER PMH660M				
OUTPUT A	1+	1-	2+	2-
MAIN MONO	POS	NEG	-	-
MON	POS	NEG	-	-
BRIDGE	-	-	-	-
OUTPUT B	1+	1-	2+	2-
MAIN MONO	POS	NEG	-	-
MAIN	POS	NEG	-	-
BRIDGE	POS	-	NEG	-

Tab. 4.1: Pin connections of loudspeaker connectors

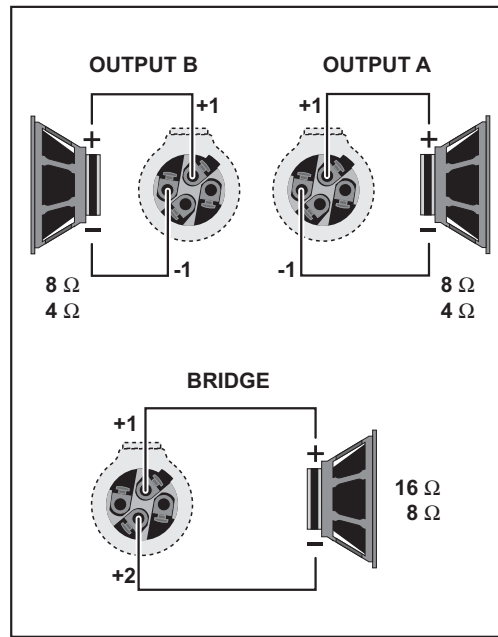

Fig. 4.7: SPEAKON® connector assignment

EUROPOWER PMH660M/PMH880S

5. WIRING EXAMPLES

For stereo operation the POWER AMP switch [28] of the PMH880S must be set to its upper position (MAIN L/MAIN R). Outputs A and B deliver the stereo main signal to the P.A. speakers. Two active speakers, wired in parallel, are connected to the PREAMP MONITOR output. They are used as on-stage monitor speakers. The effects processors can be switched on and off with a dual footswitch. This set-up is not possible with the PMH660M (no stereo operation possible).

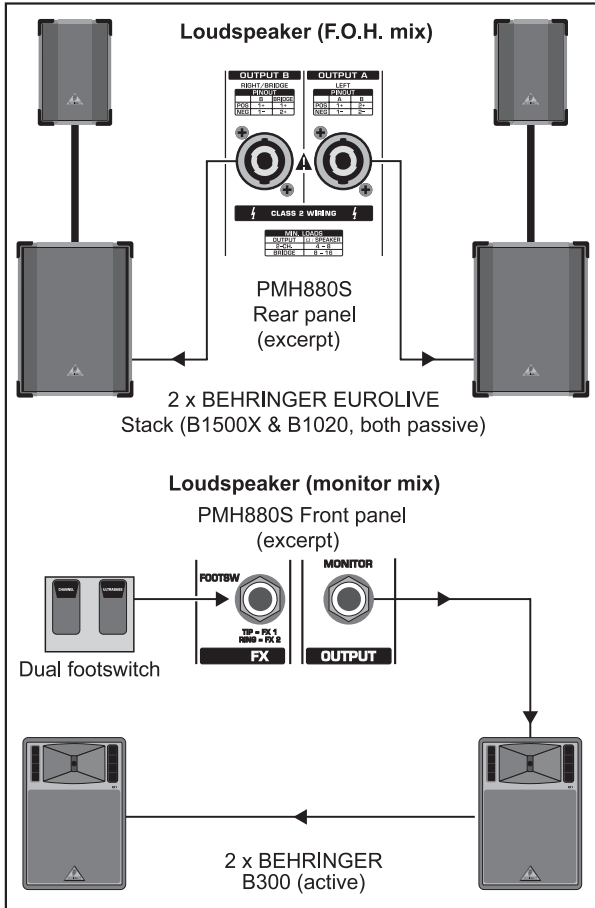

Fig. 5.1: EUROPOWER mixer as a stereo amplifier (example)

Both the PMH880S and the PMH660M can be set-up for dual mono operations. The POWER AMP switch [28] must be set to its lower (PMH660M) or center position (PMH880S). The two loudspeaker outputs provide the main and the monitor signals independently of each other and to two loudspeakers each, which are wired in parallel.

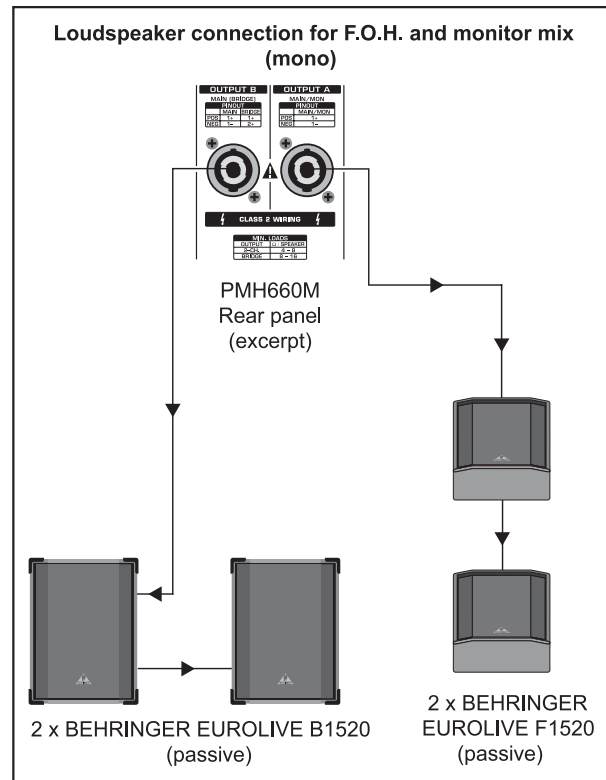

Fig. 5.2: EUROPOWER mixer as a dual mono amplifier (example)

EUROPOWER PMH660M/PMH880S

This illustration shows just one example of how the channels of your power mixer can be used, including the connection of mono and stereo sources, and the tape ins and outs recording the mix signal or playing back external signals.

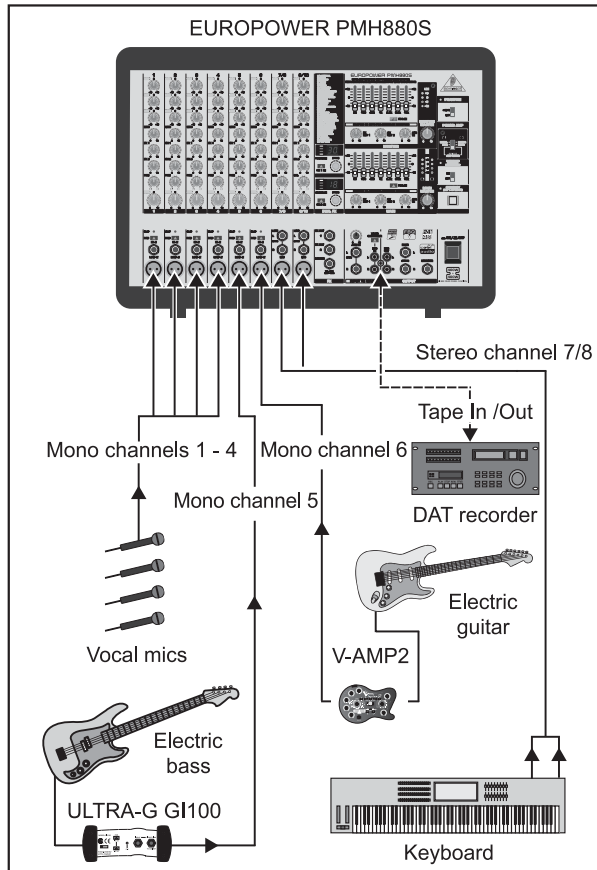

Fig. 5.3: Standard set-up (example)

One example of how to use your power mixer with a subwoofer in bridged mono mode. The illustration shows the PMH880S with a subwoofer connected to OUTPUT B that will receive the full (bridged) output power. A separate stereo power amp (BEHRINGER EUROPOWER EP1500) for the stereo main P.A. signal is connected to the PRE AMP MAIN outputs. The PRE AMP MONITOR output is wired to active speakers on the stage. This application can also be realized with the PMH660M, except for the main P.A. signal, which would be mono.

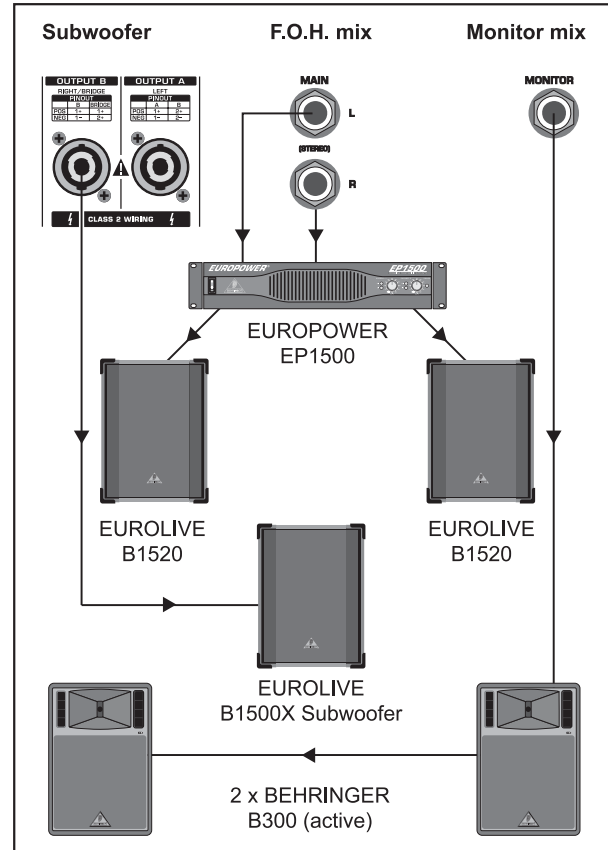

Fig. 5.4: EUROPOWER in bridged mono mode

EUROPOWER PMH660M/PMH880S

6. SPECIFICATIONS

	PMH660M	PMH880S
MICROPHONE INPUTS		
Type	XLR, electronically balanced input circuit	
Mic E.I.N. (20 Hz - 20 kHz)		
@ 0 Ω source resistance	-112 dB / 114 dB A-weighted	
@ 50 Ω source resistance	-112 dB / 114 dB A-weighted	
@ 150 Ω source resistance	-112 dB / 114 dB A-weighted	
Frequency response	< 10 Hz - 200 kHz (-1 dB)	
	< 10 Hz - > 200 kHz (-3 dB)	
Gain	+30 dB, +10 dB with pad	
Max. input level	+12 dBu @ +10 dB gain	
Impedance	approx. 2.2 k Ω balanced / 1.1 k Ω unbalanced	
Signal-to-noise ratio	110 dB / 114 dB A-weighted (0 dBu In @ +10 dB gain)	
Noise (THD + N)	0.001% / 0.0007% A-weighted	
MONO LINE INPUTS		
Type	1/4" TS connectors, balanced	
Impedance	approx. 20 k Ω , balanced	
Max. input level	+21 dBu	
STEREO LINE INPUTS		
Type	-	1/4" TRS connectors, unbalanced
Impedance	-	approx. 100 k Ω , unbalanced
Max. input level	-	+21 dBu
EQUALIZER		
Low	80 Hz / +/-15 dB	
Mid	2.5 kHz / +/-15 dB	
High	12 kHz / +/-15 dB	
2 TRACK INPUT		
Type	RCA	
Impedance	approx. 10 k Ω	
PREAMP OUTPUTS		
MAIN		
Type	1/4" TS connectors, unbalanced	
Impedance	approx. 150 Ω , unbalanced	
Max. output level	+21 dBu	
MONITOR		
Type	1/4" TS connectors, unbalanced	
Impedance	approx. 150 Ω , unbalanced	
Max. output level	+21 dBu	
STEREO OUTPUTS		
Type	-	1/4" TRS connectors, unbalanced
Impedance	-	approx. 150 Ω , unbalanced
Max. input level	-	+21 dBu
Type	RCA, mono output	RCA
Impedance	approx. 1 k Ω	approx. 1 k Ω
Max. input level	+21 dBu	+21 dBu
MAIN MIX SYSTEM DATA		
Noise		
MAIN MIX @ - ∞	-102 dB/-106 dB A-weighted	
Channel fader - ∞		
MAIN MIX @ 0 dB	-88 dB/-91 dB A-weighted	
Channel fader - ∞		
MAIN MIX @ 0 dB	-84 dB/-86 dB A-weighted	
Channel fader @ 0 dB		
LOUDSPEAKER OUTPUTS		
Type	NEUTRIK [®] SPEAKON [®] -compatible	
Load impedance		
MAIN L/R	-	4 - 8 Ω
MONITOR/MAIN MONO	4 - 8 Ω	
MAIN MONO/MAIN MONO	4 - 8 Ω	
BRIDGE	8 - 16 Ω	
DSP		
Converter	24-bit Delta-Sigma, 64/128-times oversampling	
Dynamics D/A	90 dB	
Sampling rate	46.875 kHz	
Delay Time	max. 5 secs	
Signal run time (Line In > Line Out)	approx. 1.5 msecs	
DISPLAY		
Type	2-digit, 7-segment LED	2 x 2-digit, 7-segment LED
AMPLIFIER		
	Output power	
Output power @ 4 Ω	2 x 200 W	2 x 400 W
Output power @ 8 Ω (BRIDGE)	1 x 400 W	1 x 600 W
POWER SUPPLY		
Mains voltage	100 - 240 V~, 50 / 60 Hz	
Power consumption	500 W	700 W
Fuse	T 5 A H 250 V	T 6.3 A H 250 V
Mains connector	IEC standard receptacle	
DIMENSIONS/WEIGHT		
Dimensions (H x W x D)	approx. 12 2/5" x 18 1/10" x 8 3/5"	
	approx. 315 mm x 460 mm x 220 mm	
Weight	8.5 kg	9.4 kg
	18.74 lb.	20.73 lb.

BEHRINGER is constantly striving to maintain the highest professional standards. As a result of these efforts, modifications may be made from time to time to existing products without prior notice. Specifications and appearance may differ from those listed or illustrated.

7. WARRANTY

§ 1 WARRANTY CARD/ONLINE REGISTRATION

To be protected by the extended warranty, the buyer must complete and return the enclosed warranty card within 14 days of the date of purchase to BEHRINGER Spezielle Studiotechnik GmbH, in accordance with the conditions stipulated in § 3. Failure to return the card in due time (date as per postmark) will void any extended warranty claims. Based on the conditions herein, the buyer may also choose to use the online registration option via the Internet (www.behringer.com or www.behringer.de).

§ 2 WARRANTY

1. BEHRINGER (BEHRINGER Spezielle Studiotechnik GmbH including all BEHRINGER subsidiaries listed on the enclosed page, except BEHRINGER Japan) warrants the mechanical and electronic components of this product to be free of defects in material and workmanship for a period of one (1) year* from the original date of purchase, in accordance with the warranty regulations described below. If the product shows any defects within the specified warranty period that are not excluded from this warranty as described under § 4, BEHRINGER shall, at its discretion, either replace or repair the product using suitable new or reconditioned parts. In the case that other parts are used which constitute an improvement, BEHRINGER may, at its discretion, charge the customer for the additional cost of these parts.

2. If the warranty claim proves to be justified, the product will be returned to the user freight prepaid.

3. Warranty claims other than those indicated above are expressly excluded.

§ 3 RETURN AUTHORIZATION NUMBER

1. To obtain warranty service, the buyer (or his authorized dealer) must call BEHRINGER (see enclosed list) during normal business hours **BEFORE** returning the product. All inquiries must be accompanied by a description of the problem. BEHRINGER will then issue a return authorization number.

2. Subsequently, the product must be returned in its original shipping carton, together with the return authorization number to the address indicated by BEHRINGER.

3. Shipments without freight prepaid will not be accepted.

§ 4 WARRANTY REGULATIONS

1. Warranty services will be furnished only if the product is accompanied by a copy of the original retail dealer's invoice. Any product deemed eligible for repair or replacement under the terms of this warranty will be repaired or replaced.

2. If the product needs to be modified or adapted in order to comply with applicable technical or safety standards on a national or local level, in any country which is not the country for which the product was originally developed and manufactured, this modification/adaptation shall not be considered a defect in materials or workmanship. The warranty does not cover any such modification/adaptation, irrespective of whether it was carried out properly or not. Under the terms of this warranty, BEHRINGER shall not be held responsible for any cost resulting from such a modification/adaptation.

3. Free inspections and maintenance/repair work are expressly excluded from this warranty, in particular, if caused by improper handling of the product by the user. This also applies to defects caused by normal wear and tear, in particular, of faders, crossfaders, potentiometers, keys/buttons, tubes, guitar strings, illuminants and similar parts.

4. Damages/defects caused by the following conditions are not covered by this warranty:

- ▲ improper handling, neglect or failure to operate the unit in compliance with the instructions given in BEHRINGER user or service manuals.
- ▲ connection or operation of the unit in any way that does not comply with the technical or safety regulations applicable in the country where the product is used.
- ▲ damages/defects caused by force majeure or any other condition that is beyond the control of BEHRINGER.

5. Any repair or opening of the unit carried out by unauthorized personnel (user included) will void the warranty.

6. If an inspection of the product by BEHRINGER shows that the defect in question is not covered by the warranty, the inspection costs are payable by the customer.

7. Products which do not meet the terms of this warranty will be repaired exclusively at the buyer's expense. BEHRINGER will inform the buyer of any such circumstance. If the buyer fails to submit a written repair order within 6 weeks after notification, BEHRINGER will return the unit C.O.D. with a separate invoice for freight and packing. Such costs will also be invoiced separately when the buyer has sent in a written repair order.

§ 5 WARRANTY TRANSFERABILITY

This warranty is extended exclusively to the original buyer (customer of retail dealer) and is not transferable to anyone who may subsequently purchase this product. No other person (retail dealer, etc.) shall be entitled to give any warranty promise on behalf of BEHRINGER.

§ 6 CLAIM FOR DAMAGES

Failure of BEHRINGER to provide proper warranty service shall not entitle the buyer to claim (consequential) damages. In no event shall the liability of BEHRINGER exceed the invoiced value of the product.

§ 7 OTHER WARRANTY RIGHTS AND NATIONAL LAW

1. This warranty does not exclude or limit the buyer's statutory rights provided by national law, in particular, any such rights against the seller that arise from a legally effective purchase contract.

2. The warranty regulations mentioned herein are applicable unless they constitute an infringement of national warranty law.

* Customers in the European Union please contact BEHRINGER Germany Support for further details.

Technical specifications and appearance subject to change without notice. The information contained herein is correct at the time of printing. The names of companies, institutions or publications pictured or mentioned and their respective logos are registered trademarks of their respective owners. Their use neither constitutes a claim of the trademarks by BEHRINGER® nor affiliation of the trademark owners with BEHRINGER®. BEHRINGER® accepts no liability for any loss which may be suffered by any person who relies either wholly or in part upon any description, photograph or statement contained herein. Colours and specification may vary slightly from product. Products are sold through our authorised dealers only. Distributors and dealers are not agents of BEHRINGER® and have absolutely no authority to bind BEHRINGER® by any express or implied undertaking or representation. No part of this manual may be reproduced or transmitted in any form or by any means, electronic or mechanical, including photocopying and recording of any kind, for any purpose, without the express written permission of BEHRINGER Spezielle Studiotechnik GmbH. BEHRINGER® is a registered trademark.

ALL RIGHTS RESERVED. © 2004 BEHRINGER Spezielle Studiotechnik GmbH,
Hanns-Martin-Schleyer-Str. 36-38, 47877 Willich-Münchheide II, Germany.
Tel. +49 2154 9206 0, Fax +49 2154 9206 4903