

LC15-110

OPERATING INSTRUCTIONS - I

Laney

POWER TO THE MUSIC



LANEY AMPLIFICATION

www.laney.co.uk

WARNING: When using electric products, basic cautions should always be followed, including the following.



1. Read all safety and operating instructions before using this product
2. The product should be powered by a three pin grounded (or earthed) plug connected to a power socket with a grounded earth outlet.
3. All safety and operating instructions should be retained for future reference
4. Obey all cautions in the Operating instructions and on the back of the unit
5. All operating instructions should be followed
6. This product should not be used near water, i.e. a bathtub, sink, swimming pool, wet basement, etc.
7. This product should be located so that its position does not interfere with its proper ventilation. It should not be placed flat against a wall or placed in a built up enclosure that will impede the flow of cooling air.
8. This product should not be placed near a source of heat such as stove, radiator, or another heat producing amplifier.
9. Connect only to a power supply of the type marked on the unit adjacent to the power supply cord.
10. Never break off the ground pin on a power supply cord.
11. Power supply cords should always be handled carefully. Never walk or place equipment on power supply cords. Periodically check cords for cuts or signs of stress, especially at the plug and the point where the chord exits the unit.
12. The power supply cord should be unplugged when the unit is to be unused for long periods of time.
13. If this product is to be mounted in an equipment rack, rear support should be provided.
14. The user should allow easy access to any mains plug, mains coupler and mains switch used in conjunction with this unit thus making it readily operable.
15. Metal parts can be cleaned with a damp cloth. The vinyl covering used on some units can be cleaned with a damp cloth or ammonia based household cleaner if necessary. Disconnect the unit from the power supply before cleaning.
16. Care should be taken so that objects do not fall and liquids are not spilled into the unit through any ventilation holes or openings. On no account place drinks on the unit.
17. A qualified service technician should check the unit if:
 - The power cord has been damaged
 - Anything has fallen or spilled into the unit
 - The unit does not appear to operate correctly
 - The unit has been dropped or the enclosure damaged.

18. The user should not attempt to service the equipment. All service work is done by a qualified service technician.

19. Exposure to extremely high noise levels may cause a permanent hearing loss. Individuals vary considerably in susceptibility to noise induced hearing loss, but nearly everyone will lose some hearing if exposed to sufficiently intense noise for a sufficient time. The U.S. Government's Occupational Safety and Health Administration (OSHA) has specified the following permissible noise level exposure. (See opposite).

According to OSHA, any exposure in excess of the permissible limits could result in some hearing loss. Ear plugs or protectors in the ear canals or over the ears must be worn when operating this amplification system in order to prevent a permanent hearing loss if exposure exceeds the limits set forth above. To ensure against potentially dangerous exposure to high sound pressure levels it is recommended that all persons exposed to equipment capable of producing high sound pressure levels such as this amplification system be protected by hearing protectors while this unit is in operation.

Duration Per Day In Hours	Sound Level dBA, slow response
8	90
6	92
4	95
3	97
2	100
1 1/2	102
1	105
1/2	110
1/4 or less	115

	<p>Intended to alert the user to the presence of uninsulated 'Dangerous Voltage' within the products enclosure that may be sufficient to constitute a risk of electrical shock to persons.</p> <p>Ce symbole est utilisé pour indiquer à l'utilisateur de ce produit de tension non-isolée dangereuse pouvant être d'intensité suffisante pour constituer un risque de choc électrique.</p> <p>Este simbolo tiene el proposito de alertar al usuario de la presencia de '(voltaje) peligroso' que no tiene aislamiento dentro de la caja del producto que puede tener una magnitud suficiente como para constituir riesgo de corrientazo.</p> <p>Dieses Symbol soll den Anwender vor unisolierten gefährlichen Spannungen innerhalb des Gehäuses warnen, die von Ausreichender Stärke sind, um einen elektrischen Schlag verursachen zu können.</p>
	<p>Intended to alert the user of the presence of important operating and maintenance (Servicing) instructions in the literature accompanying the product.</p> <p>Dieses Symbol soll den Anwender vor unisolierten gefährlichen Spannungen innerhalb des Gehäuses warnen, die von Ausreichender Stärke sind, um einen elektrischen Schlag verursachen zu können.</p> <p>Este simbolo tiene el proposito de la alertar al usuario de la presencia de instrucciones importantes sobre la operación y mantenimiento en la literatura que viene con el producto.</p> <p>Dieses Symbol soll den Benutzer auf wichtige Instruktionen in der Bedienungsanleitung aufmerksam machen, die Handhabung und Wartung des Produkts betreffen.</p>
<p>CAUTION:</p> <p>ATTENTION:</p> <p>PRECAUCION:</p> <p>VORSICHT:</p>	<p>Risk of electrical shock - DO NOT OPEN. To reduce the risk of electrical shock, do not remove the cover. No user serviceable parts inside. Refer servicing to qualified personnel.</p> <p>Risques de choc électrique - NE PAS OUVRIER. Afin de réduire le risque de choc électrique, ne pas enlever le couvercle. Il ne se trouve à l'intérieur aucune pièce pouvant être réparée par l'utilisateur. Confier l'entretien à un personnel qualifié.</p> <p>Riesgo de corrientazo - no abra Para disminuir el riesgo de corrientazo, no abra la cubierta. No hay piezas adentro que el pueda reparar. Deje todo mantenimiento a los técnicos calificados.</p> <p>Risiko - Elektrischer Schlag! Nicht öffnen! Um das Risiko eines elektrischen Schlages zu vermeiden, nicht die Abdeckung entfernen. Es befinden sich keine Teile darin, die vom Anwender repariert werden könnten. Reparaturen nur von qualifiziertem Fachpersonal durchführen lassen.</p>
<p>WARNING:</p> <p>ADVERTISSEMENT:</p> <p>ADVERTENCIA:</p> <p>ACHTUNG:</p>	<p>To prevent electrical shock or fire hazard, do not expose this appliance to rain or moisture. Before using this appliance please read the operating instructions for further warnings.</p> <p>Afin de prévenir les risques de décharge électrique ou de feu, n'exposez pas cet appareil à la pluie ou à l'humidité. Avant d'utiliser cet appareil, lisez les avertissements supplémentaires situés dans le guide.</p> <p>Para evitar corrientazos o peligro de incendio, no deja expuesto a la lluvia o humedad este aparato Antes de usar este aparato, lea las advertencias en la guía de operación.</p> <p>Um einen elektrischen Schlag oder Feuergefahr zu vermeiden, sollte dieses Gerät nicht dem Regen oder Feuchtigkeit ausgesetzt werden. Vor Inbetriebnahme unbedingt die Bedienungsanleitung lesen.</p>

BEFORE SWITCHING ON

After unpacking your amplifier check that it is factory fitted with a three pin 'grounded' (or earthed) plug. Before plugging into the power supply ensure you are connecting to a grounded earth outlet.

If you should wish to change the factory fitted plug yourself, ensure that the wiring convention applicable to the country where the amplifier is to be used is strictly conformed to. As an example in the United Kingdom the cable colour code for connections are as follows.

EARTH or GROUND GREEN/YELLOW
NEUTRAL - BLUE
LIVE - BROWN



NOTE

This manual has been written for easy access of information. The front and rear panels are graphically illustrated, with each control and feature numbered. For a description of the function of each control feature, simply check the number with the explanations adjacent to each panel.

Your Laney amplifier has undergone a thorough two stage, pre-delivery inspection, involving actual play testing.

When you first receive your Laney guitar amplifier, follow these simple procedures:

(i) Ensure that the amplifier is the correct voltage for the country it is to be used in.

(ii) Connect your instrument with a high quality shielded instrument cable. You have probably spent considerable money on your amplifier and guitar - don't use poor quality cable it won't do your gear justice.

Please retain your original carton and packaging so in the unlikely event that some time in the future your amplifier should require servicing you will be able to return it to your dealer securely packed.

Care of your Laney amplifier will prolong it's life.....and yours!

Dear Player,

Thank you very much for purchasing your new Laney product and becoming part of the worldwide Laney family. Each and every Laney unit is designed and built with the utmost attention to care and detail, so I trust yours will give you many years of enjoyment.

Laney products have a heritage which stretches back to 1967 when I first began building valve amplifiers in my parent's garage.

Since then we have moved on from strength to strength developing an extensive range of guitar, bass, public address and keyboard amplification products along with a list of Laney endorsees that includes some of the world's most famous and respected musicians.

At the same time we believe we have not lost sight of the reason Laney was founded in the first place - a dedication to building great sounding amplification for working musicians.

Warm Regards,

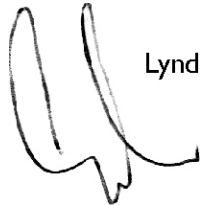
A handwritten signature in black ink, appearing to read 'Lyndon Laney', written in a cursive style.

Lyndon Laney CEO



INTRODUCTION

The LC15-110 is a no nonsense 15W all tube combo amplifier, its 15W Class A/B output stage oozes classic, warm tube tones: The harder you drive it, the better it sounds. Plus with enough gain for contemporary tones, it also has a mean, spiteful side to it as well – making it ideal for any style of playing. Perfect for studio and practice use, but also equally at home or on stage plugged into a Laney 4x12” cabinet, the sound will blow you away. The LC15-110 includes a built in footswitchable reverb with level control; FX loop with switchable level & by-pass for total flexibility.

Your LC15-110 should give you years of trouble-free amplification, however please take time to read this manual and familiarise yourself with the controls as it will allow you to get the best from your amplifier. We hope you enjoy using your LC15-110 as much as we enjoyed designing and making it.

Best wishes from all at Laney

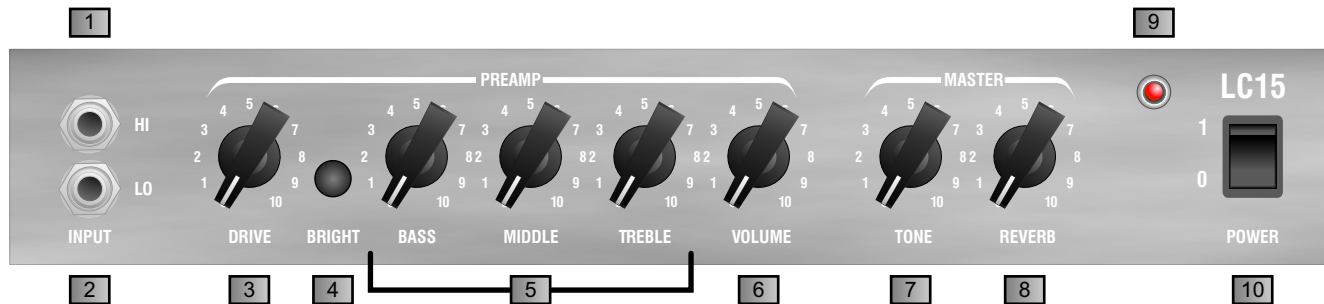

- 1 **HI INPUT:** 'Hi' stands for high gain. This input is designed for the connection of low output level guitars making it well suited for guitars with single coiled or low gain humbucker type pickups. Use of high gain pickups in this input may drive the preamp too hard causing a "mushy" sound. Only use good quality guitar cable.
- 2 **LO INPUT:** 'Lo' stands for low gain. This input is attenuated down approximately 50% from the Hi input and is designed for high output level guitars. It is useful in obtaining output that is "tight" not "mushy" from high gain humbucker type pickups. Only use good quality guitar cable.
- 3 **DRIVE:** Sets the level of tube preamplifier drive or how dirty your sound is. This control should be used in conjunction with the Volume (6) Setting low levels of gain with high levels of volume will give a clean preamplifier sound with tube output stage overdrive. Setting a medium drive level and medium volume will give a nice crisp bluesy tone, again with the ability to drive the output stage at higher volume settings. Setting a high level on the Drive control and a low setting on the Volume will give you a punchy hard rock tone, with the ability to again drive the output tubes at higher Drive volume settings. Having set the Drive and Drive Volume controls to your desired sound try backing off your guitar volume and tone controls for lots of other cool sounds. Good tube amplifiers have the unique ability to produce a wide range of sounds by using only your guitar controls, playing weight and style.

- 4 **BRIGHT:** Adds brightness and life to the treble frequencies of your guitar when on the clean channel. The switch has more effect at low Clean Volume control settings. Use in conjunction with the Treble and Tone controls for optimum performance.
- 5 **BASS, MIDDLE, TREBLE:** These are a traditional set of passive tone controls for the clean channel. Passive controls have the advantage of always sounding musical at any of their settings mainly due to their unique interactive nature. This gives players a more natural set of tools to create their ideal sound. (Try them all set at midway (5) as a good starting point).
- 6 **VOLUME:** Sets how loud the clean channel is. Try cranking it up a little to drive the power tubes harder for that real retro sound and feel that only a quality tube amplifier can deliver. Now use your guitar volume to control the amount of distortion.
- 7 **STONE:** The tone control works in a similar fashion to the Tone control you probably have on your guitar except that it uniquely works at the other end of the amplification chain. This has the ability to not only control the overall top end response but also reduce upper end harmonics on the output stage and preamplifier overdrive sounds. This will give you bright cutting sounds at high settings and smooth rounded sounds at lower settings. (Midway (5) is a good starting point)
- 8 **REVERB:** Controls how loud the built in reverb sounds.
- 9 **POWER LED:** This led will be lit when the amplifier is switched on. **(Always switch off and disconnect the power cord when not in use)**
- 10 **POWER:** Main power switch for the unit. Tube amplifiers take between 30 seconds and 2 minutes to warm up and be ready to play after switching on, this is normal.

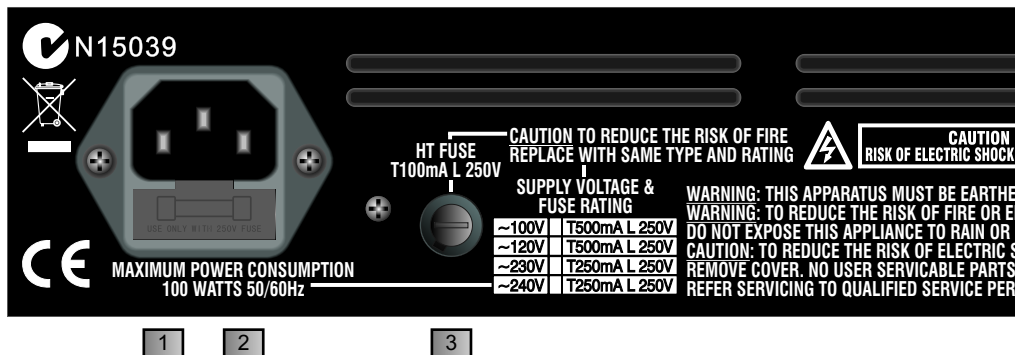

- 1 **POWER INLET SOCKET:** Connect to your power source. Make sure the specified voltage is correct for your country!
- 2 **POWER FUSE:** This drawer contains the main safety fuse for the unit. The fuse protects the AC power to the amplifier. USE ONLY THE CORRECT SIZE AND RATING OF FUSE AS SPECIFIED ON THE PANEL. If a fuse blows or fails and a replacement of the same size and rating is installed and it in turn blows, the amplifier has suffered a malfunction internally and needs immediate service from a qualified technician. DO NOT TRY USING A FUSE OF HIGHER RATING. Using a fuse that is too large in current rating may cause serious, irreparable damage to the amplifier and presents a serious fire hazard. The mains fuse ratings are detailed in the specs section at the rear of this manual. (Spare fuse included in the tray.)
- 3 **HT FUSE:** This fuse protects the DC power to the tubes within the amplifier. USE ONLY THE CORRECT SIZE AND RATING FUSE AS SPECIFIED ON THE PANEL. If a fuse blows or fails and a replacement of the same size and rating is installed and it in turn blows, the amplifier has suffered a malfunction, at this point check the output tubes and replace faulty ones if required. Should tubes not be the problem the amplifier should be checked out by a qualified technician. Do not try using a fuse of greater value. Using a fuse that is too large in current rating may cause serious, irreparable damage to the amplifier. Fuses are designed to protect, do not take chances.
- 4 **EFFECTS LOOP: SEND/LINE OUT:** Connect the input of your external effect to this socket. All of the signal leaves the amplifier via the 'Send' socket to be processed and comes back from the effects via the 'Return' socket. This socket can also be used to control another LC15-110 amplifier connected to this socket via its own return socket. Some Effects are better suited to being between the guitar and amplifier input - these are foot pedal types / distortion / wah wah pedals etc. Rack

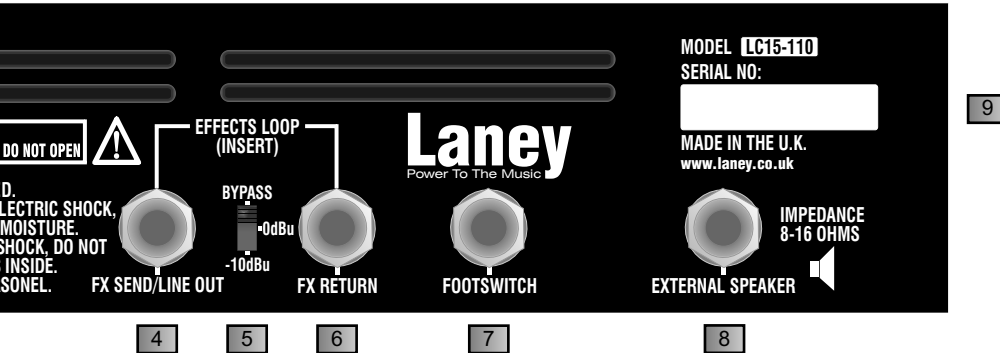

mount effects will work better in the FX loop on the amplifier rear. Stomp boxes are normally designed for small signals such as a guitar output whereas rack mount FX are designed for the higher signal level obtained from an FX send. This socket can also be used as a Line Level Out.

- 5 BY-PASS/LEVEL SWITCH:** This switch allows the effects loop to be by-passed if not in use, it also gives you the option of running the FX loop at 0dB (750mV) or at -10dB (250mV) to suit your processor.
- 6 EFFECTS LOOP: RETURN:** Connect the output from your external effects to this socket. The effects loop allows you to connect external effects such as tremolo's, chorus and delays to your amplifier. All of the signal leaves the amplifier via the `Send` socket and comes back from the effects via the `Return` socket. Use the output level control on your FX to control how loud the FX return signal sounds. This is an insert type control, therefore you need to set the Dry/Wet mix in your FX processor.
- 7 FOOTSWITCH SOCKET:** Provided for the connection of a Laney FS1 footswitch (optional).
- 8 EXTENSION CABINET:** Use to connect an 8-16 ohm extension cabinet. Please note mismatched impedance will reduce the amplifiers performance and in some cases may cause damage to your amplifier. Try the LC15-110 into a Laney extension cabinet - you will be amazed what this baby cranks out.
- 9 SERIAL NO:** Displays the model and serial number of the unit.

Laney

QUICK START SETTINGS - *suggestions only, experiment!*

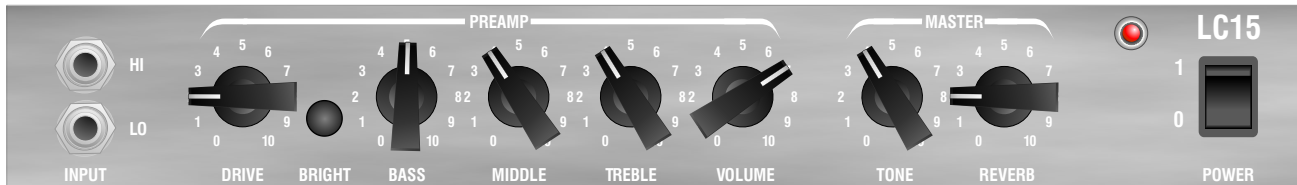

CLEAN



ROCK RHYTHM



BLUES LEAD

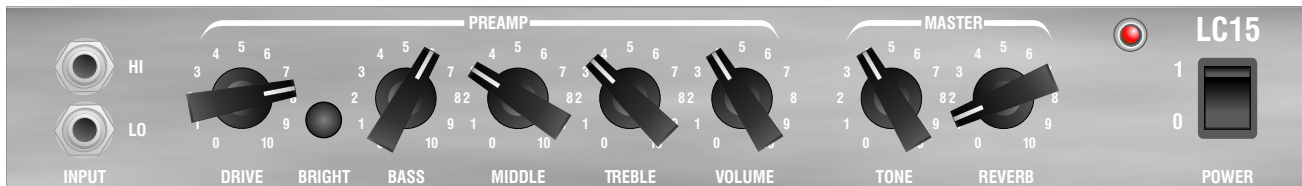

ROCK LEAD

USER SETTINGS - Store your own cool sounds

Laney

LC15-110

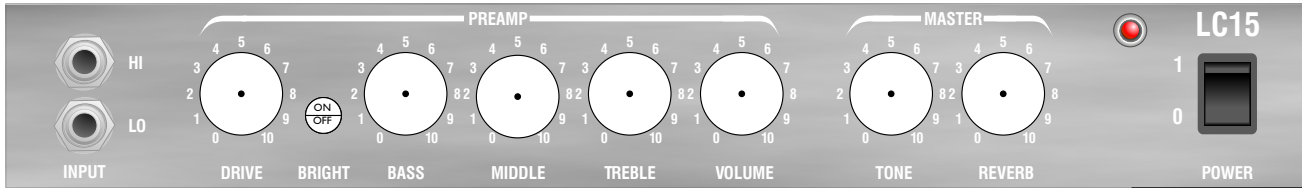
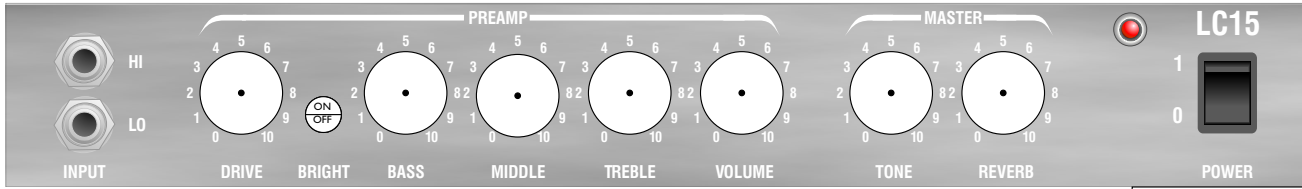
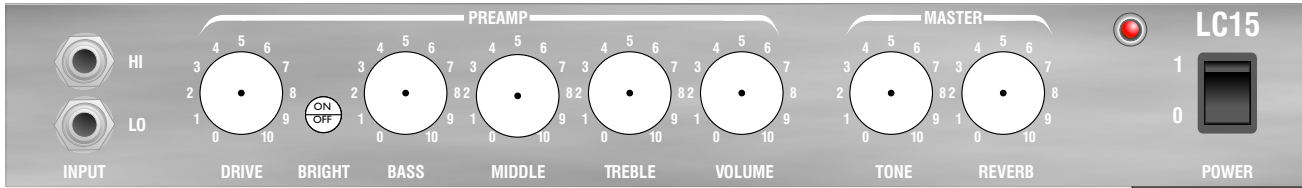
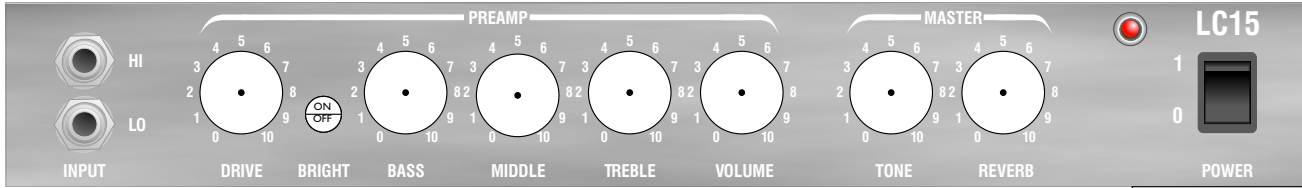

- **Tube amplifiers;** generally sound much warmer/sweeter than solid state transistor amplifiers but they also need a little more respect due to the fragile glass tubes themselves. The LC15-110 uses top quality tubes, which should give you years of trouble free service, however like all tube amps; it is important to treat it with a certain amount of care.
- **Tubes are fragile glass components;** they can easily be damaged if thrown in and out of vehicles,
- **Make sure the impedance;** of your cabinets matches the setting on your amplifier. Improper impedance matching will result in reduced output power output and compromised sound at best and amplifier failure/premature tube failure at worst.
- **Allow the amplifier;** to warm up to room temperature before switching it on, The sudden thermal shock generated can crack the cold glass tube housing plus any moisture is bad news around high voltage electronics.
- **Allow the amplifier;** to cool down after playing before moving. Hot tubes are more susceptible to damage than cool ones. Use good quality loudspeaker leads, cheap leads are often not up to the job of handling the large requirements for loudspeakers and can often short out.
- **Tube amplifiers;** don't like running into an open circuit. A tubes life expectancy is based upon a number of factors which include operating temperature, how hard and how often it is played, vibration due to travel etc. Tubes should be changed in your amplifier if you notice any change in your amplifiers performance etc. They need not be changed at any regular interval.
- **Typical problems;** with preamp tubes can be a crackly noise, hiss, hum and microphony. The preamp tubes can safely be changed with no action required if they fail or reduce in performance. Typical output tube problems can be blown HT fuse; sound lacking in punch, sound lacks extreme highs or lows and low level hum. The Output tubes can be replaced singularly if you replace them with the exact same type AND grade as factory fitted otherwise they should be replaced as a set. See the diagram following to see how to check the tube grade fitted. Exact replacement preamp tubes and matched sets of output tubes are available from Laney via your dealer.
- **To change a tube;** switch off the unit and unplug from the mains supply. Wait for the tubes to cool down. Lay amplifier down on its front face and remove the protective grille held in place with four screws. You should now be able to access the underside of the amplifier chassis. Preamp tubes are protected with a screen can, to remove; gently twist the screen can anti clockwise and then pull up. The tube can then be gently pulled out. Take care when pushing the new tube in to make sure the pins are all aligned properly. Output tubes have a spring retainer which must be pulled away before the tube will come out.
- **Amplifier connection;** In order to avoid damage, it is advisable to establish and follow a pattern for turning on and off your equipment. With all system parts connected, effects processors etc. **BEFORE** turning on your guitar amplifier. Many products have large transient surges at turn on and off which can cause damage to your speakers. By turning on your guitar amplifier **LAST** and making sure its Volume controls are set to minimum any transients from other equipment will not reach

your loudspeakers. Wait until all system parts have stabilised; usually a couple of seconds. Similarly when turning off your system always turn down the Volume controls on your guitar amplifier and then turn off its power before turning off other equipment.

- **Servicing:** The user should not attempt to service these products. Refer all servicing to qualified service personnel.

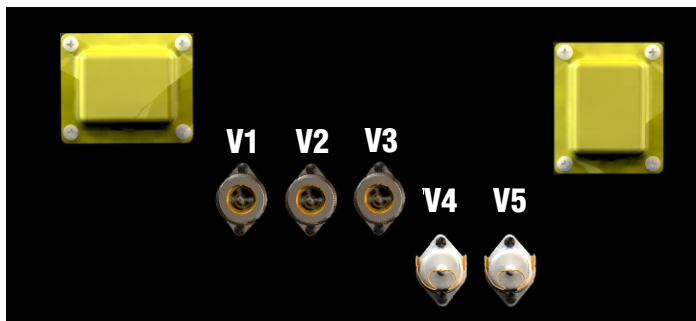

V1	ECC83	HIGRADE
V2+V3	ECC83	
V4+V5	EL84	MATCHED SET



EL84
Grade Number

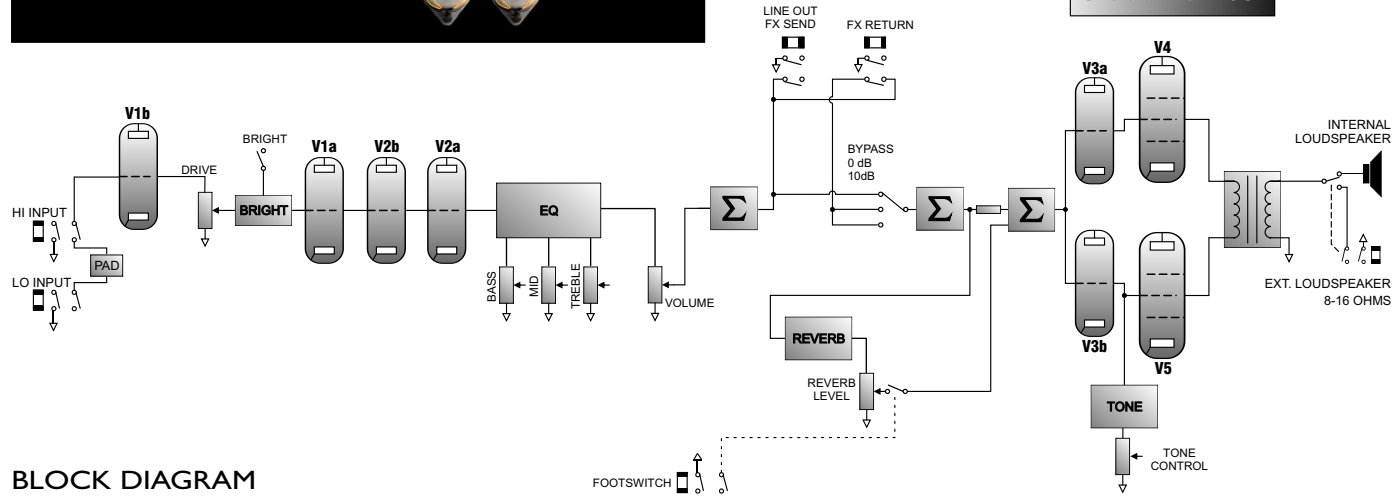

BLOCK DIAGRAM

Laney

LCI 5 SAMPLE SYSTEMS



SPECIFICATIONS

Laney

LC15-110

Supply Voltage	~100V, ~120V, ~230V, ~240V 50/60Hz Factory Option	
Mains Fuse	(~100>120V = T500mA L 250V)	(~230V>240V = T250mA L 250V)
HT Fuse	T100mA L	
Power Consumption	50W	
Output Power Rating	15W	
Loudspeaker	Custom Designed 10"	
Loudspeaker outputs	Extension speaker socket	(Disconnects Internal speaker)
	(Minimum 8 Ohm Impedance)	
Features	Pure Class A/B Valve tone	
	2xEL84 Power Tubes	(Matched Set TAD)
	3xECC83/12AX7 Preamp tubes	(TAD)
	Hi & Lo Gain Inputs	
	FX Loop With Switchable Level & By-Pass	
Footswitchable	(FSI Optional)	
Reverb	Yes	
EQ	Passive Bass, Middle and Treble	
	Bright Switch	
Input Impedance	1MΩ	
Size (H*W*D)	363*386*248 (Base)	
Unit Weight	10.5 Kg	(Shipping Weight 12Kg)

This product conforms to the requirements of the following European Regulations, Directives & Rules:-
CE Mark (93/68/EEC), Low Voltage (72/23/EEC), EMC (93/68/EEC),
RoHS (EU2002/95/EC), WEEE (EU2002/96/EC)



In order to reduce environmental damage, at the end of its useful life, this product must not be disposed of along with normal household waste to landfill sites. It must be taken to an approved recycling centre according to the recommendations of the WEEE (Waste Electrical and Electronic Equipment) directive applicable in your country.

Laney
POWER TO THE MUSIC

LANEY AMPLIFICATION
www.laney.co.uk

In the interest of continued product development, Laney reserves the right to amend product specification without prior notification.