

# JamMan Express XT

Stereo Looper w/JamSync

**DiGiTech**  
by HARMAN



# Owner's Manual

# IMPORTANT SAFETY INSTRUCTIONS



**WARNING:** TO REDUCE THE RISK OF FIRE OR ELECTRIC SHOCK DO NOT EXPOSE THIS EQUIPMENT TO RAIN OR MOISTURE

The symbols shown above are internationally accepted symbols that warn of potential hazards with electrical products. The lightning flash with arrowpoint in an equilateral triangle means that there are dangerous voltages present within the unit. The exclamation point in an equilateral triangle indicates that it is necessary for the user to refer to the owner's manual.

These symbols warn that there are no user serviceable parts inside the unit. Do not open the unit. Do not attempt to service the unit yourself. Refer all servicing to qualified personnel. Opening the chassis for any reason will void the manufacturer's warranty. Do not get the unit wet. If liquid is spilled on the unit, shut it off immediately and take it to a dealer for service. Disconnect the unit during storms to prevent damage.

The following is indicative of low altitude use; do not use this product above 2000m.



## U.K. MAINS PLUG WARNING

A molded mains plug that has been cut off from the cord is unsafe. Discard the mains plug at a suitable disposal facility.

**NEVER UNDER ANY CIRCUMSTANCES SHOULD YOU INSERT A DAMAGED OR CUT MAINS PLUG INTO A 13 AMP POWER SOCKET.**

Do not use the mains plug without the fuse cover in place. Replacement fuse covers can be obtained from your local retailer. Replacement fuses are 13 amps and **MUST** be ASTA approved to BS1362.



If you want to dispose this product, do not mix it with general household waste. There is a separate collection system for used electronic products in accordance with legislation that requires proper treatment, recovery and recycling.

Private households in the 25 member states of the EU, in Switzerland and Norway may return their used electronic products free of charge to designated collection facilities or to a retailer (if you purchase a similar new one).

For Countries not mentioned above, please contact your local authorities for a correct method of disposal.

By doing so you will ensure that your disposed product undergoes the necessary treatment, recovery and recycling and thus prevent potential negative effects on the environment and human health.

## WARNING FOR YOUR PROTECTION READ THE FOLLOWING:

KEEP THESE INSTRUCTIONS

HEED ALL WARNINGS

FOLLOW ALL INSTRUCTIONS

The apparatus shall not be exposed to dripping or splashing liquid and no object filled with liquid, such as vases, shall be placed on the apparatus.

CLEAN ONLY WITH A DRY CLOTH.

FOR INDOOR USE ONLY.

DO NOT BLOCK ANY OF THE VENTILATION OPENINGS. INSTALL IN ACCORDANCE WITH THE MANUFACTURER'S INSTRUCTIONS.

DO NOT INSTALL NEAR ANY HEAT SOURCES SUCH AS RADIATORS, HEAT REGISTERS, STOVES, OR OTHER APPARATUS (INCLUDING AMPLIFIERS) THAT PRODUCE HEAT.

ONLY USE ATTACHMENTS/ACCESSORIES SPECIFIED BY THE MANUFACTURER.

UNPLUG THIS APPARATUS DURING LIGHTNING STORMS OR WHEN UNUSED FOR LONG PERIODS OF TIME.

Do not defeat the safety purpose of the polarized or grounding-type plug. A polarized plug has two blades with one wider than the other. A grounding type plug has two blades and a third grounding prong. The wide blade or third prong are provided for your safety. If the provided plug does not fit your outlet, consult an electrician for replacement of the obsolete outlet.

Protect the power cord from being walked on or pinched particularly at plugs, convenience receptacles, and the point where they exit from the apparatus.

Use only with the cart stand, tripod bracket, or table specified by the manufacture, or sold with the apparatus. When a cart is used, use caution when moving the cart/apparatus combination to avoid injury from tip-over.



Refer all servicing to qualified service personnel. Servicing is required when the apparatus has been damaged in any way, such as power-supply cord or plug is damaged, liquid has been spilled or objects have fallen into the apparatus, the apparatus has been exposed to rain or moisture, does not operate normally, or has been dropped.

**POWER ON/OFF SWITCH:** The Power switch used in this piece of equipment DOES NOT break the connection from the mains.

**MAINS DISCONNECT:** The plug shall remain readily operable. For rack-mount or installation where plug is not accessible, an all-pole mains switch with a contact separation of at least 3 mm in each pole shall be incorporated into the electrical installation of the rack or building.

If connected to 240V supply, a suitable CSA/UL certified power cord shall be used for this supply.

# IMPORTANT SAFETY INSTRUCTIONS

## ELECTROMAGNETIC COMPATIBILITY

This device complies with part 15 of the FCC Rules and the Product Specifications noted on the **Declaration of Conformity**. Operation is subject to the following two conditions:

- this device may not cause harmful interference, and
- this device must accept any interference received, including interference that may cause undesired operation.

Operation of this unit within significant electromagnetic fields should be avoided.

- use only shielded interconnecting cables.

## SAFETY INSTRUCTIONS

NOTICE FOR CUSTOMERS IF YOUR UNIT IS EQUIPPED WITH A POWER CORD.

WARNING: THIS APPLIANCE SHALL BE CONNECTED TO A MAINS SOCKET OUTLET WITH A PROTECTIVE EARTHING CONNECTION.

THE CORES IN THE MAINS LEAD ARE COLOURED IN ACCORDANCE WITH THE FOLLOWING CODE:

**GREEN AND YELLOW - EARTH    BLUE - NEUTRAL    BROWN - LIVE**

AS COLOURS OF THE CORES IN THE MAINS LEAD OF THIS APPLIANCE MAY NOT CORRESPOND WITH THE COLOURED MARKINGS IDENTIFYING THE TERMINALS IN YOUR PLUG, PROCEED AS FOLLOWS:

- THE CORE WHICH IS COLOURED GREEN AND YELLOW MUST BE CONNECTED TO THE TERMINAL IN THE PLUG MARKED WITH THE LETTER E, OR WITH THE EARTH SYMBOL, OR COLOURED GREEN, OR GREEN AND YELLOW.
- THE CORE WHICH IS COLOURED BLUE MUST BE CONNECTED TO THE TERMINAL MARKED N OR COLOURED BLACK.
- THE CORE WHICH IS COLOURED BROWN MUST BE CONNECTED TO THE TERMINAL MARKED L OR COLOURED RED.

THIS EQUIPMENT MAY REQUIRE THE USE OF A DIFFERENT LINE CORD, ATTACHMENT PLUG, OR BOTH, DEPENDING ON THE AVAILABLE POWER SOURCE AT INSTALLATION. IF THE ATTACHMENT PLUG NEEDS TO BE CHANGED, REFER SERVICING TO QUALIFIED SERVICE PERSONNEL WHO SHOULD REFER TO THE TABLE BELOW. THE GREEN/YELLOW WIRE SHALL BE CONNECTED DIRECTLY TO THE UNITS CHASSIS.

CONDUCTOR		WIRE COLOR	
		Normal	Alt
L	LIVE	BROWN	BLACK
N	NEUTRAL	BLUE	WHITE
E	EARTH GND	GREEN/YEL	GREEN

**WARNING:** IF THE GROUND IS DEFEATED, CERTAIN FAULT CONDITIONS IN THE UNIT OR IN THE SYSTEM TO WHICH IT IS CONNECTED CAN RESULT IN FULL LINE VOLTAGE BETWEEN CHASSIS AND EARTH GROUND. SEVERE INJURY OR DEATH CAN THEN RESULT IF THE CHASSIS AND EARTH GROUND ARE TOUCHED SIMULTANEOUSLY.

## DECLARATION OF CONFORMITY

Manufacturer's Name: DigiTech  
Manufacturer's Address: 8760 S. Sandy Parkway  
Sandy, Utah 84070, USA

declares that the product:

Product name: JamMan Express XT

Product option: all (requires Class II power adapter that conforms to the requirements of EN60065, EN60742, or equivalent.)

conforms to the following Product Specifications:

Safety: IEC 60065 -01+Amd 1

EMC: EN 55022:2006  
EN 55024:1998  
FCC Part 15

Supplementary Information:

The product herewith complies with the requirements of the:  
Low Voltage Directive 2006/95/EC  
EMC Directive 2004/108/EC.  
RoHS Directive 2011/65/EC  
WEEE Directive 2002/96/EC  
EC Regulation 278/2009

With regard to Directive 2005/32/EC and EC Regulation 1275/2008 of 17 December 2008, this product is designed, produced, and classified as Professional Audio Equipment and thus is exempt from this Directive.

Rex C. Reed  
Director, Engineering  
Signal Processing  
8760 S. Sandy Parkway  
Sandy, Utah 84070, USA  
Date: July 19, 2013

European Contact: Your local DigiTech Sales and Service Office or

Harman Signal Processing  
8760 South Sandy Parkway  
Sandy, Utah  
84070 USA  
Ph: (801) 566-8800  
Fax: (801) 568-7583

# Warranty

We at **DigiTech®** are very proud of our products and back-up each one we sell with the following warranty:

1. Please register online at [digitech.com](http://digitech.com) within ten days of purchase to validate this warranty. This warranty is valid only in the United States.
2. DigiTech warrants this product, when purchased new from an authorized U.S. DigiTech dealer and used solely within the U.S., to be free from defects in materials and workmanship under normal use and service. This warranty is valid to the original purchaser only and is non-transferable.
3. DigiTech liability under this warranty is limited to repairing or replacing defective materials that show evidence of defect, provided the product is returned to DigiTech WITH RETURN AUTHORIZATION, where all parts and labor will be covered up to a period of one year (this warranty is extended to a period of six years when the product has been properly registered through our website). A Return Authorization number may be obtained from DigiTech by telephone. The company shall not be liable for any consequential damage as a result of the product's use in any circuit or assembly.
4. Proof-of-purchase is considered to be the responsibility of the consumer. A copy of the original purchase receipt must be provided for any warranty service.
5. DigiTech reserves the right to make changes in design, or make additions to, or improvements upon this product without incurring any obligation to install the same on products previously manufactured.
6. The consumer forfeits the benefits of this warranty if the product's main assembly is opened and tampered with by anyone other than a certified DigiTech technician or, if the product is used with AC voltages outside of the range suggested by the manufacturer.
7. The foregoing is in lieu of all other warranties, expressed or implied, and DigiTech neither assumes nor authorizes any person to assume any obligation or liability in connection with the sale of this product. In no event shall DigiTech or its dealers be liable for special or consequential damages or from any delay in the performance of this warranty due to causes beyond their control.

**NOTE:** The information contained in this manual is subject to change at any time without notification. Some information contained in this manual may also be inaccurate due to undocumented changes in the product since this version of the manual was completed. The information contained in this version of the owner's manual supersedes all previous versions.

## Service Contact Info

If you require technical support, contact DigiTech Technical Support. Be prepared to accurately describe the problem. Know the serial number of your device - this is printed on a sticker attached to the chassis. If you have not already taken the time to register your product, please do so now at [digitech.com](http://digitech.com).

Before you return a product to the factory for service, we recommend you refer to the manual. Make sure you have correctly followed installation steps and operation procedures. For further technical assistance or service, please visit our support page at [digitech.com/en-US/support](http://digitech.com/en-US/support). If you need to return a product to the factory for service, you **MUST** first contact Technical Support to obtain a Return Authorization Number.

No returned products will be accepted at the factory without a Return Authorization Number.

Please refer to the Warranty information, which extends to the first end-user. After expiration of the warranty, a reasonable charge will be made for parts, labor, and packing if you choose to use the factory service facility. In all cases, you are responsible for transportation charges to the factory. DigiTech will pay return shipping if the unit is still under warranty.

Use the original packing material if it is available. Mark the package with the name of the shipper and with these words in red: DELICATE INSTRUMENT, FRAGILE! Insure the package properly. Ship prepaid, not collect. Do not ship parcel post.

# Table of Contents

<b>Overview .....</b>	<b>1</b>
Introduction .....	1
Features.....	1
Package Contents .....	1
<b>The User Interface &amp; Connectors .....</b>	<b>2</b>
The User Interface .....	2
Connectors .....	3
<b>Connection Diagrams .....</b>	<b>4</b>
Standard Looping.....	4
Multi-Track Looping Using JamSync.....	4
Multi-Player/Multi-Track Looping Using JamSync .....	5
<b>Operation .....</b>	<b>6</b>
Recording a Phrase.....	6
Clearing a Phrase .....	6
Recording Overdubs .....	7
Undoing/Redoing Overdubs.....	7
Using JamSync.....	8
<b>Specifications .....</b>	<b>11</b>



# Overview

## Introduction

The JamMan Express XT is a versatile, yet simple to operate stereo looper. With stereo inputs/outputs, three LEDs to indicate looping status, and true bypass operation, the JamMan Express XT allows you to record mono or stereo loops with ease and without compromising your tone when bypassed.

Using the built-in JamSync feature, multiple JamMan Express XT devices can be synchronized to provide multi-track looping capabilities! Cascade two or more JamMan Express XTs for multi-track looping in your own rig or sync with your bandmates' JamSync compatible JamMan devices for multi-track looping with other members in the band!

With a small footprint, simplicity of operation, great sound quality, 10 minutes of stereo loop recording time, and JamSync, the JamMan Express XT is sure to be the perfect looper to compliment your rig. Thanks for choosing DigiTech®.

## Features

- Stereo 1/4" Inputs & Outputs
- 10 Minutes of Loop Recording Time
- True Bypass Operation
- JamSync for Multi-Track Looping
- Silent Clear™ Prevents Playback When Clearing Loops
- Intuitive User Interface
- 9V Battery Included
- Compatible w/Optional PS0913DC Power Supply

## Package Contents

- JamMan Express XT Stereo Looper
- 9V Battery
- Quick Start Guide
- Safety Instruction Sheet

# The User Interface & Connectors















## The User Interface

### 1. LOOP LEVEL Knob

This knob controls the output level of the loop.

### 2. Status LEDs

These LEDs indicate the status of the pedal as shown in the below table.

LED	Status
 REC	Loop is being recorded.
 PLAY	Loop is playing.
 DUB	Overdub is being recorded.
 DUB	Overdub is being undone/redone.
 REC  DUB  PLAY	Pedal is in standby (recording/playback stopped).
 REC	Loop is being cleared (footswitch held). Slave armed for record (connected as slave via JamSync).
 REC  DUB  PLAY	Slave synchronization established via JamSync.
 REC  DUB  PLAY	Low battery.

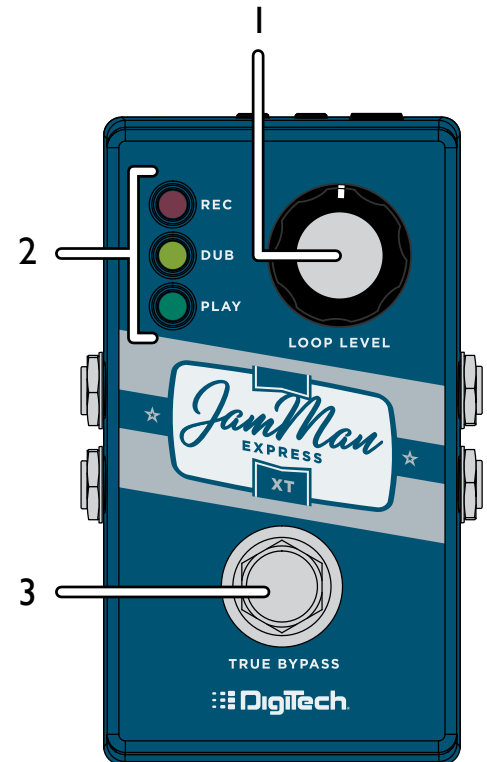

### 3. Footswitch

The Footswitch is used to perform functions in the JamMan Express XT. It is used to control all looping functions (record, play, overdub, undo/redo, stop, and loop clear).



## Connectors

### 4. Power Jack

Connect an optional PS0913DC power supply to this jack.

### 5. JAMSYNC OUT

Connect this jack to the JAMSYNC IN jack on another JAMSYNC compatible device for master control over loop playback and stop functions.

### 6. JAMSYNC IN

Connect this jack to the JAMSYNC OUT jack on another JAMSYNC compatible device to slave loop playback and stop functions to a master device.

### 7. LEFT IN (Mono)

Connect your instrument or additional pedal to this jack. The signal is fed to both outputs when only the LEFT IN (Mono) jack is used.

### 8. RIGHT IN

Connect a second input to this jack for stereo operation. LEFT and RIGHT inputs are processed separately through the looper engine and then fed to the LEFT and RIGHT outputs to maintain true stereo separation between channels.

### 9. LEFT OUT (Mono)

Connect this output to the input of a single guitar amplifier or another pedal input.

### 10. RIGHT OUT

Connect this output to the input of a second guitar amplifier when a second amp is being used.

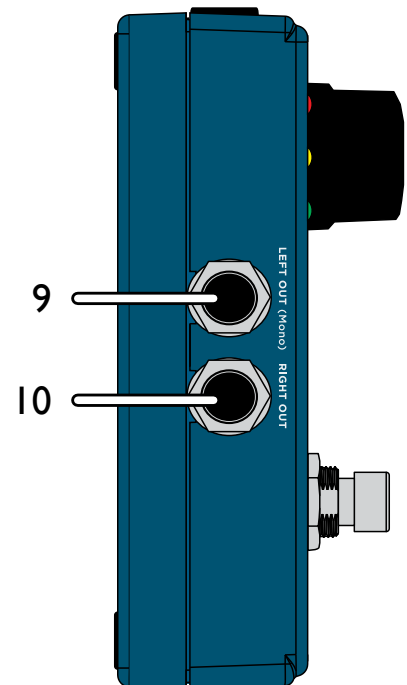
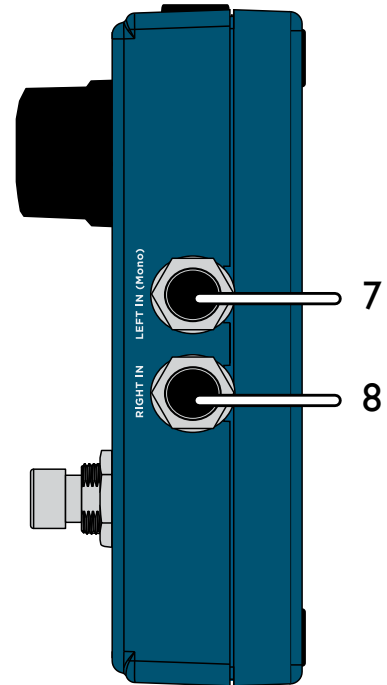
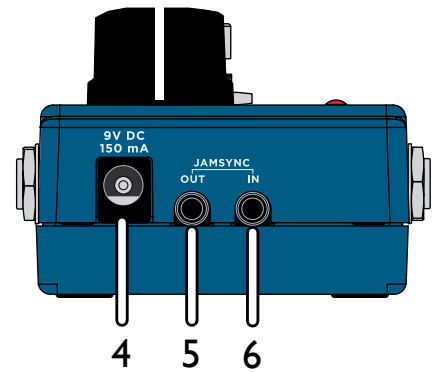

# Connection Diagrams

## Standard Looping

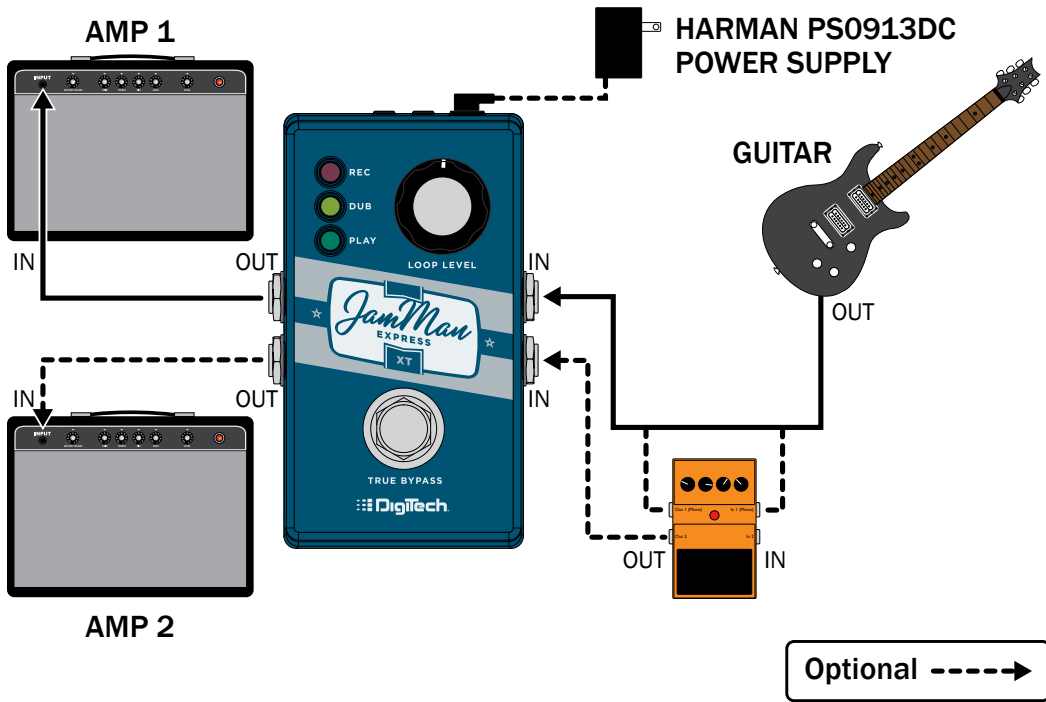

## Multi-Track Looping Using JamSync

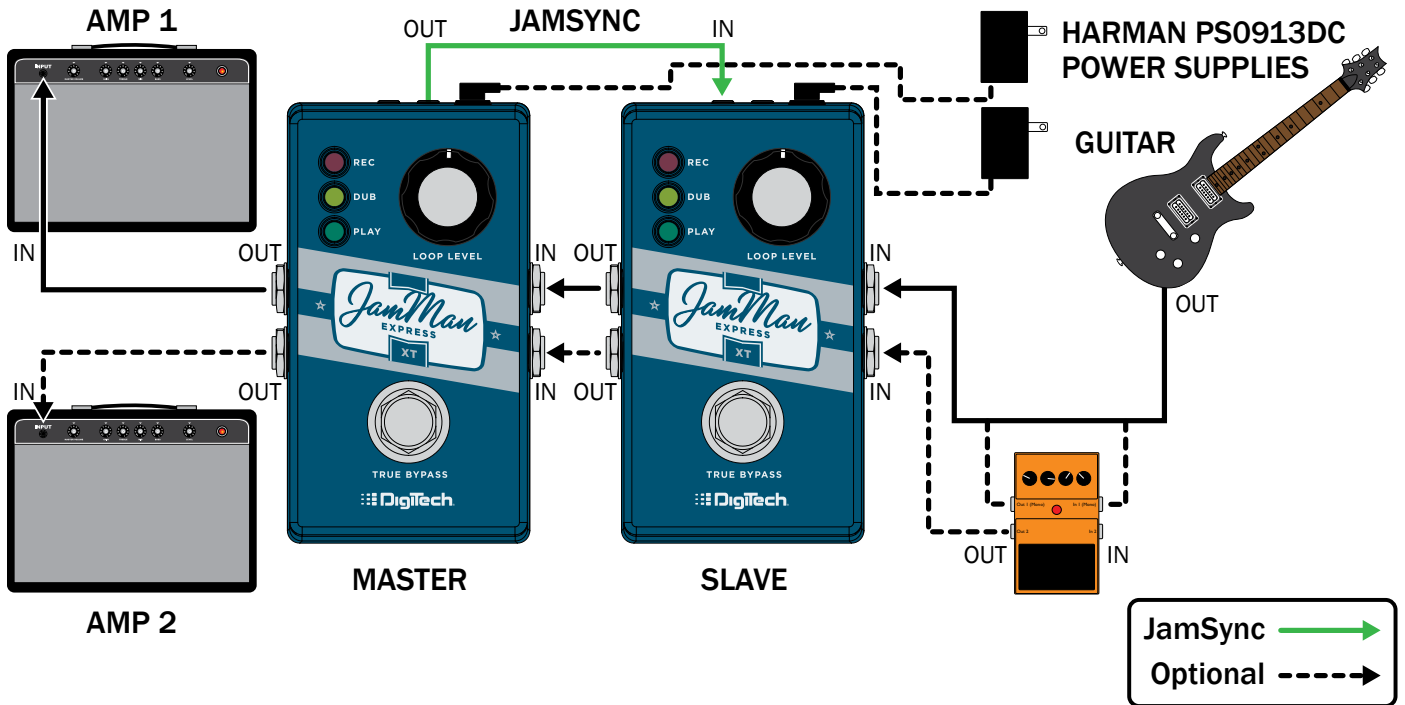

# Multi-Player/Multi-Track Looping Using JamSync

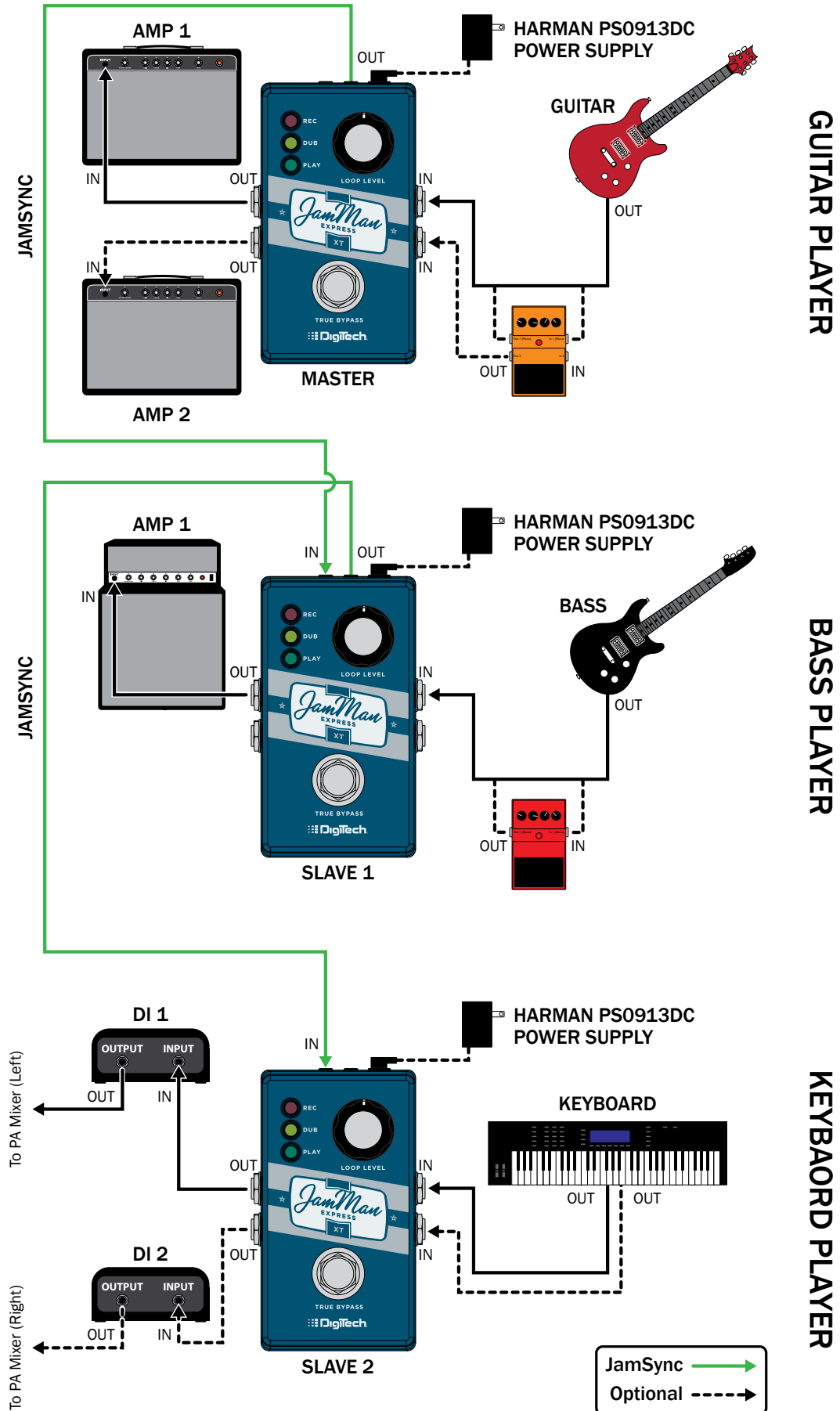

GUITAR PLAYER

BASS PLAYER

KEYBOARD PLAYER

# Operation

The JamMan Express XT was designed to be very simple to use right out of the box. This section of the manual describes how to perform the basic looping functions.

## Recording a Phrase

The JamMan Express XT records a single phrase and then plays it back as a continuous loop.

### To record a phrase:

1. Press the **FOOTSWITCH** and begin playing to start recording. The **REC LED** will light solid red and recording will begin.
2. When finished recording, press the **FOOTSWITCH** once to set the loop end point. The phrase will automatically begin playing back in a repeating loop and the **PLAY LED** will light solid green.
3. Press the **FOOTSWITCH** 2 times quickly to stop loop playback.

**NOTE:** The maximum phrase recording length is 10 minutes.

## Clearing a Phrase

Clear a phrase to re-record it or record a new phrase. The JamMan Express XT has a unique feature, referred to as "Silent Clear™", which clears a phrase without requiring you to play it first. Note that you cannot undo the process of clearing a phrase, so make sure you want to proceed before performing this function.

### To clear a recorded phrase:

1. Stop loop playback if it is not already (all LEDs should be off). If loop playback is active (the **PLAY LED** is on), press the **FOOTSWITCH** 2 times to stop loop playback.
2. Press and hold the **FOOTSWITCH** for ~2 seconds. The **REC LED** will quickly flash red, indicating the phrase has been cleared.

**NOTE:** When using a slave/master looper setup, if the master loop is ~3 seconds or less and if pressing and holding the **FOOTSWITCH** from a stopped state does not initiate clear on the slave device, you may need to initiate play then stop (3 **FOOTSWITCH** presses) and hold the footswitch on the 3rd press to clear its loop.

## Recording Overdubs

Once a phrase has been recorded, overdubs can be added on top of the phrase.

### To record overdubs:

1. Press the **FOOTSWITCH** to start loop playback. The **PLAY LED** will light solid green and the phrase will begin playing.
2. Press the **FOOTSWITCH** again to begin overdub recording. The **DUB LED** will light solid yellow and audio will be recorded on top of the phrase.
3. When done overdub recording, press the **FOOTSWITCH** to end the overdub recording session. The loop will continue playing along with the newly recorded overdub.
4. You can now decide whether you would like to undo the last overdub and re-record it (see "*Undoing/Redoing Overdubs*" in the following section) or proceed and record additional overdubs by repeating steps 2-3.
5. Press the **FOOTSWITCH** 2 times quickly to stop loop playback.

## Undoing/Redoing Overdubs

When recording overdubs, you can choose to undo the last overdub recorded if you wish to re-record it. If you change your mind or accidentally undo an overdub, you can then redo the overdub to retrieve it.

### To undo/redo an overdub:

1. Record an overdub as described in the previous section, "*Recording Overdubs*".
2. Ensure the loop is playing (the **PLAY LED** should be on). If the loop is not playing, press the **FOOTSWITCH** 1 time to initiate loop playback. Once the loop is playing, press and hold the **FOOTSWITCH** for ~2 seconds. The **DUB LED** will quickly flash yellow, indicating the overdub has been undone.
3. If you wish to restore the overdub, press and hold the **FOOTSWITCH** again for ~2 seconds to redo the overdub. The **DUB LED** will quickly flash yellow, indicating the overdub has been redone.

**NOTE:** Each time an overdub is added, the last overdub is merged with the original loop and can no longer be undone using the Undo feature. If the combined loop and overdub length exceed 10 minutes (e.g., a 6 minute loop and 6 minute overdub, etc.), the two will automatically be merged and the overdub cannot be undone. Overdubs added to a recorded loop of 5 minutes or less will not be automatically merged.

# Using JamSync

## Connection & Record Sequence

JamSync allows you to synchronize multiple JamSync compatible devices using optional 1/8" mini stereo (TRS) cables (see below cable diagram). This allows a JamSync master to control the loop playback and stop functions for all connected JamSync slaves, providing multi-track looping capabilities. You can cascade multiple JamMan Express XTs for single-player/multi-track looping or collaborate with other musicians, each recording and cueing their own loops for expressive multi-player/multi-track looping.

1/8" Mini Stereo (TRS) Cable Diagram

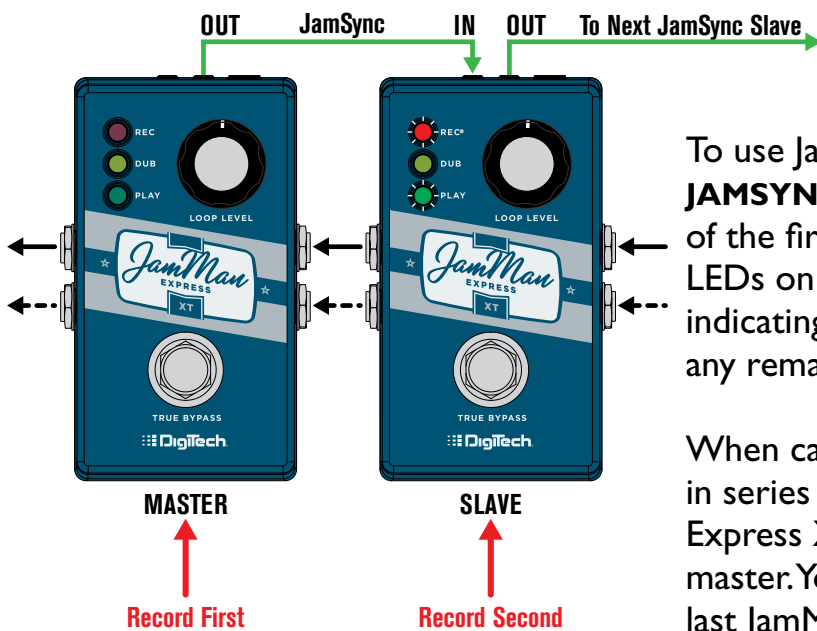
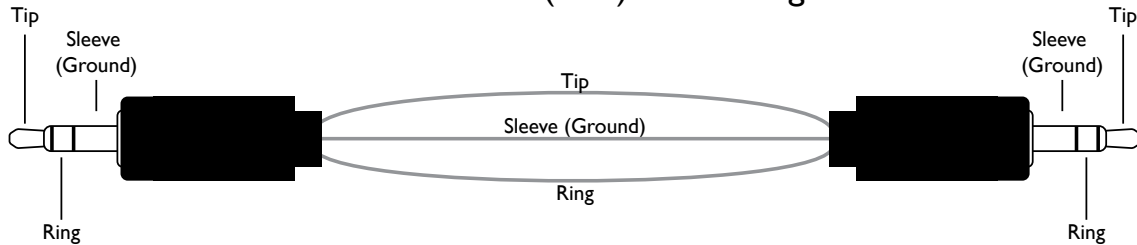

To use JamSync, connect the master device's **JAMSYNC OUT** jack to the **JAMSYNC IN** jack of the first slave device. The **REC** and **PLAY** LEDs on the slaved device will briefly flash, indicating the unit is in slave mode. Daisy chain any remaining slaves in the same manner.

When cascading multiple JamMan Express XTs in series and using JamSync, the last JamMan Express XT device in the chain should be the master. You will then want to record to the last JamMan Express XT device in the signal chain (the master) first, then the second to last device, etc., working your way backwards through the signal chain. Performing these actions will ensure you record only what you intend to during each pass.

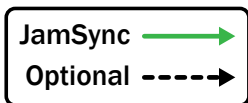

There are two methods for recording loops to a JamSync slaved JamMan device:

- **Manual Slave Recording Method**

Using this method, you can record to the master then wait until you're ready to record to the slave. This method works well if you do not wish to immediately

record to the slave and instead wish to record to the slave at a later time in the song. When using this method, you must arm the slave to record before the master device reaches its loop start point. It's at this loop start point that the master will send the record command to the slave device(s), so the slave device must be armed in advance to receive the record command.

- **Sequential Slave Recording Method**

Using this method, you can record to a JamSync slave immediately upon setting the loop end point of the master. Use this method when you want to immediately begin recording to the slave device after recording to the master device.

**To record using the Manual Slave Recording Method:**

1. Press the **FOOTSWITCH** on the master device and begin playing. The **REC LED** will light solid red and recording will begin.
2. When finished recording to the master, press the **FOOTSWITCH** once to set the loop end point. The phrase will automatically begin playing back in a repeating loop and the **PLAY LED** will light solid green.
3. Press the **FOOTSWITCH** on the slave device to arm the slave for recording. Recording will begin once the master makes another pass of its loop start point (the **REC LED** will light solid red on the slave device when recording begins ). Once recording has begun, play your part.
4. When finished recording to the slave, press the slave's **FOOTSWITCH** once to set the loop end point. The phrase will automatically begin playing back along with the master loop and the **PLAY LED** will light solid green.
5. Press the **FOOTSWITCH** on the master device 2 times quickly to stop loop playback on both devices.

**To record using the Sequential Slave Recording Method:**

1. Press the **FOOTSWITCH** on the slave device. The **REC LED** will flash red, indicating the slave is armed for recording.
2. Press the **FOOTSWITCH** on the master device and begin playing. The **REC LED** will light solid red and recording on the master will begin.
3. When finished recording to the master, press the master **FOOTSWITCH** once to set the loop end point. The master device's recorded phrase will begin playing back and the armed slave device will immediately begin recording, indicated by the slave's **REC LED** lighting solid red.

4. Play your part.
5. When finished recording to the slave, press the slave's **FOOTSWITCH** once to set the loop end point. The phrase will automatically begin playing back along with the master loop and the **PLAY LED** will light solid green.
6. Press the **FOOTSWITCH** on the master device 2 times quickly to stop loop playback on both devices.



# Specifications

## DIGITAL

A/D/A Conversion: 24-bit  
Max. Individual Loop Time: 10 minutes (stereo)

## LEFT(MONO)/RIGHT INPUTS

Connector Type: ¼" Unbalanced (Tip-Sleeve)  
Input Impedance: 550 kΩ Mono/1.1 MΩ Stereo  
Unity Gain Input to Output: Loop Level knob set to 12 o'clock position  
Max Input Level at Unity: +4 dBu DFS  
Left and Right Audio Paths: Each channel maintains analog dry path

## LEFT(MONO)/RIGHT OUTPUTS

Connector Type: ¼" Unbalanced (Tip-Sleeve)/Balanced (Tip-Ring-Sleeve)  
Output Impedance: 100 Ω Unbalanced / 200 Ω Balanced  
Playback Unity Gain: Loop Level knob set to 12 o'clock position  
Maximum Output Level: +4 dBu DFS

## PERFORMANCE

Frequency Response: +0/-3 dB 20-20 kHz  
Signal to Noise Ratio: > -100 dB

## POWER REQUIREMENTS

Consumption: < 2 Watts  
Current Draw: < 150 mA  
Battery Life: Approximately 2 hours of operation using 9V battery

## POWER ADAPTER

Model: PS0913DC-01  
Input: 100 VAC-240 VAC, 50/60 Hz  
Output: 9 VDC 1.3 A  
Polarity: 

## DIMENSIONS/WEIGHT

Dimensions: 4.4" (L) x 2.5" (W) x 2.3" (H)  
112 mm (L) x 65 mm (W) x 33 mm (H)  
Product Weight: 0.6 lb / 0.27 kg  
Shipping Weight: 0.7 lb / 0.32kg

Product specifications are subject to change without notice. DigiTech, Silent Clear, and JamSync are trademarks of Harman.



DigiTech  
8760 South Sandy Parkway  
Sandy, Utah 84070

WEB: [digitech.com](http://digitech.com)

SUPPORT: [digitech.com/en-US/support](http://digitech.com/en-US/support)

JamMan Express XT Owner's Manual 5038282-A

DigiTech is a registered trademark of Harman.

©2013 Harman, all rights reserved.

