

# JUNO-STAGE

Owner's Manual

Roland®

## Conventions Used in This Manual

Operating buttons are enclosed by square brackets [ ]; e.g., [ENTER].

Reference pages are indicated by (p. \*\*).

The following symbols are used.

**NOTE**

This indicates an important note; be sure to read it.

**MEMO**

This indicates a memo regarding the setting or function; read it as desired.

**TIP**

This indicates a useful hint for operation; read it as necessary.

**cf.**

This indicates information for your reference; read it as necessary.

**TERM**

This indicates an explanation of a term; read it as necessary.

Before using this unit, carefully read the sections entitled: "USING THE UNIT SAFELY" and "IMPORTANT NOTES" (p. 3; p. 5). These sections provide important information concerning the proper operation of the unit. Additionally, in order to feel assured that you have gained a good grasp of every feature provided by your new unit, Owner's manual should be read in its entirety. The manual should be saved and kept on hand as a convenient reference.

Copyright © 2008 ROLAND CORPORATION

All rights reserved. No part of this publication may be reproduced in any form without the written permission of ROLAND CORPORATION.

# USING THE UNIT SAFELY

## INSTRUCTIONS FOR THE PREVENTION OF FIRE, ELECTRIC SHOCK, OR INJURY TO PERSONS

### About ⚠ WARNING and ⚠ CAUTION Notices

<b>⚠ WARNING</b>	Used for instructions intended to alert the user to the risk of death or severe injury should the unit be used improperly.
<b>⚠ CAUTION</b>	Used for instructions intended to alert the user to the risk of injury or material damage should the unit be used improperly. * Material damage refers to damage or other adverse effects caused with respect to the home and all its furnishings, as well to domestic animals or pets.

### About the Symbols

	The ⚠ symbol alerts the user to important instructions or warnings. The specific meaning of the symbol is determined by the design contained within the triangle. In the case of the symbol at left, it is used for general cautions, warnings, or alerts to danger.
	The ⚡ symbol alerts the user to items that must never be carried out (are forbidden). The specific thing that must not be done is indicated by the design contained within the circle. In the case of the symbol at left, it means that the unit must never be disassembled.
	The ● symbol alerts the user to things that must be carried out. The specific thing that must be done is indicated by the design contained within the circle. In the case of the symbol at left, it means that the power-cord plug must be unplugged from the outlet.

## ALWAYS OBSERVE THE FOLLOWING

### ⚠ WARNING

- Do not open or perform any internal modifications on the unit or its AC adaptor. (The only exception would be where this manual provides specific instructions which should be followed in order to put in place user-installable options; see p. 18.)
- Do not attempt to repair the unit, or replace parts within it (except when this manual provides specific instructions directing you to do so). Refer all servicing to your retailer, the nearest Roland Service Center, or an authorized Roland distributor, as listed on the "Information" page.
- Never use or store the unit in places that are:
  - Subject to temperature extremes (e.g., direct sunlight in an enclosed vehicle, near a heating duct, on top of heat-generating equipment); or are
  - Damp (e.g., baths, washrooms, on wet floors); or are
  - Humid; or are
  - Exposed to rain; or are
  - Dusty; or are
  - Subject to high levels of vibration.
- This unit should be used only with a rack or stand that is recommended by Roland.
- When using the unit with a rack or stand recommended by Roland, the rack or stand must be carefully placed so it is level and sure to remain stable. If not using a rack or stand, you still need to make sure that any location you choose for placing the unit provides a level surface that will properly support the unit, and keep it from wobbling.

### ⚠ WARNING

- Be sure to use only the AC adaptor supplied with the unit. Also, make sure the line voltage at the installation matches the input voltage specified on the AC adaptor's body. Other AC adaptors may use a different polarity, or be designed for a different voltage, so their use could result in damage, malfunction, or electric shock.
- Use only the attached power-supply cord. Also, the supplied power cord must not be used with any other device.
- Do not excessively twist or bend the power cord, nor place heavy objects on it. Doing so can damage the cord, producing severed elements and short circuits. Damaged cords are fire and shock hazards!
- This unit, either alone or in combination with an amplifier and headphones or speakers, may be capable of producing sound levels that could cause permanent hearing loss. Do not operate for a long period of time at a high volume level, or at a level that is uncomfortable. If you experience any hearing loss or ringing in the ears, you should immediately stop using the unit, and consult an audiologist.
- Do not allow any objects (e.g., flammable material, coins, pins); or liquids of any kind (water, soft drinks, etc.) to penetrate the unit.

**⚠ WARNING**

- Immediately turn the power off, remove the AC adaptor from the outlet, and request servicing by your retailer, the nearest Roland Service Center, or an authorized Roland distributor, as listed on the "Information" page when:
  - The AC adaptor, the power-supply cord, or the plug has been damaged; or
  - If smoke or unusual odor occurs; or
  - Objects have fallen into, or liquid has been spilled onto the unit; or
  - The unit has been exposed to rain (or otherwise has become wet); or
  - The unit does not appear to operate normally or exhibits a marked change in performance.
- In households with small children, an adult should provide supervision until the child is capable of following all the rules essential for the safe operation of the unit.
- Protect the unit from strong impact. (Do not drop it!)
- Do not force the unit's power-supply cord to share an outlet with an unreasonable number of other devices. Be especially careful when using extension cords—the total power used by all devices you have connected to the extension cord's outlet must never exceed the power rating (watts/ amperes) for the extension cord. Excessive loads can cause the insulation on the cord to heat up and eventually melt through.
- Before using the unit in a foreign country, consult with your retailer, the nearest Roland Service Center, or an authorized Roland distributor, as listed on the "Information" page.
- Always turn the unit off and unplug the AC adaptor before attempting installation of the circuit board (model no. SRX series; p. 18).
- DO NOT play a CD-ROM disc on a conventional audio CD player. The resulting sound may be of a level that could cause permanent hearing loss. Damage to speakers or other system components may result.

**⚠ CAUTION**

- The unit and the AC adaptor should be located so their location or position does not interfere with their proper ventilation.
- This (JUNO-STAGE) for use only with Roland stand KS-12. Use with other stands is capable of resulting in instability causing possible injury.

**⚠ CAUTION**

- Always grasp only the plug on the AC adaptor cord when plugging into, or unplugging from, an outlet or this unit.
- At regular intervals, you should unplug the AC adaptor and clean it by using a dry cloth to wipe all dust and other accumulations away from its prongs. Also, disconnect the power plug from the power outlet whenever the unit is to remain unused for an extended period of time. Any accumulation of dust between the power plug and the power outlet can result in poor insulation and lead to fire.
- Try to prevent cords and cables from becoming entangled. Also, all cords and cables should be placed so they are out of the reach of children.
- Never climb on top of, nor place heavy objects on the unit.
- Never handle the AC adaptor or its plugs with wet hands when plugging into, or unplugging from, an outlet or this unit.
- Before moving the unit, disconnect the AC adaptor and all cords coming from external devices.
- Before cleaning the unit, turn off the power and unplug the AC adaptor from the outlet (p. 22).
- Whenever you suspect the possibility of lightning in your area, disconnect the AC adaptor from the outlet.
- Install only the specified circuit board(s) (model no. SRX series). Remove only the specified screws (p. 18).
- Keep any screws you may remove and the included hexagon wrench in a safe place out of children's reach, so there is no chance of them being swallowed accidentally.
- Always turn the phantom power off when connecting any device other than condenser microphones that require phantom power. You risk causing damage if you mistakenly supply phantom power to dynamic microphones, audio playback devices, or other devices that don't require such power. Be sure to check the specifications of any microphone you intend to use by referring to the manual that came with it.

(This instrument's phantom power: 48V DC, 10 mA Max)



# IMPORTANT NOTES

## Power Supply

- Do not connect this unit to same electrical outlet that is being used by an electrical appliance that is controlled by an inverter (such as a refrigerator, washing machine, microwave oven, or air conditioner), or that contains a motor. Depending on the way in which the electrical appliance is used, power supply noise may cause this unit to malfunction or may produce audible noise. If it is not practical to use a separate electrical outlet, connect a power supply noise filter between this unit and the electrical outlet.
- The AC adaptor will begin to generate heat after long hours of consecutive use. This is normal, and is not a cause for concern.
- Before connecting this unit to other devices, turn off the power to all units. This will help prevent malfunctions and/or damage to speakers or other devices.

## Placement

- Using the unit near power amplifiers (or other equipment containing large power transformers) may induce hum. To alleviate the problem, change the orientation of this unit; or move it farther away from the source of interference.
- This device may interfere with radio and television reception. Do not use this device in the vicinity of such receivers.
- Noise may be produced if wireless communications devices, such as cell phones, are operated in the vicinity of this unit. Such noise could occur when receiving or initiating a call, or while conversing. Should you experience such problems, you should relocate such wireless devices so they are at a greater distance from this unit, or switch them off.
- Do not expose the unit to direct sunlight, place it near devices that radiate heat, leave it inside an enclosed vehicle, or otherwise subject it to temperature extremes. Excessive heat can deform or discolor the unit.
- When moved from one location to another where the temperature and/or humidity is very different, water droplets (condensation) may form inside the unit. Damage or malfunction may result if you attempt to use the unit in this condition. Therefore, before using the unit, you must allow it to stand for several hours, until the condensation has completely evaporated.
- Do not allow objects to remain on top of the keyboard. This can be the cause of malfunction, such as keys ceasing to produce sound.
- Depending on the material and temperature of the surface on which you place the unit, its rubber feet may discolor or mar the surface. You can place a piece of felt or cloth under the rubber feet to prevent this from happening. If you do so, please make sure that the unit will not slip or move accidentally.

## Maintenance

- For everyday cleaning wipe the unit with a soft, dry cloth or one that has been slightly dampened with water. To remove stubborn dirt, use a cloth impregnated with a mild, non-abrasive detergent. Afterwards, be sure to wipe the unit thoroughly with a soft, dry cloth.
- Never use benzine, thinners, alcohol or solvents of any kind, to avoid the possibility of discoloration and/or deformation.

## Repairs and Data

- Please be aware that all data contained in the unit's memory may be lost when the unit is sent for repairs. Important data should always be backed up on a USB memory, or written down on paper (when possible). During repairs, due care is taken to avoid the loss of data. However, in certain cases (such as when circuitry related to memory itself is out of order), we regret that it may not be possible to restore the data, and Roland assumes no liability concerning such loss of data.

## Additional Precautions

- Please be aware that the contents of memory can be irretrievably lost as a result of a malfunction, or the improper operation of the unit. To protect yourself against the risk of losing important data, we recommend that you periodically save a backup copy of important data you have stored in the unit's memory on a USB memory.
- Unfortunately, it may be impossible to restore the contents of data that was stored in the unit's memory or on a USB memory once it has been lost. Roland Corporation assumes no liability concerning such loss of data.
- Use a reasonable amount of care when using the unit's buttons, sliders, or other controls; and when using its jacks and connectors. Rough handling can lead to malfunctions.
- Never strike or apply strong pressure to the display.
- A small amount of noise may be heard from the display during normal operation.
- When connecting / disconnecting all cables, grasp the connector itself—never pull on the cable. This way you will avoid causing shorts, or damage to the cable's internal elements.
- To avoid disturbing your neighbors, try to keep the unit's volume at reasonable levels. You may prefer to use headphones, so you do not need to be concerned about those around you (especially when it is late at night).
- When you need to transport the unit, package it in the box (including padding) that it came in, if possible. Otherwise, you will need to use equivalent packaging materials.

## IMPORTANT NOTES

- Use only the specified expression pedal (EV-5; sold separately). By connecting any other expression pedals, you risk causing malfunction and/or damage to the unit.
- Some connection cables contain resistors. Do not use cables that incorporate resistors for connecting to this unit. The use of such cables can cause the sound level to be extremely low, or impossible to hear. For information on cable specifications, contact the manufacturer of the cable.
- Unauthorized duplication, reproduction, hiring, and lending prohibited.
- The usable range of D Beam controller will become extremely small when used under strong direct sunlight. Please be aware of this when using the D Beam controller outside.
- The sensitivity of the D Beam controller will change depending on the amount of light in the vicinity of the unit. If it does not function as you expect, adjust the sensitivity as appropriate for the brightness of your location.

## Using USB Memory

- Carefully insert the USB memory all the way in—until it is firmly in place.
- Never touch the terminals of the USB memory. Also, avoid getting the terminals dirty.
- USB memory are constructed using precision components; handle the cards carefully, paying particular note to the following.
  - To prevent damage to the cards from static electricity, be sure to discharge any static electricity from your own body before handling the cards.
  - Do not touch or allow metal to come into contact with the contact portion of the cards.
  - Do not bend, drop, or subject cards to strong shock or vibration.
  - Do not keep cards in direct sunlight, in closed vehicles, or other such locations (storage temperature: -25 to 85° C).
  - Do not allow cards to become wet.
  - Do not disassemble or modify the cards.

## Handling CD-ROMs

- Avoid touching or scratching the shiny underside (encoded surface) of the disc. Damaged or dirty CD-ROM discs may not be read properly. Keep your discs clean using a commercially available CD cleaner.

## Copyright

- Recording, duplication, distribution, sale, lease, performance, or broadcast of copyrighted material (musical works, visual works, broadcasts, live performances, etc.) belonging to a third party in part or in whole without the permission of the copyright owner is forbidden by law.
- Do not use this unit for purposes that could infringe on a copyright held by a third party. We assume no responsibility whatsoever with regard to any infringements of third-party copyrights arising through your use of this unit.
- \* Microsoft and Windows are registered trademarks of Microsoft Corporation.
- \* The screen shots in this document are used in compliance with the guidelines of the Microsoft Corporation.
- \* Windows® is known officially as: "Microsoft® Windows® operating system."
- \* Apple and Macintosh are registered trademarks of Apple Inc.
- \* Mac OS is a trademark of Apple Inc.
- \* IBM and IBM PC are registered trademark of International Business Machines Corporation.
- \* Pentium is a registered trademark of Intel Corporation.
- \* MMX is a trademark of Intel Corporation.
- \* Iomega is a registered trademark of Iomega Corporation.
- \* All product names mentioned in this document are trademarks or registered trademarks of their respective owners.
- \* VST is a trademark of Steinberg Media Technologies AG.
- \* MPEG Layer-3 audio compression technology is licensed from Fraunhofer IIS Corporation and THOMSON Multimedia Corporation.

# Contents

<b>USING THE UNIT SAFELY</b> .....	<b>3</b>
<b>IMPORTANT NOTES</b> .....	<b>5</b>

## **Introduction** **13**

---

<b>Panel Descriptions</b> .....	<b>14</b>
Front Panel .....	14
Rear Panel .....	16
<b>Getting Ready</b> .....	<b>18</b>
<b>Installing a Wave Expansion Board</b> .....	<b>18</b>
Cautions When Installing a Wave Expansion Board .....	18
How to Install a Wave Expansion Board .....	18
Checking the Installed Wave Expansion Board .....	19
<b>Connections</b> .....	<b>19</b>
Connecting the AC Adaptor.....	19
Connecting the External Equipment.....	20
Connecting Pedals.....	21
Connecting a Portable Audio Device.....	21
<b>Turning On/Off the Power</b> .....	<b>22</b>
Turning Off the Power .....	22
<b>Adjusting the Volume Level</b> .....	<b>22</b>
<b>Adjusting the Display Contrast ([LCD CONTRAST] Knob)</b> .....	<b>22</b>
<b>Using the Included USB Memory Protector</b> .....	<b>22</b>

## **Quick Start** **23**

---

<b>Listening to the Demo Songs</b> .....	<b>24</b>
<b>Playing the Keyboard</b> .....	<b>25</b>
Playing in Piano Mode ([PIANO MODE]).....	25
<b>Selecting Sounds</b> .....	<b>28</b>
<b>Selecting Sounds (Patches)</b> .....	<b>28</b>
Playing Various Sounds (Category Group Buttons) .....	28
Selecting Sounds from the List .....	29
Registering and Selecting Frequently Used Sounds (FAVORITE) .....	30
Auditioning the Sounds ([PREVIEW]) .....	30
<b>Playing Multiple Sounds</b> .....	<b>31</b>
Playing Different Sounds in the Left and Right Areas of the Keyboard ([SPLIT]) .....	31
Changing the Split Point .....	32
Playing Layered Sounds ([DUAL]).....	32
<b>Modifying the Sound in Real Time</b> .....	<b>33</b>
Using the Pitch Bend/Modulation Lever to Modify the Sound .....	33
Changing the Pitch in Steps of an Octave (OCTAVE [DOWN] [UP]) .....	33
Changing the Pitch in Semitone Steps ([TRANSPOSE]) .....	34
Using the Knobs to Modify the Sound (SOUND MODIFY) .....	35

# Reference

**37**

<b>Chapter 1. Overview .....</b>	<b>38</b>
<b>How the JUNO-STAGE is Organized .....</b>	<b>38</b>
Basic Structure .....	38
Patch Mode and Performance Mode .....	38
About the Effects .....	40
About Memory .....	41
<b>Basic Operation of the JUNO-STAGE .....</b>	<b>42</b>
Switching the Sound Generator Mode .....	42
About the Function Buttons .....	43
Editing a Value .....	43
Entering a Value ([NUMERIC]) .....	44
Assigning a Name .....	44
<b>Chapter 2. Selecting Sounds .....</b>	<b>45</b>
<b>Selecting Patches .....</b>	<b>45</b>
<b>Selecting Patches in Patch Mode .....</b>	<b>45</b>
Using the VALUE Dial to Select a Patch .....	45
Selecting Patches from the Patch List .....	46
Selecting Patches by Number ([NUMERIC]) .....	46
Using a Pedal to Select Patches (PATCH SELECT Pedal) .....	46
<b>Auditioning a Patch ([PREVIEW]) .....</b>	<b>47</b>
<b>Registering and Calling Up Favorite Patches or Performances (FAVORITE) .....</b>	<b>47</b>
Registering a Favorite Patch or Performance .....	47
Calling Up a Favorite Sound .....	48
Registering, Calling Up, or Editing Favorites in a List .....	48
Switching Favorites with a Single Button ([FAVORITE UP/ASSIGNABLE]) .....	48
Using a Pedal to Select Favorites (PATCH SELECT Pedal) .....	48
<b>Playing the JUNO-STAGE in Performance Mode .....</b>	<b>49</b>
Selecting a Performance .....	49
Selecting a Part .....	50
Selecting a Patch for Each Part .....	50
Playing Layered Sounds (DUAL) .....	51
Dividing the Keyboard into Two Areas to Play Separate Sounds (SPLIT) .....	51
Changing the Split Point .....	51
<b>Chapter 3. Versatile Performance Functions .....</b>	<b>52</b>
<b>Changing the Keyboard Settings .....</b>	<b>52</b>
Changing the Pitch in One-octave Steps (OCTAVE [DOWN] [UP]) .....	52
Transposing the Pitch in Semitone Steps ([TRANSPOSE]) .....	52
Changing the Temperament to an Arabian or Other Scale (Scale Tune) .....	53
Adjusting the Keyboard Touch .....	54
<b>Changing the Pitch in Real Time (Pitch Bend/Modulation Lever) .....</b>	<b>54</b>
<b>Assigning Functions to [S1] [S2] .....</b>	<b>55</b>
Controlling Portamento .....	55
Playing Monophonically .....	55
Simulating a Guitarist's Double-bending .....	55
Switching the Speed of the Organ Rotary Effect .....	55

<b>Using the D Beam Controller to Modify the Sound</b> .....	<b>56</b>
SOLO SYNTH .....	57
ACTIVE EXPRESSION .....	57
ASSIGNABLE .....	57
<b>Using the Knobs to Modify the Sound (SOUND MODIFY)</b> .....	<b>58</b>
Disabling the Knobs ([LOCK]).....	59
<b>Assigning a Function to the Pedal (Control Pedal)</b> .....	<b>59</b>
<b>Playing Arpeggios ([ARPEGGIO])</b> .....	<b>60</b>
About Arpeggio Function.....	60
Playing by Using Arpeggios .....	60
Arpeggio Settings .....	61
Creating an Arpeggio Style .....	62
Saving an Arpeggio Style You've Created (WRITE).....	63
<b>Using the Chord Memory Function ([CHORD MEMORY])</b> .....	<b>64</b>
About the Chord Memory Function .....	64
Performing with the Chord Memory Function.....	64
Creating Your Own Chord Forms .....	65
Saving the Chord Forms You Have Created (WRITE).....	65
<b>Using the V-LINK ([V-LINK])</b> .....	<b>66</b>
What is V-LINK? .....	66
Connection Example .....	66
Turning the V-LINK ON/OFF.....	66
V-LINK Settings (V-LINK SETUP).....	67
 <b>Chapter 4. Using the Song Player</b> .....	 <b>68</b>
<b>Playing Back Music Files (SONG PLAYER)</b> .....	<b>68</b>
SMF/Audio Files That Can Be Played .....	69
Selecting and Playing a Song ([SONG LIST]) .....	69
Selecting and Playing a Playlist .....	71
Changing the Song Order .....	72
Deleting a Song From the Playlist.....	72
Saving the Settings of the Playlist (WRITE).....	73
Performing Along With a Song ([C. CANCEL/MINUS ONE]) .....	73
Connecting a Portable Audio Device (EXT INPUT jack) .....	73
<b>Playing Rhythm Patterns ([RHYTHM PATTERN])</b> .....	<b>74</b>
Playing Rhythm Patterns.....	74
Editing a Rhythm Pattern.....	75
Creating a Rhythm Pattern .....	76
Saving a Rhythm Pattern (WRITE).....	77
Creating a Rhythm Group.....	77
Saving a Rhythm Group You've Created (WRITE) .....	78
<b>Listening to a Click in Time with the Tempo (SONG/CLICK OUT jack)</b> .....	<b>78</b>

**Chapter 5. Applying Effects to the Sound ..... 79**

- Applying Effects ..... 79**
  - How Effects are Handled in Each Mode ..... 79
  - Turning Effects On/Off (Effect Switch) ..... 79
  - Making Effect Settings ..... 79
- Applying Effects in Patch Mode ..... 80**
  - Signal Flow and Parameters (EFFECT ROUTING) ..... 80
- Applying Effects in Performance Mode ..... 82**
  - Signal Flow and Parameters (EFFECT ROUTING) ..... 82
- Multi-Effect Settings (MFX 1–3) ..... 84**
  - Controlling a Multi-Effect via MIDI (MFX 1–3 CTRL) ..... 84
- Specifying How Multi-Effects are Combined (MFX STRUCTURE) ..... 86**
- Chorus Settings (CHORUS) ..... 86**
- Reverb Settings (REVERB) ..... 86**

**Chapter 6. Performing with a Microphone ..... 87**

- Connecting a Mic ..... 87**
  - Adjusting the Volume of the Mic ..... 87
  - Applying Reverb to the Mic ..... 87
  - Using a Condenser Mic ..... 87
  - Using the Vocoder ..... 87

**Chapter 7. Connecting an External MIDI Device ..... 88**

- About MIDI ..... 88**
  - About MIDI Connectors ..... 88
- MIDI Channels and Multitimbral Sound Generators ..... 88**
- Using the JUNO-STAGE as a Master Keyboard (MIDI Controller Mode) ..... 89**
  - Specifying the Transmit Channel ..... 89
  - Detailed Settings in MIDI Controller Mode ..... 89
- Playing the JUNO-STAGE from an External MIDI Device ..... 90**
  - Setting the Receive Channel ..... 90
  - Setting the Program Change Receive Switch ..... 90
- Synchronizing with an External MIDI Device ..... 91**
  - Transmitting Synchronization Data ..... 91
- Exchanging MIDI Messages with Your Computer ..... 92**
  - Installing the USB Driver ..... 92
  - Specifying the USB Driver ..... 93
- Using JUNO-STAGE Editor/Librarian/Playlist Editor ..... 93**
  - Installing JUNO-STAGE Editor/Librarian/Playlist Editor in Your Computer ..... 93

**Chapter 8. Detailed Editing for Patches ..... 94**

- How to Edit a Patch ..... 94**
  - Editing in a Graphic Display (ZOOM EDIT) ..... 94
  - Viewing and Editing All Parameters (PRO EDIT) ..... 95
- Initializing a Patch ..... 96**
- Copying Patch (Tone) Settings ..... 96**
- Saving a Patch You’ve Created ([WRITE]) ..... 97**

<b>Functions of Patch Parameters .....</b>	<b>98</b>
Settings Common to the Entire Patch .....	98
Modifying Waveforms/Pitch/Pitch Envelope .....	103
Modifying the Brightness of a Sound with a Filter (TVF/TVF Envelope) .....	106
Adjusting the Volume (TVA/TVA Envelope) .....	108
Matrix Control Settings/Miscellaneous Settings .....	110
Modulating Sounds/Output Setting .....	113
Setting Effects for a Patch (Effects/MFX/MFX Control/Chorus/Reverb) .....	115
<b>Detailed Settings for Piano Mode .....</b>	<b>116</b>
Adjusting the Keyboard Touch (Key Touch) .....	117
Changing the degree to which the lid is open (Lid State) .....	117
Adjusting the Amount of Resonance (Resonance) .....	118
Selecting an Effect for the Electric Piano (EFFECT) .....	118
Saving Your Piano Mode Settings .....	119
<b>Chapter 9. Detailed Settings for a Rhythm Set .....</b>	<b>120</b>
<b>Editing a Rhythm Set .....</b>	<b>120</b>
Editing in a Graphic Display (ZOOM EDIT) .....	120
Viewing and Editing All Parameters (PRO EDIT) .....	121
<b>Initializing a Rhythm Set .....</b>	<b>122</b>
<b>Copying Rhythm Set (Rhythm Tone) Settings .....</b>	<b>122</b>
<b>Saving a Rhythm Set You've Created ([WRITE]) .....</b>	<b>123</b>
<b>Functions of Rhythm Set Parameters .....</b>	<b>124</b>
Settings Common to the Entire Rhythm Set .....	124
Modifying Waveforms/Pitch/Pitch Envelope .....	125
WAVE MIX Parameters .....	127
Modifying the Brightness of a Sound with a Filter (TVF/TVF Envelope) .....	128
Adjusting the Volume (TVA/TVA Envelope) .....	130
Output Settings (OUTPUT) .....	131
Setting Effects for a Rhythm Set (Effects/MFX/MFX Control/Chorus/Reverb) .....	131
<b>Chapter 10. Detailed Editing for Performances .....</b>	<b>132</b>
<b>How to Edit a Performance .....</b>	<b>132</b>
<b>Initializing a Performance .....</b>	<b>132</b>
<b>Editing the Patch That's Assigned to a Part .....</b>	<b>133</b>
<b>Saving a Performance You've Created ([WRITE]) .....</b>	<b>133</b>
<b>Performance Edit Screens and Parameters .....</b>	<b>134</b>
Selecting the Parts that will Produce Sound (Keyboard Switch) .....	134
Specifying the Range of Each Part (Key Range) .....	134
Making Settings for the D Beam Controller and Other Controllers .....	135
Enabling/Disabling Reception of Messages for Each MIDI Channel (Part) .....	138
Adjusting Sound Settings Such as Volume or Pan (PART MIXER) .....	139
Silencing Specific Parts (Mute) .....	139
Detailed Settings for Each Part (PART VIEW) .....	140

**Chapter 11. Other Settings ..... 144**

- Saving User Data to USB Memory ..... 144**
  - Types of Data that can be Saved ..... 144
  - Saving Data to USB Memory (User Backup) ..... 144
  - Restoring Saved Data from USB Memory Back into the JUNO-STAGE (User Restore) ..... 144
- System Settings ..... 145**
  - Procedure for Making System Settings ..... 145
  - Saving the Changes You’ve Made to the System Settings (WRITE) ..... 145
- Functions of System Parameters ..... 146**
  - System Menu [2 (GENERAL)] ..... 146
  - System Menu [3 (KBD/CTRL)] ..... 147
  - System Menu [4 (MIDI/SYNC)] ..... 150
  - System Menu [5 (CLICK/PLAYER)] ..... 151
  - System Menu [6 (D BEAM)] ..... 152
- Detailed Settings for the MIC INPUT (MIC Input Setting) ..... 154**
- Detailed Settings for Minus-One (Minus One Setting) ..... 154**
- Utility ..... 155**
  - Backing Up User Data (User Backup) ..... 155
  - Restoring Backed-Up Data (User Restore) ..... 155
  - Returning to the Factory Settings (Factory Reset) ..... 155
  - Initializing USB Memory (USB Memory Format) ..... 155
- Playing the Demo Songs ..... 156**

**Appendices ..... 157**

- Troubleshooting ..... 158**
- Error Messages ..... 162**
- Effects List ..... 163**
- Performance List ..... 192**
- Patch List ..... 193**
- Rhythm Set List ..... 200**
- Waveform List ..... 209**
- Arpeggio Style List ..... 213**
- Rhythm Group List ..... 214**
- Rhythm Pattern List ..... 215**
- MIDI Implementation ..... 217**
- MIDI Implementation Chart ..... 244**
- Specifications ..... 245**
- Index ..... 246**



# Introduction

---

---

# Panel Descriptions

## Front Panel



### 1 USB MEMORY Connector

You can connect USB memory (sold separately) to this connector.

- \* Carefully insert the USB memory all the way in—until it is firmly in place.
- \* Connect the USB memory after you turn on the JUNO-STAGE's power. Never disconnect the USB memory while the JUNO-STAGE is powered up.

### 2 VOLUME Knob

Adjusts the overall volume that is output from the rear panel OUTPUT jacks and PHONES jack (p. 22).

### 3 D BEAM Controller

Turns the D Beam controller on/off. You can apply a variety of effects to the sound by moving your hand above the D Beam controller (p. 56).

#### [SOLO SYNTH]

The D Beam will function as a monophonic synthesizer (p. 57).

#### [ACTIVE EXPRESS]

The D Beam will control active expression (p. 57).

#### [ASSIGNABLE]

You can assign a variety of parameters or functions to the D Beam to control the sounds in real time (p. 57).

### 4 MIC IN

#### [REVERB]

Turns on/off the reverb that is applied to the sound from MIC INPUT jack.

#### MIC VOLUME Knob

Adjusts the volume of the input from MIC INPUT jack (p. 87).

### 5 MODE

#### [PATCH]

Selects Patch mode (p. 45).

#### [PERFORM]

Selects Performance mode (p. 49).

#### [PART SELECT]

Shows the patch that is selected for each part (p. 50).

#### [MENU]

Displays a menu where you can make system settings and use utility functions.

#### [MIDI CONTROLLER]

Selects MIDI Controller mode, allowing you to control an external MIDI sound generator (p. 89).

#### [PREVIEW]

Hold down this button to audition the currently selected sound (p. 47).

#### [PIANO MODE]

Selects Piano mode. This provides the most suitable settings for piano playing (p. 25, p. 116).

### 6 KEYBOARD

#### [SPLIT]

Splits the keyboard into left and right zones, allowing you to play separate sounds (patches) in each (p. 51).

#### [DUAL]

Puts the keyboard in "Dual," allowing you to play two sounds (patches) simultaneously as a layer (p. 51).

#### [ARPEGGIO]

Turns the arpeggiator on/off.

A setting screen will appear when you press this button to turn it on (p. 60).

#### [CHORD MEMORY]

Turns the chord memory function on/off.

A setting screen will appear when you press this button to turn it on (p. 64).

#### [V-LINK]

Turns V-LINK on/off.

The setting screen will appear when you turn V-LINK on (p. 66).

#### [TRANPOSE]

By holding down [TRANPOSE] and pressing [-] [+] you can raise or lower the pitch of the keyboard in semitone steps (p. 52).

#### OCTAVE [DOWN/-] [UP/+]

Transpose the pitch of the keyboard in one-octave units (p. 52).

### 7

#### [EDIT]

Allows you to make detailed settings for patches, rhythm sets, and effects (p. 79, p. 94, p. 120).

#### [WRITE]

Saves the modified settings in internal memory (p. 73, p. 97, p. 123, p. 133, p. 145).

#### [FAVORITE UP/ASSIGNABLE]

Switches the favorite to the next number (p. 48).

If desired, you may assign a different function to this button (p. 148).

#### FAVORITE [ON/OFF]

Turns the Favorite function on/off (p. 47).

#### FAVORITE [BANK]

When this button is on, you can use [RHYTHM/0]–[BASS/9] to select Favorite banks (p. 47).

#### [NUMERIC]

When this button is on, you can use [RHYTHM/0]–[BASS/9] to enter numeric values (p. 44).



**8**

### Display

This shows information about the operation you're performing.

### PATCH/PERFORM NUMBER Display

This indicates the number of the currently selected patch or performance.

### [RHYTHM/0]–[BASS/9] (Category Group Buttons)

In Patch mode, use these buttons to select the patch category (p. 46).

### Function Buttons ([KBD/ORG/2]–[VOCAL/PAD/7])

The six buttons located below the display will execute various functions when you're editing or performing other tasks.

The function of these buttons will depend on the screen you've selected (p. 43).

**9**

### [DEC] [INC]

Use these to modify values. The value will change faster if you hold down one button and press the other.

If you press one of these buttons while holding down [SHIFT], the value will change in larger steps (p. 43).

### [▲] [▼] [◀] [▶] (Cursor Buttons)

These buttons move the cursor position up/down/left/right (p. 43).

### VALUE Dial

Use this to modify values. The value will change faster if you turn the VALUE dial while holding down [SHIFT] (p. 43).

### [SHIFT]

This button is used in combination with other buttons to execute various functions.

### [EXIT]

Returns you to the previous screen, or closes the currently open window. In some screens, this button will cancel the currently executing function.

### [ENTER/LIST]

Use this button to confirm a value or execute an operation. This button is also used to display a list of patches or performances (p. 46, p. 49).

## **10** SONG PLAYER

### EXT INPUT Jack

You can connect your portable audio player or similar device here (p. 73).

- \* When connection cables with resistors are used, the volume level of equipment connected to the inputs (EXT INPUT) may be low. If this happens, use connection cables that do not contain resistors.

### [C. CANCEL/MINUS ONE]

Turns the Center Cancel or Minus-One function on/off (p. 73).

### [SONG LIST]

Displays the song list if USB memory is connected.

### LEVEL [▼] [▲]

Use these buttons to adjust the volume of the rhythm pattern or song (p. 69, p. 74).

### [RHYTHM PATTERN]

Turns the rhythm pattern on/off (p. 74).

### [◀◀] [▶▶] [▶▶▶] [▶▶▶▶]

If [RHYTHM PATTERN] is off, you can use these buttons to select a song or to move the playback location within a song.

When [RHYTHM PATTERN] is on, these buttons switch rhythm patterns (p. 74).

### [STOP]

Stops playback (p. 69, p. 74).

### [PLAY]

Starts playback (p. 69, p. 74).

### [TAP TEMPO]

Used to specify the tempo (p. 60, p. 70, p. 74).

## **11** SOUND MODIFY

### [LOCK]

If you turn this button on, the following knobs will be disabled (p. 59).

### ENVELOPE [ATTACK] [RELEASE] Knobs

These knobs modify the sound in real time, or edit parameter values (p. 58).

### [CUTOFF] [RESONANCE] Knobs

These knobs modify the sound in real time, or edit parameter values (p. 58).

### MASTER EQ [LOW] [HIGH] Knobs

These knobs adjust the overall tone quality.

[LOW] knob adjusts the low frequency range, and [HIGH] knob adjusts the high frequency range (p. 59).

### [REVERB] Knob

Adjusts the amount of reverb applied to the overall sound (p. 59).

**12**

### [S1] [S2] (Assignable Switches)

You can assign various parameters or functions to these buttons (p. 55).

### Pitch bend/Modulation Lever

This allows you to control pitch bend or apply vibrato (p. 54).



# Panel Descriptions

## Rear Panel



### 1 [LCD CONTRAST] Knob

This knob adjusts the contrast of the display (p. 22).

### 2 MIDI Connectors (OUT, IN)

These connectors can be connected to other MIDI devices to receive and transmit MIDI messages (p. 88).

### 3 PEDAL

#### PATCH SELECT Jack

You can connect a pedal switch (such as one from the DP series; sold separately) here, and use it to switch patches or performances (p. 21).

#### CONTROL Jack

You can connect an expression pedal (EV-5; sold separately), and use it to control a wide variety of parameters or functions that you can assign

- \* Use only the specified expression pedal (EV-5; sold separately). By connecting any other expression pedals, you risk causing malfunction and/or damage to the unit.

#### HOLD Jack

You can connect a pedal switch (such as one from the DP series; sold separately) here, and use it as a hold pedal (p. 21). Since this jack can be enabled to support half-pedaling, you can connect a damper pedal (DP-10; sold separately) here and use it to control subtle nuances of pedaling when you're playing piano sounds.

### 4 MIC INPUT Jack

You can connect a mic here (p. 87). XLR type and phone type plugs are supported.

- \* This instrument is equipped with balanced (XLR/TRS) type jacks. Wiring diagrams for these jacks are shown below. Make connections after first checking the wiring diagrams of other equipment you intend to connect.

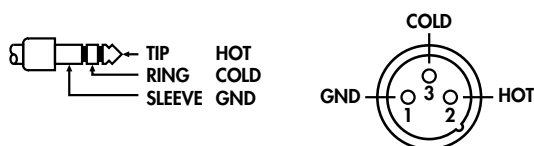

Dynamic	Phone plug (balanced, unbalanced), XLR * In "MIC INPUT SETTING," turn "Phantom Power" off (p. 154).	Nominal input level: -50 dBu (MIC VOLUME knob at MAX)
Condenser	XLR (48V phantom power provided) * In "MIC INPUT SETTING," turn "Phantom Power" on (p. 154).	

### 5 OUTPUT Jacks (R, L / MONO)

These output the audio signal in stereo to your amp or mixer. If you're outputting in mono, connect only the L/MONO jack (p. 20).

### 6 PHONES Jack

You can connect a set of headphones (sold separately) here (p. 20).

### 7 SONG/CLICK OUT Jack

You can connect a set of headphones (sold separately) here. Alternatively, this can output a stereo audio signal to your amp or mixer. When you're playing back an SMF song, a click will be output at the tempo of the song (p. 78).

### 8 USB MIDI Connector

Use this connector to connect the JUNO-STAGE to your computer via a USB cable (p. 92).

### 9 Cord Hook

Use this to secure the cord from the AC adaptor (p. 19).

### 10 DC IN Jack

Connect the AC adaptor here (p. 19). You must use only the included AC adaptor.

### 11 [POWER] Switch

This turns the power on/off (p. 22).

### 12 Ground Terminal

Depending on the circumstances of a particular setup, you may experience a discomforting sensation, or perceive that the surface feels granular when you touch this device, microphones connected to it, or the metal portions of other objects, such as guitars. This is due to an infinitesimal electrical charge, which is absolutely harmless. However, if you are concerned about this, connect the ground terminal with an external ground. When the unit is grounded, a slight hum may occur, depending on the particulars of your installation. If you are unsure of the connection method, contact the nearest Roland Service Center.

Unsuitable places for connection

- Water pipes (may result in shock or electrocution)
- Gas pipes (may result in fire or explosion)
- Telephone-line ground or lightning rod (may be dangerous in the event of lightning)



# Getting Ready

## Installing a Wave Expansion Board

Two optional Wave Expansion Boards (SRX series; sold separately) can be installed in the JUNO-STAGE.

Wave Expansion Boards store Wave data, patches, and rhythm sets, and by equipping the JUNO-STAGE with these boards, you can greatly expand your sound palette.

## Cautions When Installing a Wave Expansion Board

- To avoid the risk of damage to internal components that can be caused by static electricity, please carefully observe the following whenever you handle the board.
  - Before you touch the board, always first grasp a metal object (such as a water pipe), so you are sure that any static electricity you might have been carrying has been discharged.
  - When handling the board, grasp it only by its edges. Avoid touching any of the electronic components or connectors.
- Use a Phillips screwdriver that is suitable for the size of the screw (a number 2 screwdriver). If an unsuitable screwdriver is used, the head of the screw may be stripped.
- To remove the screws, rotate the screwdriver counter-clockwise. To tighten a screw, rotate the screwdriver clockwise.



- When installing a Wave Expansion Board, remove only the specified screw.
- Be careful that the screw you remove do not drop into the interior of the JUNO-STAGE.
- Do not leave the bottom cover removed. After installation of the Wave Expansion Board is complete, be sure to replace the cover.
- Be careful not to cut your hand on the edge of the cover or the opening edge while removing the cover.
- Do not touch any of the printed circuit pathways or connection terminals.
- Never use excessive force when installing a circuit board. If it doesn't fit properly on the first attempt, remove the board and try again.
- When circuit board installation is complete, double-check your work.

## How to Install a Wave Expansion Board

Install the Wave Expansion Board after removing the bottom panel cover.

1. Before installing the Wave Expansion Board, turn off the power of the JUNO-STAGE and all connected devices, and disconnect all cables, including the AC adaptor, from the JUNO-STAGE.
2. From the JUNO-STAGE, remove only the screw shown in the following diagram, and detach the cover.

JUNO-STAGE : bottom

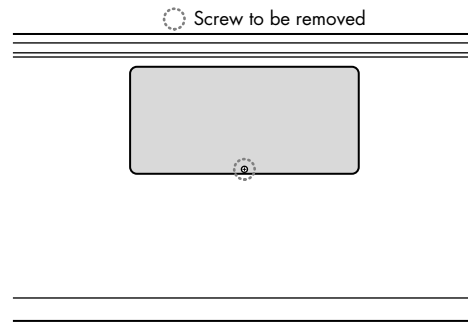

### NOTE

When turning the unit upside-down, get a bunch of newspapers or magazines, and place them under the four corners or at both ends to prevent damage to the buttons and controls. Also, you should try to orient the unit so no buttons or controls get damaged.

### NOTE

When turning the unit upside-down, handle with care to avoid dropping it, or allowing it to fall or tip over.

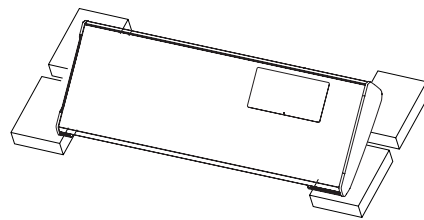

3. As shown in the following illustration, plug the connector of the Wave Expansion Board into the connector of the relevant slot, and at the same time insert the board holder through the hole of the Wave Expansion Board.

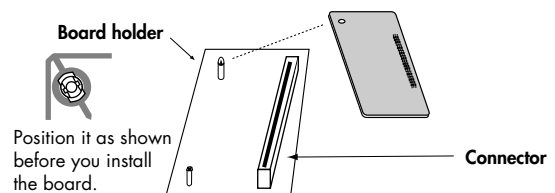

- Use the Installation tool supplied with the Wave Expansion Board to turn the holders in the LOCK direction, so the board will be fastened in place.

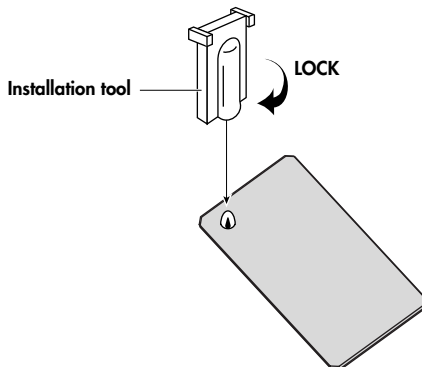

- Use the screw that you removed in step 2 to fasten the cover back in place.

## Checking the Installed Wave Expansion Board

After installation of the Wave Expansion Board has been completed, check to confirm that the installed board is being recognized correctly.

- Turn on the power, as described in p. 22.
- Press [MENU].  
The Top Menu window will open.
- Press [▲][▼] to select "1. System," and then press [ENTER].
- Press [7 (INFORMATION)].  
The SYSTEM INFORMATION screen appears.



- Press [2 (SRX)].  
Verify that the name of the installed Wave Expansion Board is displayed.

### NOTE

If the name of the board does not appear, it is possible that the board is not being recognized correctly. Turn off the power as described in "Turning Off the Power" (p. 22), and re-install the Wave Expansion Board correctly.

- To exit the SYSTEM INFORMATION screen, press [EXIT] or [7 (EXIT)].

## Connections

### Connecting the AC Adaptor

- Make sure that the [POWER] switch is off.
- Connect the included power cord to the included AC adaptor.
- Connect the AC adaptor to the JUNO-STAGE's DC IN jack, and plug the power cord into an AC outlet.

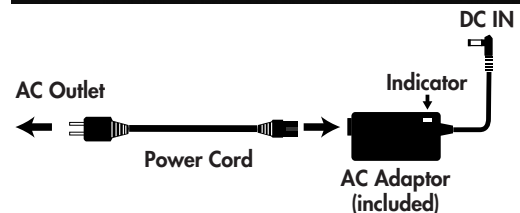

### NOTE

- Place the AC adaptor so the side with the indicator (see illustration) faces upwards and the side with textual information faces downwards.
- The indicator will light when you plug the AC adaptor into an AC outlet.
- To prevent the inadvertent disruption of power to your unit (should the plug be pulled out accidentally), and to avoid applying undue stress to the DC IN jack, anchor the power cord using the cord hook, as shown in the illustration.

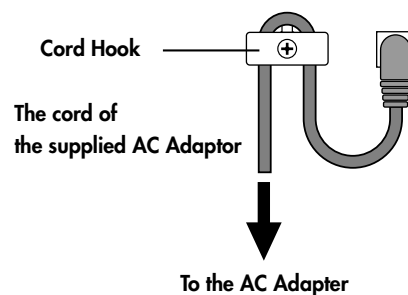

## Getting Ready

### Connecting the External Equipment

Since JUNO-STAGE contains no amplifier or speakers, you'll need to connect it to audio equipment such as a keyboard amplifier, monitor speaker system or home stereo, or use headphones to hear its sound.

In order to fully experience the JUNO-STAGE's sound, we recommend using a stereo amp/speaker system. If you're using a mono system, however, make your connections to the JUNO-STAGE's OUTPUT L/MONO jack.

\* Audio cables are not included with the JUNO-STAGE. You'll need to provide them.

#### NOTE

To prevent malfunction and/or damage to speakers or other devices, always turn down the volume, and turn off the power on all devices before making any connections.

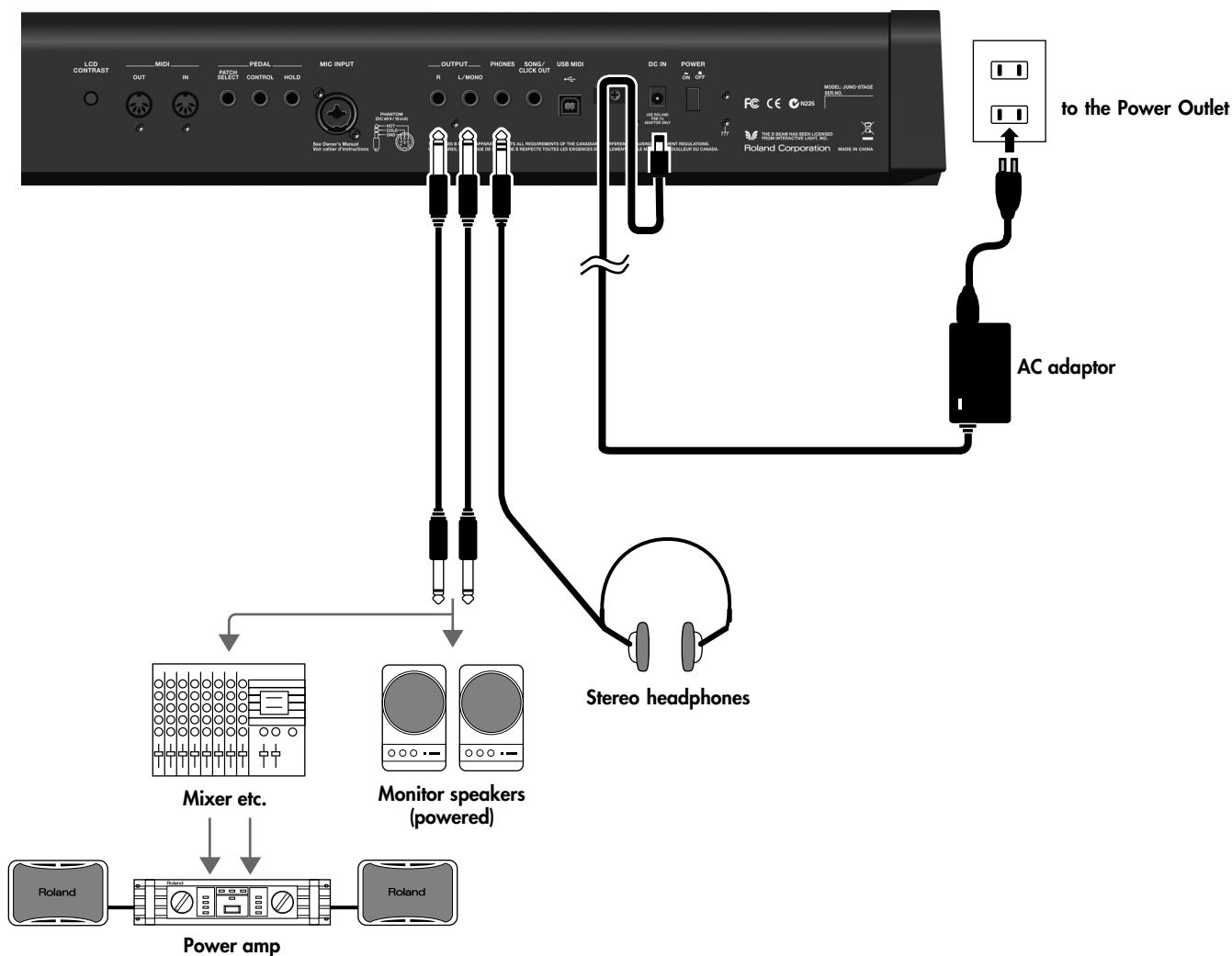



## Connecting Pedals

### Hold pedal

Connect a pedal switch (DP series; sold separately) to the rear panel PATCH SELECT jack.

While you hold down the pedal, the notes will be sustained (held) even if you take your fingers off the keyboard.

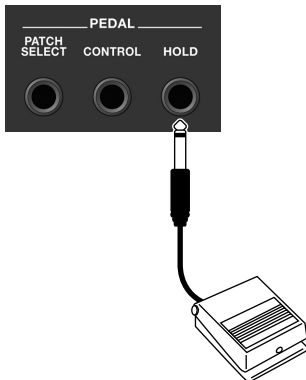

### Control pedal

Connect an expression pedal or pedal switch (EV-5 or DP series; sold separately) to the rear panel CONTROL jack.

You can use the pedal to vary the volume or tonal character, or to control various functions.

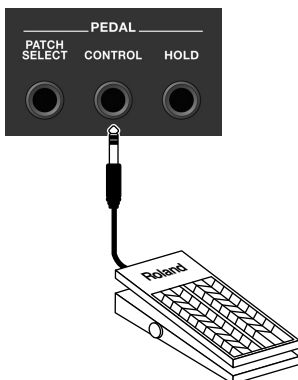

**MEMO** For details on pedal settings, refer to "Control Pedal Assign" (p. 147).

**NOTE** You must use the specified expression pedal or pedal switch (EV-5 or DP series; sold separately). Connecting a unit made by another manufacturer may cause the JUNO-STAGE to malfunction.

### Patch select pedal

Connect a pedal switch (sold separately) to the rear panel PATCH SELECT jack.

You can use the pedal to switch patches.

By using a stereo cable (sold separately) you can connect two pedal switches to the PATCH SELECT jack.

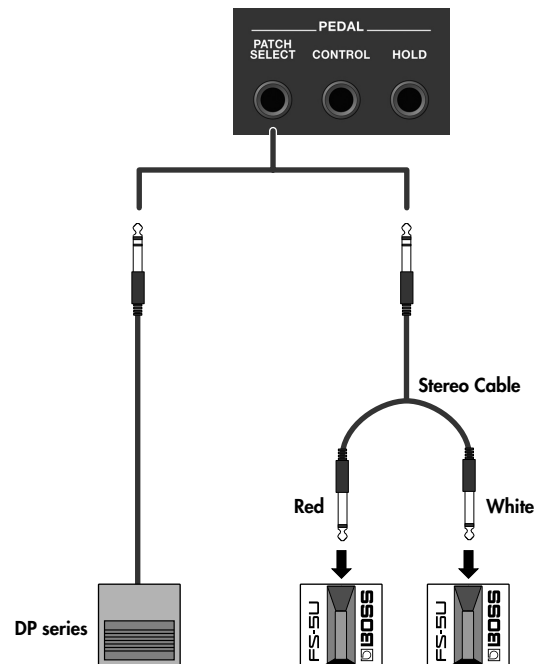

**MEMO** For details, refer to "Patch Select" (p. 147).

## Connecting a Portable Audio Device

You can connect an MP3 player or other audio device to the EXT INPUT jack on the front panel and listen to the playback.

### Using the Included Cable and Pad

You can use the included cable and pad when connecting your portable audio player to the JUNO-STAGE.

Please read "Notes when using the Music Player Pad" (included with the pad).

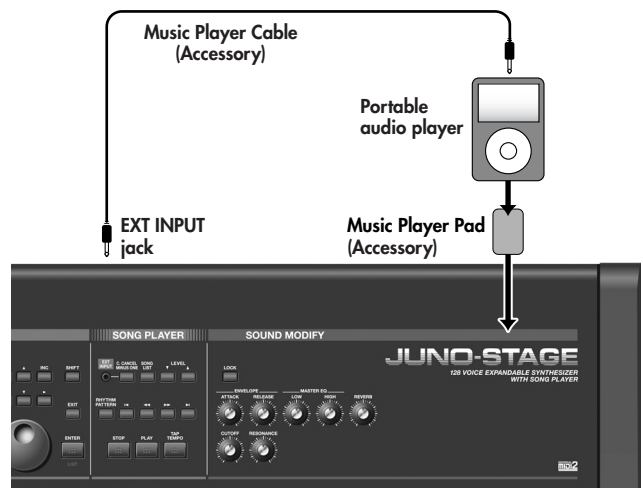

## Getting Ready

### Turning On/Off the Power

#### NOTE

Once the connections have been completed (p. 19), turn on power to your various devices in the order specified. By turning on devices in the wrong order, you risk causing malfunction and/or damage to speakers and other devices.

1. Before turning on the JUNO-STAGE's power, consider these two questions:
  - Are all devices connected properly?
  - Have the volume controls of the JUNO-STAGE and all connected audio devices been turned to their lowest settings?
2. Turn on the [POWER] switch located on the rear panel of the JUNO-STAGE.

#### NOTE

This unit is equipped with a protection circuit. A brief interval (a few seconds) after power up is required before the unit will operate normally.

#### NOTE

To ensure proper operation of the pitch bend lever, make sure not to touch the lever when turning the JUNO-STAGE's power on.

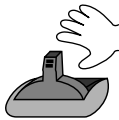

Do not touch!

3. Turn on the power for any connected audio devices.
4. While playing the keyboard and listening to the sound, slowly increase the volume of the JUNO-STAGE and the volume of the connected equipment until you obtain the desired volume.



### Turning Off the Power

1. Before turning off the power, consider these two questions:
  - Have the volume controls of the JUNO-STAGE and all connected audio devices been turned to their lowest settings?
  - Have you saved your JUNO-STAGE sounds or other data you've created?
2. Turn off the power for all connected audio devices.
3. Turn off the [POWER] switch of the JUNO-STAGE.

### Adjusting the Volume Level



1. Use the [VOLUME] knob to adjust the volume.

Turning the knob toward the left will decrease the volume, and turning it toward the right will increase the volume.  
Also adjust the connected device to an appropriate volume.

### Adjusting the Display Contrast ([LCD CONTRAST] Knob)

The characters in the display may be difficult to view immediately after turning on the JUNO-STAGE's power or after extended use. If this occurs, turn the rear panel [LCD CONTRAST] knob to make the display legible.

### Using the Included USB Memory Protector

You can use the included USB memory protector to prevent theft of the USB memory connected to the JUNO-STAGE.

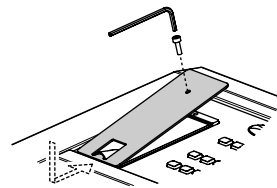

#### Caution

- You must use the included screws.
- You must use the included Allen wrench to tighten or remove the screws. Using a tool that does not match the screw heads will damage them.
- Be careful not to over-tighten the screws. Doing so may damage the screw's head, causing the wrench to rotate uselessly.
- To tighten the screws, turn the Allen wrench clockwise. To loosen the screws, turn the Allen wrench counter-clockwise.



- Keep the removed screws out of the reach of small children to ensure they are not swallowed accidentally.

# Quick Start

---

---

# Listening to the Demo Songs

Here's how to listen to the demo songs.

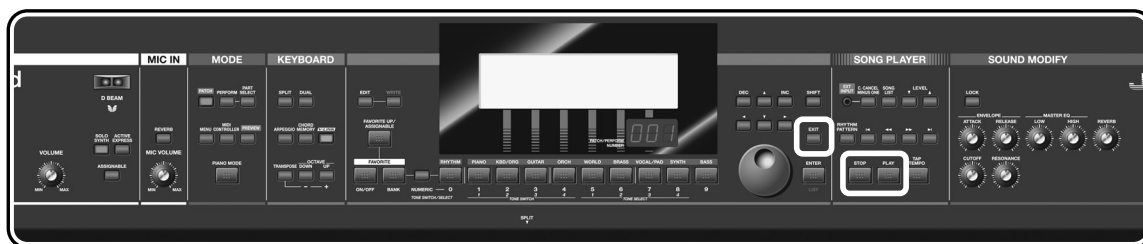

**1** Power up the JUNO-STAGE as described in “Turning On/Off the Power” (p. 22).

**2** Press [PLAY].

The DEMO PLAY screen will appear.  
The demo song will begin playing.



**3** To stop playback, press [STOP].

**TIP**

You can also select a demo song by using the cursor buttons to move the cursor.



**4** Press [EXIT] to exit the DEMO MENU screen.

No.	Title	Composer	Copyright
1	JS-GetUp!	Scott Tibbs	© 2008 Roland Corporation
2	LAURENS	Mitsuru Sakaue	© 2008 Roland Corporation
3	Earth View	Gundy Keller	© 2008 Roland Corporation

**NOTE**

All rights reserved. Unauthorized use of this material for purposes other than private, personal enjoyment is a violation of applicable laws.

**NOTE**

No data for the music that is played will be output from MIDI OUT connector.

**MEMO**

If USB memory is connected, you can press [MENU] to access the DEMO PLAY screen and play the demo songs. For details, refer to “Playing the Demo Songs” (p. 156).

# Playing the Keyboard

## Playing in Piano Mode ([PIANO MODE])

Here's how you can play piano on the JUNO-STAGE.

When you press [PIANO MODE], the JUNO-STAGE will be set to "Piano mode," which gives you the ideal settings for piano performance. You can choose either acoustic piano or electric piano as the sound, and make further detailed settings for each of these sounds.

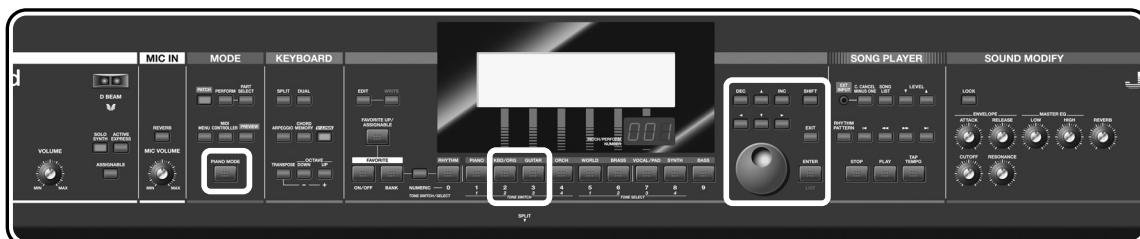

When you press [PIANO MODE] to enter Piano mode, the settings of the patch or performance you were editing will be lost. If you want to keep your edits, you must save them first.

### 1 Press [PIANO MODE].

The PIANO MODE screen will appear, and you'll be in Piano mode.

### 2 Press [2 (AC.PIANO)] or [3 (EL.PIANO)].

If you pressed [2 (AC.PIANO)], the keyboard will play a piano sound.

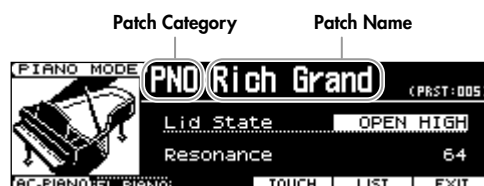

If you pressed [3 (EL.PIANO)], the keyboard will play an electric piano sound.



### 3 Use the cursor buttons to move the cursor to the patch name.



On the JUNO-STAGE, each of the sounds you play is called a "patch."

### 4 Use the VALUE dial or [DEC] [INC] to select a patch.

In Piano mode, you'll be able to select piano sounds.



You can use the cursor buttons to move the cursor to the patch category, and use the VALUE dial or [DEC] [INC] to switch to "PNO" (acoustic piano) or "EP" (electric piano).

### 5 To exit Piano mode, press [7 (EXIT)] or [EXIT].

You can also exit Piano mode by pressing [PIANO MODE] so it's extinguished.

## ■ Selecting a Patch from a List

Here's how to access a list of patches that you can select in Piano mode.

- 1 In the PIANO MODE screen, press [6 (LIST)].

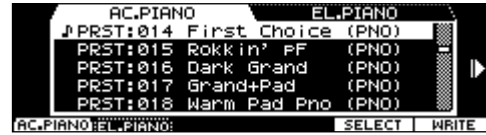

- 2 Press [2 (AC.PIANO)] or [3 (EL.PIANO)].

- 3 Use the VALUE dial or [DEC] [INC] to select a patch, and then press [6 (SELECT)].

You will return to the PIANO MODE screen.

### TIP

If you press [PREVIEW], you'll be able to audition the sound of the patch played by a suitable phrase provided for each category of patch.

### MEMO

By pressing [7 (WRITE)] you can register the currently selected patch as the patch that will be first selected when you enter Piano mode after turning on the power.

## ■ Adjusting the Piano Sound

In the PIANO MODE screen, you can vary the sound by specifying the extent to which the lid is open, and adjusting the amount of resonance.

- 1 In the PIANO MODE screen, press [2 (AC.PIANO)].

- 2 Use the cursor buttons to move the cursor to the value that you want to adjust.



- 3 Use the VALUE dial or [DEC] [INC] to adjust the value.

Parameter	Explanation	Range
Lid State	Adjusts the tonal changes that result from opening the lid by varying amounts.	FULL OPEN, OPEN HIGH, OPEN MID, OPEN LOW, CLOSED, FULL CLOSED
Resonance	On an acoustic piano, pressing the damper pedal will allow the unplayed strings to resonate with the strings of the notes you played, adding a rich and spacious resonance to the sound. This setting allows you to adjust the amount of resonance.	0-127

### cf.

You can make more detailed adjustments to the currently selected patch. For details, refer to "Chapter 8. Detailed Editing for Patches" (p. 94).

### MEMO

You can press [WRITE] and save the Lid State and Resonance settings to the currently selected patch. For details on saving, refer to "Saving a Patch You've Created ([WRITE])" (p. 97).

## ■ Selecting the Effect That Will be Applied to the Electric Piano Sound

You can choose from effects that are often applied to electric piano. The parameters that can be edited will depend on the effect you've selected.

- 1 In the PIANO MODE screen, press [3 (EL.PIANO)].

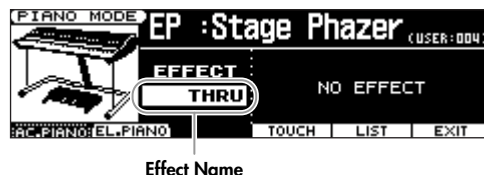

- 2 Use the cursor buttons to move the cursor to the effect name (below "EFFECT").
- 3 Use the VALUE dial or [DEC] [INC] to change the effect.

Effect name	Explanation
THRU	No effect will be applied.
Tremolo	The volume will be cyclically modulated, producing a wavering sound.
Chorus	Three-dimensional spaciousness and depth will be added to the sound.
Phaser	A swirling character will be added to the sound.
EQ	This allows you to adjust the tone quality of the high, mid, and low frequency ranges.
Speaker	This simulates various speaker types and placements of a mic that captures the sound from the speaker.

- cf.** For details on the effect parameters, refer to "Effects List" (p. 163).
- cf.** You can make more detailed adjustments to the currently selected patch. For details, refer to "Chapter 8. Detailed Editing for Patches" (p. 94).
- MEMO** You can press [WRITE] and save the effect settings to the currently selected patch. For details on saving, refer to "Saving a Patch You've Created ([WRITE])" (p. 97).

## ■ Performing with the Hold Pedal

If a pedal switch (DP series; sold separately) is connected to the PEDAL HOLD jack, pressing the pedal switch will sustain (hold) the sound even after you remove your hands from the keyboard.

- cf.** For details on connections, refer to "Hold pedal" (p. 21).

# Selecting Sounds

## Selecting Sounds (Patches)

On the JUNO-STAGE, the sounds you'll be performing are called "patches."

The JUNO-STAGE contains a wide variety of patches such as "piano," "guitar," or "brass" patches. These are called "preset patches." You are also free to create and save your own original patches ("user patches").

This section explains how to perform using the built-in preset patches.

## Playing Various Sounds (Category Group Buttons)

Each preset patch is assigned to a category group such as "piano" or "guitar," and these groups correspond to the category group buttons [RHYTHM]–[BASS]. Within each category group, the patches are further classified into additional categories.

Here's how to use the category group buttons to select a patch.

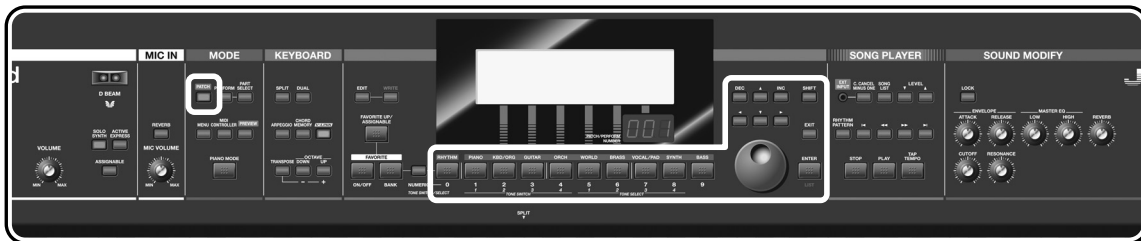

### 1 Press [PATCH].

The PATCH PLAY screen will appear.

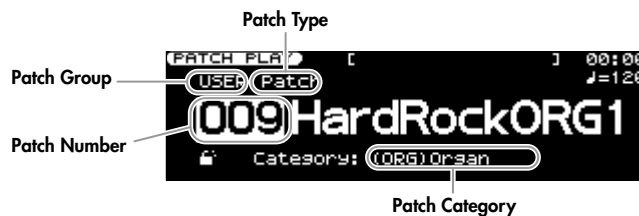

### 2 Press one of the [RHYTHM]–[BASS] buttons to select a category group.

**TIP**

By pressing [PIANO], [KBD/ORG], or [VOCAL/PAD] twice in succession you can select other categories within the same category group.

### 3 Use the VALUE dial or [DEC] [INC] to select a patch.

Play the keyboard, and you'll hear the patch you selected.



## ■ Selecting a Patch from an Expansion Board

The JUNO-STAGE allows you to install up to two separately available wave expansion boards, and select patches from them.

**cf.** For details on installing an expansion board, refer to “Installing a Wave Expansion Board” (p. 18).

### 1 Press [PATCH].

The PATCH PLAY screen will appear.

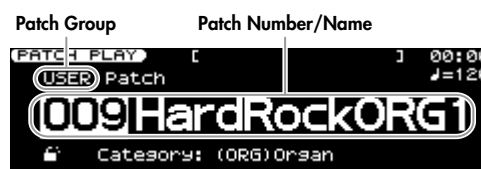

### 2 Use the cursor buttons to move the cursor to the patch group.

### 3 Use the VALUE dial or [DEC] [INC] to select “XP-A” or “XP-B.”



Make sure that the patch type is “Patch.” If it is set to “Rhythm,” move the cursor to “Rhythm” and turn the VALUE dial or press [DEC] to select “Patch.”

### 4 Use the cursor buttons to move the cursor to the patch number.

### 5 Use the VALUE dial or [DEC] [INC] to select a patch.

## Selecting Sounds from the List

### 1 Press [PATCH].

The PATCH PLAY screen will appear.

### 2 Use the cursor buttons to move the cursor to the patch number.

### 3 Press [ENTER/LIST].

The PATCH LIST screen will appear.



### 4 Use [◀] [▶] to select the category.

**TIP**

You can also press one of the category group buttons ([RHYTHM]–[BASS]) to select the category or group.

### 5 Use the VALUE dial or [DEC] [INC] to select a patch, and press [ENTER].

The patch will be selected, and you will return to the PATCH PLAY screen.

If you press [EXIT] without pressing [ENTER], the PATCH LIST screen will close without the currently selected patch being changed.

## Registering and Selecting Frequently Used Sounds (FAVORITE)

You can register your frequently used sounds in “Favorite” so they can be selected instantly when desired. You can register your favorite sounds to the ten buttons [0]–[9].

### ■ Registering a Patch

- 1 Press [PATCH].  
The PATCH PLAY screen will appear.
- 2 Select the patch that you want to register.
- 3 Hold down FAVORITE [ON/OFF] and press the button ([0]–[9]) to which you want to register the favorite.  
The patch will be registered in the favorite number you specified.

### ■ Calling up a Favorite Patch You’ve Registered

- 1 Press FAVORITE [ON/OFF] so it’s lit.
- 2 Use [0]–[9] to select a favorite.  
The patch you registered at that number will be called up.

cf.

For details on the Favorite function, refer to “Registering and Calling Up Favorite Patches or Performances (FAVORITE)” (p. 47).

## Auditioning the Sounds ([PREVIEW])

In the PATCH PLAY screen, pressing [PREVIEW] will play a phrase that’s assigned for each type (category) of patch. This lets you audition the selected patch by hearing it played with an appropriate phrase. You can also press [PREVIEW] in the PATCH LIST screen to audition the patch at which the cursor is located.

cf.

If you want to change the way in which the phrase will play when you press [PREVIEW], refer to “Preview” (p. 146).

## Playing Multiple Sounds

In Performance mode you can play separate patches with your right and left hands, or layer multiple patches so that they are heard simultaneously.

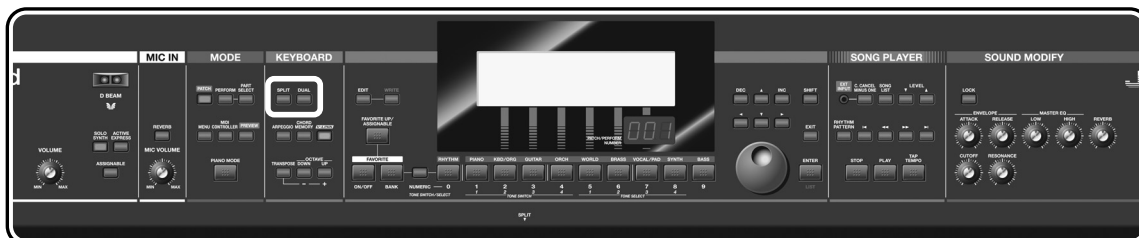

## Playing Different Sounds in the Left and Right Areas of the Keyboard ([SPLIT])

“Split mode” is when you divide the keyboard at a specified key into right-hand and left-hand areas, and play a different patch in each area. The key at which the keyboard is divided is called the “split point.” The right-hand keyboard area is called the “Upper part,” and the left-hand keyboard area is called the “Lower part.” The split point key is included in the Upper part. When you turn on the power, the split point is set to the “C4” key.

- 1 Press [PERFORM].  
The PERFORM PLAY screen will appear.



- 2 Press [SPLIT] so it's lit.  
The JUNO-STAGE will be in Split mode. [PART SELECT] will light, and the PART SELECT screen will appear.

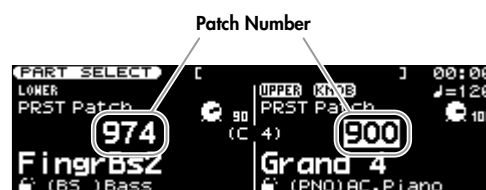

The right-hand keyboard area will play the Upper part patch, and the left-hand keyboard area will play the Lower part patch.

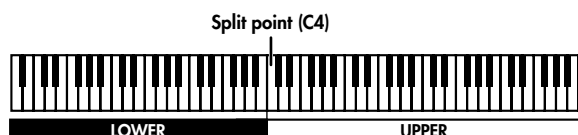

- 3 Use [◀] [▶] to move the cursor to the UPPER or LOWER patch number, and use the VALUE dial or [DEC] [INC] to select the desired patch.
- 4 To cancel Split, press [SPLIT] so it's extinguished.

## Changing the Split Point

When you're in Split, you can change the split point (the location at which the keyboard is divided).

- 1 Press [SPLIT] to turn Split on.
- 2 While holding down [SPLIT], press the key that you want to assign as the split point.  
The key you pressed will be the new split point.  
The split point key is included in the Upper part.
- 3 Press [EXIT] to close the setting window.

### TIP

You can also change the split point by holding down [SHIFT] and pressing [SPLIT] to access the setting window. In this case, use the VALUE dial or [DEC] [INC] to specify the split point in the setting window, and press [EXIT] to close the window.

## Playing Layered Sounds ([DUAL])

"Dual" is when two patches are layered across the keyboard.

- 1 Press [PERFORM].  
The PERFORM PLAY screen will appear.
- 2 Press [DUAL] so it's lit.  
You'll be in Dual.  
[PART SELECT] will light, and the PART SELECT screen will appear.  
The Upper part and Lower part patches will sound together.



- 3 Use [▲] [▼] to move the cursor to the UPPER or LOWER patch number, and use the VALUE dial or [DEC] [INC] to select the desired patch.
- 4 To cancel Dual, press [DUAL] so it's extinguished.

### MEMO

You can press [WRITE] to save the split or dual setting in the performance. For details on saving, refer to "Saving a Performance You've Created ([WRITE])" (p. 133).

## Modifying the Sound in Real Time

### Using the Pitch Bend/Modulation Lever to Modify the Sound



Pitch bend



Modulation

While playing the keyboard, you can lower the pitch by moving the lever to the left, or raise the pitch by moving the lever to the right. This is called “pitch bend.”

Pushing the lever away from yourself will apply vibrato. This is called “modulation.”

By moving the lever to left or right while pushing it away from yourself, you can apply both effects simultaneously.

### Changing the Pitch in Steps of an Octave (OCTAVE [DOWN] [UP])

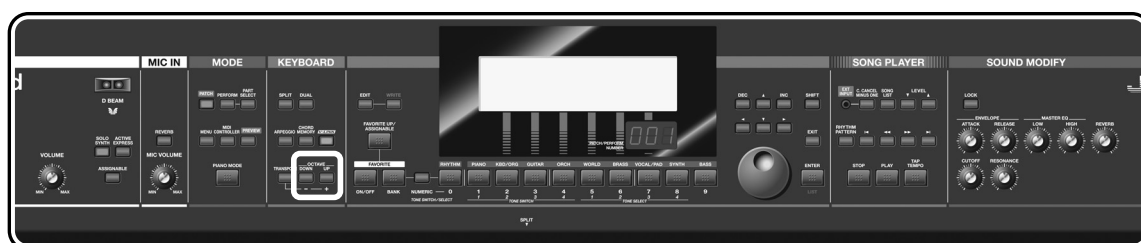

You can change the pitch of the currently selected sound in steps of one octave. This is called the “octave shift” function.

#### 1 Press OCTAVE [DOWN] or [UP].

Pressing [DOWN] will lower the pitch one octave, and pressing [UP] will raise it one octave.

You can change the pitch in a range of three octaves down (-3) to three octaves up (+3).

A setting window will open when you press one of these buttons, and will close a short time after you release the button.

If the value is other than “0,” the OCTAVE [DOWN] or [UP] indicator will light.



## Changing the Pitch in Semitone Steps ([TRANPOSE])

The transpose function lets you change the pitch of the keyboard in semitone steps. You can use this when you need to perform a transposing instrument such as trumpet or clarinet at the pitches printed in the musical score.

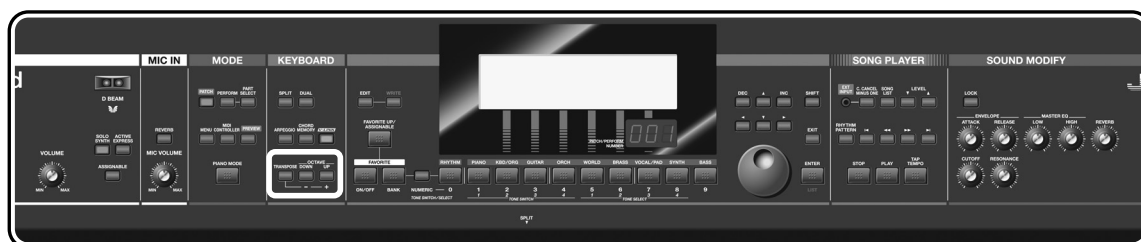

- 1 While holding down [TRANPOSE], press [-] or [+]. Specify the amount of transposition in semitone steps (G–F#: -5–+6 semitones). A setting window will open when you press the button, and will close a short time after you release the button. If the transposition value is other than “C,” the [TRANPOSE] will light.

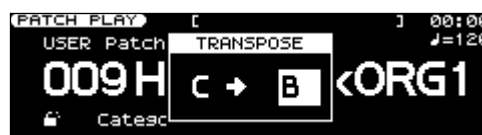

## Using the Knobs to Modify the Sound (SOUND MODIFY)

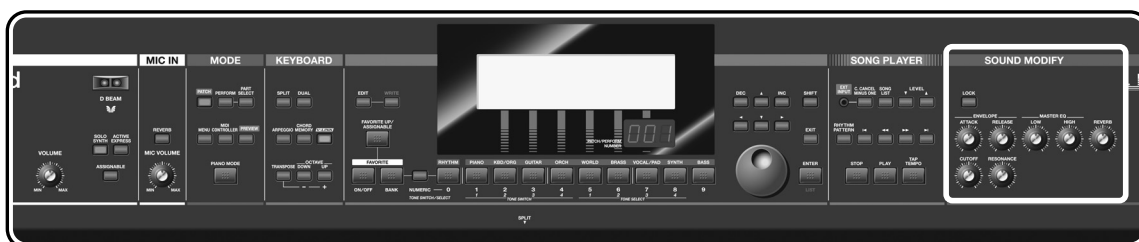

**MEMO** When you turn a knob, the corresponding setting window will open. The window will close a short time after you release the knob.

**NOTE** Depending on the settings of the patch, turning a knob might not affect the sound in some cases.

**MEMO** When in split or dual keyboard mode (in Performance mode), these changes will affect the currently selected part. The part indicated by **[KNOB]** will be affected by the SOUND MODIFY knobs.



(Example screen in Split mode)

### ■ Modifying How the Volume Changes (ENVELOPE [ATTACK]/[RELEASE] Knobs)

The “envelope” is the curve that describes how the volume changes from when the instrument begins to sound until it decays to silence.

You can use these two knobs to modify the attack and release of the envelope in real time.

**cf.** For details on the envelope, refer to “Modifying How the Volume Changes (ENVELOPE [ATTACK]/[RELEASE] Knobs)” (p. 58).

Knob	Explanation
[ATTACK]	Adjusts the time from when you press the key until the maximum level is reached. Turning the knob toward the right will lengthen the attack time, and turning it toward the left will shorten the attack time.
[RELEASE]	Adjusts the time from when you release the key until the sound diminishes to silence. Turning the knob toward the right will lengthen the release time, and turning it toward the left will shorten the release time.

## ■ Modifying the Tone Quality ([CUTOFF]/[RESONANCE] Knobs)

You can adjust the settings of the filter that cuts or boosts a specific frequency region of the sound.

Knob	Explanation
[CUTOFF]	Adjusts the filter (cutoff frequency) at which the filter begins to take effect. Turning the knob toward the right will brighten the sound, and turning it toward the left will darken the sound.
[RESONANCE]	Adjusts the way in which the sound near the cutoff frequency is boosted to produce a distinctive character. Turning the knob toward the right will strengthen the distinctive character, and turning the knob toward the left will lessen it.

## ■ Adjusting the Level of the Low and High Frequency Ranges (MASTER EQ [LOW]/[HIGH] Knobs)

You can use the knobs to adjust the high and low range levels of the equalizer that is applied to the entire sound (MASTER EQ).

Knob	Explanation
[LOW]	Adjusts the low range. Turning the knob toward the right will boost the low range, and turning it toward the left will lessen the low range.
[HIGH]	Adjusts the high range. Turning the knob toward the right will boost the high range, and turning it toward the left will lessen the high range.

## ■ Adding Reverberation to the Sound ([REVERB] Knob)

You can add reverb (reverberation) to the sounds you play from the keyboard.

Adding reverb will produce the pleasant reverberation you hear when playing in a concert hall or similar acoustic environment.

Knob	Explanation
[REVERB]	Adjusts the depth of the reverb. Turning the knob toward the right will deepen the reverb, and turning it toward the left will lessen the reverb.

cf.

For details on SOUND MODIFY, refer to "Using the Knobs to Modify the Sound (SOUND MODIFY)" (p. 58).



# Reference

---

---

# Chapter 1. Overview

## How the JUNO-STAGE is Organized

### Basic Structure

Broadly speaking, the JUNO STAGE consists of a controller section, a sound generator section, and a song player section.

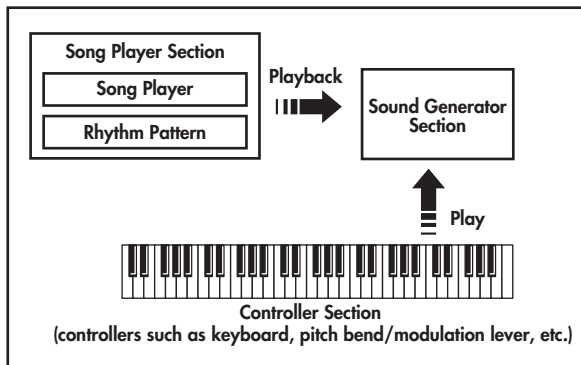

### Controller Section

This section consists of a keyboard, pitch bend/modulation lever, the panel buttons and knobs, D Beam controller, and pedals connected to the rear panel. The performance information generated when you press/release a key or press a hold pedal are transmitted as MIDI messages to the sound generator section and/or an external MIDI device.

### Sound Generator Section

This section produces the sound. It receives MIDI messages from the controller section, song player section, or an external MIDI device, generates musical sound according to the MIDI messages that were received, and outputs the sound from the output jacks and headphone jack.

### Song Player Section

The Song Player is used to play back audio files or SMF data saved in USB memory.

It can also play rhythm patterns in a variety of styles.

You can play along on the keyboard accompanied by the song or rhythm pattern played by the Song Player.

#### MEMO

When using the JUNO-STAGE's Song Player to play songs, you can create a "playlist" to specify the order in which songs will play. To create playlists, you need to use the included "Playlist Editor." For details, refer to "Using JUNO-STAGE Editor/Librarian/Playlist Editor" (p. 93).

When using the JUNO-STAGE as a MIDI sound module, you can use it in either Performance mode or in Patch mode.

### Patch Mode and Performance Mode

#### Patch Mode

In Patch mode you can use a connected keyboard or other device to play a single Patch on the JUNO-STAGE. Since Patch mode lets you use a variety of effects on a single patch, you can play very rich textures.

In Patch mode it's also easy to edit the selected sound, so this is the mode to use when editing or creating your own sounds.

#### Performance Mode

In Performance mode you can use multiple patches or rhythm sets simultaneously. A performance contains sixteen "Parts." You can assign a patch or rhythm set to each part, and use them as an ensemble, or layer sounds to create rich textures.

Of the sixteen parts in a Performance on the JUNO-STAGE, part 1 is assigned to "UPPER" and part 2 is assigned to "LOWER" (p. 51).

#### MEMO

With the factory settings, Patch mode is selected.

### How a Performance is Structured

A performance has a patch or rhythm set assigned to each of the 16 parts, and can simultaneously handle 16 sounds.

Because the JUNO-STAGE sound generator can control multiple sounds (instruments) it is called a Multi-timbral sound generator.

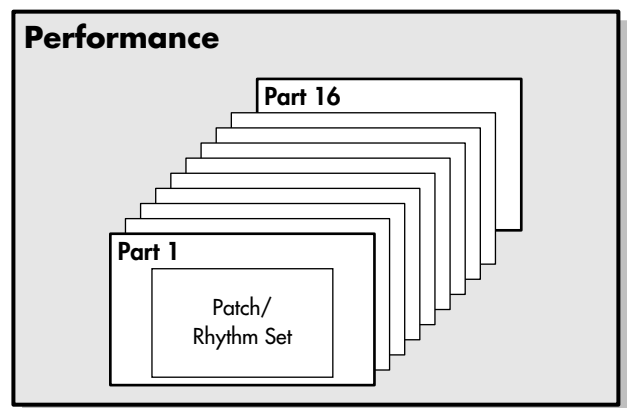

#### Part

A "part" is something to which you assign a patch or rhythm set. In Performance mode, each performance has sixteen parts, and you can assign a patch or rhythm set to each part.

## How a Patch is Structured

Patches are the basic sound configurations that you play during a performance. Each patch can be configured by combining up to four tones. Each tone can be turned on/off individually, allowing you to select the tones that will produce sound.

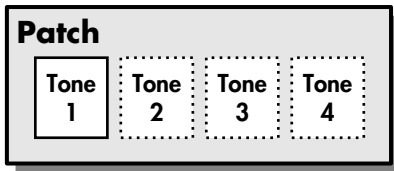

Example 1: A Patch consisting of only one Tone (Tones 2–4 are turned off).

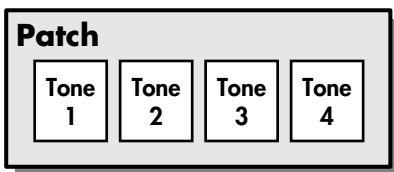

Example 2: A Patch consisting of four Tones.

### Tones

On the JUNO-STAGE, the tones are the smallest unit of sound. However, it is not possible to play a tone by itself. The patch is the unit of sound which can be played, and the tones are the basic building blocks which make up the patch.

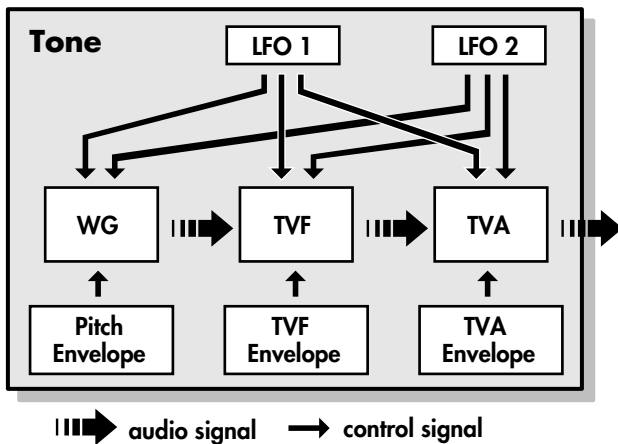

### WG (Wave Generator)

Specifies the PCM waveform (wave) that is the basis of the sound, and determines how the pitch of the sound will change.

### TVF (Time Variant Filter)

Specifies how the frequency components of the sound will change.

### TVA (Time Variant Amplifier)

Specifies the volume changes and the sound's position in a stereo soundfield.

### Envelope

You use Envelope to initiate changes to occur to a sound over time. There are separate envelopes for Pitch, TVF (filter), and TVA (volume).

### LFO (Low Frequency Oscillator)

Use the LFO to create cyclic changes (modulation) in a sound. The JUNO-STAGE has two LFOs. Either one or both can be applied to effect the WG (pitch), TVF (filter) and/or TVA (volume). When an LFO is applied to the WG pitch, a vibrato effect is produced. When an LFO is applied to the TVF cutoff frequency, a wah effect is produced. When an LFO is applied to the TVA volume, a tremolo effect is produced.

## How a Rhythm Set is Structured

Rhythm sets are groups of a number of different percussion instrument sounds. Since percussion instruments generally do not play melodies, there is no need for a percussion instrument sound to be able to play a scale on the keyboard. It is, however, more important that as many percussion instruments as possible be available to you at the same time. Therefore, each key (note number) of a rhythm set will produce a different percussion instrument.

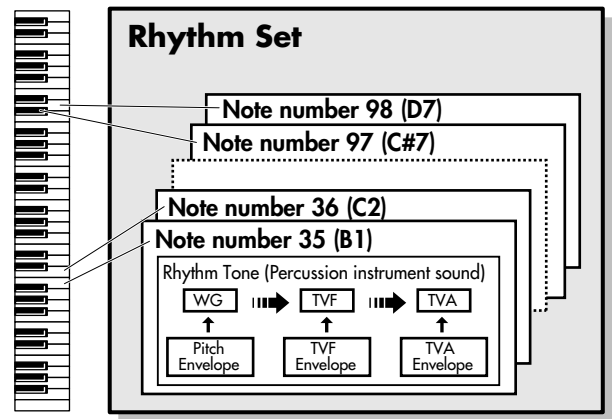

- \* There are four wave generators for each rhythm tone (percussion instrument sounds).
- \* LFO is not included in the rhythm tones (percussion instrument sounds).

## Calculating the Number of Voices Being Used

The JUNO-STAGE is able to play up to 128 notes simultaneously. The polyphony, or the number of voices (sounds) does not refer only to the number of patches actually being played, but changes according to the number of tones used in the patches, and the number of waves used in the tones. The following method is used to calculate the number of sounds used for one patch being played.

(Number of patches being played) x (Number of tones used by patches being played) x (Number of waves used in the tones)

For example, a patch that combines four tones, each of which use two waves, will use eight notes of polyphony at once. Also, when playing in Performance mode, the number of sounds for each part is counted to obtain the total number of sounds for all parts.

### How a Patch Sounds

When the JUNO-STAGE is requested to play more than 128 voices simultaneously, currently sounding notes will be turned off to make room for newly requested notes. The note with the lowest priority will be turned off first. The order of priority is determined by the Patch Priority setting (p. 98).

Patch Priority can be set either to "LAST" or "LOUDEST." When "LAST" is selected, a newly requested note that exceeds the 128 voice limit will cause the first-played of the currently sounding notes to be turned off. When "LOUDEST" is selected, the quietest of the currently sounding notes will be turned off. Usually, "LAST" is selected.

### Note priority in Performance Mode

Since Performance mode is usually used to play an ensemble consisting of several patches, it is important to decide which parts take priority. Priority is specified by the Voice Reserve settings (p. 142). When a note within a patch needs to be turned off to make room for a new note, the Patch Priority setting of the patch will apply (p. 98).

### Voice Reserve

The JUNO-STAGE has a Voice Reserve function that lets you reserve a minimum number of notes that will always be available for each part. For example if Voice Reserve is set to "10" for part 16, part 16 will always have 10 notes of sound-producing capacity available to it even if a total of more than 128 notes (total for all parts) are being requested. When you make Voice Reserve settings, you need to take into account the number of notes you want to play on each part as well as the number of tones used by the selected patch (p. 142).

It is not possible to make Voice Reserve settings that would cause the total of all parts to be greater than 64 voices.

## About the Effects

The JUNO-STAGE has built-in effect units, and you can independently edit each unit's settings.

### Multi-Effects

The multi-effects are multi-purpose effects that completely change the sound type by changing the sound itself. Contained are 79 different effects types; select and use the type that suits your aims. In addition to effects types composed of simple effects such as Distortion, Flanger, and other such effects, you can also set up a wide variety of other effects, even connecting effects in series or in parallel. Furthermore, while chorus and reverb can be found among the multi-effects types, the following chorus and reverb are handled with a different system. In Performance mode, three types of multi-effect can be used simultaneously; these are referred to as MFX1, MFX2, and MFX3. In Patch mode, you can use one multi-effect.

### Chorus

Chorus adds depth and spaciousness to the sound. You can select whether to use this as a chorus effect or a delay effect.

### Reverb

Reverb adds the reverberation characteristics of halls or auditoriums. Five different types are offered, so you can select and use the type that suits your purpose.

## Effects in Performance Mode

The multi-effects, chorus and reverb effects can be set individually for each performance. The intensity of each effect will be set for each part. When you apply effects in Performance mode, the effect settings of the patch or rhythm set assigned to each part will be ignored, and the effect settings of the performance will be used. Thus, the effects for the same patch or rhythm set may differ when played in Patch mode and in Performance mode. However, depending on the settings, you can have effect settings for a patch or rhythm set assigned to a part applied to the entire performance.

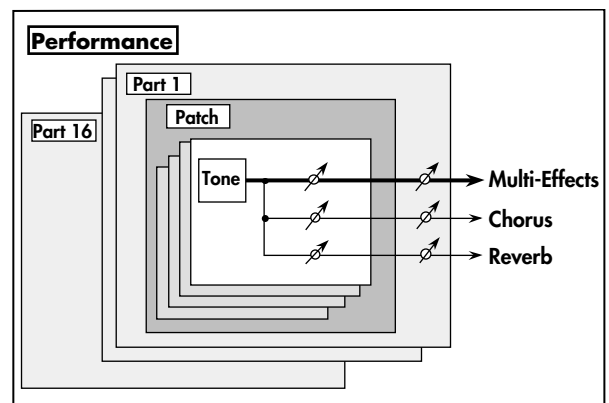

## Effects in Patch Mode

The multi-effects, chorus and reverb effects can be set up individually for each patch/rhythm set. Adjusting the signal level to be sent to each effects unit (Send Level) provides control over the effect intensity that's applied to each tone.

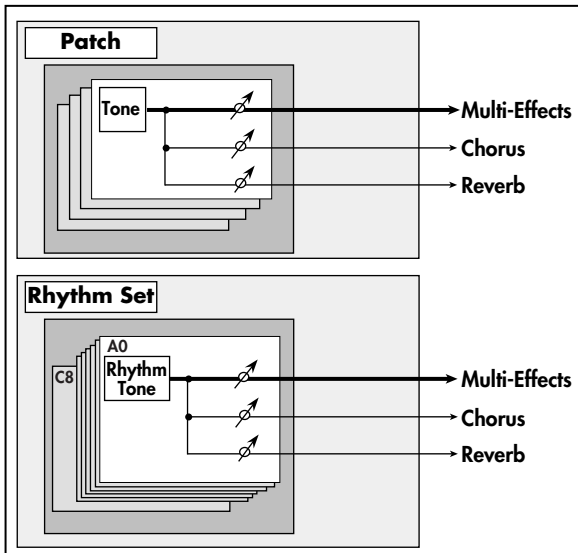

## About Memory

Patch and performance settings are stored in what is referred to as memory. There are three kind of memory: temporary, rewritable, and non-rewritable.

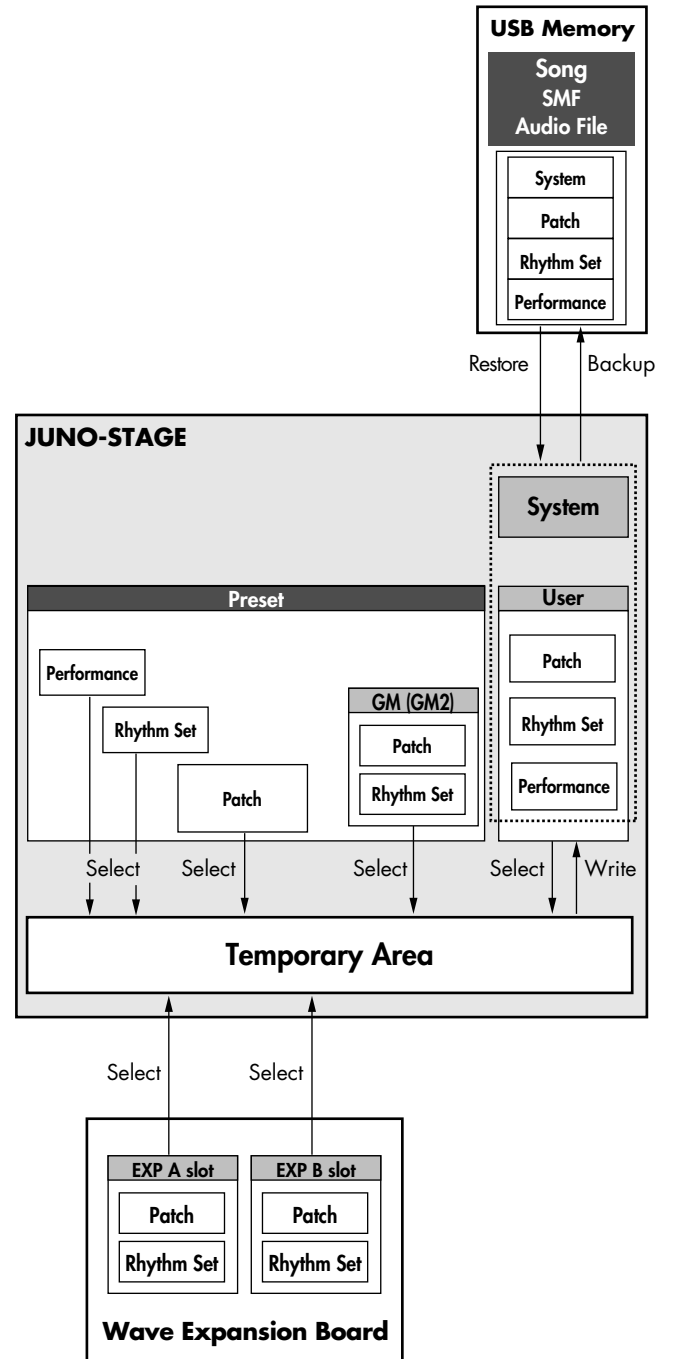

## Temporary Memory

### Temporary Area

This is the area that holds the data for the patch or performance that you've selected using the panel buttons.

When you play the JUNO-STAGE, sound is produced based on data in the temporary area. When you edit a patch or performance, you do not directly modify the data in memory; rather, you call up the data into the temporary area, and edit it there.

Settings in the temporary area will be lost when the power is turned off or when you select another patch/performance. To keep the settings you have modified, you must write them into user memory.

## Rewritable Memory

### User Memory

User memory is where you normally store the data you need.

To store a performance, execute Performance Write (p. 133). To store a patch, execute Patch Write (p. 97). To store a Rhythm Set, execute Rhythm Set Write (p. 123).

Arpeggio, chord memory, and rhythm pattern data you create is also stored in user memory (p. 63, p. 65, p. 77).

### System Memory

System memory stores system parameter settings that determine how the JUNO-STAGE functions.

To store system parameters, execute System Write (p. 145).

### USB Memory

The following settings can be backed up together to USB memory.

- User patches (rhythm sets)
- User performances
- Favorites
- User arpeggios
- User chord memories
- User rhythm patterns
- User rhythm groups
- MIDI controller mode settings
- The patch first selected in Piano mode
- System settings

## Non-Rewritable Memory

### Preset Memory

Data in Preset memory cannot be rewritten. However, you can call up settings from preset memory into the temporary area, modify them and then store the modified data in rewritable memory.

### Wave Expansion Boards (optional: SRX Series)

The JUNO-STAGE can be equipped with up to two Wave Expansion Boards (optional: SRX Series). Wave Expansion Boards contain Wave data, as well as patches and rhythm sets that use this Wave data, which can be called directly into the temporary area and played.

## Basic Operation of the JUNO-STAGE

### Switching the Sound Generator Mode

The JUNO-STAGE's sound generator can operate in one of two modes: Patch mode or Performance mode (p. 38). You can switch between these two modes as appropriate for your situation.

### Patch Mode

#### PATCH PLAY Screen

Press [PATCH] to access this screen.

In this screen you can select the patch or rhythm set that you'll play from the keyboard.



### Performance Mode

In Performance mode you can perform using multiple sounds (patches and/or rhythm sets).

#### PERFORM PLAY Screen

Press [PERFORM] to access this screen.

This screen lets you select a performance.

Here you can also make detailed settings for the performance.



#### PART SELECT Screen

Press [PART SELECT] to access this screen.

For each part, this screen shows the patch or rhythm set that is selected for that part.

If you're playing two patches as a layer (Dual: p. 51) or two patches split between the left and right regions of the keyboard (Split: p. 51), both patches will be shown in a single screen.



## About the Function Buttons

The six [KBD/ORG/2]–[VOCAL/PAD/7] buttons located below the display execute various functions (function buttons), and their operation will differ depending on the screen. The functions are shown in the bottom of the screen, and the corresponding function buttons will light.

- \* When indications such as [7 (EXIT)] appear in this manual, the numeral indicates the button name, and the text in parentheses indicates the function name displayed in the screen.

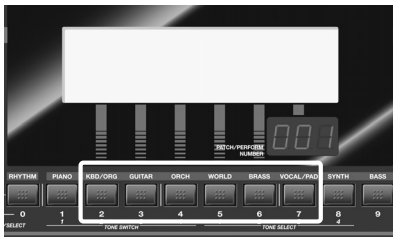

### Window

The somewhat smaller screens that appear temporarily on the normal screens are called windows. Various types of windows appears according to the situation. Some display lists, others allow you to make settings, and still others ask you to confirm an operation.



Press [EXIT] or [7 (CLOSE)] to close the window. Some windows will close automatically when an operation is performed.

## [SHIFT] Functions



By holding down [SHIFT] and pressing another button, you can access the screen for making settings related to that button. (In other words, [SHIFT] provides a shortcut to the corresponding screen.)

For example, if you hold down [SHIFT] and press [SOLO SYNTH], the Solo Synth setting screen will appear.

For details, refer to the page where a particular function is explained.

In some screens, pressing [SHIFT] will change the operation of the function buttons. In this case, pressing [SHIFT] will change the name of the functions displayed at the bottom of the screen. To execute a function, hold down [SHIFT] and press the corresponding function button.

## Editing a Value

### Moving the Cursor

A single screen or window displays multiple parameters or items for selection. To edit the setting of a parameter, move the cursor to the value of that parameter. To select an item, move the cursor to that item. When selected with the cursor, a parameter value or other selection is highlighted.

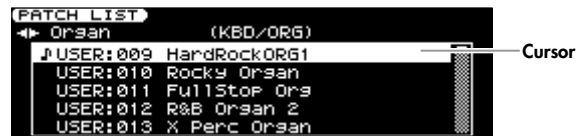

Move the cursor with [▲], [▼], [◀] and [▶] (cursor buttons).

[▲]: moves the cursor up.

[▼]: moves the cursor down.

[◀]: moves the cursor to the left.

[▶]: moves the cursor to the right.

If you hold down one cursor button while you also press the cursor button for the opposite direction, the cursor will move more rapidly in the direction of the first-pressed cursor button.

### Changing a Value

To change the value, use the VALUE dial or [DEC] [INC].



#### VALUE Dial

Turning the VALUE dial clockwise increases the value, counterclockwise decreases the value.

The value will change in larger steps if you hold down [SHIFT] while turning the VALUE dial.

#### [INC] and [DEC]

Pressing [INC] increases the value, and [DEC] decreases it.

- Keep the button pressed for continuous adjustment.
- For faster value increases, keep [INC] pressed down and press [DEC]. For decreasing value faster, keep [DEC] pressed down and press [INC].
- The value will change in larger steps if you hold down [SHIFT] while you press [INC] or [DEC].

## Entering a Value ([NUMERIC])

If you turn [NUMERIC] on, you'll be able to use the ([RHYTHM/0]-[BASS/9]) to enter numeric values.

In the PATCH PLAY (p. 45), PERFORM PLAY (p. 49), PART SELECT (p. 50), and MIDI CONTROLLER screens, you can use this method to numerically specify patch numbers, performance numbers, or MIDI program change numbers.

1. Use the cursor buttons to move the cursor to the number that you want to change.
2. Press [NUMERIC] so it's lit.  
The [0]-[9] buttons will light.
3. Use the [0]-[9] buttons to enter a numerical value, and then press [ENTER].

Your input will be finalized, and the illumination of the [0]-[9] buttons will return to their previous state.

If you press [NUMERIC] once again without pressing [ENTER], the [0]-[9] buttons will return to their previous state without the number being changed.

### TIP

When you've turned [NUMERIC] on and are entering a number, pressing [EXIT] will set the value to "0."

## Assigning a Name

On the JUNO-STAGE, you can assign names to each patch, rhythm set, performance. The procedure is the same for any type of data.



1. Press [◀] [▶] to move the cursor to the location where you wish to input a character.
2. Turn the VALUE dial, or press [DEC] [INC] to specify the character.

Button	Explanation
[3 (TYPE)]	Selects the type of character. Each time you press this, you will alternately select the first character of a character set: uppercase (A), lowercase (a), or numerals and symbols (0).
[4 (DELETE)]	Deletes the character at the cursor location.
[5 (INSERT)]	Inserts a space at the cursor location.
[6 (CANCEL)]	Cancels the input and exits the naming screen.
[7 (WRITE)]	Saves the changes you've made.
[◀] [▶]	Move the cursor.
[▲] [▼]	Switch between uppercase and lowercase letters.

### Available Characters/Symbols

space, A-Z, a-z, 0-9, ! " # \$ % & ' ( ) \* + , - . / : ; < = > ? @ [ \ ] ^ \_ ` { | }

### TIP

From a naming screen you can press [MENU] and select "1. Undo" to return the name to what it was before you changed it. From [MENU] you can select "2. To Upper" to change the character at the cursor to uppercase. From [MENU] you can select "3. To Lower" to change the character at the cursor to lowercase. From [MENU] you can select "4. Delete All" to clear all the characters you were inputting.



# Chapter 2. Selecting Sounds

## Selecting Patches

Each of the various sounds in the JUNO-STAGE is called a “patch.” Some patches are collections of percussion instrument sounds, and these are called “rhythm sets.”

The patches that are built into the JUNO-STAGE are organized into three groups: User, Preset, and GM. You can also install up to two wave expansion boards (SRX series; sold separately), giving you even more patches to choose from.

You can choose from the following patch groups.

### USER

This group contains rewritable patches in the JUNO-STAGE’s internal memory.

Patches that you create can be saved in this group. When the JUNO-STAGE is shipped from the factory, this group already contains 256 patches.

### PRST (Preset)

This group contains non-rewritable patches in the JUNO-STAGE’s internal memory.

Although the patches of this group cannot be rewritten, you are free to modify the settings of the currently selected preset patch and save the modified patch in the User patch group.

### GM (GM2)

This group contains patches compatible with GM2, which was designed to standardize the functionality of MIDI devices across manufacturers and models. You cannot rewrite these patches.

Although the patches of this group cannot be rewritten, you are free to modify the settings of the currently selected preset patch and save the modified patch in the User patch group. This group contains 256 patches.

### XP-A, B (Wave expansion board installed in the EXP A or B slot)

These groups contain patches in a wave expansion board installed in the EXP A or B slot. Although the patches of these groups cannot be rewritten, you are free to modify the settings of the currently selected patch and save the modified patch in the User patch group. The number of patches in each of these groups will depend on the wave expansion board that is installed.

#### MEMO

XP-A or B patches can be selected only if an SRX series wave expansion board (sold separately) is installed in the corresponding slot.

#### cf.

“Patch List” (p. 193)

## Selecting Patches in Patch Mode

Here’s how to select a patch in Patch mode.

You can select a patch in any of the following five ways.

- “Using the VALUE Dial to Select a Patch” (p. 45)
- “Selecting Patches from the Patch List” (p. 46)
- “Selecting Patches by Number ([NUMERIC])” (p. 46)
- “Using a Pedal to Select Patches (PATCH SELECT Pedal)” (p. 46)
- Register and select frequently used sounds (Favorite) (p. 47)

#### MEMO

The basic procedure is the same in Performance mode as well. For details, refer to “Playing the JUNO-STAGE in Performance Mode” (p. 49).

### PATCH PLAY screen

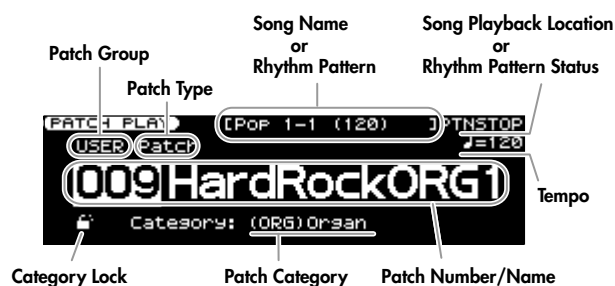

## Using the VALUE Dial to Select a Patch

1. Press [PATCH].  
The JUNO-STAGE will enter Patch mode, and the PATCH PLAY screen will appear.
2. Use the cursor buttons to move the cursor to the patch group.
3. Use the VALUE dial or [DEC] [INC] to select the desired patch group.
4. Use the cursor buttons to move the cursor to the patch type.
5. Use the VALUE dial or [DEC] [INC] to select “Patch” or “Rhythm.”
6. Use the cursor buttons to move the cursor to the patch number.
7. Use the VALUE dial or [DEC] [INC] to select a patch (or rhythm set).

### Selecting patches by category (category lock)

The lock icon (🔒) shown in the PATCH PLAY screen and PART SELECT screen specifies whether you’ll be selecting patches within the selected category or across categories.

If you move the cursor to the lock icon and use the VALUE dial or [DEC] [INC] to select the “🔒” position, you’ll be able to select patch numbers across categories. If you select the “🔓” position, you’ll be able to change the patch number within the currently selected category.

## Chapter 2. Selecting Sounds

### Selecting Patches from the Patch List

You can view a patch list and select a patch from that list.

1. Press [PATCH].  
The JUNO-STAGE will enter Patch mode, and the PATCH PLAY screen will appear.
2. Press one of the [RHYTHM]–[BASS] (category group) buttons to select the desired category group.
3. Press [ENTER].  
The PATCH LIST screen will appear.

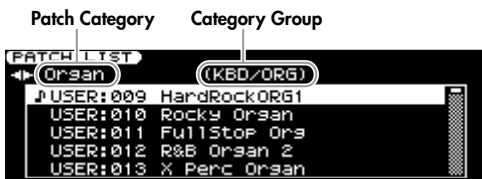

4. Use [◀] [▶] to select the desired patch category.  
Select a category within the currently selected category group. You can also use the category group buttons to select the category group.
5. Use the VALUE dial or [DEC] [INC] to select the desired patch (rhythm set).  
If you press [EXIT] instead of pressing [ENTER], you'll return to the previous screen without the patch number being changed.

### Selecting Patches by Number ([NUMERIC])

Here's how to select a patch by entering the desired patch number.

1. Press [PATCH].  
The JUNO-STAGE will enter Patch mode, and the PATCH PLAY screen will appear.
2. Use the cursor buttons to move the cursor to the patch group.
3. Use the VALUE dial or [DEC] [INC] to select the desired patch group.
4. Use the cursor buttons to move the cursor to the patch type.
5. Use the VALUE dial or [DEC] [INC] to select "Patch" or "Rhythm."
6. Use the cursor buttons to move the cursor to the patch number.
7. Press [NUMERIC] so it's lit.  
The [0]–[9] buttons will light.
8. Use the [0]–[9] buttons to enter the desired patch number, and press [ENTER].  
When you finalize the input, the [0]–[9] buttons will return to their previous state of illumination.  
If you press [NUMERIC] without pressing [ENTER], the [0]–[9] buttons will return to their previous state without changing the patch number.

### Using a Pedal to Select Patches (PATCH SELECT Pedal)

You can switch patches by using a pedal switch (such as the separately available FS-5U or FS-6) connected to the PATCH SELECT jack.

You can use a stereo cable (sold separately) to connect either two pedal switches (sold separately) or one pedal switch (such as one from the DP series; sold separately) to the PATCH SELECT jack.

When you press a pedal that's connected to the PATCH SELECT jack, the patch number is incremented or decremented according to the number of times you've pressed the pedal, and the patch will be changed accordingly.

If you've connected only one pedal, pressing the pedal will increment the patch number.

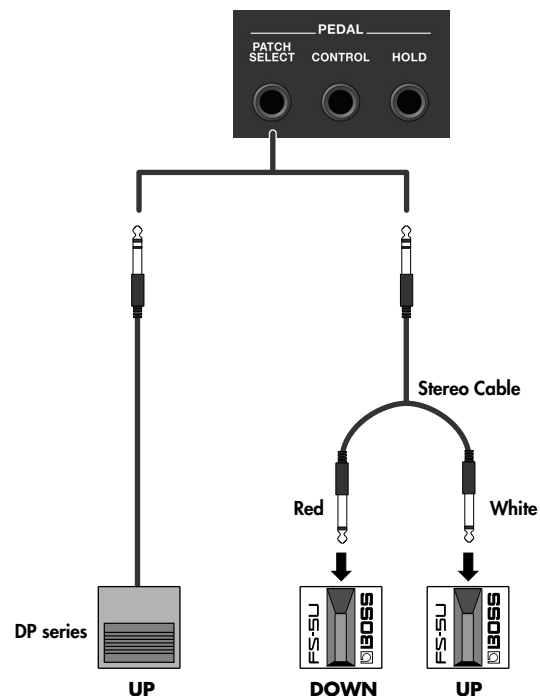

#### MEMO

This pedal will function according to the system setting "Patch Select." If "Patch Select" is assigned to "AUTO UP/(DOWN)," you'll be able to switch patches as described above. In Performance mode, pressing the pedal will switch performances, and if FAVORITE [ON/OFF] is on, pressing the pedal will switch favorites. For details, refer to the system setting "Patch Select" (p. 147).

### Auditioning a Patch ([PREVIEW])

You can press and hold down the [PREVIEW] button to audition the patch or rhythm set using a suitable phrase that's provided for each type (category) of patch. This allows you to hear the selected patch played by an appropriate phrase.

**1. Press and hold [PREVIEW].**

A phrase will play using the patch (rhythm set) that's selected in the screen.

**2. The phrase will stop playing when you release the [PREVIEW] button.**

**cf.** ➤

If you want to change how the phrase plays when you press [PREVIEW], refer to the system setting "Preview" (p. 146).

### Registering and Calling Up Favorite Patches or Performances (FAVORITE)

If there are sounds that you frequently use when playing live, you can register them in "favorites" so that they can be called up instantly. You can register patches, rhythm sets, or performances, and call them up whenever needed without regard to the mode you're in.

Each bank of favorites lets you register a total of ten patches, rhythm sets, or performances. You can create ten of these banks.

For example, up to ten sounds that you'll be using in the first song of your live set could be registered in the order in which you intend to use them.

### Registering a Favorite Patch or Performance

Here's how to register a patch (rhythm set) or performance in Favorites. You can register a sound in Favorites regardless of the FAVORITE [ON/OFF] status.

**1. In Patch mode or Performance mode, select the patch (rhythm set) or performance that you want to register.**

**2. If you want to switch Favorite banks, hold down FAVORITE [BANK], and press the button of the bank ([0]–[9]) in which you want to register the sound.**

When you press FAVORITE [BANK], the button of the currently selected bank will blink.

Pressing one of the [0]–[9] buttons will select the Favorite bank in which the sound will be registered.

**MEMO**

You can also change the Favorites bank even if FAVORITE [ON/OFF] is off.

**3. Hold down FAVORITE [ON/OFF] and press the button ([0]–[9]) to which you want to register the currently selected sound.**

A message like the following will appear, and the currently selected patch (rhythm set) or performance will be registered in the Favorite number you specified.



For example, if you registered a patch to "bank 7, number 1," the display will indicate "Patch registered to Bank: 7-1."

It's a good idea to register your favorites in the order in which they'll be used in your song or live set.

## Chapter 2. Selecting Sounds

### Calling Up a Favorite Sound

If you leave FAVORITE [ON/OFF] turned on, you'll be able to switch between favorites simply by pressing the [0]–[9] buttons.

#### 1. Press FAVORITE [ON/OFF] so it's lit.

Now you can use the [0]–[9] buttons to select favorites.

#### 2. If you want to switch Favorites banks, hold down FAVORITE [BANK] and press the button ([0]–[9]) for the desired Favorites bank.

When you press FAVORITE [BANK], the button corresponding to the currently selected bank will blink.

When you press one of the [0]–[9] buttons, the corresponding Favorites bank will be selected.

#### MEMO

You can also change the Favorites bank even if FAVORITE [ON/OFF] is off.

#### 3. Use [0]–[9] to select a Favorites number.

Depending on the favorite sound you selected, the JUNO-STAGE will enter Patch mode or Performance mode.

#### MEMO

The screen's function buttons are not available if FAVORITE [ON/OFF] is on. If you want to use the [0]–[9] buttons as function buttons, turn off FAVORITE [ON/OFF].

### Registering, Calling Up, or Editing Favorites in a List

Regardless of whether FAVORITE [ON/OFF] is on or off, you can view a list of the favorites you've registered, and add or call up registrations. You can also remove a previously registered favorite, or change the number to which it's registered.

In the favorites list, "(PAT)" is indicated for a registered patch, while "(RHY)" is indicated for a rhythm set, while "(PRF)" is indicated for a performance.

#### 1. Hold down [SHIFT] and press FAVORITE [ON/OFF].

The FAVORITE LIST screen will appear.

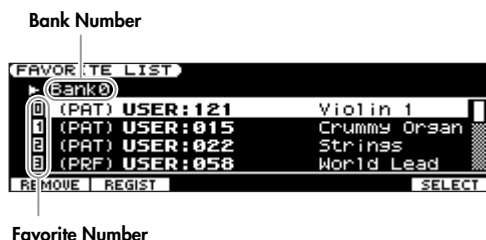

#### 2. Use [◀][▶] to select the desired bank.

#### 3. Use the VALUE dial, [▲][▼], or [DEC][INC] to select the desired favorite.

Button	Action
[ENTER] or [7 (SELECT)]	Calls up the selected favorite.
[2 (REMOVE)]	Removes the selected favorite.
[3 (REGIST)]	Registers the currently selected patch (rhythm set) or performance at the selected favorite number. If a favorite has already been registered at the selected number, the registration will be overwritten.
Hold down [SHIFT] and press [▲][▼]	Changes the registration number. If a favorite has already been registered at the move-destination number, the selected favorite will be inserted at the move destination. * It will take several seconds for this move to be executed.

### Switching Favorites with a Single Button ([FAVORITE UP/ASSIGNABLE])

#### 1. Press [FAVORITE UP/ASSIGNABLE].

You will switch to the next favorite that is registered following the currently selected favorite.

If you've selected the last number in a bank, you'll switch to a favorite in the next bank.

Numbers or banks in which no favorite has been registered will be skipped.

#### MEMO

The function of this button will depend on the System setting "Assignable Switch" (p. 148). If "ASSIGNABLE Switch" is set to "FAVORITE UP," you'll be able to switch favorites as described above.

### Using a Pedal to Select Favorites (PATCH SELECT Pedal)

You can switch favorites by using a pedal switch (sold separately) connected to the PATCH SELECT jack.

You can use a stereo cable to connect two pedal switches to the PATCH SELECT jack. (See the connection diagram on p. 21)

When you turn FAVORITE [ON/OFF] on (button lit) and press the pedal connected to the PATCH SELECT jack, the favorite number will increment or decrement accordingly.

If only one pedal is connected, pressing the pedal will increment the favorite number.

#### MEMO

This pedal function will operate according to the system setting "Patch Select." For details, refer to the system setting "Patch Select" (p. 147).

## Playing the JUNO-STAGE in Performance Mode

A performance contains patch (or rhythm set) assignments for each part, as well as volume and pan settings.

When you switch performances, you are calling up the settings for parts 1–16 together with other related settings saved in that performance.

**MEMO**

In Performance mode, there is a “keyboard switch” setting that specifies which of the parts 1–16 will produce sound. When you play the keyboard in Performance mode, you’ll hear the parts whose keyboard switch is “ON” and the part that is currently selected (the “current part”). For more about the keyboard switch, refer to “Selecting the Parts that will Produce Sound (Keyboard Switch)” (p. 134).

## Settings That Are Saved in a Performance

If you want to keep a performance you’ve edited, press [WRITE] to save it as a user performance. For details on saving, refer to “Saving a Performance You’ve Created ([WRITE])” (p. 133).

A performance contains the following settings.

- All parameters that can be edited from the PERFORM PLAY screen (p. 134) (performance parameters)
- Settings for the D Beam and other controllers (p. 135)
- Arpeggio and chord memory settings (p. 60, p. 64)
- Rhythm pattern group number (p. 74)
- The contents of effect editing done in Performance mode (p. 82)

**MEMO**

When you edit a performance, an “\*” will be shown in the PERFORM PLAY screen.

**NOTE**

The changes you make by editing a performance are temporary; they will be discarded when you turn off the power or select another performance. If you want to keep the changes to a performance you’ve edited, you must save it to user memory (p. 133).

## Selecting a Performance

The JUNO-STAGE’s performances are organized into two groups: user and preset.

### USER

This is a group of rewritable performances inside the JUNO-STAGE. Performances you create can be saved in this group. The user group already contains 64 performances.

### PRST (preset)

This is a group of non-rewritable performances inside the JUNO-STAGE. However, since you are free to edit the currently selected performance, you can select a preset performance, edit it, and write the edited performance into the user group.

#### 1. Press [PERFORM].

The JUNO-STAGE will enter Performance mode, and the PERFORM PLAY screen will appear.

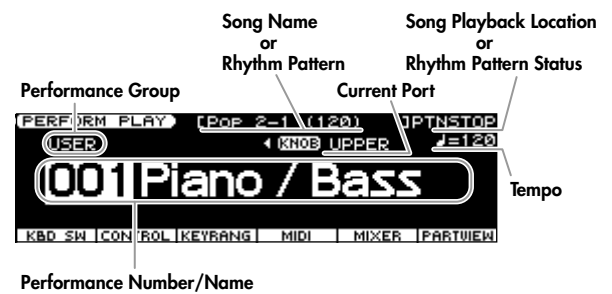

2. Use the cursor buttons to move the cursor to the performance group.
3. Use the VALUE dial or [DEC] [INC] to select the desired performance group.
4. Use the cursor buttons to move the cursor to the performance number.
5. Use the VALUE dial or [DEC] [INC] to select the desired performance.

## Selecting Performances from a List

When the cursor is located at the performance number, you can press [ENTER/LIST] to access the PERFORMANCE LIST screen.



Use [◀] [▶] to select the performance group, use the VALUE dial or [DEC] [INC] to select the desired performance, and press [ENTER]. Your choice of performance will be confirmed, and you will return to the PERFORM PLAY screen.

If you press [EXIT] instead of pressing [ENTER], you’ll return to the previous screen without the performance number being changed.

### Selecting Performances by Number ([NUMERIC])

When the cursor is located at the performance number, you can select a performance by pressing [NUMERIC], using [0]–[9] to specify the desired performance number, and pressing [ENTER].

If you press [NUMERIC] instead of pressing [ENTER], you'll return to the previous screen without the performance number being changed.

### Registering and Selecting Frequently Used Performances (FAVORITE)

You can register your frequently used performances in "Favorite" so that they can be selected instantly when desired.

For details, refer to "Registering and Calling Up Favorite Patches or Performances (FAVORITE)" (p. 47).

### Using a Pedal to Select Performances (PATCH SELECT Pedal)

You can switch performances by using a pedal switch (sold separately) connected to the PATCH SELECT jack.

You can use a stereo cable to connect two pedal switches to the PATCH SELECT jack. (Refer to the connection diagram on p. 21)

In Performance mode, each time you press a pedal connected to the PATCH SELECT jack, the performance number will increment or decrement accordingly.

If you've connected only one pedal, pressing the pedal will increment the Performance number.

#### MEMO

This pedal will function according to the system setting "Patch Select." For details, refer to the system setting "Patch Select" (p. 147).

### Selecting a Part

The currently selected part is called the "current part."

1. Press [PERFORM] or [PART SELECT] so it's lit.

The PERFORM PLAY screen or PART SELECT screen will appear.

If you're in the PERFORM PLAY screen



2. Use [◀] [▶] to select a part.

If you're in the PART SELECT screen



2. Use the cursor buttons to move the cursor to the part number.
3. Use the VALUE dial or [DEC] [INC] to select a part.

#### MEMO

If Split or Dual are on (i.e., if [SPLIT] or [DUAL] is lit), only the Upper or the Lower part can be selected.

### Selecting a Patch for Each Part

Here's how to select the patch that is assigned to a part.

1. Select a part in the PART SELECT screen.
2. Use the cursor buttons to move the cursor to the patch group or part number.
3. Use the VALUE dial or [DEC] [INC] to select the desired patch.

#### MEMO

For details on selecting patches, refer to "Selecting Patches in Patch Mode" (p. 45).

## Playing Layered Sounds (DUAL)

“Dual” refers to a setup in which two patches sound together.

If Dual is on, the patches of part 1 and part 2 will sound simultaneously. Part 1 is called the “Upper” part, and part 2 is called the “Lower” part.

### 1. Press [DUAL] so it’s lit.

Dual keyboard mode will be selected.

[PART SELECT] will light, and the PART SELECT screen will appear.



The Upper and Lower patches will sound together.

### 2. To cancel Dual keyboard mode, press [DUAL] so its illumination is turned off.

#### TIP

In the PART SELECT screen, you can move the cursor to a level knob icon in the screen and use the VALUE dial or [DEC] [INC] to adjust the part’s volume level (LEVEL). This is an easy way to adjust the volume balance of the upper and lower parts.

#### MEMO

When you turn [DUAL] on, the keyboard switch (p. 134) will be turned “ON” for Upper and Lower part and turned “OFF” for parts 3–16, regardless of the previous keyboard switch setting.

#### MEMO

When you turn [DUAL] on, the keyboard range setting (p. 134) will be set to “C–G9” (full keyboard) for Upper and Lower part, regardless of the previous keyboard range setting.

## Dividing the Keyboard into Two Areas to Play Separate Sounds (SPLIT)

“Split” refers to a setup in which the keyboard is divided into left-hand and right-hand areas with a different patch played by each area. The key at which the keyboard is divided is called the “split point.”

When you turn Split on, the right-hand area of the keyboard will play the patch that’s assigned to part 1, and the left-hand area will play the patch that’s assigned to part 2. Part 1 is called the “Upper” part, and part 2 is called the “Lower” part. The split point key is included in the upper area. The split point key is included in the Upper area.

When you turn on the power, the split point is set to “C4.”

### 1. Press [SPLIT] so it’s lit.

Split keyboard mode will be selected.

[PART SELECT] will light, and the PART SELECT screen will appear.

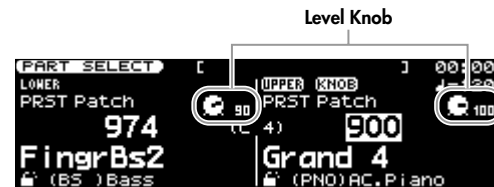

The right-hand keyboard area will play the Upper patch, and the left-hand keyboard area will play the Lower patch.

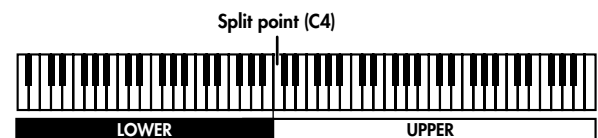

### 2. To cancel Split keyboard mode, press [SPLIT] so its illumination is turned off.

#### TIP

In the PART SELECT screen, you can move the cursor to a level knob icon in the screen and use the VALUE dial or [DEC] [INC] to adjust the part’s volume level (LEVEL). This is an easy way to adjust the volume balance of the upper and lower parts.

#### MEMO

When you turn [SPLIT] on, the Keyboard Switch setting (p. 134) will be turned “ON” for Upper and Lower part and turned “OFF” for parts 3–16, regardless of the previous keyboard switch setting.

#### MEMO

When you turn [SPLIT] on, the keyboard range (p. 134) for Upper will be set so it spans from the split point key to “G9,” while Lower will be set so it spans from “C-” to the key to the left of the split point, regardless of the previous settings.

## Changing the Split Point

In Split keyboard mode, here’s how to change the split point (the location at which the keyboard is divided).

### 1. With [SPLIT] lit, hold down [SPLIT] and press the key that you want to specify as the split point.

The key you pressed will become the new split point.

The split point key is included in the Upper area.

### 2. To close the setting window, press [EXIT].

#### TIP

You can also specify the split point by holding down [SHIFT] and pressing [SPLIT] to access a setting window. In this case, open the setting window, use the VALUE dial or [DEC] [INC] to specify the desired split point, and then press [EXIT] to close the window.

# Chapter 3. Versatile Performance Functions

## Changing the Keyboard Settings

### Changing the Pitch in One-octave Steps (OCTAVE [DOWN] [UP])

Octave Shift is a function that changes the pitch of the keyboard in steps of an octave.

If you're using your right hand to play a low-pitched part, such as a bass line, you'll find it easier to play if you shift the keyboard down one or two octaves.

1. Press **OCTAVE [DOWN]** or **[UP]**.



Pressing **[DOWN]** will lower the pitch by one octave, and pressing **[UP]** will raise the pitch by one octave.

You can change the pitch as much as three octaves down (-3) or three octaves up (+3).

A setting window will open when you press one of these buttons, and will close shortly after you release the button.

When set to any value other than "0," either **OCTAVE [DOWN]** or **[UP]** will light.

By pressing **OCTAVE [DOWN]** and **[UP]** simultaneously you can reset the value to "0."

#### MEMO

In Patch mode or Piano mode, the octave shift setting is maintained even if you switch patches.

#### NOTE

In Patch mode or Piano mode, this setting cannot be saved. The value will be reset to "0" when you power up the JUNO-STAGE.

#### MEMO

In Performance mode or MIDI controller mode you can specify an Octave Shift setting for each part.

### Transposing the Pitch in Semitone Steps ([TRANSCOPE])

Transpose is a function that changes the pitch of the keyboard in semitone steps.

You can use this to play transposing instruments such as trumpet or clarinet at the pitches written in the score.

1. Hold down **[TRANSCOPE]** and press **[-]** or **[+]**.



Specify the amount of transposition in semitone steps (G-F#: -5-+6 semitones).

A setting window will open when you press one of these buttons, and will close shortly after you release the button.

When any value other than "C" is set, **[TRANSCOPE]** will light.

By holding down **[TRANSCOPE]** and pressing **[DOWN]** and **[UP]** simultaneously you can reset the value to "C."

#### MEMO

There is a single Transpose setting for the entire JUNO-STAGE. The changed setting will be remembered even if you switch patches or performances.

#### NOTE

This setting cannot be saved. The value will be reset to "C" when you power up the JUNO-STAGE.



## Changing the Temperament to an Arabian or Other Scale (Scale Tune)

Equal temperament is the method of tuning used by most music today, including Western music. However, the JUNO-STAGE lets you recreate other temperaments by individually altering the pitches of the notes.

Using this feature, you change the temperament of the instrument to that used for Baroque or other classical music, or set it for tunings used in Arabian music.

This feature is called "Scale Tuning."

Scale tuning allows you to modify the pitch of each note in one-cent steps (1/100th of a semitone) relative to the equal-tempered pitch.

1. Press [MENU].
2. Use [▲] [▼] to select "1. System," and press [ENTER].  
The System Menu window will appear.
3. Press [2 (GENERAL)].
4. Press [3 (SOUND)].
5. Use [▲] [▼] to move the cursor to "Scale Tune Switch" or "Patch Scale Tune for C-B."
6. Use the VALUE dial or [DEC] [INC] to select the value.

Parameter	Range	Explanation
Scale Tune Switch	OFF, ON	Turn this ON if you want to perform in a temperament other than equal temperament.
Patch Scale Tune for C-B	-64~+63	Specifies the pitch difference in one-cent steps (1/100th of a semitone) relative to the equal-tempered pitch.

7. If you want to save your settings, press [7 (WRITE)].
8. Press [EXIT] to return to the previous screen.

### MEMO

When you're in Performance mode, you can specify the scale tuning for each part. For details, refer to the performance parameter "Part Scale Tune for C-B" (p. 143).

### ● Equal temperament

This divides the octave into twelve equal intervals, and is the most widely used type of tuning, particular in Western music.

### ● Just intonation (tonic of C)

Compared to equal temperament, the principal triads have a more pure sound in just intonation. However, this is the case only in one key, and triads will sound ambiguous if you play in a different key.

### ● Arabian scale

Compared to equal temperament, this scale pitches the E and B notes a quarter-tone lower, and the C#, F#, and G# notes a quarter-tone higher. There is a natural third (an interval between a major third and a minor third) between G and B, C and E, F and G#, Bb and C#, and Eb and F#.

On the JUNO-STAGE you can use Arabian temperament in the three keys of G, C, and F.

### Example: Tonic of C

If you want to use Just intonation with a tonic of C, or an Arabian scale, set the "Scale Tune Switch" to "ON," and set "Patch Scale Tune for C-B" as shown in the table.

Note name	Equal temperament	Just intonation	Arabian scale
C	0	0	-6
C #	0	-8	+45
D	0	+4	-2
E <sup>b</sup>	0	+16	-12
E	0	-14	-51
F	0	-2	-8
F #	0	-10	+43
G	0	+2	-4
G #	0	+14	+47
A	0	-16	0
B <sup>b</sup>	0	+14	-10
B	0	-12	-49

## Chapter 3. Versatile Performance Functions

### Adjusting the Keyboard Touch

You can set the instrument so all notes sound at a fixed volume regardless of the strength (velocity) at which you play the keys, or adjust the way in which the keyboard responds to your playing touch.

1. Press [MENU].
2. Use [▲][▼] to select "1. System," and press [ENTER].  
The System Menu window will appear.
3. Press [3 (KBD/CTRL)].
4. Press [2 (KBD)].
5. Use [▲][▼] to select a parameter.
6. Use the VALUE dial or [DEC] [INC] to select the desired value.

Parameter	Range	Explanation
Keyboard Velocity	REAL, 1–127	The velocity produced when you play a key. <b>REAL:</b> The velocity will depend on how strongly you play the key. <b>1–127:</b> A fixed velocity will be produced regardless of how strongly you play the key.
Keyboard Velocity Curve	LIGHT, MEDIUM, HEAVY	Specifies the keyboard's touch sensitivity. <b>LIGHT:</b> Light synthesizer <b>MEDIUM:</b> Normal <b>HEAVY:</b> Acoustic piano
Keyboard Velocity Sens	-63–+63	This is a fine adjustment of the keyboard sensitivity after the Keyboard Velocity Curve has been applied. Higher settings for this parameter will cause higher velocity values to be transmitted as you play the keys more strongly.

7. If you want to keep your settings, press [7 (WRITE)].
8. Press [EXIT] to return to the previous screen.

#### MEMO

Changing the keyboard Velocity Curve setting will also affect the piano mode's "Key Touch Select" setting (p. 117).

### Changing the Pitch in Real Time (Pitch Bend/Modulation Lever)

While holding down a key, moving the lever to the left will lower the pitch, and moving it to the right will raise the pitch. This is called "pitch bend."

Pushing the lever away from yourself will apply vibrato. This is called "modulation."

Pushing the lever away from yourself while moving it to the left or right will apply both effects simultaneously.



Pitch bend



Modulation

#### MEMO

The pitch bend range can be specified separately for each patch. Refer to "Pitch Bend Range Up/Down" (p. 101).

In Performance mode you can make this setting individually for each part (p. 141).

## Assigning Functions to [S1] [S2]

You can assign various performance-related functions to [S1] and [S2]. When you turn [S1] or [S2] on/off, the assigned function will be switched or turned on/off.

### MEMO

When Split or Dual are selected (in Performance mode), these switches will perform the function assigned to the currently selected part (the current part). The part indicated by **KNOB** is the part for which [S1] [S2] will operate.



### 1. Hold down [SHIFT] and press [S1] or [S2].

A screen like the following will appear.



(Example screen in Patch mode)

### 2. Use [▲] [▼] to select the desired parameter.

"Switch 1" makes settings for [S1], and "Switch 2" makes settings for [S2].

### 3. Use the VALUE dial or [DEC] [INC] to specify the setting.

For details on the parameters and values that you can assign, refer to "[3 (S1/S2)]" (p. 136) in Performance mode, and refer to "Switch 1" (p. 149) in Patch mode.

### 4. Press [EXIT] to return to the previous screen.

### MEMO

In Performance mode, the [S1] [S2] settings are saved as performance settings. If you want to keep these settings, press [WRITE] to save them in the performance (p. 133)

### MEMO

In Patch mode, the [S1] [S2] settings are saved as system settings. If you want to keep these settings, press [7] ([WRITE]).

## Controlling Portamento

In step 3 of the above procedure, assign "PORTAMENTO" to "Switch 1" or "Switch 2."

Turning [S1] or [S2] on/off will turn portamento on/off.

This is particularly effective when used with synth bass sounds.

## Playing Monophonically

In step 3 of the above procedure, assign "MONO/POLY" to "Switch 1" or "Switch 2."

Turning [S1] or [S2] on/off will switch between monophonic and polyphonic playing.

This is particularly effective when used with synth bass sounds.

## Simulating a Guitarist's Double-bending

In step 3 above, set "Switch 1" or "Switch 2" to "BEND MODE."

When you turn [S1] or [S2] on/off, the "BEND MODE" setting "CATCH+LAST" will turn on/off.

If "CATCH+LAST" is on, and you play a chord and use the pitch bend lever, the pitch bend will apply only to the last-played note. For example, if you play a chord in the order of "D" and "C," moving the pitch bend lever toward the right will raise the pitch only of the "C" note.

This is particularly effective when used with a guitar-type sound.

## Switching the Speed of the Organ Rotary Effect

If you want to use [S1] or [S2] to switch the speed of the rotary effect, make settings as follows.

Here we will explain how to use [S1] to control the effect. If you want to use [S2], simply read "Switch 2" where "Switch 1" appears.

### ■ In Patch mode

#### 1. Assign the system setting "Switch 1" to "SYS CTRL 1 SRC."

##### 1) Hold down [SHIFT] and press [S1].

A setting screen will appear.

##### 2) For "Switch 1," set "Assign" to "SYS CTRL 1 SRC."

In this example, we'll use "SYS CTRL 1 SRC."

#### 2. Select the patch to which the effect is to be applied.

##### 1) Press [PATCH] to access the PATCH PLAY screen.

##### 2) Select a patch.

You'll probably want to select an organ-type sound.

#### 3. Make effect settings.

##### 1) Press [EDIT] and select "EFFECT EDIT."

The EFFECT ROUTING screen will appear.

##### 2) Press [3] ([MFX]).

The MFX screen will appear.

##### 3) Choose "21:ROTARY" as the MFX Type.

##### 4) Press [4] ([CTRL]).

The MFX CTRL screen will appear.

##### 5) In the MFX CTRL screen, make the following settings.

- As the "Source," specify "SYS CTRL 1."
- As the "Destination," specify "Speed."
- Set the "Sens" value to the desired amount of effect.

## Chapter 3. Versatile Performance Functions

### 4. Turning [S1] on/off will switch the speed of the rotary effect.

#### TIP

You can also use the above procedure to make settings for other effects; for example, you could change the amount of drive for an overdrive effect.

#### MEMO

If you want to keep these settings, save the system settings in System (p. 145) and save the effect settings in the patch (p. 97).

#### NOTE

If you find it difficult to hear the effect, check the following settings.

- In the EFFECT ROUTING screen (p. 80) of the selected patch, make sure that the "Tone Output Level" is raised for tones whose "Tone Switch" is on, and that the "MFX Output Level" is high enough. If these settings are too low, raise them.
- In the EFFECT ROUTING screen (p. 80) of the selected patch, make sure that "PATCH OUT" is set to "MFX." If any other setting is selected, change it to "MFX."

### ■ In Performance mode

Before you continue with the following procedure, prepare the patch to which you want to apply the rotary effect. Make settings as described in steps 2 and 3 of "In Patch mode."

#### 1. For the desired part of the performance, select the patch you prepared above.

As our example in this explanation, we'll use part 2 (or LOWER).

#### 2. Assign the performance parameter "Switch 1" to "SYS CTRL 1 SRC."

- \* Set the system control number (SYS CTRL) to match the value you specified for "Source" in step 3–5 of "In Patch mode."

##### 1) Hold down [SHIFT] and press [S1].

A setting screen will appear.

##### 2) For "Switch 1," set "Assign" to "SYS CTRL 1 SRC."

##### 3) Press [EXIT] to access the PERFORM PLAY screen.

#### 3. Make effect settings.

##### 1) Press [EDIT] and select "EFFECT EDIT."

The EFFECT ROUTING screen will appear.

##### 2) In the EFFECT ROUTING screen, make the following settings.

- Set the part number in the upper left to "PART 2 (or LOWER)."
- Below the part number, set "OUTPUT" to "MFX."
- Below "OUTPUT," set "MFX SEL" to "1."
- Set the "MFX1" Source to "P 2 (or LO)" (the part you selected in step 1). When you make this setting, the MFX Type will indicate "21: ROTARY."

##### 3) Press [EXIT] several times to access the PERFORM PLAY screen.

#### 4. Use [S1] to apply the effect.

##### 1) In the PERFORM PLAY screen or PERFORM SELECT screen, select part 2 (or LOWER).

The [S1] effect will apply to the current part; select the part to which you want the effect to apply.

##### 2) Turning [S1] on/off will switch the speed of the rotary effect.

#### MEMO

If you want to keep these settings, save them in the performance (p. 133).

## Using the D Beam Controller to Modify the Sound

The D Beam controller can be used simply by waving your hand over it. It can be used to apply various effects, depending on the function that is assigned to it. On the JUNO-STAGE, the D Beam controller can be used not only to modify the sounds, but also to control the pitch of a monophonic (solo) synthesizer sound.

#### 1. Press either the D BEAM [SOLO SYNTH], [ACTIVE EXPRESS], or [ASSIGNABLE] button to turn on the D Beam controller.

Button	Explanation
[SOLO SYNTH]	Lets you use the D Beam controller as a monophonic synthesizer.
[ACTIVE EXPRESS]	The D Beam controller will add the ideal type of expression for each sound.
[ASSIGNABLE]	Operates the function assigned to the D Beam controller.

#### 2. While you play the keyboard to produce sound, place your hand above the D Beam controller and move it slowly up and down.

An effect will be applied to the sound, depending on the function that is assigned to the D Beam controller.

#### 3. To turn off the D Beam controller, once again press the button you pressed in step 1 so the indicator goes out.

#### MEMO

If Performance mode is selected, the D Beam controller on/off setting is saved for each performance as part of the performance settings.

### The usable range of the D Beam controller

The following diagram shows the usable range of the D Beam controller. Waving your hand outside this range will produce no effect.

#### NOTE

The usable range of the D Beam controller will become extremely small when used under strong direct sunlight. If it does not function as you expect, adjust the sensitivity as appropriate for the brightness of your location.

→ "D Beam Sens" (p. 152)

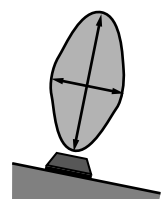

## SOLO SYNTH

On the JUNO-STAGE you can play a monophonic synthesizer whose pitch is controlled by the D Beam controller.

1. Hold down [SHIFT] and press D BEAM [SOLO SYNTH].

A screen like the following appears.



2. Press [▲][▼] to select the parameter.
3. Use the VALUE dial or [DEC] [INC] to make settings.  
For details on the available parameters and values, refer to “[3 (SYNTH)]” (p. 152).
4. If you want to keep these settings, press [7 (WRITE)].

### TIP

You can use the function keys shown in the bottom of the screen to access the D Beam assignable or active expression setting screens.

5. Press [EXIT] to return to the previous screen.

### MEMO

Setting for the Solo Synth are saved for system settings.

## ACTIVE EXPRESSION

You can use the D Beam controller to apply the ideal type of expression for each sound.

### MEMO

The way in which expression is applied will differ for each sound. For some sounds, the effect may be difficult to notice.

1. Hold down [SHIFT] and press D BEAM [ACTIVE EXPRESS].

A screen like the following appears.



2. Press [▲][▼] to select the parameter.
3. Use the VALUE dial or [DEC] [INC] to make settings.  
For details on the available parameters and values, refer to “[4 (ATV EXP)]” (p. 153).
4. If you want to keep these settings, press [7 (WRITE)].

### TIP

You can use the function keys shown in the bottom of the screen to access the D Beam controller assignable or solo synth setting screens.

5. Press [EXIT] to return to the previous screen.

### MEMO

Setting for the Active Expression are saved for system settings.

## ASSIGNABLE

You can assign various functions to the D Beam controller and apply a wide range of effects to the sound in real time.

1. Hold down [SHIFT] and press D BEAM [ASSIGNABLE].

A screen like the following appears.



(Example screen in Patch mode)

2. Press [▲][▼] to select the parameter.
3. Use the VALUE dial or [DEC] [INC] to make settings.  
For details on the available parameters and values, refer to “[4 (DBASGN)]” (p. 136) in Performance mode, and refer to “[5 (ASSIGN)]” (p. 153) in Patch mode.

### TIP

You can use the function keys shown in the bottom of the screen to access the D Beam controller active expression or solo synth setting screens.

4. Press [EXIT] to return to the previous screen.

### MEMO

In Performance mode, the assignable settings are saved as settings of the performance. If you want to save these settings, press [WRITE] to save them in the performance (p. 133).

### MEMO

In Patch mode, the assignable settings are saved as system settings. If you want to keep these settings, press [7 (WRITE)].

## Using the Knobs to Modify the Sound (SOUND MODIFY)

You can use the SOUND MODIFY knobs to modify the sound in real time.

**MEMO**

If you've selected a rhythm set in Patch mode, the ENVELOPE [ATTACK]/[RELEASE] knobs and the [CUTOFF]/[RESONANCE] knobs will affect each key (rhythm tone) individually.

**MEMO**

The parameters affected by the SOUND MODIFY knobs will depend on whether you're in Patch mode or Performance mode (MASTER EQ is an exception). For details, refer to the explanation for the relevant section.

**MEMO**

In Performance mode, these knobs will affect the current part (the currently selected part). In the PERFORM PLAY screen or PART SELECT screen, the part for which **[KNOB]** is shown is the part affected by the SOUND MODIFY knobs.



**NOTE**

Depending on the settings of the patch, turning a knob might not affect the sound in some cases.

## Modifying How the Volume Changes (ENVELOPE [ATTACK]/[RELEASE] Knobs)

The "envelope" is the shape of the volume changes from when an instrument begins sounding until it decays to silence. On a keyboard instrument, the envelope specifies the way that the volume changes, starting when you press a key, and how it decays after you release the key.

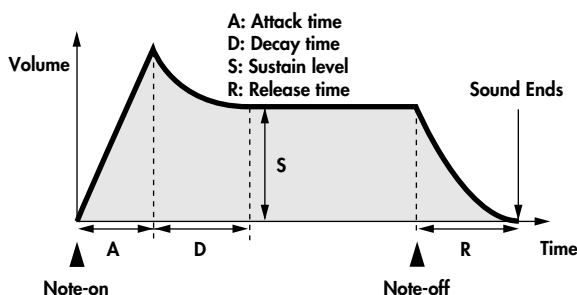

- A: Attack time:** Time from when you press the key until the sound reaches its maximum level
- D: Decay time:** Time over which the level decays from the maximum to the sustain level.
- S: Sustain level:** Volume at which the sound will be sustained while you hold down the key
- R: Release time:** Time over which the sound decays after you release the key

On the JUNO-STAGE, you can use the two ENVELOPE knobs to adjust the A (Attack) and R (Release) times of the currently selected patch.

Mode	Parameter	Value	Explanation
<b>[ATTACK] knob</b>			
Performance (Each Part)	Attack Time Offset	-64--+63	Adjusts the time from when you press the key until the sound reaches the maximum level.
Patch (Patch)	Attack Time Offset	-63--+63	Turning the knob toward the right will lengthen the attack time, and turning it toward the left will shorten the attack time.
Patch (Rhythm Set)	A-Env Time 1	0-127	
<b>[RELEASE] knob</b>			
Performance (Each Part)	Release Time	-64--+63	Adjusts the time from when you release the key until the sound is no longer heard.
Patch (Patch)	Release Time Offset	-63--+63	Turning the knob toward the right will lengthen the release time, and turning it toward the left will shorten the release time.
Patch (Rhythm Set)	A-Env Time 4	0-127	* In the case of a rhythm set, the setting window will show the currently selected key (for example, C4).

## Modifying the Tonal Character ([CUTOFF]/[RESONANCE] Knobs)

You can use these knobs to adjust the filter that cuts or boosts specific frequency regions of the sound.

These affect the following parameters of the currently selected patch.

Mode	Parameter	Value	Explanation
<b>[CUTOFF] knob</b>			
Performance (Each Part)	Cutoff Offset	-64--+63	Adjusts the frequency (cutoff frequency) at which the filter begins to be applied.
Patch (Patch)	Cutoff Offset	-63--+63	Turning the knob toward the right will brighten the sound, and turning it toward the left will darken the sound.
Patch (Rhythm Set)	Cutoff Frequency	0-127	
<b>[RESONANCE] knob</b>			
Performance (Each Part)	Resonance Offset	-64--+63	Boosts the sound in the vicinity of the cutoff frequency, adding a distinctive character to the sound.
Patch (Patch)	Resonance Offset	-63--+63	Turning the knob toward the right will strengthen this character, and turning the knob toward the left will weaken it.
Patch (Rhythm Set)	Resonance	0-127	

## Adjusting the Level of the Low and High Frequency Ranges (MASTER EQ [LOW]/[HIGH] Knobs)

You can use these knobs to adjust the levels of the Low and High Frequency ranges of the equalizer that is applied to the overall sound (MASTER EQ).

Knob	Parameter	Value	Explanation
[LOW]	Low Gain	-15-0-+15	Adjusts the low range sound. Turning the knob toward the right will boost the low range sound, while turning it toward the left will attenuate the low range sound.
[HIGH]	High Gain	-15-0-+15	Adjusts the high range sound. Turning the knob toward the right will boost the high range sound, while turning it toward the left will attenuate the high range sound.

## Adding Reverberation ([REVERB] Knob)

You can add reverb (reverberation) to the sounds that you play from the keyboard.

By adding reverb, you can recreate the pleasant acoustics that are typical of a performance in a concert hall or similar space.

Mode	Parameter	Value	Explanation
<b>[REVERB] knob</b>			
Performance	Reverb Send Level	0-127	Adjusts the amount of reverb. Turning the knob toward the right will deepen the reverb, and turning it toward the left will decrease the reverb.
Patch	Reverb Output Level	0-127	

### MEMO

This effect will be applied if "REVERB" is turned "ON" in the EFFECT SWITCH window (p. 79).

## Disabling the Knobs ([LOCK])

Turning on [LOCK] will disable the seven SOUND MODIFY knobs so that inadvertently moving these knobs during a performance will not change your settings.

### 1. Press [LOCK] so it's lit.

The Lock function will be turned on, and the SOUND MODIFY knobs will be disabled.

### 2. To cancel the Lock function, press [LOCK] so its illumination is turned off.

### MEMO

If the Lock function is on, the value of the parameters will not change even if the knob positions are changed.

## Assigning a Function to the Pedal (Control Pedal)

You can assign various performance-related functions to a pedal that is connected to the rear panel CONTROL PEDAL jack.

Pedal such as expression pedals (sold separately), pedal switches (DP series; sold separately), or foot switches (sold separately) can be connected to the JUNO-STAGE.

1. Press [MENU].
2. Use [▲][▼] to select "1. System," and press [ENTER].  
The System Menu window will appear.
3. Press [3 (KBD/CTRL)].
4. Press [3 (PEDAL)].
5. Use [▲][▼] to select the "Control Pedal Assign."
6. Use the VALUE dial or [DEC] [INC] to select the desired value.

Value	Explanation
CC01-31, 33-95	Controller numbers 1-31, 33-95
BEND UP	The pitch will rise in semitone steps (maximum 4 octaves) each time you press the pedal.
BEND DOWN	The pitch will fall in semitone steps (maximum 4 octaves) each time you press the pedal.
AFTERTOUCH	Aftertouch
OCT UP	Each pedal press raises the key range in octave steps (up to 3 octaves higher).
OCT DOWN	Each pedal press lowers the key range in octave steps (up to 3 octaves lower).
START/STOP	The song or the rhythm pattern will start/stop.
TAP TEMPO	Tap tempo (a tempo specified by the interval at which you press the pedal).
PROGRAM UP	The next sound number will be selected.
PROGRAM DOWN	The previous sound number will be selected.
FAVORITE UP	The favorite of the next number or bank will be selected.
FAVORITE DOWN	The favorite of the previous number or bank will be selected.
ARP SW	Arpeggio/Rhythm Pattern function on/off
CHORD SW	Chord memory function on/off

7. If you want to keep your settings, press [7 (WRITE)].
8. Press [EXIT] to return to the previous screen.

### Playing Arpeggios ([ARPEGGIO])

#### About Arpeggio Function

The JUNO-STAGE has an Arpeggio function that lets you produce arpeggios automatically; simply press some keys and a corresponding arpeggio will be played automatically.

You can select from various Arpeggio Styles to specify how arpeggios are produced. In addition to the factory-set arpeggio styles, you can also create and use your own original arpeggio styles.

The JUNO-STAGE provides 128 preset arpeggio styles and 128 user arpeggio styles. You are free to rewrite the user arpeggio styles that are provided as the factory settings.

Arpeggio settings are saved as part of each performance; they cannot be saved in a patch.

You can also enjoy performing an ensemble by using arpeggios in conjunction with rhythm patterns (p. 74).

#### Playing by Using Arpeggios

#### Turning Arpeggio On and Off

1. Press [ARPEGGIO] so it's lit.

The Arpeggio function will turn on.

The ARPEGGIO STYLE screen appears.



You can make arpeggio settings in this screen.

To exit the ARPEGGIO STYLE screen, press [EXIT].

2. Play a chord on the keyboard.

The JUNO-STAGE will play an arpeggio, according to the notes forming the chord you have just voiced.

3. To finish playing arpeggios, press [ARPEGGIO] again so it's distinguished.

#### MEMO

If you're in Performance mode and the arpeggio does not sound when you play the keyboard with the Arpeggio function turned on, change the current part so it matches the part that's specified for "Part" (p. 61) in the ARPEGGIO STYLE screen, or turn on the Keyboard Switch (p. 134) for the part that's specified for "Part."

#### Determining the Tempo for Arpeggio Performances

This sets the arpeggio tempo.

1. Press [TAP TEMPO].

The tempo setting window will open.

2. Press [TAP TEMPO] three or more times at the desired tempo.

The tempo will be set to the interval at which you pressed the button.



3. To close the setting window, press [7 (CLOSE)] or [EXIT].

#### TIP

When the tempo setting window is open, you can use the VALUE dial or [DEC] [INC] to directly change the tempo setting.

#### Holding an Arpeggio

By using the following procedure, you can produce arpeggios even without continuing to press the keyboard.

1. Press [ARPEGGIO] to turn on the arpeggio.

The ARPEGGIO STYLE screen appears.

2. Press [2 (HOLD)] to add a check mark (✓).

3. Play a chord on the keyboard.

4. If you play a different chord or notes while the arpeggio is being held, the arpeggio will change accordingly.

5. To cancel Arpeggio Hold, press [2 (HOLD)] once again.

#### When Using a Hold Pedal

If you play an arpeggio while pressing the hold pedal (p. 21), the arpeggio will continue to be played even if you release the chord.

1. Connect an optional pedal switch (DP series etc.) to the HOLD PEDAL jack.

2. Press [ARPEGGIO] to turn on the arpeggio.

3. Play a chord while pressing the hold pedal.

4. If you play a different chord or notes while the arpeggio is being held, the arpeggio will change accordingly.

#### Using in Combination with the Chord Memory Function

When performing with the Arpeggio, you can also use it along with the Chord Memory function (p. 64). After first storing complex Chord Forms in memory, you can then call them up when Arpeggio function is on, and you can easily play complex arpeggio sounds just by pressing a single key.



## Arpeggio Settings

1. Press [ARPEGGIO] so it's lit. Alternatively, hold down [SHIFT] and press [ARPEGGIO].

The ARPEGGIO STYLE screen appears.

**TIP**

By holding down [SHIFT] and pressing [ARPEGGIO], you can access the ARPEGGIO STYLE screen without turning the arpeggio function on/off.

2. Press [▲][▼] to select the parameter.
3. Use the VALUE dial or [DEC][INC] to make the setting.

Parameter	Value	Explanation
(Arpeggio Style)	U001-128 (User), P001-128 (Preset)	This selects the arpeggio's basic performance style. The arpeggio styles are kept in preset memory and user memory.
Grid	1/4, 1/8, 1/8L, 1/8H, 1/12, 1/16, 1/16L, 1/16H, 1/24	This sets the particular note division and resolution in a "single grid" used in creating the arpeggio in an Arpeggio Style, and how much of a "shuffle" syncopation is to be applied (none/weak/strong) to it (grid type). <b>1/4:</b> Quarter note (one grid section = one beat) <b>1/8:</b> Eighth note (two grid sections = one beat) <b>1/8L:</b> Eighth note shuffle Light (two grid sections = one beat, with a light shuffle) <b>1/8H:</b> Eighth note shuffle Heavy (two grid sections = one beat, with a heavy shuffle) <b>1/12:</b> Eighth note triplet (three grid sections = one beat) <b>1/16:</b> Sixteenth note (four grid sections = one beat) <b>1/16L:</b> Sixteenth note shuffle Light (four grid sections = one beat, with a light shuffle) <b>1/16H:</b> Sixteenth note shuffle Heavy (four grid sections = one beat, with a heavy shuffle) <b>1/24:</b> Sixteenth note triplet (six grid sections = one beat) * Grid settings are shared with the rhythm pattern.
Duration	30-120%, Full	This determines whether the sounds are played staccato (short and clipped), or tenuto (fully drawn out). <b>30-120:</b> For example, when set to "30," the length of the note in a grid (or when a series of grids is connected with ties, the final grid) is 30% of the full length of the note set in the grid type. <b>Full:</b> Even if the linked grid is not connected with a tie, the same note continues to sound until the point at which the next new sound is specified. * Duration settings are shared with the rhythm pattern.
Motif	(See p. 62.)	Refer to "Selecting Ascending/Descending Variations (Motif)" (p. 62).
Velocity	REAL, 1-127	Specifies the loudness of the notes that you play. <b>REAL:</b> If you want the velocity value of each note to depend on how strongly you play the keyboard, set this parameter to REAL. <b>1-127:</b> If you want each note to have a fixed velocity regardless of how strongly you play the keyboard, set this parameter to the desired value.
Oct Range	-3+3	This adds an effect that shifts arpeggios one cycle at a time in octave units (octave range). You can set the shift range upwards or downwards (up to three octaves up or down).
Accent	0-100	When you play arpeggios, the velocity of each arpeggiated note is determined by the velocity of the notes programmed within the arpeggio style. You can adjust the amount ("spread") of this dynamic variation. With a setting of "100," the arpeggiated notes will have the velocities that are programmed by the arpeggio style. With a setting of "0," all arpeggiated notes will be sounded at a fixed velocity.
Part (Displayed in Performance mode)	Part 1-16	Here's how to specify the part that will use the arpeggio in Performance mode. You can specify only one part for playing arpeggios. If a rhythm set is assigned to a part in Performance mode, you can play a rhythm set along with the arpeggios. * The part you select here functions for both the arpeggio and the chord memory functions.

4. When you have made the setting, press [5 (EXIT)] or [EXIT].

### About Arpeggio Styles

An Arpeggio Style is a series of data for basic arpeggio patterns and chord styles recorded in the form of a grid consisting of a maximum of 32 steps x 16 pitches.

Each grid contains one of the following kinds of data.

- **ON:** Note On (with velocity data)
- **TIE:** Tie (hold of the previous note)
- **REST:** Rest (no sound played)

The keys that are pressed along with the sequence in which they are pressed is referenced to the "lowest-pitched key during input."

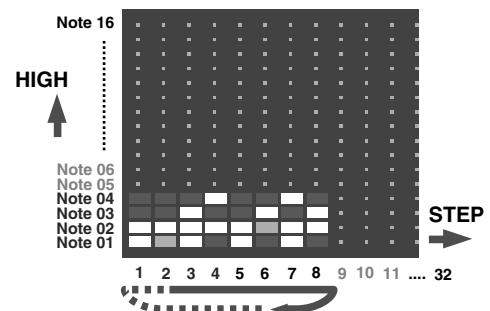

## Chapter 3. Versatile Performance Functions

### Selecting Ascending/Descending Variations (Motif)

This selects the method used to play sounds (motif) when you have a greater number of notes than programmed for the Arpeggio Style.

- \* When the number of keys played is less than the number of notes in the Style, the highest-pitched of the pressed keys is played by default.

Value:	Explanation
Up (L)	Only the lowest of the keys pressed is sounded each time, and the notes play in order from the lowest of the pressed keys.
Up (L&H)	Notes from both the lowest and highest pressed keys are sounded each time, and the notes play in order from the lowest of the pressed keys.
Up ( )	The notes play in order from the lowest of the pressed keys. No one note is played every time.
Down (L)	Only the lowest of the keys pressed is sounded each time, and the notes play in order from the highest of the pressed keys.
Down (L&H)	Notes from both the lowest and highest pressed keys are sounded each time, and the notes play in order from the highest of the pressed keys.
Down ( )	The notes play in order from the highest of the pressed keys. No note is played every time.
U/D (L)	Notes will be sounded from the lowest to the highest key you press and then back down to the lowest key, with only the lowest key sounded each time.
U/D (L&H)	Notes from both the lowest and highest pressed keys are sounded each time, and the notes play in order from the lowest of the pressed keys and then back again in the reverse order.
U/D ( )	The notes play in order from the lowest of the pressed keys, and then back again in the reverse order. No note is played every time.
Rand (L)	Notes will be sounded randomly for the keys you press, with only the lowest key sounded each time.
Rand ( )	Only the lowest of the keys pressed is sounded each time, the notes you press will be sounded randomly. No note will sound each time.
Phrase	Pressing just one key will play a phrase based on the pitch of that key. If you press more than one key, the key you press last will be used.

#### <Example>

Action of a Style starting from the lowest note, "1-2-3-2" when the keys "C-D-E-F-G" are played

- When "UP (L)" is selected as the motif:  
C-D-E-D → C-E-F-E → C-F-G-F (→ repeated)
- When "UP ( )" is selected as the motif:  
C-D-E-D → D-E-F-E → E-F-G-F (→ repeated)
- When "UP&DOWN (L&H)" is selected as the motif:  
C-D-G-D → C-E-G-E → C-F-G-F → C-E-G-E (→ repeated)

### Creating an Arpeggio Style

In addition to using the built-in arpeggio styles, you are free to create your own.

Broadly speaking, there are two ways to create an arpeggio style.

### Step-recording from the Keyboard

In this method, you use the keyboard to step-record your arpeggio. Each time you input a note, you will advance to the next step. This method is convenient when you want to create an arpeggio from scratch using a Style that contains no data.

#### MEMO

If you want to create "from scratch," you'll need to initialize the Style. In the ARPEGGIO STYLE EDIT screen, hold down [SHIFT] and press [5 (INIT)]. A message will ask whether you want to initialize; press [7 (EXEC)] to execute initialization.

1. Press [ARPEGGIO] so it's lit. Alternatively, hold down [SHIFT] and press [ARPEGGIO].

#### TIP

When you hold down [SHIFT] and press [ARPEGGIO], the ARPEGGIO STYLE screen will appear regardless of whether the arpeggio function is on or off.

2. Press [6 (EDIT)].

The ARPEGGIO STYLE EDIT screen appears.



3. Press [2 (SETUP)].

The Arpeggio Setup window appears.

4. Use the cursor buttons to move the cursor to the parameter that you want to edit.

5. Use the VALUE dial or [DEC] [INC] to set the value.

Indication	Value	Explanation
End Step	1-32	Specifies the number of steps.
Input Velocity	REAL, 1-127	Specifies the velocity (strength) of the notes. Choose "REAL" if you want the velocity to be the velocity at which you actually struck the key. Otherwise, you can specify the velocity you like. Some typical values are: p (piano) = 60, mf (mezzo forte) = 90, f (forte) = 120.

6. Press [7 (CLOSE)] to close the Arpeggio Setup window.

### 7. Press [7 (STP REC)] to add a check mark (✓).

Now you're ready to step-record.

- To move to the desired input location, press cursor buttons.
- To input notes, play the keyboard.
- To input a tie, press [3 (TIE)].
- To input a rest, press [4 (REST)].
- To erase the note, hold down [SHIFT] and press [7 (CLR NOTE)].
- To erase all notes at the current step, hold down [SHIFT] and press [6 (CLR STEP)].
- By pressing [5 (PREVU)] to add a check mark (✓) you can listen to the style that you're entering.

#### MEMO

A maximum of sixteen note numbers (pitches) can be used in a single style.

### 8. When you have finished, press [6 (EXIT)].

## Entry Using the VALUE Dial and Buttons

With this method, you use the cursor to specify the step and pitch to input, and use the VALUE dial or [DEC] [INC] to enter the values.

This method is convenient when you need to edit or modify a style that's already been input.

### 1. In the ARPEGGIO STYLE EDIT screen, press [7 (STP REC)] to clear the check mark (✓).

Proceed as follows to input the steps.

- Use the cursor buttons to specify the step and pitch to input.
  - \* When using this method to input, you can't use the keyboard to specify pitches. (You won't be entering notes as you did in Step Recording.)
- Use the VALUE dial or [DEC] [INC] to enter the velocity value. You can enter a tie by turning the VALUE dial all the way to the right (or by pressing [INC] to raise the value all the way).
- You can also enter a tie by pressing [3 (TIE)].
- To enter a rest, press [4 (REST)].
- If you press [5 (PREVU)] to display the check mark (✓), you'll be able to hear the pattern you're inputting.

#### MEMO

A maximum of sixteen different note numbers (pitches) can be used in a single style.

### 2. When you've finishing inputting, press [6 (EXIT)].

You will return to the ARPEGGIO STYLE screen.

## Saving an Arpeggio Style You've Created (WRITE)

An arpeggio style you've created is temporary, and will be lost when you turn off the power or select a different style. If you want to keep a style you've created, you must save it in the JUNO-STAGE's user memory.

#### MEMO

In Performance mode, the arpeggio parameters (Arpeggio Style, Grid, Motif, Duration, etc.) can be saved for each performance (p. 133). These parameters cannot be saved in a patch.

### 1. When you've finished creating an arpeggio style in the ARPEGGIO STYLE EDIT screen, press [EXIT] to access the ARPEGGIO STYLE screen.

### 2. Press [7 (WRITE)].

The ARPEGGIO STYLE NAME screen will appear.



### 3. Assign a name to the arpeggio style.

#### MEMO

For details on assigning a name, refer to p. 44.

### 4. When you've finished assigning the name, press [7 (WRITE)].

A screen in which you can specify the save destination will appear.

### 5. Use the VALUE dial, [DEC] [INC], or [▲] [▼] to specify the save destination.

### 6. Press [7 (WRITE)].

A confirmation message will appear.

If you decide to cancel, press [6 (CANCEL)].

### 7. Press [7 (EXEC)] to save the arpeggio style.

#### NOTE

Never turn off the power while data is being saved.

### Using the Chord Memory Function ([CHORD MEMORY])

#### About the Chord Memory Function

Chord Memory is a function that allows you to play chords based on pre-programmed Chord Forms, just by pressing a single key on the keyboard. The JUNO-STAGE can store 64 preset chord forms and 64 user chord forms. If you wish, you can overwrite any of the 64 user (factory set) chord forms.

The chord memory function operates on the arpeggio part in Performance mode. If a rhythm set is selected for that part, you can also use this to play rhythms.

#### NOTE

When you use the Chord Memory function with a tone for which the Mono/Poly Parameters (p. 101) is Mono, only one sound in the chord is played. When using the Chord Memory function to turn Poly the Mono/Poly Parameters.

#### Performing with the Chord Memory Function

#### Turning Chord Memory Function On and Off

1. Press [CHORD MEMORY] so it's lit.

The Chord Memory function will turn on.  
The CHORD MEMORY screen will appear.



(Example screen in Performance mode)

In this screen you can select a chord form and make settings for the Rolled Chord function.

To exit the CHORD MEMORY screen, press [5 (EXIT)] or [EXIT].

2. Play the keyboard.

A chord will sound according to the currently selected chord form.

When you press the C4 key (Middle C), the chord is played using the exact chord structure recorded in the Chord Form. This is referenced to the C4 key; parallel chords are played by pressing other keys.

3. To finish playing chords, press [CHORD MEMORY] again to turn it off.

#### MEMO

In Performance mode, the Chord Memory function applies to the part played by the arpeggio. In the CHORD MEMORY screen this is shown as "Arpeggio Part (part number)." To change the part that will use the Chord Memory function, go to the ARPEGGIO STYLE screen (p. 61) and change the "Part" setting.

#### Selecting Chord Forms

Changing the chord form will change the notes in the chord.

1. Press [CHORD MEMORY] so it's lit. Alternatively, hold down [SHIFT] and press [CHORD MEMORY].

The CHORD MEMORY screen appears.

#### TIP

By holding down [SHIFT] and pressing [CHORD MEMORY], you can access the CHORD MEMORY screen without turning the chord memory function on/off.

2. Use the VALUE dial or [DEC] [INC] to select a Chord Form number.

U01-64: User

P01-64: Preset

The notes of the chord will be displayed.

To exit the CHORD MEMORY screen, press [5 (EXIT)] or [EXIT].

#### Sounding a Chord in the Order of Its Notes (Rolled Chord)

This causes the notes within a chord to be sounded consecutively, rather than simultaneously. Since the playback speed will change according to the force with which you play the keyboard, you can vary your playing dynamics to create a realistic simulation of playing a guitar.

1. Press [CHORD MEMORY] so it's lit. Alternatively, hold down [SHIFT] and press [CHORD MEMORY].

The CHORD MEMORY screen appears.

#### TIP

By holding down [SHIFT] and pressing [CHORD MEMORY], you can access the CHORD MEMORY screen without turning the chord memory function on/off.

2. Press [2 (ROLL)] to add a check mark (✓).

With this setting, the notes of the chord will be sounded consecutively when you play the keyboard.

#### Changing the Order in Which Notes Are Sounded

You can change the order in which the notes of a chord are sounded.

1. In the CHORD MEMORY screen, use [▲] [▼] to move the cursor to "Rolled Chord Type."

2. Use the VALUE dial or [DEC] [INC] to change a value.

UP: Notes will be sounded in order from bottom to top.

DOWN: Notes will be sounded in order from top to bottom.

ALTERNATE: The order in which the notes are sounded will change each time you play the keyboard.

#### Using in Combination with the Arpeggio Function

When performing with the Chord Form function, you can also use it along with the Arpeggio function (p. 60). After first storing complex Chord Forms in memory, you can then call them up when Arpeggio is on, and you can easily create complex arpeggio sounds just by pressing a single key.

## Creating Your Own Chord Forms

The instrument already provides a large number of chord forms from which you can select. However, you are not limited to these, since you can freely create your own chord forms.

1. Press [CHORD MEMORY] so it's lit. Alternatively, hold down [SHIFT] and press [CHORD MEMORY].

The CHORD MEMORY screen appears.

### TIP

By holding down [SHIFT] and pressing [CHORD MEMORY], you can access the CHORD MEMORY screen without turning the chord memory function on/off.

2. Use the VALUE dial or [DEC] [INC] to select a chord form.

3. Press [6 (EDIT)].

The CHORD MEMORY EDIT screen shown below will appear.



4. Use the keyboard to input the chord that you want to play.

When you press a key, the note will be added in the screen.

- If you input a note by mistake, press [4 (DELETE)]. You can also erase a note you input by pressing the same key.
- If you want to erase all notes, press [3 (ALL DEL)].
- You can press [2 (PREVIEW)] to hear the chord that you are inputting.

5. When you have finished, press [6 (EXIT)].

You will return to the CHORD MEMORY screen.

## Saving the Chord Forms You Have Created (WRITE)

The Chord Forms you create are temporary; they are deleted as soon as you turn off the power or select some other Chord Form. If you want to keep a Chord Form you have made, save it to the JUNO-STAGE's user memory.

### MEMO

In Performance mode, you can save chord forms for each performance (p. 133). Chord forms cannot be saved in patches.

1. In the CHORD MEMORY EDIT screen, create a chord form.

2. Press [7 (WRITE)].

The CHORD NAME screen appears.



3. Assign a name to the Chord Form.

### cf.

For details on assigning names, refer to p. 44.

4. When you have finished inputting the name, press [7 (WRITE)].

A screen will appear, allowing you to select the write-destination Chord Form.

5. Use the VALUE dial, [DEC] [INC], or [▲] [▼] to select the write destination.

6. Press [7 (WRITE)].

A message will ask you for confirmation.

To cancel, press [6 (CANCEL)].

7. To save the Chord Form, press [7 (EXEC)].

### NOTE

Never switch off the JUNO-STAGE while data is being saved.

## Chapter 3. Versatile Performance Functions

### Using the V-LINK ([V-LINK])

#### What is V-LINK?

V-LINK ( **V-LINK** ) is a function that allows music and images to be performed together. By using MIDI to connect two or more V-LINK compatible devices, you can easily enjoy performing a wide range of visual effects that are linked to the expressive elements of a music performance.

For example if you use the JUNO-STAGE in conjunction with EdiroI motion dive .tokyo Performance Package, you'll be able to do the following things.

- Operate the JUNO-STAGE to make the necessary settings for performing with motion dive .tokyo Performance Package.
- Use the JUNO-STAGE's keyboard to switch images in motion dive .tokyo Performance Package.
- Use the JUNO-STAGE's knob to control the brightness and hue of the image.

#### Connection Example

Connect the JUNO-STAGE's MIDI OUT connector to your V-LINK compatible device.

We will use EdiroI motion dive .tokyo Performance Package as an example.

#### NOTE

Before connecting this unit to other devices, turn off the power to all units. This will help prevent malfunctions and/or damage to speakers or other devices.

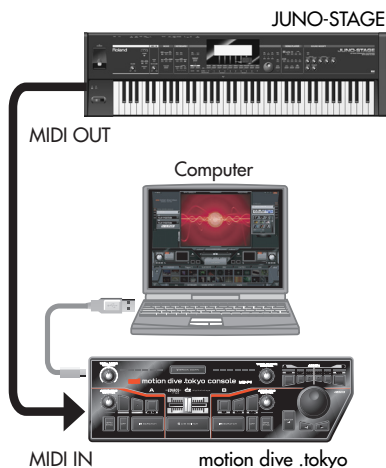

### Turning the V-LINK ON/OFF

1. Press [V-LINK] so it's lit.

The V-LINK screen appears, and the V-LINK setting will be on.



Operations on the JUNO-STAGE

By operating the JUNO-STAGE's keyboard and knobs, you can control the image along with your performance on the JUNO-STAGE.

Button/Knob/Keyboard	Explanation
[5 (CLIP)] (Clip Reset)	Turns the image off (solid black).
[6 (ALL)] (All Reset)	Resets the effect applied to the image, and restores all settings such as brightness and hue to their default values.
[7 (SETUP)]	Accesses the V-LINK SETUP screen.
Black keys	Switch tabs.
White keys	Switch clips.
[CUTOFF] knob	Controls VISUAL PLUG-IN CONTROL.
[RESONANCE] knob	Controls COLOR EQ (Back).
D BEAM controller	Controls the parameter specified in V-LINK setup.

- \* When you turn V-LINK on, the settings in V-LINK setup will take priority for D Beam controller operation.

2. With the V-LINK screen shown, press [V-LINK] again.

The V-LINK button will go dark, and the V-LINK setting will be off.

## V-LINK Settings (V-LINK SETUP)

1. Press [V-LINK] to access the V-LINK screen.

2. Press [7 (SETUP)].

The V-LINK SETUP screen appears.



3. Use [▲] [▼] to move the cursor to the parameter you want to edit.

4. Use the VALUE dial or [DEC] [INC] to set the value.

Parameter	Value	Explanation	
Note Tx Channel A	1-16	Controls the V-LINK device. Specify the MIDI channel. (*)	
Note Tx Channel B			
Note Tx Channel C			
	Assigns a V-LINK function to the D Beam controller.		
	OFF	The operation selected by D BEAM buttons will occur regardless of whether V-LINK is on or off.	
	ColorEQ Fore	CC01 (Modulation)	Used with motion dive .tokyo Performance Package
	ColorEQ Back	CC71 (Resonance)	
	Scratch SW	CC03	
	Speed Knob	CC08 (Balance)	
	Total Fader	CC10 (Panpot)	
	Cross Fader	CC11 (Expression)	
	BPM Sync SW	CC64 (Hold)	
	Clip Loop SW	CC65 (Portamento)	
	Assign Knob	CC72 (Release)	
	Fade Time SW	CC73 (Attack)	
	Visual Knob	CC74 (Cutoff)	
	AB SW	CC81 (General-6)	
	Tap SW	CC83 (General-8)	
	Total Select	CC85	
	FX Select	CC86	
	Play Pos	CC91 (Reverb)	Used with the DV-7PR and similar devices.
	LoopStartPos	CC92 (Tremolo)	
	Loop End Pos	CC93 (Chorus)	
	LayerModeSel	CC94 (Celeste)	
	Dissolve Time	CC73 (Attack)	
	Color Cb Ctrl	CC01 (Modulation)	
	Color Cr Ctrl	CC71 (Resonance)	
	Brightness Ctrl	CC74 (Cutoff)	
	VFX1 Ctrl	CC72 (Release)	
	VFX2 Ctrl	CC91 (Reverb)	
	VFX3 Ctrl	CC92 (Tremolo)	
	VFX4 Ctrl	CC93 (Chorus)	
	Fade Ctrl	CC10 (Panpot)	

\* : On V-LINK compatible devices such as the Edirol DV-7PR/P-1, only Note Tx Channel A is used.

In motion dive .tokyo Performance Package, the Note Tx Channel corresponds as follows.

**A:** The MIDI channel that controls section A

**B:** The MIDI channel that controls section B

**C:** The MIDI channel that controls the MIDI note plug-in

5. If you want to keep your settings, press [7 (WRITE)].

6. Press [6 (EXIT)] or [EXIT] to return to the previous screen.

# Chapter 4. Using the Song Player

The JUNO-STAGE's "SONG PLAYER" has the following two functions. To switch between these two functions, turn [RHYTHM PATTERN] on (the Rhythm Pattern function) or off (the SONG PLAYER function). You can play along on the keyboard to the accompaniment of the music played back by the Song Player.

## Song Player (p. 68)

This plays back songs (audio files or SMF data) saved on USB memory. You can play back songs in an order specified by a "playlist."

### TERM

#### Playlist:

When playing back multiple songs on the JUNO-STAGE, you can create a list to specify the order in which the songs will be played.

### TERM

#### Song list:

This refers to the list of the songs specified in the playlist.

## Rhythm Pattern (p. 74)

This plays back rhythm patterns for a wide variety of musical styles.

### NOTE

You can't use the song player and rhythm patterns at the same time.

## Playing Back Music Files (SONG PLAYER)

The following illustration shows the basic procedure for using JUNO-STAGE's song player to play music files.

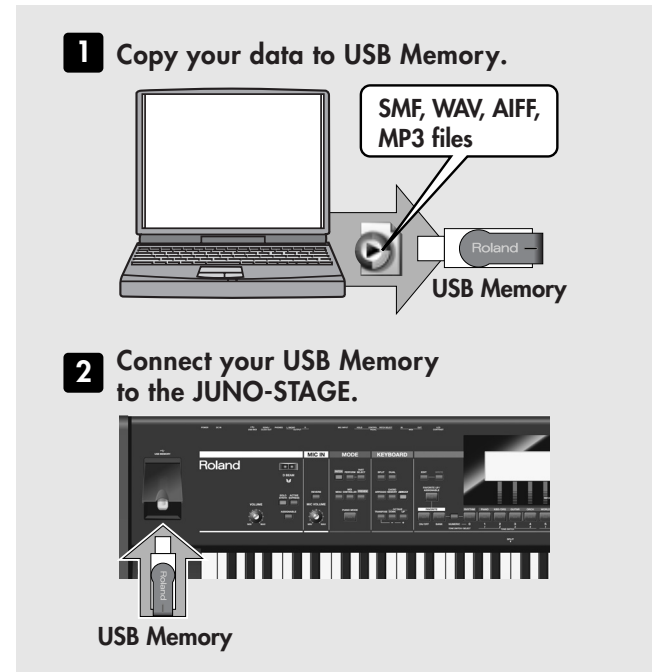

### MEMO

Please use USB memory sold by Roland. We cannot guarantee operation if other products are used.

### NOTE

- Connect your USB memory after you've turned the JUNO-STAGE's power on.
- Never disconnect the USB memory while the power is turned on.
- If there is a large number of songs, it may take ten minutes or more for the data to be loaded from USB memory.

## Creating a Playlist

On your computer, start up the included "Playlist Editor" software and create a playlist. When you want to use the JUNO-STAGE to play backing tracks (accompaniment), it's convenient to create a playlist beforehand to specify the order in which the tracks should be played.

For details on how to create a playlist, refer to the "PlaylistEditorManualE.pdf" that's installed together with "Playlist Editor."

### NOTE

- You'll need to use the included "Playlist Editor" to create playlists. You can't create playlists on the JUNO-STAGE itself.
- You can play back individual songs without creating a playlist. In this case, you'll need to place the SMF or audio files in the root directory of your USB memory.
- Only audio files of a compatible sampling frequency can be played (p. 69). When adding audio files to your playlist, we recommend that you keep their sampling frequency consistent.



## SMF/Audio Files That Can Be Played

SMF		
	<b>Format</b>	0 or 1 * For SMF format 1, there are limitations on the tracks that can be played.
	<b>File size</b>	Maximum of approximately 240 KB (this will change somewhat depending on the content of the SMF)
	<b>System exclusive</b>	Packet size must be 512 or less
Audio files		
WAV/ AIFF	<b>Sampling frequencies</b>	44.1 kHz
	<b>Bit depth</b>	8/16/24-bit
MP3	<b>Format</b>	MPEG-1 audio layer 3
	<b>Sampling frequency</b>	44.1 kHz
	<b>Bit rate</b>	32/40/48/56/64/80/96/112/128/160/192/224/256/320 kbps, VBR (Variable Bit Rate)

## Selecting and Playing a Song ([SONG LIST])

### NOTE

- Performance data from the SMF playback will not be transmitted from the USB MIDI connector.
- Use the JUNO-STAGE in Performance mode when playing SMF.
- If you want to play the keyboard while SMF plays back, first select the performance that you want to play on the keyboard, and then begin playback. Do not switch performances while the SMF is playing.
- If you play back SMF while editing a performance or patch, the contents of the temporary area will be overwritten, and the data you were editing will be lost. If you want to keep the data you were editing, write it before you play back the SMF (p. 97, p. 133).
- You can't perform Write operations or use Utility functions (p. 155) while playing a song.
- Only audio files with a sampling frequency of 44.1 kHz can be played.
- The JUNO-STAGE can handle a maximum of 999 songs or playlists. (The maximum number that can be handled by Playlist Editor is also 999.)

1. **Connect the USB memory containing your playlists and songs to the JUNO-STAGE.**
2. **Press [SONG LIST].**  
The button's indicator will light, and the SONG SELECT screen will appear.

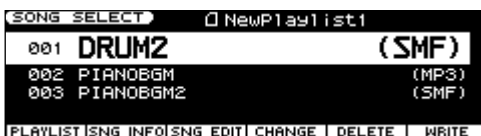





### NOTE

If  is shown at the left of the playlist's name, you can't change the settings of the songs in that playlist.

3. **Use the VALUE dial or [DEC] [INC] to select the song that you want to play.**
4. **Press [PLAY].**  
The selected song will play.  
Press [EXIT] to exit the SONG SELECT screen.
5. **To stop song playback, press [STOP].**  
The next time you press [PLAY], playback will resume from the point at which you stopped.

## Moving the Playback Location

You can use the following buttons to move the playback location.

[  ]	Returns to the beginning of the song. If you press this at the beginning of a song, you'll move to the beginning of the preceding song.
[  ]	Rewinds the song.
[  ]	Fast-forwards the song.
[  ]	Moves to the next song.
[PLAY]	Plays the song.
[STOP]	Stops the song playback.

### NOTE

If you switch the song to be played while you're in a screen other than the SONG SELECT screen (e.g., while you're in PATCH PLAY, PERFORM PLAY, or PART SELECT), it may take several seconds until playback begins.

## Adjusting the Volume of the Song Player

1. **Use LEVEL [  ] [  ] to adjust the volume.**

The volume of the Song Player will change.

**Value:** 0-127

### MEMO

Adjusting this setting will also change the "Song Player Level" setting in the System settings "CLICK/PLAYER" (p. 151).

### MEMO

If you want to adjust the volume of an individual song, refer to "SONG LEVEL EDIT Screen" (p. 71).

## Chapter 4. Using the Song Player

### Changing the Tempo of the Song (SMF)

You can change the playback tempo of SMF songs.

1. **Select the song.**
2. **Press [TAP TEMPO].**  
The tempo setting window will open.
3. **Press [TAP TEMPO] three or more times at the desired tempo.**  
The tempo setting window will open, and the tempo will be set to the interval at which you pressed the button.
4. **To close the setting window, press [7 (CLOSE)] or [EXIT].**

#### TIP

When the tempo setting window is open, you can use the VALUE dial or [DEC] [INC] to directly change the tempo setting.

#### NOTE

Even if an audio file is selected, the tempo setting window will open and the value will be modified, but the tempo of the song will not change.

### SONG SELECT Screen

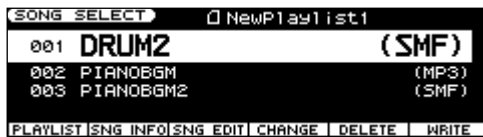

Pressing [SONG LIST] will access the SONG SELECT screen.

The [2]–[7] buttons located below the display will execute the functions shown in the bottom line of the screen.

Press [SONG LIST] once again to turn off its illumination, and you'll exit the SONG SELECT screen.

Function Button	Meaning
[2 (PLAYLIST)]	Displays the PLAYLIST SELECT screen (p. 71).
[3 (SNG INFO)]	Displays information about the currently selected song. → "SONG INFORMATION Screen" (p. 70)
[4 (SNG EDIT)]	Adjusts the volume, etc. of the currently selected song. → "SONG LEVEL EDIT Screen" (p. 71)
[5 (CHANGE)]	Changes the playback order of the currently selected song (p. 72).
[6 (DELETE)]	Deletes the currently selected song from the playlist (p. 72).
[7 (WRITE)]	Saves the edited playlist (p. 73).

### SONG INFORMATION Screen



Use [◀] [▶] to switch the screen.

Press [6 (EXIT)] to return to the SONG SELECT screen.

Indication	Meaning
Title	Song name
Artist	Artist name
Meas/Time (measure/time)	Measure in the song (for SMF) / Time in the song (for an audio file)
File Name	File name
File Type	Type of file (SMF/WAV/AIFF/MP3)
Sampling Rate	Sampling rate Shown if the file type is WAV/AIFF/MP3.
File Size	Size of the file
Memo	Comment, etc.

## SONG LEVEL EDIT Screen

For an SMF song

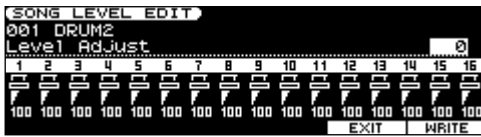

For an audio file song



Adjusts the volume of each song.

Press [6 (EXIT)] to return to the SONG SELECT screen.

### MEMO

If you want to keep the volume setting you've edited, you'll need to save it (p. 73). If you select another playlist without saving your setting, the setting will return to its original state.

Parameter	Values	Explanation
Level Adjust	-12-0-+12	Adjusts the volume in a range of -12-0-+12 relative to the original volume (the volume of the song in USB memory) as 0.
Part 1-16 Level	0-127	If the song's file type is SMF, you can adjust the volume of each part 1-16. Use the cursor buttons to move the cursor to a part number, and use the VALUE dial or [DEC] [INC] to adjust the volume of that part.

## Selecting and Playing a Playlist

Perform the following steps after performing steps 1-3 of "Selecting and Playing a Song ([SONG LIST])" (p. 69).

### 4. Press [2 (PLAYLIST)].

The PLAYLIST SELECT screen will appear.



### 5. Use the VALUE dial or [DEC] [INC] to select the playlist that you want to play.

### 6. Press [PLAY].

The songs in the selected playlist will play in the specified order.

Press [EXIT] to return to the SONG SELECT screen.

### 7. To stop song playback, press [STOP].

The next time you press [PLAY], playback will resume from the location at which you stopped.

## PLAYLIST SELECT Screen



In the SONG SELECT screen (p. 70), pressing [2 (PLAYLIST)] will take you to the PLAYLIST SELECT screen.

The [2]-[7] buttons located below the display will execute the functions shown in the bottom line of the screen.

Press [EXIT] to return to the SONG SELECT screen.

### MEMO

An "\*" is shown if the playlist has been modified. If you want to keep the changes you made, you'll need to save them (p. 73).

Function Button	Meaning
[2 (SELECT)]	Selects the playlist and displays the SONG SELECT screen (p. 70).
[3 (P INFO)]	Displays information about the currently selected playlist. → "PLAYLIST INFORMATION Screen" (p. 72)
[7 (WRITE)]	Saves the edited playlist (p. 73).

## PLAYLIST INFORMATION Screen

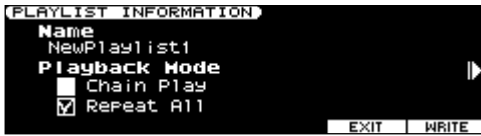

Use [◀] [▶] to switch the screen.

Use [▼] [▲] to move the cursor.

Pressing [6 (EXIT)] will take you back to the SONG SELECT screen.

Indication	Meaning
<b>Name</b>	Playlist name
<b>Playback Mode</b>	<p>Specifies how the songs will play.</p> <p><b>Chain Play</b> If you move the cursor to this item and press [ENTER] to add a check mark (✓), Chain Play will be turned on. If this is on, the songs in the playlist will play consecutively. When the last song finishes playing, playback will stop.</p> <p><b>Repeat All</b> If you move the cursor to this item and press [ENTER] to add a check mark (✓), Repeat All will be turned on. If you turn Repeat All on while Chain Play is on, the instrument will play all songs until the last song in the playlist has been played, then it will return to the first song and continue playing repeatedly. * This item is not shown for playlists that have a [Ⓛ] indication at the left of their playlist name.</p> <p><b>MEMO</b> If you want to keep the changes you made, you'll need to save them (p. 73).</p>
<b>Total Time</b>	<p>The total time (minutes: seconds) of the songs in the playlist * This item is not shown for playlists that have a [Ⓛ] indication at the left of their playlist name.</p>
<b>Total Meas (total measures)</b>	<p>The total number of measures in the songs of the playlist. * This item is not shown for playlists that have a [Ⓛ] indication at the left of their playlist name.</p>
<b>Memo</b>	Comment, etc.

## Changing the Song Order

Here's how to change the order of the currently selected song.

In the SONG SELECT screen (p. 70), press [5 (CHANGE)] to access the Change Order window.

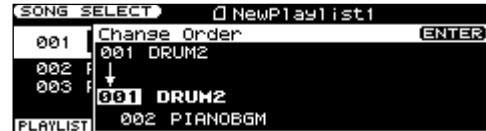

1. Turn the VALUE dial to specify the desired order of the currently selected song.
2. When you've specified the desired position in the playback order, press [ENTER].  
The song order will be changed, and you will return to the SONG SELECT screen.

### NOTE

If you modify the contents of a playlist, an "\*" will be shown. If you want to keep the changes you made, you must save them (p. 73).

## Deleting a Song From the Playlist

Here's how to delete the currently selected song from the playlist.

In the SONG SELECT screen (p. 70), press [6 (DELETE)] to open the following window.

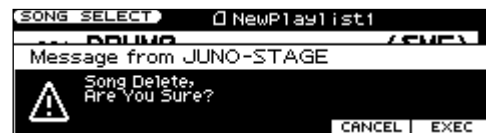

1. To delete the song from the playlist, press [7 (EXEC)].  
If you decide to cancel this operation, press [6 (CANCEL)].  
When the song has been deleted from the playlist, you will return to the SONG SELECT screen.

### NOTE

If you modify the contents of a playlist, an "\*" will be shown. If you want to keep the changes you made, you must save them (p. 73).

## Saving the Settings of the Playlist (WRITE)

Here's how to save the settings of the currently selected playlist.

In the SONG SELECT screen (p. 70), press [7 (WRITE)] to open the following window.

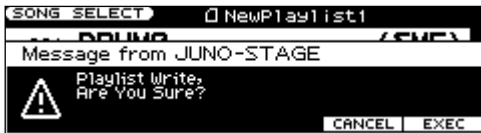

### 1. To save the playlist, press [7 (EXEC)].

If you decide to cancel, press [6 (CANCEL)].

You will return to the SONG SELECT screen.

#### NOTE

It may take several seconds for the data to be saved.

#### NOTE

Never turn off the power while data is being saved.

## Performing Along With a Song ([C. CANCEL/MINUS ONE])

If you use [C. CANCEL/MINUS ONE] when playing back an SMF song, the specified part will be muted (silenced); if you use it when playing back an audio file, the sounds located in the center will be minimized.

This allows you to mute a specific part of a song and play it yourself, or to minimize the vocal or melody of a song while you perform that part.

Depending on the file type of the song, you'll be able to perform the following operations.

File type	Function	Explanation
SMF	Minus-One	Mutes the specified part. For details on specifying the part to be muted, refer to "Detailed Settings for Minus-One (Minus One Setting)" (p. 154).
Audio files	Center cancel	Diminishes the volume of sounds that are located in the center (such as the vocal or the melody instrument). * For some songs, the vocal might not be minimized successfully.

### 1. Press [C. CANCEL/MINUS ONE] so it's lit.

When you play back the song, the specified part will be muted if the song is an SMF. If the song is an audio file, the sounds that are located in the center will be diminished in volume.

### 2. To turn off Minus-One or Center Cancel, press [C. CANCEL/MINUS ONE] so it's extinguished.

## Connecting a Portable Audio Device (EXT INPUT jack)

You can connect an MP3 player or other audio device to the JUNO-STAGE's EXT INPUT jack, and play back songs from it.

If you turn on [C. CANCEL/MINUS ONE], the Center Cancel will be applied to the playback of the device connected to the EXT INPUT jack.

#### MEMO

For details on connections, refer to "Connecting a Portable Audio Device" (p. 21).

## Playing Rhythm Patterns ([RHYTHM PATTERN])

### What is a rhythm pattern?

The JUNO-STAGE contains 256 preset rhythm patterns. Simply by pressing the function buttons ([2]–[7]) you can play a wide variety of rhythm patterns. In addition to using these built-in preset rhythm patterns, you can also create your own.

### What is a rhythm group?

A collection of six rhythm patterns is called a “rhythm group.” The rhythm set used by that group is also remembered as part of these settings.

## Playing Rhythm Patterns

1. Press [RHYTHM PATTERN] so it's lit.

The RHYTHM GROUP screen will appear.

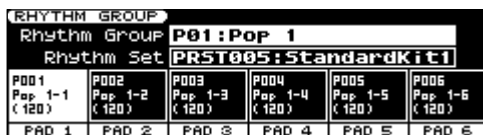

2. Press [2 (PAD 1)]–[7 (PAD 6)].

The rhythm pattern assigned to the button you pressed will begin playing. The indicator of the currently playing rhythm pattern will blink.

#### MEMO

You can make settings in RHYTHM GROUP EDIT (p. 77) to specify which pattern or rhythm set will be played by each button.

3. To stop the pattern playback, press the blinking button or [STOP].  
To exit the RHYTHM GROUP screen, press [EXIT].

## Selecting a Rhythm Pattern

Use the following buttons to select a rhythm pattern to play.

[◀◀]	Selects the previous rhythm group.
[◀]	Selects the previous rhythm pattern within the same rhythm group.
[▶▶]	Selects the next rhythm pattern within the same rhythm group.
[▶]	Selects the next rhythm group.

## Adjusting the Volume of the Rhythm Pattern

1. Use LEVEL [▼] [▲] to adjust the volume.

The volume of the rhythm pattern will change.

#### MEMO

Changing this setting will also affect the rhythm pattern's Velocity (p. 75).

#### MEMO

In Performance mode, this setting is saved for each performance.

## Changing the Tempo of the Rhythm Pattern

Here's how to change the tempo of the rhythm pattern.

1. Press [TAP TEMPO].

The tempo setting window will open.

2. Press [TAP TEMPO] three or more times at the desired tempo.

The tempo will be set to the interval at which you pressed the button.



3. To close the setting window, press [7 (CLOSE)] or [EXIT].

#### TIP

When the tempo setting window is open, you can use the VALUE dial or [DEC] [INC] to directly change the tempo setting.

## Selecting a Rhythm Group/Rhythm Set

1. Press [RHYTHM PATTERN] so it's lit.

The RHYTHM GROUP screen will appear.

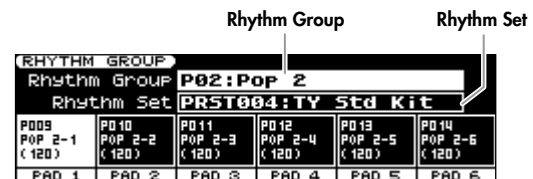

2. Use the cursor buttons to move the cursor to the rhythm group.
3. Use the VALUE dial or [DEC] [INC] to select a rhythm group.

This selects the basic playing style of the rhythm group.

U01–32: User

P01–26: Preset

When you select a rhythm group, the most suitable rhythm set will be selected.

4. Use the cursor buttons to move the cursor to the rhythm set.

5. Use the VALUE dial or [DEC] [INC] to select a rhythm set.

USER001–032: User

PRST001–032: Preset

GM001–009: Preset (GM)

XP-A 001–: Expansion board

XP-B 001–: Expansion board

## Editing a Rhythm Pattern

### RHYTHM PATTERN Screen



From the RHYTHM GROUP screen, hold down [SHIFT] and press [3] (RHY PTN)] to access the RHYTHM PATTERN screen.

Use the cursor buttons to move the cursor to the parameter you want to edit, and use the VALUE dial or [DEC] [INC] to edit its value.

The [2]–[7] buttons located below the display will execute the functions shown in the bottom line of the screen.

Press [2 (RHY GRP)] or [EXIT] to return to the RHYTHM GROUP screen.

Parameter	Values	Explanation
<b>(Rhythm Pattern)</b>	U001–256 (user), P001–256 (preset)	This selects the rhythm's basic playing style
<b>Grid</b>	1/4, 1/8, 1/8L, 1/8H, 1/12, 1/16, 1/16L, 1/16H, 1/24	<p>This specifies the time signature of the rhythm pattern and the amount of "shuffle"</p> <p>This specifies the note value considered as "one grid section," and the amount of "shuffle" (none, weak, or strong)</p> <p><b>1/4:</b> Quarter note (one grid section = one beat)</p> <p><b>1/8:</b> Eighth note (two grid sections = one beat)</p> <p><b>1/8L:</b> Eighth note shuffle Light (two grid sections = one beat, with a light shuffle)</p> <p><b>1/8H:</b> Eighth note shuffle Heavy (two grid sections = one beat, with a heavy shuffle)</p> <p><b>1/12:</b> Eighth note triplet (three grid sections = one beat)</p> <p><b>1/16:</b> Sixteenth note (four grid sections = one beat)</p> <p><b>1/16L:</b> Sixteenth note shuffle Light (four grid sections = one beat, with a light shuffle)</p> <p><b>1/16H:</b> Sixteenth note shuffle Heavy (four grid sections = one beat, with a heavy shuffle)</p> <p><b>1/24:</b> Sixteenth note triplet (six grid sections = one beat)</p> <p>* The Grid setting is shared with the arpeggio setting (p. 61).</p>

Parameter	Values	Explanation
<b>Duration</b>	30–120%, Full	<p>This specifies the duration of each note in the rhythm pattern.</p> <p>You can specify whether each note will have a short duration for a staccato feel, or an extended duration for a tenuto feel.</p> <p><b>30–120:</b> For example, if you set this to "30," the duration of a note in the grid (or if notes in the grid are connected by a tie, the duration of the last note) will be 30% of the note value specified by the grid type.</p> <p><b>Full:</b> Even if consecutive grid sections are not connected by a tie, the note will continue to sound until the next occurrence of the same note.</p> <p>* The Duration setting is shared with the arpeggio setting (p. 61).</p> <p>* This will have no effect if Tone Env Mode (p. 124) is set to "NO-SUS."</p>
<b>Velocity</b>	1–127	This specifies the loudness of the notes in the rhythm pattern.
<b>Accent</b>	0–100	<p>This specifies the strength of the accents in the rhythm pattern.</p> <p>If this is set to "100," accents will be added to the notes according to the velocities specified for the notes in the rhythm pattern. If this is set to "0," all notes will be sounded at a fixed velocity.</p>

### Function Button Operations

Function Button	Content
[2 (RHY GRP)]	Displays the RHYTHM GROUP screen (p. 77).
[3 (RHY PTN)]	(The current page)
[5 (PREVU)]	Each time you press this button, the check mark will be added or removed. When you add a check mark, the selected rhythm pattern will play.
[6 (PTN EDIT)]	Allows you to edit a rhythm pattern. → RHYTHM PATTERN EDIT screen (p. 76)
[7 (WRITE)]	Saves the rhythm pattern (p. 78).

## Creating a Rhythm Pattern

In addition to using the preset rhythm patterns that are provided, you can freely create your own rhythm patterns.

You can create a rhythm pattern either by step-recording from the keyboard or by using the VALUE dial and buttons to enter data.

It's convenient to enter notes from the keyboard if you're creating a new rhythm pattern from scratch rather than creating one based on an existing pattern. Conversely, it's convenient to use the dial or buttons to enter notes if you're editing an existing rhythm pattern.

## Initializing a Rhythm Pattern

If you're creating a rhythm pattern from scratch (rather than starting with an existing rhythm pattern), you'll begin by initializing a rhythm pattern.

1. In the RHYTHM PATTERN screen, press [6 (PTN EDIT)].

The RHYTHM PATTERN EDIT screen will appear.



2. Hold down [SHIFT] and press [5 (INIT)].

A confirmation message will appear.

Initialization will be cancelled if you press [6 (CANCEL)].

3. Press [7 (EXEC)].

The rhythm pattern will be initialized.

## Step-recording from the Keyboard

1. In the RHYTHM PATTERN EDIT screen, press [2 (SETUP)].

The Rhythm Setup window will open.

2. Use the cursor buttons to move the cursor to the parameter you want to edit.

3. Use the VALUE dial or [DEC] [INC] to set the value.

Indication	Values	Explanation
End Step	1-32	Specifies the number of steps.
Input Velocity	REAL, 1-127	Specifies the velocity of the notes. Choose "REAL" if you want to enter the velocity at which you actually pressed the key. Otherwise, specify the desired velocity; p (piano) = 60, mf (mezzo forte) = 90, f (forte) = 120.

4. Press [7 (CLOSE)] to close the Rhythm Setup window.

You will return to the RHYTHM PATTERN EDIT screen.

5. Press [7 (STP REC)] to make the check mark (✓) appear.

Now you're ready to perform step recording.

Proceed with step recording as follows.

- Use cursor buttons to move to the location at which you want to enter a note.
- The tones of the rhythm set selected in the RHYTHM GROUP screen will be assigned to the keyboard. Use the keyboard to enter notes.
- Press [3 (TIE)] to enter a tie.
- Press [4 (REST)] to enter a rest.
- To delete a note, hold down [SHIFT] and press [7 (CLR NOTE)].
- To delete all notes at the current step, hold down [SHIFT] and press [6 (CLR STEP)].
- To preview the pattern you're inputting, press [5 (PREVU)] to display a check mark (✓).

### MEMO

A maximum of sixteen rhythm tone can be used in one pattern.

6. When you're finished inputting, press [6 (EXIT)].

## Using the Dial and Buttons for Entry

In this method, you'll use the cursor buttons to specify the step and tone to be input, and use the VALUE dial or [DEC] [INC] to specify the velocity of the note.

This method is convenient when you're editing or modifying an existing pattern.

1. In the RHYTHM PATTERN EDIT screen, press [7 (STP REC)] to clear the check mark (✓).

Proceed with step recording as follows.

- Use cursor buttons to specify the step and tone that you want to enter.
- \* When using this method for entry, the keyboard can't be used to specify the tone. (Unlike the case when step-recording, the keyboard won't enter notes.)
- Use the VALUE dial or [DEC] [INC] to enter the velocity value. By turning the VALUE dial all the way to the right (or using [INC] to raise the value all the way), you can enter a tie.
- You can also enter a tie by pressing [3 (TIE)].
- To enter a rest, press [4 (REST)].
- To preview the pattern you're inputting, press [5 (PREVU)] to display a check mark (✓).

### MEMO

A maximum of sixteen rhythm tone can be used in one pattern.

2. When you're finished inputting, press [6 (EXIT)].



## Saving a Rhythm Pattern (WRITE)

The rhythm pattern you've created is temporary, and will be lost if you turn off the power or select a different pattern. If you want to keep the pattern you've created, save it in internal memory.

1. After creating a rhythm pattern in the RHYTHM PATTERN EDIT screen, press [EXIT] to access the RHYTHM PATTERN screen.

2. Press [7 (WRITE)].

The RHYTHM PATTERN NAME screen will appear.



3. Assign a name for the rhythm pattern.

**cf.** →

For details on assigning a name, refer to p. 44.

4. When you've finished assigning the name, press [7 (WRITE)].

A screen in which you can specify the save destination will appear.

5. Use the VALUE dial, [DEC] [INC], or [▲] [▼] to select the save destination.

6. Press [7 (WRITE)].

A confirmation message will appear.

If you decide to cancel, press [6 (CANCEL)].

7. Press [7 (EXEC)] to save the data.

### NOTE

Never turn off the power while data is being saved.

## Creating a Rhythm Group

In addition to using the rhythm groups that are provided, you can create your own rhythm groups.

1. Press [RHYTHM PATTERN] so it's lit.

The RHYTHM GROUP screen will appear.

2. Use the cursor buttons to move the cursor to the rhythm group number.

3. Use the VALUE dial or [DEC] [INC] to select the rhythm group that you want to edit.

4. Hold down [SHIFT] and press [6 (GRP EDIT)].

The RHYTHM GROUP EDIT screen will appear.



5. Use [◀] [▶] to select the rhythm pattern that you want to edit.

### TIP

When the RHYTHM GROUP EDIT screen is displayed, you can use [◀◀] [▶▶] to switch rhythm groups and [◀◀◀] [▶▶▶] to switch rhythm patterns.

6. Use [▲] [▼] to select a parameter.

7. Use the VALUE dial or [DEC] [INC] to edit the value.

Parameter	Values	Explanation
Pattern	U001–256, P001–256	Rhythm pattern that will be played by the function button
Rhythm Set	USER: 001–032, PRST: 001–032, GM: 001–009, XP-A 001–, XP-B 001–	Rhythm set that will be used

### MEMO

To audition the selected rhythm pattern, press [5 (PREVU)] to display a check mark (✓).

To exit the RHYTHM GROUP EDIT screen, press [6 (EXIT)].

### Saving a Rhythm Group You've Created (WRITE)

A rhythm group you've created is temporary, and will be lost if you turn off the power or select another group. If you want to keep the rhythm group you've created, you must save it to internal user memory.

1. In the RHYTHM GROUP EDIT screen, create a rhythm group.
2. In the RHYTHM GROUP EDIT screen, press [7 (WRITE)].  
The RHYTHM GROUP NAME screen will appear.

#### MEMO

You can also access the RHYTHM GROUP NAME screen from the RHYTHM GROUP screen by holding down [SHIFT] and pressing [7 (WRITE)].



3. Assign a name to the rhythm group.

#### cf.

For details on assigning a name, refer to p. 44.

4. When you've finished assigning a name, press [7 (WRITE)].  
A screen in which you can select the save destination will appear.
5. Use the VALUE dial, [DEC] [INC], or [▲] [▼] to select the save destination.
6. Press [7 (WRITE)].  
A confirmation message will appear.  
If you decide to cancel, press [6 (CANCEL)].
7. Press [7 (EXEC)] to save the data.

#### NOTE

Never turn off the power while data is being saved.

#### MEMO

The rhythm group setting can be saved as part of each performance. Press [WRITE] to save the setting in the performance (p. 133).

### Listening to a Click in Time with the Tempo (SONG/CLICK OUT jack)

When playing back an SMF song, you can use headphones connected to the SONG/CLICK OUT jack on the rear panel to monitor a click sound.



Stereo Headphones

If you're playing back an audio file (rather than an SMF song), only the sound of the song will be output.

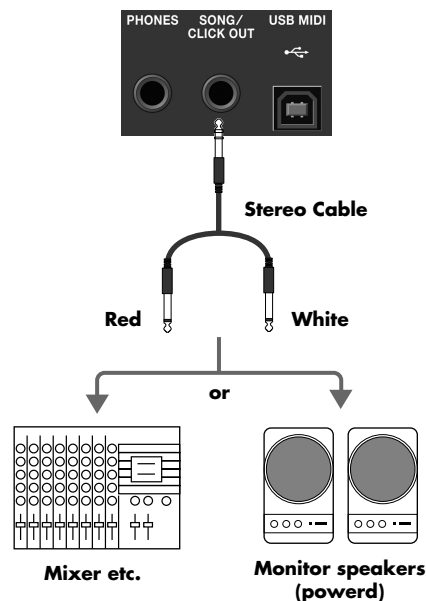

This is convenient when someone will be playing along on the drums while using the JUNO-STAGE's song player to play back a song.

#### MEMO

You can make detailed settings for the volume and tone of the click sound that is output from the SONG/CLICK OUT jack, and also specify what will be output from the SONG/CLICK OUT jack. For details, refer to "[2 (CLICKOUT)]" (p. 151).

#### TIP

By holding down [SHIFT] and pressing [TAP TEMPO] you can access a screen where you can make settings for the click sound. For details on the settings, refer to "System Menu [5 (CLICK/PLAYER)]" (p. 151).

# Chapter 5. Applying Effects to the Sound

## Applying Effects

### How Effects are Handled in Each Mode

#### Patch mode (p. 80)

In Patch mode, you can apply multi-effects (MFX), chorus, and reverb to each patch or rhythm set; the same effect will be applied to each tone.

By adjusting the amount of signal that is sent from each tone to each effect, you can control the depth of the effect for each tone.

The patch or rhythm set's effect settings that you edit will be lost when you select a different patch or rhythm set. If you want to keep your edited settings, press [WRITE] to save the patch or rhythm set settings as a user patch (p. 97, p. 123).

#### Performance mode (p. 82)

In Performance mode, you can apply three multi-effects ((MFX1, MFX2, MFX3), one chorus, and one reverb to each performance.

The three multi-effects, chorus, and reverb can each operate according to the effect settings of the performance, or according to the effect settings of the patch or rhythm set assigned to the part you specify.

In addition, the three multi-effects can not only be used individually but also as a combination of multi-effects.

The effect settings of a performance you edit will be lost when you select a different performance. If you want to keep your edited settings, press [WRITE] to save the performance settings as a user performance (p. 133).

**cf.**

"About the Effects" (p. 40) in "Chapter 1. Overview."

### Turning Effects On/Off (Effect Switch)

The JUNO-STAGE's onboard effects can be switched on/off as a whole. Turn these OFF when you want to listen to the unprocessed sound as you create a sound, or if you want to use an external effects processor instead of the built-in effects.

#### NOTE

The effect on/off settings cannot be saved.

1. Press [EDIT].
2. Press [6 (EFFECT EDIT)], or use the VALUE dial or [◀][▶] to select "EFFECT EDIT" and then press [ENTER].  
The EFFECT ROUTING screen will appear.

3. Press [7 (SWITCH)].  
The EFFECT SWITCH window will appear.



(Example screen in Performance mode)

4. Press [2 (MFX)]-[6 (REVERB)] to turn each effect on/off.  
The effect will turn on/off each time you press the button.
5. To close the setting window, press [7 (CLOSE)] or [EXIT].  
You will return to the EFFECT ROUTING screen.

### Making Effect Settings

1. In the appropriate mode, select the patch or performance to which you want to apply effects.
2. Press [EDIT].
3. Press [6 (EFFECT EDIT)], or use the VALUE dial or [◀][▶] to select "EFFECT EDIT" and then press [ENTER].  
The EFFECT ROUTING screen will appear.
4. Press [2 (ROUTING)]-[6 (REVERB)] to select the effect for which you want to make settings.  
If you're in Performance mode and you've selected [3 (MFX)], you can additionally press [2 (MFX1)]-[4 (MFX3)] to select the effect that you want to edit.



(Example of MFX1 screen in Performance mode)

5. With the cursor located at the top line of the screen, use the VALUE dial or [DEC] [INC] to select the desired effect type.
6. Use the cursor buttons to move the cursor to the parameter that you want to edit.
7. Use the VALUE dial or [DEC] [INC] to edit the value.
8. When you've finished editing, press [EXIT].

## Chapter 5. Applying Effects to the Sound

### Applying Effects in Patch Mode

In Patch mode you can use one multi-effect (MFX), one chorus, and one reverb.

#### Signal Flow and Parameters (EFFECT ROUTING)

Here you can make overall settings for effects, such as the output destination and level of the various signals.

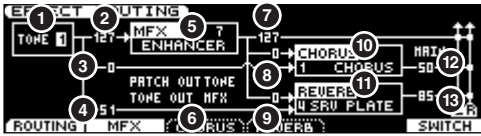

cf.

For details on how to make settings, refer to “Making Effect Settings” (p. 79).

Parameter	Range	Explanation
<b>1</b> Tone Select (Rhythm Key Select)	1–4 (A0–C8)	The tone (rhythm tone) to edit If you’ve selected a rhythm set, this will be Rhythm Key Select.
<b>2</b> Tone Output Level	0–127	Level of signal sent from each tone to the destination specified by Output Assign ( <b>6</b> )
<b>3</b> Tone Chorus Send Level	0–127	Level of signal sent from each tone to the chorus
<b>4</b> Tone Reverb Send Level	0–127	Level of signal sent from each tone to the reverb
<b>5</b> MFX Type	0–79	Type of multi-effect to use (choose one of 79 types) For details on each multi-effect, refer to “Multi-Effects Parameters (MFX1–3, MFX)” (p. 163).
<b>6</b> Patch Output Assign (Rhythm Output Assign)	MFX, L+R, L, R, TONE	Specifies how the unprocessed sound of the patch (rhythm set) will be output If you’ve selected a rhythm set, this will be Rhythm Output Assign. <b>MFX:</b> Output in stereo via the multi-effect. Chorus and reverb can also be applied after the multi-effect. <b>L+R:</b> Output in stereo from the OUTPUT jacks without passing through the multi-effect <b>L:</b> Output in mono from the OUTPUT L jack without passing through the multi-effect <b>R:</b> Output in mono from the OUTPUT R jack without passing through the multi-effect <b>TONE:</b> Output according to the settings of each tone
<b>6</b> Tone OUTPUT Assign	MFX, L+R, L, R	Specifies how the unprocessed sound of each tone will be output <b>MFX:</b> Output in stereo via the multi-effect. Chorus and reverb can also be applied after the multi-effect. <b>L+R:</b> Output in stereo from the OUTPUT jacks without passing through the multi-effect <b>L:</b> Output in mono from the OUTPUT L jack without passing through the multi-effect <b>R:</b> Output in mono from the OUTPUT R jack without passing through the multi-effect * The setting you specify here is valid only if Patch Output Assign is set to “TONE.” * If Structure (p. 99) is set to TYPE 02–10, the settings for tone 1 (3) will follow the settings of tone 2 (4). (This is because the outputs of tones 1 and 2 are combined into tone 2, and the outputs of tones 3 and 4 are combined into tone 4.)
<b>7</b> MFX Output Level	0–127	Volume of the sound that has been processed by the multi-effect
<b>8</b> MFX Chorus Send Level	0–127	Amount of chorus applied to the sound that has been processed by the multi-effect
<b>9</b> MFX Reverb Send Level	0–127	Amount of reverb applied to the sound that has been processed by the multi-effect
<b>10</b> Chorus Type	0–3	Type of chorus <b>0 (OFF):</b> Chorus/delay will not be used <b>1 (CHORUS):</b> Chorus <b>2 (DELAY):</b> Delay <b>3 (GM2 CHO):</b> GM2 chorus

Parameter	Range	Explanation
<b>11</b> Reverb Type	0–5	Type of reverb <b>0 (OFF):</b> Reverb will not be used <b>1 (REVERB):</b> Basic reverb <b>2 (SRV ROOM):</b> Reverb that simulates the reverberation of a room in greater detail <b>3 (SRV HALL):</b> Reverb that simulates the reverberation of a hall in greater detail <b>4 (SRV PLATE):</b> Simulation of a plate echo (a reverb device that uses a metal plate) <b>5 (GM2 REV):</b> GM2 reverb
<b>12</b> Chorus Output Select	MAIN, REV, M+R	Output destination of the sound that has been processed by the chorus <b>MAIN:</b> Output in stereo to the OUTPUT jacks <b>REV:</b> Output in mono to reverb <b>M+R:</b> Output in stereo to the OUTPUT jacks and in mono to the reverb
<b>12</b> Chorus Level	0–127	Volume of the sound that has been processed by the chorus
<b>13</b> Reverb Level	0–127	Volume of the sound that has been processed by the reverb

## Chapter 5. Applying Effects to the Sound

### Applying Effects in Performance Mode

In Performance mode you can use three multi-effects (MFX1, MFX2, MFX3), one chorus, and one reverb. The three multi-effects, chorus, and reverb can each use the effect settings of the performance, or the effect settings of the patch or rhythm set assigned to the specified part.

In addition, the three multi-effects can not only be used individually but also as a combination of multi-effects.

### Signal Flow and Parameters (EFFECT ROUTING)

Here you can make overall settings for effects, such as the output destination and level of the various signals.

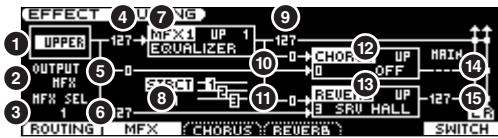

cf. ➔

For details on how to make settings, refer to “Making Effect Settings” (p. 79).

\* The parameters listed below in 7, 9 – 11 can be edited for each of the three multi-effects (MFX1–MFX3).

Parameter	Range	Explanation
1 Part Select	UPPER (PART 1), LOWER (PART 2), PART 3–16	The part for which to make settings
2 Part Output Assign	MFX, L+R, L, R, PAT	Specifies how the unprocessed sound of each part will be output <b>MFX:</b> Output in stereo via the multi-effect. Chorus and reverb can also be applied after the multi-effect. <b>L+R:</b> Output in stereo from the OUTPUT jacks without passing through the multi-effect <b>L:</b> Output in mono from the OUTPUT L jack without passing through the multi-effect <b>R:</b> Output in mono from the OUTPUT R jack without passing through the multi-effect <b>PAT:</b> Output according to the settings of the patch or rhythm set that’s assigned to the part
3 Part Output MFX Select	1–3	Multi-effect used by the part (choose one of MFX 1–3)
4 Part Output Level	0–127	Level of signal sent to the destination specified by Part Output Assign
5 Part Chorus Send Level	0–127	Level of signal sent from each part to the chorus
6 Part Reverb Send Level	0–127	Level of signal sent from each part to the reverb
7 MFX Source	PRF, UP (P1), LO (P2), P3–P16	Multi-effect parameter settings used by the performance <b>PRF:</b> Use the multi-effect settings of the performance <b>UP (P1)–P16:</b> Use the multi-effect settings of the patch or rhythm set assigned to the specified part
	MFX Type	0–79 Type of multi-effect to use (choose one of 79 types) For details on each multi-effect, refer to “Multi-Effects Parameters (MFX1–3, MFX)” (p. 163).
8 MFX Structure	1–16	How MFX 1–3 will be combined (p. 86)
9 MFX Output Level	0–127	Volume of the sound that has been processed by the multi-effect
10 MFX Chorus Send Level	0–127	Amount of chorus applied to the sound that has been processed by the multi-effect
11 MFX Reverb Send Level	0–127	Amount of reverb applied to the sound that has been processed by the multi-effect

Parameter	Range	Explanation
<b>12</b>	<b>Chorus Source</b>	PRF, UP (P1), LO (P2), P3–P16  Chorus parameter settings used by the performance <b>PRF:</b> Use the chorus settings of the performance <b>UP (P1)–P16:</b> Use the chorus settings of the patch or rhythm set assigned to the specified part
	<b>Chorus Type</b>	0–3  Type of chorus <b>0 (OFF):</b> Chorus/delay will not be used <b>1 (CHORUS):</b> Chorus <b>2 (DELAY):</b> Delay <b>3 (GM2 CHO):</b> GM2 chorus
<b>13</b>	<b>Reverb Source</b>	PRF, UP (P1), LO (P2), P3–P16  Reverb parameter settings used by the performance <b>PRF:</b> Use the reverb settings of the performance <b>UP (P1)–P16:</b> Use the reverb settings of the patch or rhythm set assigned to the specified part
	<b>Reverb Type</b>	0–5  Type of reverb <b>0 (OFF):</b> Reverb will not be used <b>1 (REVERB):</b> Basic reverb <b>2 (SRV ROOM):</b> Reverb that simulates the reverberation of a room in greater detail <b>3 (SRV HALL):</b> Reverb that simulates the reverberation of a hall in greater detail <b>4 (SRV PLATE):</b> Simulation of a plate echo (a reverb device that uses a metal plate) <b>5 (GM2 REV):</b> GM2 reverb
<b>14</b>	<b>Chorus Output Select</b>	MAIN, REV, M+R  Output destination of the sound that has been processed by the chorus <b>MAIN:</b> Output in stereo to the OUTPUT jacks <b>REV:</b> Output in mono to reverb <b>M+R:</b> Output in stereo to the OUTPUT jacks and in mono to the reverb
	<b>Chorus Level</b>	0–127  Volume of the sound that has been processed by the chorus
<b>15</b>	<b>Reverb Level</b>	0–127  Volume of the sound that has been processed by the reverb

### **If you've specified a part number as the MFX Source, Chorus Source, or Reverb Source**

If you specify a part number as a Source so that the settings of the patch or rhythm set will be used, those settings will be shown in the effect setting screen of the performance, and can be edited.

If you want to keep the changes you made, press [WRITE] to save the settings of the patch or rhythm set (p. 97, p. 123). Then you must also save the settings of the performance (p. 133).

## Chapter 5. Applying Effects to the Sound

### Multi-Effect Settings (MFX 1–3)

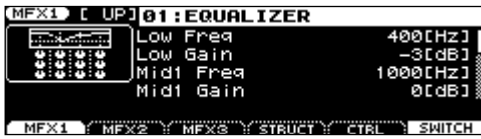

From the EFFECT ROUTING screen (p. 82), press [3 (MFX)] to access the MFX screen. Use the cursor buttons to move the cursor to the parameter that you want to edit, and use the VALUE dial or [DEC] [INC] to choose the desired value.

Parameter	Range	Explanation
(MFX Type)	00: THRU– 79: VOCODER	Selects the type of multi-effect used by MFX. Choose “00: THRU” if you don’t want to apply a multi-effect.
Parameters for each MFX type	Edit the parameters of the MFX type you’ve selected. Refer to “Multi-Effects Parameters (MFX1–3, MFX)” (p. 163).	

### Controlling a Multi-Effect via MIDI (MFX 1–3 CTRL)

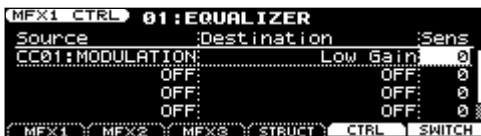

In the MFX screen (p. 84) (or the MFX STRUCTURE screen (p. 86), press [4 (CTRL)] if you’re in Patch mode or [6 (CTRL)] if you’re in Performance mode. The MFX CTRL screen will appear.

Use the cursor buttons to move the cursor to the parameter you want to edit, and use the VALUE dial or [DEC] [INC] to specify the value.

In Performance mode, pressing [6 (CTRL)] one or more times in the MFX CTRL screen allows you to select the multi-effect (MFX1, MFX2, or MFX3) that you want to edit.

#### Multi-Effect Control

In order to control the multi-effect’s volume or delay time from an external MIDI device, you would normally need to transmit system exclusive messages (MIDI messages that are specific to the JUNO-STAGE). However, system exclusive messages are more complex to set up, and require a larger amount of data to be transmitted.

For this reason, the JUNO-STAGE allows you to use control changes and other common MIDI messages to control the most important multi-effect parameters.

For example, you might use the pitch bend lever to control the degree of distortion, or use keyboard touch to change the delay time. The parameters that can be controlled in this way are predetermined for each type of multi-effect; such parameters are indicated by a “#” in the parameter lists in “Multi-Effects Parameters (MFX1–3, MFX)” (p. 163).

“Multi-effect control” is the capability of using MIDI messages in this way to control multi-effect parameters in real time. You can specify up to four multi-effect control assignments for each MFX 1–3.

In order to use multi-effect control, you’ll need to specify which MIDI message (Source) will control which parameter (Destination) by what amount (Sens).

#### TIP

As a substitute for multi-effect control, you can also use matrix control (p. 110) to control important multi-effect parameters in real time.



Parameter	Range	Explanation
<b>Source (1–4)</b> (Control Source)	OFF, CC01–31, CC33–95, PITCH BEND, AFTERTOUCHE, SYS CTRL 1–4	Specifies the MIDI message that will control the corresponding MFX control parameter. <b>OFF:</b> MFX will not be used. <b>CC01–31:</b> Controller number 1–31 <b>CC33–95:</b> Controller number 33–95 <b>PITCH BEND:</b> Pitch bend <b>AFTERTOUCHE:</b> Aftertouch <b>SYS CTRL 1–4:</b> Use the controller that is assigned by the System setting Sys Ctrl 1–4 Source (p. 148).
<b>Destination (1–4)</b> (Control Destination)	Refer to “Multi-Effects Parameters (MFX1–3, MFX)” (p. 163)	Selects the multi-effect parameter that will be controlled by control source 1–4. The type of parameters that can be selected will depend on the type of multi-effect you’ve selected in MFX Type.
<b>Sens (1–4)</b> (Control Sensitivity)	-63–+63	Specifies the depth of multi-effect control. Specify a positive (+) value if you want to change the value of the assigned destination in a positive direction (larger, toward the right, faster, etc.), or specify a negative value (-) if you want to change the value in a negative direction (smaller, toward the left, slower, etc.). Larger values will allow a greater amount of control.
<b>MFX Control Channel</b>	1–16, OFF	Specify the reception channel that will be used when using MFX control to control the multi-effect parameter in real time, when MFX 1–3 Source (p. 82) is set to “PRF.” Leave this “OFF” if you’re not using MFX control. * This parameter is not available in Patch mode.

**MEMO**

A patch or rhythm set contains parameters that specify whether pitch bend, controller number 11 (expression), and controller number 64 (hold 1) will be received for each tone or rhythm tone (p. 112, p. 124). If these settings are “ON,” receiving that MIDI message will not only change the setting of the assigned destination parameter, but will also apply the corresponding pitch bend, expression, or hold 1 effect. Leave them “OFF” if you only want to control the multi-effect parameter.

**MEMO**

A performance contains parameters that specify whether specific MIDI messages will be received for each MIDI channel (p. 138). If you want to use multi-effect control, make sure that reception is enabled for the corresponding MIDI message. If MIDI messages cannot be received, multi-effect control will not work.

## Chapter 5. Applying Effects to the Sound

### Specifying How Multi-Effects are Combined (MFX STRUCTURE)

Here you can specify how MFX 1–3 will be combined.

#### MEMO

This parameter does not exist in Patch mode.



In the MFX screen (p. 84) or MFX CTRL screen (p. 84), press [5 (STRUCT)] to access the MFX STRUCTURE screen.

Use the cursor buttons to move the cursor to the parameter that you want to edit, and use the VALUE dial or [DEC] [INC] to set the value.

Parameter	Range	Explanation
MFX Structure	TYPE01–TYPE16	Specifies how MFX 1–3 will be combined
MFX1–3	00 (THRU)–79	Specifies the multi-effect type for each MFX 1–3

### Chorus Settings (CHORUS)

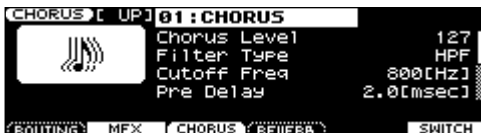

From the EFFECT ROUTING screen (p. 80, p. 82), press [4 (CHORUS)] to access the CHORUS screen.

Use the cursor buttons to move the cursor to the parameter that you want to edit, and use the VALUE dial or [DEC] [INC] to set the value.

Parameter	Range	Explanation
(Chorus Type)	00:OFF– 03:GM2 CHORUS	Selects the type of chorus. Choose “00: OFF” if you don’t want to apply chorus.
Parameters for each chorus type	Set the parameters of the selected chorus type. Refer to “Chorus Parameters” (p. 190).	

### Reverb Settings (REVERB)



From the EFFECT ROUTING screen (p. 80, p. 82), press [5 (REVERB)] to access the REVERB screen.

Use the cursor buttons to move the cursor to the parameter that you want to edit, and use the VALUE dial or [DEC] [INC] to set the value.

Parameter	Range	Explanation
(Reverb Type)	00:OFF– 05:GM2 REVERB	Selects the type of reverb. Choose “00: OFF” if you don’t want to apply reverb.
Parameters for each reverb type	Set the parameters of the selected reverb type. Refer to “Reverb Parameters” (p. 191).	

# Chapter 6. Performing with a Microphone

## Connecting a Mic

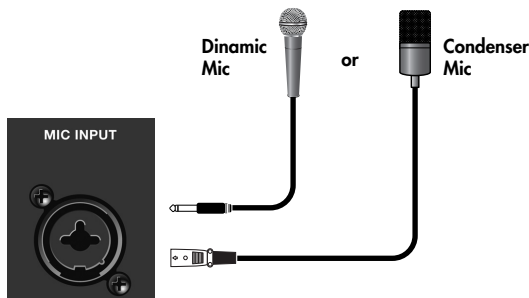

### NOTE

Depending on the position of the microphone relative to the speakers, you may experience acoustic feedback (a whine or howl). If this occurs, take the following actions.

- Change the direction of the microphone
- Move the microphone farther away from the speakers
- Lower the volume

## Adjusting the Volume of the Mic

1. Turn the [MIC VOLUME] knob to adjust the mic volume.

## Applying Reverb to the Mic

1. Press the MIC IN [REVERB] so it's lit.

### MEMO

You can make detailed settings for the reverb that is applied to the mic. Refer to "Detailed Settings for the MIC INPUT (MIC Input Setting)" (p. 154).

## Using a Condenser Mic

If you want to connect a condenser mic that requires phantom power to be supplied, you'll need to change the phantom power setting as follows.

### NOTE

- You must leave this setting "OFF" unless you are connecting a condenser mic that requires phantom power. Supplying phantom power to a dynamic mic will cause malfunctions. Refer to the owner's manual of your mic for details on its requirements.
- This setting cannot be saved. Phantom power will be "OFF" each time the JUNO-STAGE is powered up.

1. Turn the [VOLUME] knob toward the left to the "MIN" position.
2. Press [MENU].  
The Top Menu window will appear.
3. Use [▲][▼] to select "2. Mic Input Setting," and press [ENTER].
4. Use the cursor buttons to move the cursor to "Phantom Power."
5. Use the VALUE dial or [DEC][INC] to turn the setting "ON."

## Using the Vocoder

The JUNO-STAGE uses MFX to simulate a vocoder.

1. Press [PATCH] so it's lit.  
You'll be in Patch mode.
2. Select "PRST 1027 VOCODER Ens" as the patch.  
For details on how to select a patch, refer to "Selecting Patches in Patch Mode" (p. 45).
3. While you play the keyboard, vocalize into the mic.

### NOTE

The vocoder is applied to the sound from the mic. There will be no sound if you only play the keyboard without vocalizing into the mic.

### MEMO

Even for patch other than PRST1027, you can apply the vocoder effect by selecting "79: VOCODER" as the effect.

## Changing the Vocoder Settings

1. Select "PRST 1027 VOCODER Ens" as the patch.
2. Press [EDIT].
3. Press [6 (EFFECT EDIT)] or use the VALUE dial to select "EFFECT EDIT," then press [ENTER].
4. Press [3 (MFX)].  
The MFX screen will appear. In this case, "79: VOCODER" will be selected for MFX.
5. Use the cursor buttons to select the parameter you want to edit.
6. Use the VALUE dial or [DEC][INC] to edit the value.

Parameter	Values	Explanation
Mic Sens	0-127	Adjusts the input sensitivity of the mic.
Synth Level	0-127	Adjusts the input level of the instrument.
Mic Mix	0-127	Adjusts the amount of sound from the mic added to the vocoder's output.
Level	0-127	Adjusts the volume level of the sound that has passed through the vocoder.

### MEMO

If you want to keep the edited settings, save the patch as a user patch. For details, refer to "Saving a Patch You've Created ([WRITE])" (p. 97).

### TIP

To access the MIC INPUT setting screen (p. 154), hold down [SHIFT] and press MIC IN [REVERB]. If you set "MIC Mode" to "VOCODER ONLY" in the MIC INPUT setting screen, the sound of the mic will be output only when you've selected "79: VOCODER" as the effect.

This is convenient when you want to avoid outputting unwanted sound from the mic, for example when you're performing live.

# Chapter 7. Connecting an External MIDI Device

## About MIDI

MIDI (Musical Instrument Digital Interface) is a standard specification that allows musical data to be transferred between electronic musical instruments and computers. If a MIDI cable is connected between devices equipped with MIDI connectors, you'll be able to play multiple devices from a single MIDI keyboard, perform ensembles using multiple MIDI instruments, program the settings to change automatically as the song progresses, and more.

## About MIDI Connectors

The JUNO-STAGE is equipped with the following two types of MIDI connectors, each of which has the following role.



## MIDI IN Connector

This connector receives MIDI messages that are sent from an external MIDI device. When the JUNO-STAGE receives MIDI messages, it can respond by playing notes, switching sounds, etc.

## MIDI OUT Connector

This connector transmits MIDI messages to an external MIDI device. Use it when you want to control an external MIDI device.

## MIDI Channels and Multitimbral Sound Generators

MIDI is able to transmit multiple streams of performance data over a single MIDI cable. This is made possible thanks to the concept of MIDI channels. MIDI channels allow a receiving device to pay attention only to the messages that are intended for it, and not to messages intended for another device. In some ways, MIDI channels are similar to television channels. By changing the reception channel of a television set, you can view the programs that are being broadcast by different stations. This is because the television set is choosing only the desired data from the variety of data that is being broadcast. In the same way, MIDI also allows a device to distinguish and use only the incoming data that is being transmitted to it.

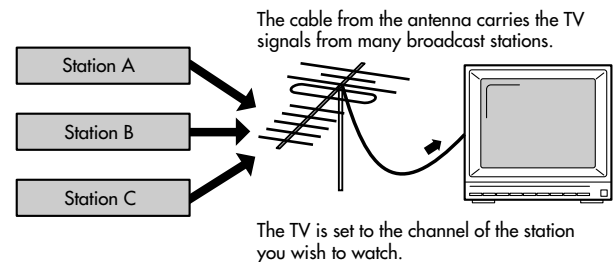

There are sixteen MIDI channels: 1–16. Normally, you'll set the receiving device to receive only the channels that it needs to receive.

### Example:

Set the transmitting device to transmit on channel 1 and channel 2, set sound module A to receive only channel 1, and set sound module B to receive only channel 2. With this setup, you could create an ensemble in which sound module A is playing a guitar sound while sound module B is playing a bass sound.

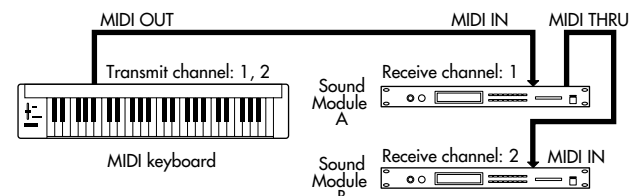

You'll be able to use up to sixteen channels when using the JUNO-STAGE as a sound module. Sound modules that can receive multiple channels of data simultaneously and play different sounds on each channel are called multitimbral sound modules.

### GM

GM (General MIDI) is a set of recommendations that allows the MIDI capabilities of sound modules to be standardized across manufacturers. Sound modules or music data that meet the GM standard carry the GM logo (  ). Music data with the GM logo can be played back on any sound module carrying the GM logo, and will produce essentially the same musical performance.

### GM2

GM2 (  ) is a set of recommendations that is upwardly compatible with the original GM recommendations, and allows a higher level of musical expression and compatibility. It covers issues that were not covered by the original GM recommendations, such as ways in which sounds can be edited and how effects should be handled. It also expands the sounds that are available. Sound modules that are compatible with GM2 will correctly play back music data that carries either the GM or GM2 logo. The original GM, which does not include the GM2 enhancements, is sometimes called "GM1" in order to distinguish it from the newer set of recommendations.

## Using the JUNO-STAGE as a Master Keyboard (MIDI Controller Mode)

You can connect external MIDI devices to the JUNO-STAGE's MIDI OUT connector, and use the JUNO-STAGE to control the connected MIDI devices.

### Connection Example

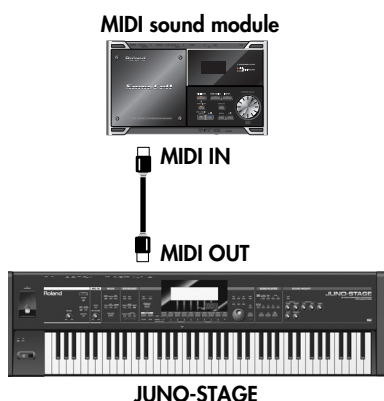

#### 1. Press [MIDI CONTROLLER] so it's lit.

The MIDI CONTROLLER screen will appear, and the JUNO-STAGE will be in MIDI Controller mode.

When you press one of the [0]–[9] buttons, the program change message assigned to that button will be transmitted.

You can turn the SOUND MODIFY knobs to transmit control change messages.

#### 2. To exit MIDI controller mode, press [MIDI CONTROLLER] to turn off the button's illumination.

#### NOTE

The D Beam controller and [S1] [S2] will not operate when you're in MIDI controller mode.

## Specifying the Transmit Channel

Set the JUNO-STAGE's transmit channel so it matches the channel your external MIDI device is using for reception.

#### 1. In the MIDI CONTROLLER screen, use the cursor buttons to move the cursor to the "MIDI Ch" value.

#### 2. Use the VALUE dial or [DEC] [INC] to edit the value. Range: 1–16

#### MEMO

For details on how to set the receive channel of your external MIDI device, refer to its owner's manual.

## Detailed Settings in MIDI Controller Mode



#### MEMO

You can set the keyboard to Split (p. 51) or Dual (p. 51) modes even in MIDI controller mode. When you play the keyboard, the performance data from the Upper and Lower parts will be transmitted on the MIDI channels assigned for each. Operations of the [0]–[9] buttons or the SOUND MODIFY knobs are sent to the MIDI channel of the part indicated by **[KNOB]**.

#### MEMO

The note numbers transmitted in MIDI controller mode are determined by the key you press, the transpose setting (p. 52), and the octave shift setting (p. 52) you specify in MIDI controller mode.

#### MEMO

You can use the arpeggio (p. 60) and chord memory (p. 64) functions even when you're in MIDI Controller mode.

- In the MIDI CONTROLLER screen, use the cursor buttons to select the parameter that you want to edit.
- Use the VALUE dial or [DEC] [INC] to edit the value.

Parameter	Explanation	Range
Local Sw	Specifies whether MIDI messages will be sent to the JUNO-STAGE's own internal sound generator when you operate the JUNO-STAGE.	OFF, ON
MIDI Ch	Specifies the channel on which MIDI messages will be transmitted.	1–16
Button	Selects the number of the button for which you'll assign an MSB, LSB, and PC.	0–9
PC	Program Change number that is transmitted	1–128
MSB	MSB that is transmitted	0–127, OFF (If you specify "OFF," the LSB will also be OFF.)
LSB	LSB that is transmitted	0–127, OFF (If MSB is "OFF," this will also be "OFF" automatically.)
Knob	Selects the SOUND MODIFY knob for which you'll make a controller assignment.	ATTACK, RELEASE, EQ LOW, EQ HIGH, REVERB, CUTOFF, RESONANCE
(Control Change)	Specifies the controller assignment for the selected SOUND MODIFY knob.	CC01–31, CC33–95, PITCH BEND, AFTERTOUCH

- To save your settings, press [WRITE].

### Playing the JUNO-STAGE from an External MIDI Device

#### Example Connections with an External MIDI Device

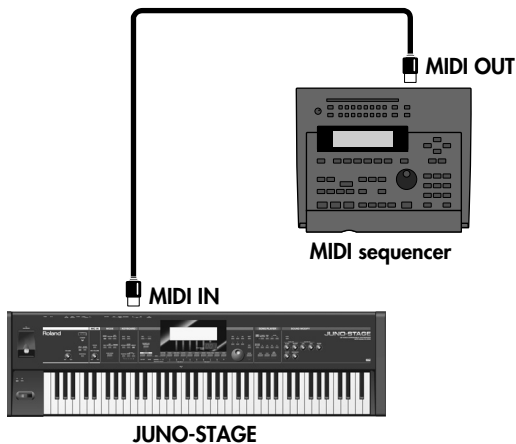

#### Setting the Receive Channel

You'll need to match your external MIDI device's transmit channel with the JUNO-STAGE's receive channel.

Here we'll explain how to make settings for playing the JUNO-STAGE in Patch mode.

1. Press the [MENU].
2. Use [▲][▼] to select "1. System" and press the [ENTER].
3. Press [4 (MIDI/SYNC)].
4. Press [2 (General)].
5. Use [▲][▼] to select "Kbd Patch Rx/Tx Channel."
6. Use the VALUE dial or [DEC] [INC] to set the value.  
Range: 1–16

#### Setting the Program Change Receive Switch

Here's how to turn on the receive switch for program change and bank select messages. With the factory settings, both are turned "ON."

1. Press [MENU].
2. Use [▲][▼] to select "1. System" and press [ENTER].
3. Press [4 (MIDI/SYNC)].
4. Press [4 (RX)].
5. Use the cursor buttons to select "Receive Program Change" or "Receive Bank Select."
6. Use the VALUE dial or [DEC] [INC] to turn each of these "ON."
7. To save your settings, press [WRITE].  
If you decide not to save the changes you made, press [EXIT] to return to the previous screen.

#### MEMO

For details on these settings, refer to "[4 (RX)]" (p. 151).

#### MEMO

For details on how to set the transmit channel of your external MIDI device, refer to its owner's manual.

#### MEMO

If you're using the JUNO-STAGE in Performance mode, you'll also need to make settings in the MIDI FILTER screen to specify the "Rx (Receive Switch)," "PC (Receive Program Change)," and "BS (Receive Bank Select)" setting for each part (p. 138), in addition to the settings described above.

## Synchronizing with an External MIDI Device

### Connection Example

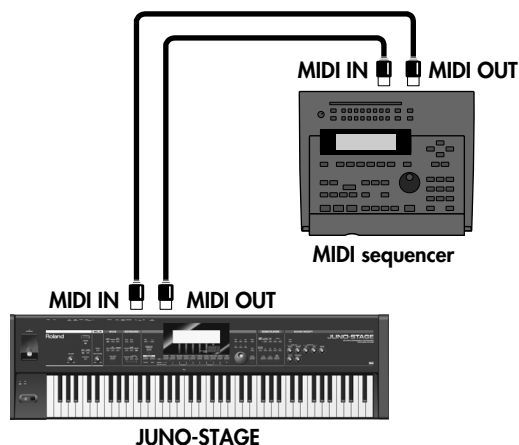

1. Press the [MENU].
2. Use [▲] [▼] to select "1. System" and press the [ENTER].
3. Press [4 (MIDI/SYNC)].
4. Press [5 (SYNC)].
5. Use the cursor buttons to select the parameter you want to edit.
6. Use the VALUE dial or [DEC] [INC] to edit the value.

Parameter	Range	Explanation
Sync Mode	MASTER, SLAVE, REMOTE	Specifies the signal according to which the JUNO-STAGE will operate. <b>MASTER:</b> The JUNO-STAGE will be the master. Choose this setting if you're using the JUNO-STAGE on its own, without synchronizing to another device. <b>SLAVE:</b> The JUNO-STAGE will be a slave device. Choose this setting if you want the JUNO-STAGE to operate according to MIDI Clock messages received from an external device. <b>REMOTE:</b> The JUNO-STAGE will obey Play, Continue, and Stop MIDI messages received from an external device, but will operate according to its own tempo setting.
Sync Output	OFF, ON	If this is ON, synchronization-related MIDI messages (MIDI Clock, Start, Continue, Stop) will be transmitted to the external MIDI device.
Tempo Override	OFF, ON	If this is ON, the tempo will be switched to the "Recommended Tempo" setting of the performance when you switch performances.

7. To save the settings, press [WRITE].

## Transmitting Synchronization Data

If you want an external MIDI device to synchronize to the operation of the JUNO-STAGE, make the following settings.

Parameter	Value
Sync Mode	MASTER
Sync Output	ON

### Exchanging MIDI Messages with Your Computer

If you use a commercially available USB cable to connect the JUNO-STAGE's rear panel USB MIDI connector to a USB connector on your computer, you'll be able to do the following things.

- SMF played back by MIDI-compatible software can be sounded by the JUNO-STAGE.
- MIDI messages can be exchanged between the JUNO-STAGE and your sequencer software, allowing you to carry out sophisticated music production and editing.

### Connection Example

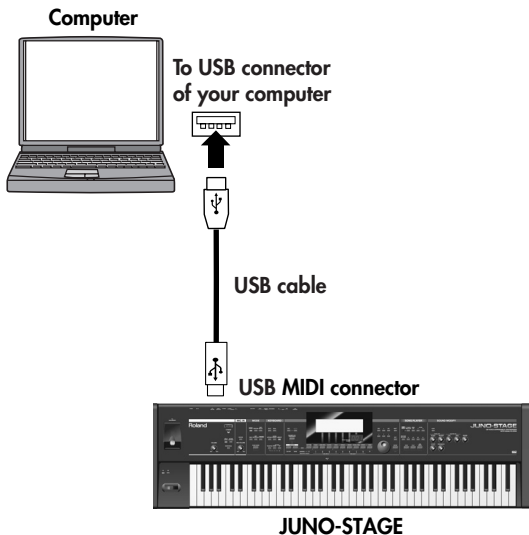

#### NOTE

For details on the operating requirements, refer to the Roland website. You can reach this information from the Roland website <http://www.roland.com/>

#### NOTE

Depending on the type of your computer, this may not work correctly. For details on the operating systems that are supported, refer to the Roland website.

#### Note

- Before making connections to other equipment, you must minimize the volume on all your equipment and turn off the power in order to avoid malfunction and/or damage to your speakers or other devices.
- Only MIDI data can be transmitted or received via USB.
- No USB cable is included. Please consult the dealer from whom you purchased the JUNO-STAGE.
- Power up the JUNO-STAGE before you start up the MIDI application on your computer. Do not turn the JUNO-STAGE's power on or off while the MIDI application is running.

### Installing the USB Driver

#### MEMO

You'll need to install the USB driver if you want to use the software provided on the included CD-ROM.

The driver is provided on the included CD-ROM (JUNO-STAGE Editor CD). You can also download it from the Roland website.

Roland website:

<http://www.roland.com/>

The correct driver and the installation procedure for it will depend on the system you're using. Please carefully read the Readme file on the CD-ROM before you proceed.

#### What is the USB MIDI driver?

The USB MIDI driver is software that passes data between your computer application (e.g., sequencer software) and the JUNO-STAGE when your computer and the JUNO-STAGE are connected via a USB cable.

The USB driver passes data from your application to the JUNO-STAGE, and passes data from the JUNO-STAGE to your application.

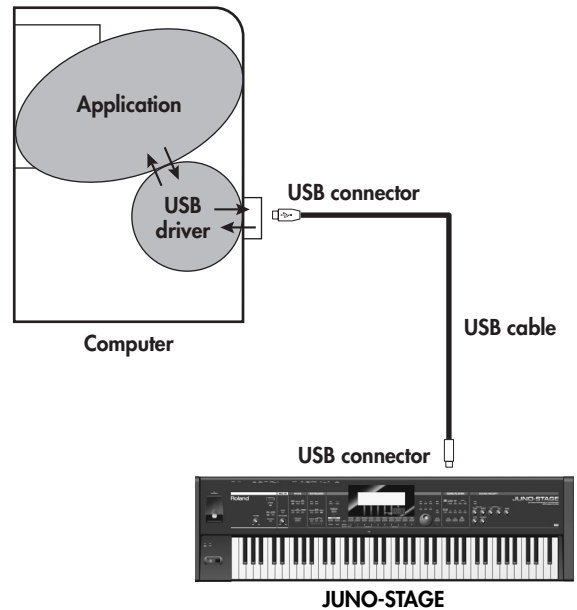



## Specifying the USB Driver

Here's how to specify the USB driver that will be used when the JUNO-STAGE is connected to your computer via the USB MIDI connector.

**NOTE**

If you want to change this setting, disconnect the USB cable before doing so.

1. Press [MENU].
2. Use [▲] [▼] to select "1. System" and press the [ENTER].
3. Press [2 (GENERAL)].
4. Press [2 (COMMON)].
5. Use the cursor buttons to move the cursor to "USB Driver."
6. Use the VALUE dial or [DEC] [INC] to specify the driver.

Parameter	Value	Explanation
USB Driver	VENDER	Choose this if you want to use a USB driver from the included CD-ROM or a USB driver downloaded from the Roland website.
	GENERIC	Choose this if you want to use the generic USB driver provided by your computer's operating system.

A confirmation message will appear.

Press [7 (CLOSE)] to return to the previous screen.

7. Press the [7 (WRITE)] button.
8. Turn the power off, then on again.

**NOTE**

If you change the "USB Driver" setting, you must turn the power off, then on again to ensure that the JUNO-STAGE will operate correctly.

## Using JUNO-STAGE Editor/Librarian/Playlist Editor

The included JUNO-STAGE Editor/Librarian/Playlist Editor software will help you enjoy the full potential of the JUNO-STAGE.

JUNO-STAGE Editor lets you use your computer to edit the JUNO-STAGE's sounds and other settings. Parameters can be assigned to sliders and knobs in the screen of your computer, allowing you to edit efficiently in a graphical manner.

JUNO-STAGE Librarian is software that lets you manage the JUNO-STAGE's parameters as a library on your computer, allowing efficient management of patches, rhythm sets, and performances.

Playlist Editor is software that lets you create playlists for the Song Player (p. 68).

## Installing JUNO-STAGE Editor/Librarian/Playlist Editor in Your Computer

Carefully read the Readme file in the "JUNO-STAGE Editor CD" CD-ROM included with the JUNO-STAGE, and install JUNO-STAGE Editor/Librarian/Playlist Editor as directed.

### Windows Users

Refer to "Readme\_E.txt" on the "JUNO-STAGE Editor CD" CD-ROM

### Macintosh Users

Refer to "Readme\_E.txt" on the "JUNO-STAGE Editor CD" CD-ROM

## Making Connections

1. Set the USB driver selection to "VENDER."  
Refer to "Specifying the USB Driver" (p. 93).
2. Use a USB cable (sold separately) to connect the JUNO-STAGE to your computer.  
Refer to the connection example (p. 92).

# Chapter 8. Detailed Editing for Patches

“Editing” is the process of modifying the values of the JUNO-STAGE’s various settings (parameters). This chapter explains the procedure for patch editing, and how the patch parameters work.

The JUNO-STAGE’s patches are organized into three groups: User, Preset, and GM. You can also install up to two wave expansion boards (SRX series; sold separately).

The following patch groups are available.

## USER

This is a group of rewritable patches inside the JUNO-STAGE. Patches you create can be saved in this group. When the JUNO-STAGE is shipped from the factory, this group already contains 256 patches.

## PRST (preset)

This is a group of non-rewritable patches inside the JUNO-STAGE. Although these patches cannot be rewritten, you are free to edit the settings of the currently selected patch, and then save the modified settings in the user patch group.

## GM (GM2)

This is a group of non-rewritable patches that are compatible with GM2, a set of recommendations that allows compatibility across manufacturers and models. Although these patches cannot be rewritten, you are free to modify the settings of the currently selected patch, and then save the modified settings in the user patch group. This group contains 256 patches.

## XP-A, B (wave expansion board installed in the EXP A or B slot)

These groups allow you to use patches on a wave expansion board installed in the EXP A or B slots. Although these patches cannot be rewritten, you are free to modify the settings of the currently selected patch, and then save the modified settings in the user patch group. The number of patches in each group will depend on the wave expansion board that is installed.

### NOTE

XP-A and B patches cannot be selected unless an SRX series wave expansion board (sold separately) is installed in the corresponding slot.

## How to Edit a Patch

You can create a new patch by editing an existing patch.

A patch consists of up to four “tones.” Before editing a patch, you should listen to each tone individually to familiarize yourself with the role it plays in creating the overall sound of the patch.

### Four tips when creating patches

- **Choose a patch that’s close to what you have in mind (p. 45)**

If you’re trying to create a new patch, it will be difficult to make progress if you simply select any old patch and start making changes blindly. It’s important to start by selecting a patch that’s close to what you have in mind.

- **Decide which tones you’ll use (p. 95)**

When creating a patch, it’s very important to decide which tones you’re going to use. In the EDIT screen, use the Tone Switch 1–4 settings to specify whether each tone will be heard (on) or silent (off). Turning off unneeded tones is also an important way to conserve polyphony.

- **Check the structure setting (p. 99)**

The Structure parameter is a very important one; it specifies how the four tones will be combined. Before you begin actually editing the tones, you must understand the relationship between the tones.

- **Turn the effects off (p. 79)**

The JUNO-STAGE contains a diverse array of effects, allowing you to process the sound in sophisticated ways. Effects have a major impact on the sound, and simply turning off the effects may produce an entirely different impression. Turning off the effects will allow you to hear the sound of the patch itself, which makes it easier to hear the result of the changes you make. In some cases, editing the effect settings may be enough to create the sound you want.

## Editing in a Graphic Display (ZOOM EDIT)

The ZOOM EDIT screen lets you edit using a graphic display of important parameters that are edited frequently.

### MEMO

For details on the parameters, refer to p. 98 and following.

1. **In Patch mode or Performance mode, select the patch that you want to edit.**

For details, refer to “Selecting Patches in Patch Mode” (p. 45) or “Selecting a Patch for Each Part” (p. 50).

### MEMO

If you want to create a patch from scratch rather than starting from an existing one, execute the Initialize operation (p. 96).

2. **Press [EDIT].**

- Press [3 (PATCH EDIT)], or use the VALUE dial to select "PATCH EDIT" and then press [ENTER].

The ZOOM EDIT screen will appear.



- Use [2]–[5] to select the desired editing screen. By pressing [6 (PAGE)] you can switch among the [2]–[5] screens.

Button	Screen
[2 (PCH ENV)]	PITCH ENVELOPE (p. 105)
[3 (TVF PRM)]	TVF PARAMETER (p. 106)
[4 (TVF ENV)]	TVF ENVELOPE (p. 107)
[5 (TVA ENV)]	TVA ENVELOPE (p. 109)
[6 (PAGE ↓)] [6 (PAGE ↑)]	
[2 (STRUCT)]	STRUCTURE (p. 99)
[3 (LFO 1)]	LFO 1 (p. 113)
[4 (LFO 2)]	LFO 2 (p. 113)
[5 (STEP LFO)]	STEP LFO (p. 115)

- Use the cursor buttons to select the parameter that you want to edit.
- Press [TONE SWITCH/SELECT] so it's lit, and use TONE SELECT [1]–[4] to select the tone that you want to edit.
  - To simultaneously edit the same parameter for multiple tones  
Simultaneously press TONE SELECT [1]–[4] corresponding to the tones that you want to edit, so they're lit in red.
  - To switch tones on/off  
Press TONE SWITCH [1]–[4] to turn each tone on/off.
- Use the VALUE dial or [DEC] [INC] to edit the value. If you've selected more than one tone for editing, all of those tones will be set to the same value.

**MEMO**

In PRO EDIT (p. 95) you can edit while preserving the relative differences between tones.

- Repeat steps 4–7 to edit the patch as desired.
- If you want to save the changes you've made, press [WRITE] (p. 97).  
If you decide not to save the changes, press [EXIT] to exit the ZOOM EDIT screen.  
If you exit the ZOOM EDIT screen without saving, an "\*" will be displayed in the PATCH PLAY screen of Patch mode.

**NOTE**

If you turn off the power or select a different sound when the "\*" is displayed, the patch settings you edited will be lost.

## Viewing and Editing All Parameters (PRO EDIT)

This shows the parameters of ZOOM EDIT, and additionally allows you to edit in greater detail.

**MEMO**

For details on the parameters refer to p. 98 and following.

- In Patch mode or Performance mode, select the patch that you want to edit.  
For details, refer to "Selecting Patches in Patch Mode" (p. 45) or "Selecting a Patch for Each Part" (p. 50).

**MEMO**

If you want to create a patch from scratch without using an existing patch, execute the Initialize operation (p. 96).

- Press [EDIT].
- Either press [3 (PATCH EDIT)] or use the VALUE dial to select "PATCH EDIT," and then press [ENTER].  
The ZOOM EDIT screen will appear.
- Press [7 (PRO EDIT)].  
The PRO EDIT screen will appear.
- Use [3 (GRP ↑)] [4 (GRP ↓)] to switch between parameter groups.

**TIP**

Alternatively, you can switch between parameter groups by pressing [2 (GRP LIST)] to access the Patch Pro Edit Menu window, then using the VALUE dial, [DEC] [INC], or [▲] [▼] to select the parameter group, and pressing [ENTER].

- Use the cursor buttons to select a parameter.



- Press [TONE SWITCH/SELECT] so it's lit, and use TONE SELECT [1]–[4] to select the tone that you want to edit.
  - To edit the same parameter of multiple tones simultaneously  
Simultaneously press the TONE SELECT [1]–[4] buttons for the tones that you want to edit, so they're lit in red.
  - To switch tones on/off  
Press TONE SWITCH [1]–[4] to switch tones on/off. You'll be editing the tones for which a check mark (✓) is shown for the tone numbers in the upper right of the screen.
- Use the VALUE dial or [DEC] [INC] to edit the value. If you've selected more than one tone for editing, their values will change while their relative differences are preserved.

## Chapter 8. Detailed Editing for Patches

- Repeat steps 5–8 to edit the parameters as desired.
- If you want to save the modified settings, press [WRITE] (p. 97).  
If you decide not to save the changes you made, press [EXIT] to exit the PRO EDIT screen.  
If you exit the PRO EDIT screen without saving, an "\*" will be displayed in the PATCH PLAY screen of Patch mode.

### NOTE

If you turn off the power or select a different sound when the "\*" is displayed, the patch settings you edited will be lost.

## Initializing a Patch

Here's how to return (initialize) the settings of the currently selected patch to their default values.

### NOTE

Initialization will affect only the currently selected patch. If you want to return all settings to their factory-set state, execute the Factory Reset operation (p. 155).

- In Patch mode or Performance mode, select the user patch that you want to initialize.  
For details, refer to "Selecting Patches in Patch Mode" (p. 45) or "Selecting a Patch for Each Part" (p. 50).
- Press [EDIT].
- Either press [3], or use the VALUE dial to select "PATCH EDIT" and press [ENTER].  
The ZOOM EDIT screen will appear.
- Hold down [SHIFT] and press [6 (INIT)].  
A confirmation message will appear.  
If you decide to cancel, press [6 (CANCEL)].
- Press [7 (EXEC)] to initialize the patch.

## Copying Patch (Tone) Settings

Here's how to copy the tone settings of a desired patch to the currently selected patch.

- In Patch mode or Performance mode, select the copy-destination user patch.  
For details, refer to "Selecting Patches in Patch Mode" (p. 45) or "Selecting a Patch for Each Part" (p. 50).
- Press [EDIT].
- Either press [3], or use the VALUE dial to select "PATCH EDIT" and press [ENTER].  
The ZOOM EDIT screen will appear.
- Hold down [SHIFT] and press [7 (TONE CPY)].  
The Patch Tone Copy window will appear.

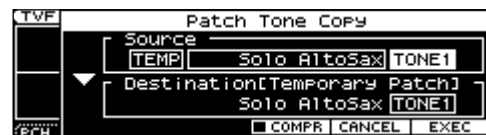

- Use the cursor buttons to move the cursor, and use the VALUE dial or [DEC] [INC] to select the desired "Source (copy-source)" group, number, and tone.  
If you press [5 (COMPR)] to apply a check mark (✓), you'll be able to play the copy-source patch (Compare function).
- Use the cursor buttons to move the cursor, and select the "Destination (copy-destination)" tone.
- Press [7 (EXEC)].  
A confirmation message will appear.  
If you decide to cancel, press [6 (CANCEL)].
- Press [7 (EXEC)] to execute the copy.

### Compare function

When copying patch tones or saving patches, it's often convenient to use the Compare function.

If you want to hear the copy-source (or save-destination) patch, press [5 (COMPR)] to apply a check mark (✓); now you can use the keyboard to play the copy-source (or save-destination) patch.

- \* The patch may sound slightly different than normal when played via the Compare function.

## Saving a Patch You've Created ([WRITE])

Changes you make are temporary, and will be lost when you turn off the power or select another patch. If you want to keep the patch you modified, you must save it to internal user memory.

When you edit the settings of a patch in Patch mode, an "\*" will be shown in the PATCH PLAY screen.

If you've edited a patch in Performance mode, you should also save the performance after saving the patch (p. 133).

### NOTE

When you save, the data that previously occupied the save destination will be overwritten.

#### 1. Edit a patch.

#### 2. Press [WRITE].

The PATCH NAME screen will appear.

If you're in Performance mode, the WRITE MENU screen will appear. Pressing [3 (PAT/RHY)] will access the PATCH NAME screen.



#### 3. Assign a name to the patch.

For details on assigning a name, refer to p. 44.

#### 4. When you've finished assigning a name, press [7 (WRITE)].

A screen allowing you to select the save destination will appear.

#### 5. Use the VALUE dial, [DEC] [INC], or [▲] [▼] to select the save-destination patch number.

If you press [5 (COMPR)] to apply a check mark (✓), you'll be able to play the save-destination patch (Compare function).

#### 6. Press [7 (WRITE)].

A confirmation message will appear.

If you decide to cancel, press [6 (CANCEL)].

#### 7. Press [7 (EXEC)] to save the patch.

### NOTE

Never turn off the power while data is being saved.

### Note when selecting a waveform

The JUNO-STAGE uses complex PCM waveforms as the basis for its sounds. For this reason, you should be aware that if you specify a waveform that is very different than the original waveform, the result may not be what you expect.

The JUNO-STAGE's internal waveforms can be categorized into the following two types.

#### One-shot:

These are sounds with a short decay time. One-shot waveforms contain the entire duration of the sound from the attack until it decays to silence. Some of these waveforms capture a complete sound such as a percussion instrument, but there are also many attack component sounds such as the hammer strike of a piano or the fret noise of a guitar.

#### Loop:

These are sounds with a long decay, or sustaining sounds. Looped waveforms will repeatedly play a portion of a sound once it has reached a relatively stable state. These sounds also include numerous component sounds, such as a vibrating piano string or a resonating pipe.

The following illustration shows an example of a sound created by combining a one-shot waveform with a loop waveform. (This example is of an electric organ.)

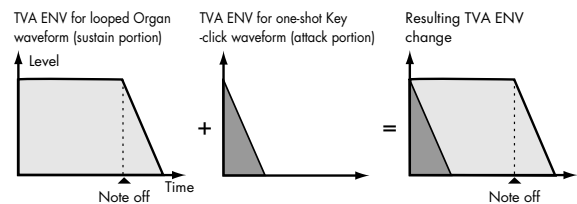

### Note when selecting a one-shot waveform

It's not possible to use the envelope settings to give a one-shot waveform a longer decay than the original waveform contains, or to make it a sustaining sound. Even if you made this type of envelope setting, you would be trying to bring out something that doesn't exist in the original waveform.

### Note when selecting a looped waveform

Many acoustic instruments such as piano or sax are marked by a sudden change in timbre at the very beginning of the sound, and this rapid change is what gives the instrument its distinctive character. When using these waveforms, it's best to use the complex tonal changes in the attack portion of the sound without attempting to modify them; use the envelope only to modify the decay portion of the sound as desired. If you use the envelope to modify the attack as well, the envelope settings will be affected by the attack of the waveform itself, and you may not get the result you intend.

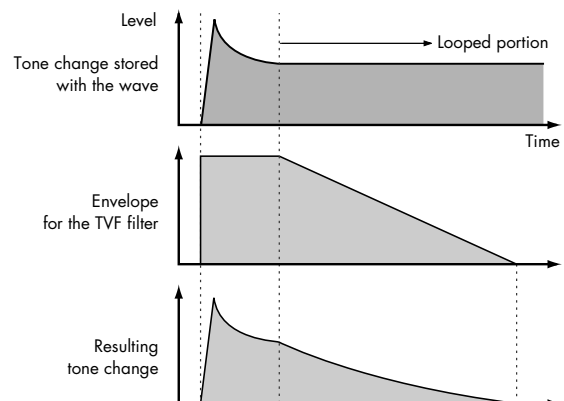

## Functions of Patch Parameters

### Settings Common to the Entire Patch

#### GENERAL

Parameters indicated by ( **ZOOM** ) can be edited via ZOOM EDIT (p. 94).

Parameter marked with a "★" can be controlled using specified MIDI messages.  
(Matrix Control, p. 110)

Parameter	Value	Explanation
Patch Category	Refer to "Patch List" (p. 193).	Type (category) of the patch
Patch Level	0-127	Volume of the patch
Patch Pan	L64-0-63R	Left/right position of the patch
Patch Priority	LAST, LOUDEST	How notes will be managed when the maximum polyphony is exceeded (128 voices) <b>LAST:</b> The last-played voices will be given priority (Notes will be turned off in order, beginning with the first-played note.) <b>LOUDEST:</b> The loudest voices will be given priority (Notes will be turned off, beginning with the lowest-volume voice.)
Octave Shift	-3→+3	Pitch of the patch's sound (in units of an octave)
Patch Coarse Tune ★	-48→+48	Pitch of the patch's sound (in semitones, +/- 4 octaves)
Patch Fine Tune	-50→+50	Pitch of the patch's sound (in 1-cent steps; one cent is 1/100th of a semitone)
Stretch Tune Depth	OFF, 1-3	Stretched tuning (a system by which acoustic pianos are normally tuned, causing the lower range to be lower and the higher range to be higher than the mathematical tuning ratios would otherwise dictate) <b>OFF:</b> Equal temperament <b>1-3:</b> Higher settings will produce the greater difference in the pitch of the low and high ranges.
Analog Feel	0-127	Depth of 1/f modulation (a pleasant and naturally-occurring ratio of modulation that occurs in a babbling brook or rustling wind) * You can simulate the natural instability characteristic of an analog synthesizer by adding this "1/f modulation."

#### Stretched Tuning

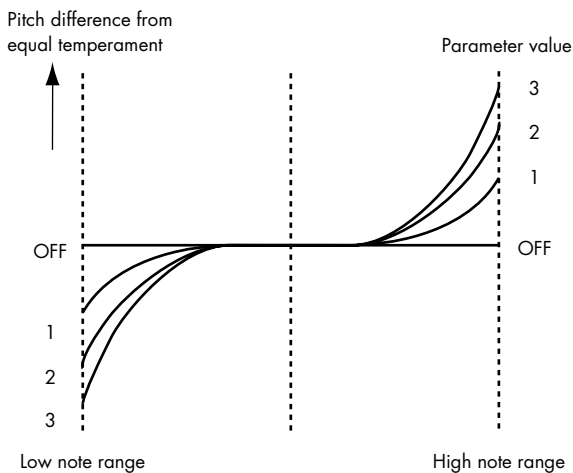

## Changing How a Tone is Sounded (Structure)

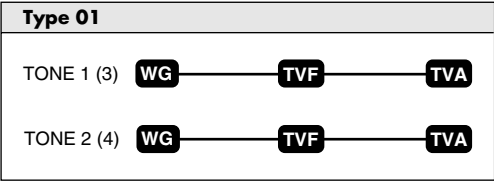
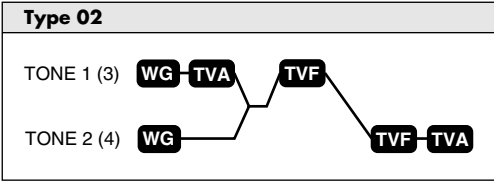
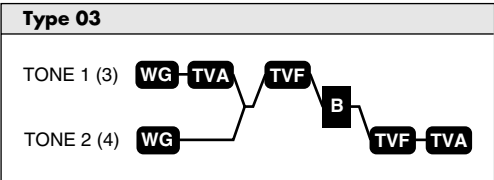
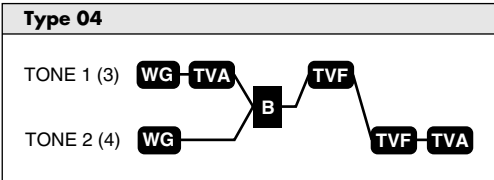
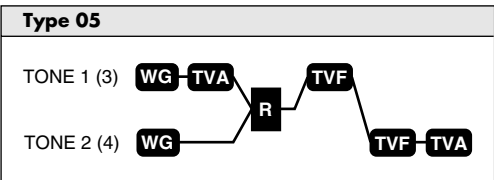
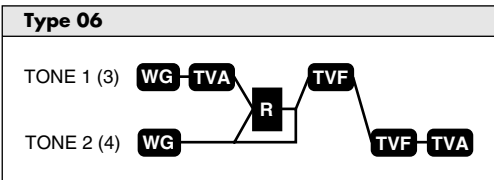
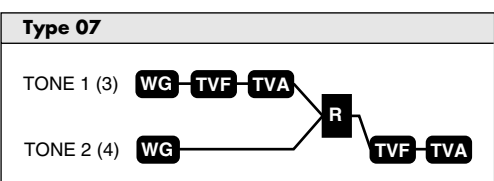
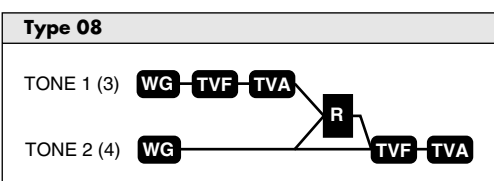
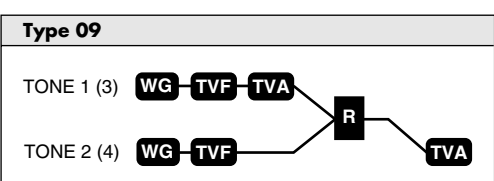
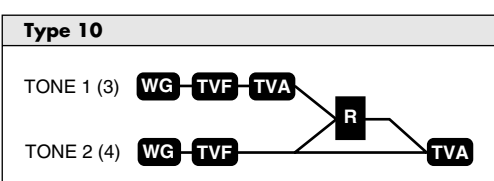
Parameter	Value	Explanation
<b>Struct 1 &amp; 2, 3 &amp; 4</b> (Structure Type) <b>ZOOM</b> Struct 1&2, 3&4	TYPE 01–TYPE 10	Determines how tone 1 and 2, or tone 3 and 4 are connected. The following 10 different Types of combination are available.
<b>Type 01</b> 	<b>Type 02</b> 	With this type, tones 1 and 2 (or 3 and 4) are independent. Use this type when you want to preserve PCM sounds or create and combine sounds for each tone.  This type stacks the two filters together to intensify the characteristics of the filters. The TVA for tone 1 (or 3) controls the volume balance between the two tones.
<b>Type 03</b> 	<b>Type 04</b> 	This type mixes the sound of tone 1 (3) and tone 2 (4), applies a filter, and then applies a booster to distort the waveform.  This type applies a booster to distort the waveform, and then combines the two filters. The TVA for tone 1 (or 3) controls the volume balance between the two tones and adjusts booster level.
<b>Type 05</b> 	<b>Type 06</b> 	This type uses a ring modulator to create new overtones, and combines the two filters. The tone 1 (3) TVA will control the volume balance of the two tones, adjusting the depth of ring modulator.  This type uses a ring modulator to create new overtones, and in addition mixes in the sound of tone 2 (4) and stacks the two filters. Since the ring-modulated sound can be mixed with tone 2 (4), tone 1 (3) TVA can adjust the amount of the ring-modulated sound.
<b>Type 07</b> 	<b>Type 08</b> 	This type applies a filter to tone 1 (3) and ring-modulates it with tone 2 (4) to create new overtones.  This type sends the filtered tone 1 (3) and tone 2 (4) through a ring modulator, and then mixes in the sound of tone 2 (4) and applies a filter to the result.
<b>Type 09</b> 	<b>Type 10</b> 	This type passes the filtered sound of each tone through a ring modulator to create new overtones. The tone 1 (3) TVA will control the volume balance of the two tones, adjusting the depth of ring modulator.  This type passes the filtered sound of each tone through a ring modulator to create new overtones, and also mixes in the sound of tone 2 (4). Since the ring-modulated sound can be mixed with tone 2 (4), tone 1 (3) TVA can adjust the amount of the ring-modulated sound.

- \* When TYPE 02–10 is selected and one tone of a pair is turned off, the other tone will be sounded as TYPE 01 regardless of the displayed setting.
- \* If you limit the keyboard area in which a tone will sound (KEY RANGE, p. 102) or limit the range of velocities for which it will sound (VELOCITY RANGE, p. 102), the result in areas or ranges where the tone does not sound is just as if the tone had been turned off. This means that if TYPE 02–10 is selected and you create a keyboard area or velocity range in which one tone of a pair does not sound, notes played in that area or range will be sounded by the other tone as TYPE 01 regardless of the displayed setting.

## Chapter 8. Detailed Editing for Patches

Parameter	Value	Explanation
<b>Booster 1&amp;2, 3&amp;4</b> (Booster Gain) <b>ZOOM</b> <b>Booster 1&amp;2, 3&amp;4</b>	0, +6, +12, +18	Specifies the amount of boost that is applied (when the structure type is TYPE 03 or TYPE 04) The booster distorts the sound by boosting the input signal, producing the distortion effect that is often used with an electric guitar. Increasing this value will produce stronger distortion.

### Booster

The Booster is used to distort the incoming signal.

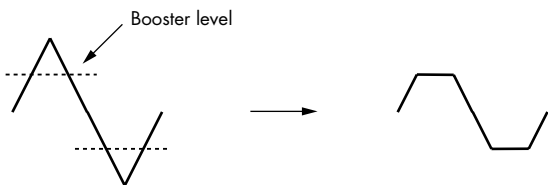

In addition to using this to create distortion, you can use the waveform (WG1) of one of the tones as an LFO which shifts the other waveform (WG2) upward or downward to create modulation similar to PWM (pulse width modulation). This parameter works best when you use it in conjunction with the Wave Gain parameter (p. 103).

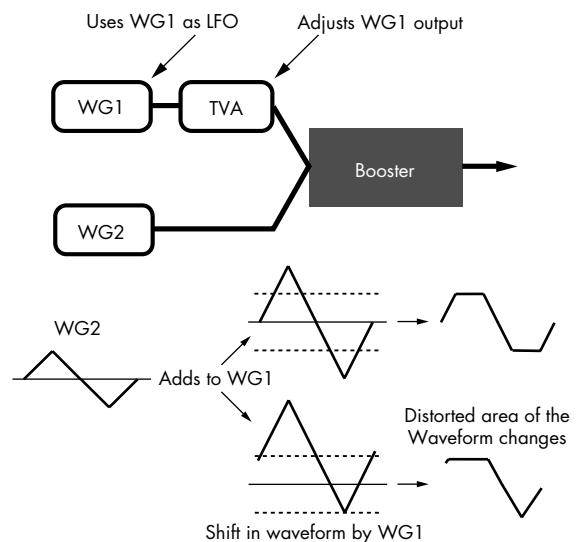

### Ring Modulator

A ring modulator multiplies the waveforms of two tones with each other, generating many new overtones (in harmonic partials) which were not present in either waveform (Unless one of the waveforms is a sine wave, evenly-spaced frequency components will not usually be generated.).

As the pitch difference between the two waveforms changes the harmonic structure, the result will be an unpitched metallic sound. This function is suitable for creating metallic sounds such as bells.

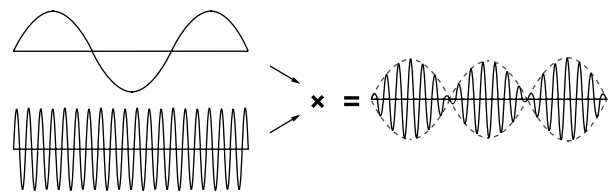

## MODIFY

These values are added to the parameter values of each tone.

Parameter	Value	Description
<b>Cutoff Offset</b>	-63--+63	Cutoff Frequency (p. 106)
<b>Resonance Offset</b>	-63--+63	Resonance (p. 106)
<b>Attack Time Offset</b>	-63--+63	F-Env Time 1, A-Env Time 1 (p. 107, p. 109)
<b>Release Time Offset</b>	-63--+63	F-Env Time 4, A-Env Time 4 (p. 107, p. 109)
<b>Velocity Sens Offset</b>	-63--+63	Cutoff V-Sens, Level V-Sens (p. 107, p. 108)



## PORTAMENTO

Portamento is an effect which smoothly changes the pitch from the first-played key to the next-played key.

**Portamento Start: PITCH**

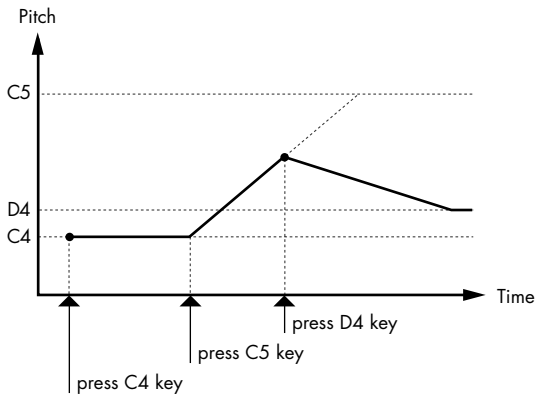

**Portamento Start: NOTE**

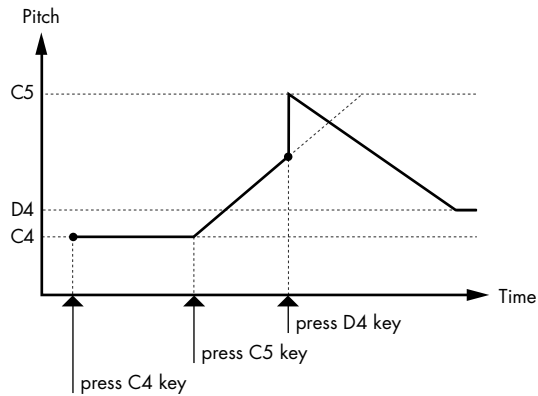

Parameter	Value	Explanation
<b>Portamento Switch</b>	OFF, ON	Specifies whether the portamento effect will be applied (ON) or not (OFF).
<b>Portamento Mode</b>	NORMAL, LEGATO	<b>NORMAL:</b> Portamento will always be applied. <b>LEGATO:</b> Portamento will be applied only when you play legato.
<b>Portamento Type</b>	RATE, TIME	<b>RATE:</b> Speed of pitch change is uniform (the time required for the pitch change will correspond to the distance of the pitch change) <b>TIME:</b> The time it takes will be constant, regardless of how far apart in pitch the notes are.
<b>Portamento Start</b>	PITCH, NOTE	<b>PITCH:</b> Starts a new portamento when another key is pressed while the pitch is changing. <b>NOTE:</b> Portamento will begin anew from the pitch where the current change would end.
<b>Portamento Time</b>	0-127	Specifies the time over which the pitch will change.

## CONTROL

Parameter	Value	Explanation
<b>Mono/Poly</b>	MONO, POLY	<b>MONO:</b> Only the last-played note will sound. This setting is effective when playing a solo instrument patch such as sax or flute. <b>POLY:</b> Two or more notes can be played simultaneously.
<b>Legato Switch</b>	OFF, ON	<b>ON:</b> Pressing a key while continuing to press a previous key causes the note to change pitch to the pitch of the most recently pressed key, sounding all the while. This is effective when you wish to simulate the hammering-on and pulling-off techniques used by a guitarist. * Legato Switch is valid when the Mono/Poly parameter is set to "MONO."
<b>Legato Retrigger</b>	OFF, ON	<b>OFF:</b> When one key is held down and another key is then pressed, only the pitch changes, without the attack of the latter key being played. Set this to "OFF" when performing wind and string phrases or when using modulation with the mono synth keyboard sound. <b>ON:</b> Normally you will leave this parameter "ON." * Legato Retrigger is valid when the Mono/Poly is set to "MONO" and the Legato Switch is set to "ON."
<b>Pitch Bend Range Up</b>	0-+48	Degree of pitch change in semitones when the Pitch Bend lever is all the way right (in semitones)
<b>Pitch Bend Range Down</b>	-48-0	Degree of pitch change in semitones when the Pitch Bend lever is all the way left (in semitones)

## Chapter 8. Detailed Editing for Patches

### KEY RANGE

You can use the note number to control the way each Tone is played.

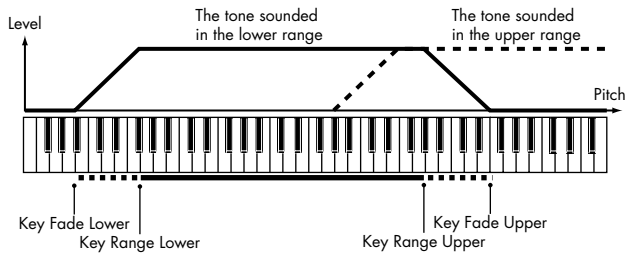

Parameter	Value	Explanation
<b>Key Fade Lower</b>	0-127	Determines what will happen to the tone's level when a note that's lower than Key Range Lower is played. If you don't want the tone to sound at all, set this parameter to "0."
<b>Key Range Lower</b>	C --(Upper)	Specifies the lowest note that the tone will sound for each tone.
<b>Key Range Upper</b>	(Lower)-G9	Specifies the highest note that the tone will sound for each tone.
<b>Key Fade Upper</b>	0-127	Determines what will happen to the tone's level when a note that's higher than Key Range Upper is played. If you don't want the tone to sound at all, set this parameter to "0."

### VELOCITY RANGE

You can use the force with which keys are played to control the way each Tone is played.

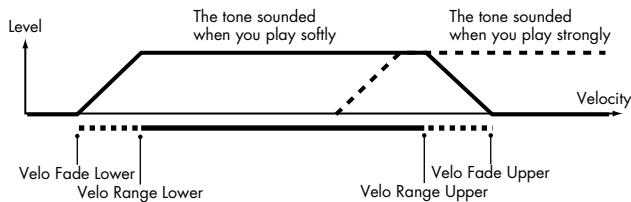

Parameter	Value	Explanation
<b>Tone Mix Velo Control</b>	OFF, ON, RANDOM, CYCLE	Determines whether a different tone is played (ON) or not (OFF) depending on the force with which the key is played (velocity). <b>RANDOM:</b> The patch's constituent tones will sound randomly, regardless of any Velocity messages. <b>CYCLE:</b> The patch's constituent tones will sound consecutively, regardless of any Velocity messages.
<b>Control Switch</b>	OFF, ON	Use the Matrix Control (p. 110) to enable (ON), or disable (OFF) sounding of different tones.
<b>Velo Fade Lower</b>	0-127	Determines what will happen to the tone's level when the tone is played at a velocity lower than Velo Range Lower. If you don't want the tone to sound at all, set this parameter to "0."
<b>Velo Range Lower</b>	1-(Upper)	Specifies the lowest velocity at which the tone will sound.
<b>Velo Range Upper</b>	(Lower)-127	Specifies the highest velocity at which the tone will sound.
<b>Velo Fade Upper</b>	0-127	Determines what will happen to the tone's level when the tone is played at a velocity greater than Velo Range Upper. If you don't want the tone to sound at all, set this parameter to "0."

#### MEMO

When using the Matrix Control to have different tones played, set the lowest value (Lower) and highest value (Upper) of the value of the MIDI message used.

#### NOTE

Instead of using Velocity, you can also have tones substituted using the Matrix Control. However, the keyboard velocity and the Matrix Control cannot be used simultaneously to make different tones to sound. When using the Matrix Control to switch tones, set the Tone Mix Velo Control parameter to "OFF."

## Modifying Waveforms/Pitch/Pitch Envelope

### WAVE PARAMETER

Parameter marked with a "★" can be controlled using specified MIDI messages.  
(Matrix Control, p. 110)

Parameter	Value	Explanation
Wave Group	INT, EXP	Group for the waveform that is to be the basis of the tone <b>INT:</b> Waveforms stored in internal <b>EXP:</b> Waveform stored in a Wave Expansion Board (SRX series) installed in EXP slots
Wave Bank	A, B	When the Wave Group is EXP <b>A, B:</b> Wave expansion board slots
Wave No. L (Mono) Wave No. R	—, 1–	Basic waveform for a tone (The upper limit will depend on the Wave Group and Wave Bank.) When in monaural mode, only the left side (L) is specified. When in stereo, the right side (R) is also specified. If you want to select a left/right pair of Waves, select the left (L) Wave number, and then hold down [SHIFT] and press [5 (STEREO)] to add a check mark (✓); the right (R) (Wave) will be recalled.
Wave Gain	-6, 0, +6, +12	Gain (amplification) of the waveform The value changes in 6 dB (decibel) steps—an increase of 6 dB doubles the waveform's gain. * If you intend to use the Booster to distort the waveform's sound, set this parameter to its maximum value (p. 100).
Wave Tempo Sync	OFF, ON	When you wish to synchronize a Phrase Loop to the clock (tempo), set this to "ON." * This is valid only when a separately sold wave expansion board is installed, and a waveform that indicates a tempo (BPM) is selected. If a waveform from a wave expansion board is selected for the tone, turning the Wave Tempo Sync parameter "ON" will cause pitch-related settings and FXM-related settings to be ignored. * When this parameter is set to "ON," set the Tone Delay Time parameter (p. 111) to "0."
FXM Switch	OFF, ON	This sets whether FXM will be used (ON) or not (OFF).
FXM Color	1–4	How FXM will perform frequency modulation Higher settings result in a grainier sound, while lower settings result in a more metallic sound.
FXM Depth ★	0–16	Depth of the modulation produced by FXM

#### Phrase Loop

Phrase loop refers to the repeated playback of a phrase that's been pulled out of a song (e.g., by using a sampler). One technique involving the use of Phrase Loops is the excerpting of a Phrase from a pre-existing song in a certain genre, for example dance music, and then creating a new song with that Phrase used as the basic motif. This is referred to as "Break Beats."

#### FXM

FXM (Frequency Cross Modulation) uses a specified waveform to apply frequency modulation to the currently selected waveform, creating complex overtones. This is useful for creating dramatic sounds or sound effects.

# Chapter 8. Detailed Editing for Patches

## WAVE PITCH

Parameter marked with a "★" can be controlled using specified MIDI messages.  
(Matrix Control, p. 110)

Parameter	Value	Explanation
<b>Tone Coarse Tune ★</b>	-48→+48	Pitch of the tone's sound (in semitones, +/-4 octaves)
<b>Tone Fine Tune ★</b>	-50→+50	Pitch of the tone's sound (in 1-cent steps; one cent is 1/100th of a semitone)
<b>Rand Pitch Depth</b>	0-1200	Width of random pitch deviation that will occur each time a key is pressed (in 1-cent steps) If you do not want the pitch to change randomly, set this to "0."
<b>Pitch Keyfollow</b>	-200→+200	Amount of pitch change that will occur when you play a key one octave higher If you want the pitch to rise one octave as on a conventional keyboard, set this to "+100." If you want the pitch to rise two octaves, set this to "+200."
<b>P-Env V-Sens</b>	-63→+63	Keyboard playing dynamics can be used to control the depth of the pitch envelope. If you want the pitch envelope to have more effect for strongly played notes, set this parameter to a positive (+) value.
<b>P-Env T1 V-Sens</b>	-63→+63	This allows keyboard dynamics to affect the T1 of the Pitch envelope. If you want T1 to be speeded up for strongly played notes, set this parameter to a positive (+) value.
<b>P-Env T4 V-Sens</b>	-63→+63	Use this parameter when you want key release speed to affect the T4 value of the Pitch envelope. If you want T4 to be speeded up for quickly released notes, set this parameter to a positive (+) value.
<b>P-Env Time KF (Time Keyfollow)</b>	-100→+100	Use this setting if you want the pitch envelope times (T2-T4) to be affected by the keyboard location. Based on the pitch envelope times for the C4 key, positive (+) settings will cause notes higher than C4 to have increasingly shorter times.

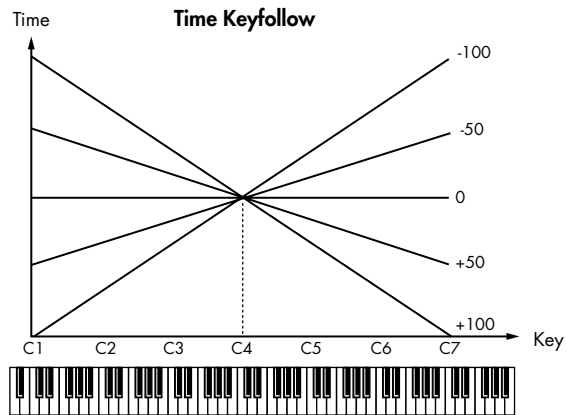
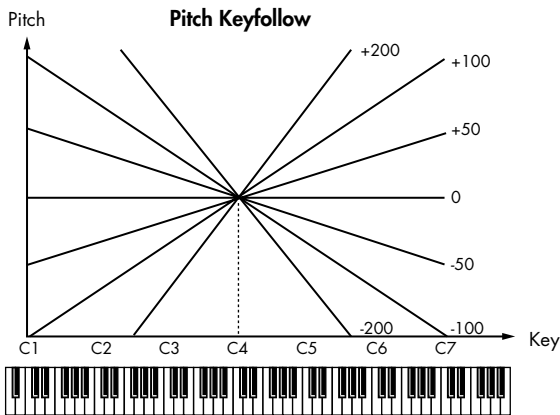

## WAVE PITCH ENV

Parameters indicated by ( **ZOOM** ) can be edited via ZOOM EDIT (p. 94).

Parameter marked with a "★" can be controlled using specified MIDI messages.  
(Matrix Control, p. 110)

Parameter	Value	Explanation
<b>P-Env Depth</b> <b>ZOOM</b> Env Depth	-12→+12	Depth of the Pitch envelope Higher settings will cause the pitch envelope to produce greater change. Negative (-) settings will invert the shape of the envelope.
<b>P-Env Time 1-4 ★</b> <b>ZOOM</b> Time 1-4	0-127	Pitch envelope times (T1-T4) Higher settings will result in a longer time until the next pitch is reached.
<b>P-Env Level 0-4</b> <b>ZOOM</b> Level 0-4	-63→+63	Pitch envelope levels (L0-L4) Specify how the pitch will change at each point, relative to the pitch set with Coarse Tune or Fine Tune.

**Pitch Envelope**

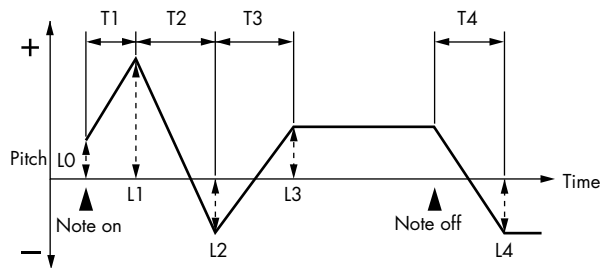

# Chapter 8. Detailed Editing for Patches

## Modifying the Brightness of a Sound with a Filter (TVF/TVF Envelope)

A filter cuts or boosts a specific frequency region to change a sound's brightness, thickness, or other qualities.

### TVF PARAMETER

Parameters indicated by ( **ZOOM** ) can be edited via ZOOM EDIT (p. 94).

Parameter marked with a "★" can be controlled using specified MIDI messages.  
(Matrix Control, p. 110)

Parameter	Value	Explanation
<b>Filter Type</b> <b>ZOOM</b> Filter Type	OFF, LPF, BPF, HPF, PKG, LPF2, LPF3	Type of filter <b>OFF:</b> No filter is used. <b>LPF:</b> Low Pass Filter. This reduces the volume of all frequencies above the Cutoff Frequency in order to round off, or un-brighten the sound. <b>BPF:</b> Band Pass Filter. This leaves only the frequencies in the region of the Cutoff Frequency, and cuts the rest. This can be useful when creating distinctive sounds. <b>HPF:</b> High Pass Filter. This cuts the frequencies in the region below the Cutoff Frequency. This is suitable for creating percussive sounds emphasizing their higher tones. <b>PKG:</b> Peaking Filter. This emphasizes the frequencies in the region of the Cutoff Frequency. You can use this to create wah-wah effects by employing an LFO to change the Cutoff Frequency cyclically. <b>LPF2:</b> Low Pass Filter 2. Although frequency components above the Cutoff Frequency are cut, the sensitivity of this filter is half that of the LPF. This filter is good for use with simulated instrument sounds such as the acoustic piano. <b>LPF3:</b> Low Pass Filter 3. Although frequency components above the Cutoff Frequency are cut, the sensitivity of this filter changes according to the Cutoff Frequency. While this filter is also good for use with simulated acoustic instrument sounds, the nuance it exhibits differs from that of the LPF2, even with the same TVF Envelope settings. * If you set "LPF2" or "LPF3," the setting for the Resonance parameter will be ignored.
<b>Cutoff Frequency ★</b> <b>ZOOM</b> Cutoff	0-127	Frequency at which the filter begins to have an effect on the waveform's frequency components
<b>Resonance ★</b> <b>ZOOM</b> Resonance	0-127	Emphasizes the portion of the sound in the region of the cutoff frequency, adding character to the sound * Excessively high settings can produce oscillation, causing the sound to distort.
<b>Cutoff Keyfollow</b> <b>ZOOM</b> Cutoff KFolw	-200-+200	Use this parameter if you want the cutoff frequency to change according to the key that is pressed Relative to the cutoff frequency at the C4 key (center C), positive (+) settings will cause the cutoff frequency to rise for notes higher than C4, and negative (-) settings will cause the cutoff frequency to fall for notes higher than C4. Larger settings will produce greater change.

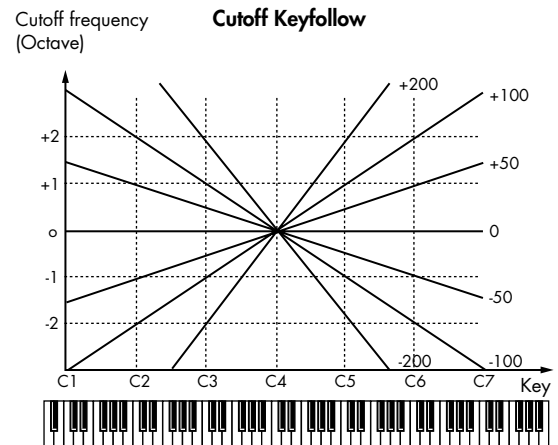
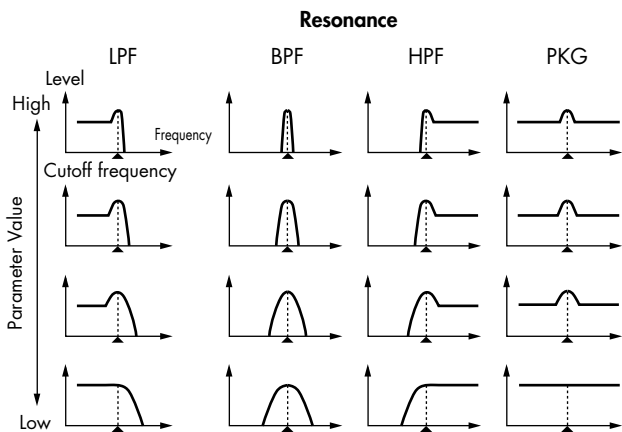

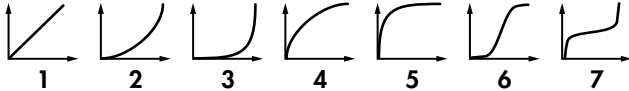
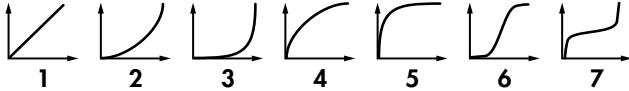
Parameter	Value	Explanation
<b>Cutoff V-Curve</b>	FIX, 1-7	Curve that determines how keyboard playing dynamics (velocity) will affect the cutoff frequency Set this to "FIX" if you don't want the Cutoff frequency to be affected by the keyboard velocity. 
<b>Cutoff V-Sens</b>	-63+63	Use this parameter when changing the cutoff frequency to be applied as a result of changes in playing velocity. If you want strongly played notes to raise the cutoff frequency, set this parameter to positive (+) settings.
<b>Resonance V-Sens</b>	-63+63	This allows keyboard velocity to modify the amount of Resonance. If you want strongly played notes to have a greater Resonance effect, set this parameter to positive (+) settings.
<b>F-Env V-Curve</b>	FIX, 1-7	Curve that determines how keyboard playing dynamics (velocity) will affect the TVF envelope Set this to "FIX" if you don't want the TVF Envelope to be affected by the keyboard velocity. 
<b>F-Env V-Sens</b>	-63+63	Specifies how keyboard playing dynamics will affect the depth of the TVF envelope. Positive (+) settings will cause the TVF envelope to have a greater effect for strongly played notes, and negative (-) settings will cause the effect to be less.
<b>F-Env T1 V-Sens</b>	-63+63	This allows keyboard dynamics to affect the T1 of the TVF envelope. If you want T1 to be speeded up for strongly played notes, set this parameter to a positive (+) value.
<b>F-Env T4 V-Sens</b>	-63+63	Use this parameter when you want key release speed to affect the T4 value of the TVF envelope. If you want T4 to be speeded up for quickly released notes, set this parameter to a positive (+) value.

## TVF ENVELOPE

Parameters indicated by ( **ZOOM** ) can be edited via ZOOM EDIT (p. 94).

Parameter marked with a "★" can be controlled using specified MIDI messages.  
(Matrix Control, p. 110)

Parameter	Value	Explanation
<b>F-Env Depth</b> <b>ZOOM</b> Env Depth	-63+63	Depth of the TVF envelope Higher settings will cause the TVF envelope to produce greater change. Negative (-) settings will invert the shape of the envelope.
<b>F-Env Time KF</b> (Time Keyfollow)	-100+100	Use this setting if you want the TVF envelope times (T2-T4) to be affected by the keyboard location. Based on the TVF envelope times for the C4 key (center C), positive (+) settings will cause notes higher than C4 to have increasingly shorter times.
<b>F-Env Time 1-4 ★</b> <b>ZOOM</b> Time 1-4	0-127	TVF envelope times (T1-T4) Higher settings will lengthen the time until the next cutoff frequency level is reached.
<b>F-Env Level 0-4</b> <b>ZOOM</b> Level 0-4	0-127	TVF envelope levels (L0-L4) Specify how the cutoff frequency will change at each point, relative to the Cutoff Frequency value.

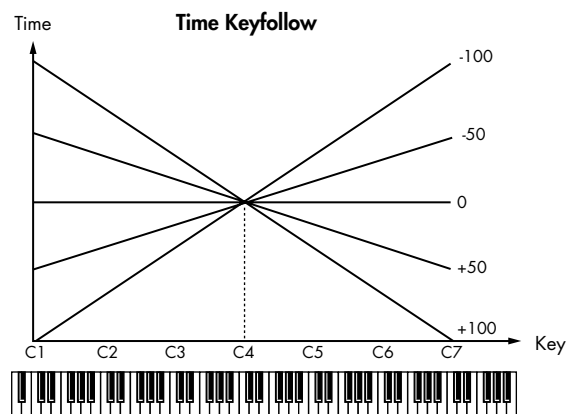
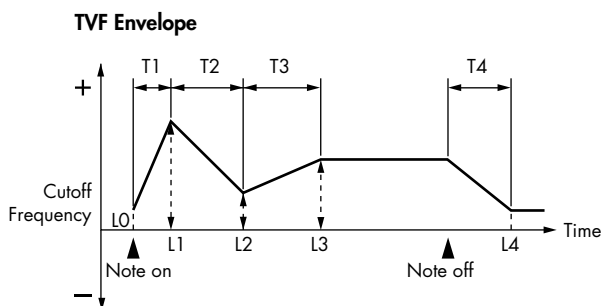

## Chapter 8. Detailed Editing for Patches

### Adjusting the Volume (TVA/TVA Envelope)

#### TVA PARAMETER

Parameter marked with a "★" can be controlled using specified MIDI messages.  
(Matrix Control, p. 110)

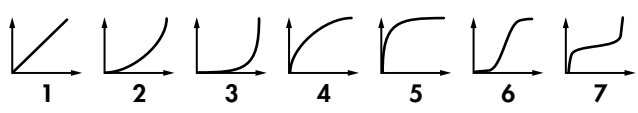
Parameter	Value	Explanation
<b>Tone Level ★</b>	0–127	Volume of the tone This setting is useful primarily for adjusting the volume balance between tones.
<b>Level V-Curve</b>	FIX, 1–7	Curve that determines how keyboard playing dynamics (velocity) will affect the volume Set this to "FIX" if you don't want the volume of the tone to be affected by the keyboard velocity. 
<b>Level V-Sens</b>	-63–+63	Set this when you want the volume of the tone to change depending on keyboard playing dynamics Set this to a positive (+) value to have the changes in tone volume increase the more forcefully the keys are played; to make the tone play more softly as you play harder, set this to a negative (-) value.

#### Bias

Bias causes the volume to be affected by the keyboard position. This is useful for changing volume through keyboard position (pitch) when playing acoustic instruments.

<b>Bias Level</b>	-100–+100	Angle of the volume change that will occur in the selected Bias Direction Larger settings will produce greater change. Negative (-) values will invert the change direction.
<b>Bias Position</b>	C - –G9	Key relative to which the volume will be modified
<b>Bias Direction</b>	LWR, UPR, L&U, ALL	Direction in which change will occur starting from the Bias Position <b>LWR:</b> The volume will be modified for the keyboard area below the Bias Point. <b>UPR:</b> The volume will be modified for the keyboard area above the Bias Point. <b>L&amp;U:</b> The volume will be modified symmetrically toward the left and right of the Bias Point. <b>ALL:</b> The volume changes linearly with the bias point at the center.

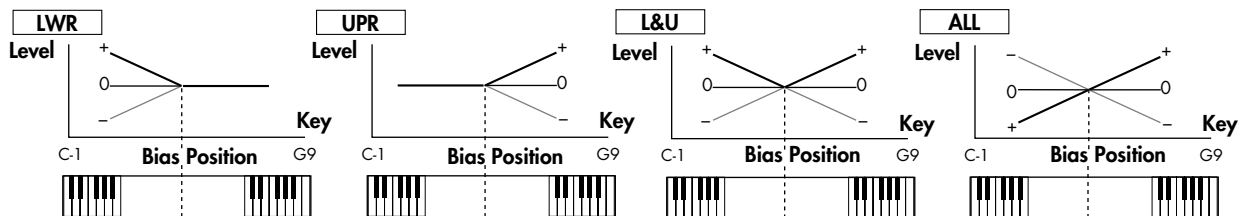

Parameter	Value	Explanation
<b>Tone Pan ★</b>	L64–0–63R	Left/right position of the tone
<b>Pan Keyfollow</b>	-100–+100	Use this parameter if you want key position to affect panning. Positive (+) settings will cause notes higher than C4 key (center C) to be panned increasingly further toward the right, and negative (-) settings will cause notes higher than C4 key (center C) to be panned toward the left. Larger settings will produce greater change.

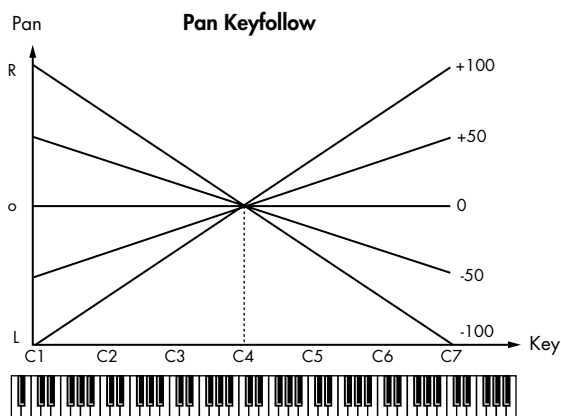

\* When a TYPE 02–10 has been selected for Structure (p. 99), the settings for Pan Keyfollow, Random Pan Depth, and Alter Pan Depth for tone 1 (3) will be in concord with the settings for tone 2 (4). (This is because the outputs of tones 1 and 2 are consolidated in tone 2, and the outputs of tones 3 and 4 are consolidated in tone 4.)



Parameter	Value	Explanation
Random Pan Depth	0–63	Use this parameter when you want the stereo location to change randomly each time you press a key. Higher settings will produce a greater amount of change.
Alter Pan Depth	L63–0–63R	This setting causes panning to be alternated between left and right each time a key is pressed. Higher settings will produce a greater amount of change. “L” or “R” settings will reverse the order in which the pan will alternate between left and right. For example if two tones are set to “L” and “R” respectively, the panning of the two tones will alternate each time they are played.

## TVA ENVELOPE

Parameters indicated by ( **ZOOM** ) can be edited via ZOOM EDIT (p. 94).

Parameter marked with a “★” can be controlled using specified MIDI messages.  
(Matrix Control, p. 110)

Parameter	Value	Explanation
A-Env T1 V-Sens	-63–+63	This allows keyboard dynamics to affect the T1 of the TVA envelope. If you want Time 1 to be speeded up for strongly played notes, set this parameter to a positive (+) value. If you want it to be slowed down, set this to a negative (-) value.
A-Env T4 V-Sens	-63–+63	Use this parameter when you want key release speed to affect the T4 value of the TVA envelope. If you want T4 to be speeded up for quickly released notes, set this parameter to a positive (+) value. If you want it to be slowed down, set this to a negative (-) value.
A-Env Time KF (Time Keyfollow)	-100–+100	Use this setting if you want the TVA envelope times (T2–T4) to be affected by the keyboard location. Based on the TVA envelope times for the C4 key (center C), positive (+) settings will cause notes higher than C4 to have increasingly shorter times, and negative (-) settings will cause them to have increasingly longer times. Larger settings will produce greater change.
A-Env Time 1–4 ★ <b>ZOOM</b> Time 1–4	0–127	TVA envelope times (T1–T4) Higher settings will lengthen the time until the next volume level is reached.
A-Env Level 1–3 <b>ZOOM</b> Level 1–3	0–127	TVA envelope levels (L1–L3) Specify how the volume will change at each point, relative to the Tone Level value.

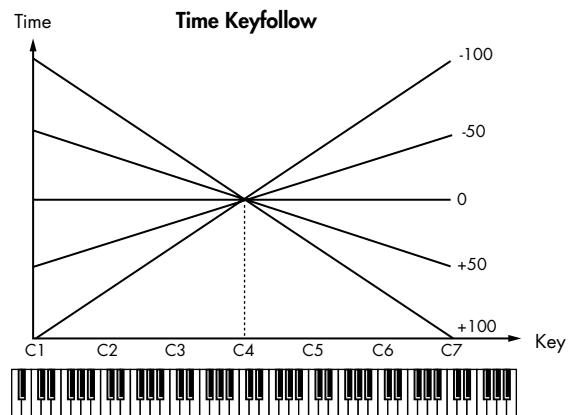
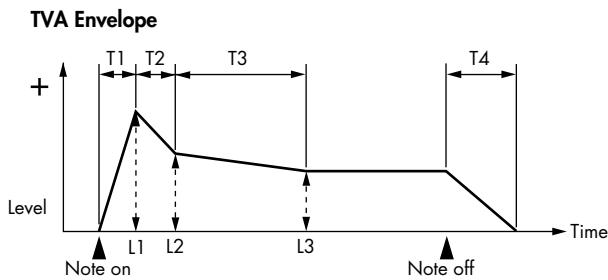

## Matrix Control Settings/Miscellaneous Settings

### MATRIX CTRL1-4

The function which allows you use MIDI messages to make changes in realtime to the tone parameters is called the **Matrix Control**. Up to four Matrix Controls can be used in a single patch.

To use the Matrix Control, specify which MIDI message (CTRL Source) will be used to control which parameter (CTRL Destination), and how greatly (CTRL Sens), and the tone to which the effect is applied (CTRL Switch).

Parameter	Value	Explanation
<b>CTRL 1-4 Source</b>	OFF, CC01-31, 33-95, PITCH BEND, AFTERTOUCH, SYS CTRL1-4, VELOCITY, KEY FOLLOW, TEMPO, LFO1, LFO2, PITCH ENV, TVF ENV, TVA ENV	MIDI message used to change the tone parameter with the Matrix Control <b>OFF:</b> Matrix control will not be used. <b>CC01-31, 33-95:</b> Controller numbers 1-31, 33-95 <b>PITCH BEND:</b> Pitch Bend <b>AFTERTOUCH:</b> Aftertouch <b>SYS CTRL1-4:</b> Controllers that are shared by the entire JUNO-STAGE (see TIP below) <b>VELOCITY:</b> Pressure you press a key with <b>KEY FOLLOW:</b> Keyboard position with C4 as 0 <b>TEMPO:</b> The specified tempo of the JUNO-STAGE or the tempo of an external MIDI sequencer. <b>LFO1:</b> LFO 1 <b>LFO2:</b> LFO 2 <b>PITCH ENV:</b> Pitch envelope <b>TVF ENV:</b> TVF envelope <b>TVA ENV:</b> TVA envelope

**MEMO**

VELOCITY and KEY FOLLOW correspond to Note messages.

**TIP**

- Although there are no MIDI messages for LFO 1 through TVA Envelope, they can be used as Matrix Control. In this case, you can change the tone settings in realtime by playing patches.
- If you want to use common controllers for the entire JUNO-STAGE, select "SYS CTRL1"- "SYS CTRL4." MIDI messages used as System Control 1-4 are set with the System Ctrl 1-4 Source parameters (p. 148).

**NOTE**

- If Rx Bender, Rx Expression, or Rx Hold-1 (p. 112) are "ON," incoming MIDI messages of these types will affect the Pitch Bend, Expression, or Hold 1 settings at the same time that they affect the target parameter (CTRL Destination). If you want these incoming messages to affect only the target parameter, turn these settings "OFF."
- There are parameters that let you specify whether specific MIDI messages will be received for each channel in a performance (p. 138). When a patch with Matrix Control settings is assigned to a part, confirm that any MIDI messages used for the Matrix Control will be received. If the JUNO-STAGE is set up such that reception of MIDI messages is disabled, then the Matrix Control will not function.

Parameter	Value	Explanation
<b>CTRL 1-4 Destination 1-4</b>	OFF, PITCH, CUTOFF, RESONANCE, LEVEL, PAN, OUTPUT LEVEL, CHORUS SEND, REVERB SEND, LFO1/2 PITCH DEPTH, LFO1/2 TVF DEPTH, LFO1/2 TVA DEPTH, LFO1/2 PAN DEPTH, LFO1/2 RATE, PCH ENV A-TIME, PCH ENV D-TIME, PCH ENV R-TIME, TVF ENV A-TIME, TVF ENV D-TIME, TVF ENV R-TIME, TVA ENV A-TIME, TVA ENV D-TIME, TVA ENV R-TIME, TMT, FXM DEPTH, MFX CTRL1-4	Tone parameters that are to be controlled when using the Matrix Control Up to four parameters can be specified for each Matrix Control, and controlled simultaneously. * In this manual, parameters that can be controlled using the Matrix Control are marked with a "★."

Parameter	Value	Explanation
<b>CTRL 1-4</b> <b>Sens 1-4</b>	-63→+63	Amount of the Matrix Control's effect that is applied <ul style="list-style-type: none"> <li>• If you wish to modify the selected parameter in a positive (+) direction—i.e., a higher value, toward the right, or faster etc.—from its current setting, select a positive (+) value.</li> <li>• If you wish to modify the selected parameter in a negative (-) direction—i.e., a lower value, toward the left, or slower etc.—from its current setting, select a negative (-) value.</li> <li>• For either positive or negative settings, greater absolute values will allow greater amounts of change. Set this to "0" if you don't want to apply the effect.</li> </ul>
<b>CTRL 1-4</b> <b>Switch 1-4</b>	OFF, ON, REVS	Tone to which the effect is applied when using the Matrix Control <p><b>OFF:</b> The effect will not be applied.  <b>ON:</b> The effect will be applied.  <b>REVS:</b> The effect will be applied in reverse.</p>

### MISC

#### Tone Delay

This produces a time delay between the moment a key is pressed (or released), and the moment the tone actually begins to sound. You can also make settings that shift the timing at which each tone is sounded. This differs from the Delay in the internal effects, in that by changing the sound qualities of the delayed tones and changing the pitch for each tone, you can also perform arpeggio-like passages just by pressing one key.

You can also synchronize the tone delay time to the tempo of the JUNO-STAGE.

- \* If you are not going to use Tone Delay, set the Tone Delay Mode parameter to "NORM" and Delay Time parameter to "0."
- \* If "Struct 1 & 2, 3 & 4" (p. 99) is set to TYPE 02-10, the settings for tone 1 (3) will follow the settings of tone 2 (4). (This is because the outputs of tones 1 and 2 are combined into tone 2, and the outputs of tones 3 and 4 are combined into tone 4.)

Parameter	Value	Explanation
<b>Tone Delay Mode</b>	NORM, HOLD, OFFN, OFFD	Type of tone delay <p><b>NORM:</b> The tone begins to play after the time specified in the Tone Delay Time parameter has elapsed.</p> <p><b>HOLD:</b> Although the tone begins to play after the time specified in the Tone Delay Time parameter has elapsed, if the key is released before the time specified in the Tone Delay Time parameter has elapsed, the tone is not played.</p> <p><b>OFFN:</b> Rather than being played while the key is pressed, the tone begins to play once the period of time specified in the Tone Delay Time parameter has elapsed after release of the key. This is effective in situations such as when simulating noises from guitars and other instruments.</p> <p><b>OFFD:</b> Rather than being played while the key is pressed, the tone begins to play once the period of time specified in the Tone Delay Time parameter has elapsed after release of the key. Here, however, changes in the TVA Envelope begin while the key is pressed, which in many cases means that only the sound from the release portion of the envelope is heard.</p> <p>* If you have selected a waveform that is a decay-type sound (i.e., a sound that fades away naturally even if the key is not released), selecting "OFFN" or "OFFD" may result in no sound being heard.</p>
<b>Tone Delay Time</b>	0-127, Note	Time from when the key is pressed (or if the Tone Delay Mode parameter is set to "OFFN" or "OFFD," the time from when the key is released) until when the tone will sound <p>Specify this as a note value if you want to synchronize the delay to the tempo of the JUNO-STAGE.</p>

Tone Delay Mode: NORM

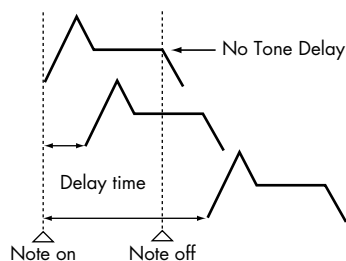

Tone Delay Mode: HOLD

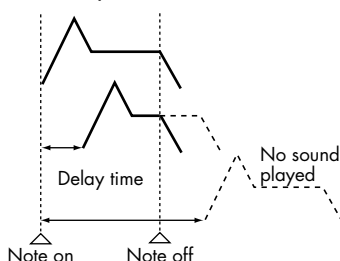

Tone Delay Mode: OFFN

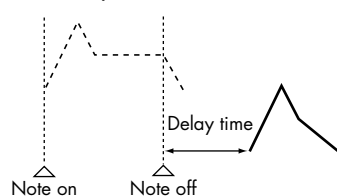

Tone Delay Mode: OFFD

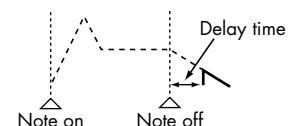

## Chapter 8. Detailed Editing for Patches

Parameter	Value	Explanation
<b>Tone Env Mode</b>	NSUS, SUST	When a loop waveform (p. 97) is selected, the sound will normally continue as long as the key is pressed. If you want the sound to decay naturally even if the key remains pressed, set this to "NSUS." * If a one-shot type wave (p. 97) is selected, it will not sustain even if this parameter is set to "SUST."
<b>Rx Bender</b>	OFF, ON	For each tone, specify whether MIDI Pitch Bend messages will be received (ON), or not (OFF).
<b>Rx Expression</b>	OFF, ON	For each tone, specify whether MIDI Expression messages will be received (ON), or not (OFF).
<b>Rx Hold-1</b>	OFF, ON	For each tone, specify whether MIDI Hold-1 messages will be received (ON), or not (OFF). * If "NSUS" is selected for Tone Env Mode parameter, this setting will have no effect.
<b>Rx Pan Mode</b>	CONT, K-ON	For each tone, specify how pan messages will be received. <b>CONT:</b> Whenever Pan messages are received, the stereo position of the tone will be changed. <b>K-ON:</b> The pan of the tone will be changed only when the next note is played. If a pan message is received while a note is sounding, the panning will not change until the next key is pressed. * The channels cannot be set so as not to receive Pan messages.
<b>Redamper Sw</b>	OFF, ON	You can specify, on an individual tone basis, whether or not the sound will be held when a Hold 1 message is received after a key is released, but before the sound has decayed to silence. If you want to sustain the sound, set this "ON." This function is effective for piano sounds. * In order to use this function, you must also set Rx Hold-1 to "ON."

## Modulating Sounds/Output Setting

An LFO (Low Frequency Oscillator) causes change over a cycle in a sound. Each tone has two LFOs (LFO1/LFO2), and these can be used to cyclically change the pitch, cutoff frequency and volume to create modulation-type effects such as vibrato, wah and tremolo. Both LFOs have the same parameters so only one explanation is needed.

### LFO 1-2

Parameters indicated by ( **ZOOM** ) can be edited via ZOOM EDIT (p. 97).

Parameter marked with a "★" can be controlled using specified MIDI messages.  
(Matrix Control, p. 110)

Parameter	Value	Explanation
<b>Waveform</b> <b>ZOOM</b> Waveform	SIN, TRI, SAWU, SAWD, SQR, RND, BD-U, BD-D, TRP, S&H, CHS, VSIN, STEP	Waveform of the LFO <b>SIN:</b> Sine wave <b>TRI:</b> Triangle wave <b>SAWU:</b> Sawtooth wave <b>SAWD:</b> Sawtooth wave (negative polarity) <b>SQR:</b> Square wave <b>RND:</b> Random wave <b>BD-U:</b> Once the attack of the waveform output by the LFO is allowed to develop in standard fashion, the waveform then continues without further change. <b>BD-D:</b> Once the decay of the waveform output by the LFO is allowed to develop in standard fashion, the waveform then continues without further change. <b>TRP:</b> Trapezoidal wave <b>S&amp;H:</b> Sample & Hold wave (one time per cycle, LFO value is changed) <b>CHS:</b> Chaos wave <b>VSIN:</b> Modified sine wave. The amplitude of a sine wave is randomly varied once each cycle. <b>STEP:</b> A waveform generated by the data specified by LFO Step 1-16. This produces stepped change with a fixed pattern similar to a step modulator. * If you set this to "BD-U" or "BD-D," you must turn the Key Trigger parameter (p. 114) to "ON." If this is "OFF," it will have no effect.
<b>Rate ★</b> <b>ZOOM</b> Rate	0-127, Note	Modulation speed of the LFO If you want the LFO rate to be synchronized with the tempo, this should be set in terms of a note value. * This setting will be ignored if the Waveform parameter is set to "CHS."
<b>Rate Detune</b>	0-127	Makes subtle changes in the LFO cycle rate (Rate parameter) each time a key is pressed. Higher settings will cause greater change. * This parameter is invalid when Rate is set to "note."
<b>Offset</b>	-100-+100	Raises or lowers the LFO waveform relative to the central value (pitch or cutoff frequency). Positive (+) settings will move the waveform so that modulation will occur from the central value upward. Negative (-) settings will move the waveform so that modulation will occur from the central value downward.
<b>Delay Time</b> <b>ZOOM</b> Delay	0-127	Time elapsed before the LFO effect is applied (the effect continues) after the key is pressed (or released) When using violin, wind, or certain other instrument sounds in a performance, rather than having vibrato added immediately after the sounds are played, it can be effective to add the vibrato after the note is drawn out somewhat. * Set this according to your purpose as described in "How to Apply the LFO" (p. 114).
<b>Delay Time KF</b> (Time Keyfollow)	-100-+100	Adjusts the value for the Delay Time parameter depending on the key position, relative to the C4 key (center C). If this is set to a positive "+" value, the Delay Time will become shorter as you play notes higher than the C4 key (middle C).

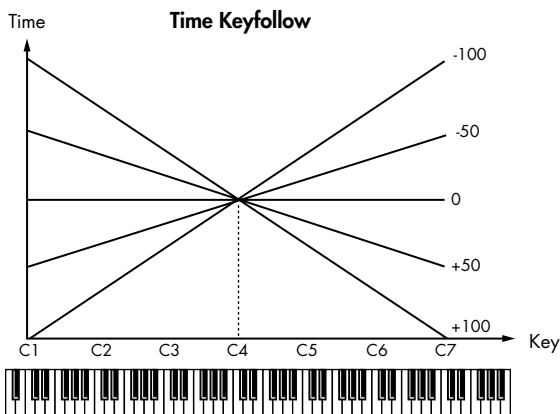

## Chapter 8. Detailed Editing for Patches

Parameters indicated by ( **ZOOM** ) can be edited via ZOOM EDIT (p. 97).

Parameter marked with a "★" can be controlled using specified MIDI messages.  
(Matrix Control, p. 110)

Parameter	Value	Explanation
<b>Fade Mode</b> <b>ZOOM</b> Fade Mode	ON <, ON >, OFF <, OFF >	How the LFO will be applied * Set this according to your purpose as described in "How to Apply the LFO" (below).
<b>Fade Time</b> <b>ZOOM</b> Fade	0–127	Time over which the LFO amplitude will reach the maximum (minimum) * Set this according to your purpose as described in "How to Apply the LFO" (below).
<b>Key Trigger</b>	OFF, ON	Specifies whether the LFO cycle will be synchronized to begin when the key is pressed (ON) or not (OFF).
<b>Pitch Depth ★</b> <b>ZOOM</b> Pitch Depth	-63–+63	How deeply the LFO will affect pitch
<b>TVF Depth ★</b> <b>ZOOM</b> Filter Depth	-63–+63	How deeply the LFO will affect the cutoff frequency
<b>TVA Depth ★</b> <b>ZOOM</b> Amp Depth	-63–+63	How deeply the LFO will affect the volume
<b>Pan Depth ★</b> <b>ZOOM</b> Pan Depth	-63–+63	How deeply the LFO will affect the pan

Positive (+) and negative (-) settings for the Depth parameters result in differing kinds of change in pitch and volume. For example, if you set the Depth parameter to a positive (+) value for one tone, and set another tone to the same numerical value, but make it negative (-), the modulation phase for the two tones will be the reverse of each other. This allows you to shift back and forth between two different tones, or combine it with the Pan setting to cyclically change the location of the sound image.

\* If "Struct 1 & 2, 3 & 4" (p. 99) is set to TYPE 02–10, the settings for tone 1 (3) will follow the settings of tone 2 (4). (This is because the outputs of tones 1 and 2 are combined into tone 2, and the outputs of tones 3 and 4 are combined into tone 4.)

### How to Apply the LFO

#### ● Apply the LFO gradually after the key is pressed

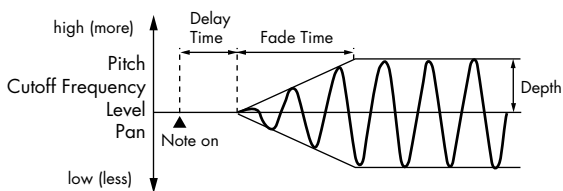

**Fade Mode:** ON <  
**Delay Time:** Time from when the keyboard is played until the LFO begins to be applied  
**Fade Time:** Time over which the LFO amplitude will reach the maximum after the Delay Time has elapsed

#### ● Apply the LFO immediately when the key is pressed, and then gradually begin to decrease the effect

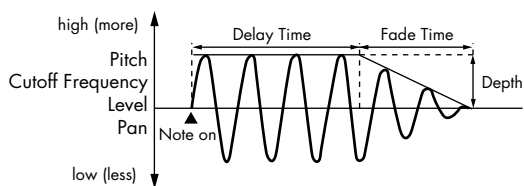

**Fade Mode:** ON >  
**Delay Time:** Time that the LFO will continue after the keyboard is played  
**Fade Time:** Time over which the LFO amplitude will reach the minimum after the Delay Time has elapsed

#### ● Apply the LFO gradually after the key is released

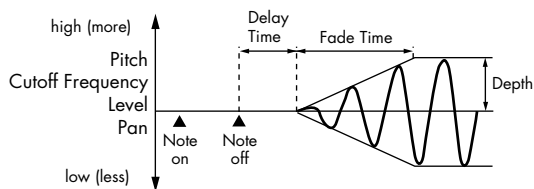

**Fade Mode:** OFF <  
**Delay Time:** Time from when the keyboard is released until the LFO begins to be applied  
**Fade Time:** Time over which the LFO amplitude will reach the maximum after the Delay Time has elapsed

#### ● Apply the LFO from when the key is pressed until it is released, and gradually begin to decrease the effect when the key is released

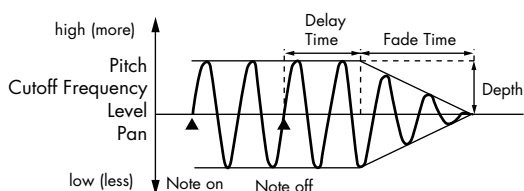

**Fade Mode:** OFF >  
**Delay Time:** Time that the LFO will continue after the keyboard is released  
**Fade Time:** Time over which the LFO amplitude will reach the minimum after the Delay Time has elapsed

### STEP LFO

Parameters indicated by ( **ZOOM** ) can be edited via ZOOM EDIT (p. 97).

Parameter	Value	Explanation
<b>Step Type</b> <b>ZOOM</b> Step Type	TYP1, TYP2	When generating an LFO waveform from the data specified in LFO Step 1–16, specify whether the level will change abruptly at each step or will be connected linearly. <b>TYP1:</b> stair-step change <b>TYP2:</b> linear change
<b>Step 1–16</b> <b>ZOOM</b> Step 1–16	-36–+36	Specifies the data for the Step LFO. If the LFO Pitch Depth is +63, each +1 unit of the step data corresponds to a pitch of +50 cents.

### OUTPUT

Parameter	Value	Explanation
<b>Patch Out Assign</b>	MFX, L+R, L, R, TONE	Specifies how the direct sound of each patch will be output. <b>MFX:</b> Output in stereo through multi-effects. You can also apply chorus or reverb to the sound that passes through multi-effects. <b>L+R:</b> Output in stereo to the OUTPUT jacks without passing through the multi-effect <b>L:</b> Output in mono to the OUTPUT L jack without passing through the multi-effect <b>R:</b> Output in mono to the OUTPUT R jack without passing through the multi-effect <b>TONE:</b> Outputs according to the settings for each tone.
<b>Tone Out Assign</b>	MFX, L+R, L, R	Specifies how the direct sound of each tone will be output. <b>MFX:</b> Output in stereo through multi-effects. You can also apply chorus or reverb to the sound that passes through multi-effects. <b>L+R:</b> Output in stereo to the OUTPUT jacks without passing through the multi-effect <b>L:</b> Output in mono to the OUTPUT L jack without passing through the multi-effect <b>R:</b> Output in mono to the OUTPUT R jack without passing through the multi-effect * If the Patch Out Assign is set to anything other than "TONE," these settings will be ignored. * If "Struct 1 & 2, 3 & 4" (p. 99) is set to TYPE 02–10, the settings for tone 1 (3) will follow the settings of tone 2 (4). (This is because the outputs of tones 1 and 2 are combined into tone 2, and the outputs of tones 3 and 4 are combined into tone 4.) * Sounds are output to chorus and reverb in mono at all times. * The output destination of the signal after passing through the chorus is set with the Chorus Output Select.
<b>Tone Out Level</b>	0–127	Level of the signal that is sent to the output destination specified by Tone Output Assign
<b>Send Level (Output = MFX)</b>		
<b>Tone Chorus Send</b>	0–127	Level of the signal sent to chorus for each tone if the tone is sent through MFX
<b>Tone Reverb Send</b>	0–127	Level of the signal sent to reverb for each tone if the tone is sent through MFX
<b>Send Level (Output = non MFX)</b>		
<b>Tone Chorus Send</b>	0–127	Level of the signal sent to chorus for each tone if the tone is not sent through MFX
<b>Tone Reverb Send</b>	0–127	Level of the signal sent to reverb for each tone if the tone is not sent through MFX

### Setting Effects for a Patch (Effects/MFX/MFX Control/Chorus/Reverb)

For details regarding effect settings, refer to the pages shown below.

- "Making Effect Settings" (p. 79)
- "Multi-Effect Settings (MFX 1–3)" (p. 84)
- "Chorus Settings (CHORUS)" (p. 86)
- "Reverb Settings (REVERB)" (p. 86)

## Chapter 8. Detailed Editing for Patches

### Detailed Settings for Piano Mode

#### MEMO

You should also take a look at the related information in “Playing in Piano Mode ([PIANO MODE])” (p. 25) in the Quick Start.

This chapter explains the more detailed settings that you can make in Piano mode.

#### Keep in mind when using Piano mode

- Patch editing is done in Patch mode. Pressing [EDIT] will take you to Patch mode.
- If you wish to use a hold pedal, we recommend that you use a Roland DP-10. The DP-10 will allow you to adjust the resonance of the sound by the depth to which you press the pedal.

### The PIANO MODE Screen

When you press [PIANO MODE] so it's lit, the PIANO MODE screen will appear.

Use the cursor buttons to select a parameter, and use the VALUE dial or [DEC] [INC] to edit the value.

The [2]–[7] buttons located below the display will execute the functions shown in the bottom line of the screen.

If you press [PIANO MODE] so its illumination is turned off, or if you press [7 (EXIT)] or [EXIT], you will exit Piano mode and enter Patch mode.

#### If you select [2 (AC.PIANO)]

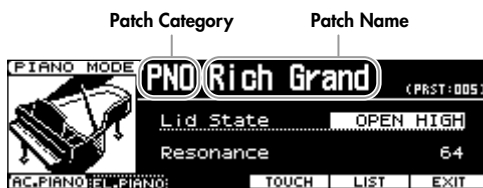

Indication	Content
Lid State	Adjusts the degree to which the lid is open (p. 117).
Resonance	On an acoustic piano, pressing the damper pedal will allow the strings of notes other than the keys you played to resonate sympathetically, creating a rich and spacious resonance. This parameter adjusts the degree of resonance.
[3 (EL.PIANO)]	Selects settings for playing electric piano.
[5 (TOUCH)]	Adjusts the keyboard touch (p. 117).
[6 (LIST)]	Displays a list of the patches you can select in Piano mode. → PIANO PATCH LIST screen
[7 (EXIT)]	Exits Piano mode.

#### If you select [3 (EL.PIANO)]

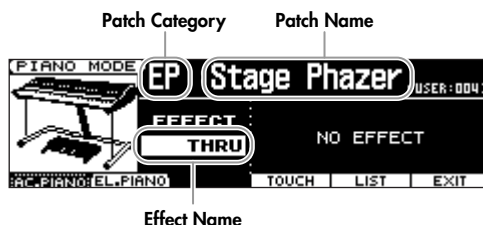

Indication	Content
EFFECT	Makes effect settings (p. 118). The parameters you can edit will depend on the effect that is selected.
[2 (AC.PIANO)]	Selects settings for playing acoustic piano.
[5 (TOUCH)]	Adjusts the keyboard touch (p. 117).
[6 (LIST)]	Displays a list of the patches you can select in Piano mode. → PIANO PATCH LIST screen
[7 (EXIT)]	Exits Piano mode.



## PIANO PATCH LIST Screen

In the PIANO MODE screen, press [6 (LIST)] to access the PIANO PATCH LIST screen.

You can use [◀] [▶] to choose “AC.PIANO” or “EL.PIANO.”

Use the VALUE dial or [DEC] [INC] to select a patch.

The [2]–[7] buttons located below the display will execute the functions shown in the bottom line of the screen.

Press [EXIT] to return to the PIANO MODE screen.



Indication	Content
[6 (SELECT)]	Confirms the patch you've selected in the list, and returns you to the PIANO MODE screen. If you press [EXIT] instead of pressing [6 (SELECT)], you will return to the PIANO MODE screen without changing the patch.
[7 (WRITE)]	Saves the settings (p. 119).

## Adjusting the Keyboard Touch (Key Touch)

- From the PIANO MODE screen, press [5 (TOUCH)].

The Key Touch Select window will appear.

- Use the VALUE dial or [DEC] [INC] to adjust the touch sensitivity.

Parameter	Value	Explanation
Key Touch Select	LIGHT	Light weight synthesizer keyboard like
	MEDIUM	Standard
	HEAVY	Acoustic piano simulation

- Press [7 (SELECT)].

The chosen Key Touch Select setting will be applied, and the window will close.

If you press [6 (CANCEL)] or [EXIT], the window will close without the current setting being changed.

### MEMO

This setting is shared by both “AC.PIANO” and “EL.PIANO.”

### MEMO

This setting is the “Keyboard Velocity Curve” system setting.

## Changing the degree to which the lid is open (Lid State)

- In the PIANO MODE (AC.PIANO) screen, use [▲] [▼] to move the cursor to “Lid State.”

- Use the VALUE dial or [DEC] [INC] to adjust the degree to which the grand piano's lid is open.

Parameter	Value	Explanation
Lid State	FULL OPEN, OPEN HIGH, OPEN MID, OPEN LOW, CLOSED, FULL CLOSED	The amount of resonance will increase as the lid is opened.

## Chapter 8. Detailed Editing for Patches

### Adjusting the Amount of Resonance (Resonance)

On an acoustic piano, pressing the damper pedal will allow the strings of notes other than the keys you played to resonate sympathetically, creating a rich and spacious resonance. This parameter adjusts the degree of resonance.

1. From the PIANO MODE (AC.PIANO) screen, use [ ▲ ] [ ▼ ] to move the cursor to "Resonance."
2. Use the VALUE dial or [DEC] [INC] to adjust the amount of resonance.

Parameter	Value	Explanation
Resonance	0–127	Increasing this value will increase the amount of resonance.

### Selecting an Effect for the Electric Piano (EFFECT)

Here you can select effects that are frequently used with an electric piano. The parameters that can be edited will depend on the effect you've selected.

1. In the PIANO MODE (EL.PIANO) screen, use the cursor buttons to move the cursor to the effect name (below "EFFECT").
2. Use the VALUE dial or [DEC] [INC] to change the effect.
3. Use the cursor buttons to select the parameter that you want to edit.
4. Use the VALUE dial or [DEC] [INC] to edit the value.

Effect name/ Parameter	Value	Explanation
<b>THRU: No effect will be applied.</b>		
<b>Tremolo: Cyclically modulates the volume. The sound will appear to waver.</b>		
Wave	TRI, SQR, SIN, SAW1, SAW2	Type of modulation
Rate	0.05–10.00	Frequency of modulation
Depth	0–127	Depth of effect
<b>Chorus: Adds a three-dimensional spaciousness and depth to the sound.</b>		
Rate	0.05–10.00	Frequency of modulation
Depth	0–127	Depth of modulation
Balance	D100:0W–D0:100W	Volume balance between the original sound (D) and chorus sound (W)
<b>Phaser: Adds a twisting character to the sound.</b>		
Manual	0–127	Center frequency at which the sound is modulated
Rate	0.05–10.00	Frequency of modulation
Depth	0–127	Depth of modulation
Resonance	0–127	Amount of feedback
<b>EQ: Adjusts the tone of the high, mid, and low frequency ranges.</b>		
Low Gain	-15 [dB]→+15 [dB]	Amount of boost/cut for the low frequency range
Mid1 Gain	-15 [dB]→+15 [dB]	Amount of boost/cut for the mid-1 frequency range
Mid2 Gain	-15 [dB]→+15 [dB]	Amount of boost/cut for the mid-2 frequency range
High Gain	-15 [dB]→+15 [dB]	Amount of boost/cut for the high frequency range
<b>Speaker: This simulates various speaker types as well as the settings for the microphone used to capture the sound from the speakers.</b>		
Speaker	SMALL 1, SMALL 2, MIDDLE, JC-120, BUILT-IN 1, BUILT-IN 2, BUILT-IN 3, BUILT-IN 4, BUILT-IN 5, BG STACK 1, BG STACK 2, MS STACK 1, MS STACK 2, METAL STACK, 2-STACK, 3-STACK	Type of speaker
Mic Level	0–127	Volume of the mic
Direct Level	0–127	Volume of the direct sound

#### MEMO

These effect settings are only for Piano mode. The effect you've specified in Piano mode will be applied regardless of the effect settings of the patch you've selected.

### Saving Your Piano Mode Settings

#### Saving a Patch Whose Settings You've Edited ([WRITE])

If you want to save a patch whose settings (Lid State, Resonance, EFFECT, etc.) you've edited in Piano mode, use [WRITE] to save the patch.

For details on saving a patch, refer to "Saving a Patch You've Created ([WRITE])" (p. 97).

#### **MEMO**

The "EFFECT" settings are only for Piano mode. The effect you've specified in Piano mode will be applied regardless of the effect settings of the patch you've selected.

#### Saving the Patch that will be Selected When You Press [PIANO MODE] (WRITE)

You can store the patch that will be selected first when you press [PIANO MODE] after the instrument's been powered up. This will also save the Key Touch setting (p. 117).

- 1. In the PIANO MODE screen, press [6 (LIST)].**  
The PIANO PATCH LIST screen will appear.
- 2. Use [◀] [▶] to choose "AC.PIANO" or "EL.PIANO," and use the VALUE dial or [DEC] [INC] to select a patch.**
- 3. Press [7 (WRITE)].**  
The patch selected in the list when you press [7 (WRITE)] will be the patch that is selected when you press [PIANO MODE] the next time you power up the JUNO-STAGE.

#### **NOTE**

Never turn off the power while data is being saved.

# Chapter 9. Detailed Settings for a Rhythm Set

“Editing” is the process of modifying the values of the JUNO-STAGE’s various settings (parameters). This chapter explains the procedure for editing a rhythm set, and describes the function of the rhythm set parameters.

Rhythm sets are selected from the patch group. This means that just as for patches, there will be three groups: user, preset, and GM. You also have the option of installing up to two wave expansion boards (SRX series; sold separately).

For more about patch groups, refer to “Chapter 8. Detailed Editing for Patches” (p. 94).

## Editing a Rhythm Set

You can create a new rhythm set by editing an existing rhythm set. A rhythm set is a collection of rhythm tones (percussion instrument sounds). To edit a rhythm set, you need to edit the settings of the rhythm tone assigned to each key.

The rhythm tone assigned to each key consists of up to four waves. The relationship between rhythm tones and waves is the same as the relationship between patches and tones.

## Editing in a Graphic Display (ZOOM EDIT)

The Zoom Edit screen lets you edit using a graphic display of important parameters that are edited frequently.

### MEMO

For details on the parameters, refer to p. 124 and following.

1. In Patch mode or Performance mode, select the rhythm set that you want to edit.

For details, refer to “Selecting Patches in Patch Mode” (p. 45) or “Selecting a Patch for Each Part” (p. 50).

### MEMO

If you want to create a rhythm set from scratch rather than starting from an existing one, execute the Initialize operation (p. 122).

2. Press [EDIT].
3. Press [3], or use the VALUE dial to select “RHYTHM EDIT” and then press [ENTER].  
The Zoom Edit screen will appear.



4. Press a key to specify the rhythm tone (A0–C8) that you want to edit.  
The specified key is shown in the upper right of the screen.

5. Press the [2]–[5] buttons to select the desired editing screen.

Button	Screen
[2 (PCH ENV)]	PITCH ENVELOPE (p. 126)
[3 (TVF PRM)]	TVF PARAMETER (p. 128)
[4 (TVF ENV)]	TVF ENVELOPE (p. 129)
[5 (TVA ENV)]	TVA ENVELOPE (p. 130)

6. Use the cursor buttons to select the parameter that you want to edit.
7. Press [TONE SWITCH/SELECT] so it’s lit, and use TONE SELECT [1]–[4] to select the wave that you want to edit.
  - To simultaneously edit the same parameter for multiple waves  
Simultaneously press TONE SELECT [1]–[4] corresponding to the waves that you want to edit, so they’re lit in red.
  - To switch waves on/off  
Press TONE SWITCH [1]–[4] to turn each wave on/off.
8. Use the VALUE dial or [DEC] [INC] to edit the value.  
If you’ve selected more than one wave for editing, all of these waves will be set to the same value.

### MEMO

In PRO EDIT (p. 121) you can edit while preserving the relative differences between waves.

9. Repeat steps 4–8 to edit the rhythm set as desired.
10. If you want to save the changes you’ve made, press [WRITE] (p. 123).  
If you decide not to save the changes, press [EXIT] to exit the ZOOM EDIT screen.

If you exit the ZOOM EDIT screen without saving, an “\*” will be displayed in the PATCH PLAY screen of Patch mode.

### NOTE

If you turn off the power or select a different sound when the “\*” is displayed, the patch settings you edited will be lost.

## Viewing and Editing All Parameters (PRO EDIT)

This shows the parameters of ZOOM EDIT, and additionally allows you to edit in greater detail.

### MEMO

For details on the parameters refer to p. 124 and following.

1. In Patch mode or Performance mode, select the patch that you want to edit.

For details, refer to "Selecting Patches in Patch Mode" (p. 45) or "Selecting a Patch for Each Part" (p. 50).

### MEMO

If you want to create a patch from scratch without using an existing patch, execute the Initialize operation (p. 122).

2. Press [EDIT].
3. Either press [3] or use the VALUE dial to select "RHYTHM EDIT," and then press [ENTER].  
The ZOOM EDIT screen will appear.
4. Press [7 (PRO EDIT)].  
The PRO EDIT screen will appear.
5. Press a key to select the rhythm tone (A0–C8) that you want to edit.
6. Use [3 (GRP ↑)] [4 (GRP ↓)] to switch between parameter groups.

### TIP

Alternatively, you can switch between parameter groups by pressing [2 (GRP LIST)] to access the Rhythm Pro Edit Menu window, then using the VALUE dial, [DEC] [INC], or [▲] [▼] to select the parameter group, and pressing [ENTER].

7. Use the cursor buttons to select a parameter.



8. Press [TONE SWITCH/SELECT] so it's lit, and use TONE SELECT [1]–[4] to select the wave that you want to edit.
  - To edit the same parameter of multiple waves simultaneously  
Simultaneously press TONE SELECT [1]–[4] for the waves that you want to edit, so they're lit in red.
  - To switch waves on/off  
Press TONE SWITCH [1]–[4] to switch waves on/off. You'll be editing the waves for which a check mark (✓) is shown for the tone numbers in the upper right of the screen.

9. Use the VALUE dial or [DEC] [INC] to edit the value.

If you've selected more than one wave for editing, their values will change while their relative differences are preserved.

10. Repeat steps 5–9 to edit the parameters as desired.

11. If you want to save the modified settings, press [WRITE] (p. 123).

If you decide not to save the changes you made, press [EXIT] to exit the PRO EDIT screen.

If you exit the PRO EDIT screen without saving, an "\*" will be displayed in the PATCH PLAY screen of Patch mode.

### NOTE

If you turn off the power or select a different sound when the "\*" is displayed, the patch settings you edited will be lost.

### Initializing a Rhythm Set

Here's how to return (initialize) the settings of the currently selected patch (rhythm set) to their default values. It is also possible to initialize only a specific key (rhythm tone) of the currently selected rhythm set.

#### NOTE

Initialization will affect only the currently selected rhythm set. If you want to return all settings to their factory-set state, execute the Factory Reset operation (p. 155).

- In Patch mode or Performance mode, select the user patch that you want to initialize.**  
For details, refer to "Selecting Patches in Patch Mode" (p. 45) or "Selecting a Patch for Each Part" (p. 50).
- Press [EDIT].
- Either press [3], or use the VALUE dial to select "RHYTHM EDIT" and press [ENTER].**  
The ZOOM EDIT screen will appear.
- If you want to initialize only a specific key, press that key to specify the key (A0–C8) that will be initialized.**  
The specified key is shown in the upper right of the screen.
- Hold down [SHIFT] and press [6 (INIT)].**  
The Rhythm Initialize window will open.
- Use [▲] [▼] to specify the initialization method.**

Value	Meaning
All	All keys of the rhythm set will be initialized.
Key	Only the key you specified in step 4 will be initialized.
- Press [7 (SELECT)].  
A confirmation message will appear.  
If you decide to cancel, press [6 (CANCEL)].
- Press [7 (EXEC)] to carry out the initialization.

### Copying Rhythm Set (Rhythm Tone) Settings

Here's how to copy the tone settings of a desired rhythm set to the currently selected patch.

- In Patch mode or Performance mode, select the copy-destination user patch.**  
For details, refer to "Selecting Patches in Patch Mode" (p. 45) or "Selecting a Patch for Each Part" (p. 50).
- Press [EDIT].
- Either press [3], or use the VALUE dial to select "RHYTHM EDIT" and press [ENTER].**  
The ZOOM EDIT screen will appear.
- Hold down [SHIFT] and press [7 (TONE CPY)].**  
The Rhythm Tone Copy window will appear.



- Use the cursor buttons to move the cursor, and use the VALUE dial or [DEC] [INC] to select the "Source (copy-source)" group, number, and tone.**  
If you press [5 (COMPR)] to apply a check mark (✓), you'll be able to play the copy-source rhythm set (Compare function).
- Use the cursor buttons to move the cursor, and select the "Destination (copy-destination)" tone.**
- Press [7 (EXEC)].  
A confirmation message will appear.  
If you decide to cancel, press [6 (CANCEL)].
- Press [7 (EXEC)] to execute the copy.

#### Compare function

When copying or saving rhythm set tones, it's often convenient to use the Compare function.

If you want to hear the copy-source (or save-destination) rhythm set, press [5 (COMPR)] to apply a check mark (✓); now you can use the keyboard to play the copy-source (or save-destination) rhythm set.

\* The rhythm set may sound slightly different than normal when played via the Compare function.

## Saving a Rhythm Set You've Created ([WRITE])

Changes you make are temporary, and will be lost when you turn off the power or select another patch (rhythm set). If you want to keep the rhythm set you modified, you must save it to internal user memory.

When you edit the settings of a rhythm set in Patch mode, an "\*" will be shown in the PATCH PLAY screen. If you've edited a patch in Performance mode, you should also save the performance after saving the patch (p. 133).

### NOTE

When you save, the data that previously occupied the save destination will be overwritten.

#### 1. Edit a rhythm set.

#### 2. Press [WRITE].

The RHYTHM SET NAME screen will appear.

If you're in Performance mode, the WRITE MENU screen will appear. Pressing [3 (PAT/RHY)] will access the RHYTHM SET NAME screen.



#### 3. Assign a name to the rhythm set.

For details on assigning a name, refer to p. 44.

#### 4. When you've finished assigning a name, press [7 (WRITE)].

A screen allowing you to select the save destination will appear.

#### 5. Use the VALUE dial, [DEC] [INC], or [▲] [▼] to select the save-destination rhythm set number.

If you press [5 (COMPR)] to apply a check mark (✓), you'll be able to play the save-destination rhythm set (Compare function).

#### 6. Press [7 (WRITE)].

A confirmation message will appear.

If you decide to cancel, press [6 (CANCEL)].

#### 7. Press [7 (EXEC)] to save the rhythm set.

### NOTE

Never turn off the power while data is being saved.

### Note when selecting a waveform

The JUNO-STAGE uses complex PCM waveforms as the basis for its sounds. For this reason, you should be aware that if you specify a waveform that is very different than the original waveform, the result may not be what you expect.

The JUNO-STAGE's internal waveforms can be categorized into the following two types.

#### One-shot:

These are sounds with a short decay time. One-shot waveforms contain the entire duration of the sound from the attack until it decays to silence. Some of these waveforms capture a complete sound such as a percussion instrument, but there are also many attack component sounds such as the hammer strike of a piano or the fret noise of a guitar.

#### Loop:

These are sounds with a long decay, or sustaining sounds. Looped waveforms will repeatedly play a portion of a sound once it has reached a relatively stable state. These sounds also include numerous component sounds such as a vibrating piano string or a resonating pipe.

The following illustration shows an example of a sound created by combining a one-shot waveform with a loop waveform. (This example is of an electric organ.)

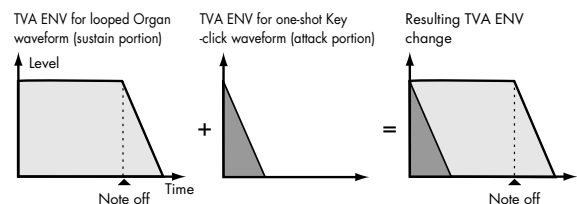

### Note when selecting a one-shot waveform

It's not possible to use the envelope settings to give a one-shot waveform a longer decay than the original waveform contains, or to make it a sustaining sound. Even if you made this type of envelope setting, you would be trying to bring out something that doesn't exist in the original waveform.

### Note when selecting a looped waveform

Many acoustic instruments such as piano or sax are marked by a sudden change in timbre at the very beginning of the sound, and this rapid change is what gives the instrument its distinctive character. When using these waveforms, it's best to use the complex tonal changes in the attack portion of the sound without attempting to modify them; use the envelope only to modify the decay portion of the sound as desired. If you use the envelope to modify the attack as well, the envelope settings will be affected by the attack of the waveform itself, and you may not get the result you intend.

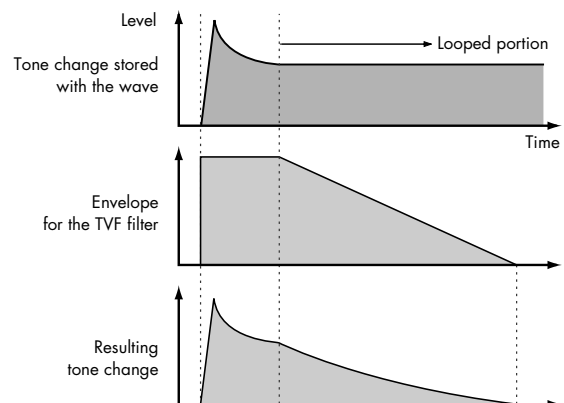

### Functions of Rhythm Set Parameters

#### Settings Common to the Entire Rhythm Set

##### GENERAL

Parameter	Value	Explanation
Rhythm Level	0–127	Volume of the rhythm set
Rhythm Tone Name	You can assign a name of up to 12 characters to the rhythm tone. Press [ ◀ ] [ ▶ ] to move the cursor, and use the VALUE dial or [DEC] [INC] to select characters.	

##### CONTROL

Parameter	Value	Explanation
Assign Type	MULTI, SINGLE	Sets the way sounds are played when the same key is pressed a number of times. <b>MULTI:</b> Layer the sound of the same keys. Even with continuous sounds where the sound plays for an extended time, such as with crash cymbals, the sounds are layered, without previously played sounds being eliminated. <b>SINGLE:</b> Only one sound can be played at a time when the same key is pressed. With continuous sounds where the sound plays for an extended time, the previous sound is stopped when the following sound is played.
Mute Group	OFF, 1–31	The Mute Group function allows you to designate two or more rhythm tones that are not allowed to sound simultaneously. On an actual acoustic drum set, an open hi-hat and a closed hi-hat sound can never occur simultaneously. To reproduce the reality of this situation, you can set up a Mute Group. Up to 31 Mute Groups can be used. Rhythm tones that do not belong to any such group should be set to "OFF."
Tone Env Mode	NO-SUS, SUSTAIN	When a loop waveform (p. 123) is selected, the sound will normally continue as long as the key is pressed. If you want the sound to decay naturally even if the key remains pressed, set this to "NO-SUS." * If a one-shot type wave (p. 123) is selected, it will not sustain even if this parameter is set to "SUSTAIN."
Tone Pitch Bend Range	0–48	Amount of pitch change in semitones (4 octaves) that will occur when the Pitch Bend Lever is moved The amount of change when the lever is tilted is set to the same value for both left and right sides.
One Shot Mode	OFF, ON	<b>ON:</b> The sound will play back until the end of the waveform (or the end of the envelope, whichever comes first).
Relative Level	-64+63	Adjusts the volume of the rhythm tone. This parameter is set by the system exclusive message Key Based Controller. Normally, you can leave it set to 0. <b>NOTE</b> If the rhythm tone level is set to 127, the volume cannot be raised any farther.

##### RECEIVE

Parameter	Value	Explanation
Tone Receive Expression	OFF, ON	For each rhythm tone, specify whether MIDI Expression messages will be received (ON), or not (OFF).
Tone Receive Hold-1	OFF, ON	For each rhythm tone, specify whether MIDI Hold-1 messages will be received (ON), or not (OFF). * If "NO-SUS" is selected for Env Mode parameter, this setting will have no effect.
Tone Receive Pan Mode	CONTINUOUS, KEY-ON	For each rhythm tone, specify how pan messages will be received. <b>CONTINUOUS:</b> Whenever Pan messages are received, the stereo position of the tone will be changed. <b>KEY-ON:</b> The pan of the tone will be changed only when the next note is played. If a pan message is received while a note is sounding, the panning will not change until the next key is pressed. * The channels cannot be set so as not to receive Pan messages.



## Modifying Waveforms/Pitch/Pitch Envelope

### WAVE PARAMETER

Parameter	Value	Explanation
<b>Wave Group</b>	INT, EXP	Group containing the waveforms comprising the rhythm tone <b>INT:</b> Waveforms stored in internal <b>EXP:</b> Waveform stored in a Wave Expansion Board (SRX series) installed in EXP slots
<b>Wave Bank</b>	A, B	When the Wave Group is EXP <b>A, B:</b> Wave expansion board slots
<b>Wave No. L (Mono) Wave No. R</b>	—, 1–	Waves comprising the rhythm tone (The upper limit will depend on the Wave Group and Wave Bank.) When in monaural mode, only the left side (L) is specified. When in stereo, the right side (R) is also specified. If you want to select a left/right pair of Waves, select the left (L) Wave number, and then hold down [SHIFT] and press [5 (STEREO)] to add a check mark (✓); the right (R) (Wave) will be recalled.
<b>Wave Gain</b>	-6, 0, +6, +12	Gain (amplification) of the waveform The value changes in 6 dB (decibel) steps—an increase of 6 dB doubles the waveform's gain.
<b>Wave Tempo Sync</b>	OFF, ON	When you wish to synchronize a Phrase Loop to the clock (tempo), set this to "ON." * This is valid only when a separately sold wave expansion board is installed, and a waveform that indicates a tempo (BPM) is selected. If a waveform from a wave expansion board is selected for the tone, turning the Wave Tempo Sync parameter "ON" will cause pitch-related settings and FXM-related settings to be ignored.
<b>FXM Switch</b>	OFF, ON	This sets whether FXM will be used (ON) or not (OFF).
<b>FXM Color</b>	1–4	How FXM will perform frequency modulation Higher settings result in a grainier sound, while lower settings result in a more metallic sound.
<b>FXM Depth</b>	0–16	Depth of the modulation produced by FXM

#### Phrase Loop

Phrase loop refers to the repeated playback of a phrase that's been pulled out of a song (e.g., by using a sampler). One technique involving the use of Phrase Loops is the excerpting of a Phrase from a pre-existing song in a certain genre, for example dance music, and then creating a new song with that Phrase used as the basic motif. This is referred to as "Break Beats."

#### FXM

FXM (Frequency Cross Modulation) uses a specified waveform to apply frequency modulation to the currently selected waveform, creating complex overtones. This is useful for creating dramatic sounds or sound effects.

## Chapter 9. Detailed Settings for a Rhythm Set

### WAVE PITCH

Parameter	Value	Explanation
Tone Coarse Tune	0 (C <sub>2</sub> )- 127 (G <sub>9</sub> )	Pitch at which a rhythm tone sounds Set the coarse tuning for Waves comprising the rhythm tones with the Wave Coarse Tune parameter (p. 127).
Tone Fine Tune	-50→+50	Pitch of the rhythm tone's sound (in 1-cent steps; one cent is 1/100th of a semitone) Set the fine tuning for Waves comprising the rhythm tones with the Wave Fine Tune parameter (p. 127).
Tone Random Pitch Depth	0-1200	Width of random pitch deviation that will occur each time a key is pressed (in 1-cent steps) If you do not want the pitch to change randomly, set this to "0."

### WAVE PITCH ENV

Parameters indicated by ( **ZOOM** ) can be edited via ZOOM EDIT (p. 120).

Parameter	Value	Explanation
P-Env Depth ( <b>ZOOM</b> ) Env Depth	-12→+12	Depth of the Pitch Envelope Higher settings will cause the pitch envelope to produce greater change. Negative (-) settings will invert the shape of the envelope.
P-Env V-Sens	-63→+63	Keyboard playing dynamics can be used to control the depth of the pitch envelope. If you want the pitch envelope to have more effect for strongly played notes, set this parameter to a positive (+) value.
P-Env T1 V-Sens	-63→+63	This allows keyboard dynamics to affect the T1 of the Pitch envelope. If you want T1 to be speeded up for strongly played notes, set this parameter to a positive (+) value.
P-Env T4 V-Sens	-63→+63	Use this parameter when you want key release speed to affect the T4 value of the Pitch envelope. If you want T4 to be speeded up for quickly released notes, set this parameter to a positive (+) value.
P-Env Time 1-4 ( <b>ZOOM</b> ) Time 1-4	0-127	Pitch envelope times (T1-T4) Higher settings will result in a longer time until the next pitch is reached.
P-Env Level 0-4 ( <b>ZOOM</b> ) Level 0-4	-63→+63	Pitch envelope levels (L0-L4) Specify how the pitch will change at each point, relative to the pitch set with Coarse Tune or Fine Tune.

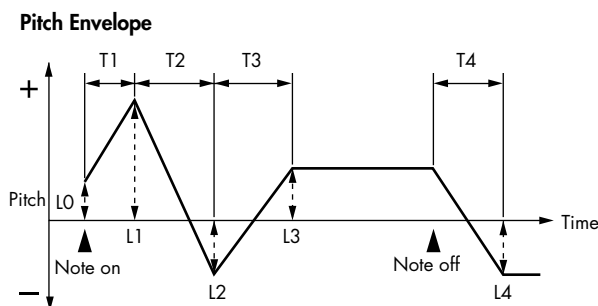

## WAVE MIX Parameters

### WAVE MIX LV/PN

Parameter	Value	Explanation
Wave Level	0-127	Volume of the waveform
Wave Pan	L64-0-63R	Left/right position of the waveform
Wave Rnd Pan Sw	OFF, ON	Use this setting to cause the waveform's panning to change randomly each time a key is pressed (ON) or not (OFF). The range of the panning change is set by the Random Pan Depth parameter (p. 130).
Wave Alter Pan Sw	OFF, ON, REVS	This setting causes panning of the waveform to be alternated between left and right each time a key is pressed. Set this to "ON" to pan the wave according to the Alternate Pan Depth parameter (p. 130) settings, or to "REVS" when you want the panning reversed.

### WAVE MIX TUNE

Parameter	Value	Explanation
Wave Coarse Tune	-48-+48	Pitch of the waveform's sound (in semitones, +/-4 octaves)
Wave Fine Tune	-50-+50	Pitch of the waveform's sound (in 1-cent steps; one cent is 1/100th of a semitone)

### VELOCITY RANGE

You can use the force with which keys are played to control the way each waveform is played.

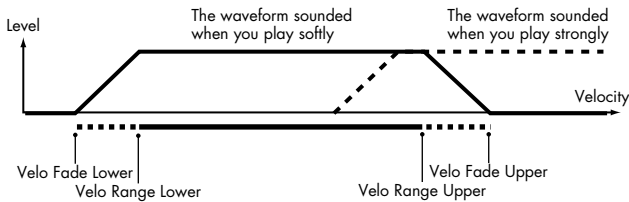

Parameter	Value	Explanation
Velocity Control	OFF, ON, RAN	Determines whether a different waveform is played (ON) or not (OFF) depending on the force with which the key is played (velocity). <b>RAN:</b> The rhythm tone's constituent waveforms will sound randomly, regardless of any Velocity messages.
Velo Fade Lower	0-127	Determines what will happen to the waveform's level when the rhythm tone is played at a velocity lower than Velo Range Lower. If you don't want the waveform to sound at all, set this parameter to "0."
Velo Range Lower	1-(UPPER)	Specifies the lowest velocity at which the waveform will sound.
Velo Range Upper	(LOWER)-127	Specifies the highest velocity at which the waveform will sound.
Velo Fade Upper	0-127	Determines what will happen to the waveform's level when the rhythm tone is played at a velocity greater than Velo Range Upper. If you don't want the waveform to sound at all, set this parameter to "0."

## Chapter 9. Detailed Settings for a Rhythm Set

### Modifying the Brightness of a Sound with a Filter (TVF/TVF Envelope)

A filter cuts or boosts a specific frequency region to change a sound's brightness, thickness, or other qualities.

#### TVF PARAMETER

Parameters indicated by ( **ZOOM** ) can be edited via ZOOM EDIT (p. 120).

Parameter	Value	Explanation
<b>Filter Type</b> <b>ZOOM</b> Filter Type	OFF, LPF, BPF, HPF, PKG, LPF2, LPF3	Type of filter <b>OFF:</b> No filter is used. <b>LPF:</b> Low Pass Filter. This reduces the volume of all frequencies above the cutoff frequency in order to round off, or un-brighten the sound. <b>BPF:</b> Band Pass Filter. This leaves only the frequencies in the region of the cutoff frequency, and cuts the rest. This can be useful when creating distinctive sounds. <b>HPF:</b> High Pass Filter. This cuts the frequencies in the region below the cutoff frequency. This is suitable for creating percussive sounds emphasizing their higher tones. <b>PKG:</b> Peaking Filter. This emphasizes the frequencies in the region of the cutoff frequency. You can use this to create wah-wah effects by employing an LFO to change the cutoff frequency cyclically. <b>LPF2:</b> Low Pass Filter 2. Although frequency components above the cutoff frequency are cut, the sensitivity of this filter is half that of the LPF. This filter is good for use with simulated instrument sounds such as the acoustic piano. <b>LPF3:</b> Low Pass Filter 3. Although frequency components above the cutoff frequency are cut, the sensitivity of this filter changes according to the cutoff frequency. While this filter is also good for use with simulated acoustic instrument sounds, the nuance it exhibits differs from that of the LPF2, even with the same TVF Envelope settings. * If you set "LPF2" or "LPF3," the setting for the Resonance parameter will be ignored.
<b>Cutoff Frequency</b> <b>ZOOM</b> Cutoff	0-127	Frequency at which the filter begins to have an effect on the waveform's frequency components
<b>Resonance</b> <b>ZOOM</b> Resonance	0-127	Emphasizes the portion of the sound in the region of the cutoff frequency, adding character to the sound. * Excessively high settings can produce oscillation, causing the sound to distort.

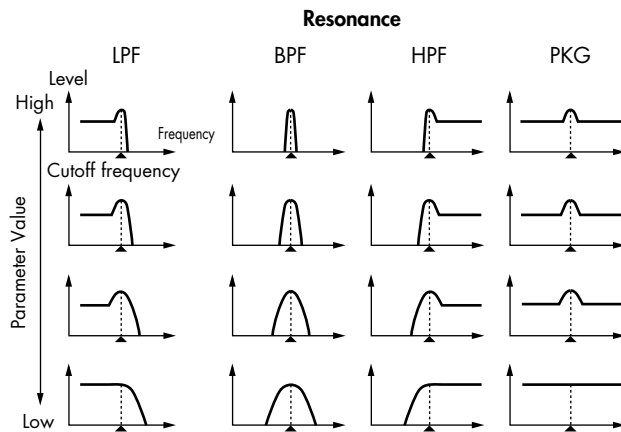

Parameter	Value	Explanation
<b>Cutoff V-Curve</b>	FIX, 1-7	Curve that determines how keyboard playing dynamics (velocity) will affect the cutoff frequency. Set this to "FIX" if you don't want the cutoff frequency to be affected by the keyboard velocity. 
<b>Cutoff V-Sens</b>	-63+63	Use this parameter when changing the cutoff frequency to be applied as a result of changes in playing velocity. If you want strongly played notes to raise the cutoff frequency, set this parameter to positive (+) settings.
<b>Resonance V-Sens</b>	-63+63	This allows keyboard velocity to modify the amount of Resonance. If you want strongly played notes to have a greater Resonance effect, set this parameter to positive (+) settings.

## TVF ENVELOPE

Parameters indicated by ( **ZOOM** ) can be edited via ZOOM EDIT (p. 120).

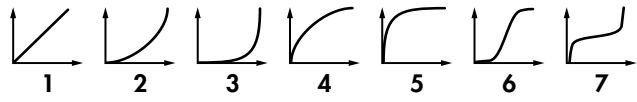
Parameter	Value	Explanation
F-Env Depth <b>ZOOM</b> Env Depth	-63--+63	Depth of the TVF envelope Higher settings will cause the TVF envelope to produce greater change. Negative (-) settings will invert the shape of the envelope.
F-Env V-Curve	FIX, 1-7	Curve that determines how keyboard playing dynamics (velocity) will affect the TVF envelope Set this to "FIX" if you don't want the TVF Envelope to be affected by the keyboard velocity. 
F-Env V-Sens	-63--+63	Specifies how keyboard playing dynamics will affect the depth of the TVF envelope. Positive (+) settings will cause the TVF envelope to have a greater effect for strongly played notes, and negative (-) settings will cause the effect to be less.
F-Env T1 V-Sens	-63--+63	This allows keyboard dynamics to affect the T1 of the TVF envelope. If you want T1 to be speeded up for strongly played notes, set this parameter to a positive (+) value.
F-Env T4 V-Sens	-63--+63	Use this parameter when you want key release speed to affect the T4 value of the TVF envelope. If you want T4 to be speeded up for quickly released notes, set this parameter to a positive (+) value.
F-Env Time 1-4 <b>ZOOM</b> Time 1-4	0-127	TVF envelope times (T1-T4) Higher settings will lengthen the time until the next cutoff frequency level is reached.
F-Env Level 0-4 <b>ZOOM</b> Level 0-4	0-127	TVF envelope levels (L0-L4) Specify how the cutoff frequency will change at each point, relative to the Cutoff Frequency value.

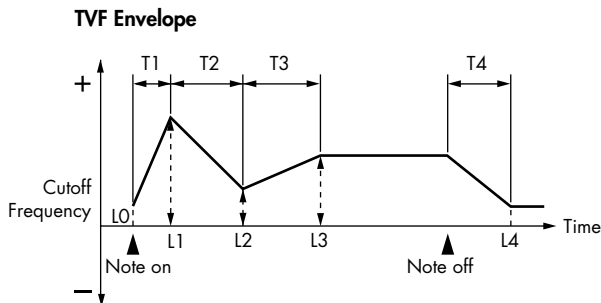

## Chapter 9. Detailed Settings for a Rhythm Set

### Adjusting the Volume (TVA/TVA Envelope)

#### TVA PARAMETER

Parameter	Value	Explanation
Tone Level	0-127	Volume of the rhythm tone This setting is useful primarily for adjusting the volume balance between rhythm ones.
Level V-Curve	FIX, 1-7	Curve that determines how keyboard playing dynamics (velocity) will affect the volume Set this to "FIX" if you don't want the volume of the tone to be affected by the keyboard velocity. 
Level V-Sens	-63+63	Set this when you want the volume of the tone to change depending on keyboard playing dynamics. Set this to a positive (+) value to have the changes in tone volume increase the more forcefully the keys are played; to make the tone play more softly as you play harder, set this to a negative (-) value.
Tone Pan	L64-0-63R	Left/right position of the rhythm tone
Random Pan Depth	0-63	Use this parameter when you want the stereo location to change randomly each time you press a key. Higher settings will produce a greater amount of change.
Alternate Pan Depth	L63-0-63R	This setting causes panning to be alternated between left and right each time a key is pressed. Higher settings will produce a greater amount of change. "L" or "R" settings will reverse the order in which the pan will alternate between left and right. For example if two rhythm tones are set to "L" and "R" respectively, the panning of the two rhythm tones will alternate each time they are played.

#### TVA ENVELOPE

Parameters indicated by ( **ZOOM** ) can be edited via ZOOM EDIT (p. 120).

Parameter	Value	Explanation
A-Env T1 V-Sens	-63+63	This allows keyboard dynamics to affect the T1 of the TVA envelope. If you want Time 1 to be speeded up for strongly played notes, set this parameter to a positive (+) value. If you want it to be slowed down, set this to a negative (-) value.
A-Env T4 V-Sens	-63+63	Use this parameter when you want key release speed to affect the T4 value of the TVA envelope. If you want T4 to be speeded up for quickly released notes, set this parameter to a positive (+) value. If you want it to be slowed down, set this to a negative (-) value.
A-Env Time 1-4 <b>ZOOM</b> Time 1-4	0-127	TVA envelope times (T1-T4) Higher settings will lengthen the time until the next volume level is reached.
A-Env Level 1-3 <b>ZOOM</b> Level 1-3	0-127	TVA envelope levels (L1-L3) Specify how the volume will change at each point, relative to the Tone Level value.

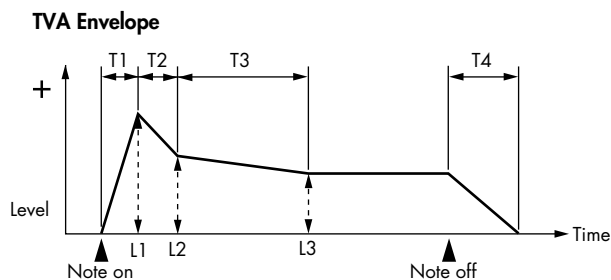

### Output Settings (OUTPUT)

Parameter	Value	Explanation
<b>Rhythm Out Assign</b>	MFX, L+R, L, R, TONE	Specifies for each rhythm set how the direct sound will be output. <b>MFX:</b> Output in stereo through multi-effects. You can also apply chorus or reverb to the sound that passes through multi-effects. <b>L+R:</b> Output in stereo to the OUTPUT jacks without passing through the multi-effect <b>L:</b> Output in mono to the OUTPUT L jack without passing through the multi-effect <b>R:</b> Output in mono to the OUTPUT R jack without passing through the multi-effect <b>TONE:</b> Outputs according to the settings for each rhythm tone.
<b>Tone Out Assign</b>	MFX, L+R, L, R	Specifies how the direct sound of each rhythm tone will be output. <b>MFX:</b> Output in stereo through multi-effects. You can also apply chorus or reverb to the sound that passes through multi-effects. <b>L+R:</b> Output in stereo to the OUTPUT jacks without passing through the multi-effect <b>L:</b> Output in mono to the OUTPUT L jack without passing through the multi-effect <b>R:</b> Output in mono to the OUTPUT R jack without passing through the multi-effect * If the Rhythm Out Assign is set to anything other than "TONE," these settings will be ignored. * Sounds are output to chorus and reverb in mono at all times. * The output destination of the signal after passing through the chorus is set with the Chorus Output Select parameters (p. 81).
<b>Tone Out Level</b>	0-127	Level of the signal that is sent to the output destination specified by Tone Out Assign
<b>Send Level (Output = MFX)</b>		
<b>Tone Chorus Send</b>	0-127	Level of the signal sent to chorus for each rhythm tone if the tone is sent through MFX
<b>Tone Reverb Send</b>	0-127	Level of the signal sent to reverb for each rhythm tone if the tone is sent through MFX
<b>Send Level (Output = non MFX)</b>		
<b>Tone Chorus Send</b>	0-127	Level of the signal sent to chorus for each rhythm tone if the tone is not sent through MFX
<b>Tone Reverb Send</b>	0-127	Level of the signal sent to reverb for each rhythm tone if the tone is not sent through MFX

### Setting Effects for a Rhythm Set (Effects/MFX/MFX Control/Chorus/Reverb)

For details regarding effect settings, refer to the pages shown below.

- "Making Effect Settings" (p. 79)
- "Multi-Effect Settings (MFX 1-3)" (p. 84)
- "Chorus Settings (CHORUS)" (p. 86)
- "Reverb Settings (REVERB)" (p. 86)

# Chapter 10. Detailed Editing for Performances

The JUNO-STAGE's performances are organized into two groups: User and Preset.

## USER

This is a group of rewritable performances inside the JUNO-STAGE. The performances you create can be saved in this group. When the JUNO-STAGE is shipped from the factory, this group already contains 64 performances.

## PRST (preset)

This is a group of non-rewritable performances inside the JUNO-STAGE. Although these performances cannot be rewritten, you are free to edit the settings of the currently selected performance, and then save the modified settings in the user performance group.

## How to Edit a Performance

A performance contains the patch (rhythm set) assignments for all of the parts, and includes settings such as volume and pan for each part. When you switch performances, the settings it contains for parts 1–16 will be called up, along with various other settings that determine how the JUNO-STAGE responds to your playing.

1. Press [PERFORM].  
The PERFORM PLAY screen will appear.
2. Select the performance that you want to edit.  
For details on how to select a performance, refer to "Selecting a Performance" (p. 49).
3. Use the function buttons to access the desired editing screen.  
For details, refer to the explanation of each screen.
4. Use the cursor buttons to select the parameter that you want to edit.
5. Use the VALUE dial or [DEC] [INC] to edit the value.
6. When you've finished editing, press [EXIT].  
You will return to the PERFORM PLAY screen.  
If you return to the PERFORM PLAY screen without saving the changes you made, an "\*" will be displayed at the left of the performance group.  
If you turn off the power or select a different sound when the "\*" is displayed, the changes you made will be discarded. If you want to keep the changes, save the performance (p. 133).

## Initializing a Performance

Here's how to initialize the settings of the currently selected performance to their default values.

### NOTE

Initialization will affect only the currently selected performance. If you want to return all settings to their factory-set state, execute the Factory Reset operation (p. 155).

1. In the PERFORM PLAY screen, select the performance that you want to initialize.
2. Hold down [SHIFT] and press [7 (INIT)].  
The Performance Initialize window will appear.
3. Use [▲] [▼] to select the desired method of initialization.

Setting	Content
Default	Initializes the settings of the currently selected performance to their default values.
Sound Control	Initializes the following part parameters. Cutoff Offset, Resonance Offset, Attack Time Offset, Release Time Offset, Decay Time Offset, Vibrato Rate, Vibrato Depth, Vibrato Delay

4. Press [7 (SELECT)].  
A confirmation message will appear.  
If you decide to cancel, press [6 (CANCEL)].
5. Press [7 (EXEC)] to initialize the settings.



## Editing the Patch That's Assigned to a Part

When you use a patch (or rhythm set) in Performance mode, its effects and some other settings will be affected by the settings of the performance. To edit the patch (or rhythm set) in the context of these performance settings, proceed as follows.

1. Make sure that [PERFORM] is lit.
2. Press [EDIT].
3. Either press [3], or use the VALUE dial to select "PATCH EDIT" (or "RHYTHM EDIT") and press [ENTER].

Now you can edit the patch that's assigned to the currently selected part. For details on patch editing, refer to "Chapter 8. Detailed Editing for Patches" (p. 94) or "Chapter 9. Detailed Settings for a Rhythm Set" (p. 120).

### MEMO

After you've finished editing the patch, press [WRITE] to save the patch (p. 133).

## Saving a Performance You've Created ([WRITE])

Changes you make are temporary, and will be lost when you turn off the power or select another performance. If you want to keep the performance you've edited, you must save it to internal user memory. If you've edited a performance, an "\*" will be shown in the PERFORM PLAY screen.

### NOTE

When you save, the data that previously occupied the save destination will be overwritten.

1. Edit a performance.
2. Press [WRITE].  
The WRITE MENU screen will appear.
3. Press [2 (PERF)].  
Alternatively, you can use [▲] [▼] to select "Performance," and then press [ENTER].  
The PERFORMANCE NAME screen will appear.
4. Assign a name to the performance.  
For details on assigning a name, refer to p. 44.
5. When you've finished assigning a name, press [7 (WRITE)].  
A screen allowing you to select the save destination will appear.
6. Use the VALUE dial, [DEC] [INC], or [▲] [▼] to select the save-destination performance number.
7. Press [7 (WRITE)].  
A confirmation message will appear.  
If you decide to cancel, press [6 (CANCEL)].
8. Press [7 (EXEC)] to save the performance.

### NOTE

Never turn off the power while data is being saved.

## If You've Edited a Patch or Rhythm Set Assigned to a Part of the Performance

If you've edited a patch or rhythm set assigned to a part of the performance and attempt to save the performance without having saved the edited patch or rhythm set, a message like the following will appear.

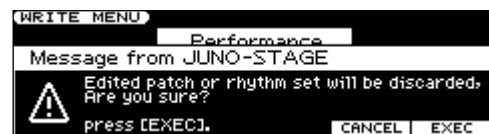

In this case, save the patch or rhythm set before you save the performance.

## Performance Edit Screens and Parameters

### PERFORM PLAY Screen



When you press [PERFORM], the PERFORM PLAY screen will appear.

Use the [2]–[7] buttons located below the display to execute the functions shown in the bottom line of the screen.

#### NOTE

You can't use the function buttons if FAVORITE [ON/OFF] is on. If you want to use the function buttons, turn off FAVORITE [ON/OFF].

Button	Content
[2 (KBD SW)]	Opens the Keyboard Switch window, where you can select the parts that will produce sound.
[3 (CONTROL)]	Accesses the CTRL SETTING (PERF) screen, where you can edit the controller settings (p. 135).
[4 (KEYRANG)]	Opens the Key Range window, where you can specify the key range for each part.
[5 (MIDI)]	Accesses the MIDI FILTER screen, where you can turn MIDI message reception on/off for each MIDI channel (p. 138).
[6 (MIXER)]	Accesses the PART MIXER screen, where you can edit the volume and panning (p. 139).
[7 (PARTVIEW)]	Accesses the PART VIEW screen, where you can view a list of each part's settings and edit them in detail (p. 140).

### Selecting the Parts that will Produce Sound (Keyboard Switch)

Here's how to select the parts that will play a patch or rhythm set. Each part has a "keyboard switch" that determines whether it can be played from the keyboard.

1. In the PERFORM PLAY screen, press [2 (KBD SW)].

The Keyboard Switch window will open.

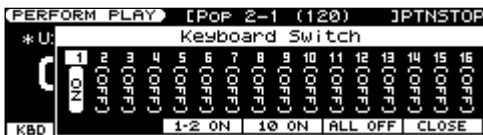

2. Use [◀] [▶] to select a part.
3. Use the VALUE dial, [DEC] [INC], or [▲] [▼] to select "ON" or "OFF."
 

When you play the keyboard, you'll hear the parts whose keyboard switch is "ON" and the part that is currently selected. You can also use the following function buttons to turn this on/off.

  - Pressing [4 (1-2 ON)] will turn part 1 and part 2 on.
  - Pressing [5 (10 ON)] will turn part 10 on.
  - Pressing [6 (ALL OFF)] will turn all parts off.
4. Repeat steps 2–3 to turn the Keyboard Switch "ON" for each part that you want to play from the keyboard.
5. Press [7 (CLOSE)].
 

The Keyboard Switch window will close.

### Specifying the Range of Each Part (Key Range)

In Performance mode you can specify the key range of each part, allowing you to divide the keyboard into as many as sixteen zones, and play a different sound in each.

The keyboard zone to which each part will respond is determined by the part's "key range" setting.

1. In the PERFORM PLAY screen, press [4 (KEYRANG)].

The Key Range window will open.

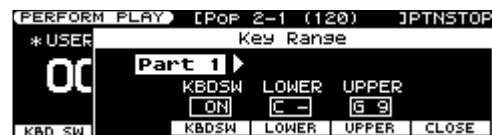

2. Use the cursor buttons to move the cursor to the part name, and use [◀] [▶] to select the part that you want to edit.
3. Use the cursor buttons or [4 (KBDSW)]–[6 (UPPER)] to select a parameter.
4. Use the VALUE dial or [DEC] [INC] to set the value.

Parameter	Value	Explanation
KBDSW	OFF, ON	Turns the sound of the part on/off
LOWER	C - -(UPPER)	Specifies the lower limit of the key range
UPPER	(LOWER)–G9	Specifies the upper limit of the key range

5. When you've finished making settings, press [7 (CLOSE)].

The Key Range window will close.

#### TIP

By overlapping the key range of two or more parts, you can layer those parts so that they will sound together.

## Making Settings for the D Beam Controller and Other Controllers

You can assign a variety of functions to controllers such as the D Beam Controller and the buttons.

### CTRL SETTING (PERF) Screen



In the PERFORM PLAY screen, press [3 (CONTROL)] to access this screen.

Use the cursor buttons to select the parameter you want to edit, and use the VALUE dial or [DEC] [INC] to set its value.

The [2]–[7] buttons located below the display provide access to the edit screens indicated in the bottom line of the screen.

When you’ve finished making settings, press [EXIT] to return to the PERFORM PLAY screen.

**MEMO**

For more about D Beam settings, refer also to “Using the D Beam Controller to Modify the Sound” (p. 56).

Button	Content
[2 (TEMPO)]	Specifies the tempo of the performance.
[3 (S1/S2)]	Specifies the functions controlled by the [S1] and [S2] buttons.
[4 (DB ASGN)]	Specifies the function controlled by the D Beam controller.
[5 (DB EXP)]	Makes settings for when using the D Beam controller to control active expression. For details on these parameters, refer to System settings “[4 (ATV EXP)]” (p. 153). * These are system settings. To save them, press [7 (WRITE)] in the edit screen to save the system settings.
[6 (DB SYN)]	Makes settings for when using the D Beam controller as a monophonic synthesizer. For details on these parameters, refer to System settings “[3 (SYNTH)]” (p. 152). * These are system settings. To save them, press [7 (WRITE)] in the edit screen to save the system settings.
[7 (CTRL SW)]	Accesses the CONTROL SW (PERF) screen, where you can turn the controllers on/off for each part, and specify the MIDI messages that they will transmit (p. 137). * “[7 (CTRL SW)]” is not shown if [5 (DB EXP)] or [6 (DB SYN)] are selected.

## Chapter 10. Detailed Editing for Performances

### CTRL SETTING (PERF) Parameters

#### [2 (TEMPO)]

Parameter	Value	Explanation
<b>Recommended Tempo</b>	20-250	If the JUNO-STAGE's tempo is to change when you switch performances, this setting specifies the tempo. In order to enable this setting, you must turn on the System setting "Tempo Override" (p. 151).

#### [3 (S1/S2)]

Specifies the functions that will be controlled by the [S1] and [S2] buttons.

Parameter	Value	Explanation
<b>Switch 1/Switch 2</b>		
<b>Assign</b>	TRANSCOPE UP	Shift the pitch of the keyboard upward in semitone steps (a maximum of six semitones).
	TRANSCOPE DOWN	Shift the pitch of the keyboard downward in semitone steps (a maximum of five semitones).
	TAP TEMPO	Used to set the tempo to the interval at which you press the button.
	MONO/POLY	Specify whether the patch will play polyphonically (POLY) or monophonically (MONO).
	PORTAMENTO	Turn the Portamento on/off.
	HOLD	Turn the Hold on/off.
	MF1-3 SW	Switch the multi-effects 1-3 on/off.
	CHORUS SW	Switch the chorus on/off.
	REVERB SW	Switch the reverb on/off.
	SYS CTRL 1-4 SRC	Transmit the MIDI message specified by the System setting "Sys Ctrl 1-4 Source" (p. 148).
	BEND MODE	Switches the bend mode (p. 146) The mode will be "Normal" when the button is off, and "CATCH+LAST" when the button is on.
	PART 1-16 KBD SW	Turns the keyboard switch (p. 134) on/off for the specified part
<b>Type</b>	LATCH	The on/off status will alternate each time you press the button.
	MOMENTARY	The assigned function will turn on while you press the button, and will turn off when you release it.

#### [4 (DBASGN)]

Specifies the function that will be controlled by the D Beam controller when D BEAM [ASSIGNABLE] is on.

Parameter	Value	Explanation
<b>Type</b>	CC01-31, 33-95	Controller number 1-31, 33-95
	BEND UP	Control the pitch change specified by the Pitch Bend Range Up (p. 101) setting.
	BEND DOWN	Control the pitch change specified by the Pitch Bend Range Down (p. 101) setting.
	START/STOP	Start/stop the song or the rhythm pattern.
	TAP TEMPO	Specify the tempo according to the interval at which you position your hand over the D Beam (tap tempo).
	ARP GRID	Specify the time signature and swing of the arpeggio.
	ARP DURATION	Specify the duration for each note of the arpeggio.
	ARP MOTIF	Change the upward/downward variation of the arpeggio.
	ARP OCTAVE UP	Shift the arpeggio's octave upward (maximum of three octaves)
	ARP OCTAVE DOWN	Shift the arpeggio's octave downward (maximum of three octaves)
	ARP STEP	Control the playback position of the arpeggio pattern.
	AFTERTOUCH	Aftertouch
	<b>Range Min</b>	0-127
<b>Range Max</b>	0-127	Specifies the upper limit of the D Beam controller's range. There will be no effect if the position of your hand above the D Beam controller is lower than this setting. * If Range Max is lower than Range Min, the range of variation will be vertically inverted.

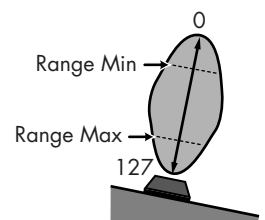

## [5 (DB EXP)]

Refer to the system setting "[4 (ATV EXP)]" (p. 153).

## [6 (DB SYN)]

Refer to the system setting "[3 (SYNTH)]" (p. 152).

## CONTROL SW (PERF) Screen



In the CTRL SETTING (PERF) screen, press [7 (CTRL SW)] to access this screen.

Use the cursor buttons to select the parameter that you want to edit, and use the VALUE dial or [DEC] [INC] to set the value.

When you've finished editing, press [7 (EXIT)]. You will return to the CTRL SETTING (PERF) screen.

## [2 (CTRL SW)]

For each patch assigned to a part, you can specify whether certain MIDI messages will be transmitted (on) or not (off).

Parameter	Value	Explanation
P.B	OFF, ON (✓)	MIDI pitch bend message transmission on/off
Mod		MIDI modulation message transmission on/off
Hold		Transmission on/off for the control messages from a pedal connected to the HOLD PEDAL jack
Ctrl		Transmission on/off for the control messages from a pedal connected to the CONTROL PEDAL jack
S1		Transmission on/off for the control messages from the [S1] button
S2		Transmission on/off for the control messages from the [S2] button
D Beam		Transmission on/off for the control messages from the D Beam

## [3 (EXT)]

Specifies the MIDI message that will be transmitted for each part.

Parameter	Value	Explanation
Bank Sel (MSB)	0–127, OFF	The MSB (control number 0) of the bank select number transmitted when you switch performances. Choose "OFF" if you don't want to transmit this message. * This message is not transmitted from parts whose Keyboard Switch is off.
Bank Sel (LSB)	0–127	The LSB (control number 32) of the bank select number transmitted when you switch performances. * This message is not transmitted from parts whose Keyboard Switch is off.
Prog	1–128, OFF	The program change number transmitted when you switch performances. Choose "OFF" if you don't want to transmit this message. * This message is not transmitted from parts whose Keyboard Switch is off.
Level	0–127, OFF	The value of the volume change transmitted when you switch performances. * This message is not transmitted from parts whose Keyboard Switch is off.
Pan	164–0–63R, OFF	The value of the pan message transmitted when you switch performances. Choose "OFF" if you don't want to transmit this message. * This message is not transmitted from parts whose Keyboard Switch is off.

## Enabling/Disabling Reception of Messages for Each MIDI Channel (Part)

Parts 1–16 of a performance correspond to MIDI channels 1–16 of MIDI messages received from an external MIDI device.

For each channel you can specify whether MIDI message reception will be enabled (on) or disabled (off). You can also enable reception for only specific types of messages.

### MIDI FILTER Screen



In the PERFORM PLAY screen, press [5 (MIDI)].

Use the cursor buttons to select the parameter that you want to edit, and use the VALUE dial or [DEC] [INC] to turn reception on ( shown) or off ( cleared).

When you've finished making settings, press [7 (EXIT)]. You will return to the PERFORM PLAY screen.

Parameter	Value	Explanation
<b>Rx</b>	OFF, ON ( <input checked="" type="checkbox"/> )	Enables/disables MIDI message reception for each part. If this is OFF, that part cannot be played. Normally, you can leave this ON, but you can turn it OFF if you don't want a specific part to play.
<b>PC</b> (Program Change)	OFF, ON ( <input checked="" type="checkbox"/> )	Enables/disables reception of the specific MIDI message for each MIDI channel.
<b>BS</b> (Bank Select)		
<b>PB</b> (Pitch Bend)		
<b>PA</b> (Polyphonic Key Pressure)		
<b>CA</b> (Channel Pressure)		
<b>Md</b> (Modulation)		
<b>Vo</b> (Volume)		
<b>Pn</b> (Pan)		
<b>Ex</b> (Expression)		
<b>Hd</b> (Hold 1)		

## Adjusting Sound Settings Such as Volume or Pan (PART MIXER)

### PART MIXER Screen

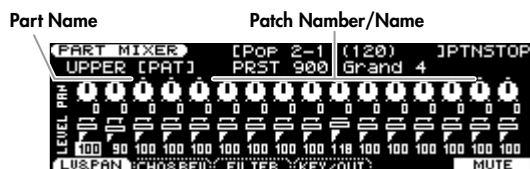

In the PERFORM PLAY screen, press [6 (MIXER)] to access this screen.

Use the cursor buttons to select the parameter that you want to edit, and use the VALUE dial or [DEC] [INC] to set the value.

The [2]–[7] buttons located below the screen provide access to the editing screens indicated in the bottom line of the screen.

When you’ve finished editing, press [EXIT] to return to the PERFORM PLAY screen.

Button	Content	
[2 (LV&PAN)]	Part volume (Level, p. 140) and PAN (left/right position) (Pan, p. 140)	
[3 (CHO&REV)]	Level of the signal sent from each part to chorus (Chorus, p. 141) and to reverb (Reverb, p. 141)	
[4 (FILTER)]	Each part’s cutoff (Cutoff, p. 142) and resonance (Reso, p. 142) settings	
[5 (KEY/OUT)]	KEY	Pitch of each part (semitone steps, ±4 octaves) (Coarse, p. 141)
	KBD	Keyboard switch (p. 134)
	RHY	Specifies the part that will play the rhythm pattern.
	ARP	Arpeggio part (p. 61)
[7 (MUTE)]	Output assign (Asgn, p. 141)	
[7 (MUTE)]	Opens the Part Mute window, where you can silence (mute) specific parts.	

## Silencing Specific Parts (Mute)

When you’re playing back a song from an external MIDI device connected to the JUNO-STAGE, you may wish to silence (mute) the playback of specific parts.

For example, you can mute the melody and use the remainder of the song for karaoke or for practicing that part yourself.

- 1. In the PART MIXER screen, press [7 (MUTE)].**

The Part Mute window will open.

- 2. Use [◀] [▶] to select a part.**

- 3. Use the VALUE dial, [DEC] [INC], or [▲] [▼] to turn muting “ON” or “OFF.”**

Parts whose mute setting is “ON” will not produce sound.

You can also use the following function buttons to turn the mute setting on/off.

- Pressing [4 (1-2 ON)] will turn part 1 and part 2 on.
- Pressing [5 (10 ON)] will turn part 10 on.
- Pressing [6 (ALL OFF)] will turn all parts off.

- 4. Press [7 (CLOSE)].**

The Part Mute window will close.

#### MEMO

Part muting does not turn off the part’s MIDI reception switch; rather, it silences the part by minimizing its volume. This means that MIDI messages are being received by the part.

## Chapter 10. Detailed Editing for Performances

### Detailed Settings for Each Part (PART VIEW)

The PART VIEW screen lets you view a list of the settings for the parts in Performance mode.

In the PART VIEW screen, you can view and edit the patch assigned to each part together with settings such as volume and pan for four parts at a time. This allows you to access more detailed settings that are not available in the PERFORM PLAY screen or the PART MIXER screen.

### PART VIEW Screen

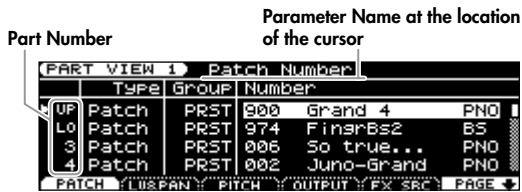

In the PERFORM PLAY screen, press [7 (PARTVIEW)] to access this screen.

Use the cursor buttons to select a parameter, and use the VALUE dial or [DEC] [INC] to set its value.

The [2]–[6] buttons located below the display provide access to the editing screens indicated in the bottom line of the screen.

Pressing [7 (PAGE)] will switch the screens that are selected by the [2]–[6] buttons.

When you've finished editing, press [EXIT] to return to the PERFORM PLAY screen.

For details on the parameters, refer to "Performance parameters," below.

### Performance Parameters

#### [2 (PATCH)]

Parameter	Value	Explanation
Type	Patch, Rhythm	Sets the assignment of a patch or rhythm set to each of the parts.
Group	USER, PRST, GM, XP-A, XP-B	Selects the group to which the desired patch belongs. (* If Type is Patch) <b>USER:</b> User <b>PRST:</b> Preset <b>GM:</b> General MIDI (GM2) <b>XP-A, XP-B:</b> Wave Expansion Board
Number	001–	Selects the desired patch or rhythm set by its number.

#### [3 (LV&PAN)]

Parameter	Value	Explanation
Level	0–127	Volume of each part This setting's main purpose is to adjust the volume balance between parts.
Pan	L64–0–63R	Left/right position of each part
Kbd	OFF, ON (✓)	Specifies, for each part, whether or not the keyboard controller section will be connected to the internal sound generator.
Solo	OFF, ON (✓)	Check "✓" this setting if you want to hear the part by itself; this is called "soloing" the part.
Mute	OFF, ON (✓)	Mutes (✓) or un-mutes (OFF) each part. Use this setting when, for example, you want to use the instrument for karaoke by muting the part playing the melody, or when you want to play something using a separate sound module. * The Mute Switch parameter does not turn the part off, but sets the volume to minimum so that no sound is heard. Therefore, MIDI messages are still received.



### [4 (PITCH)]

Parameter	Value	Explanation
<b>Octave</b>	-3--+3	Pitch of the part's sound (in 1-octave units) * Note that when a rhythm set is assigned to a part, you cannot modify this parameter.
<b>Coarse</b>	-48--+48	Pitch of the part's sound (in semitones, +/-4 octaves)
<b>Fine</b>	-50--+50	Pitch of the part's sound (in 1-cent steps; one cent is 1/100th of a semitone)
<b>Bend</b>	0-24, PAT	Amount of pitch change in semitones (2 octaves) that will occur when the Pitch Bend Lever is moved. The amount of change when the lever is tilted is set to the same value for both left and right sides. If you want to use the Pitch Bend Range setting of the patch assigned to the part (p. 101), set this to "PAT."

#### Coarse Tune and Octave Shift

The Coarse Tune and Fine Tune parameters, along with the Octave Shift parameter, can all be seen as doing the same thing to the sound, i.e., changing the pitch of the sound. For example, if C4 (Middle C) is played with the Coarse Tune parameter set to "+12," the note produced is C5 (one octave above C4). For example, if C4 (Middle C) is played with the Octave Shift parameter set to "+1," the note produced is C5 (one octave above C4).

However, internally these function very differently. When the Coarse Tune parameter is set to "+12," the pitch itself is raised one octave. On the other hand, when the Octave Shift parameter is set to "+1," it is the same as pressing the keys one octave up. In other words, use the Coarse Tune parameter when changing the pitch, and the Octave Shift parameter when you want to shift the entire keyboard, for example, when the number of keys is insufficient.

### [5 (OUTPUT)]

Parameter	Value	Explanation
<b>Asgn</b>	MFX 1-3, L+R, L, R, PAT 1-3	Specifies for each part how the direct sound will be output. <b>MFX 1-3:</b> Output in stereo through multi-effects. You can also apply chorus or reverb to the sound that passes through multi-effects. Specify which multi-effects (1-3) will be used. <b>L+R:</b> Output in stereo to the OUTPUT jacks without passing through the multi-effect <b>L:</b> Output in mono to the OUTPUT L jack without passing through the multi-effect <b>R:</b> Output in mono to the OUTPUT R jack without passing through the multi-effect <b>PAT 1-3:</b> The part's output destination is determined by the settings of the patch or rhythm set assigned to the part. Specify which multi-effects (1-3) will be used. <ul style="list-style-type: none"> <li>• Chorus and reverb are output in mono at all times.</li> <li>• The output destination of the signal after passing through the chorus is set with the Chorus Output Select parameters (p. 81).</li> </ul>
<b>Output</b>	0-127	Level of the signal that is sent to the output destination specified by Asgn.
<b>Chorus</b>	0-127	Level of the signal sent to chorus for each part
<b>Reverb</b>	0-127	Level of the signal sent to reverb for each part

### [6 (FX SRC)]

Parameter	Value	Explanation
<b>MFX1-3</b>	OFF, ON (✓)	The settings of a specific patch can be used as the settings for MFX1-MFX3, chorus, and reverb. This setting specifies the part to which this patch has been assigned. If no part is selected, the settings of the Performance will be used.
<b>Chorus</b>		
<b>Reverb</b>		

## Chapter 10. Detailed Editing for Performances

### [PAGE ↓] - [2 (OFFSET)]

The values set here are applied to the parameters of the patches/rhythm sets of the various parts, and are used in correcting the tone.

Parameter	Value	Explanation
Cutoff	-64+63	Adjusts the cutoff frequency for the patch or rhythm set assigned to a part.
Reso	-64+63	Adjusts the Resonance for the patch or rhythm set assigned to a part.
Attack	-64+63	Adjusts the TVA/TVF Envelope Attack Time for the patch or rhythm set assigned to a part.
Releas	-64+63	Adjusts the TVA/TVF Envelope Release Time for the patch or rhythm set assigned to a part.
Decay	-64+63	Adjusts the TVA/TVF Envelope Decay Time for the patch or rhythm set assigned to a part.

### [PAGE ↓] - [3 (VIBRATO)]

Parameter	Value	Explanation
Vib Rate	-64+63	For each part, adjust the vibrato speed.
Depth	-64+63	For each part, this adjusts the depth of the vibrato effect.
Delay	-64+63	For each part, this adjusts the time delay until the vibrato.
Phase	OFF, ON	Set to "ON" when you want to suppress discrepancies in timing of parts played on the same MIDI channel. * When this parameter is set to "ON," parts on the same MIDI channel are put in a condition in which their timing is matched, enabling them to be played at the same time. Accordingly, a certain amount of time may elapse between reception of the Note messages and playing of the sounds. Turn this setting to "ON" only as needed.

### [PAGE ↓] - [4 (KEYBOARD)]

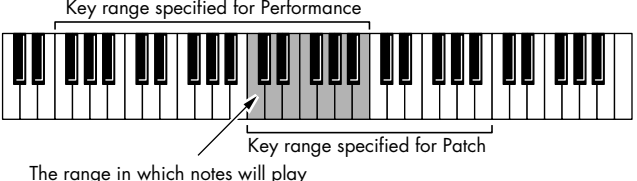
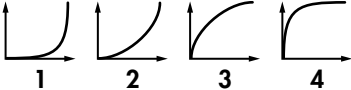
Parameter	Value	Explanation
Kbd	OFF, ON (✓)	Specifies, for each part, whether or not the keyboard controller section will be connected to the internal sound generator.
K.L	C - -(Upper)	Lowest note that the tone will sound for each part
K.U	(Lower)-G9	Highest note that the tone will sound for each part When the Key Range (p. 134) is set for each individual tone in a patch, sounds are produced in the range where the Key Range of each tone and the Key Range for the part overlap. 
Velo	-63+63	Changes the volume and cutoff frequency for each part according to the velocity with which the keys are pressed. If you want strongly played notes to raise the volume/cutoff frequency, set this parameter to positive (+) settings. If you want strongly played notes to lower the volume/cutoff frequency, use negative (-) settings.
Curve	OFF, 1-4	Velocity curve for each MIDI channel Selects for each MIDI channel one of the four following Velocity Curve types that best matches the touch of the connected MIDI keyboard. Set this to "OFF" if you are using the MIDI keyboard's own velocity curve. 
Voice	0-63, FULL	This setting specifies the number of voices that will be reserved for each part when more than 128 voices are played simultaneously. * It is not possible for the settings of all parts to total an amount greater than 64. The remaining number of available voices will be displayed at (rest=). Pay attention to this readout as you make Voice Reserve settings.
Ch	1-16	MIDI receive channel for each part

## Calculating the Number of Voices Being Used

The JUNO-STAGE is able to play up to 128 notes simultaneously. The polyphony, or the number of voices (sounds) does not refer only to the number of sounds actually being played, but changes according to the number of tones used in the patches, and the number of Waves used in the tones. The following method is used to calculate the number of sounds used for one patch being played.

(Number of Sounds Being Played) x (Number of Tones Used by Patches Being Played) x (Number of Waves Used in the Tones)

Realtime Stretch requires twice the normal polyphony.

## [PAGE ↓] - [5 (KEY MOD)]

Parameter	Value	Explanation
<b>Mono/Poly</b>	MONO, POLY, PAT	Set this parameter to "MONO" when the patch assigned to the part is to be played monophonically, or to "POLY" when the patch is to be played polyphonically. If you want to use the Mono/Poly setting of the patch assigned to the part (p. 101), set this to "PAT." * This setting is ignored for parts to which a rhythm set is assigned.
<b>Legato</b>	OFF, ON, PAT	You can add legato when performing monophonically. The term "legato" refers to a playing style in which notes are smoothly connected to create a flowing feel. This creates a smooth transition between notes, which is effective when you wish to simulate the hammering-on and pulling-off techniques used by a guitarist. Turn this parameter "ON" when you want to use the Legato feature and "OFF" when you don't. If you want to use the Legato Switch setting of the patch assigned to the part (p. 101), set this to "PAT." * This setting is ignored for parts to which a rhythm set is assigned.
<b>Portament</b>	OFF, ON, PAT	Specify whether portamento will be applied. Turn this parameter "ON" when you want to apply Portamento and "OFF" when you don't. If you want to use the Portamento Switch setting of the patch assigned to the part (p. 101), set this to "PAT."
<b>Time</b>	0-127, PAT	When portamento is used, this specifies the time over which the pitch will change. Higher settings will cause the pitch change to the next note to take more time. If you want to use the Portamento Time setting of the patch assigned to the part (p. 101), set this to "PAT."

## [PAGE ↓] - [6 (S.TUNE)]

Parameter	Value	Explanation
<b>Part Scale Tune for C-B</b>	-64+63	Make scale tune settings for each part. Scale Tune is switched on/off by means of the Scale Tune Switch parameter (p. 146).

## Equal Temperament

This tuning divides the octave into 12 equal parts, and is the most widely used method of temperament used in Western music. The JUNO-STAGE employs equal temperament when the Scale Tune Switch is set to "OFF."

### Just Intonation (Tonic of C)

Compared with equal temperament, the principle triads sound pure in this tuning. However, this effect is achieved only in one key, and the triads will become ambiguous if you transpose.

### Arabian Scale

In this scale, E and B are a quarter note lower and C#, F# and G# are a quarter-note higher compared to equal temperament. The intervals between G and B, C and E, F and G#, Bb and C#, and Eb and F# have a natural third-the interval between a major third and a minor third. On the JUNO-STAGE, you can use Arabian temperament in the three keys of G, C and F.

## <Example>

Note name	Equal temperament	Just intonation	Arabian scale
C	0	0	-6
C #	0	-8	+45
D	0	+4	-2
E b	0	+16	-12
E	0	-14	-51
F	0	-2	-8
F #	0	-10	+43
G	0	+2	-4
G #	0	+14	+47
A	0	-16	0
B b	0	+14	-10
B	0	-12	-49

# Chapter 11. Other Settings

## Saving User Data to USB Memory

You can save system settings or user data to USB memory.

### NOTE

Connect your USB memory after you've turned the JUNO-STAGE's power on. Never disconnect the USB memory while the power is turned on.

### Types of Data that can be Saved

When you save settings from the JUNO-STAGE to USB memory, the following settings are saved.

- User patches (rhythm sets)
- User performances
- Favorites
- User arpeggios
- User chord memory
- User rhythm patterns
- User rhythm groups
- MIDI Controller mode settings
- Patch first selected in Piano mode
- System settings

### Saving Data to USB Memory (User Backup)

Here's how to save user data to USB memory. This operation is called "User Backup."

### MEMO

Use USB memory sold by Roland. We cannot guarantee correct operation if other products are used.

1. Press [MENU].  
The Top Menu window will appear.
2. Use [▲][▼] to select "4. Utility," and press [ENTER].  
The UTILITY MENU screen will appear.
3. Use the cursor buttons to select "User Backup," and press [ENTER].  
The following screen will appear.

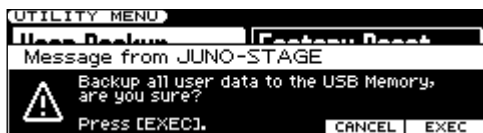

4. Press [7 (EXEC)].  
If you decide to cancel, press [6 (CANCEL)].  
When the backup has been completed, you will return to the UTILITY MENU screen.

### Restoring Saved Data from USB Memory Back into the JUNO-STAGE (User Restore)

Here's how to restore backed-up user data from USB memory into the JUNO-STAGE. This operation is called "User Restore."

1. Press [MENU].  
The Top Menu window will appear.
2. Use [▲][▼] to select "4. Utility," and press [ENTER].  
The UTILITY MENU screen will appear.
3. Use the cursor buttons to select "User Restore," and press [ENTER].  
The following screen will appear.



4. Press [7 (EXEC)].  
If you decide to cancel, press [6 (CANCEL)].  
When the restore operation has been completed, the following screen will appear.



5. Turn the power of the JUNO-STAGE off, then on again.

## System Settings

Here you can make “System settings” that affect the operation of the entire JUNO-STAGE, such as the tuning and how MIDI messages will be received.

### Procedure for Making System Settings

1. Press [MENU].  
The Top Menu window will appear.
2. Use [▲][▼] to choose “1. System” and press the [ENTER].  
The System Menu screen will appear.
3. Press one of the function buttons to select the setting that you want to edit.  
The setting screen for the selected button will appear.  
If necessary, press a function button again to access the desired setting screen.
4. Use the cursor buttons to select to the parameter that you want to set.
5. Use the VALUE dial or the [DEC] [INC] to set the value.

### Saving the Changes You’ve Made to the System Settings (WRITE)

Changes you’ve made to the system settings will return to their original state when you turn off the power. If you want to keep the changes you’ve made, you must save them as follows.

1. Access a system function setting screen.
2. Press [7 (WRITE)].  
A screen like the following will appear, and the settings will be saved.



When the settings have been saved, you will return to the previous screen.

## Functions of System Parameters

This section explains what the different System parameters do, and also how these parameters are organized.

### System Menu [2 (GENERAL)]

#### [2 (COMMON)]

Parameter	Value	Explanation
<b>System Common</b>		
<b>Power Up Mode</b>	PATCH, PERFORM	Mode that the JUNO-STAGE will be in when it is powered up. <b>PATCH:</b> Patch mode <b>PERFORM:</b> Performance mode
<b>Patch Remain</b>	OFF, ON	Specifies whether currently sounding notes will continue sounding when another patch or rhythm set is selected (ON), or not (OFF). When this is "ON," changes produced by incoming MIDI messages such as Volume or Pan (CC 5, 7, 10, 65, 68, 71–74, RPN 0, 1, 2, MONO ON, POLY ON), as well as tonal quality and volume changes produced by the various controllers will be inherited. * Effects settings change as soon as you switch to a new patch or rhythm set, without being influenced by the Patch Remain setting. Because of this, certain effects settings can cause notes that were until then sounding to no longer be heard, even though Patch Remain has been set to "ON."
<b>Bend Mode</b>	NORMAL	The pitch bend lever will operate in the conventional way.
	CATCH+LAST	If you press a key while the pitch bend lever is already moved to one side, that note will sound at its normal pitch (as if the pitch bend lever were in the center). Only after the lever has passed through the center position will it begin to affect the pitch. This will apply only to the last-played note. This is a useful way to simulate the guitar technique of double-bending.
<b>Screen Saver Time</b>	OFF, 5 min, 10 min, 20 min, 30 min, 40 min, 50 min, 60 min	Time until the screen saver is displayed
<b>Driver Setting</b>		
<b>USB Driver</b>	GENERIC, VENDER	USB driver setting. * This setting will take effect when you turn the power off, then on again.

#### [3 (SOUND)]

Parameter	Value	Explanation
<b>Sound Generator</b>		
<b>Master Tune</b>	415.3–466.2 Hz	Overall tuning of the JUNO-STAGE The display shows the frequency of the A4 note (center A).
<b>Master Key Shift</b>	-24–+24	Shifts the overall pitch of the JUNO-STAGE in semitone steps.
<b>Master Level</b>	0–127	Volume of the entire JUNO-STAGE
<b>Output Gain</b>	-12– 12 dB	Output gain from the JUNO-STAGE's Output When, for example, there are relatively few voices being sounded, boosting the output gain can let you attain the most suitable output level for recording and other purposes.
<b>Preview</b>		
<b>Preview Mode</b>	SINGLE, CHORD, PHRASE	<b>SINGLE:</b> The notes specified by Preview 1–4 Note Number will sound successively one by one. <b>CHORD:</b> The notes specified by Preview 1–4 Note Number will sound simultaneously. <b>PHRASE:</b> The Phrase associated with the patch's type/category is played.
<b>Preview 1–4 Note Number</b>	C–G9	Specify the pitch of the four notes that will sound when the Preview Mode is set to "SINGLE" or "CHORD." * If "PHRASE" is selected for the Preview Mode parameter, these settings will have no effect.
<b>Preview 1–4 Velocity</b>	OFF, 1–127	Specify the velocity of the four notes that will sound when the Preview Mode is set to "SINGLE" or "CHORD." * If "PHRASE" is selected for the Preview Mode parameter, these settings will have no effect.

#### Scale Tune for Patch Mode

The JUNO-STAGE allows you to play the keyboard using temperaments other than equal temperament. The pitch is specified in one-cent units relative to the equal tempered pitch. One-cent is 1/100th of a semitone.

One set of Scale Tune settings can be created in Patch mode. In Performance mode, this can be set for each part of the performance (p. 143).

\* In Patch mode, this is valid only for the keyboard part.

\* The selected scale applies to MIDI messages received from an external MIDI device.

<b>Scale Tune Switch</b>	OFF, ON	Turn this on when you wish to use a tuning scale other than equal temperament.
<b>Patch Scale Tune for C–B</b>	-64–+63	Make scale tune settings for Patch mode.

System Menu [3 (KBD/CTRL)]

[2 (KBD)]

Parameter	Value	Explanation
Keyboard Velocity	REAL, 1–127	Velocity value that will be transmitted when you play the keyboard <b>REAL:</b> Actual keyboard velocity will be transmitted. <b>1–127:</b> A fixed velocity value will be transmitted regardless of how you play.
Keyboard Velocity Curve	LIGHT, MEDIUM, HEAVY	Keyboard's touch <b>LIGHT:</b> Light weight synthesizer keyboard like <b>MEDIUM:</b> Standard <b>HEAVY:</b> Acoustic piano simulation
Keyboard Velocity Sens	-63+63	Makes fine adjustments to the keyboard sensitivity following the Keyboard Velocity Curve selection. Higher settings for this value will increase the velocity value that is transmitted according to your playing strength.

[3 (PEDAL)]

Parameter	Value	Explanation
Pedal		
Control Pedal Assign	CC01–31, 33–95, BEND UP, BEND DOWN, AFTERTOUCH, OCT UP, OCT DOWN, START/STOP, TAP TEMPO, PROGRAM UP, PROGRAM DOWN, FAVORITE UP, FAVORITE DOWN, ARP SW, CHORD SW	Function of the pedal connected to the PEDAL CONTROL jack <b>CC01–31, 33–95:</b> Controller numbers 1–31, 33–95 <b>BEND UP:</b> The pitch will rise in semitone steps (maximum 4 octaves) each time you press the pedal. <b>BEND DOWN:</b> The pitch will fall in semitone steps (maximum 4 octaves) each time you press the pedal. <b>AFTERTOUCH:</b> Aftertouch <b>OCT UP:</b> Each pedal press raises the key range in octave steps (up to 3 octaves higher). <b>OCT DOWN:</b> Each pedal press lowers the key range in octave steps (up to 3 octaves lower). <b>START/STOP:</b> The song or the rhythm pattern will start/stop. <b>TAP TEMPO:</b> Tap tempo (a tempo specified by the interval at which you press the pedal). <b>PROGRAM UP:</b> Select the next-numbered patch in Patch mode, or the next-numbered performance in Performance mode. <b>PROGRAM DOWN:</b> Select the previous-numbered patch in Patch mode, or the previous numbered performance in Performance mode. <b>FAVORITE UP:</b> The favorite of the next number or bank will be selected. <b>FAVORITE DOWN:</b> The favorite of the previous number or bank will be selected. <b>ARP SW:</b> Arpeggio/Rhythm Pattern function on/off <b>CHORD SW:</b> Chord memory function on/off
Control Pedal Polarity	STANDARD, REVERSE	Selects the polarity of the pedal connected to the PEDAL CONTROL jack or to the PEDAL HOLD jack. On some pedals, the electrical signal output by the pedal when it is pressed or released is the opposite of other pedals. If your pedal has an effect opposite of what you expect, set this parameter to "REVERSE." If you are using a Roland pedal (that has no polarity switch), set this parameter to "STANDARD."
Hold Pedal Polarity		
Continuous Hold Pedal	OFF, ON	Determines whether the HOLD PEDAL jack will provide support for half-pedaling (ON), or not (OFF). When this is set to support use of half-pedaling techniques, you can then connect an optional expression pedal (DP-10, etc.), and employ pedal work to achieve even finer control in performances in which piano tones are used.
Patch Select	AUTO UP/(DOWN), PROGRAM UP/(DOWN), FAVORITE UP/(DOWN)	The function controlled by a pedal connected to the PATCH SELECT jack <b>AUTO UP/(DOWN):</b> The function will depend on whether FAVORITE [ON/OFF] is on or off. When FAVORITE [ON/OFF] is on, the pedal will switch favorites (the FAVORITE UP/(DOWN) function). When FAVORITE [ON/OFF] is off, the pedal will switch either patches or performances, depending on the mode (the PROGRAM UP/(DOWN) function). <b>PROGRAM UP/(DOWN):</b> The next-numbered patch will be selected in Patch mode, or the next-numbered performance will be selected in Performance mode. If you've connected two pedals, the other pedal will select the preceding number. <b>FAVORITE UP/(DOWN):</b> The favorite of the next number or next bank will be selected. If you've connected two pedals, the other pedal will select the favorite of the preceding number or bank.

## Chapter 11. Other Settings

Parameter	Value	Explanation
Patch Select Polarity	STANDARD, REVERSE	Selects the polarity of the pedal connected to the PATCH SELECT jack. On some pedals, the electrical signal output by the pedal when it is pressed or released is the opposite of other pedals. If your pedal has an effect opposite of what you expect, set this parameter to "REVERSE." If you are using a Roland pedal (that has no polarity switch), set this parameter to "STANDARD."

### [4 (CTRL)]

Parameter	Value	Explanation
Sys Ctrl 1–4 Source	OFF, CC01–95, PITCH BEND, AFTERTOUCH	Selects the MIDI message used as the System Control. <b>OFF:</b> The system control knob will not be used. <b>CC01–95:</b> Controller numbers 1–95 <b>PITCH BEND:</b> Pitch Bend <b>AFTERTOUCH:</b> Aftertouch

#### System Control

This function, which departs from previously used methods, and instead allows you to use MIDI messages to change tone settings in realtime, is called the **Matrix Control** (p. 110). Similarly, the function allowing you to use MIDI messages to change multi-effects settings in realtime is called the **Multi-effects Control** (p. 84).

Normally, the Matrix Control is used for making patch settings, and the Multi-effects Control for making settings to patches, rhythm sets, and performances.

For example, if you want the same MIDI message to always be used for matrix control for other patches as well, select that MIDI message as Sys Ctrl 1 Source, and select "SYS CTRL 1" as the CTRL Source for the other patches. With these settings, even if you need to change the MIDI message used for matrix control, all you need to do is simply choose a different MIDI message as the Sys Ctrl 1 Source. In other words, you could call the System Controls global Matrix Control/Multi-effects Control for the entire JUNO-STAGE.

You can use up to four System Controls.

### [5 (SWITCH)]

Parameter	Value	Explanation
<b>ASSIGNABLE Switch</b>		
Assign	FAVORITE UP, FAVORITE DOWN, PROGRAM UP, PROGRAM DOWN, TRANSPOSE UP, TRANSPOSE DOWN, TAP TEMPO, MONO/POLY, PORTAMENTO, HOLD, MFX1–3 SW, CHORUS SW, REVERB SW, SYS CTRL 1–4 SRC, BEND MODE, START/STOP	The function assigned to [FAVORITE UP/ASSIGNABLE] <b>FAVORITE UP:</b> Select the favorite of the next number or bank. <b>FAVORITE DOWN:</b> Select the favorite of the preceding number or bank. <b>PROGRAM UP:</b> Select the next-numbered patch in Patch mode, or the next-numbered performance in Performance mode. <b>PROGRAM DOWN:</b> Select the previous-numbered patch in Patch mode, or the previous-numbered performance in Performance mode. <b>TRANSPOSE UP:</b> Raise the key range in semitone steps (maximum of 6 semitones). <b>TRANSPOSE DOWN:</b> Lower the key range in semitone steps (maximum of 5 semitones). <b>TAP TEMPO:</b> Tap tempo (set the tempo by pressing the button at the desired interval). <b>MONO/POLY:</b> Switch the patch between polyphonic (POLY) or monophonic (MONO) playing. <b>PORTAMENTO:</b> Turn portamento on/off. <b>HOLD:</b> Turn hold on/off. <b>MFX1–3 SW:</b> Multi-effect 1–3 switch. <b>CHORUS SW:</b> Chorus switch. <b>REVERB SW:</b> Reverb switch. <b>SYS CTRL 1–4 SRC:</b> Transmit the MIDI message specified by "Sys Ctrl 1–4 Source." <b>BEND MODE:</b> Switch the bend mode (p. 146). "NORMAL" when the button is off, "CATCH+LAST" when the button is on. <b>START/STOP:</b> Start/stop the song or rhythm pattern.
Type	LATCH, MOMENTARY	The way in which [FAVORITE UP/ASSIGNABLE] will operate when pressed. <b>LATCH:</b> The on/off status will alternate each time you press the button. <b>MOMENTARY:</b> The function is turned on while you press the button, and is turned off when you release it. * Depending on the Assign setting, this may not be available.



Parameter	Value	Explanation
<b>Switch 1</b>		
<b>Assign</b>	TRANSPOSE UP, TRANSPOSE DOWN, TAP TEMPO, MONO/POLY, PORTAMENTO, HOLD, MFX1-3 SW (Performance Mode), MFX SW (Patch Mode), CHORUS SW, REVERB SW, SYS CTRL 1-4 SRC, BEND MODE, PART 1-16 KBD SW, (Performance Mode)	The function assigned to [S1] <b>TRANSPOSE UP:</b> Raise the key range in semitone steps (maximum of 6 semitones). <b>TRANSPOSE DOWN:</b> Lower the key range in semitone steps (maximum of 5 semitones). <b>TAP TEMPO:</b> Tap tempo (set the tempo by pressing the button at the desired interval). <b>MONO/POLY:</b> Switch the patch between polyphonic (POLY) or monophonic (MONO) playing. <b>PORTAMENTO:</b> Turn portamento on/off. <b>HOLD:</b> Turn hold on/off. <b>MFX1-3 SW</b> or <b>MFX SW:</b> Multi-effect switch. <b>CHORUS SW:</b> Chorus switch. <b>REVERB SW:</b> Reverb switch. <b>SYS CTRL 1-4 SRC:</b> Transmit the MIDI message specified by "Sys Ctrl 1-4 Source." <b>BEND MODE:</b> Switch the bend mode (p. 146). "NORMAL" when the button is off, and "CATCH+LAST" when the button is on. <b>PART 1-6 KBD SW:</b> Turns the keyboard switch (p. 134) on/off for the specified part
<b>Type</b>	LATCH, MOMENTARY	The way in which [S1] will operate when pressed. <b>LATCH:</b> The on/off status will alternate each time you press the button. <b>MOMENTARY:</b> The status will turn on when you press the button, and turn off when you release it. * Depending on the Assign setting, this may not be available.
<b>Switch 2</b>		
<b>Assign</b>	(same as Switch 1)	
<b>Type</b>		

## Chapter 11. Other Settings

### System Menu [4 (MIDI/SYNC)]

#### [2 (GENERAL)]

Parameter	Value	Explanation
Local Switch	OFF, ON	Determines whether the internal sound generator is disconnected (OFF) from the controller section (keyboard, pitch bend/modulation lever, knobs, buttons, D Beam controller, pedal, and so on); or not disconnected (ON). Normally this is left "ON," but if you wish to use the JUNO-STAGE's keyboard and controllers to control only external sound modules, set it to "OFF."
Device ID	17-32	When you want to transmit or receive System Exclusive messages, set this parameter to match the Device ID number of the other MIDI device.
Remote Keyboard Switch	OFF, ON	Set this parameter "ON" when you want to use an external MIDI keyboard instead of the JUNO-STAGE's keyboard. In this case, the MIDI transmit channel of the external MIDI keyboard can be set to any channel. Normally you will leave this parameter "OFF." * Turn this "ON" when you want to control the JUNO-STAGE from an external MIDI device when performing with the Arpeggio function.
Performance Control Channel	1-16, OFF	Selects the MIDI receive channel used during switching of performances when MIDI messages (Program Change/Bank Select) are sent from an external MIDI device. Set this to "OFF" if performances are not to be switched from an external MIDI device. * If only a program change is received, and if this parameter setting coincides with the MIDI receive channel of a part, priority will be given to switching the performance.
Kbd Patch Rx/Tx Channel	1-16	Channel used to transmit and receive MIDI messages for the Keyboard part in Patch mode
<b>USB MIDI</b>		
USB-MIDI Thru	OFF, ON	If this is "ON," incoming MIDI messages will be re-transmitted without change from the MIDI OUT connector.

#### Using the Local Switch

When you're using the JUNO-STAGE with external sequencer software, leave the Local Switch turned off. Read the following for details.

Typically, things are hooked up so the data travels as follows: the JUNO-STAGE's keyboard → your external sequencer software → the JUNO-STAGE's sound generator. Normally, the JUNO-STAGE's keyboard section is internally connected to its sound generator section; this internal connection is controlled by the Local Switch. If you turn the Local Switch off, the JUNO-STAGE's keyboard and sound generator sections will be independent, allowing you to use the connection described with your external sequencer software.

#### Connecting the JUNO-STAGE to an external sequencer

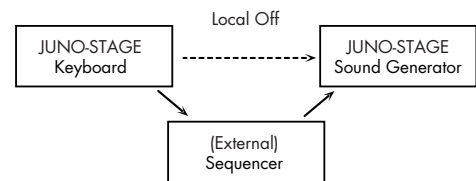

#### [3 (TX)]

Parameter	Value	Explanation
Transmit Program Change	OFF, ON	Specifies whether Program Change messages will be transmitted (ON) or not (OFF).
Transmit Bank Select	OFF, ON	Specifies whether Bank Select messages will be transmitted (ON) or not (OFF).
Transmit Active Sensing	OFF, ON	Specifies whether Active Sensing messages will be transmitted (ON) or not (OFF).
Transmit Edit Data	OFF, ON	Specify whether changes you make in the settings of a patch, performance will be transmitted as system exclusive messages (ON), or will not be transmitted (OFF).
Soft Through	OFF, ON	Thru function re-transmits all messages received at the MIDI IN connector to the MIDI OUT connector without modifying them in any way.

### [4 (RX)]

Parameter	Value	Explanation
Receive Program Change	OFF, ON	Specifies whether Program Change messages will be received (ON) or not (OFF).
Receive Bank Select	OFF, ON	Specifies whether Bank Select messages will be received (ON) or not (OFF).
Receive Exclusive	OFF, ON	Specifies whether System Exclusive messages will be received (ON) or not (OFF).
Receive GM System On	OFF, ON	Specifies whether General MIDI System On messages will be received (ON) or not (OFF).
Receive GM2 System On	OFF, ON	Specifies whether General MIDI 2 System On messages will be received (ON) or not (OFF).
Receive GS Reset	OFF, ON	Specifies whether GS Reset messages will be received (ON) or not (OFF).

### [5 (SYNC)]

Parameter	Value	Explanation
Sync Mode	MASTER, SLAVE, REMOTE	Specifies the synchronization signals that the JUNO-STAGE will follow. <b>MASTER:</b> The JUNO-STAGE will be the master. Choose this setting if you're operating the JUNO-STAGE by itself, without synchronizing it to any other device. <b>SLAVE:</b> The JUNO-STAGE will be the slave. Choose this setting if you want the JUNO-STAGE to operate according to MIDI Clock messages received from an external device. <b>REMOTE:</b> The JUNO-STAGE will obey MIDI Start, Continue, and Stop messages from an external device, but will use its own tempo setting.
Sync Output	OFF, ON	If this is ON, the JUNO-STAGE will transmit synchronization-related MIDI messages (MIDI Clock, Start, Continue, Stop) to an external MIDI device. * This cannot be set if Sync Mode is "SLAVE."
Tempo Override	OFF, ON	If this is ON, switching performances will make the tempo change to the "Recommended Tempo" specified for that performance.

## System Menu [5 (CLICK/PLAYER)]

### [2 (CLICKOUT)]

Parameter	Value	Explanation
<b>Click Setting</b>		
Song/Click Output Mode	CLICK, SONG	<b>CLICK:</b> If SMF data is being played back, the SONG/CLICK OUT jack will output a click sound. The SONG/CLICK OUT jack will output either the click sound (while playing back SMF data) or the song (while playing back audio data). The OUTPUT L/R jacks will output the song. <b>SONG:</b> The SONG/CLICK OUT jack will output the song. The SONG/CLICK OUT jack will output the song. The OUTPUT L/R jacks will not output the click or the song. * This setting is valid if the song is SMF data. If the song is audio data, the sound of the song will always be output, regardless of this setting.
Click Level	0–10	Volume of the click
Click Sound	TYPE1–TYPE4	Sound type of the click <b>TYPE 1:</b> A conventional click sound (A bell will sound on the first beat.) <b>TYPE 2:</b> Clicks <b>TYPE 3:</b> Beeps <b>TYPE 4:</b> Cowbell
<b>Level</b>		
Song/Click Output Level	0–127	Volume of the output from the SONG/CLICK OUT jack

### [3 (PLAYER)]

Parameter	Range	Explanation
<b>Song Player Level</b>		
Audio Level	0–127	Sets the volume at which audio files will be played by the song player.
SMF Level	0–127	Sets the volume at which SMF will be played by the song player.

## Chapter 11. Other Settings

### System Menu [6 (D BEAM)]

#### [2 (GENEERL)]

Parameter	Value	Explanation
<b>Sensitivity</b>		
D Beam Sens	0-127	This sets the D Beam controller's sensitivity. Increasing this value will make the D Beam controller more responsive.

#### [3 (SYNTH)]

Parameter	Value	Explanation
<b>Level &amp; Range</b>		
Level	0-127	Volume Level of the Solo Synth
Chorus Send Level	0-127	Level of the signal sent to chorus
Reverb Send Level	0-127	Level of the signal sent to reverb
Range	2OCT, 4OCT, 8OCT	Range in which the pitch of the solo synth will vary
<b>Osc 1</b>		
Osc 1 Waveform	SAW, SQR	Waveform <b>SAW:</b> Sawtooth wave <b>SQR:</b> Square wave
Osc 1 Pulse Width	0-127	Pulse width of the waveform By cyclically modifying the pulse width you can create subtle changes in the tone.
Osc 1 Coarse Tune	-48-+48	Pitch of the tone's sound (in semitones, +/-4 octaves)
Osc 1 Fine Tune	-50-+50	Pitch of the tone's sound (in 1-cent steps)
<b>Osc2 &amp; Sync</b>		
Osc 2 Waveform	(same as Osc 1)	
Osc 2 Pulse Width		
Osc 2 Coarse Tune		
Osc 2 Fine Tune		
Osc 2 Level	0-127	Level of the OSC2
Osc Sync Switch	OFF, ON	Turning this switch on produces a complex sound with many harmonics. This is effective when the OSC1 pitch is higher than the OSC2 pitch.
<b>Filter</b>		
Filter Type	OFF, LPF, BPF, HPF, PKG	Type of filter <b>OFF:</b> No filter is used. <b>LPF:</b> Low Pass Filter. This reduces the volume of all frequencies above the cutoff frequency (Cutoff) in order to round off, or un-brighten the sound. <b>BPF:</b> Band Pass Filter. This leaves only the frequencies in the region of the cutoff frequency, and cuts the rest. <b>HPF:</b> High Pass Filter. This cuts the frequencies in the region below the cutoff frequency. <b>PKG:</b> Peaking Filter. This emphasizes the frequencies in the region of the cutoff frequency.
Cutoff	0-127	Frequency at which the filter begins to have an effect on the waveform's frequency components
Resonance	0-127	Emphasizes the portion of the sound in the region of the cutoff frequency, adding character to the sound.
<b>LFO</b>		
LFO Rate	0-127	Modulation speed of the LFO
LFO Osc 1 Pitch Depth	-63-+63	Depth to which the LFO will modulate the Osc 1 pitch
LFO Osc 2 Pitch Depth	-63-+63	Depth to which the LFO will modulate the Osc 2 pitch
LFO Osc 1 Pulse Width Depth	-63-+63	Depth to which the LFO will modulate the pulse width of the Osc 1 waveform * The Pulse Width is activated when "SQR" is selected with Osc 1 waveform.
LFO Osc 2 Pulse Width Depth	-63-+63	Depth to which the LFO will modulate the pulse width of the Osc 2 waveform * The Pulse Width is activated when "SQR" is selected with Osc 2 waveform.

[4 (ATV EXP)]

Parameter	Value	Explanation
Range Min	0-127	Lower limit of the range of the Active Expression. The effect will be applied when the position of your hand above the D Beam controller is lower than this value.
Range Max	0-127	Upper limit of the range of the Active Expression. The effect will be applied when the position of your hand above the D Beam controller is above this value. * By setting Range Max below Range Min you can invert the range of change.

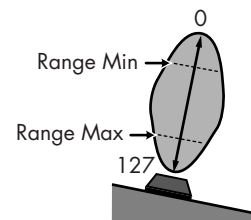

[5 (ASSIGN)]

Parameter	Value	Explanation
Type	CC01-31, 33-95, BEND UP, BEND DOWN, START/STOP, TAP TEMPO, ARP GRID, ARP DURATION, ARP MOTIF, ARP OCTAVE UP, ARPOCTAVE DOWN, ARP STEP, AFTERTOUCH	Function controlled by the D Beam controller <b>CC01-31, 33-95:</b> Controller numbers 1-31, 33-95 <b>BEND UP:</b> Controls the pitch as specified by the "Pitch Bend Range Up" setting (p. 101). <b>BEND DOWN:</b> Controls the pitch as specified by the "Pitch Bend Range Down" setting (p. 101). <b>START/STOP:</b> Starts/stops the song or rhythm pattern. <b>TAP TEMPO:</b> Tap tempo (a tempo specified by the interval at which you move your hand over the D Beam controller). <b>ARP GRID:</b> Specifies the arpeggio's time signature and swing <b>ARP DURATION:</b> Duration of each arpeggiated note <b>ARP MOTIF:</b> Ascending/descending arpeggio variation <b>ARP OCTAVE UP:</b> The range in which the arpeggio is sounded will rise in steps of an octave (maximum 3 octaves). <b>ARP OCTAVE DOWN:</b> The range in which the arpeggio is sounded will lower in steps of an octave (maximum 3 octaves). <b>ARP STEP:</b> Control the playback position within the arpeggio pattern. <b>AFTERTOUCH:</b> Produce the same effect as aftertouch.
Range Min	0-127	Lower limit of the range of the D Beam controller. The effect will be applied when the position of your hand above the D Beam controller is lower than this value.
Range Max	0-127	Upper limit of the range of the D Beam controller. The effect will be applied when the position of your hand above the D Beam controller is above this value. * By setting Range Max below Range Min you can invert the range of change.

### Detailed Settings for the MIC INPUT (MIC Input Setting)

Here's how to make settings for the MIC INPUT jack, and specify the reverb that will be applied to the connected mic.

1. Press [MENU].  
The Top Menu window will appear.
2. Use [▲][▼] to select "2. Mic Input Setting," and press [ENTER].  
The MIC INPUT SETTING screen will appear.
3. Use the cursor buttons to select the parameter that you want to change.
4. Use the VALUE dial or [DEC] [INC] to change the value.

**MEMO**

If you want to save the changes you made, press [7 (WRITE)]. If you want to exit without saving, press [EXIT] or [6 (EXIT)].

**MEMO**

You can also access the MIC INPUT SETTING screen by holding down [SHIFT] and pressing MIC IN [REVERB].

Parameter	Value	Explanation
Phantom Power	OFF, ON	Turn this ON if you want to use phantom power. * This setting cannot be saved. When the power is turned on, this will be set to "OFF."
Mic-In Reverb Level	0–127	Amount of reverb that is applied to the sound of the mic.
Mic-In Reverb Type	ROOM1, ROOM2, STAGE1, STAGE2, HALL1, HALL2, DELAY, PAN-DELAY	Type of reverb/delay <b>ROOM1:</b> Short, high-density reflections <b>ROOM2:</b> Short, low-density reflections <b>STAGE1:</b> Greater amount of late reverberation <b>STAGE2:</b> Stronger early reflections <b>HALL1:</b> Clear-sounding reverberation <b>HALL2:</b> Rich-sounding reverberation <b>DELAY:</b> Conventional delay <b>PAN-DELAY:</b> Delay that moves the reflections between left and right
Mic-In Reverb Time	0–127	Length of the reverberation (when Mic-In Reverb Type is ROOM1–HALL2) Delay time of the delay (when Mic-In Reverb Type is DELAY or PAN-DELAY)
Mic Mode	ALL, VOCODER ONLY	Specifies whether the sound from the mic will be output at all times (ALL) or only if MFX (p. 84) is set to "79:VOCODER" (VOCODER ONLY).

### Detailed Settings for Minus-One (Minus One Setting)

Here you can specify the parts that will be muted by Minus One (p. 73) when playing back an SMF song.

Parts for which this setting is ON will be muted.



1. Press [MENU].  
The Top Menu window will appear.
2. Use [▲][▼] to select "3. Minus One Setting," and press [ENTER].  
The MINUS ONE SETTING screen will appear.
3. Use the cursor buttons to select to the part that you want to change.
4. Use the VALUE dial or [DEC] [INC] to turn the setting on or off.  
You can also use the following function buttons to turn the setting on/off.
  - Pressing [2 (1 ON)] will turn part 1 on.
  - Pressing [3 (3-4 ON)] will turn part 3 and part 4 on.
  - Pressing [4 (ALL OFF)] will turn all parts off.

**MEMO**

If you want to save the changes you made, press [7 (WRITE)]. If you want to exit without saving, press [EXIT] or [6 (EXIT)].

**MEMO**

You can also access the MINUS ONE SETTING screen by holding down [SHIFT] and pressing [C.CANCEL/MINUS ONE].

## Utility

From the Top Menu window, choose “4. Utility” to access the UTILITY MENU screen. Here you can save user data to USB memory, or restore data from USB memory back into the JUNO-STAGE.



### Backing Up User Data (User Backup)

You can save user data to USB memory. This operation is called “User Backup.”

For the user backup procedure, refer to “Saving Data to USB Memory (User Backup)” (p. 144).

### Restoring Backed-Up Data (User Restore)

User data that was backed-up to USB memory can be restored back into the JUNO-STAGE. This operation is called “User Restore.”

For the user restore procedure, refer to “Restoring Saved Data from USB Memory Back into the JUNO-STAGE (User Restore)” (p. 144).

### Returning to the Factory Settings (Factory Reset)

You can return all of the JUNO-STAGE’s settings to the state they were in when the instrument was shipped from the factory. This operation is called “Factory Reset.”

#### NOTE

If the JUNO-STAGE’s internal memory contains important data that you’ve created, be aware that all of this user data will be lost when you execute the factory reset operation. If you want to keep this data, save it to USB memory before you continue.

1. In the UTILITY MENU screen, use the cursor buttons to select “Factory Reset,” and press [ENTER].

A confirmation message will appear.

2. To execute the factory reset, [7 (EXEC)].  
If you decide to cancel, press [6 (CANCEL)].

When the factory reset has been completed, the following screen will appear.

**Completed.**  
**Turn the Power off**  
**and on again.**

3. Turn the power of the JUNO-STAGE off, then on again.

### Initializing USB Memory (USB Memory Format)

You can initialize (format) USB memory. This operation is called “USB Memory Format.”

#### NOTE

If the USB memory contains important data that you’ve created, be aware that all of this data will be lost when you execute this operation.

1. In the UTILITY MENU screen, use the cursor buttons to select “USB Memory Format,” and press [ENTER].

A confirmation message will appear.



2. To exit the format operation, press [7 (EXEC)].  
If you decide to cancel, press [6 (CANCEL)].

### Playing the Demo Songs

1. Press the [MENU].  
The Top Menu window will appear.
2. Use [▲] [▼] to select "5. Demo Play," and press [ENTER].  
The DEMO MENU screen will appear.



#### NOTE

You can't play the keyboard while the DEMO MENU screen or the DEMO PLAY screen are displayed.

3. Use the VALUE dial or the cursor buttons to select a demo song.
4. Press [ENTER] or [PLAY].  
The DEMO PLAY screen will appear, and the selected demo song will begin playing.  
If you press [7 (PLAY ALL)], the first through fourth songs will play, and playback will stop when the fourth song has ended.  
While a song is playing, you can use [DEC] [INC], [◀] [▶], or [◀] [▶] to select the previous or next song.
5. To stop playback, press [EXIT] or [STOP].  
Playback will stop, and you will return to the DEMO MENU screen.  
Press [EXIT] to exit the DEMO MENU screen.

#### MEMO

For details about Demo Song (such as title, etc.), refer to "Listening to the Demo Songs" (p. 24).

#### MEMO

If USB memory is not connected and [RHYTHM PATTERN] is off (the button is extinguished), you can access the DEMO MENU screen simply by pressing [PLAY].



# Appendices

---

---

# Troubleshooting

If the JUNO-STAGE does not function in the way you expect, first check the following points. If this does not resolve the problem, consult your dealer or a nearby Roland Service Station.

\* If any sort of message is being displayed on the screen during an operation, refer to "Error Messages" (p. 162).

## Problems Concerning the Entire JUNO-STAGE

### Q The power does not turn on.

**A** Make sure that the JUNO-STAGE's AC adaptor is correctly connected to an AC outlet and to the rear panel power connector, and that the adaptor itself and AC power cable are connected correctly (p. 19).

## Issues Related to Sound

### Q There is no sound.

**A** Check the following points.

- Is the power for connected amps and speakers turned on?
- Is the volume turned all the way down?
- Is the VOLUME knob turned all the way down?
- Have connections been made correctly?
- Can you hear sound through headphones?  
If there is sound in the headphones, it is possible that the connection cables are broken, or that your amp/mixer has malfunctioned. Check your cables and amp/mixer system once again.
- If you do not hear sound when you play the keyboard, check whether the Local Switch is turned OFF.  
Make sure that the Local Switch parameter is turned on (p. 150).
- Have all tones in the patch been turned off?  
Turn on "Tone Switch" (p. 95, p. 120).
- The Part level settings may be too low.  
Access the Level parameter, and check the level of each part (p. 140).
- Are the Effect settings correct?  
Check the Effect settings ON or OFF, the Effect Balance or Level (p. 79).
- Is the Wave Expansion Board properly installed?  
When selecting the settings that stipulate the use of XP-A/B waves, Patches, or Rhythm Sets, check that the Wave Expansion Board is installed properly in the slot (p. 18).
- Has the volume been lowered by pedal operations or by MIDI messages (volume messages or expression messages) received from an external MIDI device?

### Q A specific Part does not sound.

**A** Check the following points.

- Has the volume level of the part been lowered?  
Adjust the Level parameter to raise the volume of the part that is not heard (p. 140).
- Is the part being muted?  
Set the Mute parameter to "OFF" (p. 139).
- Could the keyboard switch be off?  
Turn the keyboard switch on (p. 134).

### Q Specific pitch ranges do not sound.

**A** Has a restricted range of notes been set?

If a specific range of notes does not sound, check the Key Range settings for the Patch Tone, the Performance Part.

- Tone Key Range  
Key Range Lower/Key Range Upper parameter (p. 102)
- Part Key Range  
PART VIEW K.L/K.U parameter (p. 142)

### Q The sound is distorted.

**A** Check the following points.

- Is an effect which distorts the sound being applied?  
If the sound for a specific patch or part is distorted, lower the volume level on that part.
- If all sounds are distorted, use the VOLUME knob to lower the volume level.
- Could the Output Gain be excessively high?  
In "System Menu," check the "Sound" parameter of "GENERAL" (p. 146).

### Q Pitch is incorrect.

**A** Check the following points.

- Is the tuning of the JUNO-STAGE incorrect?  
Check the Master Tune parameter setting (p. 146).
- Has the pitch been changed by pedal operations or by Pitch Bend messages received from an external MIDI device?
- Have the Coarse or Fine parameters been set for specific Parts?  
Check the Coarse parameter and Fine parameter settings (p. 141).

### Q The sound is interrupted.

**A** Sounds will be interrupted if more than 128 voices are used simultaneously.

- Reduce the number of Tones that you are using.
- Increase the Voice Reserve setting for parts that must not drop out (p. 142).

**Q When I play the keyboard, notes do not stop.**

**A** Is the pedal polarity of the Hold Pedal reversed?  
Check the Hold Pedal Polarity parameter setting (p. 147).

**Q The sound cuts off when I switch Patches in Patch mode.**

**A** Although you can apply a wide variety of multi-effects with the JUNO-STAGE's multi-effects, switching the Patch also switches the type of multi-effects used.

In such instances, discrepancies between the sound being produced and the multi-effects type can arise, which may result in sounds being different than intended, so sounds produced when Patches are switched may be muted when factory settings are in effect. In certain situations, such as when not using multi-effects that have a great influence on the sound, remembering to set Patch Remain parameter (p. 146) to "ON" allows you to switch Patches without sounds being muted.

**Q When switching Patches in Patch mode, the volume and other parameters set with Control Changes end up being reset.**

**A** Set Patch Remain parameter (p. 146) to "ON." Even once they have switched Patches, Control Change messages that have been received are carried forward, so even when switching a Patch whose level is turned all the way down by a Control Change volume message, the level remains unchanged.

**Q If the Tone Delay time value is set to the note, then does the delay time not change beyond a fixed length when the tempo is slowed down?**

**A** There is a maximum permissible value for the Tone Delay Time parameter (p. 111). So, if the time setting is specified in terms of a note value, and the tempo is slowed down, this maximum permissible value will be reached, and it cannot be increased further. The upper time limit for each is the maximum value that can be set other than the numerical value for the beat.

**Q Even when I set the Pan for a Patch completely to one side, sound still comes from the other channel.**

**A** The JUNO-STAGE's internal effects are in stereo, so if you have effects applied to a Patch, even if the Pan is set all the way to one side, you will still be able to hear sounds of the effect component from the other channel.

**Q Sometimes, when playing legato, the pitch won't rise.**

**A** When the Legato Switch parameter (p. 101) is "ON," and the Legato Retrigger parameter (p. 101) is "OFF," and you hold down keys in the high register to play legato, the upper pitch limit of the wave may be exceeded, so that the pitch does not rise as far as you expect, but will stop rising at a certain point. Additionally, if differing upper pitch limits are used for the waves of a Patch that uses multiple tones, it may stop being heard in MONO. When making large pitch changes, set the Legato Retrigger parameter to "ON."

**Q The notes sound strange in the upper registers of the keyboard.**

**A** Sometimes when playing the keys in the upper part of the JUNO-STAGE's keyboard, the sound may stop, or the pitch may stop rising; or with certain keys, there may be intermittent noise. This occurs mainly when the JUNO-STAGE's upper pitch limit is exceeded, so this issue doesn't arise in the ranges normally used. But, in any case, it does not indicate a malfunction.

**Q Although the same Patch is selected, it sounds different when I listen to it in the Performance.**

**A** In Performance mode, the parameters of each part of the performance can apply further modification to parameters such as pan, octave, and filter, relative to the settings specified by the patch. Thus, Patches in a Performance may sound different than they do when heard in Patch mode.

Additionally, although a Patch may comprise tones created with the use of the multi-effects, the multi-effects used in the Performance may differ from the multi-effects selected by the Patch. Check the multi-effect settings of the performance. Also do the same for the Chorus and Reverb settings.

## Issues Related to Effects

**Q Effects not applied.**

- A** Check the following points.
- Could the effect switch be off?  
In the EFFECT SWITCH window, check the on/off status of each effect (p. 79).
  - Are the various effect settings correct? (p. 80, p. 82)
  - If the send level of each effect is set to 0, the effect will not be applied. Check the settings.
  - Even with send levels to each effect set at 0, effects are not applied if the Multi-effects Output Level, the Chorus Level, or the Reverb Level is set to 0. Check each setting.

**Q The Modulation or other controller is always on.**

**A** Check the Matrix Controller settings (p. 110).  
The JUNO-STAGE allows you to use the Matrix Control to control Patches in real time. The Matrix Control functions as the control source for the Control Change and other MIDI messages received by the JUNO-STAGE, and makes changes to the various Patch parameters based on these messages.  
Depending on these settings, the JUNO-STAGE may be responding to MIDI messages sent from external MIDI devices, and may result the Patches sounding different than intended.

**Q Raising the chorus or reverb send level for each part of a performance still does not cause the effect to be applied sufficiently.**

**A** Although you can make Send level settings to the Chorus and Reverb for each individual Part in a Performance, these values only set the upper limit of the Chorus and Reverb Send levels for the Patch used. Accordingly, even when the value is set to the maximum of 127, if the Send level is lowered in the Patch being used, there will be no effect. In addition, different Patch Chorus and Reverb Send level settings can be used according to whether or not the multi-effects are used.

**Q Using the Matrix Control or other such means to control the LFO results in noise when the Pan is changed suddenly.**

**A** Lower the change in speed (LFO Rate).  
Due to the specialized processing used for the Pan, which alters the volume level in each of the left and right sides, sudden Pan movements causing rapid changes in these levels creates large changes in volume, and noise from this may be audible as a result.

**Q Multi-effect 43: DELAY or other delay time value is set to the note, and then the tempo is slowed down, does the delay time not change beyond a fixed length?**

**A** Such Delay time settings have an upper limit, so if the upper limit of a value set to the note is exceeded when the tempo is retarded, that upper value cannot rise any further. The upper time limit for each is the maximum value that can be set other than the numerical value for the beat.

## Issues Related to Saving Data

**Q The Performance sounds different than when it was written.**

**A** If you have modified the settings of a patch used by a performance, or if the temporary patch of the performance has been modified by an external MIDI device, these patches must also be saved.

If patches used by a performance have been edited when you write that performance, the JUNO-STAGE will display a message asking whether you want to discard these patches. In such cases, first save the patch (p. 97) or rhythm set (p. 123), and then save the performance (p. 133) again.

**Q Patches sound different than when written.**

**A** The write operation cannot be used to save Patches as changed in Patch mode using Control Change messages from an external MIDI device.

**Q The Arpeggio and D Beam controller settings in the Performance are different than those for the Patch.**

**A** Since the JUNO-STAGE stores arpeggio and D Beam controller settings for each performance, it will operate according to the arpeggio and D Beam controller settings that were specified for each performance.

## Issues Related to Songs

**Q Playlists are not shown**

**A** This may be due to the following reasons.

- Playlists may not be shown if you directly add/delete/modify the song data in the PLAYLIST folder without using Playlist Editor.
- For some reason the USB memory is not recognized.
- It is possible that the USB memory was not formatted correctly. The JUNO-STAGE can use USB memory that has been formatted as FAT. If your USB memory was formatted using any other method, please re-format it using FAT.

**Q Songs are not shown**

**A** This may be due to the following reasons.

- Are the songs placed in the root directory?
- Songs may not be shown if you directly add/delete/modify the song data in the PLAYLIST folder without using Playlist Editor.
- It is possible that the USB memory was not formatted correctly. The JUNO-STAGE can use USB memory that has been formatted as FAT. If your USB memory was formatted using any other method, please re-format it using FAT.

## Q Songs won't play

**A** This may be due to the following reasons.

- Could a “?” mark be shown by the song in the play list? Songs (audio files) whose sample rate is other than 44.1 kHz cannot be played by the JUNO-STAGE.
- The file type of the song is not one of the file types that the JUNO-STAGE can play.
- It may be that the song data is damaged.
- Songs cannot be played if you directly add/delete/modify the song data in the PLAYLIST folder without using Playlist Editor.

## Q Can't hear the playback sound

**A** Check the following point.

- VOLUME knob setting
- Value for “PLAYER LEVEL” that appears when you press LEVEL [ ▼ ] [ ▲ ] (p. 69).
- SONG LEVEL EDIT screen settings (p. 71)
- Minus-one setting (p. 73, p. 154)
- Could the system setting “Song/Click Output Mode” be set to “SONG” (p. 151)?  
If this is set to “SONG,” the song will not be output from the OUTPUT L/R jacks. If you want the song to be output from the OUTPUT L/R jacks, set this to “CLICK.”

## Issues Related to MIDI and External Devices

### Q No Sound from connected MIDI device.

**A** Check the following points.

- Is the instrument set to transmit MIDI messages?
- In Patch Mode  
Kbd Patch Rx/Tx Channel parameter (p. 150)
- In Performance Mode  
KBD switch (p. 134).  
MIDI messages are not transmitted for parts whose keyboard switch is turned off.

### Q Exclusive messages are not received.

**A** Check the following points.

- Is the instrument set to receive Exclusive messages?  
Set the Receive Exclusive parameter to “ON” (p. 151).
- Does the Device ID number of the transmitting device match the Device ID number of the JUNO-STAGE?  
Check the Device ID parameter (p. 150).

### Q The JUNO-STAGE's rhythm set does not sound when an external sequencer or MIDI keyboard is connected to the MIDI IN connector.

**A** Check to make sure that the MIDI Transmit channel of the external MIDI device and the JUNO-STAGE's MIDI Receive channel are matched. The MIDI Receive channel used by the JUNO-STAGE in Patch mode is set with the Kbd Patch RX/TX Channel parameter. Rhythm Set performance data is generally received on MIDI Channel 10.

### Q When using sequencing software, operating the knobs or other controls does not affect the sound.

**A** For some sequencing programs, System Exclusive messages are not transmitted by the Thru function. If you are using such sequencer software and want to record system exclusive messages, turn on the following parameters.

- In Patch Mode  
Local Switch parameter (p. 150).
- In Performance Mode  
KBD switch (p. 134).

### Q When the Bend Range for a Patch is increased (48), the pitch does not rise sufficiently, even when a MIDI Pitch Bend message is received.

**A** While Patch Bend Ranges can be set anywhere between 0 and 48, when certain Waves in which the pitch is raised (in the + direction) are used, the pitch may stop rising at a fixed point, rather than continuing to go up. Although a value of 12 is ensured for the upper limit of raised pitches, use caution when setting the Bend Range above this figure.

### Q Mic sound is not output/is too weak.

**A** Check the following points.

- Is the mic cable connected correctly?  
Check the connection.
- Could you have connected a condenser mic?  
If you're using a condenser mic, you'll need to provide phantom power.  
Turn Phantom Power “ON” (p. 154).
- The mic level may have been lowered.  
Could the top panel MIC VOLUME knob be turned down?

### Q The volume level of the instrument connected to JUNO-STAGE is too low.

**A** Could you be using a connection cable that contains a resistor?  
Use a connection cable that does not contain a resistor.

## Issues related to USB memory

### Q USB memory is not detected. The files are not shown.

**A** Check the format of your USB memory.  
The JUNO-STAGE can use USB memory that has been formatted as FAT. If your USB memory was formatted using any other method, please re-format it using FAT.

### Q Can't back up to USB memory

**A** Check the following points.

- Could the USB memory be write protected?
- Is there sufficient free space on the USB memory?

# Error Messages

If an incorrect operation is performed, or if processing could not be performed as you specified, an error message will appear. Refer to the explanation for the error message that appears, and take the appropriate action.

Message	Meaning	Action
<b>USB Memory Not Ready!</b>	USB memory is not connected.	Connect USB memory.
<b>Read Error!</b>	Failed to load data from USB memory.	Make sure that USB memory is correctly connected.
	It may be that the file is damaged.	Do not use this file.
	This file cannot be loaded since its format is incorrect.	Do not use this file.
<b>Write Error!</b>	Failed to write data to USB memory.	Make sure that USB memory is correctly connected.
	Data cannot be written because the USB memory has no more free space.	Delete unneeded files from the USB memory. Alternatively, use a different USB memory device, one that has more free space available.
	The file or the USB memory itself is write protected.	Make sure that the file or the USB memory is not write protected.
<b>Incorrect File!</b>	This is a file that the JUNO-STAGE is unable to play.	Do not use this file.
	This song has not been transferred from Playlist Editor to USB memory.	Select the song for transfer from Playlist Editor, and transfer the data once again to USB memory.
<b>System Memory Damaged!</b>	It is possible that the contents of system memory have been damaged.	Please execute a Factory Reset. If this does not resolve the problem, contact your dealer or a nearby Roland service center.
<b>File Not Found!</b>	The file was not found in USB memory.	Save the file once again in USB memory.
<b>MIDI Buffer Full!</b>	An unusually large amount of MIDI data was received, and could not be processed.	Reduce the amount of MIDI messages that are being transmitted.
<b>MIDI Offline!</b>	The MIDI IN connection was broken.	Check that there is no problem with the MIDI cable connected to the JUNO-STAGE's MIDI IN, and that the MIDI cable was not disconnected.
<b>Now Playing!</b>	The Song Player is currently playing.	Either stop playback, or wait until playback has ended.

# Effects List

## Multi-Effects Parameters (MFX1–3, MFX)

The multi-effects feature 79 different kinds of effects. Some of the effects consist of two or more different effects connected in series. Parameters marked with a sharp “#” can be controlled using a Multi-Effects Control (p. 84) or Matrix Control (p. 110). (Two setting items will change simultaneously for “#1” and “#2”).

FILTER (10 types)		
01	EQUALIZER	P.165
02	SPECTRUM	P.165
03	ISOLATOR	P.165
04	LOW BOOST	P.165
05	SUPER FILTER	P.166
06	STEP FILTER	P.166
07	ENHANCER	P.166
08	AUTO WAH	P.167
09	HUMANIZER	P.167
10	SPEAKER SIMULATOR	P.167
MODULATION (12 types)		
11	PHASER	P.168
12	STEP PHASER	P.168
13	MULTI STAGE PHASER	P.168
14	INFINITE PHASER	P.169
15	RING MODULATOR	P.169
16	STEP RING MODULATOR	P.169
17	TREMOLO	P.169
18	AUTO PAN	P.170
19	STEP PAN	P.170
20	SLICER	P.170
21	ROTARY	P.171
22	VK ROTARY	P.171
CHORUS (12 types)		
23	CHORUS	P.171
24	FLANGER	P.172
25	STEP FLANGER	P.172
26	HEXA-CHORUS	P.172
27	TREMOLO CHORUS	P.173
28	SPACE-D	P.173
29	3D CHORUS	P.173
30	3D FLANGER	P.174
31	3D STEP FLANGER	P.174
32	2BAND CHORUS	P.174
33	2BAND FLANGER	P.175
34	2BAND STEP FLNGR	P.175
DYNAMICS (8 types)		
35	OVERDRIVE	P.176
36	DISTORTION	P.176
37	VS OVERDRIVE	P.176
38	VS DISTORTION	P.176
39	GUITAR AMP SIMULATOR	P.176
40	COMPRESSOR	P.177
41	LIMITER	P.177
42	GATE	P.177

DELAY (13 types)		
43	DELAY	P.178
44	LONG DELAY	P.178
45	SERIAL DELAY	P.179
46	MODULATION DELAY	P.179
47	3TAP PAN DELAY	P.180
48	4TAP PAN DELAY	P.180
49	MULTI TAP DELAY	P.180
50	REVERSE DELAY	P.181
51	SHUFFLE DELAY	P.181
52	3D DELAY	P.182
53	TIME CTRL DELAY	P.182
54	LONG TIME CTRL DELAY	P.182
55	TAPE ECHO	P.183
LO-FI (5 types)		
56	LOFI NOISE	P.183
57	LOFI COMPRESS	P.184
58	LOFI RADIO	P.184
59	TELEPHONE	P.184
60	PHONOGRAPH	P.184
PITCH (3 types)		
61	PITCH SHIFTER	P.185
62	2VOICE PITCH SHIFTER	P.185
63	STEP PITCH SHIFTER	P.185
REVERB (2 types)		
64	REVERB	P.186
65	GATED REVERB	P.186
COMBINATION (12 types)		
66	OVERDRIVE → CHORUS	P.186
67	OVERDRIVE → FLANGER	P.186
68	OVERDRIVE → DELAY	P.187
69	DISTORTION → CHORUS	P.187
70	DISTORTION → FLANGER	P.187
71	DISTORTION → DELAY	P.187
72	ENHANCER → CHORUS	P.187
73	ENHANCER → FLANGER	P.188
74	ENHANCER → DELAY	P.188
75	CHORUS → DELAY	P.188
76	FLANGER → DELAY	P.188
77	CHORUS → FLANGER	P.189
PIANO (1 type)		
78	SYMPATHETIC RESONANCE	P.189
VOCODER (1 type)		
79	VOCODER	P.189

## Effects List

### About Note

Some effect parameters (such as Rate or Delay Time) can be set in terms of a note value.

Such parameters have a num/note switch that lets you specify whether you will set the value as a numerical value or as a note value.

If you want to set Rate (Delay Time) as a numerical value, set the num/note switch to "Hz" ("msec"). If you want to set it as a note value, set the num/note switch to "NOTE."



\* If the Rate is specified as a note value, the modulation will be synchronized with the tempo when you play back SMF song data.

### note:

	Sixty-fourth note		Thirty-second-note triplet
	Sixteenth-note triplet		Dotted thirty-second note
	Eighth-note triplet		Dotted sixteenth note
	Quarter-note triplet		Dotted eighth note
	Half-note triplet		Dotted quarter note
	Whole-note triplet		Dotted half note
	Double-note triplet		Dotted whole note

### NOTE

If a parameter whose num/note switch is set to "NOTE" is specified as a destination for multi-effect control, you will not be able to use multi-effect control to control that parameter.

### NOTE

If you specify the delay time as a note value, slowing down the tempo will not change the delay time beyond a certain length. This is because there is an upper limit for the delay time; if the delay time is specified as a note value and you slow down the tempo until this upper limit is reached, the delay time cannot change any further. This upper limit is the maximum value that can be specified when setting the delay time as a numerical value.

### When Using 3D Effects

The following 3D effects utilize RSS (Roland Sound Space) technology to create a spaciousness that cannot be produced by delay, reverb, chorus, etc.

- 52: 3D DELAY
- 29: 3D CHORUS
- 30: 3D FLANGER
- 31: 3D STEP FLANGER

When using these effects, we recommend that you place your speakers as follows. Also, make sure that the speakers are at a sufficient distance from the walls on either side.

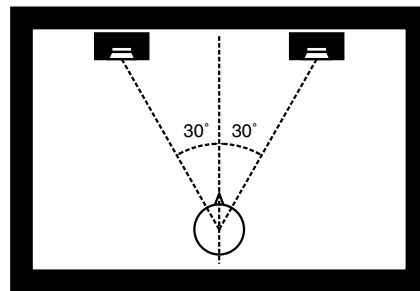

If the left and right speakers are too far apart, or if there is too much reverberation, the full 3D effect may not appear.

Each of these effects has an "Output Mode" parameter. If the sound from the OUTPUT jacks is to be heard through speakers, set this parameter to "SPEAKER." If the sound is to be heard through headphones, set it to "PHONES." This will ensure that the optimal 3D effect will be heard. If this parameter is not set correctly, the full 3D effect may not appear.

### About the STEP RESET function

- 06: STEP FILTER
- 16: STEP RING MOD
- 19: STEP PAN
- 20: SLICER
- 63: STEP PCH SHIFTER

The above five types contain a sixteen-step sequencer.

For these types, you can use a multi-effect control (p. 84) to reset the sequence to play from the first step.

To do this, set the multi-effect control Destination to "Step Reset."

For example if you are using the modulation lever to control the effect, you would make the following settings.

**Source:** CC01: MODULATION  
**Destination:** Step Reset  
**Sens:** +63

With these settings, the sequence will play back from the first step whenever you operate the modulation lever.



### 01: EQUALIZER

This is a four-band stereo equalizer (low, mid x 2, high).

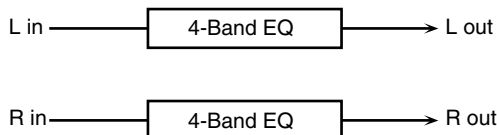

Parameter	Value	Explanation
Low Freq	200, 400 Hz	Frequency of the low range
Low Gain #	-15+15 dB	Gain of the low range
Mid1 Freq	200-8000 Hz	Frequency of the middle range 1
Mid1 Gain	-15+15 dB	Gain of the middle range 1
Mid1 Q	0.5, 1.0, 2.0, 4.0, 8.0	Width of the middle range 1 Set a higher value for Q to narrow the range to be affected.
Mid2 Freq	200-8000 Hz	Frequency of the middle range 2
Mid2 Gain	-15+15 dB	Gain of the middle range 2
Mid2 Q	0.5, 1.0, 2.0, 4.0, 8.0	Width of the middle range 2 Set a higher value for Q to narrow the range to be affected.
High Freq	2000, 4000, 8000 Hz	Frequency of the high range
High Gain #	-15+15 dB	Gain of the high range
Level #	0-127	Output Level

### 02: SPECTRUM

This is a stereo spectrum. Spectrum is a type of filter which modifies the timbre by boosting or cutting the level at specific frequencies.

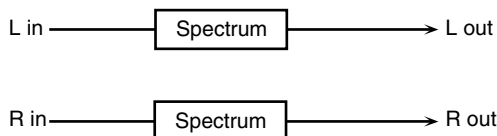

Parameter	Value	Explanation
Band1 (250Hz)	-15+15 dB	Gain of each frequency band
Band2 (500Hz)		
Band3 (1000Hz)		
Band4 (1250Hz)		
Band5 (2000Hz)		
Band6 (3150Hz)		
Band7 (4000Hz)		
Band8 (8000Hz)		
Q	0.5, 1.0, 2.0, 4.0, 8.0	Simultaneously adjusts the width of the adjusted ranges for all the frequency bands.
Level #	0-127	Output Level

### 03: ISOLATOR

This is an equalizer which cuts the volume greatly, allowing you to add a special effect to the sound by cutting the volume in varying ranges.

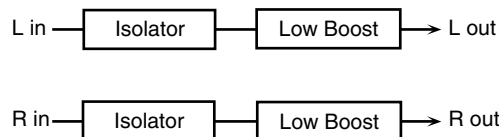

Parameter	Value	Explanation
Boost/Cut Low #	-60+4 dB	These boost and cut each of the High, Middle, and Low frequency ranges. At -60 dB, the sound becomes inaudible. 0 dB is equivalent to the input level of the sound.
Boost/Cut Mid #		
Boost/Cut High #		
Anti Phase Low Sw	OFF, ON	Turns the Anti-Phase function on and off for the Low frequency ranges. When turned on, the counter-channel of stereo sound is inverted and added to the signal.
Anti Phase Low Level	0-127	Adjusts the level settings for the Low frequency ranges. Adjusting this level for certain frequencies allows you to lend emphasis to specific parts. (This is effective only for stereo source.)
Anti Phase Mid Sw	OFF, ON	Settings of the Anti-Phase function for the Middle frequency ranges
Anti Phase Mid Level	0-127	The parameters are the same as for the Low frequency ranges.
Low Boost Sw	OFF, ON	Turns Low Booster on/off. This emphasizes the bottom to create a heavy bass sound.
Low Boost Level	0-127	Increasing this value gives you a heavier low end. * Depending on the Isolator and filter settings this effect may be hard to distinguish.
Level	0-127	Output Level

### 04: LOW BOOST

Boosts the volume of the lower range, creating powerful lows.

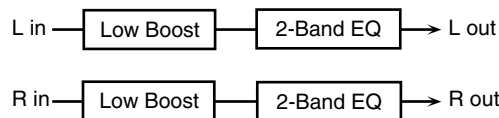

Parameter	Value	Explanation
Boost Frequency #	50-125 Hz	Center frequency at which the lower range will be boosted
Boost Gain #	0+12 dB	Amount by which the lower range will be boosted
Boost Width	WIDE, MID, NARROW	Width of the lower range that will be boosted
Low Gain	-15+15 dB	Gain of the low frequency range
High Gain	-15+15 dB	Gain of the high frequency range
Level	0-127	Output level

## Effects List

### 05: SUPER FILTER

This is a filter with an extremely sharp slope. The cutoff frequency can be varied cyclically.

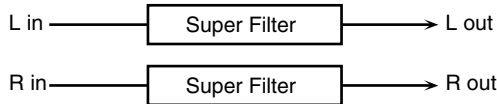

Parameter	Value	Explanation
Filter Type	LPF, BPF, HPF, NOTCH	Filter type Frequency range that will pass through each filter <b>LPF</b> : frequencies below the cutoff <b>BPF</b> : frequencies in the region of the cutoff <b>HPF</b> : frequencies above the cutoff <b>NOTCH</b> : frequencies other than the region of the cutoff
		Amount of attenuation per octave <b>-36 dB</b> : extremely steep <b>-24 dB</b> : steep <b>-12 dB</b> : gentle
Filter Slope	-12, -24, -36 dB	
Filter Cutoff #	0-127	Cutoff frequency of the filter Increasing this value will raise the cutoff frequency.
Filter Resonance #	0-127	Filter resonance level Increasing this value will emphasize the region near the cutoff frequency.
Filter Gain	0+12 dB	Amount of boost for the filter output
Modulation Sw	OFF, ON	On/off switch for cyclic change
Modulation Wave	TRI, SQR, SIN, SAW1, SAW2	How the cutoff frequency will be modulated <b>TRI</b> : triangle wave <b>SQR</b> : square wave <b>SIN</b> : sine wave <b>SAW1</b> : sawtooth wave (upward) <b>SAW2</b> : sawtooth wave (downward)
	SAW1 SAW2	
Rate #	0.05-10.00Hz, note	Rate of modulation
Depth	0-127	Depth of modulation
Attack #	0-127	Speed at which the cutoff frequency will change This is effective if Modulation Wave is SQR, SAW1, or SAW2.
Level	0-127	Output level

### 06: STEP FILTER

This is a filter whose cutoff frequency can be modulated in steps. You can specify the pattern by which the cutoff frequency will change.

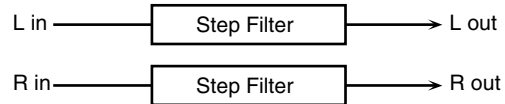

Parameter	Value	Explanation
Step 01-16	0-127	Cutoff frequency at each step
Rate #	0.05-10.00Hz, note	Rate of modulation
Attack #	0-127	Speed at which the cutoff frequency changes between steps
Filter Type	LPF, BPF, HPF, NOTCH	Filter type Frequency range that will pass through each filter <b>LPF</b> : frequencies below the cutoff <b>BPF</b> : frequencies in the region of the cutoff <b>HPF</b> : frequencies above the cutoff <b>NOTCH</b> : frequencies other than the region of the cutoff
		Amount of attenuation per octave <b>-12 dB</b> : gentle <b>-24 dB</b> : steep <b>-36 dB</b> : extremely steep
Filter Slope	-12, -24, -36 dB	
Filter Resonance #	0-127	Filter resonance level Increasing this value will emphasize the region near the cutoff frequency.
Filter Gain	0+12 dB	Amount of boost for the filter output
Level	0-127	Output level

#### MEMO

You can use multi-effect control to make the step sequence play again from the beginning (p. 164).

### 07: ENHANCER

Controls the overtone structure of the high frequencies, adding sparkle and tightness to the sound.

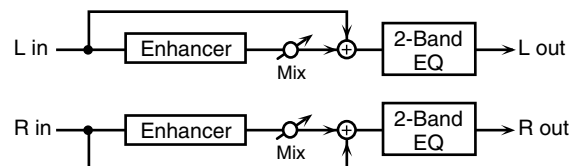

Parameter	Value	Explanation
Sens #	0-127	Sensitivity of the enhancer
Mix #	0-127	Level of the overtones generated by the enhancer
Low Gain	-15+15 dB	Gain of the low range
High Gain	-15+15 dB	Gain of the high range
Level	0-127	Output Level

### 08: AUTO WAH

Cyclically controls a filter to create cyclic change in timbre.



Parameter	Value	Explanation
<b>Filter Type</b>	LPF, BPF	Type of filter <b>LPF:</b> The wah effect will be applied over a wide frequency range. <b>BPF:</b> The wah effect will be applied over a narrow frequency range.
<b>Manual #</b>	0–127	Adjusts the center frequency at which the effect is applied.
<b>Peak</b>	0–127	Adjusts the amount of the wah effect that will occur in the range of the center frequency. Set a higher value for Q to narrow the range to be affected.
<b>Sens #</b>	0–127	Adjusts the sensitivity with which the filter is controlled.
<b>Polarity</b>	UP, DOWN	Sets the direction in which the frequency will change when the auto-wah filter is modulated. <b>UP:</b> The filter will change toward a higher frequency. <b>DOWN:</b> The filter will change toward a lower frequency.
<b>Rate #</b>	0.05–10.00 Hz, note	Frequency of modulation
<b>Depth #</b>	0–127	Depth of modulation
<b>Phase #</b>	0–180 deg	Adjusts the degree of phase shift of the left and right sounds when the wah effect is applied.
<b>Low Gain</b>	-15–+15 dB	Gain of the low range
<b>High Gain</b>	-15–+15 dB	Gain of the high range
<b>Level</b>	0–127	Output Level

### 09: HUMANIZER

Adds a vowel character to the sound, making it similar to a human voice.

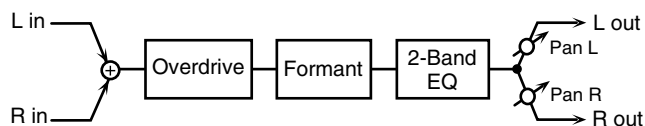

Parameter	Value	Explanation
<b>Drive Sw</b>	OFF, ON	Turns Drive on/off.
<b>Drive #</b>	0–127	Degree of distortion Also changes the volume.
<b>Vowel1</b>	a, e, i, o, u	Selects the vowel.
<b>Vowel2</b>	a, e, i, o, u	
<b>Rate #</b>	0.05–10.00 Hz, note	Frequency at which the two vowels switch
<b>Depth #</b>	0–127	Effect depth
<b>Input Sync Sw</b>	OFF, ON	LFO reset on/off Determines whether the LFO for switching the vowels is reset by the input signal (ON) or not (OFF).
<b>Input Sync Threshold</b>	0–127	Volume level at which reset is applied

Parameter	Value	Explanation
<b>Manual #</b>	0–100	Point at which Vowel 1/2 switch <b>49 or less:</b> Vowel 1 will have a longer duration. <b>50:</b> Vowel 1 and 2 will be of equal duration. <b>51 or more:</b> Vowel 2 will have a longer duration.
<b>Low Gain</b>	-15–+15 dB	Gain of the low frequency range
<b>High Gain</b>	-15–+15 dB	Gain of the high frequency range
<b>Pan #</b>	L64–63R	Stereo location of the output
<b>Level</b>	0–127	Output level

### 10: SPEAKER SIMULATOR

Simulates the speaker type and mic settings used to record the speaker sound.

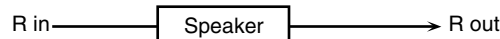
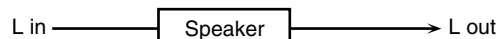

Parameter	Value	Explanation
<b>Speaker Type</b>	(See the table right.)	Type of speaker
<b>Mic Setting</b>	1, 2, 3	Adjusts the location of the mic that is recording the sound of the speaker. This can be adjusted in three steps, with the mic becoming more distant in the order of 1, 2, and 3.
<b>Mic Level #</b>	0–127	Volume of the microphone
<b>Direct Level #</b>	0–127	Volume of the direct sound
<b>Level #</b>	0–127	Output Level

#### Specifications of each Speaker Type

The speaker column indicates the diameter of each speaker unit (in inches) and the number of units.

Type	Cabinet	Speaker	Mic
<b>SMALL 1</b>	small open-back enclosure	10	dynamic
<b>SMALL 2</b>	small open-back enclosure	10	dynamic
<b>MIDDLE</b>	open back enclosure	12 x 1	dynamic
<b>JC-120</b>	open back enclosure	12 x 2	dynamic
<b>BUILT-IN 1</b>	open back enclosure	12 x 2	dynamic
<b>BUILT-IN 2</b>	open back enclosure	12 x 2	condenser
<b>BUILT-IN 3</b>	open back enclosure	12 x 2	condenser
<b>BUILT-IN 4</b>	open back enclosure	12 x 2	condenser
<b>BUILT-IN 5</b>	open back enclosure	12 x 2	condenser
<b>BG STACK 1</b>	sealed enclosure	12 x 2	condenser
<b>BG STACK 2</b>	large sealed enclosure	12 x 2	condenser
<b>MS STACK 1</b>	large sealed enclosure	12 x 4	condenser
<b>MS STACK 2</b>	large sealed enclosure	12 x 4	condenser
<b>METAL STACK</b>	large double stack	12 x 4	condenser
<b>2-STACK</b>	large double stack	12 x 4	condenser
<b>3-STACK</b>	large triple stack	12 x 4	condenser

## Effects List

### 11: PHASER

A phase-shifted sound is added to the original sound and modulated.

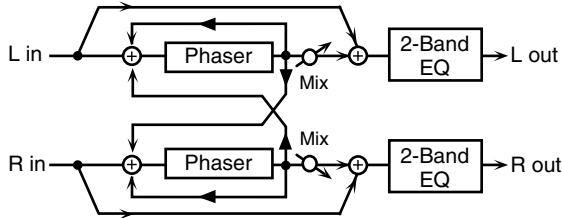

Parameter	Value	Explanation
Mode	4-STAGE, 8-STAGE, 12-STAGE	Number of stages in the phaser
Manual #	0–127	Adjusts the basic frequency from which the sound will be modulated.
Rate #	0.05–10.00 Hz, note	Frequency of modulation
Depth	0–127	Depth of modulation
Polarity	INVERSE, SYNCHRO	Selects whether the left and right phase of the modulation will be the same or the opposite. <b>INVERSE:</b> The left and right phase will be opposite. When using a mono source, this spreads the sound. <b>SYNCHRO:</b> The left and right phase will be the same. Select this when inputting a stereo source.
Resonance #	0–127	Amount of feedback
Cross Feedback	-98–+98%	Adjusts the proportion of the phaser sound that is fed back into the effect. Negative (-) settings will invert the phase.
Mix #	0–127	Level of the phase-shifted sound
Low Gain	-15–+15 dB	Gain of the low range
High Gain	-15–+15 dB	Gain of the high range
Level	0–127	Output Level

### 12: STEP PHASER

The phaser effect will be varied gradually.

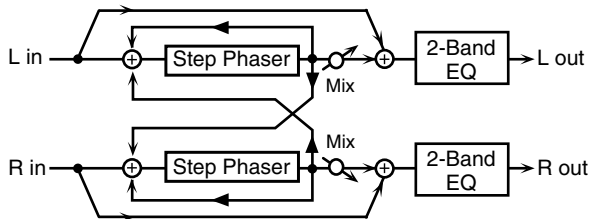

Parameter	Value	Explanation
Mode	4-STAGE, 8-STAGE, 12-STAGE	Number of stages in the phaser
Manual #	0–127	Adjusts the basic frequency from which the sound will be modulated.
Rate #	0.05–10.00 Hz, note	Frequency of modulation
Depth	0–127	Depth of modulation

Parameter	Value	Explanation
Polarity	INVERSE, SYNCHRO	Selects whether the left and right phase of the modulation will be the same or the opposite. <b>INVERSE:</b> The left and right phase will be opposite. When using a mono source, this spreads the sound. <b>SYNCHRO:</b> The left and right phase will be the same. Select this when inputting a stereo source.
Resonance #	0–127	Amount of feedback
Cross Feedback	-98–+98%	Adjusts the proportion of the phaser sound that is fed back into the effect. Negative (-) settings will invert the phase.
Step Rate #	0.10–20.00 Hz, note	Rate of the step-wise change in the phaser effect
Mix #	0–127	Level of the phase-shifted sound
Low Gain	-15–+15 dB	Gain of the low range
High Gain	-15–+15 dB	Gain of the high range
Level	0–127	Output Level

### 13: MULTI STAGE PHASER

Extremely high settings of the phase difference produce a deep phaser effect.

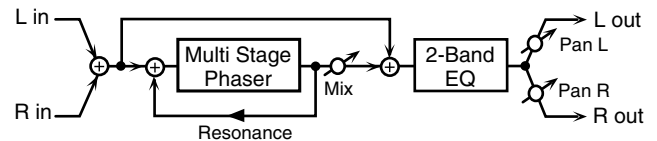

Parameter	Value	Explanation
Mode	4-STAGE, 8-STAGE, 12-STAGE, 16-STAGE, 20-STAGE, 24-STAGE	Number of phaser stages
Manual #	0–127	Adjusts the basic frequency from which the sound will be modulated.
Rate #	0.05–10.00 Hz, note	Frequency of modulation
Depth	0–127	Depth of modulation
Resonance #	0–127	Amount of feedback
Mix #	0–127	Level of the phase-shifted sound
Pan #	L64–63R	Stereo location of the output sound
Low Gain	-15–+15 dB	Gain of the low range
High Gain	-15–+15 dB	Gain of the high range
Level	0–127	Output Level

### 14: INFINITE PHASER

A phaser that continues raising/lowering the frequency at which the sound is modulated.

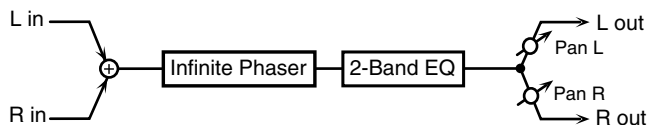

Parameter	Value	Explanation
Mode	1, 2, 3, 4	Higher values will produce a deeper phaser effect.
Speed #	-100+100	Speed at which to raise or lower the frequency at which the sound is modulated (+: upward / -: downward)
Resonance #	0-127	Amount of feedback
Mix #	0-127	Volume of the phase-shifted sound
Pan #	L64-63R	Panning of the output sound
Low Gain	-15+15 dB	Amount of boost/cut for the low-frequency range
High Gain	-15+15 dB	Amount of boost/cut for the high-frequency range
Level	0-127	Output volume

### 15: RING MODULATOR

This is an effect that applies amplitude modulation (AM) to the input signal, producing bell-like sounds. You can also change the modulation frequency in response to changes in the volume of the sound sent into the effect.

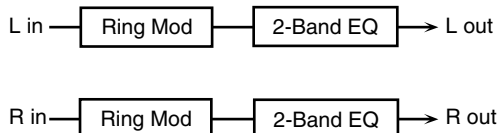

Parameter	Value	Explanation
Frequency #	0-127	Adjusts the frequency at which modulation is applied.
Sens #	0-127	Adjusts the amount of frequency modulation applied.
Polarity	UP, DOWN	Determines whether the frequency modulation moves towards higher frequencies (UP) or lower frequencies (DOWN).
Low Gain	-15+15 dB	Gain of the low frequency range
High Gain	-15+15 dB	Gain of the high frequency range
Balance #	D100:0W-D0:100W	Volume balance between the direct sound (D) and the effect sound (W)
Level	0-127	Output level

### 16: STEP RING MODULATOR

This is a ring modulator that uses a 16-step sequence to vary the frequency at which modulation is applied.

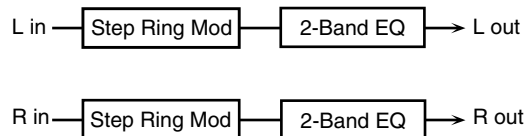

Parameter	Value	Explanation
Step 01-16	0-127	Frequency of ring modulation at each step
Rate #	0.05-10.00 Hz, note	Rate at which the 16-step sequence will cycle
Attack #	0-127	Speed at which the modulation frequency changes between steps
Low Gain	-15+15 dB	Amount of boost/cut for the low-frequency range
High Gain	-15+15 dB	Amount of boost/cut for the high-frequency range
Balance #	D100:0W-D0:100W	Volume balance of the original sound (D) and effect sound (W)
Level	0-127	Output volume

**MEMO**

You can use multi-effect control to make the step sequence play again from the beginning (p. 164).

### 17: TREMOLO

Cyclically modulates the volume to add tremolo effect to the sound.

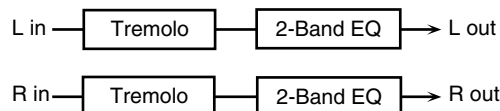



Parameter	Value	Explanation
Mod Wave	TRI, SQR, SIN, SAW1, SAW2	Modulation Wave TRI: triangle wave SQR: square wave SIN: sine wave SAW1/2: sawtooth wave
	SAW1, SAW2	
Rate #	0.05-10.00 Hz, note	Frequency of the change
Depth #	0-127	Depth to which the effect is applied
Low Gain	-15+15 dB	Gain of the low range
High Gain	-15+15 dB	Gain of the high range
Level	0-127	Output Level

## Effects List

### 18: AUTO PAN

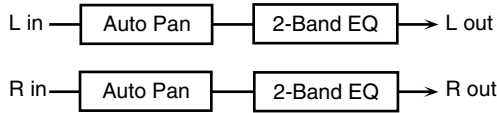
Cyclically modulates the stereo location of the sound.

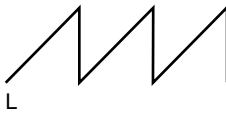

Parameter	Value	Explanation
Mod Wave	TRI, SQR, SIN, SAW1, SAW2	Modulation Wave <b>TRI</b> : triangle wave <b>SQR</b> : square wave <b>SIN</b> : sine wave <b>SAW1/2</b> : sawtooth wave
	SAW1 R  L	SAW2 R  L
Rate #	0.05–10.00 Hz, note	Frequency of the change
Depth #	0–127	Depth to which the effect is applied
Low Gain	-15→+15 dB	Gain of the low range
High Gain	-15→+15 dB	Gain of the high range
Level	0–127	Output Level

### 19: STEP PAN

This uses a 16-step sequence to vary the panning of the sound.

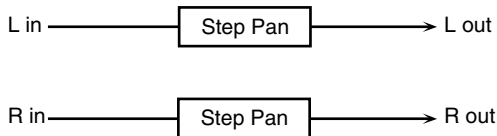

Parameter	Value	Explanation
Step 01–16	164–63R	Pan at each step
Rate #	0.05–10.00 Hz, note	Rate at which the 16-step sequence will cycle
Attack #	0–127	Speed at which the pan changes between steps
Input Sync Sw	OFF, ON	Specifies whether an input note will cause the sequence to resume from the first step of the sequence (ON) or not (OFF)
Input Sync Threshold	0–127	Volume at which an input note will be detected
Level	0–127	Output volume

#### MEMO

You can use multi-effect control to make the step sequence play again from the beginning (p. 164).

### 20: SLICER

By applying successive cuts to the sound, this effect turns a conventional sound into a sound that appears to be played as a backing phrase. This is especially effective when applied to sustain-type sounds.

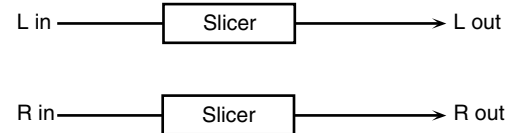

Parameter	Value	Explanation
Step 01–16	0–127	Level at each step
Rate #	0.05–10.00 Hz, note	Rate at which the 16-step sequence will cycle
Attack #	0–127	Speed at which the level changes between steps
Input Sync Sw	OFF, ON	Specifies whether an input note will cause the sequence to resume from the first step of the sequence (ON) or not (OFF)
Input Sync Threshold	0–127	Volume at which an input note will be detected
Mode	LEGATO, SLASH	Sets the manner in which the volume changes as one step progresses to the next. <b>LEGATO</b> : The change in volume from one step's level to the next remains unaltered. If the level of a following step is the same as the one preceding it, there is no change in volume. <b>SLASH</b> : The level is momentarily set to 0 before progressing to the level of the next step. This change in volume occurs even if the level of the following step is the same as the preceding step.
Shuffle #	0–127	Timing of volume changes in levels for even-numbered steps (step 2, step 4, step 6...). The higher the value, the later the beat progresses.
Level	0–127	Output level

#### MEMO

You can use multi-effect control to make the step sequence play again from the beginning (p. 164).

## 21: ROTARY

The Rotary effect simulates the sound of the rotary speakers often used with the electric organs of the past. Since the movement of the high range and low range rotors can be set independently, the unique type of modulation characteristic of these speakers can be simulated quite closely. This effect is most suitable for electric organ Patches.

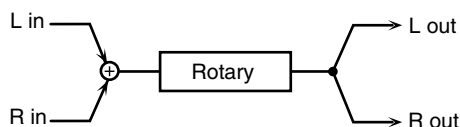

Parameter	Value	Explanation
Speed #	SLOW, FAST	Simultaneously switch the rotational speed of the low frequency rotor and high frequency rotor. <b>SLOW:</b> Slows down the rotation to the Slow Rate. <b>FAST:</b> Speeds up the rotation to the Fast Rate.
Woofer Slow Speed	0.05–10.00 Hz	Slow speed (SLOW) of the low frequency rotor
Woofer Fast Speed	0.05–10.00 Hz	Fast speed (FAST) of the low frequency rotor
Woofer Acceleration	0–15	Adjusts the time it takes the low frequency rotor to reach the newly selected speed when switching from fast to slow (or slow to fast) speed. Lower values will require longer times.
Woofer Level	0–127	Volume of the low frequency rotor
Tweeter Slow Speed	0.05–10.00 Hz	Settings of the high frequency rotor The parameters are the same as for the low frequency rotor
Tweeter Fast Speed	0.05–10.00 Hz	
Tweeter Acceleration	0–15	
Tweeter Level	0–127	
Separation	0–127	Spatial dispersion of the sound
Level #	0–127	Output Level

## 22: VK ROTARY

This type provides modified response for the rotary speaker, with the low end boosted further. This effect features the same specifications as the VK-7's built-in rotary speaker.

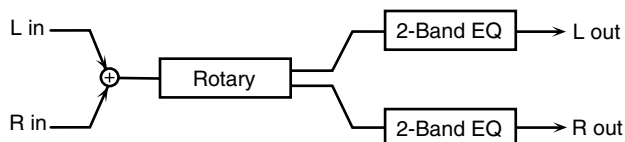

Parameter	Value	Explanation
Speed #	SLOW, FAST	Rotational speed of the rotating speaker
Brake #	OFF, ON	Switches the rotation of the rotary speaker. When this is turned on, the rotation will gradually stop. When it is turned off, the rotation will gradually resume.
Woofer Slow Speed	0.05–10.00 Hz	Low-speed rotation speed of the woofer
Woofer Fast Speed	0.05–10.00 Hz	High-speed rotation speed of the woofer

Parameter	Value	Explanation
Woofer Trans Up	0–127	Adjusts the rate at which the woofer rotation speeds up when the rotation is switched from Slow to Fast.
Woofer Trans Down	0–127	Adjusts the rate at which the woofer rotation speeds up when the rotation is switched from Fast to Slow.
Woofer Level	0–127	Volume of the woofer
Tweeter Slow Speed	0.05–10.00 Hz	Settings of the tweeter The parameters are the same as for the woofer.
Tweeter Fast Speed	0.05–10.00 Hz	
Tweeter Trans Up	0–127	
Tweeter Trans Down	0–127	
Tweeter Level	0–127	
Spread	0–10	Sets the rotary speaker stereo image. The higher the value set, the wider the sound is spread out.
Low Gain	-15→+15 dB	Gain of the low range
High Gain	-15→+15 dB	Gain of the high range
Level #	0–127	Output Level

## 23: CHORUS

This is a stereo chorus. A filter is provided so that you can adjust the timbre of the chorus sound.

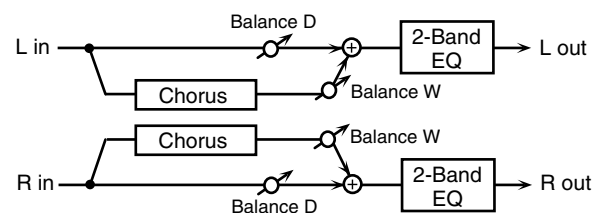

Parameter	Value	Explanation
Filter Type	OFF, LPF, HPF	Type of filter <b>OFF:</b> no filter is used <b>LPF:</b> cuts the frequency range above the Cutoff Freq <b>HPF:</b> cuts the frequency range below the Cutoff Freq
Cutoff Freq	200–8000 Hz	Center frequency when using the filter to cut a specific frequency range
Pre Delay	0.0–100 msec	Adjusts the delay time from the direct sound until the chorus sound is heard.
Rate #	0.05–10.00 Hz, note	Frequency of modulation
Depth	0–127	Depth of modulation
Phase	0–180 deg	Spatial spread of the sound
Low Gain	-15→+15 dB	Gain of the low range
High Gain	-15→+15 dB	Gain of the high range
Balance #	D100:0W–D0:100W	Volume balance between the direct sound (D) and the chorus sound (W)
Level	0–127	Output Level

## Effects List

### 24: FLANGER

This is a stereo flanger. (The LFO has the same phase for left and right.) It produces a metallic resonance that rises and falls like a jet airplane taking off or landing. A filter is provided so that you can adjust the timbre of the flanged sound.

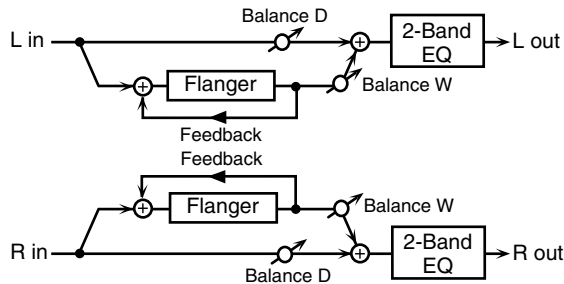

Parameter	Value	Explanation
<b>Filter Type</b>	OFF, LPF, HPF	Type of filter <b>OFF:</b> no filter is used <b>LPF:</b> cuts the frequency range above the Cutoff Freq <b>HPF:</b> cuts the frequency range below the Cutoff Freq
<b>Cutoff Freq</b>	200–8000 Hz	Center frequency when using the filter to cut a specific frequency range
<b>Pre Delay</b>	0.0–100 msec	Adjusts the delay time from when the direct sound begins until the flanger sound is heard.
<b>Rate #</b>	0.05–10.00 Hz, note	Frequency of modulation
<b>Depth</b>	0–127	Depth of modulation
<b>Phase</b>	0–180 deg	Spatial spread of the sound
<b>Feedback #</b>	–98–+98%	Adjusts the proportion of the flanger sound that is fed back into the effect. Negative (-) settings will invert the phase.
<b>Low Gain</b>	–15–+15 dB	Gain of the low range
<b>High Gain</b>	–15–+15 dB	Gain of the high range
<b>Balance #</b>	D100:0W–D0:100W	Volume balance between the direct sound (D) and the flanger sound (W)
<b>Level</b>	0–127	Output Level

### 25: STEP FLANGER

This is a flanger in which the flanger pitch changes in steps. The speed at which the pitch changes can also be specified in terms of a note-value of a specified tempo.

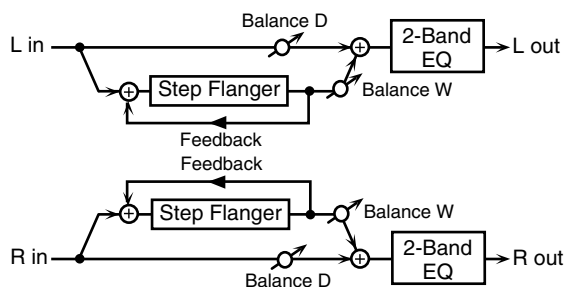

Parameter	Value	Explanation
<b>Filter Type</b>	OFF, LPF, HPF	Type of filter <b>OFF:</b> no filter is used <b>LPF:</b> cuts the frequency range above the Cutoff Freq <b>HPF:</b> cuts the frequency range below the Cutoff Freq
<b>Cutoff Freq</b>	200–8000 Hz	Center frequency when using the filter to cut a specific frequency range
<b>Pre Delay</b>	0.0–100 msec	Adjusts the delay time from when the direct sound begins until the flanger sound is heard.
<b>Rate #</b>	0.05–10.00 Hz, note	Frequency of modulation
<b>Depth</b>	0–127	Depth of modulation
<b>Phase</b>	0–180 deg	Spatial spread of the sound
<b>Feedback #</b>	–98–+98%	Adjusts the proportion of the flanger sound that is fed back into the effect. Negative (-) settings will invert the phase.
<b>Step Rate #</b>	0.10–20.00 Hz, note	Rate (period) of pitch change
<b>Low Gain</b>	–15–+15 dB	Gain of the low range
<b>High Gain</b>	–15–+15 dB	Gain of the high range
<b>Balance #</b>	D100:0W–D0:100W	Volume balance between the direct sound (D) and the flanger sound (W)
<b>Level</b>	0–127	Output Level

### 26: HEXA-CHORUS

Uses a six-phase chorus (six layers of chorused sound) to give richness and spatial spread to the sound.

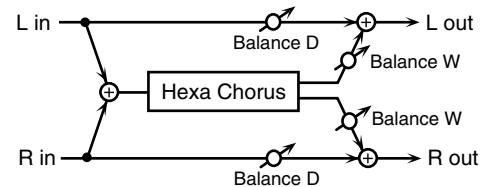

Parameter	Value	Explanation
<b>Pre Delay</b>	0.0–100 msec	Adjusts the delay time from the direct sound until the chorus sound is heard.
<b>Rate #</b>	0.05–10.00 Hz, note	Frequency of modulation
<b>Depth</b>	0–127	Depth of modulation
<b>Pre Delay Deviation</b>	0–20	Adjusts the differences in Pre Delay between each chorus sound.
<b>Depth Deviation</b>	–20–+20	Adjusts the difference in modulation depth between each chorus sound.
<b>Pan Deviation</b>	0–20	Adjusts the difference in stereo location between each chorus sound. <b>0:</b> All chorus sounds will be in the center. <b>20:</b> Each chorus sound will be spaced at 60 degree intervals relative to the center.
<b>Balance #</b>	D100:0W–D0:100W	Volume balance between the direct sound (D) and the chorus sound (W)
<b>Level</b>	0–127	Output Level



### 27: TREMOLO CHORUS

This is a chorus effect with added Tremolo (cyclic modulation of volume).

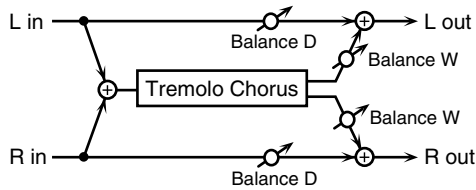

Parameter	Value	Explanation
Pre Delay	0.0–100 msec	Adjusts the delay time from the direct sound until the chorus sound is heard.
Chorus Rate #	0.05–10.00 Hz, note	Modulation frequency of the chorus effect
Chorus Depth	0–127	Modulation depth of the chorus effect
Tremolo Rate #	0.05–10.00 Hz, note	Modulation frequency of the tremolo effect
Tremolo Separation	0–127	Spread of the tremolo effect
Tremolo Phase	0–180 deg	Spread of the tremolo effect
Balance #	D100:0W–D0:100W	Volume balance between the direct sound (D) and the tremolo chorus sound (W)
Level	0–127	Output Level

### 28: SPACE-D

This is a multiple chorus that applies two-phase modulation in stereo. It gives no impression of modulation, but produces a transparent chorus effect.

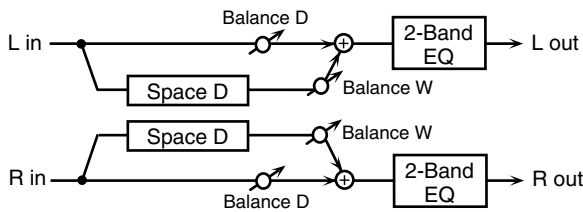

Parameter	Value	Explanation
Pre Delay	0.0–100 msec	Adjusts the delay time from the direct sound until the chorus sound is heard.
Rate #	0.05–10.00 Hz, note	Frequency of modulation
Depth	0–127	Depth of modulation
Phase	0–180 deg	Spatial spread of the sound
Low Gain	-15–+15 dB	Gain of the low range
High Gain	-15–+15 dB	Gain of the high range
Balance #	D100:0W–D0:100W	Volume balance between the direct sound (D) and the chorus sound (W)
Level	0–127	Output Level

### 29: 3D CHORUS

This applies a 3D effect to the chorus sound. The chorus sound will be positioned 90 degrees left and 90 degrees right.

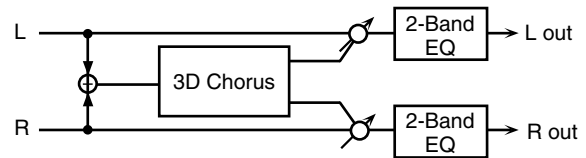

Parameter	Value	Explanation
Filter Type	OFF, LPF, HPF	Type of filter <b>OFF</b> : no filter is used <b>LPF</b> : cuts the frequency range above the Cutoff Freq <b>HPF</b> : cuts the frequency range below the Cutoff Freq
Cutoff Freq	200–8000 Hz	Center frequency when using the filter to cut a specific frequency range
Pre Delay	0.0–100 msec	Adjusts the delay time from the direct sound until the chorus sound is heard.
Rate #	0.05–10.00 Hz, note	Frequency of modulation
Depth	0–127	Modulation depth of the chorus effect
Phase	0–180 deg	Spatial spread of the sound
Output Mode	SPEAKER, PHONES	Adjusts the method that will be used to hear the sound that is output to the OUTPUT jacks. The optimal 3D effect will be achieved if you select <b>SPEAKER</b> when using speakers, or <b>PHONES</b> when using headphones.
Low Gain	-15–+15 dB	Gain of the low range
High Gain	-15–+15 dB	Gain of the high range
Balance #	D100:0W–D0:100W	Volume balance between the direct sound (D) and the chorus sound (W)
Level	0–127	Output Level

## Effects List

### 30: 3D FLANGER

This applies a 3D effect to the flanger sound. The flanger sound will be positioned 90 degrees left and 90 degrees right.

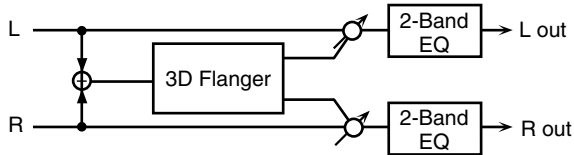

Parameter	Value	Explanation
Filter Type	OFF, LPF, HPF	Type of filter <b>OFF:</b> no filter is used <b>LPF:</b> cuts the frequency range above the Cutoff Freq <b>HPF:</b> cuts the frequency range below the Cutoff Freq
Cutoff Freq	200–8000 Hz	Center frequency when using the filter to cut a specific frequency range
Pre Delay	0.0–100 msec	Adjusts the delay time from when the direct sound begins until the flanger sound is heard.
Rate #	0.05–10.00 Hz, note	Frequency of modulation
Depth	0–127	Depth of modulation
Phase	0–180 deg	Spatial spread of the sound
Feedback #	–98→+98%	Adjusts the proportion of the flanger sound that is fed back into the effect. Negative (-) settings will invert the phase.
Output Mode	SPEAKER, PHONES	Adjusts the method that will be used to hear the sound that is output to the OUTPUT jacks. The optimal 3D effect will be achieved if you select <b>SPEAKER</b> when using speakers, or <b>PHONES</b> when using headphones.
Low Gain	–15→+15 dB	Gain of the low range
High Gain	–15→+15 dB	Gain of the high range
Balance #	D100:0W–D0:100W	Volume balance between the direct sound (D) and the flanger sound (W)
Level	0–127	Output Level

### 31: 3D STEP FLANGER

This applies a 3D effect to the step flanger sound. The flanger sound will be positioned 90 degrees left and 90 degrees right.

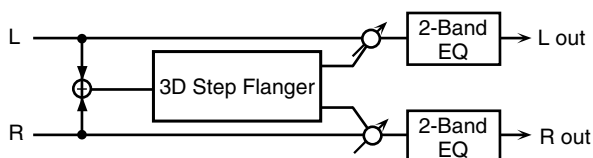

Parameter	Value	Explanation
Filter Type	OFF, LPF, HPF	Type of filter <b>OFF:</b> no filter is used <b>LPF:</b> cuts the frequency range above the Cutoff Freq <b>HPF:</b> cuts the frequency range below the Cutoff Freq
Cutoff Freq	200–8000 Hz	Center frequency when using the filter to cut a specific frequency range

Parameter	Value	Explanation
Pre Delay	0.0–100 msec	Adjusts the delay time from when the direct sound begins until the flanger sound is heard.
Rate #	0.05–10.00 Hz, note	Frequency of modulation
Depth	0–127	Depth of modulation
Phase	0–180 deg	Spatial spread of the sound
Feedback #	–98→+98%	Adjusts the proportion of the flanger sound that is fed back into the effect. Negative (-) settings will invert the phase.
Step Rate #	0.10–20.00 Hz, note	Rate (period) of pitch change
Output Mode	SPEAKER, PHONES	Adjusts the method that will be used to hear the sound that is output to the OUTPUT jacks. The optimal 3D effect will be achieved if you select <b>SPEAKER</b> when using speakers, or <b>PHONES</b> when using headphones.
Low Gain	–15→+15 dB	Gain of the low range
High Gain	–15→+15 dB	Gain of the high range
Balance #	D100:0W–D0:100W	Volume balance between the direct sound (D) and the flanger sound (W)
Level	0–127	Output Level

### 32: 2 BAND CHORUS

A chorus effect that lets you apply an effect independently to the low-frequency and high-frequency ranges.

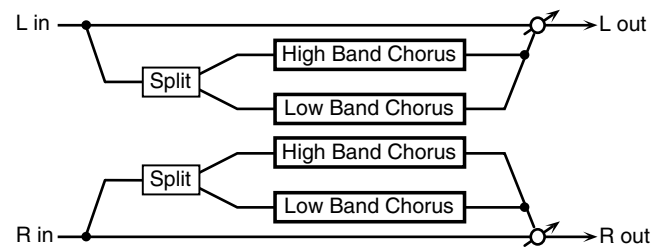

Parameter	Value	Explanation
Split Freq	200–8000 Hz	Frequency at which the low and high ranges will be divided
Low Pre Delay	0.0–100 msec	Delay time from when the original sound is heard to when the low-range chorus sound is heard
Low Rate #	0.05–10.00 Hz, note	Rate at which the low-range chorus sound is modulated
Low Depth	0–127	Modulation depth for the low-range chorus sound
Low Phase	0–180 deg	Spaciousness of the low-range chorus sound
High Pre Delay	0.0–100 msec	Delay time from when the original sound is heard to when the high-range chorus sound is heard
High Rate #	0.05–10.00 Hz, note	Rate at which the low-range chorus sound is modulated
High Depth	0–127	Modulation depth for the high-range chorus sound
High Phase	0–180 deg	Spaciousness of the high-range chorus sound
Balance #	D100:0W–D0:100W	Volume balance of the original sound (D) and chorus sound (W)
Level	0–127	Output volume

### 33: 2 BAND FLANGER

A flanger that lets you apply an effect independently to the low-frequency and high-frequency ranges.

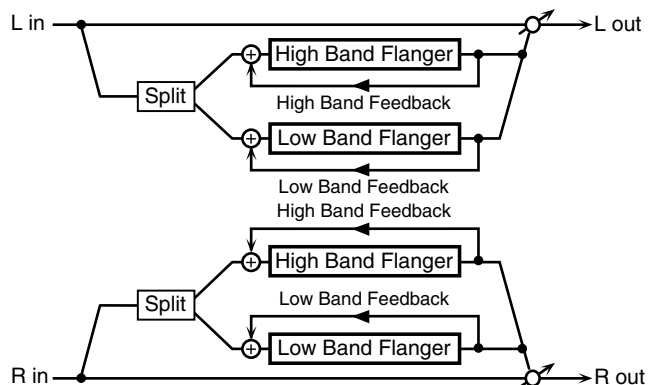

Parameter	Value	Explanation
Split Freq	200–8000 Hz	Frequency at which the low and high ranges will be divided
Low Pre Delay	0.0–100 msec	Delay time from when the original sound is heard to when the low-range flanger sound is heard
Low Rate #	0.05–10.00 Hz, note	Rate at which the low-range flanger sound is modulated
Low Depth	0–127	Modulation depth for the low-range flanger sound
Low Phase	0–180 deg	Spaciousness of the low-range flanger sound
Low Feedback #	–98–+98%	Proportion of the low-range flanger sound that is to be returned to the input (negative values invert the phase)
High Pre Delay	0.0–100 msec	Delay time from when the original sound is heard to when the high-range flanger sound is heard
High Rate #	0.05–10.00 Hz, note	Rate at which the high-range flanger sound is modulated
High Depth	0–127	Modulation depth for the high-range flanger sound
High Phase	0–180 deg	Spaciousness of the high-range flanger sound
High Feedback #	–98–+98%	Proportion of the high-range flanger sound that is to be returned to the input (negative values invert the phase)
Balance #	D100:0W–D0:100W	Volume balance of the original sound (D) and flanger sound (W)
Level	0–127	Output volume

### 34: 2 BAND STEP FLANGER

A step flanger that lets you apply an effect independently to the low-frequency and high-frequency ranges.

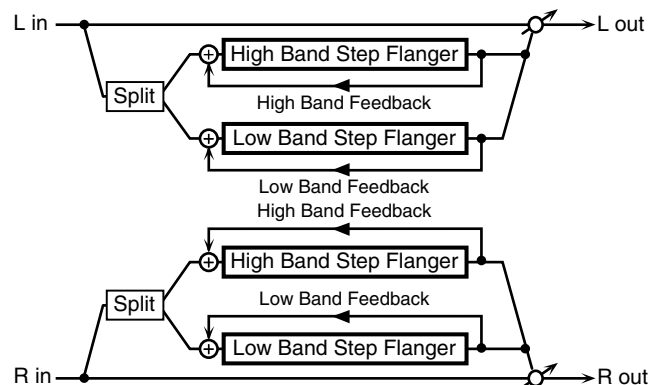

Parameter	Value	Explanation
Split Freq	200–8000 Hz	Frequency at which the low and high ranges will be divided
Low Pre Delay	0.0–100 msec	Delay time from when the original sound is heard to when the low-range flanger sound is heard
Low Rate #	0.05–10.00 Hz, note	Rate at which the low-range flanger sound is modulated
Low Depth	0–127	Modulation depth for the low-range flanger sound
Low Phase	0–180 deg	Spaciousness of the low-range flanger sound
Low Feedback #	–98–+98%	Proportion of the low-range flanger sound that is to be returned to the input (negative values invert the phase)
Low Step Rate #	0.10–20.00 Hz, note	Rate at which the steps will cycle for the low-range flanger sound
High Pre Delay	0.0–100 msec	Delay time from when the original sound is heard to when the high-range flanger sound is heard
High Rate #	0.05–10.00 Hz, note	Rate at which the high-range flanger sound is modulated
High Depth	0–127	Modulation depth for the high-range flanger sound
High Phase	0–180 deg	Spaciousness of the high-range flanger sound
High Feedback #	–98–+98%	Proportion of the high-range flanger sound that is to be returned to the input (negative values invert the phase)
High Step Rate #	0.10–20.00 Hz, note	Rate at which the steps will cycle for the high-range flanger sound
Balance #	D100:0W–D0:100W	Volume balance of the original sound (D) and flanger sound (W)
Level	0–127	Output volume

## Effects List

### 35: OVERDRIVE

Creates a soft distortion similar to that produced by vacuum tube amplifiers.

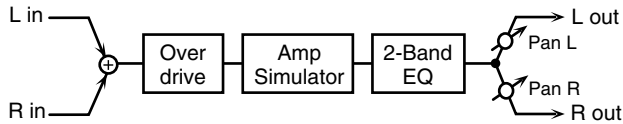

Parameter	Value	Explanation
Drive #	0–127	Degree of distortion Also changes the volume.
Amp Type	SMALL, BUILT-IN, 2-STACK, 3-STACK	Type of guitar amp <b>SMALL:</b> small amp <b>BUILT-IN:</b> single-unit type amp <b>2-STACK:</b> large double stack amp <b>3-STACK:</b> large triple stack amp
Low Gain	-15–+15 dB	Gain of the low range
High Gain	-15–+15 dB	Gain of the high range
Pan #	L64–63R	Stereo location of the output sound
Level	0–127	Output Level

### 36: DISTORTION

Produces a more intense distortion than Overdrive. The parameters are the same as for "35: OVERDRIVE."

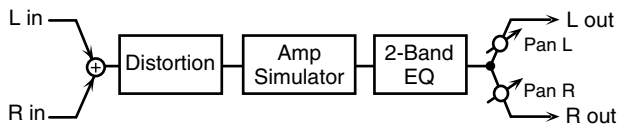

### 37: VS OVERDRIVE

This is an overdrive that provides heavy distortion.

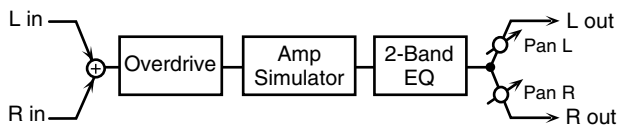

Parameter	Value	Explanation
Drive #	0–127	Degree of distortion Also changes the volume.
Tone #	0–127	Sound quality of the Overdrive effect
Amp Sw	OFF, ON	Turns the Amp Simulator on/off.
Amp Type	SMALL, BUILT-IN, 2-STACK, 3-STACK	Type of guitar amp <b>SMALL:</b> small amp <b>BUILT-IN:</b> single-unit type amp <b>2-STACK:</b> large double stack amp <b>3-STACK:</b> large triple stack amp
Low Gain	-15–+15 dB	Gain of the low range
High Gain	-15–+15 dB	Gain of the high range
Pan #	L64–63R	Stereo location of the output sound
Level	0–127	Output Level

### 38: VS DISTORTION

This is a distortion effect that provides heavy distortion. The parameters are the same as for "37: VS OVERDRIVE."

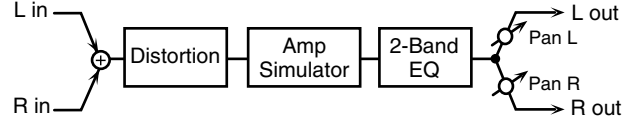

### 39: GUITAR AMP SIMULATOR

This is an effect that simulates the sound of a guitar amplifier.

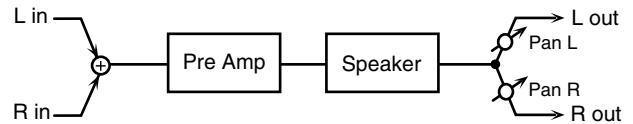

Parameter	Value	Explanation
Pre Amp Sw	OFF, ON	Turns the amp switch on/off.
Pre Amp Type	JC-120, CLEAN TWIN, MATCH DRIVE, BG LEAD, MS1959I, MS1959II, MS1959I+II, SLDN LEAD, METAL 5150, METAL LEAD, OD-1, OD-2 TURBO, DISTORTION, FUZZ	Type of guitar amp
Pre Amp Volume #	0–127	Volume and amount of distortion of the amp
Pre Amp Master #	0–127	Volume of the entire pre-amp
Pre Amp Gain	LOW, MIDDLE, HIGH	Amount of pre-amp distortion
Pre Amp Bass	0–127	Tone of the bass/mid/treble frequency range * Middle cannot be set if "MATCH DRIVE" is selected as the Pre Amp Type.
Pre Amp Middle		
Pre Amp Treble		
Pre Amp Presence	0–127	Tone for the ultra-high frequency range
Pre Amp Bright	OFF, ON	Turning this "On" produces a sharper and brighter sound. * This parameter applies to the "JC-120," "CLEAN TWIN," and "BG LEAD" Pre Amp Types.
Speaker Sw	OFF, ON	Determines whether the signal passes through the speaker (ON), or not (OFF).
Speaker Type	(See the table below.)	Type of speaker
Mic Setting	1, 2, 3	Adjusts the location of the mic that's capturing the sound of the speaker. This can be adjusted in three steps, from 1 to 3, with the mic becoming more distant as the value increases.
Mic Level	0–127	Volume of the mic
Direct Level	0–127	Volume of the direct sound
Pan #	L64–63R	Stereo location of the output
Level #	0–127	Output level

### Specifications for each Speaker Type

The speaker column indicates the diameter of each speaker unit (in inches) and the number of units.

Type	Cabinet	Speaker	Mic
SMALL 1	small open-back enclosure	10	dynamic
SMALL 2	small open-back enclosure	10	dynamic
MIDDLE	open back enclosure	12 x 1	dynamic
JC-120	open back enclosure	12 x 2	dynamic
BUILT-IN 1	open back enclosure	12 x 2	dynamic
BUILT-IN 2	open back enclosure	12 x 2	condenser
BUILT-IN 3	open back enclosure	12 x 2	condenser
BUILT-IN 4	open back enclosure	12 x 2	condenser
BUILT-IN 5	open back enclosure	12 x 2	condenser
BG STACK 1	sealed enclosure	12 x 2	condenser
BG STACK 2	large sealed enclosure	12 x 2	condenser
MS STACK 1	large sealed enclosure	12 x 4	condenser
MS STACK 2	large sealed enclosure	12 x 4	condenser
METAL STACK	large double stack	12 x 4	condenser
2-STACK	large double stack	12 x 4	condenser
3-STACK	large triple stack	12 x 4	condenser

### 40: COMPRESSOR

Flattens out high levels and boosts low levels, smoothing out fluctuations in volume.



Parameter	Value	Explanation
Attack #	0–127	Sets the time from when the input exceeds the Threshold until the volume starts being compressed
Threshold #	0–127	Adjusts the volume at which compression begins
Post Gain	0+18 dB	Adjusts the output gain.
Low Gain	-15+15 dB	Gain of the low frequency range
High Gain	-15+15 dB	Gain of the high frequency range
Level #	0–127	Output level

### 41: LIMITER

Compresses signals that exceed a specified volume level, preventing distortion from occurring.

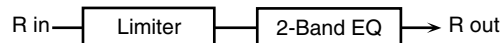

Parameter	Value	Explanation
Release #	0–127	Adjusts the time after the signal volume falls below the Threshold Level until compression is no longer applied.
Threshold #	0–127	Adjusts the volume at which compression begins
Ratio	1.5:1, 2:1, 4:1, 100:1	Compression ratio
Post Gain	0+18 dB	Adjusts the output gain.
Low Gain	-15+15 dB	Gain of the low frequency range
High Gain	-15+15 dB	Gain of the high frequency range
Level #	0–127	Output level

### 42: GATE

Cuts the reverb's delay according to the volume of the sound sent into the effect. Use this when you want to create an artificial-sounding decrease in the reverb's decay.

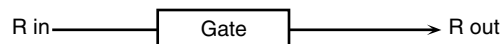
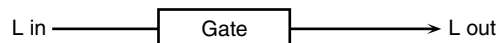

Parameter	Value	Explanation
Threshold #	0–127	Volume level at which the gate begins to close
Mode	GATE, DUCK	Type of gate <b>GATE:</b> The gate will close when the volume of the original sound decreases, cutting the original sound. <b>DUCK (Ducking):</b> The gate will close when the volume of the original sound increases, cutting the original sound.
Attack	0–127	Adjusts the time it takes for the gate to fully open after being triggered.
Hold	0–127	Adjusts the time it takes for the gate to start closing after the source sound falls beneath the Threshold.
Release	0–127	Adjusts the time it takes the gate to fully close after the hold time.
Balance #	D100:0W–D0:100W	Volume balance between the direct sound (D) and the effect sound (W)
Level	0–127	Output level

## Effects List

### 43: DELAY

This is a stereo delay.

When Feedback Mode is NORMAL:

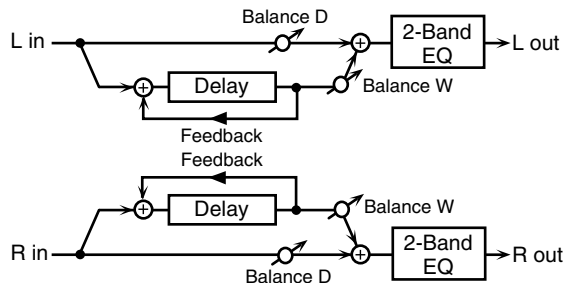

When Feedback Mode is CROSS:

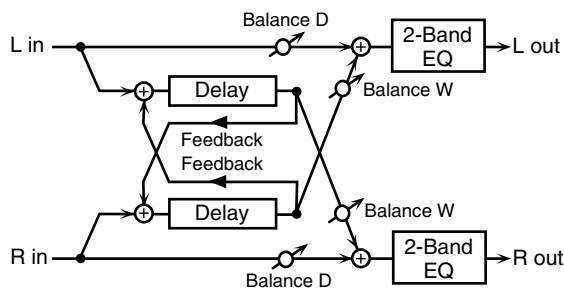

Parameter	Value	Explanation
Delay Left	0–1300 msec, note	Adjusts the time until the delay sound is heard.
Delay Right		
Phase Left	NORMAL, INVERSE	Phase of the delay sound
Phase Right		
Feedback Mode	NORMAL, CROSS	Selects the way in which delay sound is fed back into the effect. (See the figures above.)
Feedback #	-98–+98%	Adjusts the amount of the delay sound that's fed back into the effect. Negative (-) settings invert the phase.
HF Damp	200–8000 Hz, BYPASS	Adjusts the frequency above which sound fed back to the effect is filtered out. If you don't want to filter out any high frequencies, set this parameter to BYPASS.
Low Gain	-15–+15 dB	Gain of the low frequency range
High Gain	-15–+15 dB	Gain of the high frequency range
Balance #	D100:0W–D0:100W	Volume balance between the direct sound (D) and the delay sound (W)
Level	0–127	Output level

### 44: LONG DELAY

A delay that provides a long delay time.

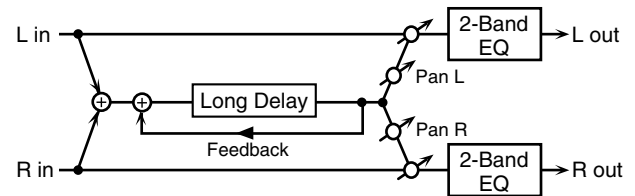

Parameter	Value	Explanation
Delay Time	0–2600 msec, note	Delay time from when the original sound is heard to when the delay sound is heard
Phase	NORMAL, INVERSE	Phase of the delay (NORMAL: non-inverted, INVERT: inverted)
Feedback #	-98–+98%	Proportion of the delay sound that is to be returned to the input (negative values invert the phase)
HF Damp	200–8000 Hz, BYPASS	Frequency at which the high-frequency content of the delayed sound will be cut (BYPASS: no cut)
Pan #	L64–63R	Panning of the delay sound
Low Gain	-15–+15 dB	Amount of boost/cut for the high-frequency range
High Gain	-15–+15 dB	Amount of boost/cut for the high-frequency range
Balance #	D100:0W–D0:100W	Volume balance of the original sound (D) and delay sound (W)
Level	0–127	Output volume

### 45: SERIAL DELAY

This delay connects two delay units in series. Feedback can be applied independently to each delay unit, allowing you to produce complex delay sounds.

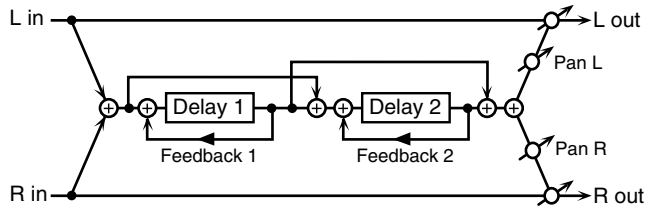

Parameter	Value	Explanation
<b>Delay 1 Time</b>	0–1300 msec, note	Delay time from when sound is input to delay 1 until the delay sound is heard
<b>Delay 1 Feedback #</b>	-98–+98%	Proportion of the delay sound that is to be returned to the input of delay 1 (negative values invert the phase)
<b>Delay 1 HF Damp</b>	200–8000 Hz, BYPASS	Frequency at which the high-frequency content of the delayed sound of delay 1 will be cut (BYPASS: no cut)
<b>Delay 2 Time</b>	0–1300 msec, note	Delay time from when sound is input to delay 2 until the delay sound is heard
<b>Delay 2 Feedback #</b>	-98–+98%	Proportion of the delay sound that is to be returned to the input of delay 2 (negative values invert the phase)
<b>Delay 2 HF Damp</b>	200–8000 Hz, BYPASS	Frequency at which the high-frequency content of the delayed sound of delay 2 will be cut (BYPASS: no cut)
<b>Pan #</b>	L64–63R	Panning of the delay sound
<b>Low Gain</b>	-15–+15 dB	Amount of boost/cut for the low-frequency range
<b>High Gain</b>	-15–+15 dB	Amount of boost/cut for the high-frequency range
<b>Balance #</b>	D100:0W–D0:100W	Volume balance of the original sound (D) and delay sound (W)
<b>Level</b>	0–127	Output volume

### 46: MODULATION DELAY

Adds modulation to the delayed sound. When Feedback Mode is NORMAL:

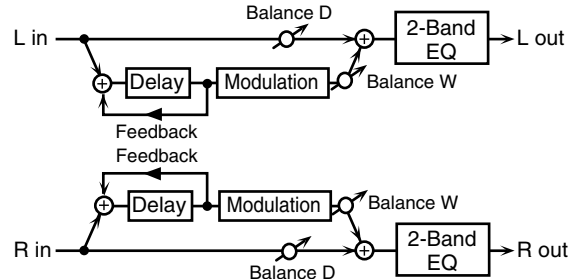

When Feedback Mode is CROSS:

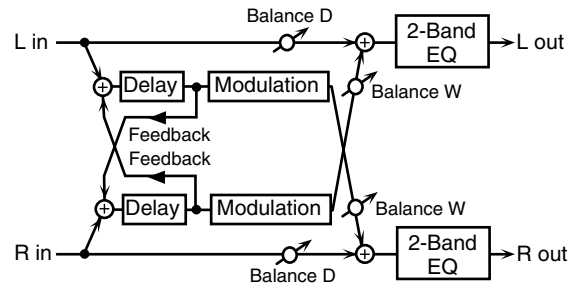

Parameter	Value	Explanation
<b>Delay Left</b>	0–1300 msec, note	Adjusts the time until the delay sound is heard.
<b>Delay Right</b>	0–1300 msec, note	Adjusts the time until the delay sound is heard.
<b>Feedback Mode</b>	NORMAL, CROSS	Selects the way in which delay sound is fed back into the effect (See the figures above.)
<b>Feedback #</b>	-98–+98%	Adjusts the amount of the delay sound that's fed back into the effect. Negative (-) settings invert the phase.
<b>HF Damp</b>	200–8000 Hz, BYPASS	Adjusts the frequency above which sound fed back to the effect is filtered out. If you don't want to filter out any high frequencies, set this parameter to BYPASS.
<b>Rate #</b>	0.05–10.00 Hz, note	Frequency of modulation
<b>Depth</b>	0–127	Depth of modulation
<b>Phase</b>	0–180 deg	Spatial spread of the sound
<b>Low Gain</b>	-15–+15 dB	Gain of the low frequency range
<b>High Gain</b>	-15–+15 dB	Gain of the high frequency range
<b>Balance #</b>	D100:0W–D0:100W	Volume balance between the direct sound (D) and the delay sound (W)
<b>Level</b>	0–127	Output level

# Effects List

## 47: 3TAP PAN DELAY

Produces three delay sounds; center, left and right.

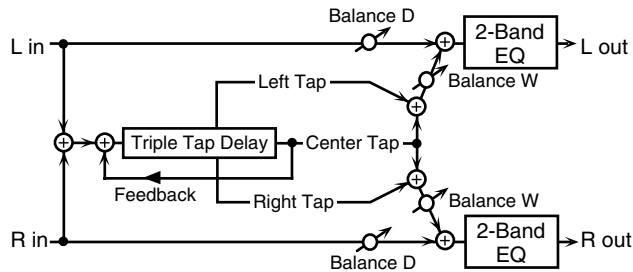

Parameter	Value	Explanation
Delay Left/Right/Center	0–2600 msec, note	Adjusts the time from the original sound until the left, right, and center delayed sounds are heard
Center Feedback #	–98–+98%	Adjusts the amount of the delay sound that's fed back into the effect. Negative (–) settings invert the phase.
HF Damp	200–8000 Hz, BYPASS	Adjusts the frequency above which sound fed back to the effect is filtered out. If you do not want to filter out any high frequencies, set this parameter to BYPASS.
Left/Right/Center Level	0–127	Volume of each delay
Low Gain	–15–+15 dB	Gain of the low frequency range
High Gain	–15–+15 dB	Gain of the high frequency range
Balance #	D100:0W–D0:100W	Volume balance between the direct sound (D) and the delay sound (W)
Level	0–127	Output level

## 48: 4TAP PAN DELAY

This effect has four delays.

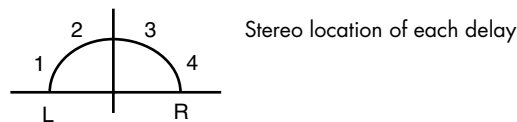
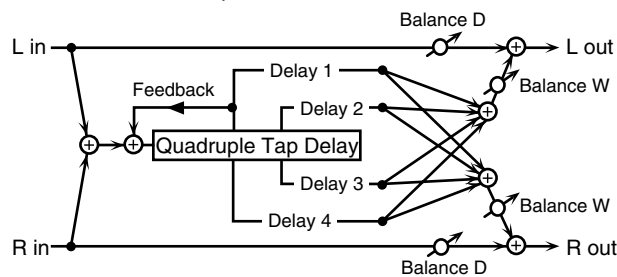

Parameter	Value	Explanation
Delay 1–4 Time	0–2600 msec, note	Adjusts the time from the original sound until delay sounds 1–4 are heard
Delay 1 Feedback #	–98–+98%	Adjusts the amount of the delay sound that's fed back into the effect. Negative (–) settings invert the phase.
HF Damp	200–8000 Hz, BYPASS	Adjusts the frequency above which sound fed back to the effect is filtered out. If you do not want to filter out any high frequencies, set this parameter to BYPASS.
Delay 1–4 Level	0–127	Volume of each delay
Low Gain	–15–+15 dB	Gain of the low frequency range
High Gain	–15–+15 dB	Gain of the high frequency range
Balance #	D100:0W–D0:100W	Volume balance between the direct sound (D) and the effect sound (W)
Level	0–127	Output level

## 49: MULTI TAP DELAY

This effect provides four delays. Each of the Delay Time parameters can be set to a note length based on the selected tempo. You can also set the panning and level of each delay sound.

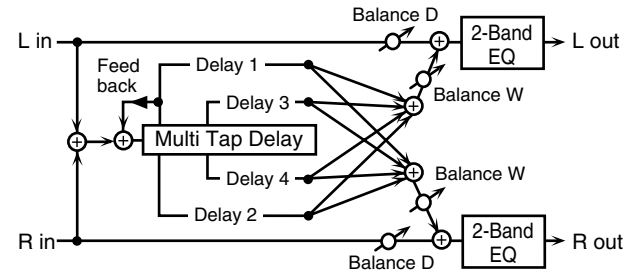

Parameter	Value	Explanation
Delay 1–4 Time	0–2600 msec, note	Adjusts the time until Delays 1–4 are heard.
Delay 1 Feedback #	–98–+98%	Adjusts the amount of the delay sound that's fed back into the effect. Negative (–) settings invert the phase.
HF Damp	200–8000 Hz, BYPASS	Adjusts the frequency above which sound fed back to the effect is filtered out. If you don't want to filter out any the high frequencies, set this parameter to BYPASS.
Delay 1–4 Pan	L64–63R	Stereo location of Delays 1–4
Delay 1–4 Level	0–127	Output level of Delays 1–4
Low Gain	–15–+15 dB	Gain of the low frequency range
High Gain	–15–+15 dB	Gain of the high frequency range
Balance #	D100:0W–D0:100W	Volume balance between the direct sound (D) and the effect sound (W)
Level	0–127	Output level



### 50: REVERSE DELAY

This is a reverse delay that adds a reversed and delayed sound to the input sound. A tap delay is connected immediately after the reverse delay.

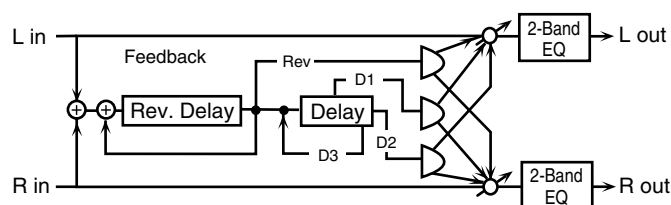

Parameter	Value	Explanation
<b>Threshold</b>	0–127	Volume at which the reverse delay will begin to be applied
<b>Rev Delay Time</b>	0–1300 msec, note	Delay time from when sound is input into the reverse delay until the delay sound is heard
<b>Rev Delay Feedback #</b>	-98–+98%	Proportion of the delay sound that is to be returned to the input of the reverse delay (negative values invert the phase)
<b>Rev Delay HF Damp</b>	200–8000 Hz, BYPASS	Frequency at which the high-frequency content of the reverse-delayed sound will be cut (BYPASS: no cut)
<b>Rev Delay Pan</b>	L64–63R	Panning of the reverse delay sound
<b>Rev Delay Level</b>	0–127	Volume of the reverse delay sound
<b>Delay 1 – 3 Time</b>	0–1300 msec, note	Delay time from when sound is input into the tap delay until the delay sound is heard
<b>Delay 3 Feedback #</b>	-98–+98%	Proportion of the delay sound that is to be returned to the input of the tap delay (negative values invert the phase)
<b>Delay HF Damp</b>	200–8000 Hz, BYPASS	Frequency at which the low-frequency content of the tap delay sound will be cut (BYPASS: no cut)
<b>Delay 1 Pan, Delay 2 Pan</b>	L64–63R	Panning of the tap delay sounds
<b>Delay 1 Level, Delay 2 Level</b>	0–127	Volume of the tap delay sounds
<b>Low Gain</b>	-15–+15 dB	Amount of boost/cut for the low-frequency range
<b>High Gain</b>	-15–+15 dB	Amount of boost/cut for the high-frequency range
<b>Balance #</b>	D100:0W–D0:100W	Volume balance of the original sound (D) and delay sound (W)
<b>Level</b>	0–127	Output volume

### 51: SHUFFLE DELAY

Adds a shuffle to the delay sound, giving the sound a bouncy delay effect with a swing feel.

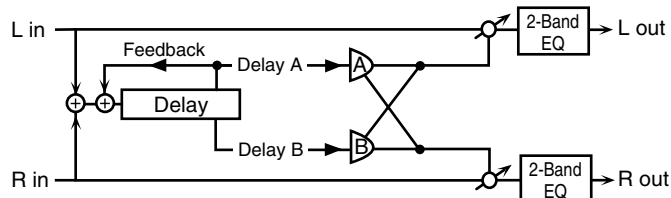

Parameter	Value	Explanation
<b>Delay Time #</b>	0–2600 msec, note	Adjusts the time until the delay sound is heard.
<b>Shuffle Rate #</b>	0–100	Adjusts the ratio (as a percentage) of the time that elapses before Delay B sounds relative to the time that elapses before the Delay A sounds. When set to 100, the delay times are the same.
<b>Acceleration</b>	0–15	Adjusts the speed which the Delay Time changes from the current setting to its specified new setting.
<b>Feedback #</b>	-98–+98%	Adjusts the amount of the delay that's feedback into the effect. Negative (-) settings invert the phase.
<b>HF Damp</b>	200–8000 Hz, BYPASS	Adjusts the frequency above which sound fed back to the effect is filtered out. If you don't want to filter out any high frequencies, set this parameter to BYPASS.
<b>Pan A/B</b>	0–127	Stereo location of Delay A/B
<b>Level A/B</b>	0–127	Volume of delay A/B
<b>Low Gain</b>	-15–+15 dB	Gain of the low frequency range
<b>High Gain</b>	-15–+15 dB	Gain of the high frequency range
<b>Balance #</b>	D100:0W–D0:100W	Volume balance between the direct sound (D) and the effect sound (W)
<b>Level</b>	0–127	Output level

## Effects List

### 52: 3D DELAY

This applies a 3D effect to the delay sound. The delay sound will be positioned 90 degrees left and 90 degrees right.

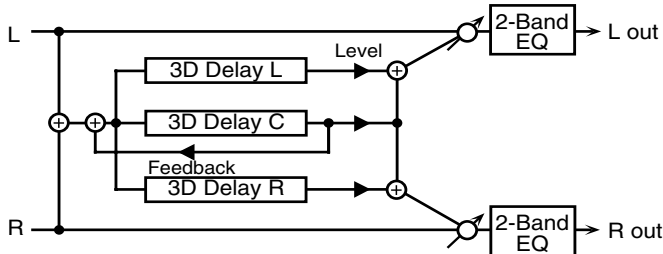

Parameter	Value	Explanation
Delay Left		
Delay Right	0–2600 msec, note	Adjusts the delay time from the direct sound until the delay sound is heard.
Delay Center		
Center Feedback #	-98→+98%	Adjusts the proportion of the delay sound that is fed back into the effect. Negative (-) settings will invert the phase.
HF Damp	200–8000 Hz, BYPASS	Adjusts the frequency above which sound fed back to the effect will be cut. If you do not want to cut the high frequencies, set this parameter to BYPASS.
Left Level		
Right Level	0–127	Output level of the delay sound
Center Level		
Output Mode	SPEAKER, PHONES	Adjusts the method that will be used to hear the sound that is output to the OUTPUT jacks. The optimal 3D effect will be achieved if you select <b>SPEAKER</b> when using speakers, or <b>PHONES</b> when using headphones.
Low Gain	-15→+15 dB	Gain of the low range
High Gain	-15→+15 dB	Gain of the high range
Balance #	D100:0W–D0:100W	Volume balance between the direct sound (D) and the effect sound (W)
Level	0–127	Output Level

### 53: TIME CTRL DELAY

A stereo delay in which the delay time can be varied smoothly.

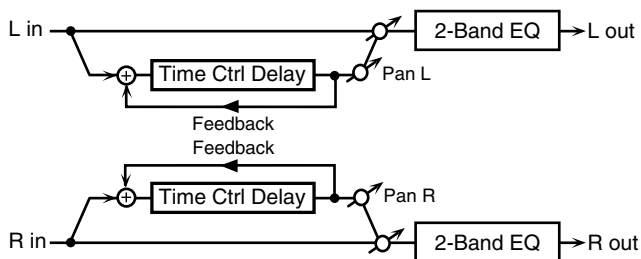

Parameter	Value	Explanation
Delay Time #	0–1300 msec, note	Adjusts the time until the delay is heard.
Acceleration	0–15	Adjusts the speed which the Delay Time changes from the current setting to a specified new setting. The rate of change for the Delay Time directly affects the rate of pitch change.

Parameter	Value	Explanation
Feedback #	-98→+98%	Adjusts the amount of the delay that's fed back into the effect. Negative (-) settings invert the phase.
HF Damp	200–8000 Hz, BYPASS	Adjusts the frequency above which sound fed back to the effect is filtered out. If you do not want to filter out any high frequencies, set this parameter to BYPASS.
Low Gain	-15→+15 dB	Gain of the low frequency range
High Gain	-15→+15 dB	Gain of the high frequency range
Balance #	D100:0W–D0:100W	Volume balance between the direct sound (D) and the delay sound (W)
Level	0–127	Output level

### 54: LONG TIME CTRL DELAY

A delay in which the delay time can be varied smoothly, and allowing an extended delay to be produced.

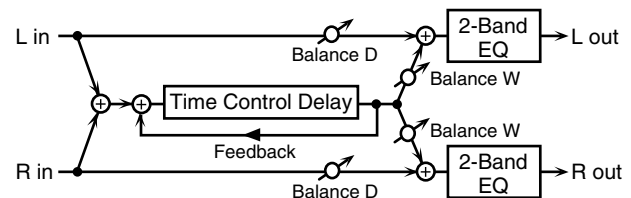

Parameter	Value	Explanation
Delay Time #	0–2600 msec, note	Adjusts the time until the delay is heard.
Acceleration	0–15	Adjusts the speed which the Delay Time changes from the current setting to a specified new setting. The rate of change for the Delay Time directly affects the rate of pitch change.
Feedback #	-98→+98%	Adjusts the amount of the delay that's fed back into the effect. Negative (-) settings invert the phase.
HF Damp	200–8000 Hz, BYPASS	Adjusts the frequency above which sound fed back to the effect is filtered out. If you do not want to filter out any high frequencies, set this parameter to BYPASS.
Pan #	L64–63R	Stereo location of the delay
Low Gain	-15→+15 dB	Gain of the low frequency range
High Gain	-15→+15 dB	Gain of the high frequency range
Balance #	D100:0W–D0:100W	Volume balance between the direct sound (D) and the delay sound (W)
Level	0–127	Output level

### 55: TAPE ECHO

A virtual tape echo that produces a realistic tape delay sound. This simulates the tape echo section of a Roland RE-201 Space Echo.

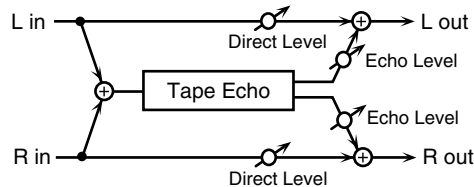

Parameter	Value	Explanation
Mode	S, M, L, S+M, S+L, M+L, S+M+L	Combination of playback heads to use. Select from three different heads with different delay times. <b>S</b> : short, <b>M</b> : middle, <b>L</b> : long
Repeat Rate #	0-127	Tape speed. Increasing this value will shorten the spacing of the delayed sounds.
Intensity #	0-127	Amount of delay repeats
Bass	-15 to +15 dB	Boost/cut for the lower range of the echo sound
Treble	-15 to +15 dB	Boost/cut for the upper range of the echo sound
Head S Pan	164-63R	Independent panning for the short, middle, and long playback heads
Head M Pan		
Head L Pan		
Tape Distortion	0-5	Amount of tape-dependent distortion to be added. This simulates the slight tonal changes that can be detected by signal-analysis equipment. Increasing this value will increase the distortion.
Wow/Flutter Rate	0-127	Speed of wow/flutter (complex variation in pitch caused by tape wear and rotational irregularity)
Wow/Flutter Depth	0-127	Depth of wow/flutter
Echo Level #	0-127	Volume of the echo sound
Direct Level #	0-127	Volume of the original sound
Level	0-127	Output level

### 56: LOFI NOISE

In addition to a lo-fi effect, this adds various types of noise such as white noise and disc noise.

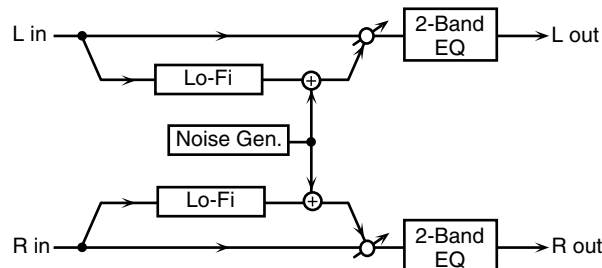

Parameter	Value	Explanation
LoFi Type	1-9	Degrades the sound quality. The sound quality grows poorer as this value is increased.
Post Filter Type	OFF, LPF, HPF	Type of filter that follows the LoFi effect. <b>OFF</b> : no filter is used. <b>LPF</b> : cuts the frequency range above the Cutoff. <b>HPF</b> : cuts the frequency range below the Cutoff.
Post Filter Cutoff	200-8000 Hz	Center frequency of the filter
W/P Noise Type	WHITE, PINK	Switch between white noise and pink noise.
W/P Noise LPF	200-8000 Hz, BYPASS	Center frequency of the low pass filter applied to the white/pink noise (BYPASS: no cut)
W/P Noise Level #	0-127	Volume of the white/pink noise
Disc Noise Type	LP, EP, SP, RND	Type of record noise. The frequency at which the noise is heard depends on the selected type.
Disc Noise LPF	200-8000 Hz, BYPASS	Adjusts the cutoff frequency of the low pass filter applied to the record noise. If you don't want to filter out any high frequencies, set this parameter to BYPASS.
Disc Noise Level #	0-127	Volume of the record noise
Hum Noise Type	50 Hz, 60 Hz	Frequency of the hum noise
Hum Noise LPF	200-8000 Hz, BYPASS	Center frequency of the low pass filter applied to the hum noise (BYPASS: no cut)
Hum Noise Level #	0-127	Volume of the hum noise
Low Gain	-15 to +15 dB	Gain of the low range
High Gain	-15 to +15 dB	Gain of the high range
Balance #	D100:0W-D0:100W	Volume balance between the direct sound (D) and the effect sound (W)
Level	0-127	Output level

## Effects List

### 57: LOFI COMPRESS

This is an effect that intentionally degrades the sound quality for creative purposes.

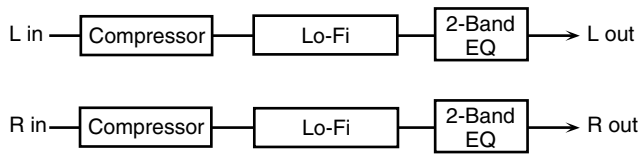

Parameter	Value	Explanation
Pre Filter Type	1–6	Selects the type of filter applied to the sound before it passes through the Lo-Fi effect. 1: Compressor off 2–6: Compressor on
LoFi Type	1–9	Degrades the sound quality. The sound quality grows poorer as this value is increased.
Post Filter Type	OFF, LPF, HPF	Type of filter OFF: no filter is used LPF: cuts the frequency range above the Cutoff HPF: cuts the frequency range below the Cutoff
Post Filter Cutoff	200–8000 Hz	Basic frequency of the Post Filter
Low Gain	-15–+15 dB	Gain of the low range
High Gain	-15–+15 dB	Gain of the high range
Balance #	D100:0W–D0:100W	Volume balance between the direct sound (D) and the effect sound (W)
Level #	0–127	Output level

### 58: LOFI RADIO

In addition to a Lo-Fi effect, this effect also generates radio noise.

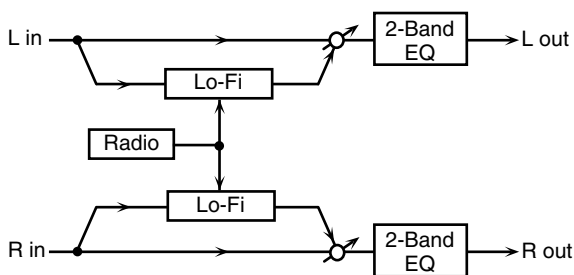

Parameter	Value	Explanation
LoFi Type	1–9	Degrades the sound quality. The sound quality grows poorer as this value is increased.
Post Filter Type	OFF, LPF, HPF	Type of filter OFF: no filter is used LPF: cuts the frequency range above the Cutoff HPF: cuts the frequency range below the Cutoff
Post Filter Cutoff	200–8000 Hz	Basic frequency of the Post Filter
Radio Detune #	0–127	Simulates the tuning noise of a radio. As this value is raised, the tuning drifts further.
Radio Noise Level #	0–127	Volume of the radio noise
Low Gain	-15–+15 dB	Gain of the low range
High Gain	-15–+15 dB	Gain of the high range
Balance #	D100:0W–D0:100W	Volume balance between the direct sound (D) and the effect sound (W)
Level	0–127	Output level

### 59: TELEPHONE

This effect produces a muffled sound, like that heard through a telephone.

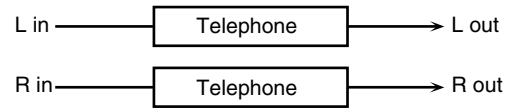

Parameter	Value	Explanation
Voice Quality #	0–15	Audio quality of the telephone voice
Treble	-15–+15 dB	Bandwidth of the telephone voice
Balance #	D100:0–D0:100W	Volume balance between the direct sound (D) and the effect sound (W)
Level	0–127	Output level

### 60: PHONOGRAPH

Simulates a sound recorded on an analog record and played back on a record player. This effect also simulates the various types of noise that are typical of a record, and even the rotational irregularities of an old turntable.

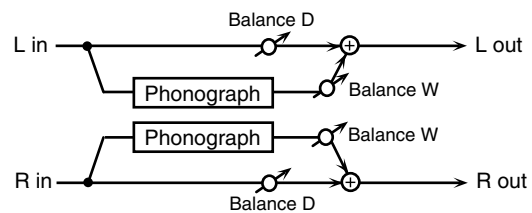

Parameter	Value	Explanation
Signal Distortion	0–127	Depth of distortion
Frequency Range	0–127	Frequency response of the playback system Decreasing this value will produce the impression of an old system with a poor frequency response.
Disc Type	LP, EP, SP	Rotational speed of the turntable This will affect the frequency of the scratch noise.
Scratch Noise Level	0–127	Amount of noise due to scratches on the record
Dust Noise Level	0–127	Volume of noise due to dust on the record
Hiss Noise Level	0–127	Volume of continuous “hiss”
Total Noise Level #	0–127	Volume of overall noise
Wow	0–127	Depth of long-cycle rotational irregularity
Flutter	0–127	Depth of short-cycle rotational irregularity
Random	0–127	Depth of indefinite-cycle rotational irregularity
Total Wow/Flutter #	0–127	Depth of overall rotational irregularity
Balance #	D100:0W–D0:100W	Volume balance between the direct sound (D) and the effect sound (W)
Level	0–127	Output level

### 61: PITCH SHIFTER

A stereo pitch shifter.

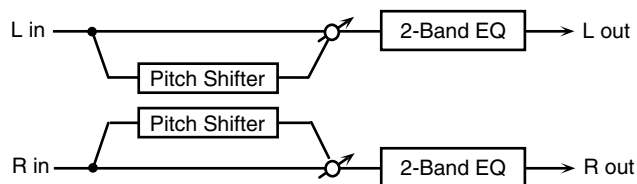

Parameter	Value	Explanation
Coarse #1	-24+12 semi	Adjusts the pitch of the pitch shifted sound in semitone steps.
Fine #1	-100+100 cent	Adjusts the pitch of the pitch shifted sound in 2-cent steps.
Delay Time	0-1300 msec, note	Adjusts the delay time from the direct sound until the pitch shifted sound is heard.
Feedback #	-98+98%	Adjusts the proportion of the pitch shifted sound that is fed back into the effect. Negative (-) settings will invert the phase.
Low Gain	-15+15 dB	Gain of the low range
High Gain	-15+15 dB	Gain of the high range
Balance #	D100:0W-D0:100W	Volume balance between the direct sound (D) and the pitch shifted sound (W)
Level	0-127	Output Level

### 62: 2VOICE PITCH SHIFTER

Shifts the pitch of the original sound. This 2-voice pitch shifter has two pitch shifters, and can add two pitch shifted sounds to the original sound.

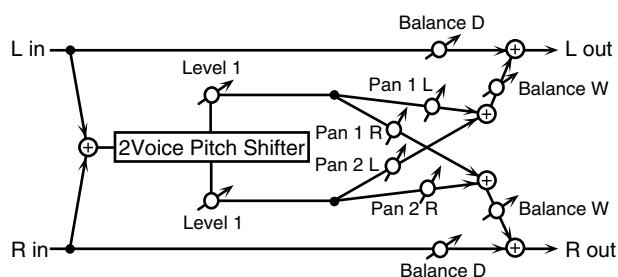

Parameter	Value	Explanation
Pitch1 Coarse #1	-24+12 semi	Adjusts the pitch of Pitch Shift 1 in semitone steps.
Pitch1 Fine #1	-100+100 cent	Adjusts the pitch of Pitch Shift 1 in 2-cent steps.
Pitch1 Delay	0-1300 msec, note	Adjusts the delay time from the direct sound until the Pitch Shift 1 sound is heard.
Pitch1 Feedback #	-98+98%	Adjusts the proportion of the pitch shifted sound that is fed back into the effect. Negative (-) settings will invert the phase.
Pitch1 Pan #	L64-63R	Stereo location of the Pitch Shift 1 sound
Pitch1 Level	0-127	Volume of the Pitch Shift1 sound

Parameter	Value	Explanation
Pitch2 Coarse #2	-24+12 semi	Settings of the Pitch Shift 2 sound. The parameters are the same as for the Pitch Shift 1 sound.
Pitch2 Fine #2	-100+100 cent	
Pitch2 Delay	0-1300 msec, note	
Pitch2 Feedback #	-98+98%	
Pitch2 Pan #	L64-63R	
Pitch2 Level	0-127	
Low Gain	-15+15 dB	Gain of the low range
High Gain	-15+15 dB	Gain of the high range
Balance	D100:0W-D0:100W	Volume balance between the direct sound (D) and the pitch shifted sound (W)
Level	0-127	Output Level

### 63: STEP PITCH SHIFTER

A pitch shifter in which the amount of pitch shift is varied by a 16-step sequence.

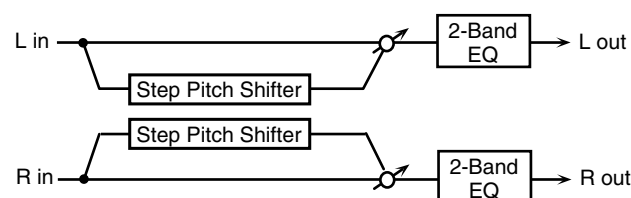

Parameter	Value	Explanation
Step 01-16	-24+12 semi	Amount of pitch shift at each step (semitone units)
Rate #	0.05-10.00 Hz, note	Rate at which the 16-step sequence will cycle
Attack #	0-127	Speed at which the amount of pitch shift changes between steps
Gate Time #	0-127	Duration of the pitch shifted sound at each step
Fine	-100+100 cent	Pitch shift adjustment for all steps (2-cent units)
Delay Time	0-1300 msec, note	Delay time from the original sound until the pitch-shifted sound is heard
Feedback #	-98+98%	Proportion of the pitch-shifted sound that is to be returned to the input (negative values invert the phase)
Low Gain	-15+15 dB	Amount of boost/cut for the low-frequency range
High Gain	-15+15 dB	Amount of boost/cut for the high-frequency range
Balance #	D100:0W-D0:100W	Volume balance of the original sound (D) and pitch-shifted sound (W)
Level	0-127	Output volume

**MEMO**

You can use multi-effect control to make the step sequence play again from the beginning (p. 164).

# Effects List

## 64: REVERB

Adds reverberation to the sound, simulating an acoustic space.

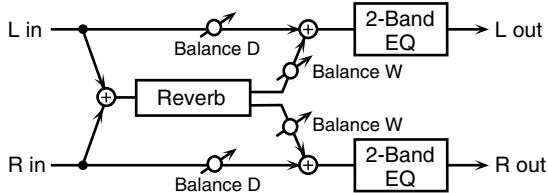

Parameter	Value	Explanation
Type	ROOM1, ROOM2, STAGE1, STAGE2, HALL1, HALL2	Type of reverb <b>ROOM1:</b> dense reverb with short decay <b>ROOM2:</b> sparse reverb with short decay <b>STAGE1:</b> reverb with greater late reverberation <b>STAGE2:</b> reverb with strong early reflections <b>HALL1:</b> reverb with clear reverberance <b>HALL2:</b> reverb with rich reverberance
Pre Delay	0.0–100 msec	Adjusts the delay time from the direct sound until the reverb sound is heard.
Time #	0–127	Time length of reverberation
HF Damp	200–8000 Hz, BYPASS	Adjusts the frequency above which the reverberant sound will be cut. As the frequency is set lower, more of the high frequencies will be cut, resulting in a softer and more muted reverberance. If you do not want to cut the high frequencies, set this parameter to BYPASS.
Low Gain	-15+15 dB	Gain of the low range
High Gain	-15+15 dB	Gain of the high range
Balance #	D100:0W–D0:100W	Volume balance between the direct sound (D) and the reverb sound (W)
Level	0–127	Output Level

## 65: GATED REVERB

This is a special type of reverb in which the reverberant sound is cut off before its natural length.

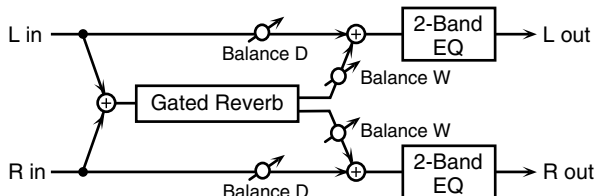

Parameter	Value	Explanation
Type	NORMAL, REVERSE, SWEEP1, SWEEP2	Type of reverb <b>NORMAL:</b> conventional gated reverb <b>REVERSE:</b> backwards reverb <b>SWEEP1:</b> the reverberant sound moves from right to left <b>SWEEP2:</b> the reverberant sound moves from left to right
Pre Delay	0.0–100 msec	Adjusts the delay time from the direct sound until the reverb sound is heard.
Gate Time	5–500 msec	Adjusts the time from when the reverb is heard until it disappears.
Low Gain	-15+15 dB	Gain of the low range

Parameter	Value	Explanation
High Gain	-15+15 dB	Gain of the high range
Balance #	D100:0W–D0:100W	Volume balance between the direct sound (D) and the reverb sound (W)
Level #	0–127	Output Level

## 66: OVERDRIVE → CHORUS

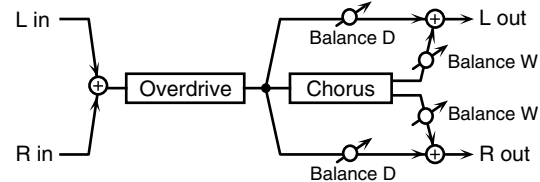

Parameter	Value	Explanation
Overdrive Drive #	0–127	Degree of distortion Also changes the volume.
Overdrive Pan #	L64–63R	Stereo location of the overdrive sound
Chorus Pre Delay	0.0–100 msec	Adjusts the delay time from the direct sound until the chorus sound is heard.
Chorus Rate #	0.05–10.00 Hz, note	Frequency of modulation
Chorus Depth	0–127	Depth of modulation
Chorus Balance #	D100:0W–D0:100W	Adjusts the volume balance between the sound that is sent through the chorus (W) and the sound that is not sent through the chorus (D).
Level	0–127	Output Level

## 67: OVERDRIVE → FLANGER

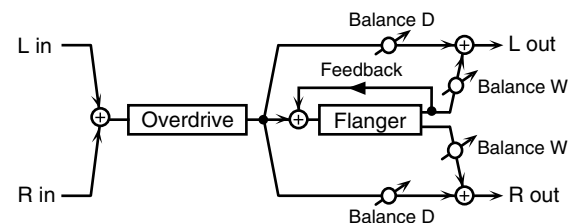

Parameter	Value	Explanation
Overdrive Drive #	0–127	Degree of distortion Also changes the volume.
Overdrive Pan #	L64–63R	Stereo location of the overdrive sound
Flanger Pre Delay	0.0–100 msec	Adjusts the delay time from when the direct sound begins until the flanger sound is heard.
Flanger Rate #	0.05–10.00 Hz, note	Frequency of modulation
Flanger Depth	0–127	Depth of modulation
Flanger Feedback #	-98+98%	Adjusts the proportion of the flanger sound that is fed back into the effect. Negative (-) settings will invert the phase.
Flanger Balance #	D100:0W–D0:100W	Adjusts the volume balance between the sound that is sent through the flanger (W) and the sound that is not sent through the flanger (D).
Level	0–127	Output Level

**68: OVERDRIVE → DELAY**

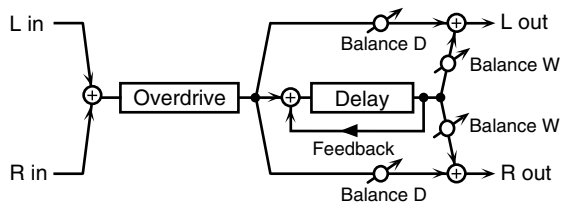

Parameter	Value	Explanation
Overdrive Drive #	0–127	Degree of distortion Also changes the volume.
Overdrive Pan #	L64–63R	Stereo location of the overdrive sound
Delay Time	0–2600 msec, note	Adjusts the delay time from the direct sound until the delay sound is heard.
Delay Feedback #	–98–+98%	Adjusts the proportion of the delay sound that is fed back into the effect. Negative (–) settings will invert the phase.
Delay HF Damp	200–8000 Hz, BYPASS	Adjusts the frequency above which sound fed back to the effect will be cut. If you do not want to cut the high frequencies, set this parameter to BYPASS.
Delay Balance #	D100:0W–D0:100W	Adjusts the volume balance between the sound that is sent through the delay (W) and the sound that is not sent through the delay (D).
Level	0–127	Output Level

**69: DISTORTION → CHORUS**

The parameters are essentially the same as in “66: OVERDRIVE → CHORUS,” with the exception of the following two.  
Overdrive Drive → Distortion Drive,  
Overdrive Pan → Distortion Pan

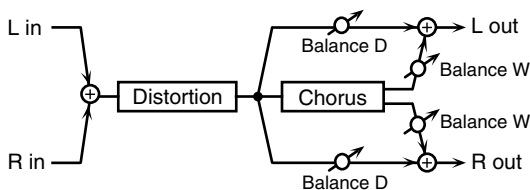

**70: DISTORTION → FLANGER**

The parameters are essentially the same as in “67: OVERDRIVE → FLANGER,” with the exception of the following two.

Overdrive Drive → Distortion Drive,  
Overdrive Pan → Distortion Pan

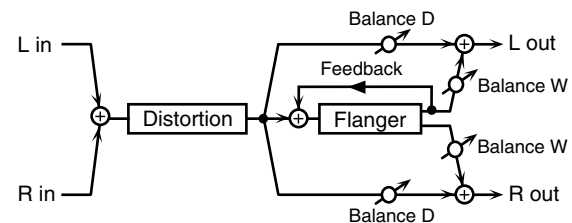

**71: DISTORTION → DELAY**

The parameters are essentially the same as in “68: OVERDRIVE → DELAY,” with the exception of the following two.

Overdrive Drive → Distortion Drive,  
Overdrive Pan → Distortion Pan

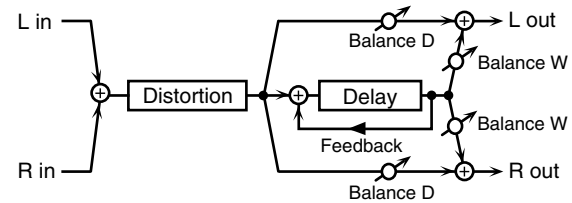

**72: ENHANCER → CHORUS**

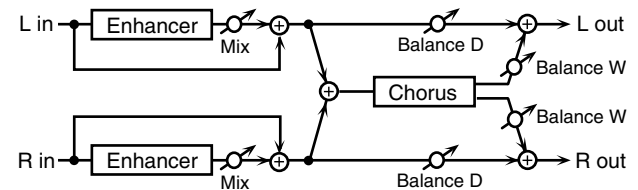

Parameter	Value	Explanation
Enhancer Sens #	0–127	Sensitivity of the enhancer
Enhancer Mix #	0–127	Level of the overtones generated by the enhancer
Chorus Pre Delay	0.0–100 msec	Adjusts the delay time from the direct sound until the chorus sound is heard.
Chorus Rate #	0.05–10.00 Hz, note	Frequency of modulation
Chorus Depth	0–127	Depth of modulation
Chorus Balance #	D100:0W–D0:100W	Adjusts the volume balance between the sound that is sent through the chorus (W) and the sound that is not sent through the chorus (D).
Level	0–127	Output Level

## Effects List

### 73: ENHANCER → FLANGER

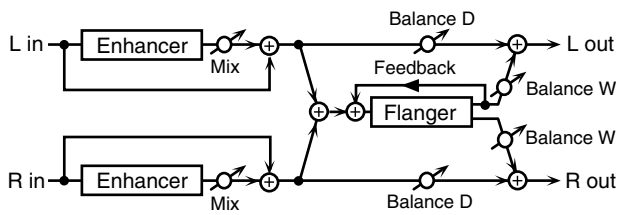

Parameter	Value	Explanation
Enhancer Sens #	0–127	Sensitivity of the enhancer
Enhancer Mix #	0–127	Level of the overtones generated by the enhancer
Flanger Pre Delay	0.0–100 msec	Adjusts the delay time from when the direct sound begins until the flanger sound is heard.
Flanger Rate #	0.05–10.00 Hz, note	Frequency of modulation
Flanger Depth	0–127	Depth of modulation
Flanger Feedback #	-98→+98%	Adjusts the proportion of the flanger sound that is fed back into the effect. Negative (-) settings will invert the phase.
Flanger Balance #	D100:0W–D0:100W	Adjusts the volume balance between the sound that is sent through the flanger (W) and the sound that is not sent through the flanger (D).
Level	0–127	Output Level

### 74: ENHANCER → DELAY

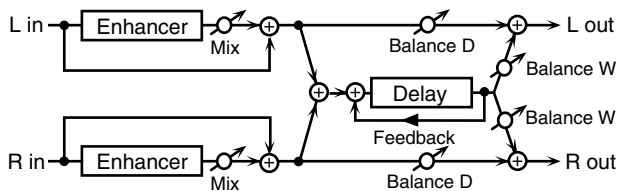

Parameter	Value	Explanation
Enhancer Sens #	0–127	Sensitivity of the enhancer
Enhancer Mix #	0–127	Level of the overtones generated by the enhancer
Delay Time	0–2600 msec, note	Adjusts the delay time from the direct sound until the delay sound is heard.
Delay Feedback #	-98→+98%	Adjusts the proportion of the delay sound that is fed back into the effect. Negative (-) settings will invert the phase.
Delay HF Damp	200–8000 Hz, BYPASS	Adjusts the frequency above which sound fed back to the effect will be cut. If you do not want to cut the high frequencies, set this parameter to BYPASS.
Delay Balance #	D100:0W–D0:100W	Adjusts the volume balance between the sound that is sent through the delay (W) and the sound that is not sent through the delay (D).
Level	0–127	Output Level

### 75: CHORUS → DELAY

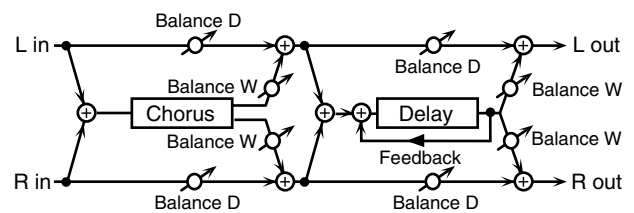

Parameter	Value	Explanation
Chorus Pre Delay	0.0–100 msec	Adjusts the delay time from the direct sound until the chorus sound is heard.
Chorus Rate #	0.05–10.00 Hz, note	Frequency of modulation
Chorus Depth	0–127	Depth of modulation
Chorus Balance #	D100:0W–D0:100W	Volume balance between the direct sound (D) and the chorus sound (W)
Delay Time	0–2600 msec, note	Adjusts the delay time from the direct sound until the delay sound is heard.
Delay Feedback #	-98→+98%	Adjusts the proportion of the delay sound that is fed back into the effect. Negative (-) settings will invert the phase.
Delay HF Damp	200–8000 Hz, BYPASS	Adjusts the frequency above which sound fed back to the effect will be cut. If you do not want to cut the high frequencies, set this parameter to BYPASS.
Delay Balance #	D100:0W–D0:100W	Adjusts the volume balance between the sound that is sent through the delay (W) and the sound that is not sent through the delay (D).
Level	0–127	Output Level

### 76: FLANGER → DELAY

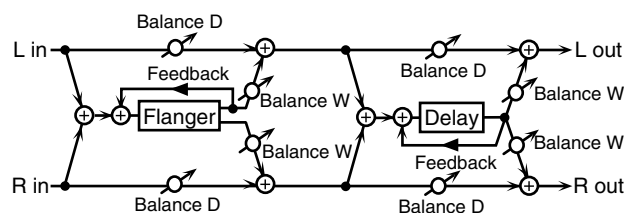

Parameter	Value	Explanation
Flanger Pre Delay	0.0–100 msec	Adjusts the delay time from when the direct sound begins until the flanger sound is heard.
Flanger Rate #	0.05–10.00 Hz, note	Frequency of modulation
Flanger Depth	0–127	Depth of modulation
Flanger Feedback #	-98→+98%	Adjusts the proportion of the flanger sound that is fed back into the effect. Negative (-) settings will invert the phase.
Flanger Balance #	D100:0W–D0:100W	Volume balance between the direct sound (D) and the flanger sound (W)
Delay Time	0–2600 msec, note	Adjusts the delay time from the direct sound until the delay sound is heard.



Parameter	Value	Explanation
Delay Feedback #	-98--+98%	Adjusts the proportion of the delay sound that is fed back into the effect. Negative (-) settings will invert the phase.
Delay HF Damp	200-8000 Hz, BYPASS	Adjusts the frequency above which sound fed back to the effect will be cut. If you do not want to cut the high frequencies, set this parameter to BYPASS.
Delay Balance #	D100:0W-D0:100W	Adjusts the volume balance between the sound that is sent through the delay (W) and the sound that is not sent through the delay (D).
Level	0-127	Output Level

**77: CHORUS → FLANGER**

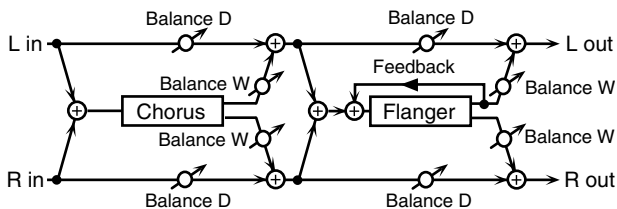

Parameter	Value	Explanation
Chorus Pre Delay	0.0-100 msec	Adjusts the delay time from the direct sound until the chorus sound is heard.
Chorus Rate #	0.05-10.00 Hz, note	Modulation frequency of the chorus effect
Chorus Depth	0-127	Modulation depth of the chorus effect
Chorus Balance #	D100:0W-D0:100W	Volume balance between the direct sound (D) and the chorus sound (W)
Flanger Pre Delay	0.0-100 msec	Adjusts the delay time from when the direct sound begins until the flanger sound is heard.
Flanger Rate #	0.05-10.00 Hz, note	Modulation frequency of the flanger effect
Flanger Depth	0-127	Modulation depth of the flanger effect
Flanger Feedback #	-98--+98%	Adjusts the proportion of the flanger sound that is fed back into the effect. Negative (-) settings will invert the phase.
Flanger Balance #	D100:0W-D0:100W	Adjusts the volume balance between the sound that is sent through the flanger (W) and the sound that is not sent through the flanger (D).
Level	0-127	Output Level

**78: SYMPATHETIC RESONANCE**

On an acoustic piano, holding down the damper pedal allows other strings to resonate in sympathy with the notes you play, creating rich and spacious resonances. This effect simulates these sympathetic resonances.

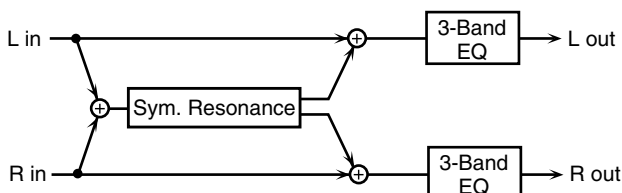

Parameter	Value	Explanation
Depth #	0-127	Depth of the effect
Damper #	0-127	Depth to which the damper pedal is pressed (controls the resonant sound)
Pre LPF	16-15000 Hz, BYPASS	Frequency of the filter that cuts the high-frequency content of the input sound (BYPASS: no cut)
Pre HPF	BYPASS, 16-15000 Hz	Frequency of the filter that cuts the low-frequency content of the input sound (BYPASS: no cut)
Peaking Freq	200-8000 Hz	Frequency of the filter that boosts/cuts a specific frequency region of the input sound
Peaking Gain	-15--+15 dB	Amount of boost/cut produced by the filter at the specified frequency region of the input sound
Peaking Q	0.5, 1.0, 2.0, 4.0, 8.0	Width of the frequency region boosted/cut by the 'Peaking Gain' parameter (larger values make the region narrower)
HF Damp	16-15000 Hz, BYPASS	Frequency at which the high-frequency content of the resonant sound will be cut (BYPASS: no cut)
LF Damp	BYPASS, 16-15000 Hz	Frequency at which the low-frequency content of the resonant sound will be cut (BYPASS: no cut)
Lid	1-6	This simulates the actual changes in sound that occur when the lid of a grand piano is set at different heights.
EQ Low Freq	200, 400 Hz	Frequency of the low-range EQ
EQ Low Gain	-15--+15 dB	Amount of low-range boost/cut
EQ Mid Freq	200-8000 Hz	Frequency of the midrange EQ
EQ Mid Gain	-15--+15 dB	Amount of midrange boost/cut
EQ Mid Q	0.5, 1.0, 2.0, 4.0, 8.0	Width of midrange (larger values make the region narrower)
EQ High Freq	2000, 4000, 8000 Hz	Frequency of the high-range EQ
EQ High Gain	-15--+15 dB	Amount of high-range boost/cut
Level	0-127	Output Level

**79: VOCODER**

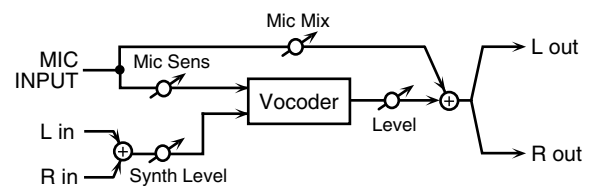

Parameter	Value	Explanation
Mic Sens #	0-127	Input sensitivity of the mic
Synth Level #	0-127	Input level of the instrument
Mic Mix #	0-127	Amount of mic audio added to the output of the vocoder
Level	0-127	Volume level after passing through the vocoder

## Effects List

### Chorus Parameters

The JUNO-STAGE's Chorus effect unit can also be used as a stereo delay unit.

These settings allow you to select chorus or delay, and the characteristics of the selected effect type.

Parameter	Value	Explanation
<b>Chorus Type</b>	00 (OFF), 01 (CHORUS), 02 (DELAY), 03 (GM2 CHORUS)	Selects either Chorus or Delay. 00 (OFF): Neither Chorus or Delay is used. 01 (CHORUS): Chorus is used. 02 (DELAY): Delay is used. 03 (GM2 CHORUS): GM2 Chorus is used.
<b>Chorus Level</b>	0–127	Volume of the chorus sound
<b>01: CHORUS</b>		
<b>Filter Type</b>	OFF, LPF, HPF	Type of filter <b>OFF:</b> no filter is used <b>LPF:</b> cuts the frequency range above the Cutoff Freq <b>HPF:</b> cuts the frequency range below the Cutoff Freq
<b>Cutoff Freq</b>	200–8000 Hz	Basic frequency of the filter
<b>Pre Delay</b>	0.0–100 msec	Adjusts the delay time from the direct sound until the chorus sound is heard.
<b>Rate</b>	0.05–10.00 Hz, note	Frequency of modulation
<b>Depth</b>	0–127	Depth of modulation
<b>Phase</b>	0–180 deg	Spatial spread of the sound
<b>Feedback</b>	0–127	Adjusts the amount of the chorus sound that is fed back into the effect.
<b>02: DELAY</b>		
<b>Delay Left</b>	0–1000 msec, note	Adjusts the delay time from the direct sound until the delay sound is heard.
<b>Delay Right</b>		
<b>Delay Center</b>		
<b>Center Feedback</b>	-98–+98%	Adjusts the proportion of the delay sound that is fed back into the effect. Negative (-) settings will invert the phase.
<b>HF Damp</b>	200–8000 Hz, BYPASS	Adjusts the frequency above which sound fed back to the effect will be cut. If you do not want to cut the high frequencies, set this parameter to BYPASS.
<b>Left Level</b>	0–127	Volume of each delay sound
<b>Right Level</b>		
<b>Center Level</b>		
<b>03: GM2 CHORUS</b>		
<b>Pre-LPF</b>	0–7	Cuts the high frequency range of the sound coming into the chorus. Higher values will cut more of the high frequencies.
<b>Level</b>	0–127	Volume of the chorus sound
<b>Feedback</b>	0–127	Adjusts the amount of the chorus sound that is fed back into the effect.
<b>Delay</b>	0–127	Adjusts the delay time from the direct sound until the chorus sound is heard.
<b>Rate</b>	0–127	Frequency of modulation
<b>Depth</b>	0–127	Depth of modulation
<b>Send Level to Reverb</b>	0–127	Adjusts the amount of chorus sound that will be sent to the reverb.

#### NOTE

If you specify the delay time as a note value, slowing down the tempo will not change the delay time beyond a certain length. This is because there is an upper limit for the delay time; if the delay time is specified as a note value and you slow down the tempo until this upper limit is reached, the delay time cannot change any further. This upper limit is the maximum value that can be specified when setting the delay time as a numerical value.

#### note:

	Sixty-fourth-note triplet		Sixty-fourth note		Thirty-second-note triplet
	Thirty-second note		Sixteenth-note triplet		Dotted thirty-second note
	Sixteenth note		Eighth-note triplet		Dotted sixteenth note
	Eighth note		Quarter-note triplet		Dotted eighth note
	Quarter note		Half-note triplet		Dotted quarter note
	Half note		Whole-note triplet		Dotted half note
	Whole note		Double-note triplet		Dotted whole note
	Double note				

## Reverb Parameters

These settings allow you to select the desired type of reverb, and its characteristics.

Parameter	Value	Explanation
<b>Reverb Type</b>	00 (OFF), 01 (REVERB), 02 (SRV ROOM), 03 (SRV HALL), 04 (SRV PLATE), 05 (GM2 REVERB)	Type of reverb 00 (OFF): Reverb is not used. 01 (REVERB): Normal reverb 02 (SRV ROOM): This simulates typical room acoustic reflections. 03 (SRV HALL): This simulates typical concert hall acoustic reflections. 04 (SRV PLATE): This simulates a reverb plate, a popular type of artificial reverb unit that derives its sound from the vibration of a metallic plate. 05 (GM2 REVERB): GM2 Reverb
<b>Reverb Level</b>	0–127	Volume of the reverb sound
<b>01: REVERB</b>		
<b>Type</b>	ROOM1, ROOM2, STAGE1, STAGE2, HALL1, HALL2, DELAY, PAN-DELAY	Type of reverb/delay <b>ROOM1:</b> short reverb with high density <b>ROOM2:</b> short reverb with low density <b>STAGE1:</b> reverb with greater late reverberation <b>STAGE2:</b> reverb with strong early reflections <b>HALL1:</b> very clear-sounding reverb <b>HALL2:</b> rich reverb <b>DELAY:</b> conventional delay effect <b>PAN-DELAY:</b> delay effect with echoes that pan left and right
<b>Time</b>	0–127	Time length of reverberation (Type: ROOM1–HALL2) Delay time (Type: DELAY, PAN-DELAY)
<b>HF Damp</b>	200–8000 Hz, BYPASS	Adjusts the frequency above which the high-frequency content of the reverb sound will be cut, or “damped.” If you do not want to cut the high frequencies, set this parameter to BYPASS.
<b>Delay Feedback</b>	0–127	Adjusts the amount of delay feedback when the Type setting is DELAY or PAN-DELAY. Amount of delay sound returned to the input (this setting is valid only if Type is DELAY or PAN-DELAY)
<b>02: SRV ROOM 03: SRV HALL 04: SRV PLATE</b>		
<b>Pre Delay</b>	0.0–100 msec	Adjusts the delay time from the direct sound until the reverb sound is heard.
<b>Time</b>	0–127	Time length of reverberation
<b>Size</b>	1–8	Size of the simulated room or hall
<b>High Cut</b>	160–12500 Hz, BYPASS	Adjusts the frequency above which the high-frequency content of the reverb will be reduced. If you do not want to reduce the high frequencies, set this parameter to BYPASS.
<b>Density</b>	0–127	Density of reverb
<b>Diffusion</b>	0–127	Adjusts the change in the density of the reverb over time. The higher the value, the more the density increases with time. (The effect of this setting is most pronounced with long reverb times.)
<b>LF Damp Freq</b>	50–4000 Hz	Adjusts the frequency below which the low-frequency content of the reverb sound will be reduced, or “damped.”
<b>LF Damp Gain</b>	-36–0 dB	Adjusts the amount of damping applied to the frequency range selected with LF Damp. With a setting of “0,” there will be no reduction of the reverb’s low-frequency content.
<b>HF Damp Freq</b>	4000–12500 Hz	Adjusts the frequency above which the high-frequency content of the reverb sound will be reduced, or “damped.”
<b>HF Damp Gain</b>	-36–0 dB	Adjusts the amount of damping applied to the frequency range selected with HF Damp. With a setting of “0,” there will be no reduction of the reverb’s high-frequency content.

Parameter	Value	Explanation
<b>05: GM2 REVERB</b>		
<b>Character</b>	0–7	Type of reverb 0–5: reverb 6, 7: delay
<b>Pre-LPF</b>	0–7	Cuts the high frequency range of the sound coming into the reverb. Higher values will cut more of the high frequencies.
<b>Level</b>	0–127	Output level of reverberation
<b>Time</b>	0–127	Time length of reverberation
<b>Delay Feedback</b>	0–127	Adjusts the amount of the delay sound that is fed back into the effect when the Character setting is 6 or 7.

# Performance List

## USER (User Group)

No	Name	No	Name
1	Piano / Bass	33	GM2 Template
2	Jazz n' Rhtm	34	SuperRichPNO
3	RollTheRock	35	Bs/Piano
4	Symphonique	36	Brite Piano
5	Back 2 Juno	37	CrystalGrand
6	TinyBee / Bs	38	SuperPhaseEP
7	Funky Stage	39	D50 Memories
8	Eden Gardens	40	RockOrg
9	Concerto Pno	41	Delicate
10	Stage Brass	42	SuperStrings
11	Notre-Dame	43	Braves
12	Dual Rotary	44	Orchestral
13	Silky Analog	45	Sonic
14	Leading D/A	46	Pole
15	Now Friends	47	Twilight
16	Airy Wurly	48	3AM
17	London Stage	49	Ocean
18	Vinstage Pno	50	Jupiters
19	Only Roland	51	Blizzard
20	Vienna 1781	52	Horizon
21	The Leader	53	Buzz
22	Rotary / Bs	54	80s
23	EP / Rotary	55	TripTo80s
24	EP / Bass	56	80s Stack
25	Piano / Brs	57	AutoNoise
26	Dreaming Pno	58	World Lead
27	HypnoRhythm	59	XyloSawLead
28	Dual D-50	60	WoodyFltLd
29	New Age	61	Saturn
30	VOCODER+Bass	62	Tale
31	VOCODER+Orgn	63	Synchronize
32	VOCODER+Pad	64	Gramophone

## PRST (Preset Group)

No	Name	No	Name
1	Piano / Bass	33	GM2 Template
2	Jazz n' Rhtm	34	SuperRichPNO
3	RollTheRock	35	Bs/Piano
4	Symphonique	36	Brite Piano
5	Back 2 Juno	37	CrystalGrand
6	TinyBee / Bs	38	SuperPhaseEP
7	Funky Stage	39	D50 Memories
8	Eden Gardens	40	RockOrg
9	Concerto Pno	41	Delicate
10	Stage Brass	42	SuperStrings
11	Notre-Dame	43	Braves
12	Dual Rotary	44	Orchestral
13	Silky Analog	45	Sonic
14	Leading D/A	46	Pole
15	Now Friends	47	Twilight
16	Airy Wurly	48	3AM
17	London Stage	49	Ocean
18	Vinstage Pno	50	Jupiters
19	Only Roland	51	Blizzard
20	Vienna 1781	52	Horizon
21	The Leader	53	Buzz
22	Rotary / Bs	54	80s
23	EP / Rotary	55	TripTo80s
24	EP / Bass	56	80s Stack
25	Piano / Brs	57	AutoNoise
26	Dreaming Pno	58	World Lead
27	HypnoRhythm	59	XyloSawLead
28	Dual D-50	60	WoodyFltLd
29	New Age	61	Saturn
30	VOCODER+Bass	62	Tale
31	VOCODER+Orgn	63	Synchronize
32	VOCODER+Pad	64	Gramophone

# Patch List

## USER (User Group)

User 1-128 (CC#0 = 87, CC#32 = 0), User129-256 (CC#0 = 87, CC#32 = 1)

No	Name	Voice	Category
001	88StageGrand	2	AC.Piano
002	Juno-Grand	4	AC.Piano
003	JD-800 Piano	1	AC.Piano
004	Stage Phaser	2	EL.Piano
005	Lounge Kit	2	Combination
006	Trem Wuly	1	EL.Piano
007	FM-777	5	EL.Piano
008	SA EPiano	3	EL.Piano
009	HardRockORG1	4	Organ
010	Rocky Organ	2	Organ
011	FullStop Org	3	Organ
012	R&B Organ 2	4	Organ
013	X Perc Organ	3	Organ
014	Smoky Organ	1	Organ
015	Crummy Organ	2	Organ
016	Chapel Organ	2	Organ
017	Mid Pipe Org	4	Organ
018	VntgClav	3	Keyboards
019	Phase Clavi	2	Keyboards
020	Funky Line	2	Keyboards
021	Harpsy Clavi	2	Keyboards
022	Strings	8	Strings
023	String Ens	3	Strings
024	Wind & Str 1	7	Orchestra
025	Soft Orch 2	7	Orchestra
026	Hollow	4	Soft Pad
027	Heaven Pad	3	Soft Pad
028	Soft OB Pad	3	Soft Pad
029	Reso Pad	3	Soft Pad
030	Slow Saw Str	2	Soft Pad
031	JP Strings 2	5	Soft Pad
032	Comb	3	Bright Pad
033	Super SynStr	2	Bright Pad
034	80s Str	8	Bright Pad
035	Polar Night	4	Bright Pad
036	Distant Sun	4	Bright Pad
037	BrtBrass	4	AC.Brass
038	Horny Sax	2	Sax
039	80s Brass 1	6	Synth Brass
040	Juno-106 Brs	1	Synth Brass
041	Poly Brass	2	Synth Brass
042	JP8000 Brass	6	Synth Brass
043	Brass	4	Synth Brass
044	SuperSawSlow	2	Other Synth
045	Trance	3	Other Synth
046	Trancy Synth	2	Other Synth
047	Stacc Heaven	4	Other Synth
048	Sugar Synth	5	Other Synth
049	Himalaya Ice	2	Bell
050	Wine Glass	4	Bell
051	Synergy MLT	2	Mallet
052	AirPluck	4	Mallet
053	Marimba	1	Mallet
054	Cmp'd Fng Bs	3	Bass
055	FingerMaster	2	Bass
056	Return2Base!	1	Bass
057	Chicken Bass	3	Bass
058	Fretnot 1	2	Bass
059	Got Pop?	1	Bass
060	Ac Bass	1	Bass
061	Low Bass	3	Synth Bass
062	Foundation	2	Synth Bass
063	Fat RubberBs	3	Synth Bass
064	Punch MG 2	2	Synth Bass
065	GarageBs2	2	Synth Bass
066	Acid Bs	2	Synth Bass
067	Loco Voco	2	Synth Bass
068	VirtualHuman	4	Pulsating
069	Strobot	2	Pulsating
070	Strobe	4	Pulsating

No	Name	Voice	Category
071	HPF Slicer	3	Pulsating
072	Choir Aahs 1	4	Vox
073	Choir Aahs 2	4	Vox
074	Angels Choir	4	Vox
075	Syn Opera	4	Vox
076	Choir&Str	7	Vox
077	Terra Nostra	8	Soft Pad
078	Aah Vox	2	Vox
079	SquLead	4	Soft Lead
080	Howards Lead	3	Soft Lead
081	Windy Synth	3	Soft Lead
082	Sinetic	2	Soft Lead
083	SoloNzPeaker	1	Soft Lead
084	Juno SftLd	1	Soft Lead
085	R&B TriLead	1	Soft Lead
086	X-Pulse Lead	2	Soft Lead
087	Theramax	1	Soft Lead
088	GR Lead	2	Soft Lead
089	Chubby Lead	2	Soft Lead
090	Shaku Lead	5	Soft Lead
091	Porta SoloLd	2	Hard Lead
092	Wind Syn Ld	2	Hard Lead
093	Follow Me	2	Hard Lead
094	Saw Ld 1	2	Hard Lead
095	Sync Ld Mono	1	Hard Lead
096	Brt Nylon	1	AC.Guitar
097	So good !	2	AC.Guitar
098	12str Gtr	3	AC.Guitar
099	Jazz Guitar	1	EL Guitar
100	Strat Gtr	1	EL Guitar
101	Trem-o-Vibe	2	Dist.Guitar
102	Searing COSM	2	Dist.Guitar
103	Larsen /Aft	2	Dist.Guitar
104	Loud Gtr	3	Dist.Guitar
105	Sitar on C	6	Plucked
106	Pat is away	5	Plucked
107	Bosporus	3	Plucked
108	Aerial Harp	2	Plucked
109	Nice Kalimba	1	Plucked
110	Flute	2	Flute
111	Andes Mood	1	Flute
112	LongDistance	1	Ethnic
113	Ambi Shaku	3	Ethnic
114	Soprano Sax	1	Sax
115	Solo AltoSax	1	Sax
116	XP TrnBreathy	1	Sax
117	Good Old Day	3	Wind
118	BluesHrp V/S	1	Harmonica
119	Squeeze Me!	4	Accordion
120	Solo Tp	2	AC.Brass
121	Violin 1	1	Strings
122	Cello 1	1	Strings
123	Juno-D Maj7	4	Techno Synth
124	Sweet House	4	Techno Synth
125	ElectroDisco	5	Beat&Groove
126	Groove 007	4	Beat&Groove
127	Autotrance	4	Beat&Groove
128	CompuSonic 2	4	Beat&Groove
129	Passing by	4	Synth FX
130	Rich Grand	2	AC.Piano
131	GermanGrand	2	AC.Piano
132	Oil Can Bass	3	Synth Bass
133	Pedal SynBs	2	Synth Bass
134	Big Mini 1	3	Synth Bass
135	Big Mini 2	2	Synth Bass
136	SH-2 Bs	2	Synth Bass
137	SH-101 Bs	2	Synth Bass
138	R&B Bass 5	3	Synth Bass
139	R&B Bass 6	1	Synth Bass
140	R&B Bass 7	3	Synth Bass

No	Name	Voice	Category
141	Moogy Bass 1	2	Synth Bass
142	Moogy Bass 2	2	Synth Bass
143	Juno Reso	2	Synth Bass
144	Alpha SBass1	2	Synth Bass
145	Alpha SBass2	2	Synth Bass
146	SH Square	2	Synth Bass
147	SH Sawtooth	2	Synth Bass
148	Pedal Square	2	Synth Bass
149	Doze Bass	1	Synth Bass
150	Virtual RnBs	2	Synth Bass
151	Saw&MG Bass	4	Synth Bass
152	SquareBs 1	2	Synth Bass
153	Sine Lead	1	Soft Lead
154	Pure Sin Ld	1	Soft Lead
155	PureLD Tri	3	Soft Lead
156	Sqr Lead 1	2	Soft Lead
157	Squ Pipe	4	Soft Lead
158	Pure SquLd 1	1	Soft Lead
159	Pure SquLd 2	2	Soft Lead
160	MG Squ Ld 1	2	Soft Lead
161	MG Squ Ld 2	2	Soft Lead
162	MG Squ Ld 3	1	Soft Lead
163	MG Squ Ld 4	2	Soft Lead
164	Reso G	1	Soft Lead
165	Mew Lead	1	Soft Lead
166	Pulstar G	2	Soft Lead
167	MG Saw Ld 1	2	Soft Lead
168	MG Saw Ld 2	4	Soft Lead
169	Vint SawLead	2	Soft Lead
170	Shy Saw Lead	1	Soft Lead
171	Mid Saw Ld 1	2	Soft Lead
172	Mid Saw Ld 2	2	Soft Lead
173	Mid Saw Ld 3	1	Soft Lead
174	Mid Saw Ld 4	4	Soft Lead
175	Mid Saw Ld 5	1	Soft Lead
176	Mid Saw Key	2	Soft Lead
177	ResoSaw Lead	2	Soft Lead
178	ResoAmp Ld	2	Soft Lead
179	Jucy Saw	3	Soft Lead
180	Juno SftLead	1	Soft Lead
181	R&B Tri Ld 1	1	Soft Lead
182	R&B Tri Ld 2	1	Soft Lead
183	Weather Ld 1	2	Soft Lead
184	Weather Ld 2	2	Soft Lead
185	Weather Pad	4	Soft Lead
186	Weather Ld 3	2	Soft Lead
187	Shy Soloist	1	Soft Lead
188	SoffLead	2	Soft Lead
189	CompSaw Ld	2	Soft Lead
190	OB Lead 1	2	Soft Lead
191	OB Lead 2	2	Soft Lead
192	BellSawLead1	3	Soft Lead
193	BellSawLead2	4	Soft Lead
194	Brusky Ld	3	Soft Lead
195	Mod Lead	4	Soft Lead
196	Polysine	2	Soft Lead
197	Wally Ld	3	Soft Lead
198	Belly Ld	3	Soft Lead
199	Castle Ld 1	2	Soft Lead
200	Castle Ld 2	2	Soft Lead
201	CompSqu Ld	2	Soft Lead
202	Digi Vox Ld	3	Soft Lead
203	Digi Lead	3	Soft Lead
204	Velo Voicez	2	Bright Pad
205	Jet Pad	8	Bright Pad
206	Space Pad	4	Bright Pad
207	Glossy Pad	4	Bright Pad
208	Magic Sines	4	Soft Pad
209	PAD	3	Soft Pad

User 210-256: "INIT PATCH"

# Patch List

## PRST (Preset Group)

Preset 001-128 (CC#0= 87, CC#32 =64 PC=1-128), Preset 129-256 (CC#0= 87, CC#32 =65 PC=1-128)

No	Name	Voice	Category	No	Name	Voice	Category	No	Name	Voice	Category	No	Name	Voice	Category
001	88StageGrand	2	AC.Piano	065	FM EP mix	6	EL.Piano	129	SuperDistORG	4	Organ	193	Punker 2	2	Dist.Guitar
002	Juno-Grand	4	AC.Piano	066	FM-777	5	EL.Piano	130	SuperDistLd2	4	Organ	194	Larsen /Aft	2	Dist.Guitar
003	ConcrtPno	2	AC.Piano	067	FM EPad	3	EL.Piano	131	FullDraw Org	3	Organ	195	Rockin' Dly	3	Dist.Guitar
004	GermanGrand	2	AC.Piano	068	EP Stack	4	EL.Piano	132	StakDraw Org	4	Organ	196	Ac Bass	1	Bass
005	Rich Grand	2	AC.Piano	069	EP Belle 1	3	EL.Piano	133	FullStop Org	3	Organ	197	Ulli Ac Bass	2	Bass
006	So true...	2	AC.Piano	070	80s EP	4	EL.Piano	134	Perc Org	4	Organ	198	Downright Bs	3	Bass
007	ConcertPiano	3	AC.Piano	071	SA EPiano	3	EL.Piano	135	VKHold4Speed	4	Organ	199	Cmp'd Fng Bs	3	Bass
008	Warm Piano	2	AC.Piano	072	BrillClav DB	2	Keyboards	136	X Perc Organ	3	Organ	200	Fing Bs	3	Bass
009	ConcertGrand	2	AC.Piano	073	Clav	1	Keyboards	137	Rocky Organ	2	Organ	201	Ultimo Bass	2	Bass
010	Hall Concert	2	AC.Piano	074	VntgClav	3	Keyboards	138	Euro Organ	2	Organ	202	Roomy Bass	2	Bass
011	Bright Tune	2	AC.Piano	075	Cutter Clavi	2	Keyboards	139	Rhythm'n'B	4	Organ	203	FingerMaster	2	Bass
012	Mellow Tune	2	AC.Piano	076	Funky D	2	Keyboards	140	Phono Organ	2	Organ	204	All Round Bs	2	Bass
013	Studio Grand	2	AC.Piano	077	Phase Clavi	2	Keyboards	141	LaFi PercOrg	1	Organ	205	R&B Bs/Slide	2	Bass
014	First Choice	2	AC.Piano	078	BPF Clavi Ph	2	Keyboards	142	Rochno Org	4	Organ	206	Pick Bs	3	Bass
015	Rokkin' pF	2	AC.Piano	079	Pulse Clavi	2	Keyboards	143	R&B Organ 1	2	Organ	207	Thumb Up!	1	Bass
016	Dark Grand	4	AC.Piano	080	PWM Clav	1	Keyboards	144	R&B Organ 2	4	Organ	208	Tubby Mute	2	Bass
017	Grand+Pad	4	AC.Piano	081	Funky Line	2	Keyboards	145	Dist Bee	1	Organ	209	Chicken Bass	3	Bass
018	Warm Pad Pno	4	AC.Piano	082	Biting Clav	2	Keyboards	146	60's Org 1	2	Organ	210	Snug Bass	2	Bass
019	Grand+Vox	4	AC.Piano	083	Analog Clavi	1	Keyboards	147	60's Org 2	2	Organ	211	Return2Basel	1	Bass
020	Cicada Piano	4	AC.Piano	084	Reso Clavi	2	Keyboards	148	Smoky Organ	1	Organ	212	Chorus Bass	2	Bass
021	X Piano +Str	4	AC.Piano	085	Snappy Clav	2	Keyboards	149	SoapOpera	1	Organ	213	A Big Pick	3	Bass
022	Warm Str Pno	6	AC.Piano	086	Over-D6	3	Keyboards	150	Crummy Organ	2	Organ	214	Basement	1	Bass
023	Grand Hall	5	AC.Piano	087	Harps Clavi	2	Keyboards	151	Chapel Organ	2	Organ	215	Fretnot 1	2	Bass
024	Rapsody	7	AC.Piano	088	Harpsi	4	Keyboards	152	Grand Pipe	3	Organ	216	Fretnot 2	3	Bass
025	JD-800 Piano	1	AC.Piano	089	Amadeus	8	Keyboards	153	Pipe Org/Mod	6	Organ	217	RichFretless	2	Bass
026	SA Dance Pno	2	AC.Piano	090	Celesta	1	Keyboards	154	Masked Opera	6	Organ	218	NewAge Frtls	3	Bass
027	E-Grand	4	AC.Piano	091	Himalaya Ice	2	Bell	155	Mid Pipe Org	4	Organ	219	SlapBass1	1	Bass
028	Back E-Grand	2	AC.Piano	092	FM Syn Bell	4	Bell	156	VodkaKordion	3	Accordion	220	Slap2 w/Fx	1	Bass
029	Grand+FM	4	AC.Piano	093	D-50 Fantsia	3	Bell	157	Squeeze Mel	4	Accordion	221	Got Pop?	1	Bass
030	Blend Pno	5	AC.Piano	094	Wine Glass	4	Bell	158	Guinguette	3	Accordion	222	JBass v/Thmb	2	Bass
031	Piano Oz	4	AC.Piano	095	MuBox Pad	4	Bell	159	HarWonderca	2	Harmonica	223	Slap Bass	2	Bass
032	FX Piano	4	AC.Piano	096	Bell 1	4	Bell	160	BluesHrp V/S	1	Harmonica	224	X Slap Bass	3	Bass
033	AmbientPiano	4	AC.Piano	097	FM Heaven	4	Bell	161	Green Bullet	2	Harmonica	225	Low Bass	3	Synth Bass
034	Pure EP	1	EL.Piano	098	Juno Glocken	1	Bell	162	Brit Nylon	1	AC.Guitar	226	Mini Like!	2	Synth Bass
035	Trem EP	1	EL.Piano	099	Music Bells	2	Bell	163	SoftNylN Gtr	2	AC.Guitar	227	MC-404 Bass	2	Synth Bass
036	Phase EP	1	EL.Piano	100	Musicbox	1	Bell	164	Nylon Gt	2	AC.Guitar	228	Fat RubberBs	3	Synth Bass
037	PhaseEPlayer	3	EL.Piano	101	Music Box 2	2	Bell	165	Wet NylN Gtr	3	AC.Guitar	229	SH-101 Bs 1	2	Synth Bass
038	E.Piano	5	EL.Piano	102	Kalimbells	2	Bell	166	Pre Mass Hum	4	AC.Guitar	230	Syn Bass1	3	Synth Bass
039	StageEP Trem	2	EL.Piano	103	Step Ice	4	Bell	167	Thick Steel	2	AC.Guitar	231	Juno-106 Bs	2	Synth Bass
040	Back2the60s	2	EL.Piano	104	Bell 2	2	Bell	168	Uncle Martin	2	AC.Guitar	232	Smooth Bass	2	Synth Bass
041	Stage EP	4	EL.Piano	105	Candy Bell	2	Bell	169	Wide Ac Gtr	4	AC.Guitar	233	Flat Bs	3	Synth Bass
042	Stage Phazer	2	EL.Piano	106	Chime	1	Bell	170	Comp Stil Gtr	2	AC.Guitar	234	Foundation	2	Synth Bass
043	StageCabinet	2	EL.Piano	107	Bell Ring	4	Bell	171	Stl Gtr Duo	2	AC.Guitar	235	Punch MG 2	2	Synth Bass
044	Tine EP	1	EL.Piano	108	Tubular Bell	1	Bell	172	12str Gtr	3	AC.Guitar	236	Electro Rubb	2	Synth Bass
045	LEO EP	4	EL.Piano	109	5th Key	2	Bell	173	So good !	2	AC.Guitar	237	R&B Bass 1	2	Synth Bass
046	LonesomeRoad	2	EL.Piano	110	Bell Monitor	2	Bell	174	StratSeq'nce	3	EL.Guitar	238	Enorjizor	2	Synth Bass
047	Age'nTines	2	EL.Piano	111	TubyRuesday	2	Bell	175	Jazz Guitar	1	EL.Guitar	239	LowFat Bass	3	Synth Bass
048	Brill TremEP	2	EL.Piano	112	Vibrations	2	Mallet	176	DynoJazz Gtr	1	EL.Guitar	240	Doze Bass	1	Synth Bass
049	Crystal EP	2	EL.Piano	113	Vibe	1	Mallet	177	Clean Gtr	1	EL.Guitar	241	DCO Bass	4	Synth Bass
050	Vintage Tine	1	EL.Piano	114	Ringy Vibes	2	Mallet	178	Crimson Gtr	2	EL.Guitar	242	Virtual RnBs	2	Synth Bass
051	Celestial EP	4	EL.Piano	115	Airie Vibez	4	Mallet	179	Plug n' Gig	1	EL.Guitar	243	Saw&MG Bass	4	Synth Bass
052	Psycho EP	4	EL.Piano	116	Marimba	1	Mallet	180	Kinda Kurt	2	EL.Guitar	244	MG+SubOsc Bs	2	Synth Bass
053	Mk2 phsr	3	EL.Piano	117	FM Wood	4	Mallet	181	Nice Oct Gtr	2	EL.Guitar	245	R&B Bass 2	1	Synth Bass
054	Dreaming EP	4	EL.Piano	118	Xylo	1	Mallet	182	Strat Gtr	1	EL.Guitar	246	R&B Bass 3	2	Synth Bass
055	Balladeer	3	EL.Piano	119	Ethno Keys	2	Mallet	183	Touch Drive	1	Dist.Guitar	247	Not a Bass	2	Synth Bass
056	Remember	2	EL.Piano	120	Synergy MLT	2	Mallet	184	Chunk	4	Dist.Guitar	248	ResoSyn Bs 1	2	Synth Bass
057	Vibe EP	1	EL.Piano	121	Icy Keys	4	Mallet	185	Trem-o-Vibe	2	Dist.Guitar	249	SH-1 Bass	2	Synth Bass
058	sin(EP)	2	EL.Piano	122	Steel Drums	2	Mallet	186	LP Dist	2	Dist.Guitar	250	SH-101 Bs 2	2	Synth Bass
059	Pure Wuly	1	EL.Piano	123	50' SteelDrms	4	Mallet	187	Hurling Gtr	3	Dist.Guitar	251	Punch MG 1	2	Synth Bass
060	Trem Wuly	1	EL.Piano	124	Xylosizer	2	Mallet	188	Searing COSM	2	Dist.Guitar	252	MKS-50 SynBs	1	Synth Bass
061	Super Wurly	3	EL.Piano	125	Toy Box	3	Mallet	189	Loud Gtr	3	Dist.Guitar	253	Gashed Bass	2	Synth Bass
062	Wurly Trem	3	EL.Piano	126	AirPluck	4	Mallet	190	Plugged!!	1	Dist.Guitar	254	Q Bass	3	Synth Bass
063	VelSpdWurly	2	EL.Piano	127	HardRockORG1	4	Organ	191	Punker 1	2	Dist.Guitar	255	Super-G DX	3	Synth Bass
064	Fonky Fonky	2	EL.Piano	128	HardRockORG2	5	Organ	192	PowerChd	2	Dist.Guitar	256	Kickin' Bass	2	Synth Bass

Preset 257-384 (CC#0= 87, CC#32 =66 PC=1-128), Preset 385-512 (CC#0= 87, CC#32 =67 PC=1-128)

No	Name	Voice	Category	No	Name	Voice	Category	No	Name	Voice	Category	No	Name	Voice	Category
257	OilDrum Bass	3	Synth Bass	321	Biggie Bows	6	Strings	385	Simple Tutti	2	AC.Brass	449	X-Sink Delay	3	Hard Lead
258	Dust Bass	4	Synth Bass	322	Staccato VS	4	Strings	386	F.Horns Sect	3	AC.Brass	450	Destroyed Ld	2	Hard Lead
259	Glide-iator	2	Synth Bass	323	So Staccato	4	Strings	387	Full sForza	4	AC.Brass	451	Synchro Lead	2	Hard Lead
260	AcidPunch	2	Synth Bass	324	DelicatePizz	4	Strings	388	Stereo Brass	4	AC.Brass	452	Sync Ld Mono	1	Hard Lead
261	TBasic	1	Synth Bass	325	Vls PizzHall	8	Strings	389	Wide SynBrss	2	Synth Brass	453	SyncModulate	3	Hard Lead
262	Unison Bs	2	Synth Bass	326	Orch Pizz	4	Strings	390	DetuneSawBrs	2	Synth Brass	454	Distorted MG	1	Hard Lead
263	Detune Bass	2	Synth Bass	327	Pizz'Stac VS	6	Strings	391	J-Pop Brass	6	Synth Brass	455	Vampire	2	Hard Lead
264	Lo Bass	3	Synth Bass	328	Mellow Tron	3	Strings	392	80s Brass 1	6	Synth Brass	456	Blue Meanie	2	Hard Lead
265	GarageBs1	3	Synth Bass	329	Tronic Str	2	Strings	393	80s Brass 2	4	Synth Brass	457	Juno Dist Ld	2	Hard Lead
266	GarageBs2	2	Synth Bass	330	Tape Memory	2	Strings	394	Ana Brass	5	Synth Brass	458	Ringmod Lead	4	Hard Lead
267	Sub Sonic	4	Synth Bass	331	Wind & Str 1	7	Orchestra	395	Soft Brass	3	Synth Brass	459	Stimulation	4	Hard Lead
268	Jungle Bs	2	Synth Bass	332	Wind & Str 2	5	Orchestra	396	JP8000 Brass	6	Synth Brass	460	BodyElectric	3	Hard Lead
269	R&B Bass 4	1	Synth Bass	333	Farewell	6	Orchestra	397	Brass	4	Synth Brass	461	Classic Lead	4	Hard Lead
270	Simply Basic	2	Synth Bass	334	Orch & Horns	5	Orchestra	398	Syn Brass	4	Synth Brass	462	Feat Lead	2	Hard Lead
271	Beepin Bass	2	Synth Bass	335	Soft Orch 1	4	Orchestra	399	Syn Brass 2	4	Synth Brass	463	Wire Sync	3	Hard Lead
272	MC-TB Bass	2	Synth Bass	336	Soft Orch 2	7	Orchestra	400	Xpand Brass	2	Synth Brass	464	Epic Lead	2	Hard Lead
273	Acdbg Bass	2	Synth Bass	337	Henry IX	4	Orchestra	401	Xpand Brass2	4	Synth Brass	465	Bag Lead	3	Hard Lead
274	Loco Voco	2	Synth Bass	338	Ending Scene	4	Orchestra	402	Super Saw	4	Synth Brass	466	Wezcoast	2	Hard Lead
275	Unplug it!	1	Synth Bass	339	Symphonika	8	Orchestra	403	SoftSynBrass	2	Synth Brass	467	HyperJupiter	3	Hard Lead
276	S&H Bass	2	Synth Bass	340	Mix Hit 2	4	Hit&Stab	404	Silky JP	2	Synth Brass	468	Vintagolizer	4	Hard Lead
277	Destroyed Bs	2	Synth Bass	341	Cheezy Movie	4	Hit&Stab	405	Silk Brs Pad	1	Synth Brass	469	C64 Lead	2	Hard Lead
278	Acid Bs	2	Synth Bass	342	Philly Hit	1	Hit&Stab	406	80s Brass 3	8	Synth Brass	470	303 NRG	2	Hard Lead
279	Lo-Fi TB	1	Synth Bass	343	Smear Hit 1	2	Hit&Stab	407	X-Saw Brass1	2	Synth Brass	471	SqLead	4	Soft Lead
280	Drop Bass	3	Synth Bass	344	Smear Hit 2	2	Hit&Stab	408	Cheesy Brass	4	Synth Brass	472	Sqr Lead	2	Soft Lead
281	Big Mini	3	Synth Bass	345	Good Old Hit	4	Hit&Stab	409	Dual Saw Brs	2	Synth Brass	473	SH Sqr Lead	2	Soft Lead
282	Muffled MG	2	Synth Bass	346	Mix Hit 1	4	Hit&Stab	410	Juno-106 Brs	1	Synth Brass	474	Round SQR	2	Soft Lead
283	Intrusive Bs	2	Synth Bass	347	Lo-Fi Hit	4	Hit&Stab	411	Poly Brass	2	Synth Brass	475	Windy Synth	3	Soft Lead
284	Alpha SynBs	2	Synth Bass	348	2ble Action	2	Hit&Stab	412	Stacked Brs	4	Synth Brass	476	Sqr Diamond	2	Soft Lead
285	TransistorBs	3	Synth Bass	349	In da Cave	2	Hit&Stab	413	Soprano Sax	1	Sax	477	Sinetic	2	Soft Lead
286	Juno-60 Bass	2	Synth Bass	350	Housechord	3	Hit&Stab	414	Solo Sop Sax	1	Sax	478	PeakArpSine	1	Soft Lead
287	Storm Bass	4	Synth Bass	351	Mod Chord	2	Hit&Stab	415	Alto mp	1	Sax	479	Howards Lead	3	Soft Lead
288	Alpha ResoBs	2	Synth Bass	352	Dance Steam	2	Hit&Stab	416	Alto Sax	1	Sax	480	SoloNzPeaker	1	Soft Lead
289	SH-101 Vibe	4	Synth Bass	353	Good Old Day	3	Wind	417	Solo AltoSax	1	Sax	481	Juno SftLd	1	Soft Lead
290	Fazee Bass	4	Synth Bass	354	WindWood	3	Wind	418	AltoLead Sax	1	Sax	482	R&B TriLead	1	Soft Lead
291	Hi-Energy Bs	2	Synth Bass	355	Clarence.net	2	Wind	419	XP TrnBrethy	1	Sax	483	R&B Tri Ld2	1	Soft Lead
292	Violin 1	1	Strings	356	Oboe	1	Wind	420	Tenor Sax	2	Sax	484	Jupiter Lead	1	Soft Lead
293	Violin 2	1	Strings	357	Hall Oboe	1	Wind	421	Fat TenorSax	3	Sax	485	Dig-n-Duke	2	Soft Lead
294	Viola	3	Strings	358	English Horn	1	Wind	422	Baritone Sax	1	Sax	486	SoftLead	2	Soft Lead
295	Cello 1	1	Strings	359	Bassoon	1	Wind	423	Sax Sect. 1	3	Sax	487	Mid Saw Ld	4	Soft Lead
296	Cello 2	1	Strings	360	Flute	2	Flute	424	Sax Sect. 2	4	Sax	488	X-Pulse Lead	2	Soft Lead
297	Contrabass	4	Strings	361	Piccolo	2	Flute	425	Horny Sax	2	Sax	489	Mild 2-SawLd	2	Soft Lead
298	Dolce Qrt	2	Strings	362	Andes Mood	1	Flute	426	FXM Alto Sax	1	Sax	490	Mew Lead	1	Soft Lead
299	Chamber Str	3	Strings	363	HimalayaPipe	4	Flute	427	Porta Solold	2	Hard Lead	491	Shy Soloist	1	Soft Lead
300	Small Str	7	Strings	364	Solo Tp	2	AC.Brass	428	Porta Lead	2	Hard Lead	492	Theramax	1	Soft Lead
301	Marcato	2	Strings	365	Horn Chops	2	AC.Brass	429	Wind Syn Ld	2	Hard Lead	493	Therasqu	1	Soft Lead
302	Bright Str	2	Strings	366	Flugel Horn	1	AC.Brass	430	Saw Ld 1	2	Hard Lead	494	GR Lead	2	Soft Lead
303	String Ens	3	Strings	367	Spit Flugel	3	AC.Brass	431	Saw Ld 2	2	Hard Lead	495	SH-2 Lead	2	Soft Lead
304	Strings	8	Strings	368	Mute Tp /Mod	3	AC.Brass	432	Juno Lead	2	Hard Lead	496	ResoLead	3	Soft Lead
305	Stringz 101	2	Strings	369	Harmon Mute	1	AC.Brass	433	Follow Me	2	Hard Lead	497	Modulated Ld	1	Soft Lead
306	Crossed Bows	5	Strings	370	Soft Tb	2	AC.Brass	434	DC Triangle	2	Hard Lead	498	Synthi Fizz	2	Soft Lead
307	Warm Strings	5	Strings	371	Solo Tb	1	AC.Brass	435	Sqr-Sequence	1	Hard Lead	499	Waspy Lead	1	Soft Lead
308	Stacc mp Str	4	Strings	372	Solo Bone	2	AC.Brass	436	Pure Square	2	Hard Lead	500	Pulstar Ld	1	Soft Lead
309	Movie Scene	4	Strings	373	XP Horn	1	AC.Brass	437	Griggley	2	Hard Lead	501	Naked Lead	1	Soft Lead
310	Hybrid Str 1	6	Strings	374	Grande Tuba	2	AC.Brass	438	LegatoSaw	2	Hard Lead	502	Alpha Spit	1	Soft Lead
311	Gang Strangs	6	Strings	375	Tuba	1	AC.Brass	439	Lone Prophat	1	Hard Lead	503	Vliolin Lead	2	Soft Lead
312	Clustered!?!	8	Strings	376	StackTp Sect	4	AC.Brass	440	Dual Profs	2	Hard Lead	504	Mod Lead	4	Soft Lead
313	Full Strings	4	Strings	377	Tb Section	5	AC.Brass	441	Gwyo Press	2	Hard Lead	505	JP Saw Lead	2	Soft Lead
314	X StrSection	4	Strings	378	TpTb Sect.	2	AC.Brass	442	Q DualSaws	2	Hard Lead	506	Tristar	2	Soft Lead
315	Oct Strings	6	Strings	379	BrtBrass	4	AC.Brass	443	Mogulator Ld	2	Hard Lead	507	Chubby Lead	2	Soft Lead
316	Sahara Str	4	Strings	380	BrsSect 1	7	AC.Brass	444	DirtyVoltage	2	Hard Lead	508	Sneaky Leady	2	Soft Lead
317	Random Mood	6	Strings	381	BrsSect 2	8	AC.Brass	445	Clean?	2	Hard Lead	509	Shaku Lead	5	Soft Lead
318	X Hall Str	8	Strings	382	Tpts & Tmbs	2	AC.Brass	446	Distortion	4	Hard Lead	510	Legato Tkno	1	Soft Lead
319	Slow Str	8	Strings	383	Brass & Sax	5	AC.Brass	447	Syn Ld	2	Hard Lead	511	ResoSawLd	2	Soft Lead
320	Hybrid Str 2	7	Strings	384	BrassPartOut	6	AC.Brass	448	SynLead 0322	2	Hard Lead	512	SliCed Lead	2	Soft Lead

# Patch List

Preset 513-640 (CC#0= 87, CC#32 =68 PC=1-128), Preset 641-768 (CC#0= 87, CC#32 =69 PC=1-128)

No	Name	Voice	Category	No	Name	Voice	Category	No	Name	Voice	Category	No	Name	Voice	Category
513	Mini Growl	2	Soft Lead	577	Euro Teuro	6	Pulsating	641	ResoSweep Dn	1	Synth FX	705	Presssyn	2	Other Synth
514	Evangelized	2	Soft Lead	578	Auto Trance	2	Pulsating	642	Zap B3 & C4	1	Synth FX	706	High Five	2	Other Synth
515	Air Lead	4	Soft Lead	579	Eureggae	2	Pulsating	643	PolySweep Nz	4	Synth FX	707	4DaCommonMan	4	Other Synth
516	Juno-D Maj7	4	Techno Synth	580	Sorry4theDLY	2	Pulsating	644	Strange Land	6	Synth FX	708	Orgaenia	5	Other Synth
517	Sweet House	4	Techno Synth	581	Beat Pad	3	Pulsating	645	S&H Voc	2	Synth FX	709	Sleeper	4	Other Synth
518	Periscope	4	Techno Synth	582	TMT Seq Pad	4	Pulsating	646	12th Planet	2	Synth FX	710	Sugar Synth	5	Other Synth
519	5th Voice	6	Techno Synth	583	ForYourBreak	4	Pulsating	647	Scare	7	Synth FX	711	Ice Palace	4	Other Synth
520	HPF Sweep	2	Techno Synth	584	HPF Slicer	3	Pulsating	648	Hillside	1	Synth FX	712	Story Harp	7	Other Synth
521	BPF Saw	4	Techno Synth	585	Sliced Choir	6	Pulsating	649	Mod Scanner	2	Synth FX	713	LostParadise	5	Other Synth
522	Moon Synth	2	Techno Synth	586	Digi-Doo	2	Pulsating	650	SoundOnSound	1	Synth FX	714	Magnetic 5th	2	Other Synth
523	DelyResoSaws	2	Techno Synth	587	PanningFrmnt	2	Pulsating	651	Gasp	8	Synth FX	715	DigimaX	2	Other Synth
524	R-Trance	7	Techno Synth	588	Dirty Beat	7	Pulsating	652	ResoSweep Up	1	Synth FX	716	Exhale	2	Other Synth
525	Braatz...	6	Techno Synth	589	Electrons	1	Pulsating	653	Magic Wave	2	Synth FX	717	X-panda	2	Other Synth
526	AllinOneRiff	7	Techno Synth	590	Protons	2	Pulsating	654	Shangri-La	5	Synth FX	718	Saw Keystep	2	Other Synth
527	YZ Again	7	Techno Synth	591	Brisk Vortex	3	Pulsating	655	CerealKiller	1	Synth FX	719	4mant Cycle	1	Other Synth
528	Floazy Lead	8	Techno Synth	592	Throbulax	2	Pulsating	656	Cosmic Drops	1	Synth FX	720	Modular	2	Other Synth
529	Coffee Bee	2	Techno Synth	593	Lonizer	4	Pulsating	657	Space Echo	4	Synth FX	721	Angel Pipes	2	Other Synth
530	Stage-303	1	Techno Synth	594	diGital Pad	4	Pulsating	658	Robot Sci-Fi	4	Synth FX	722	Wired Synth	8	Other Synth
531	Dance Saws	8	Techno Synth	595	StepPitShift	2	Pulsating	659	Stacc Heaven	4	Other Synth	723	Analog Dream	3	Other Synth
532	AluminmWires	3	Techno Synth	596	Pad Pulses	3	Pulsating	660	Juno Poly	4	Other Synth	724	DCO Bell Pad	4	Other Synth
533	Fred&Barney	6	Techno Synth	597	Seq-Pad 2	8	Pulsating	661	DigitalDream	2	Other Synth	725	Fanta	3	Other Synth
534	Electrostars	4	Techno Synth	598	DSP Chaos	1	Pulsating	662	Jucy Saw	3	Other Synth	726	Juno 5th	2	Other Synth
535	LoFiSequence	2	Techno Synth	599	Dancefloor	4	Pulsating	663	Cue Tip	1	Other Synth	727	DoubleBubble	4	Other Synth
536	Melodic Line	2	Techno Synth	600	Minor Thirds	2	Pulsating	664	Wasy Synth	2	Other Synth	728	Comb	3	Bright Pad
537	TB Wah	1	Techno Synth	601	FX World	2	Pulsating	665	TB-Sequence	1	Other Synth	729	Super SynStr	2	Bright Pad
538	Waving TB303	3	Techno Synth	602	Mr. Fourier	3	Pulsating	666	Europe Xpres	2	Other Synth	730	80s Str	8	Bright Pad
539	Digi Seq	3	Techno Synth	603	Nu Trance X	2	Pulsating	667	Squeepy	1	Other Synth	731	PhaseStrings	2	Bright Pad
540	Juno Seq Saw	1	Techno Synth	604	Auto 5thSaws	4	Pulsating	668	DOC Stack	2	Other Synth	732	Voyager	4	Bright Pad
541	Reso Seq Saw	1	Techno Synth	605	Cross Talk	1	Pulsating	669	Sweep Lead	2	Other Synth	733	Cosmic Rays	4	Bright Pad
542	DetuneSeqSaw	2	Techno Synth	606	Reanimation	2	Pulsating	670	80s Saws 1	8	Other Synth	734	Stringship	4	Bright Pad
543	TechnoIbibe	2	Techno Synth	607	VoX Chopper	2	Pulsating	671	80s Saws 2	6	Other Synth	735	Fat Stacks	4	Bright Pad
544	Teethy Grit	3	Techno Synth	608	Trevor's Pad	4	Pulsating	672	80s Saws 3	5	Other Synth	736	Strings R Us	2	Bright Pad
545	Repetition	4	Techno Synth	609	Fantomas Pad	5	Pulsating	673	Digitaless	2	Other Synth	737	Electric Pad	3	Bright Pad
546	Killerbeez	4	Techno Synth	610	Jazzy Arps	4	Pulsating	674	Flip Pad	3	Other Synth	738	Neo RS-202	2	Bright Pad
547	Acid Lead	2	Techno Synth	611	Keep Running	4	Pulsating	675	Short Detune	2	Other Synth	739	OB Rezo Pad	3	Bright Pad
548	Tranceformer	1	Techno Synth	612	Step In	4	Pulsating	676	forSequence	2	Other Synth	740	Synthi Ens	4	Bright Pad
549	Anadroid	1	Techno Synth	613	Echo Echo	8	Pulsating	677	Memory Pluck	2	Other Synth	741	Giant Sweep	2	Bright Pad
550	Shroomy	3	Techno Synth	614	Keep going	4	Pulsating	678	Metalic Bass	2	Other Synth	742	Mod Dare	4	Bright Pad
551	Noize R us	2	Techno Synth	615	Arposphere	4	Pulsating	679	Aqua	2	Other Synth	743	Space	4	Bright Pad
552	Beep Melodie	4	Techno Synth	616	Voco Riff	4	Pulsating	680	Big Planet	2	Other Synth	744	Digi-Swell	3	Bright Pad
553	Morpher	8	Techno Synth	617	Pulsator	4	Pulsating	681	Wet Atax	2	Other Synth	745	Surfer	2	Bright Pad
554	Uni-G	2	Techno Synth	618	Motion Bass	2	Pulsating	682	Houze Clavi	2	Other Synth	746	New Year Day	4	Bright Pad
555	Power Synth	4	Techno Synth	619	Sine Magic	3	Pulsating	683	SuperSawSlow	2	Other Synth	747	Polar Morn	4	Bright Pad
556	Hoover Again	4	Techno Synth	620	Juno-D Slice	3	Pulsating	684	Trance	3	Other Synth	748	Distant Sun	4	Bright Pad
557	Alpha Said..	2	Techno Synth	621	Pulsatron	4	Pulsating	685	Trancy X	4	Other Synth	749	PG Chimes	4	Bright Pad
558	Ravers Awake	2	Techno Synth	622	Mega Sync	2	Pulsating	686	Trancy Synth	2	Other Synth	750	Saturn Rings	4	Bright Pad
559	Tekno Gargle	2	Techno Synth	623	Passing by	4	Synth FX	687	Juno Trnce	4	Other Synth	751	Brusky	4	Bright Pad
560	Tranceiver	4	Techno Synth	624	Lazer Points	2	Synth FX	688	Saw Stack	2	Other Synth	752	2 Point 2	7	Bright Pad
561	Techno Dream	4	Techno Synth	625	Retro Sci-Fi	4	Synth FX	689	Frigile Saws	2	Other Synth	753	2.2 Pad	7	Bright Pad
562	Techno Pizz	4	Techno Synth	626	Magic Chime	4	Synth FX	690	Steamed Sawz	2	Other Synth	754	two.two Pad	4	Bright Pad
563	VirtualHuman	4	Pulsating	627	TryThis!	3	Synth FX	691	RAVtune	2	Other Synth	755	SaturnHolia	2	Bright Pad
564	Strobot	2	Pulsating	628	New Planetz	4	Synth FX	692	Bustranza	2	Other Synth	756	Neuro-Drone	7	Bright Pad
565	Strobe	4	Pulsating	629	Jet Noise	4	Synth FX	693	AfTtch Ji-n	2	Other Synth	757	In The Pass	3	Bright Pad
566	Strobe X	5	Pulsating	630	Chaos 2003	4	Synth FX	694	JP OctAttack	2	Other Synth	758	Polar Night	4	Bright Pad
567	Rhythmic 5th	4	Pulsating	631	Control Room	4	Synth FX	695	Oct Unison	6	Other Synth	759	5th	3	Bright Pad
568	Pad	3	Pulsating	632	OutOf sortz	5	Synth FX	696	Xtatic	4	Other Synth	760	MistOver5ths	4	Bright Pad
569	DarknessSide	6	Pulsating	633	Scatter	7	Synth FX	697	Dirty Combo	2	Other Synth	761	Gritty Pad	1	Bright Pad
570	Shape of X	5	Pulsating	634	Low Beat-S	5	Synth FX	698	FM's Attack	3	Other Synth	762	India Garden	6	Bright Pad
571	Dance	5	Pulsating	635	WaitnOutside	2	Synth FX	699	Digi-vox Syn	1	Other Synth	763	BillionStars	4	Bright Pad
572	ShapeURMusic	5	Pulsating	636	Breath Echo	1	Synth FX	700	Fairy Factor	6	Other Synth	764	Sand Pad	2	Bright Pad
573	Synth Force	4	Pulsating	637	SoundStrange	3	Synth FX	701	Tempest	2	Other Synth	765	ReverseSweep	2	Bright Pad
574	Trance Split	2	Pulsating	638	Cosmic Pulse	2	Synth FX	702	X-Racer	2	Other Synth	766	HugeSoundMod	4	Bright Pad
575	Step Trance	1	Pulsating	639	Faked Piano	4	Synth FX	703	TB Booster	2	Other Synth	767	Metal Swell	5	Bright Pad
576	Chop Synth	2	Pulsating	640	Crystal Soft	2	Synth FX	704	Syn-Orch/Mod	4	Other Synth	768	NuSoundtrack	4	Bright Pad



Preset 769–896 (CC#0= 87, CC#32 =70 PC=1-128), Preset 897–1024 (CC#0= 87, CC#32 =71 PC=1–128)  
 Preset 1025–1027 (CC#0= 87, CC#32 =72 PC=1– 3)

No	Name	Voice	Category	No	Name	Voice	Category	No	Name	Voice	Category	No	Name	Voice	Category
769	Phat Strings	4	Bright Pad	833	Choir&Str	7	Vox	897	Grand 1	2	AC.Piano	961	D.Bar Org 19	4	Organ
770	Soft OB Pad	3	Soft Pad	834	Aah Vox	2	Vox	898	Grand 2	2	AC.Piano	962	D.Bar Org 20	4	Organ
771	Hollow	4	Soft Pad	835	Synvox	2	Vox	899	Grand 3	2	AC.Piano	963	D.Bar Org 21	4	Organ
772	Sqr Pad	4	Soft Pad	836	Uhhmm	8	Vox	900	Grand 4	2	AC.Piano	964	Cathedral	4	Organ
773	Silk Pad	3	Soft Pad	837	Morning Star	3	Vox	901	Grand 5	2	AC.Piano	965	Posit/Mod	4	Organ
774	WarmReso Pad	2	Soft Pad	838	Syn Opera	4	Vox	902	Piano 1	2	AC.Piano	966	Nylon 1	2	AC.Guitar
775	Soft Pad	3	Soft Pad	839	BeautifulOne	4	Vox	903	Piano 2	2	AC.Piano	967	Nylon 2	2	AC.Guitar
776	Air Pad	4	Soft Pad	840	Ooze	2	Vox	904	Piano 3	2	AC.Piano	968	Nylon 3	2	AC.Guitar
777	Soft Breeze	2	Soft Pad	841	Aerial Choir	4	Vox	905	Piano 4	2	AC.Piano	969	NylonSld	1	AC.Guitar
778	JP Strings 1	3	Soft Pad	842	3D Vox	3	Vox	906	FairyPno	6	AC.Piano	970	St.Nylon	4	AC.Guitar
779	JP Strings 2	5	Soft Pad	843	Film Cue	4	Vox	907	Meditate Pno	4	AC.Piano	971	Ac Bass2	2	Bass
780	DelayStrings	3	Soft Pad	844	Paradise	4	Vox	908	Layers	4	AC.Piano	972	Ac Bass3	2	Bass
781	NorthStrings	4	Soft Pad	845	Sad ceremony	8	Vox	909	EP 1	2	EL.Piano	973	FingrBs1	2	Bass
782	Syn Str	5	Soft Pad	846	Lost Voices	4	Vox	910	EP 2	2	EL.Piano	974	FingrBs2	2	Bass
783	Slow Saw Str	2	Soft Pad	847	Jazz Doos	4	Vox	911	EP 3	2	EL.Piano	975	P.Bass	2	Bass
784	Syn Strings	2	Soft Pad	848	Beat Vox	1	Vox	912	EP Trm 1	2	EL.Piano	976	Fretless	2	Bass
785	OB Slow Str	2	Soft Pad	849	Talk 2 Me	2	Vox	913	EP Trm 2	2	EL.Piano	977	Pick Bs2	2	Bass
786	Strings Pad	2	Soft Pad	850	FM Vox	4	Vox	914	EP Trm 3	2	EL.Piano	978	SlwOrch1	6	Orchestra
787	R&B SoftPad	2	Soft Pad	851	Let's Talk!	3	Vox	915	Wurly 1	2	EL.Piano	979	SlwOrch2	8	Orchestra
788	Reso Pad	3	Soft Pad	852	Nice Kalimba	1	Plucked	916	Wurly 2	2	EL.Piano	980	Strings2	2	Strings
789	Phat Pad	2	Soft Pad	853	Quiet River	4	Plucked	917	Wurly 3	2	EL.Piano	981	DynaStrSect1	4	Strings
790	PhaserPad	2	Soft Pad	854	Teky Drop	4	Plucked	918	WlyTrm 1	2	EL.Piano	982	DynaStrSect2	4	Strings
791	Mystic Str	5	Soft Pad	855	Pat is away	5	Plucked	919	WlyTrm 2	2	EL.Piano	983	Staccato	6	Strings
792	Glass Organ	3	Soft Pad	856	Sitar 1	4	Plucked	920	WlyTrm 3	2	EL.Piano	984	DynaPizz	6	Strings
793	Wind Pad	4	Soft Pad	857	Sitar 2	5	Plucked	921	Chorus 1	2	EL.Piano	985	Bs MG	2	Synth Bass
794	Combination	4	Soft Pad	858	Sitar on C	6	Plucked	922	Chorus 2	2	EL.Piano	986	Bs Reso1	2	Synth Bass
795	HumanKindnes	4	Soft Pad	859	Sitar Baby	1	Plucked	923	Chorus 3	2	EL.Piano	987	Bs Reso2	2	Synth Bass
796	BeautyPad	4	Soft Pad	860	Elec Sitar	3	Plucked	924	EP Belle 2	1	EL.Piano	988	Bs Alpha	2	Synth Bass
797	Atmospherics	2	Soft Pad	861	Neo Sitar	2	Plucked	925	FM EP 1	1	EL.Piano	989	Bs MKS	2	Synth Bass
798	Terra Nostra	8	Soft Pad	862	SarasvatiRvr	3	Plucked	926	FM EP 2	1	EL.Piano	990	Bs SH	2	Synth Bass
799	OB Aahs	4	Soft Pad	863	Bosporus	3	Plucked	927	Tine+Pad	6	EL.Piano	991	Bs TB	2	Synth Bass
800	Vulcano Pad	5	Soft Pad	864	Santur Stack	4	Plucked	928	Wly+Pad	6	EL.Piano	992	Bs MC	2	Synth Bass
801	Cloud #9	3	Soft Pad	865	Aerial Harp	2	Plucked	929	Vibe 2	1	Mallet	993	Bs Pedal	2	Synth Bass
802	Organic Pad	3	Soft Pad	866	Harpiness	2	Plucked	930	Clav 2	2	Keyboards	994	BsReleas	2	Synth Bass
803	Hum Pad	4	Soft Pad	867	Skydiver	2	Plucked	931	Clav 3	2	Keyboards	995	BsCheeze	2	Synth Bass
804	Vox Pad	4	Soft Pad	868	TroubadorEns	4	Plucked	932	Clav 4	2	Keyboards	996	Ld Tri 1	3	Hard Lead
805	Digital Aahs	3	Soft Pad	869	Jamisen	2	Plucked	933	Vibrabel	1	Bell	997	Ld Tri 2	4	Hard Lead
806	Tri 5th Pad	4	Soft Pad	870	Koto	8	Plucked	934	Celesta2	1	Bell	998	Ld Sqr 1	3	Hard Lead
807	MovinPad	8	Soft Pad	871	Monsoon	4	Plucked	935	B Org 1	5	Organ	999	Ld Sqr 2	4	Hard Lead
808	Seq-Pad 1	8	Soft Pad	872	Bend Koto	2	Plucked	936	B Org 2	5	Organ	1000	Ld Saw 1	3	Hard Lead
809	Follow	2	Soft Pad	873	LongDistance	1	Ethnic	937	B Org 3	5	Organ	1001	Ld Saw 2	4	Hard Lead
810	Consolament	3	Soft Pad	874	Ambi Shaku	3	Ethnic	938	B Org 4	5	Organ	1002	Ld GR 1	3	Hard Lead
811	Spacious Pad	4	Soft Pad	875	Lochscape	2	Ethnic	939	B Org 5	5	Organ	1003	Ld GR 2	4	Hard Lead
812	JD Pop Pad	3	Soft Pad	876	PipeDream	4	Ethnic	940	B Org 6	5	Organ	1004	Ld Oct 1	3	Hard Lead
813	JP-8 Phase	4	Soft Pad	877	Far East	4	Ethnic	941	B Org 7	5	Organ	1005	Ld Oct 2	4	Hard Lead
814	Nu Epic Pad	2	Soft Pad	878	Banjo	2	Fretted	942	B Org 8	5	Organ	1006	Ld Swp 1	3	Hard Lead
815	Forever	5	Soft Pad	879	Timpani+Low	4	Percussion	943	D.Bar Org 1	2	Organ	1007	Ld Swp 2	4	Hard Lead
816	Flange Dream	4	Soft Pad	880	Timpani Roll	2	Percussion	944	D.Bar Org 2	2	Organ	1008	Ld Sine1	3	Hard Lead
817	Evolution X	2	Soft Pad	881	Bass Drum	4	Percussion	945	D.Bar Org 3	2	Organ	1009	Ld Sine2	4	Hard Lead
818	Heaven Pad	3	Soft Pad	882	Ambidextrous	2	Sound FX	946	D.Bar Org 4	3	Organ	1010	Syn Str2	6	Soft Pad
819	Angelis Pad	4	Soft Pad	883	En-co-re	4	Sound FX	947	D.Bar Org 5	3	Organ	1011	Syn Str3	6	Soft Pad
820	Juno-106 Str	1	Soft Pad	884	Mobile Phone	1	Sound FX	948	D.Bar Org 6	3	Organ	1012	Syn Pad1	6	Soft Pad
821	JupiterMoves	2	Soft Pad	885	ElectroDisco	5	Beat&Groove	949	D.Bar Org 7	3	Organ	1013	Syn Pad2	6	Soft Pad
822	Oceanic Pad	2	Soft Pad	886	Groove 007	4	Beat&Groove	950	D.Bar Org 8	3	Organ	1014	SynPoly1	6	Other Synth
823	Fairy's Song	4	Soft Pad	887	In Da Groove	4	Beat&Groove	951	D.Bar Org 9	3	Organ	1015	SynPoly2	6	Other Synth
824	Borealis	2	Soft Pad	888	Sweet 80s	4	Beat&Groove	952	D.Bar Org 10	3	Organ	1016	Syn Brs1	6	Synth Brass
825	JX Warm Pad	2	Soft Pad	889	Auto trance	4	Beat&Groove	953	D.Bar Org 11	3	Organ	1017	Syn Brs2	6	Synth Brass
826	Analog Bgrrnd	3	Soft Pad	890	Juno Pop	4	Beat&Groove	954	D.Bar Org 12	3	Organ	1018	Oct Brs1	6	Synth Brass
827	Choir Aahs 1	4	Vox	891	Compusonic 1	4	Beat&Groove	955	D.Bar Org 13	2	Organ	1019	Oct Brs2	6	Synth Brass
828	Choir Aahs 2	4	Vox	892	Compusonic 2	4	Beat&Groove	956	D.Bar Org 14	2	Organ	1020	Pad Airy	8	Soft Pad
829	ChoirOoh/Aft	4	Vox	893	80s Combo	3	Combination	957	D.Bar Org 15	2	Organ	1021	Pad Soft	4	Bright Pad
830	Angels Choir	4	Vox	894	Analog Days	3	Combination	958	D.Bar Org 16	3	Organ	1022	Pad Pure	4	Bright Pad
831	Angelique	4	Vox	895	Techno Craft	3	Combination	959	D.Bar Org 17	3	Organ	1023	Pad Vox1	2	Bright Pad
832	Gospel Oohs	2	Vox	896	Lounge Kit	2	Combination	960	D.Bar Org 18	3	Organ	1024	Pad Vox2	2	Bright Pad
												1025	VOCODER Robt	1	Vox
												1026	VOCODER Chr	1	Vox
												1027	VOCODER Ens	1	Vox

# Patch List

## GM (GM2 Group)

No	Name	Category	Voices	LSB	PC	No	Name	Category	Voices	LSB	PC	No	Name	Category	Voices	LSB	PC
001	Piano 1	AC.PIANO	2	0	1	065	Chorus Gt.	EL.GUITAR	2	1		129	French Horns	AC.BRASS	3	0	61
002	Piano 1w	AC.PIANO	2	1		066	Mid Tone GTR	EL.GUITAR	1	2		130	Fr.Horn 2	AC.BRASS	1	1	
003	European Pf	AC.PIANO	2	2		067	Muted Gt.	EL.GUITAR	1	0	29	131	Brass 1	AC.BRASS	4	0	62
004	Piano 2	AC.PIANO	2	0	2	068	Funk Pop	EL.GUITAR	1	1		132	Brass 2	AC.BRASS	4	1	
005	Piano 2w	AC.PIANO	2	1		069	Funk Gt.2	EL.GUITAR	1	2		133	Synth Brass1	SYNTH BRASS	4	0	63
006	Piano 3	AC.PIANO	2	0	3	070	Jazz Man	EL.GUITAR	1	3		134	JP Brass	SYNTH BRASS	4	1	
007	Piano 3w	AC.PIANO	2	1		071	Overdrive Gt	DIST.GUITAR	2	0	30	135	Oct SynBrass	SYNTH BRASS	4	2	
008	Honky-tonk	AC.PIANO	2	0	4	072	Guitar Pinch	DIST.GUITAR	1	1		136	Jump Brass	SYNTH BRASS	3	3	
009	Honky-tonk 2	AC.PIANO	2	4		073	DistortionGt	DIST.GUITAR	1	0	31	137	Synth Brass2	SYNTH BRASS	3	0	64
010	E.Piano 1	EL.PIANO	1	0	5	074	Feedback Gt.	DIST.GUITAR	2	1		138	SynBrass sfz	SYNTH BRASS	2	1	
011	St.Soft EP	EL.PIANO	3	1		075	Dist Rtm GTR	DIST.GUITAR	2	2		139	Velo Brass 1	SYNTH BRASS	2	2	
012	FM+SA EP	EL.PIANO	3	2		076	Gt.Harmonics	EL.GUITAR	2	0	32	140	Soprano Sax	SAX	1	0	65
013	Wurly	EL.PIANO	1	3		077	Gt. Feedback	EL.GUITAR	1	1		141	Alto Sax	SAX	1	0	66
014	E.Piano 2	EL.PIANO	4	0	6	078	Acoustic Bs.	BASS	1	0	33	142	Tenor Sax	SAX	1	0	67
015	Detuned EP 2	EL.PIANO	4	1		079	Fingered Bs.	BASS	3	0	34	143	Baritone Sax	SAX	1	0	68
016	St.FM EP	EL.PIANO	4	2		080	Finger Slap	BASS	3	1		144	Oboe	WIND	3	0	69
017	EP Legend	EL.PIANO	4	3		081	Picked Bass	BASS	3	0	35	145	English Horn	WIND	1	0	70
018	EP Phase	EL.PIANO	2	4		082	Fretless Bs.	BASS	2	0	36	146	Bassoon	WIND	1	0	71
019	Harpsichord	KEYBOARDS	2	0	7	083	Slap Bass 1	BASS	2	0	37	147	Clarinet	WIND	2	0	72
020	Coupled Hps.	KEYBOARDS	7	1		084	Slap Bass 2	BASS	3	0	38	148	Piccolo	FLUTE	2	0	73
021	Harpsi.w	KEYBOARDS	2	2		085	Synth Bass 1	SYNTH BASS	1	0	39	149	Flute	FLUTE	2	0	74
022	Harpsi.o	KEYBOARDS	4	3		086	SynthBass101	SYNTH BASS	1	1		150	Recorder	FLUTE	1	0	75
023	Clav.	KEYBOARDS	2	0	8	087	Acid Bass	SYNTH BASS	1	2		151	Pan Flute	FLUTE	1	0	76
024	Pulse Clav	KEYBOARDS	2	1		088	Clavi Bass	SYNTH BASS	2	3		152	Bottle Blow	FLUTE	2	0	77
025	Celesta	KEYBOARDS	1	0	9	089	Hammer	SYNTH BASS	2	4		153	Shakuhachi	ETHNIC	2	0	78
026	Glockenspiel	BELL	1	0	10	090	Synth Bass 2	SYNTH BASS	3	0	40	154	Whistle	FLUTE	2	0	79
027	Music Box	BELL	2	0	11	091	Beef FM Bass	SYNTH BASS	2	1		155	Ocarina	FLUTE	3	0	80
028	Vibraphone	MALLET	1	0	12	092	RubberBass 2	SYNTH BASS	2	2		156	Square Wave	HARD LEAD	2	0	81
029	Vibraphone w	MALLET	1	1		093	Attack Pulse	SYNTH BASS	1	3		157	MG Square	HARD LEAD	1	1	
030	Marimba	MALLET	1	0	13	094	Violin	STRINGS	1	0	41	158	2600 Sine	HARD LEAD	1	2	
031	Marimba w	MALLET	1	1		095	Slow Violin	STRINGS	1	1		159	Saw Wave	HARD LEAD	2	0	82
032	Xylophone	MALLET	1	0	14	096	Viola	STRINGS	1	0	42	160	OB2 Saw	HARD LEAD	1	1	
033	Tubular-bell	BELL	1	0	15	097	Cello	STRINGS	1	0	43	161	Doctor Solo	HARD LEAD	2	2	
034	Church Bell	BELL	1	1		098	Contrabass	STRINGS	1	0	44	162	Natural Lead	HARD LEAD	2	3	
035	Carillon	BELL	4	2		099	Tremolo Str	STRINGS	4	0	45	163	SequencedSaw	HARD LEAD	2	4	
036	Santur	PLUCKED	4	0	16	100	PizzicatoStr	STRINGS	4	0	46	164	Syn.Calliope	SOFT LEAD	2	0	83
037	Organ 1	ORGAN	3	0	17	101	Harp	PLUCKED	2	0	47	165	Chiffer Lead	SOFT LEAD	2	0	84
038	Trem. Organ	ORGAN	2	1		102	Yang Qin	PLUCKED	3	1		166	Charang	HARD LEAD	2	0	85
039	60's Organ 1	ORGAN	1	2		103	Timpani	PERCUSSION	4	0	48	167	Wire Lead	HARD LEAD	2	1	
040	70's E.Organ	ORGAN	2	3		104	Strings	STRINGS	4	0	49	168	Solo Vox	SOFT LEAD	2	0	86
041	Organ 2	ORGAN	3	0	18	105	Orchestra	ORCHESTRA	7	1		169	5th Saw Wave	HARD LEAD	2	0	87
042	Chorus Or.2	ORGAN	3	1		106	60s Strings	STRINGS	4	2		170	Bass & Lead	HARD LEAD	2	0	88
043	Perc. Organ	ORGAN	4	2		107	Slow Strings	STRINGS	4	0	50	171	Delayed Lead	HARD LEAD	2	1	
044	Organ 3	ORGAN	4	0	19	108	Syn.Strings1	STRINGS	3	0	51	172	Fantasia	OTHER SYNTH	4	0	89
045	Church Org.1	ORGAN	2	0	20	109	Syn.Strings3	STRINGS	3	1		173	Warm Pad	SOFT PAD	1	0	90
046	Church Org.2	ORGAN	4	1		110	Syn.Strings2	SOFT PAD	2	0	52	174	Sine Pad	SOFT PAD	2	1	
047	Church Org.3	ORGAN	6	2		111	Choir Aahs	VOX	4	0	53	175	Polysynth	OTHER SYNTH	2	0	91
048	Reed Organ	ORGAN	3	0	21	112	Chorus Aahs	VOX	4	1		176	Space Voice	VOX	4	0	92
049	Puff Organ	ORGAN	1	1		113	Voice Oohs	VOX	4	0	54	177	Itopia	VOX	3	1	
050	Accordion Fr	ACCRDION	3	0	22	114	Humming	VOX	4	1		178	Bowed Glass	SOFT PAD	3	0	93
051	Accordion It	ACCRDION	3	1		115	SynVox	VOX	4	0	55	179	Metal Pad	BRIGHT PAD	4	0	94
052	Harmonica	HARMONICA	2	0	23	116	Analog Voice	VOX	2	1		180	Halo Pad	BRIGHT PAD	3	0	95
053	Bandoneon	ACCRDION	3	0	24	117	OrchestraHit	HIT&STAB	2	0	56	181	Sweep Pad	SOFT PAD	3	0	96
054	Nylon-str.Gt	AC.GUITAR	1	0	25	118	Bass Hit	HIT&STAB	2	1		182	Ice Rain	OTHER SYNTH	3	0	97
055	Ukulele	AC.GUITAR	1	1		119	6th Hit	HIT&STAB	2	2		183	Soundtrack	SOFT PAD	5	0	98
056	Nylon Gt.o	AC.GUITAR	2	2		120	Euro Hit	HIT&STAB	2	3		184	Crystal	BELL	2	0	99
057	Nylon Gt.2	AC.GUITAR	1	3		121	Trumpet	AC.BRASS	2	0	57	185	Syn Mallet	BELL	2	1	
058	Steel-str.Gt	AC.GUITAR	4	0	26	122	Dark Trumpet	AC.BRASS	1	1		186	Atmosphere	AC.GUITAR	3	0	100
059	12-str.Gt	AC.GUITAR	3	1		123	Trombone	AC.BRASS	1	0	58	187	Brightness	OTHER SYNTH	4	0	101
060	Mandolin	AC.GUITAR	2	2		124	Trombone 2	AC.BRASS	2	1		188	Goblin	PULSATING	3	0	102
061	Steel + Body	AC.GUITAR	4	3		125	Bright Tb	AC.BRASS	2	2		189	Echo Drops	BRIGHT PAD	2	0	103
062	Jazz Gt.	EL.GUITAR	1	0	27	126	Tuba	AC.BRASS	1	0	59	190	Echo Bell	BRIGHT PAD	3	1	
063	Pedal Steel	EL.GUITAR	1	1		127	MutedTrumpet	AC.BRASS	3	0	60	191	Echo Pan	BRIGHT PAD	2	2	
064	Clean Gt.	EL.GUITAR	1	0	28	128	MuteTrumpet2	AC.BRASS	1	1		192	Star Theme	BRIGHT PAD	3	0	104

No	Name	Category	Voices	LSB	PC
193	Sitar	PLUCKED	2	0	105
194	Sitar 2	PLUCKED	5	1	
195	Banjo	FRETTED	2	0	106
196	Shamisen	PLUCKED	2	0	107
197	Koto	PLUCKED	4	0	108
198	Taisho Koto	PLUCKED	3	1	
199	Kalimba	PLUCKED	1	0	109
200	Bagpipe	ETHNIC	3	0	110
201	Fiddle	STRINGS	1	0	111
202	Shanai	ETHNIC	2	0	112
203	Tinkle Bell	BELL	3	0	113
204	Agogo	PERCUSSION	1	0	114
205	Steel Drums	MALLET	2	0	115
206	Woodblock	PERCUSSION	1	0	116
207	Castanets	PERCUSSION	1	1	
208	Taiko	PERCUSSION	3	0	117
209	Concert BD	PERCUSSION	4	1	
210	Melo. Tom 1	PERCUSSION	1	0	118
211	Melo. Tom 2	PERCUSSION	1	1	
212	Synth Drum	PERCUSSION	1	0	119
213	808 Tom	PERCUSSION	1	1	
214	Elec Perc	PERCUSSION	1	1	
215	Reverse Cym.	PERCUSSION	1	0	120
216	Gt.FretNoise	AC.GUITAR	1	0	121
217	Gt.Cut Noise	AC.GUITAR	1	1	
218	String Slap	AC.GUITAR	1	2	
219	Breath Noise	SYNTH FX	1	0	122
220	Fl.Key Click	SYNTH FX	1	1	
221	Seashore	SOUND FX	2	0	123
222	Rain	SOUND FX	2	1	
223	Thunder	SOUND FX	1	2	
224	Wind	SOUND FX	2	3	
225	Stream	SOUND FX	2	4	
226	Bubble	SOUND FX	2	5	
227	Bird	SOUND FX	2	0	124
228	Dog	SOUND FX	1	1	
229	Horse-Gallop	SOUND FX	1	2	
230	Bird 2	SOUND FX	1	3	
231	Telephone 1	SOUND FX	1	0	125
232	Telephone 2	SOUND FX	1	1	
233	DoorCreaking	SOUND FX	1	2	
234	Door	SOUND FX	1	3	
235	Scratch	SOUND FX	1	4	
236	Wind Chimes	SOUND FX	2	5	
237	Helicopter	SOUND FX	1	0	126
238	Car-Engine	SOUND FX	1	1	
239	Car-Stop	SOUND FX	1	2	
240	Car-Pass	SOUND FX	1	3	
241	Car-Crash	SOUND FX	2	4	
242	Siren	SOUND FX	1	5	
243	Train	SOUND FX	1	6	
244	Jetplane	SOUND FX	3	7	
245	Starship	SOUND FX	4	8	
246	Burst Noise	SOUND FX	2	9	
247	Applause	SOUND FX	2	0	127
248	Laughing	SOUND FX	1	1	
249	Screaming	SOUND FX	1	2	
250	Punch	SOUND FX	1	3	
251	Heart Beat	SOUND FX	1	4	
252	Footsteps	SOUND FX	1	5	
253	Gun Shot	SOUND FX	1	0	128
254	Machine Gun	SOUND FX	1	1	
255	Lasergun	SOUND FX	1	2	
256	Explosion	SOUND FX	2	3	

# Rhythm Set List

## USER (User Group)

No	Name
001	SF Std Kit
002	WD Std Kit
003	LD Std Kit
004	TY Std Kit
005	StandardKit1
006	StandardKit2
007	StandardKit3
008	Rock Kit 1
009	Rock Kit 2
010	Brush Jz Kit
011	Orch Kit
012	909 808 Kit
013	Limiter Kit
014	HipHop Kit 1
015	R&B Kit
016	HiFi R&B Kit
017	Machine Kit1
018	Kit-Euro:POP
019	House Kit
020	Nu Technica
021	Machine Kit2
022	ArtificalKit
023	Noise Kit
024	Kick Menu
025	Snare Menu
026	Snr/Rim Menu
027	HiHat Menu
028	Tom Menu
029	Clp&Cym&Hit
030	FX/SFX Menu
031	Percussion
032	Scr&Vox&Wld

## PRST (Preset Group)

No	Name
001	SF Std Kit
002	WD Std Kit
003	LD Std Kit
004	TY Std Kit
005	StandardKit1
006	StandardKit2
007	StandardKit3
008	Rock Kit 1
009	Rock Kit 2
010	Brush Jz Kit
011	Orch Kit
012	909 808 Kit
013	Limiter Kit
014	HipHop Kit 1
015	R&B Kit
016	HiFi R&B Kit
017	Machine Kit1
018	Kit-Euro:POP
019	House Kit
020	Nu Technica
021	Machine Kit2
022	ArtificalKit
023	Noise Kit
024	Kick Menu
025	Snare Menu
026	Snr/Rim Menu
027	HiHat Menu
028	Tom Menu
029	Clp&Cym&Hit
030	FX/SFX Menu
031	Percussion
032	Scr&Vox&Wld

## GM (GM2 Group)

No	Name
001	GM2 STANDARD
002	GM2 ROOM
003	GM2 POWER
004	GM2 ELECTRIC
005	GM2 ANALOG
006	GM2 JAZZ
007	GM2 BRUSH
008	GM2 ORCHESTRA
009	GM2 SFX

\* Rhythm Set are common to Preset Group and User Group.

## USER (User Group)/PRST (Preset Group)

Prst:	001	002	003	004	005	006
User:	001	002	003	004	005	006
Note No.	SF Std Kit	WD Std Kit	LD Std Kit	TY Std Kit	StandardKit1	StandardKit2
28	Dance Kick	Dance Kick	Dance Kick	Dance Kick	MaxLow Kick2	Dance Kick
29	Dry Kick 1	Dry Kick 1	Dry Kick 1	Dry Kick 1	Rk CmpKick	Dry Kick 1
30	Snr Roll	Snr Roll	Snr Roll	Snr Roll	Gospel Clap	Snr Roll
31	Power Kick	Power Kick	Power Kick	Power Kick	Sweep Bass	Power Kick
32	Amb.Snr 2	Amb.Snr 2	Amb.Snr 2	Amb.Snr2 p	Sft Snr Gst	Amb.Snr 2p
33	Power Kick	Reg.Kick 2	Reg.Kick 2	Power Kick	HipHop Kick2	Power Kick
34	Reg.PHH	Reg.PHH	Reg.PHH	Reg.PHH	Reg.PHH	Reg.PHH
35	Reg.Kick	Reg.Kick 1	Reg.Kick 1	Reg.Kick	Reg.Kick 1	Reg.Kick 1
C2	SF Kick 1	WD Kick	LD Kick	TY Kick	Reg.Kick 2	Reg.Kick 2
37	SF CStk	WD CStk	LD CStk	TY CStk	Reg.Stick	Wild Stick
38	SF Snr	WD Snr	LD Snr	TY Snr	Reg.Snr 2	Amb.Snr 1
39	SF Snr Gst	SF Snr Gst	Reg.Snr Gst	SF SnrGst	Reg.Snr Gst	Reg.Snr Gst
40	SF Rim	WD Rim	LD Rim	TY Rim	Reg.Snr 1	Amb.Snr 2
41	RR F.Tom	RR F.Tom	RR F.Tom	RR F.Tom	Reg.F.Tom	Reg.F.Tom
42	Reg.CHH 1	Reg.CHH 1	Reg.CHH 1	Reg.CHH 1	Reg.CHH 1	Reg.CHH 1
43	SF L.Tom	TY L.Tom	LD L.Tom	TY L.Tom	Reg.L.Tom	Reg.L.Tom
44	Reg.CHH 2	Reg.CHH 2	Reg.CHH 2	Reg.CHH 2	Reg.CHH 2	Reg.CHH 2
45	SF M.Tom	TY M.Tom	LD M.Tom	TY M.Tom	Reg.M.Tom 1	Reg.M.Tom
46	Reg.OHH	Reg.OHH	Reg.OHH	Reg.OHH	Reg.OHH	Reg.OHH
47	SF MT.Flm	TY M.Tom	LD M.Tom	TY M.Tom	Reg.M.Tom 2	Reg.M.TomFlm
C3	SF H.Tom	TY H.Tom	LD H.Tom	TY H.Tom	Reg.H.Tom 1	Reg.H.Tom
49	Crash Cym1a	Crash Cym1a	Crash Cym1a	Crash Cym 2	Crash Cym1	Crash Cym1a
50	SF HT.Flm	TY H.Tom	LD H.Tom	TY H.Tom	Reg.H.Tom 2	Reg.H.TomFlm
51	Rock Ride 1	Rock Ride 1	Rock Ride 1	Rock Ride 1	Rock Ride	Rock Ride 1
52	China Cymbal	China Cymbal	China Cymbal	China Cymbal	China Cymbal	China Cymbal
53	Splash Cym	Splash Cym	Splash Cym	Splash Cym	Ride Edge	Splash Cym
54	Tamborine2	Tamborine 3	Tamborine 3	Tamborine2	Tamborine	Tamborine
55	Rock Crash 1	Rock Crash 1	Rock Crash 1	Crash Cym1a	Crash Cym2a	Rock Crash 1
56	Cowbell3	Cowbell3	Cowbell3	Cowbell3	Cowbell Low	Cowbell Hi
57	Crash Cym1b	Crash Cym1b	Crash Cym1	Crash Cym1b	Crash Cym2b	Crash Cym1b
58	Cowbell2 Lng	Cowbell2 Lng	Cowbell	Cowbell2 Lng	Cowbell Hi	Cowbell Low
59	Rock Ride.2	Rock Ride.2	Rock Ride.2	Rock Ride.2	Ride Bell	Rock Ride.2
C4	Conga 2H Mt	Conga Hi Mt	Conga 2H Mt	Conga 2H Mt	Conga Hi Mt	Conga Hi Mt
61	Conga 2L Mt	Conga Lo Mt	Conga 2L Mt	Conga 2L Mt	Conga Lo Mt	Conga Lo Mt
62	Conga 2H Slp	Conga Hi Slp	Conga 2H Slp	Conga 2H Slp	Conga Lo	Conga Hi Slp
63	Conga 2H Op	Conga Hi Op	Conga 2H Op	Conga 2H Op	Conga Hi Op	Conga Hi Op
64	Conga 2L Op	Conga Lo Op	Conga Lo Op	Conga 2L Op	Conga Lo Op	Conga Lo Op
65	Timbale 4	Timbale Hi	Timbale 1	Timbale 4	Timbale Hi	Timbale Hi
66	Timbale 3	Timbale Low	Timbale 2	Timbale 3	Timbale Low	Timbale Low
67	Agogo 2 Hi	Mild Agogo H	Agogo 2 Hi	Agogo 2 Hi	Agogo Bell H	Mild Agogo H
68	Agogo 2 Low	Mild Agogo L	Agogo 2 Low	Agogo 2 Low	Agogo Bell L	Mild Agogo L
69	Cabasa 2	Cabasa Up	Cabasa 2	Cabasa 2	Cabasa Up	Cabasa Up
70	Shaker 2	Maracas	Shaker 2	Shaker 1	Maracas	Maracas
71	Whistle Shrt	Whistle Shrt	Whistle Shrt	Whistle Shrt	Whistle Shrt	Whistle Shrt
C5	Whistle Long	Whistle Long	Whistle	Whistle Long	Whistle Long	Whistle Long
73	Guiro 2 Up	Guiro Short	Guiro 2 Up	Guiro 2 Up	Guiro Short	Guiro Short
74	Guiro 2 Down	Guiro Long	Guiro Long	Guiro 2 Down	Guiro Long	Guiro Long
75	Claves 2	Claves	Claves 2	Claves 2	Claves	Claves
76	Wood Block2H	Wood Block H	Wood Block2H	Wood Block2H	Wood Block H	Wood Block H
77	Wood Block2L	Wood Block L	Wood Block2L	Wood Block2L	Wood Block L	Wood Block L
78	Cuica 2 Low	Cuica Mute	Cuica 2 Low	Cuica 2 Low	Cuica Mute	Cuica Mute
79	Cuica 2 Hi	Cuica Open	Cuica 2 Hi	Cuica 2 Hi	Cuica Open	Cuica Open
80	Triangle Mt	Triangle Mt	Triangle Mt	Triangle Mt	Triangle Mt	Triangle Mt
81	Triangle Op	Triangle Op	Triangle Op	Triangle Op	Triangle Op	Triangle Op
82	Cabasa2 Cut	Cabasa Cut	Cabasa2 Cut	Cabasa2 Cut	Cabasa Cut	Cabasa Cut
83	DigiSpectrum	DigiSpectrum	DigiSpectrum	DigiSpectrum	Castanet	DigiSpectrum
C6	Wind Chime	Wind Chime	Wind Chime	Wind Chime	Bongo Hi Mt	Wind Chime
85	Wood Block2M	Wood Block M	Wood Block2M	Wood Block2M	Bongo Hi Slp	Wood Block M
86	Cajon 2	Cajon 2	Cajon 2	Cajon 2	Bongo Lo Slp	Cajon 2
87	ConcertBD	ConcertBD	ConcertBD	ConcertBD	Bongo Hi Op	ConcertBD
88	R&B Kick	R&B Kick	R&B Kick	R&B Kick	Bongo Lo Op	R&B Kick
89	Dry Kick 2	Dry Kick 2	Dry Kick 2	Dry Kick 2	Cajon 1	Dry Kick 2
90	Old Kick	Old Kick	Old Kick	Old Kick	Cajon 2	Old Kick
91	Jazz Doos	Jazz Doos	Jazz Doos	Jazz Doos	Cajon 3	Jazz Doos
92	Agogo Noise	Agogo Noise	Agogo Noise	Agogo Noise	Vint Snr 2	Agogo Noise
93	Rock OHH	Rock OHH	Rock OHH	Rock OHH	Shaker 3	Rock OHH
94	JD Anklungs	JD Anklungs	JD Anklungs	JD Anklungs	WD Rim	JD Anklungs
95	Rock OHH	Rock OHH	Rock OHH	Rock OHH	Mix Kick 1	Rock OHH
C7	Cajon 3	Cajon 3	Cajon 3	Cajon 3	Mix Kick 2	Mix Kick 1
97	Cajon 1	Cajon 1	Cajon 1	Cajon 1	Mix Kick 3	Cajon 1
98	Mix Kick 4	Mix Clap	Mix Kick 4	TY Rim f	Mix Kick 4	Mix Kick 2
99	Gospel Clap	Gospel Clap	Gospel Clap	Gospel Clap	Mix Kick 5	Gospel Clap
100	Bright Clap	Bright Clap	Bright Clap	Bright Clap	Mix Clap 1	Bright Clap
101	Rock Rd Cup	Rock Rd Cup	Rock Rd Cup	Rock Rd Cup	Wind Chime	Rock Rd Cup
102	Cowbell	Cowbell	Cowbell	Cowbell	Tibet Cymbal	Cowbell
103	Crash Cym 2	Crash Cym 2	Crash Cym 2	Crash Cym 2	Crotale	Crash Cym 2

# Rhythm Set List

Prst:	007	008	009	010	011	012
User:	007	008	009	010	011	012
Note No.	StandardKit3	Rock Kit 1	Rock Kit 2	Brush Jz Kit	Orch Kit	909 808 Kit
28	HipHop Kick2	R&B Kick	MaxLow Kick2	TR909 Kick1a	Timpani Roll	TR909 Kick 2
29	Syn Swt Atk1	Rk CmpKick	MaxLow Kick1	TR909 Kick1b	ConcertBD 2	TR909 Kick 4
30	Lo-Bit Stk 1	Sff Snr Gst	LD Rim mf	Jazz Snr	R8 Shaker 1	Urbn Sn Roll
31	TR707 Kick	Dry Kick 4	Power Kick	Reg.Kick 1	Jngl pkt Snr	TR909 Kick 5
32	TR808 Snr 5	Snr Roll	Mix Clap 2	Soft Jz Roll	Reverse Cym	TR909 Snr 3
33	Vint Kick 1	SH32 Kick	Vint Kick	Reg.Kick 2	Snr Roll	TR909 Kick 3
34	Reg.PHH	Reg.PHH	Rock CHH2	Reg.PHH	Jazz Ride	TR909 PHH 2
35	Vint Kick 2	Reg.Kick 1	Rock Kick	Jazz Kick 1	Timpani Roll	TR909 Kick 6
36	Old Kick 1	Reg.Kick 2	Rk CmpKick	Jazz Kick 2	ConcertBD 1	TR909 Kick 1
37	Lo-Bit Stk 4	Reg.Stick	Wild Stick	Hard Stick	Hard Stick	TR909 Rim
38	Reg.Snr 1	Reg.Snr2	Maple Snr	Jazz Rim	Amb.Snr 2	TR909 Snr 1
39	Amb Clap	Reg.Snr Gst	Sft Snr Gst	Jz Brsh Swsh	Gospel Clap	TR909 Clap 1
40	TY Rim	Reg.Snr 1	Reg.Snr 1	Jazz Snr	Concert SD	TR909 Snr 2
41	Jazz Lo Tom1	Reg.F.Tom	Sharp L.Tom1	Reg.F.Tom 1	Timpani F	TR909 Tom L
42	Reg.CHH 1	Reg.CHH 1	Rock CHH 1	Reg.CHH 1	Timpani F#	TR909 CHH 1
43	Jazz Lo Tom2	Reg.L.Tom	Sharp L.Tom2	Reg.L.Tom 1	Timpani G	TR909 Tom L
44	Reg.CHH 2	Reg.CHH 2	Reg.PHH	Reg.CHH 2	Timpani G#	TR909 PHH 1
45	Jazz Mid Tom	Reg.M.Tom	Sharp L.Tom3	Reg.M.Tom 1	Timpani A	TR909 Tom M
46	Reg.OHH	Reg.OHH	Rock OHH	Reg.OHH	Timpani A#	TR909 OHH 2
47	Jazz Mid Tom	Reg.M.TomFlm	Sharp H.Tom1	Reg.M.Tom 1	Timpani B	TR909 Tom M
48	Jazz Hi Tom	Reg.H.Tom	Sharp H.Tom2	Reg.H.Tom 1	Timpani C	TR909 Tom H
49	Crash Cym1	Crash Cym 1a	Crash Cym 1	Jazz Crash	Timpani C#	TR909 Crash
50	Jazz Hi Tom	Reg.H.TomFlm	Sharp H.Tom3	Reg.H.Tom 1	Timpani D	TR909 Tom H
51	Rock Rd Edge	Rock Ride 1	Ride Cymbal	Jazz Ride 1	Timpani D#	TR909 Ride 1
52	China Cymbal	China Cymbal	China Cymbal	China Cym 1	Timpani E	TR909 Crash1
53	Rock Rd Cup	Splash Cym	Ride Bell	Ride Edge	Timpani f	TR909 Ride 2
54	Tamborine	Tamborine	Tamborine 3	Tamborine	Tamborine 3	CR78 Tamb 1
55	Splash Cym	Rock Crash 1	Rock Crash 2	Crash Cym	Concert Cym	TR909 Crash2
56	Cowbell	Cowbell Hi	Cowbell Mute	Cowbell Low	Cowbell Mute	JD Sm Metal
57	Rock Crash 2	Crash Cym 1b	Splash Cym	Crash Cym	Concert Cym2	TR909 Ride 3
58	TR808 Cym	Cowbell Low	Cowbell	Cowbell Hi	Ride Cymbal	Syn Swt Atk3
59	Jazz Ride	Rock Ride 2	Rock Rd.Cup	Ride Bell	Crash Cym.1	TR808 Kick 1
60	Bongo Hi	Conga Hi Mt	Conga Hi Mt	Conga Hi Mt	Bongo Hi Op	TR808 Kick 2
61	Bongo Lo	Conga Lo Mt	Conga Lo Mt	Conga Lo Mt	Bongo Lo Op	TR808 Rim
62	Conga Hi Mt	Conga Hi Slp	Conga Slp Op	Conga Lo Slp	Conga Hi Mt	TR808 Snr 2
63	Conga Hi	Conga Hi Op	Conga Hi Op	Conga Hi Op	Conga Hi Op	TR808 Clap 2
64	Conga Lo	Conga Lo Op	Conga Lo Op	Conga Lo Op	Conga Lo Op	TR808 Snr 4
65	Timbale Hi	Timbale Hi	Timbale Hi	Timbale Hi	Timbale Hi	TR808 Tom L
66	Timbale Low	Timbale Low	Timbale Low	Timbale Low	Timbale Low	TR808 CHH 1
67	Cowbell Hi	Agogo Bell H	Agogo Bell H	Agogo Bell H	Agogo Bell H	TR808 Tom L
68	Cowbell Low	Agogo Bell L	Agogo Bell L	Agogo Bell L	Agogo Bell L	TR808 CHH 2
69	Cabasa	Cabasa Up	Cabasa Up	Cabasa Up	Cabasa Up	TR808 Tom M
70	Shaker	Maracas	Maracas	Maracas	Maracas	TR808 OHH 1
71	Noise.OHH 2	Whistle Shrt	Whistle Shrt	Jazz Kick 1	Whistle Shrt	TR808 Tom M
72	Scratch 5	Whistle Long	Whistle Long	Jazz Kick 2	Whistle Long	TR808 Tom H
73	Syn Low Atk2	Guiro Short	Guiro Short	Hard Stick	Guiro Short	TR808Cowbell
74	MG Zap 3	Guiro Long	Guiro Long	Jazz Rim	Guiro Long	TR808 Tom H
75	Syn Swt Atk1	Claves	Claves	Sft Snr Gst	Claves	TR606 Cym
76	Syn Swt Atk4	Wood Block H	Wood Block H	Jazz Snr	Wood Block H	TR606 OHH 1
77	Bongo Hi Slp	Wood Block L	Wood Block L	Reg.F.Tom 2	Wood Block L	TR606 OHH 2
78	Noise OHH	Cuica Mute	Cuica Mute	Reg.CHH 1	Cuica Mute	CR78 Tamb 2
79	Noise CHH	Cuica Open	Cuica Open	Reg.L.Tom 2	Cuica Open	CR78 OHH 1
80	Triangle 1	Triangle Mt	Triangle Mt	Reg.CHH 2	Triangle Mt	Cowbell Mute
81	Triangle 2	Triangle Op	Triangle Op	Reg.M.Tom 2	Triangle Op	CR78 OHH 2
82	Cajon 1	Cabasa Cut	Cabasa Cut	Reg.OHH	Cabasa Cut	Syn Swt Atk5
83	Cajon 3	DigiSpectrum	Wind Chime	Reg.M.TomFlm	Finger Snap	TR808 OHH 2
84	Wind Chime	Wind Chime	Dist Chord 1	Reg.H.Tom 2	Wind Chime	808 Maracas
85	SprgDrm Hit	Dist Chord 1	Dist Chord 2	Jazz Cymbal	Tibet Cymbal	TR808 Claves
86	Crotale	Dist Chord 2	Dist Chord 3	Reg.H.TomFlm	Vibraslap	Triangle Mt
87	R8 Click	Dist Chord 3	Dist Chord 4	Jazz Ride 2	Crotale	Triangle Op
88	Metro Bell	Dist Chord 4	Dist Chord 5	China Cym 2	Applause	Narrow Hit 2
89	DR202 Beep	Dist Chord 5	Dist Chord 6	Cajon 1	TubulrBel F	TR808 Cym1
90	Reverse Cym	Rock CHH 2	Rock CHH 2	Cajon 2	TubulrBel F#	MG Zap 4
91	Xylo Seq.	Cowbell 2a	Dist Chord 7	Cajon 3	TubulrBel G	Scratch 1
92	Vinyl Noise	Rock CHH 1	DistGtr Nz 1	Cajon 3	TubulrBel G#	MG Zap 1
93	Mobile Phone	Cowbell 2b	DistGtr Nz 2	Vint Snr 2	TubulrBel A	TR606 Snr 2
94	Group Snap	Rock OHH	DistGtr Nz 3	Shaker 3	TubulrBel A#	Synth Saw
95	Laser	Fng.EB2.Sld	JD Switch	WD Rim f	TubulrBel B	Digi Breath
96	Siren	Cajon 3	Cajon 3	Mix Kick 1	TubulrBel B	TR808 Cym2
97	AnalogKick 3	Cajon 2	Cajon 2	Mix Kick 2	TubulrBel C	TR808 Conga1
98	Old Kick 2	Cajon 1	Cajon 1	Mix Kick 3	TubulrBel C#	TR808 Conga2
99	Reg.Kick	Gospel Clap	Real Clap	Mix Kick 4	TubulrBel D	TR808 Conga2
100	TR909 Snr 4	Rock Crash 2	Gospel Clap	Mix Kick 5	TubulrBel D#	Cajon 1
101	TR808 Snr 2	Rock Rd Cup	Tibet Cymbal	Mix Clap 1	TubulrBel E	Vint Snr 3
102	Short Snr1	Club FinSnap	Tamborine 1	Wind Chime	TubulrBel f	Door Creak
103	Vint Snr 4	TR909 Snr 6	Tamborine 2	Tibet Cymbal	Church Bell1	Vint.Phone
				Crotale	Church Bell2	Door Creak

# Rhythm Set List

Prst:	013	014	015	016	017	018
User:	013	014	015	016	017	018
Note No.	Limiters Kit	HipHop Kit 1	R&B Kit	HiFi R&B Kit	Machine Kit1	Kit-Euro:POP
28	Dance Kick 1	PlasticKick2	70's Kick	MaxLow Kick2	TR909 Kick 2	TR707 Kick
29	HipHop Kick1	Group Snap	AnalogKick 6	FB Kick	TR909 Kick 4	AnalogKick 1
30	WD CSik	Snr Roll	Urbn Sn Roll	Rough Kick1a	Light Snr	Dirty Snr 6
31	R&B Kick 1	AnalogKick 3	HipHop Kick2	MaxLow Kick1	Mix Kick 5	FB Kick
32	Wild Stick	GoodOld Snr5	R&B ShrtSnr1	Rough Kick3	DR660 Snr	BrushRoll
33	Dance Kick 2	Dist Kick	Old Kick	Rk CmpKick	Mix Kick 2	PlasticKick2
34	Hip PHH	Noise CHH	HipHop CHH	TR909 Kick 5	TR808 PHH	Reg.CHH 2
35	LD Kick	TR707 Kick	EuroHit Kick	Rough Kick1b	AnalogKick 6	Power Kick
C2	R&B Kick 2	Dry Kick 4	TR909 Kick 1	R&B Kick	70's Kick 1	TR909 Kick 6
37	Lo-Bit Sik 2	Jazz Rim	Dry Stick 4	Hard Stick	TR808 Rim	R&B ShrtRim1
38	Wild Stick	Dirty Snr 2	Dirty Snr 2	GoodOld Snr3	Jngl pktSnr1	TR909 Snr 3
39	Dist Clap	Old Clap	Maple Snr	GoodOld Snr4	Funk Clap	TR909 Clap 1
40	DR660 Snr	Vint Snr 4a	Short Snr2	GoodOld Snr2	Jngl pktSnr2	TR909 Snr 4a
41	Reg.F.Tom p	TR909 Tom L	TR808 Tom 1	Lo-Bit Snr 1	MG Attack	Sharp L.Tom2
42	Lo-Bit CHH 2	HipHop CHH 2	TR606 CHH 2	Noise CHH	TR808 CHH 1	TR909 CHH 1
43	Reg.F.Tom f	Deep Tom L	Reg.F.Tom	Jazz Snr	MG Attack	Sharp L.Tom1
44	Lo-Bit CHH 4	Lo-Bit PHH	TR909 CHH 2	Hip PHH	TR808 PHH	TR909 PHH 1
45	Reg.L.Tom	TR909 Tom M	TR808 Tom 2	Lo-Bit Snr 2	MG Blip	Sharp M.Tom
46	Lo-Bit OHH 2	Lo-Bit OHH 2	Lo-Bit OHH 2	Reg.OHH	TR808 OHH 1	TR909 OHH 2
47	Reg.L.TomFlm	Deep Tom M	Reg.M.Tom	Vint Snr 2	MG Blip	Sharp M.Tom
C3	Reg.H.Tom	TR909 Tom H	TR808 Tom 3	WD Snr	Beam HiQ	Sharp H.Tom
49	Crash Cym 1	Crash Cym1 p	Rock Crash 1	TR808 Cym 1	TR606 Cym 2a	TR909 Crash
50	Reg.H.TomFlm	Deep Tom H	Reg.H.Tom	GoodOld Snr6	Beam HiQ	Sharp H.Tom
51	Lo-Bit OHH 1	Rock Crash 1	Splash Cym	TR606 Cym 2	Lo-Bit OHH1a	TR909 Ride
52	TR606 Cym 2	Rock Rd Edge	Rock Rd Edge	White Noise	TR606 Cym 2	China Cymbal
53	Jazz Ride 1	China Cymbal	Concert Cym	Bright Form	Lo-Bit OHH1b	Rock Rd Edge
54	Tamborine 1	Snap	Cheap Clap	CR78 Tamb	CR78 Tamb 1	Tamborine 3
55	TR606 OHH	TR808 Conga2	Snap	SBF Hrd Ld 1	TR606 Cym 2b	Crash Cym1 p
56	Vibraslap	Vint Snr 4	Lo-Bit Snr 2	JD Sm Metal	JD Sm Metal1	Cowbell
57	Mix Kick 2	TR808Cowbell	Wood Block	TR808 Cym 2	Lo-Bit OHH1c	Rock Crash 2
58	Hip PHH	Guiro Long	Shaku Noise	Syn Swt Atk3	Syn Swt Atk3	Vibraslap
59	Mix Kick 2	Guiro 2	Syn Hrd Atk1	TR909 Kick4a	AnalogKick 6	TR606 Cym 2
C4	Rough Kick	Guiro 1	JD MetalWind	TR909 Kick4b	70's Kick 2	Bongo Lo Op
61	Dry Stick	Shaker 3	Maracas	TR808 Rim	R8 Comp Rim	Bongo Hi Op
62	GoodOld Snr5	Noise CHH	Cabasa Up	TR808 Snr 2	Pocket Snr	Conga Hi Mt
63	R8 Clap	Cabasa 2	Cabasa Down	TR909 Clap 2	TR909 Clap 2	Conga Hi Op
64	Jngl pkt Snr	Vibraslap	Cabasa Cut	TR808 Snr 4	Vint Snr 4	Conga Lo Op
65	TR808 Tom	Mix Kick 2	Tamborine 1	TR808 Tom 4	TR606 Tom L	Conga Efx
66	Noise CHH 1	Dist Snr	Tamborine 2	TR808 CHH 1	Dance CHH	Shaker 3
67	TR808 Tom	Sweep Bass	Tamborine 1	TR808 Tom 3	TR606 Tom L	Shaker 2
68	Noise CHH 2	Short Snr1	Triangle Mt	TR808 CHH 2	Lo-Bit CHH 1	CR78 Beat
69	TR606 Tom L1	CR78 CHH	Triangle Op	TR808 Tom 2	TR606 Tom M	Cabasa Cut 1
70	Lo-Bit OHH 2	Shaker 2	Xylo Seq.	TR808 OHH 1	Reg.OHH	Cabasa Cut 2
71	TR606 Tom L2	CR78 Tamb	Philly Hit	TR808 Tom 1	TR606 Tom M	Lo-Bit PHH
C5	TR606 Tom H1	Noise OHH	LoFi Min Hit	Scratch 3	TR606 Tom H	Scratch 7
73	Crash Cym 2	Slight Bell	Vinyl Noise	Scratch 4	TR909 Crash1	Syn Low Atk2
74	TR606 Tom H2	Tibet Cymbal	Cajon 1	Scratch 5	TR606 Tom H	MG Zap 7
75	Jazz Ride 2	Wind Chime	Cajon 2	Scratch 6	Lite OHH 1	Syn Swt Atk1
76	Splash Cym	Scratch 2	Cajon 3	Old Clap	TR909 Crash2	Syn Swt Atk4
77	Rock Rd Edge	Scratch 1	Conga Hi Mt	Hand Clap	Lite OHH 2	Conga Thumb
78	Tamborine 3	Scratch 10	Conga Lo Mt	R8 Clap	CR78 Tamb 2	Triangle 1
79	Guiro Long	Scratch 9	Conga Hi Slp	Cabasa Cut	TR909 Crash	Triangle 2
80	Gospel Clap	Smear Hit 2	Conga Lo Slp	R8 Shaker	JD Sm Metal2	Euro Hit 1
81	Tibet Cymbal	LoFi Min Hit	Conga Hi Op	Tamborine 2	Lite OHH 3	Tao Hit
82	Wind Chime	Thin Beef	Conga Lo Op	Cabasa Down	Syn Swt Atk1	Narrow Hit 2
83	Mix Kick 1	Dist Hit	Conga Slp Op	Cabasa Cut	TR808 OHH 2	Euro Hit 2
C6	Mix Kick 2	Narrow Hit 2	Conga Efx	Tibet Cymbal	808 Maracas	Wind Chime
85	Mix Kick 4	MG Attack	Conga Thumb	Crotale	TR808 Claves	Timpani Roll
86	Vint Snr 1	MG Zap 9	Noise OHH	Slight Bell	Triangle Mt	Crotale
87	Vint Snr 2	Mix Clap 3	Shaker 3	Wind Chime	Triangle Op	R8 Click
88	Vint Snr 3	R8 Shaker	Castanet	Triangle 1	Narrow Hit 2	Metro Bell
89	Vint Snr 4	Cabasa Down	CR78 Beat	Mild CanWave	Euro Hit	MC500 Beep 1
90	Noise CHH	Cabasa Cut	CR78 OHH	Cheap Clap	MG Zap 4	MC500 Beep 2
91	CR78 CHH	MaxLow Kick1	CR78 CHH	JD Plunk	Scratch 1	Atmosphere
92	Noise CHH 3	MaxLow Kick2	Lite OHH	Syn Swt Atk2	MG Zap 1	Agogo Noise
93	Noise OHH 2	Lo-Bit Snr 1	CR78 Tamb	DistGtr Nz 2	TR606 Snr 2	Car Slip
94	Noise OHH 1	Dance CHH	JD Vox Noise	River	Synth Saw	Group Snap
95	Heartbeat	Wild Stick	Guiro 2 Fast	Bubble	Digi Breath	Laser
C7	Scratch 2	MC500 Beep 1	Metro Click	Train Pass	DigiSpectrum	ConcertBD
97	Scratch 5	MC500 Beep 2	Metro Bell	LoFi Min Hit	Shaker 3	AnalogKick 3
98	Scratch 1	Gospel Clap	Wind Chime	Pink Noise	Conga 2H Slp	Old Kick
99	Scratch 4	TR606 Cym	Crotale	Agogo Noise	Cajon 1	Reg.Kick
100	Scratch 6	China Cymbal	Crash Cym1 p	SynVox Nz 1	Vint Snr 3	TR909 Snr 4b
101	Mobile Phone	Rock Crash 2	TR909 Crash	SynVox Nz 2	Door Creak 1	TR808 Snr 2
102	Sweep Bass 1	CR78 OHH	CR78 OHH	R8 Click	Vint.Phone	Vint Snr 4
103	Sweep Bass 2	Concert Cym	Rev.Lite OHH	Syn Swt Atk1	Door Creak 2	Light Snr

# Rhythm Set List

Prst:	019	020	021	022	023	024
User:	019	020	021	022	023	024
Note No.	House Kit	Nu Technica	Machine Kit2	ArtificialKit	Noise Kit	Kick Menu
28	TR909 Kick 3	SH32 Kick 1	AnalogKick 5	TR909 Kick 2	TR909 Kick 2	—
29	SH32 Kick	JD EML 5th 1	AnalogKick6a	AnalogKick 2	TR909 Kick 4	—
30	Urbn Sn Roll	AnalogKick 6	Analog Snr 1	TR808 Snr 5	Urbn SnRoll1	—
31	TR909 Kick 2	TR909 Kick 5	AnalogKick 1a	TR909 Kick 3	TR909 Kick 5	—
32	TR909 Snr 6	Plastic Kc3a	TR808 Snr 4	Vint Snr 3	Door Creak 1	—
33	TR909 Kick 5	R&B Kick	FB Kick	FB Kick	TR909 Kick 1	—
34	TR909 PHH 2	TR707 Kick	TR808 PHH	TR606 Cym 2a	SynSwt Atk7a	—
35	TR909 Kick4a	Plastic Kc3b	AnalogKick6b	AnalogKick 3	Cajon 3a	Reg.Kick p
36	TR909 Kick4b	SH32 Kick 2	AnalogKick6c	TVF Trigger	Cajon 3b	Reg.Kick f
37	TR909 Rim	TR909 Snr 5	R&B ShrtRim2	TR909 Rim	Laser	Reg.Kick ff
38	TR909 Snr 4	Syn Mtl Atk2	TR909 Snr 1	TR909 Snr 1	Door Creak2a	Rock Kick p
39	TR909 Clap 2	Flange Snr	TR707 Clap	Claptail	Train Pass	Rock Kick f
40	TR909 Snr 5	TR909 Snr 3	Lo-Bit Snr 2	TR909 Snr 3	Door Creak2b	Jazz Kick p
41	TR909 Tom L	Dance CHH	Deep Tom L	TR909 Tom L2	Syn Swt AtkL	Jazz Kick mf
42	TR909 CHH 2	TR606DstCHH1	TR606 CHH 1	TR909 CHH 1	SynSwt Atk7b	Jazz Kick f
43	TR909 Tom L	TR909 PHH 2	Deep Tom L	TR909 Tom L1	TR909 Tom L1	Dry Kick 1
44	TR909 PHH 2	TR606 PHH 2a	TR606 PHH 1	TR909 PHH 1	Syn Mtl Atk2	Tight Kick
45	TR909 Tom M	TR909 OHH 1	Deep Tom M	TR909 Tom M2	Syn Swt AtkM	Old Kick
46	TR909 OHH 2	Lite OHH	TR909 OHH 2	TR909 OHH 2	White Noise	Jz Dry Kick
47	TR909 Tom M	Rock Rd Cup	Deep Tom M	TR909 Tom M1	Syn Swt AtkM	Dry Kick 2
48	TR909 Tom H	Syn Hrd Atk4	Deep Tom H	TR909 Tom H2	Syn Swt AtkH	Dry Kick 3
49	TR909 Crash1	MG Zap 7a	Lite OHH	TR909 Crash	Syn Mtl Atk1	Power Kick
50	TR909 Tom H	MG Zap 9	Deep Tom H	TR909 Tom H1	Syn Swt AtkH	R&B Kick L
51	TR909 Ride 1	MG Zap 8	TR808 OHH 1	TR909 Ride	SynLow Atk1a	Rk CmpKick
52	TR909 Crash2	MG Zap 10	TR606 Cym 2a	White Noise1	Crotale 1	Dance Kick
53	TR909 Ride 2	HipHop CHH 2	TR909 Ride 1	CR78 Beat	Laser 1	HipHop Kick1
54	CR78 Tamb	Syn Swt Atk3	CR78 Tamb	Tamborine 3	MG Zap 11	HipHop Kick2
55	MG Zap 4	Reg.PHH	TR606 Cym 2b	Atmosphere	Laser 2	TR909 Kick 1
56	JD Sm Metal	Syn Swt Atk6	JD Sm Metal	Cowbell Mute	MG Zap 4a	TR808 Kick
57	MG Zap 5	HipHop OHH	TR909 Ride 2	Syn Swt Atk1	Digi Loop 1	TR909 Kick 4
58	Syn Swt Atk3	TR909 OHH 2	Syn Swt Atk3	Cowbell	MG Zap 6a	WD Kick mf
59	AnalogKick 2	TR909 R.Crsh	AnalogKick1b	Reverse.Cym	SynLow Atk2a	WD Kick f
60	TR909 Kick 2	TR909 Crash	AnalogKick 4	AnalogKick 5	SynLow Atk2b	WD Kick ff
61	TR909 Rim	Rock Crash 1	Urbn SnRoll1	Metal Vox W1	MG Attack	LD Kick mf
62	TR909 Snr 1	MG Zap 2	Analog Snr 2	Metal Vox W2	Syn Hrd Atk4	LD Kick f
63	TR909 Clap 1	MG Zap 9	Dist Clap	Metal Vox W3	Train Pass	LD Kick ff
64	TR909 Snr 2	Smear Hit 2	Analog Snr 3	White Noise2	Syn Mtl Atk1	TY Kick mf
65	TR909 D.TomL	Low Square	R8 Shaker	White Noise3	Syn Swt AtkL	TY Kick f
66	TR909 CHH 1	JD WoodCrak1	Syn Swt Atk2	TR606 Cym 2b	Syn Swt Atk7	TY Kick ff
67	TR909 D.TomL	Piano Atk Nz	R8 Shaker	MG Blip	Syn Swt AtkL	SF Kick 1
68	TR808 CHH 2	JD WoodCrak2	TR909 PHH 2	MG Blip Rev.	Syn Mtl Atk2	SF Kick 2
69	TR909 D.TomM	DR202 Beep 1	Syn Hrd Atk1	DigiSpectrum	Syn Swt AtkM	MaxLow Kick1
70	TR909 OHH 1	JD WoodCrak3	TR909 OHH 2	Ice Crash	DigiSpectrum	MaxLow Kick2
71	TR909 D.TomM	Syn Pulse 2	SynHrd Atk1a	Metal Vox L2	Syn Swt AtkM	Dist Kick
72	TR909 D.TomH	DR202 Beep 2	SynHrd Atk1b	Thin Beef	Syn Swt AtkH	FB Kick
73	TR909 Crash3	Narrow Hit2a	TR909 Crash	LoFi Min Hit	Digi Loop 1	Rough Kick1
74	TR909 D.TomH	E.Gtr Harm	SynHrd Atk1c	Trance Saw	Syn Swt AtkH	Rough Kick2
75	TR909 Ride 3	Narrow Hit2b	TR909 Ride 3	TB DstSqr	SynLow Atk1b	Rough Kick3
76	TR909 Crash4	Euro Hit	TR909 Crash	Finger Snap	Crotale 2	PlasticKick1
77	TR909 Ride 4	Jazz Lo Tom1	TR909 Ride 1	Conga Slp Op	Laser 3	70's Kick
78	Tamborine 2	TR909 D.TomL	CR78 Tamb	Conga Lo Op	MG Zap 11	AnalogKick 1
79	MG Zap 2	Jazz Lo Tom2	MG Zap 2	Conga Hi Op	Laser 4	PlasticKick2
80	Cowbell Low	TR909 D.TomM	JD Sm Metal	Triangle Mt	MG Zap 4b	PlasticKick3
81	MG Zap 6	Jazz Lo Tom3	MG Zap 6	Triangle Op	Crotale 3	TR909 Kick 2
82	Cowbell Hi	TR909 D.TomH	Syn Swt Atk1	Cabasa Cut	MG Zap 6b	AnalogKick 2
83	MG Zap 7	AnalogKick 3	MG Zap 7	R8 Shaker	Syn Low Atk2	TR909 Kick 3
84	Conga Hi Mt	AnalogKick 5	808 Maracas	AnalogKick 1	808 Maracas	AnalogKick 3
85	Conga Lo Mt	Club Clap	TR808 Claves	PlasticKick2	TR808 Claves	AnalogKick 4
86	Conga Lo Slp	TR808 Snr 7	Triangle Mt	PlasticKick3	Triangle Mt	AnalogKick 5
87	Conga Hi Op	TR808 Snr 3	Triangle Op	TR909 Kick 1	Triangle Op	AnalogKick 6
88	Conga Lo Op	TR909 Snr 6a	Euro Hit	AnalogKick 4	Dry Lo Tom	TR606DstKick
89	Timbale Hi	TR909 CHH 2	Scratch 4	AnalogKick 6	Conga Thumb	TR909 Kick 5
90	Timbale Low	TR606DstCHH2	Brit Strat C	TR909 Snr 2	Funk Gtr	SH32 Kick
91	Agogo Bell H	Dance CHH	Crotale	TR909 Snr 4	Digi Loop 1	TR707 Kick
92	Agogo Bell L	TR606 PHH 2b	MG Zap 4	TR909 Snr 5	MG Zap 4c	TR909 Kick 6
93	Cabasa Down	TR909 OHH 2	Urbn SnRoll2	TR909 Snr 6	Urbn SnRoll2	Mix Kick 1
94	Maracas	TR606 OHH	Calc.Saw	TR808 Snr 1	Sweep Saw	Mix Kick 2
95	Guiro Short	CR78 OHH	White Noise	TR808 Snr 2	White Noise	Mix Kick 3
96	Guiro Long	Juno Sqr HD	Blow Loop	TR808 CHH 1	Monsoon	Mix Kick 4
97	Claves	TR909 Snr 6b	Shaker 2	TR808 OHH 1	Shaker 3	Mix Kick 5
98	Wood Block L	TR808 Kick	Shaker 3	TR909 CHH 2	Scream	Dry Kick 4
99	Wood Block H	JD EML 5th 2	Cajon 1	TR909 OHH 2	Cajon 1	Sweep Bass
100	Triangle Mt	TR707 Clap	Euro Hit	Lite CHH	Euro Hit	Vint Kick
101	Triangle Op	Dist Clap	Laugh	Lite OHH	Laugh	Small Kick
102	Castanet	MG Zap 5	Office Phone	TR606 Cym 2c	ConcertBD	—
103	Whistle	MG Zap 7b	Door Creak	China Cymbal	Timpani	—



# Rhythm Set List

Prst:	025	026	027	028	029	030
User:	025	026	027	028	029	030
Note No.	Snare Menu	Snr/Rim Menu	HiHat Menu	Tom Menu	Clp&Cym&Hit	FX/SFX Menu
28	—	—	—	—	—	—
29	—	—	—	—	—	—
30	—	—	—	—	—	—
31	—	—	—	—	—	—
32	—	—	—	—	—	—
33	—	—	—	—	—	—
34	—	—	—	—	—	—
35	—	—	—	—	—	—
C2 36	Reg.Snr1 p	GoodOld Snr1	Reg.CHH 1 p	Reg.F.Tom p	Hand Clap	MG Zap 1
	Reg.Snr1 mf	GoodOld Snr2	Reg.CHH 1 mf	Reg.F.Tom f	Club Clap	MG Zap 2
37	Reg.Snr1 f	GoodOld Snr3	Reg.CHH 1 f	Reg.L.Tom p	Real Clap	MG Zap 3
38	Reg.Snr1 ff	GoodOld Snr4	Reg.CHH 1 ff	Reg.L.Tom f	Bright Clap	MG Zap 4
39	Reg.Snr2 p	GoodOld Snr5	Reg.CHH 2 mf	Reg.M.Tom p	R8 Clap	MG Zap 5
40	Reg.Snr2 f	GoodOld Snr6	Reg.CHH 2 f	Reg.M.Tom f	Gospel Clap	MG Zap 6
	Reg.Snr2ff	Dirty Snr 1	Reg.CHH 2 ff	Reg.H.Tom p	Amb Clap	MG Zap 7
41	Amb.Snr1 p	Dirty Snr 2	Reg.PHH mf	Reg.H.Tom f	TR808 Clap 1	MG Zap 8
42	Amb.Snr1 f	Dirty Snr 4	Reg.PHH f	Reg.L.TomFlm	TR808 Clap 2	MG Zap 9
43	Amb.Snr2 p	Dirty Snr 5	Reg.OHH mf	Reg.M.TomFlm	TR909 Clap 1	MG Zap 10
44	Amb.Snr2 f	Dirty Snr 6	Reg.OHH f	Reg.H.TomFlm	TR909 Clap 2	MG Zap 11
45	Amb.Snr2 ff	Dirty Snr 7	Reg.OHH ff	Jazz Lo Tom	TR707 Clap	MG Blip
46	Piccolo Snr	Dirty Snr 7	Reg.OHH ff	Jazz Lo Tom	TR707 Clap	MG Blip
47	Maple Snr	Grit Snr 1	Rock.CHH1 mf	Jazz Mid Tom	Cheap Clap	Beam HiQ
C3 48	Reg.Snr Gst	Grit Snr 2	Rock CHH1 f	Jazz Hi Tom	Mix Clap 1	MG Attack
	Sft Snr Gst	Grit Snr 3	Rock CHH2 mf	Jazz Lo Flm	Mix Clap 2	Syn Low Atk1
49	Jazz Snr p	LoBit SnrFlm	Rock CHH2 f	Jazz Mid Flm	Mix Clap 3	Syn Low Atk2
50	Jz Brsh Slap	Lo-Bit Snr 1	Rock OHH	Jazz Hi Flm	Mix Clap 4	Syn Hrd Atk1
51	Jz Brsh Swsh	Dirty Snr 3	Lo-Bit CHH 1	Sharp Lo Tom	Dist Clap	Syn Hrd Atk2
52	Swish&Turn p	Lo-Bit Snr 2	Lo-Bit CHH 2	Sharp Hi Tom	Dist Clap 2	Syn Hrd Atk3
53	Swish&Turn f	Analog Snr 1	Lo-Bit CHH 3	Dry Lo Tom	Crash Cym1 p	Syn Hrd Atk4
54	Concert SD	Tiny Snare	Lo-Bit CHH 4	TR909 Tom	Crash Cym1 f	Syn Mtl Atk1
55	Snr Roll Lp	R&B ShrtSnr1	Lo-Bit CHH 5	TR909 DstTom	Crash Cym 2	Syn Mtl Atk2
56	BrushRoll Lp	TR808 Snr 1	HipHop CHH	TR808 Tom	Rock Crash 1	Syn Swt Atk1
57	WD Snr p	TR808 Snr 2	TR909 CHH 1	TR606 Tom	Rock Crash 2	Syn Swt Atk2
58	WD Snr mf	TR808 Snr 3	TR909 CHH 2	Deep Tom	Splash.Cym	Syn Swt Atk3
C4 60	WD Snr f	TR606 Snr 1	TR808 CHH 1	RR F.Tom mp	Jazz Crash	Syn Swt Atk4
	WD Snr ff	MrchCmp Snr	TR808 CHH 2	RR F.Tom f	Ride Cymbal	Syn Swt Atk5
61	WD Rim p	Reggae Snr	TR606 CHH 1	RR F.Tom ff	Ride Bell	Syn Swt Atk6
62	WD Rim mf	DR660 Snr	TR606 CHH 2	LD L.Tom mf	Rock Rd Cup	Syn Swt Atk7
63	WD Rim f	Jngl pkt Snr	TR606 DstCHH	LD L.Tom f	Rock Rd Edge	R8 Click
64	WD Rim ff	Pocket Snr	Noise CHH	LD L.Tom ff	Jazz Ride p	MC500 Beep 1
65	LD Snr p	Flange Snr	Lite CHH	LD M.Tom mf	Jazz Ride mf	MC500 Beep 2
66	LD Snr mf	Analog Snr 2	CR78 CHH	LD M.Tom f	China Cymbal	DR202 Beep
67	LD Snr f	Analog Snr 3	Dance CHH	LD M.Tom ff	TR909 Crash	JD Switch
68	LD Snr ff	TR909 Snr 1	Lo-Bit PHH	LD H.Tom mf	TR909 Ride	Cutting Nz
69	LD Rim mf	TR909 Snr 2	Hip PHH	LD H.Tom f	Concert Cym1	Vinyl Noise
70	LD Rim f	TR909 Snr 3	TR909 PHH 1	LD H.Tom ff	Concert Cym2	Applause
71	LD Rim ff	TR909 Snr 4	TR909 PHH 2	TY L.Tom mf	TR606 Cym	River
C5 72	TY Snr p	TR909 Snr 5	TR808 PHH	TY L.Tom f	TR808 Cym	Thunder
	TY Snr mf	TR909 Snr 6	TR606 PHH 1	TY L.Tom ff	Reverse Cym	Monsoon
73	TY Snr f	TR808 Snr 4	TR606 PHH 2	TY M.Tom mf	ClassicHseHit	Stream
74	TY Snr ff	Lite Snare	HipHop OHH	TY M.Tom f	Narrow Hit 1	Bubble
75	TY Rim p	TR808 Snr 5	TR909 OHH 1	TY M.Tom ff	Narrow Hit 2	Bird Song
76	TY Rim mf	TR808 Snr 6	TR909 OHH 2	TY H.Tom mf	Euro Hit	Dog Bark
77	TY Rim f	TR606 Snr 2	TR808 OHH 1	TY H.Tom f	Dist Hit	Gallap
78	TY Rim ff	CR78 Snare	TR808 OHH 2	TY H.Tom ff	Thin Beef	Vint.Phone
79	SF Snr p	Urbn Sn Roll	TR606 OHH	SF L.Tom mf	Tao Hit	Office Phone
80	SF Snr mf	Reg.Stick	Lo-Bit OHH 1	SF L.Tom ff	Smear Hit 1	Mobile Phone
81	SF Snr f	Soft Stick	Lo-Bit OHH 2	SF M.Tom mf	Smear Hit 2	Door Creak
82	SF Snr ff	Hard Stick	Lo-Bit OHH 3	SF M.Tom f	LoFi Min Hit	Door Slam
C6 84	SF SnrGst1	Wild Stick	Lite OHH	SF M.Tom ff	Orch. Hit	Car Engine
	SF SnrGst2	R&B ShrtRim1	CR78 OHH	SF H.Tom mf	Punch Hit	Car Slip
85	SF Rim p	R&B ShrtRim2	Noise OHH 1	SF H.Tom f	O'Skool Hit	Car Pass
86	SF Rim mf	WD CSik mf	Noise OHH 2	SF H.Tom ff	Philly Hit	Crash Seq.
87	SF Rim f	WD CSik f	—	RR FT Flm ff	—	Gun Shot
88	SF Rim ff	LD CSik mf	—	SF LT Flm ff	—	Siren
89	Light Snr ff	LD CSik f	—	SF MT Flm f	—	Train Pass
90	Click Snr p	TY CSik mf	—	SF HT Flm p	—	Airplane
91	Click Snr ff	TY CSik f	—	SF HT Flm f	—	Laugh
92	Jazz Snr mf	SfCrsSik p	—	SF HT Flm ff	—	Scream
93	Jazz Snr f	SfCrsSik f	—	—	—	Punch
C7 94	Jazz Rim p	Lo-Bit Sik 1	—	—	—	Heartbeat
	Soft Jz Roll	Lo-Bit Sik 2	—	—	—	Footsteps
95	—	Dry Stick 1	—	—	—	Machine Gun
96	—	Dry Stick 2	—	—	—	Laser
97	—	Dry Stick 3	—	—	—	Thunder Lp
98	—	R8 Comp Rim	—	—	—	Metro Bell
99	—	TR909 Rim	—	—	—	Metro Click
100	—	TR808 Rim	—	—	—	—
101	—	—	—	—	—	—
102	—	—	—	—	—	—
103	—	—	—	—	—	—

# Rhythm Set List

Prst:	031	032
User:	031	032
Note No.	Percussion	ScrH&Vox&Wld
28	Cowbell	—
29	Cowbell Mute	—
30	Cowbell2 Lng	—
31	Cowbell2 Edg	—
32	Cowbell3 mf	—
33	Cowbell3 f	—
34	Wood Block	—
35	Wood Block2H	Scratch 1
36	Wood Block2L	Scratch 2
37	Claves	Scratch 3
38	TR808 Claves	Scratch 4
39	Claves 2	Scratch 5
40	CR78 Beat	Scratch 6
41	Castanet	Scratch 7
42	Whistle	Scratch 9
43	Whistle Long	Scratch 10
44	Whistle Shrt	Aah Formant
45	Bongo Hi Mt	Eeh Formant
46	Bongo Hi Slp	Iih Formant
47	Bongo Lo Slp	Ooh Formant
48	Bongo Hi Op	Uuh Formant
49	Bongo Lo Op	Metal Vox W1
50	Conga Hi Mt	Metal Vox W2
51	Conga Lo Mt	Metal Vox W3
52	Conga Hi Slp	JD Gamelan 1
53	Conga Lo Slp	JD Gamelan 2
54	Conga Hi Op	JD Gamelan 3
55	Conga Lo Op	JD Gamelan 4
56	Conga Slp Op	JD Gamelan 5
57	Conga Efx	JD Gamelan 6
58	Conga Thumb	JD Gamelan 7
59	Conga 2H Op	JD Gamelan 8
60	Conga 2H Mt	JD Gamelan 9
61	Conga 2H Slp	JD Gamelan10
62	Conga 2L Op	JD Gamelan11
63	Conga 2L Mt	JD Gamelan12
64	Timbale 1	Cajon 1
65	Timbale 2	Cajon 2
66	Timbale 3	Cajon 3
67	Timbale 4	Cajon 4
68	Cabasa Up	SprgDrm Hit
69	Cabasa Down	Cuica
70	Cabasa Cut	Cuica 2 Hi
71	Cabasa2	Cuica 2 Low
72	Cabasa2 Cut	—
73	Shaker	—
74	Maracas	—
75	808 Maracas	—
76	R8 Shaker	—
77	Guiro 1	—
78	Guiro 2	—
79	Guiro Long	—
80	Guiro 2 Up	—
81	Guiro 2 Down	—
82	Guiro 2 Fast	—
83	Vibraslap	—
84	Tamborine 1	—
85	Tamborine 2	—
86	Tamborine 3	—
87	Tamborine4 f	—
88	Tamborine4 p	—
89	CR78 Tamb	—
90	Timpani p	—
91	Timpani f	—
92	Timpani Roll	—
93	Timpani Lp	—
94	ConcertBD p	—
95	ConcertBD f	—
96	ConcertBD ff	—
97	ConcertBD Lp	—
98	Triangle 1Op	—
99	Triangle 1Mt	—
100	Triangle 2	—
101	Tibet Cymbal	—
102	Wind Chime	—
103	Crotale	—

# Rhythm Set List

## GM (GM2 Group)

Note No.	001 (PC: 1) GM2 STANDARD	002 (PC: 9) GM2 ROOM	003 (PC: 17) GM2 POWER	004 (PC: 25) GM2 ELECTRIC	005 (PC: 26) GM2 ANALOG	006 (PC: 33) GM2 JAZZ
27	High-Q	High-Q	High-Q	High-Q	High-Q	High-Q
28	Slap	Slap	Slap	Slap	Slap	Slap
29	ScratchPush	ScratchPush	ScratchPush	ScratchPush	ScratchPush	ScratchPush
30	ScratchPull	ScratchPull	ScratchPull	ScratchPull	ScratchPull	ScratchPull
31	Sticks	Sticks	Sticks	Sticks	Sticks	Sticks
32	SquareClick	SquareClick	SquareClick	SquareClick	SquareClick	SquareClick
33	Mtrnm.Click	Mtrnm.Click	Mtrnm.Click	Mtrnm.Click	Mtrnm.Click	Mtrnm.Click
34	Mtrnm. Bell	Mtrnm. Bell	Mtrnm. Bell	Mtrnm. Bell	Mtrnm. Bell	Mtrnm. Bell
35	Mix Kick	Mix Kick	Mix Kick	Mix Kick	Mix Kick	Jazz Kick 2
C2	Standard KK1	Standard KK1	Power Kick1	Elec Kick 1	TR-808 Kick	Jazz Kick 1
37	Side Stick	Side Stick	Side Stick	Side Stick	808 Rimshot	Side Stick
38	Standard SN1	Standard SN1	Dance Snare1	Elec. Snare	808 Snare 1	Standard SN1
39	909 HandClap	909 HandClap	909 HandClap	909 HandClap	909 HandClap	909 HandClap
40	Elec Snare 3	Elec Snare 3	Elec Snare 3	Elec Snare 2	Elec Snare 3	Elec Snare 3
41	Real Tom 6	Room Tom 5	Rock Tom 4	Synth Drum 2	808 Tom 2	Real Tom 6
42	Close HiHat2	Close HiHat2	Close HiHat2	Close HiHat2	TR-808 CHH	Close HiHat2
43	Real Tom 6	Room Tom 5	Rock Tom 4	Synth Drum 2	808 Tom 2	Real Tom 6
44	Pedal HiHat2	Pedal HiHat2	Pedal HiHat2	Pedal HiHat2	808_chh	Pedal HiHat2
45	Real Tom 4	Room Tom 2	Rock Tom 4	Synth Drum 2	808 Tom 2	Real Tom 4
46	Open HiHat2	Open HiHat2	Open HiHat2	Open HiHat2	TR-808 OHH	Open HiHat2
47	Real Tom 4	Room Tom 2	Rock Tom 4	Synth Drum 2	808 Tom 2	Real Tom 4
C3	Real Tom 1	Room Tom 2	Rock Tom 1	Synth Drum 2	808 Tom 2	Real Tom 1
49	Crash Cym.1	Crash Cym.1	Crash Cym.1	Crash Cym.1	808 Crash	Crash Cym.1
50	Real Tom 1	Room Tom 2	Rock Tom 1	Synth Drum 2	808 Tom 2	Real Tom 1
51	Ride Cymbal	Ride Cymbal	Ride Cymbal	Ride Cymbal	Ride Cymbal	Ride Cymbal
52	ChinaCymbal	ChinaCymbal	ChinaCymbal	ReverseCymb	ChinaCymbal	ChinaCymbal
53	Ride Bell	Ride Bell	Ride Bell	Ride Bell	Ride Bell	Ride Bell
54	Tambourine	Tambourine	Tambourine	Tambourine	Tambourine	Tambourine
55	Splash Cym.	Splash Cym.	Splash Cym.	Splash Cym.	Splash Cym.	Splash Cym.
56	Cowbell	Cowbell	Cowbell	Cowbell	808cowbe	Cowbell
57	Crash Cym.2	Crash Cym.2	Crash Cym.2	Crash Cym.2	Crash Cym.2	Crash Cym.2
58	Vibraslap	Vibraslap	Vibraslap	Vibraslap	Vibraslap	Vibraslap
59	Ride Cymbal	Ride Cymbal	Ride Cymbal	Ride Cymbal	Ride Cymbal	Ride Cymbal
C4	Bongo High	Bongo High	Bongo High	Bongo High	Bongo High	Bongo High
61	Bongo Lo	Bongo Lo	Bongo Lo	Bongo Lo	Bongo Lo	Bongo Lo
62	Mute H.Conga	Mute H.Conga	Mute H.Conga	Mute H.Conga	808 Conga	Mute H.Conga
63	Conga Hi Opn	Conga Hi Opn	Conga Hi Opn	Conga Hi Opn	808 Conga	Conga Hi Opn
64	Conga Lo Opn	Conga Lo Opn	Conga Lo Opn	Conga Lo Opn	808 Conga	Conga Lo Opn
65	High Timbale	High Timbale	High Timbale	High Timbale	High Timbale	High Timbale
66	Low Timbale	Low Timbale	Low Timbale	Low Timbale	Low Timbale	Low Timbale
67	Agogo	Agogo	Agogo	Agogo	Agogo	Agogo
68	Agogo	Agogo	Agogo	Agogo	Agogo	Agogo
69	Cabasa	Cabasa	Cabasa	Cabasa	Cabasa	Cabasa
70	Maracas	Maracas	Maracas	Maracas	808marac	Maracas
71	ShrtWhistle	ShrtWhistle	ShrtWhistle	ShrtWhistle	ShrtWhistle	ShrtWhistle
C5	LongWhistle	LongWhistle	LongWhistle	LongWhistle	LongWhistle	LongWhistle
73	Short Guiro	Short Guiro	Short Guiro	Short Guiro	Short Guiro	Short Guiro
74	Long Guiro	Long Guiro	Long Guiro	Long Guiro	Long Guiro	Long Guiro
75	Claves	Claves	Claves	Claves	808clave	Claves
76	Woodblock	Woodblock	Woodblock	Woodblock	Woodblock	Woodblock
77	Woodblock	Woodblock	Woodblock	Woodblock	Woodblock	Woodblock
78	Mute Cuica	Mute Cuica	Mute Cuica	Mute Cuica	Mute Cuica	Mute Cuica
79	Open Cuica	Open Cuica	Open Cuica	Open Cuica	Open Cuica	Open Cuica
80	MuteTriangl	MuteTriangl	MuteTriangl	MuteTriangl	MuteTriangl	MuteTriangl
81	OpenTriangl	OpenTriangl	OpenTriangl	OpenTriangl	OpenTriangl	OpenTriangl
82	Shaker	Shaker	Shaker	Shaker	Shaker	Shaker
83	Jingle Bell	Jingle Bell	Jingle Bell	Jingle Bell	Jingle Bell	Jingle Bell
C6	Bell Tree	Bell Tree	Bell Tree	Bell Tree	Bell Tree	Bell Tree
85	Castanets	Castanets	Castanets	Castanets	Castanets	Castanets
86	Mute Surdo	Mute Surdo	Mute Surdo	Mute Surdo	Mute Surdo	Mute Surdo
87	Open Surdo	Open Surdo	Open Surdo	Open Surdo	Open Surdo	Open Surdo
88	—	—	—	—	—	—

PC: Program Change Number

Bank Select MSB is all 120, LSB is all 0

# Rhythm Set List

## GM (GM2 Group)

Note No.	007 (PC: 41) GM2 BRUSH	008 (PC: 49) GM2 ORCHSTRA	009 (PC: 57) GM2 SFX
27	High-Q	Close HiHat2	—
28	Slap	Pedal HiHat2	—
29	ScratchPush	Open HiHat2	—
30	ScratchPull	Ride Cymbal	—
31	Sticks	Sticks	—
32	SquareClick	SquareClick	—
33	Mtrnm.Click	Mtrnm.Click	—
34	Mtrnm. Bell	Mtrnm. Bell	—
35	Jazz Kick 2	Concert BD	—
36	Jazz Kick 1	ConcertBD Mt	—
37	Side Stick	Side Stick	—
38	Brush Swirl	Concert Snr	—
39	Brush Slap1	Castanets	High-Q
40	Brush Swirl	Concert Snr	Slap
41	Real Tom 6	Timpani	ScratchPush
42	Close HiHat2	Timpani	ScratchPull
43	Real Tom 6	Timpani	Sticks
44	Pedal HiHat2	Timpani	SquareClick
45	Real Tom 4	Timpani	Mtrnm.Click
46	Open HiHat2	Timpani	Mtrnm. Bell
47	Real Tom 4	Timpani	Gt.FretNoiz
48	Real Tom 1	Timpani	Gt.CutNoise
49	Crash Cym.1	Timpani	Gt.CutNoise
50	Real Tom 1	Timpani	String Slap
51	Ride Cymbal	Timpani	Fl.KeyClick
52	ChinaCymbal	Timpani	Laughing
53	Ride Bell	Timpani	Screaming
54	Tambourine	Tambourine	Punch
55	Splash Cym.	Splash Cym.	Heart Beat
56	Cowbell	Cowbell	Footsteps
57	Crash Cym.2	Con.Cymbal2	Footsteps
58	Vibraslap	Vibraslap	Applause
59	Ride Cymbal	Concert Cym.	Creaking
60	Bongo High	Bongo High	Door
61	Bongo Lo	Bongo Lo	Scratch
62	Mute H.Conga	Mute H.Conga	Wind Chimes
63	Conga Hi Opn	Conga Hi Opn	Car-Engine
64	Conga Lo Opn	Conga Lo Opn	Car-Stop
65	High Timbale	High Timbale	Car-Pass
66	Low Timbale	Low Timbale	Car-Crash
67	Agogo	Agogo	Siren
68	Agogo	Agogo	Train
69	Cabasa	Cabasa	Jetplane
70	Maracas	Maracas	Helicopter
71	ShrtWhistle	ShrtWhistle	Starship
72	LongWhistle	LongWhistle	Gun Shot
73	Short Guiro	Short Guiro	Machine Gun
74	Long Guiro	Long Guiro	Lasergun
75	Claves	Claves	Explosion
76	Woodblock	Woodblock	Dog
77	Woodblock	Woodblock	HorseGallop
78	Mute Cuica	Mute Cuica	Bird
79	Open Cuica	Open Cuica	Rain
80	MuteTriangl	MuteTriangl	Thunder
81	OpenTriangl	OpenTriangl	Wind
82	Shaker	Shaker	Seashore
83	Jingle Bell	Jingle Bell	Stream
84	Bell Tree	Bell Tree	Bubble
85	Castanets	Castanets	—
86	Mute Surdo	Mute Surdo	—
87	Open Surdo	Open Surdo	—
88	—	Applause	—

PC: Program Change Number

Bank Select MSB is all 120, LSB is all 0

# Waveform List

In waveform numbers 0001–0027 and 0061-0087, note numbers 91–108 are set to Damper Free in order to accurately reproduce the characteristics of an acoustic piano.

No.	Wave Name	No.	Wave Name	No.	Wave Name	No.	Wave Name	No.	Wave Name
001	HM-Pno*mpA L	081	Pop P*ff A M	161	Wurly DI f A	241	Positive '8	321	Sitar Drn A
002	HM-Pno*mpA R	082	Pop P*ff B L	162	Wurly DI f B	242	Pipe Organ	322	Sitar Drn B
003	HM-Pno*mpA M	083	Pop P*ff B R	163	Wurly DI f C	243	Cathedr Org	323	Sitar Drn C
004	HM-Pno*mpB L	084	Pop P*ff B M	164	Wurly DI f fA	244	Brtn.Gtr p A	324	E.Sitar A
005	HM-Pno*mpB R	085	Pop P*ff C L	165	Wurly DI f fB	245	Brtn.Gtr p B	325	E.Sitar B
006	HM-Pno*mpB M	086	Pop P*ff C R	166	Wurly DI f fC	246	Brtn.Gtr p C	326	E.Sitar C
007	HM-Pno*mpC L	087	Pop P*ff C M	167	Wurly mp A	247	Brtn.Gtr mfA	327	Santur A
008	HM-Pno*mpC R	088	Pop P mp A L	168	Wurly mp B	248	Brtn.Gtr mfB	328	Santur B
009	HM-Pno*mpC M	089	Pop P mp A R	169	Wurly mp C	249	Brtn.Gtr mfC	329	Santur C
010	HM-Pno*mfA L	090	Pop P mp A M	170	Wurly mf A	250	Brtn.Gtr f fA	330	Dulcimer A
011	HM-Pno*mfA R	091	Pop P mp B L	171	Wurly mf B	251	Brtn.Gtr f fB	331	Dulcimer B
012	HM-Pno*mfA M	092	Pop P mp B R	172	Wurly mf C	252	Brtn.Gtr f fC	332	Dulcimer C
013	HM-Pno*mfB L	093	Pop P mp B M	173	Wurly ff A	253	Brtn.GtrSldA	333	Shamisen A
014	HM-Pno*mfB R	094	Pop P mp C L	174	Wurly ff B	254	Brtn.GtrSldB	334	Shamisen B
015	HM-Pno*mfB M	095	Pop P mp C R	175	Wurly ff C	255	Brtn.GtrSldC	335	Shamisen C
016	HM-Pno*mfC L	096	Pop P mp C M	176	Soft SA EP A	256	Nylon Gtr1 A	336	Koto A
017	HM-Pno*mfC R	097	Pop P f A L	177	Soft SA EP B	257	Nylon Gtr1 B	337	Koto B
018	HM-Pno*mfC M	098	Pop P f A R	178	Soft SA EP C	258	Nylon Gtr1 C	338	Koto C
019	HM-Pno*f A L	099	Pop P f A M	179	Hard SA EP A	259	Nylon Gtr2 A	339	FatAc.Bs p A
020	HM-Pno*f A R	100	Pop P f B L	180	Hard SA EP B	260	Nylon Gtr2 B	340	FatAc.Bs p B
021	HM-Pno*f A M	101	Pop P f B R	181	Hard SA EP C	261	Nylon Gtr2 C	341	FatAc.Bs p C
022	HM-Pno*f B L	102	Pop P f B M	182	SA E.Piano A	262	Bright Gtr A	342	FatAc.Bs f A
023	HM-Pno*f B R	103	Pop P f C L	183	SA E.Piano B	263	Bright Gtr B	343	FatAc.Bs f B
024	HM-Pno*f B M	104	Pop P f C R	184	SA E.Piano C	264	Bright Gtr C	344	FatAc.Bs f C
025	HM-Pno*f C L	105	Pop P f C M	185	80's E.Pno 1	265	Ac.Gtr mp A	345	Ac.Bass A
026	HM-Pno*f C R	106	Pop P ff A L	186	80's E.Pno 2	266	Ac.Gtr mp B	346	Ac.Bass B
027	HM-Pno*f C M	107	Pop P ff A R	187	80's E.Pno1f	267	Ac.Gtr mp C	347	Ac.Bass C
028	HM-Pno mpA L	108	Pop P ff A M	188	80's E.Pno2f	268	Ac.Gtr mf A	348	Fng.EB1 mf A
029	HM-Pno mpA R	109	Pop P ff B L	189	Hard E.Pno	269	Ac.Gtr mf B	349	Fng.EB1 mf B
030	HM-Pno mpA M	110	Pop P ff B R	190	Celesta	270	Ac.Gtr mf C	350	Fng.EB1 mf C
031	HM-Pno mpB L	111	Pop P ff B M	191	Music Box	271	Ac.Gtr ff A	351	Fng.EB1 ff A
032	HM-Pno mpB R	112	Pop P ff C L	192	ClavDB Brt A	272	Ac.Gtr ff B	352	Fng.EB1 ff B
033	HM-Pno mpB M	113	Pop P ff C R	193	ClavDB Brt B	273	Ac.Gtr ff C	353	Fng.EB1 ff C
034	HM-Pno mpC L	114	Pop P ff C M	194	ClavDB Brt C	274	Ac.Gtr Sld A	354	Fng.EB2 mf A
035	HM-Pno mpC R	115	JD Piano A	195	Reg.Clav A	275	Ac.Gtr Sld B	355	Fng.EB2 mf B
036	HM-Pno mpC M	116	JD Piano B	196	Reg.Clav B	276	Ac.Gtr Sld C	356	Fng.EB2 mf C
037	HM-Pno mfA L	117	JD Piano C	197	Reg.Clav C	277	Ac.Gtr Hrm A	357	Fng.EB2 f A
038	HM-Pno mfA R	118	Piano Atk Nz	198	Retro Clav A	278	Ac.Gtr Hrm B	358	Fng.EB2 f B
039	HM-Pno mfA M	119	MKS Piano A	199	Retro Clav B	279	Ac.Gtr Hrm C	359	Fng.EB2 f C
040	HM-Pno mfB L	120	MKS Piano B	200	Retro Clav C	280	Jazz Gtr A	360	FngrCmp Bs A
041	HM-Pno mfB R	121	MKS Piano C	201	Tight Clav A	281	Jazz Gtr B	361	FngrCmp Bs B
042	HM-Pno mfB M	122	Vint.EP pp A	202	Tight Clav B	282	Jazz Gtr C	362	FngrCmp Bs C
043	HM-Pno mfC L	123	Vint.EP pp B	203	Tight Clav C	283	Clean Gtr A	363	Finger Bs A
044	HM-Pno mfC R	124	Vint.EP pp C	204	Hard Clav A	284	Clean Gtr B	364	Finger Bs B
045	HM-Pno mfC M	125	Vint.EP mp A	205	Hard Clav B	285	Clean Gtr C	365	Finger Bs C
046	HM-Pno f A L	126	Vint.EP mp B	206	Hard Clav C	286	Clr Mt Gtr A	366	P.Bass
047	HM-Pno f A R	127	Vint.EP mp C	207	ClvMtrS DB f	287	Clr Mt Gtr B	367	ThumbMfBs pA
048	HM-Pno f A M	128	Vint.EP f A	208	HarpSi A	288	Clr Mt Gtr C	368	ThumbMfBs pB
049	HM-Pno f B L	129	Vint.EP f B	209	HarpSi B	289	E.Gtr Ld	369	ThumbMfBs pC
050	HM-Pno f B R	130	Vint.EP f C	210	HarpSi C	290	Brt Strat A	370	Fretlss Bs A
051	HM-Pno f B M	131	Vint.EP ff A	211	JLOrg Slow L	291	Brt Strat B	371	Fretlss Bs B
052	HM-Pno f C L	132	Vint.EP ff B	212	JLOrg Slow R	292	Brt Strat C	372	Fretlss Bs C
053	HM-Pno f C R	133	Vint.EP ff C	213	JLOrg Fast L	293	FstPick70s A	373	Fretlss SftA
054	HM-Pno f C M	134	Stage EP p A	214	JLOrg Fast R	294	FstPick70s B	374	Fretlss SftB
055	HM-Pno mp Lt+	135	Stage EP p B	215	JD Full Draw	295	FstPick70s C	375	Fretlss SftC
056	HM-Pno mp Rt+	136	Stage EP p C	216	Org Basic 1	296	Funk Gtr A	376	Pick EB f A
057	HM-Pno mf Lt+	137	Stage EP f A	217	Org Basic 2	297	Funk Gtr B	377	Pick EB f B
058	HM-Pno mf Rt+	138	Stage EP f B	218	Ballad Org	298	Funk Gtr C	378	Pick EB f C
059	HM-Pno f Lt+	139	Stage EP f C	219	3rd Perc Org	299	Funk MtGtr A	379	Pick Bass
060	HM-Pno f Rt+	140	Tine EP p A	220	Perc Organ	300	Funk MtGtr B	380	Slp.E.BassA
061	Pop P*mp A L	141	Tine EP p B	221	Rock Organ A	301	Funk MtGtr C	381	Slp.E.BassB
062	Pop P*mp A R	142	Tine EP p C	222	Rock Organ B	302	Nasty Gtr	382	Slp.E.BassC
063	Pop P*mp A M	143	Tine EP mf A	223	Rock Organ C	303	Overdrive A	383	Slp.EB HO A
064	Pop P*mp B L	144	Tine EP mf B	224	RtryOrg1 A L	304	Overdrive C	384	Slp.EB HO B
065	Pop P*mp B R	145	Tine EP mf C	225	RtryOrg1 A R	305	Distortion A	385	Slp.EB HO C
066	Pop P*mp B M	146	Tine EP ff A	226	RtryOrg1 B L	306	Distortion B	386	Pul.E.BassA
067	Pop P*mp C L	147	Tine EP ff B	227	RtryOrg1 B R	307	Distortion C	387	Pul.E.BassB
068	Pop P*mp C R	148	Tine EP ff C	228	RtryOrg1 C L	308	Dist Chord A	388	Pul.E.BassC
069	Pop P*mp C M	149	Dyno EP mp A	229	RtryOrg1 C R	309	Dist Chord B	389	Pul.EB HO A
070	Pop P* f A L	150	Dyno EP mp B	230	RtryOrg2 A L	310	Dist Chord C	390	Pul.EB HO B
071	Pop P* f A R	151	Dyno EP mp C	231	RtryOrg2 A R	311	E.Gtr Harm	391	Pul.EB HO C
072	Pop P* f A M	152	Dyno EP mf A	232	RtryOrg2 B L	312	Harp A	392	Slap Bass
073	Pop P* f B L	153	Dyno EP mf B	233	RtryOrg2 B R	313	Harp B	393	Slap +Pull 1
074	Pop P* f B R	154	Dyno EP mf C	234	RtryOrg2 C L	314	Harp C	394	Slap +Pull 2
075	Pop P* f B M	155	Dyno EP ff A	235	RtryOrg2 C R	315	Banjo A	395	Slap +Pull 3
076	Pop P* f C L	156	Dyno EP ff B	236	LoFi RtryOrg	316	Banjo B	396	Jz Slap Bass
077	Pop P* f C R	157	Dyno EP ff C	237	Vint.Org 1	317	Banjo C	397	Jz Slp+Pull1
078	Pop P* f C M	158	Wurly DI p A	238	Vint.Org 2	318	Sitar A	398	Jz Slp+Pull2
079	Pop P*ff A L	159	Wurly DI p B	239	Vint.Org 3	319	Sitar B	399	Jz Slp+Pull3
080	Pop P*ff A R	160	Wurly DI p C	240	Vint.Org 4	320	Sitar C	400	Jungle Bass

# Waveform List

No.	Wave Name	No.	Wave Name	No.	Wave Name	No.	Wave Name	No.	Wave Name
401	Garage Bass	481	Trumpet B	561	JV Strings R	641	Jazz Doos B	721	TB DstSqr 1C
402	SH-101 Bs A	482	Trumpet C	562	JV Strings A	642	Jazz Doos C	722	Dist SquareA
403	SH-101 Bs B	483	Wide Tp A	563	JV Strings C	643	Jz Doos Lp A	723	Dist SquareB
404	SH-101 Bs C	484	Wide Tp B	564	F.Str mf A L	644	Jz Doos Lp B	724	Dist SquareC
405	Organ Bass	485	Wide Tp C	565	F.Str mf A R	645	Jz Doos Lp C	725	Juno Pls HD
406	MG Bass 1 A	486	Mute Tp A	566	F.Str mf B L	646	Gospel Hum A	726	JP8 Pls 10HD
407	MG Bass 1 B	487	Mute Tp B	567	F.Str mf B R	647	Gospel Hum B	727	JP8 Pls 15HD
408	MG Bass 1 C	488	Mute Tp C	568	F.Str mf C L	648	Gospel Hum C	728	JP8 Pls 25HD
409	MG Bass 2	489	Trombone A	569	F.Str mf C R	649	Soprano Vox	729	JP8 Pls 30HD
410	MG Bass 3	490	Trombone B	570	F.Str mf lpl	650	Kalimba	730	JP8 Pls 40HD
411	MC Bass A	491	Trombone C	571	F.Str mf lpr	651	JD Klmba Atk	731	JP8 Pls 45HD
412	MC Bass B	492	Tbn mf A	572	F.Str ff A L	652	JD Wood Crak	732	Syn Pulse 1
413	MC Bass C	493	Tbn mf B	573	F.Str ff A R	653	JD Gamelan 1	733	Syn Pulse 2
414	Atk Syn Bass	494	Tbn mf C	574	F.Str ff B L	654	JD Gamelan 2	734	SH-1000 Puls
415	Flute A	495	Tuba A	575	F.Str ff B R	655	JD Lag Drum	735	700 Triangle
416	Flute B	496	Tuba B	576	F.Str ff C L	656	JD Xylo	736	Syn Triangle
417	Flute C	497	Tuba C	577	F.Str ff C R	657	Marimba	737	JD Triangle
418	Piccolo A	498	Sft F.Horn A	578	F.Str ff lpl	658	Vibraphone	738	VS-Triangle
419	Piccolo B	499	Sft F.Horn B	579	F.Str ff lpr	659	Glocken	739	Mild Form
420	Piccolo C	500	Sft F.Horn C	580	F.StrStacA L	660	Steel Drums	740	VS-Ramp
421	Pan Flute	501	French Hrn A	581	F.StrStacA R	661	D-50 Bell A	741	Sync Sweep
422	Shakuhachi	502	French Hrn C	582	F.StrStacB L	662	D-50 Bell B	742	Sine
423	JD Fl Push	503	XP Horn A	583	F.StrStacB R	663	D-50 Bell C	743	JD Fine Wine
424	Clarinet A	504	XP Horn B	584	F.StrStacC L	664	D-50 Bell Lp	744	Digi Loop
425	Clarinet B	505	F.HornSect A	585	F.StrStacC R	665	Agogo Bell	745	JD MetalWind
426	Clarinet C	506	F.HornSect B	586	ChmbrStrAtkA	666	Agogo 2 Hi	746	Atmosphere
427	Oboe Mezzo A	507	F.HornSect C	587	ChmbrStrAtkB	667	Agogo 2 Low	747	DigiSpectrum
428	Oboe Mezzo B	508	Tp Section A	588	ChmbrStrAtkC	668	Finger Bell	748	JD Vox Noise
429	Oboe Mezzo C	509	Tp Section B	589	ChmbrStrRevA	669	JD Cowbell	749	SynVox Noise
430	Oboe Forte A	510	Tp Section C	590	ChmbrStrRevB	670	Tubular Bell	750	Shaku Noise
431	Oboe Forte B	511	OctBrs p A L	591	ChmbrStrRevC	671	Church Bell	751	Digi Breath
432	Oboe Forte C	512	OctBrs p A R	592	Vls Pizz A	672	Mild CanWave	752	Agogo Noise
433	E.Horn A	513	OctBrs p B L	593	Vls Pizz B	673	JD Crystal	753	Vinyl Noise
434	E.Horn B	514	OctBrs p B R	594	Vls Pizz C	674	Bell Organ	754	White Noise
435	E.Horn C	515	OctBrs p C L	595	VlsPizzRev A	675	Old DigiBell	755	Pink Noise
436	Bassoon A	516	OctBrs p C R	596	VlsPizzRev B	676	JD Bell Wave	756	Aah Formant
437	Bassoon B	517	OctBrs f A L	597	VlsPizzRev C	677	TinyBellWave	757	Eeh Formant
438	Bassoon C	518	OctBrs f A R	598	Vcs Pizz A	678	Vib Wave	758	lih Formant
439	Recorder A	519	OctBrs f B L	599	Vcs Pizz B	679	JD Bri Digi	759	Ooh Formant
440	Recorder B	520	OctBrs f B R	600	Vcs Pizz C	680	Bagpipe	760	Uuh Formant
441	Recorder C	521	OctBrs f C L	601	Unison Saw A	681	Digital Vox	761	Metal Vox W1
442	SopranoSax A	522	OctBrs f C R	602	Unison Saw B	682	JD WallyWave	762	Metal Vox L1
443	SopranoSax B	523	XP Brass	603	Unison Saw C	683	JD Brusky Lp	763	Metal Vox W2
444	SopranoSax C	524	OrchUnis A L	604	Super Saw A	684	Bright Form	764	Metal Vox L2
445	Alto Sax Vib	525	OrchUnis A R	605	Super Saw B	685	JD Nasty	765	Metal Vox W3
446	Soft Alto A	526	OrchUnis B L	606	Super Saw C	686	JD Spark Vox	766	Metal Vox L3
447	Soft Alto B	527	OrchUnis B R	607	Trance Saw A	687	JD Cutters	767	JD Rattles
448	Soft Alto C	528	OrchUnis C L	608	Trance Saw B	688	SBF Hrd Ld	768	Xylo Seq.
449	Wide Sax A	529	OrchUnis C R	609	Trance Saw C	689	JD EML 5th	769	JD Anklungs
450	Wide Sax B	530	Violin F A	610	Warm Pad A	690	Juno Saw HD	770	JD Shami
451	Wide Sax C	531	Violin F B	611	Warm Pad B	691	TB303 Saw HD	771	SynBassClick
452	BreathySax A	532	Violin F C	612	Warm Pad C	692	Custm Saw HD	772	JD EP Atk
453	BreathySax B	533	Violin Vib A	613	OB2 Pad 1 A	693	MG Saw HD	773	Key On Click
454	BreathySax C	534	Violin Vib B	614	OB2 Pad 1 B	694	DigitalSawHD	774	Org Click 1
455	TenorBreathy	535	Violin Vib C	615	OB2 Pad 1 C	695	P5 Saw HD	775	Org Click 2
456	Tenor Sax A	536	Cello f A	616	OB2 Pad 2 A	696	Calc.Saw	776	Org Click 3
457	Tenor Sax B	537	Cello f B	617	OB2 Pad 2 B	697	Calc.Saw inv	777	Org Click 4
458	Tenor Sax C	538	Cello f C	618	OB2 Pad 2 C	698	Synth Saw	778	Org Click 5
459	Bari.Sax 1 A	539	Cello Vib A	619	D-50 HeavenA	699	JD Syn Saw	779	JD Sm Metal
460	Bari.Sax 1 B	540	Cello Vib B	620	D-50 HeavenB	700	JD Fat Saw	780	Ice Crash
461	Bari.Sax 1 C	541	Cello Vib C	621	D-50 HeavenC	701	JP-8 Saw	781	JD Switch
462	Bari.Sax 2 A	542	VI Sect. A L	622	SBF Vox A	702	D-50 Saw	782	JD Tuba Slap
463	Bari.Sax 2 B	543	VI Sect. A R	623	SBF Vox B	703	SH-1000 Saw	783	JD Plink
464	Bari.Sax 2 C	544	VI Sect. B L	624	SBF Vox C	704	SH-2 Saw	784	JD Plunk
465	Musette	545	VI Sect. B R	625	Syn Vox 1 A	705	LA-Saw	785	TVF Trigger
466	Accord 4' A	546	VI Sect. C L	626	Syn Vox 1 B	706	Air Wave	786	Hi Q
467	Accord 4' B	547	VI Sect. C R	627	Syn Vox 1 C	707	GR-300 Saw 1	787	Slap
468	Accord 4' C	548	Vc Sect. A L	628	Syn Vox 2 A	708	GR-300 Saw 2	788	Stick
469	Accord 8' A	549	Vc Sect. A R	629	Syn Vox 2 B	709	TB Dst Saw A	789	Click
470	Accord 8' B	550	Vc Sect. B L	630	Syn Vox 2 C	710	TB Dst Saw B	790	Cutting Nz
471	Accord 8' C	551	Vc Sect. B R	631	Female Ahs A	711	TB Dst Saw C	791	Ac.Bass Body
472	Accord PadNz	552	Vc Sect. C L	632	Female Ahs B	712	Juno Sqr HD	792	Flute Pad Nz
473	Harmonica A	553	Vc Sect. C R	633	Female Ahs C	713	P5 Sqr HD	793	Applause
474	Harmonica B	554	Full Str A L	634	Female Oos A	714	Fat Square	794	River
475	Harmonica C	555	Full Str A R	635	Female Oos B	715	JP-8 Square	795	Thunder
476	Blues G-harp	556	Full Str B L	636	Female Oos C	716	SH-2 Square	796	Monsoon
477	Flugel A	557	Full Str B R	637	Male Aahs A	717	TB303 Sqr HD	797	Stream
478	Flugel B	558	Full Str C L	638	Male Aahs B	718	LA-Square	798	Bubble
479	Flugel C	559	Full Str C R	639	Male Aahs C	719	TB DstSqr 1A	799	Bird Song
480	Trumpet A	560	JV Strings L	640	Jazz Doos A	720	TB DstSqr 1B	800	Dog Bark

# Waveform List

No.	Wave Name	No.	Wave Name	No.	Wave Name	No.	Wave Name	No.	Wave Name
801	Gallop	881	Syn Mtl Atk1	961	SH32 Kick	1041	Reg.Snr1 f L	1121	TR808 Snr 3
802	Vint.Phone	882	Syn Mtl Atk2	962	TR707 Kick	1042	Reg.Snr1 f R	1122	TR808 Snr 4
803	Office Phone	883	Syn Swt Atk1	963	TR909 Kick 6	1043	Reg.Snr1ff L	1123	Lite Snare
804	Mobile Phone	884	Syn Swt Atk2	964	Mix Kick 1 L	1044	Reg.Snr1ff R	1124	TR808 Snr 5
805	Door Creak	885	Syn Swt Atk3	965	Mix Kick 1 R	1045	Reg.Snr2 p L	1125	TR808 Snr 6
806	Door Slam	886	Syn Swt Atk4	966	Slam	1046	Reg.Snr2 p R	1126	TR606 Snr 1
807	Car Engine	887	Syn Swt Atk5	967	Mix Kick 2 R	1047	Reg.Snr2 f L	1127	TR606 Snr 2
808	Car Slip	888	Syn Swt Atk6	968	Mix Kick 3	1048	Reg.Snr2 f R	1128	CR78 Snare
809	Car Pass	889	Syn Swt Atk7	969	Mix Kick 4	1049	Reg.Snr2ff L	1129	Urbn Sn Roll
810	Crash Seq.	890	WD Kick mf L	970	Mix Kick 5	1050	Reg.Snr2ff R	1130	Vint Snr 1
811	Gun Shot	891	WD Kick mf R	971	Dry Kick 4	1051	Amb.Snr1 p L	1131	Vint Snr 2
812	Siren	892	WD Kick f L	972	Small Kick	1052	Amb.Snr1 p R	1132	Vint Snr 3
813	Train Pass	893	WD Kick f R	973	Vint Kick	1053	Amb.Snr1 f L	1133	Vint Snr 4
814	Airplane	894	WD Kick ff L	974	Sweep Bass	1054	Amb.Snr1 f R	1134	Dist Snr
815	Helicopter	895	WD Kick ff R	975	WD Snr p L	1055	Amb.Snr2 p L	1135	Short Snr1
816	Space Voyage	896	LD Kick mf L	976	WD Snr p R	1056	Amb.Snr2 p R	1136	Short Snr2
817	Blow Loop	897	LD Kick mf R	977	WD Snr mf L	1057	Amb.Snr2 f L	1137	WD CSik mf L
818	Laugh	898	LD Kick f L	978	WD Snr mf R	1058	Amb.Snr2 f R	1138	WD CSik mf R
819	Scream	899	LD Kick f R	979	WD Snr f L	1059	Piccolo Snr	1139	WD CSik f L
820	Punch	900	LD Kick ff L	980	WD Snr f R	1060	Maple Snr	1140	WD CSik f R
821	Heartbeat	901	LD Kick ff R	981	WD Snr ff L	1061	Light Snr ff	1141	LD CSik mf L
822	Footstep	902	TY Kick mf L	982	WD Snr ff R	1062	Click Snr p	1142	LD CSik mf R
823	Machine Gun	903	TY Kick mf R	983	WD Rim p L	1063	Click Snr ff	1143	LD CSik f L
824	Laser	904	TY Kick f L	984	WD Rim p R	1064	SF SnrGst1 L	1144	LD CSik f R
825	Thunder Lp	905	TY Kick f R	985	WD Rim mf L	1065	SF SnrGst1 R	1145	TY CSik mf L
826	Ac.Bass Nz	906	TY Kick ff L	986	WD Rim mf R	1066	SF SnrGst2 L	1146	TY CSik mf R
827	E.Bass Nz 1	907	TY Kick ff R	987	WD Rim f L	1067	SF SnrGst2 R	1147	TY CSik f L
828	E.Bass Nz 2	908	SF Kick 1 L	988	WD Rim f R	1068	Reg.SnrGst L	1148	TY CSik f R
829	E.Bass Slide	909	SF Kick 1 R	989	WD Rim ff L	1069	Reg.SnrGst R	1149	SF CSik p L
830	Eng.EB2 Sld	910	SF Kick 2 L	990	WD Rim ff R	1070	Sft Snr Gst	1150	SF CSik p R
831	DistGtr Nz 1	911	SF Kick 2 R	991	LD Snr p L	1071	Jazz Snr p	1151	SF CSik f L
832	DistGtr Nz 2	912	Reg.Kick p L	992	LD Snr p R	1072	Jazz Snr mf	1152	SF CSik f R
833	DistGtr Nz 3	913	Reg.Kick p R	993	LD Snr mf L	1073	Jazz Snr f	1153	Reg.Stick L
834	Gtr Fret Nz1	914	Reg.Kick f L	994	LD Snr mf R	1074	Jazz Rim p	1154	Reg.Stick R
835	Gtr Fret Nz2	915	Reg.Kick f R	995	LD Snr f L	1075	Jz Brsh Slap	1155	Soft Stick
836	ClassichseHt	916	Reg.Kick ffl	996	LD Snr f R	1076	Jz Brsh Swsh	1156	Hard Stick
837	Narrow Hit 1	917	Reg.Kick ffr	997	LD Snr ff L	1077	Swish&Turn p	1157	Wild Stick
838	Narrow Hit 2	918	Rock Kick p	998	LD Snr ff R	1078	Swish&Turn f	1158	Lo-Bit Stk 1
839	Euro Hit	919	Rock Kick f	999	LD Rim mf L	1079	Snr Roll Lp	1159	Lo-Bit Stk 2
840	Dist Hit	920	Jazz Kick p	1000	LD Rim mf R	1080	BrushRoll Lp	1160	Dry Stick 1
841	Thin Beef	921	Jazz Kick mf	1001	LD Rim f L	1081	Soft Jz Roll	1161	Dry Stick 2
842	Tao Hit	922	Jazz Kick f	1002	LD Rim f R	1082	Concert SD	1162	Dry Stick 3
843	Smear Hit 1	923	Dry Kick 1	1003	LD Rim ff L	1083	GoodOld Snr1	1163	R8 Comp Rim
844	Smear Hit 2	924	Tight Kick	1004	LD Rim ff R	1084	GoodOld Snr2	1164	R&B ShrtRim1
845	LoFi Min Hit	925	Old Kick	1005	TY Snr p L	1085	GoodOld Snr3	1165	R&B ShrtRim2
846	Orch. Hit	926	Jz Dry Kick	1006	TY Snr p R	1086	GoodOld Snr4	1166	TR909 Rim
847	Punch Hit	927	Dry Kick 2	1007	TY Snr mf L	1087	GoodOld Snr5	1167	TR808 Rim
848	O'Skool Hit	928	Dry Kick 3	1008	TY Snr mf R	1088	GoodOld Snr6	1168	LD L.Tom mf
849	Philly Hit	929	Power Kick	1009	TY Snr f L	1089	Dirty Snr 1	1169	LD L.Tom f
850	Scratch 1	930	R&B Kick L	1010	TY Snr f R	1090	Dirty Snr 2	1170	LD L.Tom ff
851	Scratch 2	931	R&B Kick R	1011	TY Snr ff L	1091	Dirty Snr 3	1171	LD M.Tom mf
852	Scratch 3	932	Rk CmpKick L	1012	TY Snr ff R	1092	Dirty Snr 4	1172	LD M.Tom f
853	Scratch 4	933	Rk CmpKick R	1013	TY Rim p L	1093	Dirty Snr 5	1173	LD M.Tom ff
854	Scratch 5	934	MaxLow Kick1	1014	TY Rim p R	1094	Dirty Snr 6	1174	LD H.Tom mf
855	Scratch 6	935	MaxLow Kick2	1015	TY Rim mf L	1095	Dirty Snr 7	1175	LD H.Tom f
856	Scratch 7	936	Dist Kick	1016	TY Rim mf R	1096	Grit Snr 1	1176	LD H.Tom ff
857	Scratch 9	937	FB Kick	1017	TY Rim f L	1097	Grit Snr 2	1177	TY L.Tom mf
858	Scratch 10	938	Rough Kick1	1018	TY Rim f R	1098	Grit Snr 3	1178	TY L.Tom f
859	Scratch Push	939	Rough Kick2	1019	TY Rim ff L	1099	LoBit SnrFlm	1179	TY L.Tom ff
860	Scratch Pull	940	Rough Kick3	1020	TY Rim ff R	1100	Lo-Bit Snr 1	1180	TY M.Tom mf
861	MG Zap 1	941	PlasticKick1	1021	SF Snr p L	1101	Lo-Bit Snr 2	1181	TY M.Tom f
862	MG Zap 2	942	70's Kick	1022	SF Snr p R	1102	MrchCmp Snr	1182	TY M.Tom ff
863	MG Zap 3	943	Dance Kick	1023	SF Snr mf L	1103	Reggae Snr	1183	TY H.Tom mf
864	MG Zap 4	944	HipHop Kick1	1024	SF Snr mf R	1104	DR660 Snr	1184	TY H.Tom f
865	MG Zap 5	945	HipHop Kick2	1025	SF Snr f L	1105	Jngl pkt Snr	1185	TY H.Tom ff
866	MG Zap 6	946	AnalogKick 1	1026	SF Snr f R	1106	Pocket Snr	1186	RR F.Tom mp
867	MG Zap 7	947	PlasticKick2	1027	SF Snr ff L	1107	Flange Snr	1187	RR F.Tom f
868	MG Zap 8	948	PlasticKick3	1028	SF Snr ff R	1108	Analog Snr 1	1188	RR F.Tom ff
869	MG Zap 9	949	TR909 Kick 1	1029	SF Rim p L	1109	Analog Snr 2	1189	SF L.Tom mf
870	MG Zap 10	950	TR909 Kick 2	1030	SF Rim p R	1110	Analog Snr 3	1190	SF L.Tom ff
871	MG Zap 11	951	AnalogKick 2	1031	SF Rim mf L	1111	Tiny Snare	1191	SF M.Tom mf
872	MG Blip	952	TR909 Kick 3	1032	SF Rim mf R	1112	R&B ShrtSnr1	1192	SF M.Tom f
873	Beam HIQ	953	AnalogKick 3	1033	SF Rim f L	1113	TR909 Snr 1	1193	SF M.Tom ff
874	MG Attack	954	AnalogKick 4	1034	SF Rim f R	1114	TR909 Snr 2	1194	SF H.Tom mf
875	Syn Low Atk1	955	AnalogKick 5	1035	SF Rim ff L	1115	TR909 Snr 3	1195	SF H.Tom f
876	Syn Low Atk2	956	AnalogKick 6	1036	SF Rim ff R	1116	TR909 Snr 4	1196	SF H.Tom ff
877	Syn Hrd Atk1	957	TR606DstKick	1037	Reg.Snr1 p L	1117	TR909 Snr 5	1197	RR FT Flm ff
878	Syn Hrd Atk2	958	TR808 Kick	1038	Reg.Snr1 p R	1118	TR909 Snr 6	1198	SF LT Flm ff
879	Syn Hrd Atk3	959	TR909 Kick 4	1039	Reg.Snr1mf L	1119	TR808 Snr 1	1199	SF MT Flm f
880	Syn Hrd Atk4	960	TR909 Kick 5	1040	Reg.Snr1mf R	1120	TR808 Snr 2	1200	SF HT Flm p

# Waveform List

No.	Wave Name	No.	Wave Name	No.	Wave Name
1201	SF HT Flm f	1281	Noise OHH 2	1361	Conga Lo Op
1202	SF HT Flm ff	1282	Crash Cym1 p	1362	Conga Slp Op
1203	Reg.F.Tom p	1283	Crash Cym1 f	1363	Conga Efx
1204	Reg.F.Tom f	1284	Crash Cym 2	1364	Conga Thumb
1205	Reg.L.Tom p	1285	Rock Crash 1	1365	Conga 2H Op
1206	Reg.L.Tom f	1286	Rock Crash 2	1366	Conga 2H Mt
1207	Reg.M.Tom p	1287	Splash Cym	1367	Conga 2H Slp
1208	Reg.M.Tom f	1288	Jazz Crash	1368	Conga 2L Op
1209	Reg.H.Tom p	1289	TR909 Crash	1369	Conga 2L Mt
1210	Reg.H.Tom f	1290	TR909 Crash2	1370	TR808 Conga1
1211	Reg.L.TomFlm	1291	TR808 Cym	1371	TR808 Conga2
1212	Reg.M.TomFlm	1292	TR606 Cym 2	1372	Timbale 1
1213	Reg.H.TomFlm	1293	Ride Cymbal	1373	Timbale 2
1214	Jazz Lo Tom	1294	Ride Bell	1374	Timbale 3
1215	Jazz Mid Tom	1295	Rock Rd Cup	1375	Timbale 4
1216	Jazz Hi Tom	1296	Rock Rd Edge	1376	Cabasa Up
1217	Jazz Lo Flm	1297	Jazz Ride p	1377	Cabasa Down
1218	Jazz Mid Flm	1298	Jazz Ride mf	1378	Cabasa Cut
1219	Jazz Hi Flm	1299	TR909 Ride	1379	Cabasa 2
1220	Sharp Lo Tom	1300	China Cymbal	1380	Cabasa 2 Cut
1221	Sharp Hi Tom	1301	Concert Cym	1381	Maracas
1222	Dry Lo Tom	1302	Concert Cym2	1382	808 Maracas
1223	TR909 Tom	1303	Hand Clap	1383	R8 Shaker
1224	TR909 DstTom	1304	Club Clap	1384	Shaker 1
1225	TR808 Tom	1305	Real Clap	1385	Shaker 2
1226	TR606 Tom	1306	Bright Clap	1386	Shaker 3
1227	Deep Tom	1307	R8 Clap	1387	Guiro 1
1228	Reg.CHH 1 p	1308	Gospel Clap	1388	Guiro 2
1229	Reg.CHH 1 mf	1309	Amb Clap	1389	Guiro Long
1230	Reg.CHH 1 f	1310	Hip Clap	1390	Guiro 2 Up
1231	Reg.CHH 1 ff	1311	Funk Clap	1391	Guiro 2 Down
1232	Reg.CHH 2 mf	1312	Claptail	1392	Guiro 2 Fast
1233	Reg.CHH 2 f	1313	TR808 Clap 1	1393	Vibraslap
1234	Reg.CHH 2 ff	1314	Disc Clap	1394	Tamborine 1
1235	Reg.PHH mf	1315	Dist Clap	1395	Tamborine 2
1236	Reg.PHH f	1316	Dist Clap 2	1396	Tamborine 3
1237	Reg.OHH mf	1317	Old Clap	1397	Tamborine4 p
1238	Reg.OHH f	1318	TR909 Clap 1	1398	Tamborine4 f
1239	Reg.OHH ff	1319	TR909 Clap 2	1399	CR78 Tamb
1240	Rock CHH1 mf	1320	TR808 Clap 2	1400	Cajon 1
1241	Rock CHH1 f	1321	TR707 Clap	1401	Cajon 2
1242	Rock CHH2 mf	1322	Cheap Clap	1402	Cajon 3
1243	Rock CHH2 f	1323	Mix Clap 1 L	1403	Cajon 4
1244	Rock OHH	1324	Mix Clap 1 R	1404	SprgDrm Hit
1245	Lo-Bit CHH 1	1325	Mix Clap 2 L	1405	Cuica
1246	Lo-Bit CHH 2	1326	Mix Clap 2 R	1406	Cuica 2 Hi
1247	Lo-Bit CHH 3	1327	Mix Clap 3	1407	Cuica 2 Low
1248	Lo-Bit CHH 4	1328	Mix Clap 4	1408	Timpani p
1249	Lo-Bit CHH 5	1329	Finger Snap	1409	Timpani f
1250	HipHop CHH	1330	Club FinSnap	1410	Timpani Roll
1251	TR909 CHH 1	1331	Snap	1411	Timpani Lp
1252	TR909 CHH 2	1332	Group Snap	1412	ConcertBD p
1253	TR808 CHH 1	1333	Cowbell	1413	ConcertBD f
1254	TR808 CHH 2	1334	Cowbell Mute	1414	ConcertBD ff
1255	TR606 CHH 1	1335	Cowbell2 Lng	1415	ConcertBD Lp
1256	TR606 CHH 2	1336	Cowbell2 Edg	1416	Triangle 1
1257	TR606 DstCHH	1337	Cowbell3 mf	1417	Triangle 2
1258	Lite CHH	1338	Cowbell3 f	1418	Tibet Cymbal
1259	CR78 CHH	1339	TR808Cowbell	1419	Slight Bell
1260	Dance CHH	1340	Wood Block	1420	Wind Chime
1261	Noise CHH	1341	Wood Block2H	1421	Crotale
1262	Hip PHH	1342	Wood Block2L	1422	R8 Click
1263	TR909 PHH 1	1343	Claves	1423	Metro Bell
1264	TR909 PHH 2	1344	Claves 2	1424	Metro Click
1265	TR808 PHH	1345	TR808 Claves	1425	MC500 Beep 1
1266	TR606 PHH 1	1346	CR78 Beat	1426	MC500 Beep 2
1267	TR606 PHH 2	1347	Castanet	1427	DR202 Beep
1268	Lo-Bit PHH	1348	Whistle	1428	Low Square
1269	Lo-Bit OHH 1	1349	Whistle Long	1429	Low Sine
1270	Lo-Bit OHH 2	1350	Whistle Shrt	1430	DC
1271	Lo-Bit OHH 3	1351	Bongo Hi Mt	1431	Reverse Cym
1272	HipHop OHH	1352	Bongo Hi Slp		
1273	TR909 OHH 1	1353	Bongo Hi Op		
1274	TR909 OHH 2	1354	Bongo Lo Op		
1275	TR808 OHH 1	1355	Bongo Lo Slp		
1276	TR808 OHH 2	1356	Conga Hi Mt		
1277	TR606 OHH	1357	Conga Lo Mt		
1278	Lite OHH	1358	Conga Hi Slp		
1279	CR78 OHH	1359	Conga Lo Slp		
1280	Noise OHH	1360	Conga Hi Op		



# Arpeggio Style List

## PRST (Preset Group)

### USER (User Group)

\* Arpeggio Styles are common between Preset Group and User Group.

No.	Name	No.	Name	No.	Name
001	Basic 1 (A)	061	Seq Ptn 55 (P)	121	Gtr Backng 1(A)
002	Basic 2 (A)	062	Seq Ptn 56 (P)	122	Gtr Backng 2 (A)
003	Basic 3 (A)	063	Seq Ptn 57 (P)	123	Key Bckng1 (A)
004	Basic 4 (A)	064	Seq Ptn 58 (P)	124	Key Bckng2 (A)
005	Basic 5 (A)	065	Seq Ptn 59 (P)	125	Key Bckng3 (1-3)
006	Basic 6 (A)	066	Seq Ptn 60 (P)	126	1/1 Note Trg (1)
007	Seq Ptn 1 (2)	067	Bassline 1 (1)	127	1/2 Note Trg (1)
008	Seq Ptn 2 (2)	068	Bassline 2 (1)	128	1/4 Note Trg (1)
009	Seq Ptn 3 (2)	069	Bassline 3 (1)		
010	Seq Ptn 4 (2)	070	Bassline 4 (1)		
011	Seq Ptn 5 (2)	071	Bassline 5 (1)		
012	Seq Ptn 6 (3)	072	Bassline 6 (1)		
013	Seq Ptn 7 (3)	073	Bassline 7 (1)		
014	Seq Ptn 8 (3)	074	Bassline 8 (1)		
015	Seq Ptn 9 (3)	075	Bassline 9 (1)		
016	Seq Ptn 10 (3)	076	Bassline 10 (2)		
017	Seq Ptn 11 (3)	077	Bassline 11 (2)		
018	Seq Ptn 12 (3)	078	Bassline 12 (2)		
019	Seq Ptn 13 (3)	079	Bassline 13 (2)		
020	Seq Ptn 14 (3)	080	Bassline 14 (2)		
021	Seq Ptn 15 (3)	081	Bassline 15 (2)		
022	Seq Ptn 16 (3)	082	Bassline 16 (3)		
023	Seq Ptn 17 (3)	083	Bassline 17 (3)		
024	Seq Ptn 18 (4)	084	Bassline 18 (3)		
025	Seq Ptn 19 (4)	085	Bassline 19 (3)		
026	Seq Ptn 20 (4)	086	Bassline 20 (3)		
027	Seq Ptn 21 (4)	087	Bassline 21 (3)		
028	Seq Ptn 22 (4)	088	Bassline 22 (P)		
029	Seq Ptn 23 (4)	089	Bassline 23 (P)		
030	Seq Ptn 24 (4)	090	Bassline 24 (P)		
031	Seq Ptn 25 (4)	091	Bassline 25 (P)		
032	Seq Ptn 26 (4)	092	Bassline 26 (P)		
033	Seq Ptn 27 (4)	093	Bassline 27 (P)		
034	Seq Ptn 28 (4)	094	Bassline 28 (P)		
035	Seq Ptn 29 (4)	095	Bassline 29 (P)		
036	Seq Ptn 30 (5)	096	Bassline 30 (P)		
037	Seq Ptn 31 (5)	097	Bassline 31 (P)		
038	Seq Ptn 32 (6)	098	Bassline 32 (P)		
039	Seq Ptn 33 (P)	099	Bassline 33 (P)		
040	Seq Ptn 34 (P)	100	Bassline 34 (P)		
041	Seq Ptn 35 (P)	101	Bassline 35 (P)		
042	Seq Ptn 36 (P)	102	Bassline 36 (P)		
043	Seq Ptn 37 (P)	103	Bassline 37 (P)		
044	Seq Ptn 38 (P)	104	Bassline 38 (P)		
045	Seq Ptn 39 (P)	105	Bassline 39 (P)		
046	Seq Ptn 40 (P)	106	Bassline 40 (P)		
047	Seq Ptn 41 (P)	107	Bassline 41 (P)		
048	Seq Ptn 42 (P)	108	Sliced 1 (A)		
049	Seq Ptn 43 (P)	109	Sliced 2 (A)		
050	Seq Ptn 44 (P)	110	Sliced 3 (A)		
051	Seq Ptn 45 (P)	111	Sliced 4 (A)		
052	Seq Ptn 46 (P)	112	Sliced 5 (A)		
053	Seq Ptn 47 (P)	113	Sliced 6 (A)		
054	Seq Ptn 48 (P)	114	Sliced 7 (A)		
055	Seq Ptn 49 (P)	115	Sliced 8 (A)		
056	Seq Ptn 50 (P)	116	Sliced 9 (A)		
057	Seq Ptn 51 (P)	117	Sliced 10 (A)		
058	Seq Ptn 52 (P)	118	Gtr Arp 1 (4)		
059	Seq Ptn 53 (P)	119	Gtr Arp 2 (5)		
060	Seq Ptn 54 (P)	120	Gtr Arp 3 (6)		

### Recommended number of notes to press

(1) – (6): One to six notes  
 (1-3): One bass note + three-note chord  
 (A): As desired  
 (P): One note, with Motif (p. 62) set to “Phrase”

# Rhythm Group List

**PRST (Preset Group)**

**USER (User Group)**

\* Rhythm Groups are common between Preset Group and User Group.

No.	Name	Recommended Rhythm Set	
001	Pop 1	PRST001	SF Std Kit
002	Pop 2	PRST002	WD Std Kit
003	Pop 3	PRST005	StandardKit1
004	Pop 4	PRST006	StandardKit2
005	Pop 5	PRST003	LD Std Kit
006	Pop 6	PRST005	StandardKit1
007	Pop 7	PRST006	StandardKit2
008	Pop 8	PRST004	TY Std Kit
009	Pop 9	PRST006	StandardKit2
010	Rock1	PRST008	Rock Kit 1
011	Rock2	PRST005	StandardKit1
012	Funk	PRST004	TY Std Kit
013	Fusion	PRST001	SF Std Kit
014	Jazz	PRST010	Brush Jz Kit
015	Bossa	PRST003	LD Std Kit
016	HipHop	PRST017	Machine Kit1
017	R&B	PRST016	HiFi R&B Kit
018	Reggae	PRST018	Kit-Euro:POP
019	Trance 1	PRST021	Machine Kit2
020	Trance 2	PRST018	Kit-Euro:POP
021	Techno	PRST022	ArtificialKit
022	House 1	PRST019	House Kit
023	House 2	PRST018	Kit-Euro:POP
024	Drum'n Bs	PRST007	StandardKit3
025	Disco	PRST007	StandardKit3
026	NuTechnica	PRST020	Nu Technica

# Rhythm Pattern List

## PRST (Preset Group) USER (User Group)

\* Rhythm Patterns are common between Preset Group and User Group.

\* Recommended tempo is shown in parentheses ( )

No.	Name	Recommended Rhythm Set	No.	Name	Recommended Rhythm Set	No.	Name	Recommended Rhythm Set
001	Pop 1-1 (120)	PRST:001 SF Std Kit	057	Pop 8-1 (130)	PRST:004 TY Std Kit	113	Bossa 1 (160)	PRST:003 LD Std Kit
002	Pop 1-2 (120)							
003	Pop 1-3 (120)							
004	Pop 1-4 (120)							
005	Pop 1-5 (120)							
006	Pop 1-6 (120)							
007	Pop 1-7 (120)							
008	Pop 1-8 (120)							
009	Pop 2-1 (120)	PRST:002 WD Std Kit1	065	Pop 9-1 (125)	PRST:006 StandardKit2	121	HipHop 1-A (100)	PRST:012 909 808 Kit
010	Pop 2-2 (120)							
011	Pop 2-3 (120)							
012	Pop 2-4 (120)							
013	Pop 2-5 (120)							
014	Pop 2-6 (120)							
015	Pop 2-7 (120)							
016	Pop 2-8 (120)							
017	Pop 3-1 (150)	PRST:005 StandardKit1	073	Rock 1-1 (120)	PRST:008 Rock Kit 1	129	HipHop 2-A (095)	PRST:017 Machine Kit1
018	Pop 3-2 (150)							
019	Pop 3-3 (150)							
020	Pop 3-4 (150)							
021	Pop 3-5 (150)							
022	Pop 3-6 (150)							
023	Pop 3-7 (150)							
024	Pop 3-8 (150)							
025	Pop 4-1 (120)	PRST:006 StandardKit2	081	Rock 2-1 (114)	PRST:005 StandardKit1	137	R&B 1-A (100)	PRST:017 Machine Kit1
026	Pop 4-2 (120)							
027	Pop 4-3 (120)							
028	Pop 4-4 (120)							
029	Pop 4-5 (120)							
030	Pop 4-6 (120)							
031	Pop 4-7 (120)							
032	Pop 4-8 (120)							
033	Pop 5-1 (103)	PRST:003 LD Std Kit	089	Funk 1 (115)	PRST:004 TY Std Kit	145	R&B 2-A (140)	PRST:016 HiFi R&B Kit
034	Pop 5-2 (103)							
035	Pop 5-3 (103)							
036	Pop 5-4 (103)							
037	Pop 5-5 (103)							
038	Pop 5-6 (103)							
039	Pop 5-7 (103)							
040	Pop 5-8 (103)							
041	Pop 6-1 (096)	PRST:005 StandardKit1	097	Fusion 1 (100)	PRST:001 SF Std Kit	153	Reggae A (105)	PRST:018 Kit-Euro:POP
042	Pop 6-2 (096)							
043	Pop 6-3 (096)							
044	Pop 6-4 (096)							
045	Pop 6-5 (096)							
046	Pop 6-6 (096)							
047	Pop 6-7 (096)							
048	Pop 6-8 (096)							
049	Pop 7-1 (104)	PRST:002 StandardKit2	105	Jazz 1 (136)	PRST:010 Brush Jz Kit	161	Trance 1-A (140)	PRST:021 Machine Kit2
050	Pop 7-2 (104)							
051	Pop 7-3 (104)							
052	Pop 7-4 (104)							
053	Pop 7-5 (104)							
054	Pop 7-6 (104)							
055	Pop 7-7 (104)							
056	Pop 7-8 (104)							
			106	Jazz 2 (136)		162	Trance 1-B (138)	
			107	Jazz 3 (136)		163	Trance 1-C (142)	
			108	Jazz 4 (136)		164	Trance 1-D (142)	
			109	Jazz 5 (136)		165	Trance 1-E (142)	
			110	Jazz 6 (136)		166	Trance 1-F (142)	
			111	Jazz 7 (136)		167	Trance 1-G (138)	
			112	Jazz 8 (136)		168	Trance 1-H (138)	

## Rhythm Pattern List

No.	Name	Recommended Rhythm Set	No.	Name	Recommended Rhythm Set
169	Trance 2-A (143)	PRST:018 Kit-Euro:POP	233	NuTeknica A (110)	PRST:020 Nu Technica
170	Trance 2-B (142)		234	NuTeknica B (110)	
171	Trance 2-C (135)		235	NuTeknica C (110)	
172	Trance 2-D (140)		236	NuTeknica D (110)	
173	Trance 2-E (130)		237	NuTeknica E (110)	
174	Trance 2-F (154)		238	NuTeknica F (110)	
175	Trance 2-G (140)		239	NuTeknica G (110)	
176	Trance 2-H (138)		240	NuTeknica H (110)	
177	Techno 1-A (132)	PRST:022 Artificalkit	241	Tabla Phr A (120)	---
178	Techno 1-B (142)		242	Tabla Phr B (120)	
179	Techno 1-C (138)		243	Tabla Phr C (120)	
180	Techno 1-D (141)		244	Tabla Phr D (120)	
181	Techno 1-E (136)		245	Tabla Phr E (120)	
182	Techno 1-F (143)		246	Tabla Phr F (120)	
183	Techno 1-G (140)		247	Tabla Phr G (120)	
184	Techno 1-H (140)		248	Tabla Phr H (120)	
185	Techno 2-A (132)	---	249	Perc Phr A (120)	---
186	Techno 2-B (126)		250	Perc Phr B (120)	
187	Techno 2-C (128)		251	Perc Phr C (120)	
188	Techno 2-D (128)		252	Perc Phr D (120)	
189	Techno 2-E (128)		253	Perc Phr E (120)	
190	Techno 2-F (130)		254	Perc Phr F (120)	
191	Techno 2-G (134)		255	Perc Phr G (120)	
192	Techno 2-H (130)		256	Perc Phr H (120)	
193	House 1-A (126)	PRST:019 House Kit			
194	House 1-B (126)				
195	House 1-C (124)				
196	House 1-D (128)				
197	House 1-E (125)				
198	House 1-F (128)				
199	House 1-G (126)				
200	House 1-H (126)				
201	House 2-A (125)	PRST:018 Kit-Euro:POP			
202	House 2-B (130)				
203	House 2-C (134)				
204	House 2-D (127)				
205	House 2-E (128)				
206	House 2-F (128)				
207	House 2-G (128)				
208	House 2-H (128)				
209	Drum'n Bs A (170)	PRST:007 StandardKit3			
210	Drum'n Bs B (160)				
211	Drum'n Bs C (180)				
212	Drum'n Bs D (160)				
213	Drum'n Bs E (170)				
214	Drum'n Bs F (170)				
215	Drum'n Bs G (170)				
216	Drum'n Bs H (170)				
217	BrkBts A (130)	---			
218	BrkBts B (130)				
219	BrkBts C (130)				
220	BrkBts D (130)				
221	BrkBts E (130)				
222	BrkBts F (130)				
223	BrkBts G (130)				
224	BrkBts H (130)				
225	Disco A (125)	PRST:007 StandardKit3			
226	Disco B (125)				
227	Disco C (125)				
228	Disco D (120)				
229	Disco E (130)				
230	Disco F (124)				
231	Disco G (125)				
232	Disco H (125)				

## 1. Data Reception

### ■ Channel Voice Messages

\* Not received in Performance mode when the Receive Switch parameter (PERFORM/MIDI) is OFF.

#### ● Note off

Status	2nd byte	3rd byte
8nH	kkH	vvH
9nH	kkH	00H
n = MIDI channel number:	0H - FH (ch.1 - 16)	
kk = note number:	00H - 7FH (0 - 127)	
vv = note off velocity:	00H - 7FH (0 - 127)	

\* Not received when the Tone Env Mode parameter (PATCH/MISC and RHYTHM/CONTROL) is NSUS/NO-SUS.

#### ● Note on

Status	2nd byte	3rd byte
9nH	kkH	vvH
n = MIDI channel number:	0H - FH (ch.1 - 16)	
kk = note number:	00H - 7FH (0 - 127)	
vv = note on velocity:	01H - 7FH (1 - 127)	

#### ● Polyphonic Key Pressure

Status	2nd byte	3rd byte
AnH	kkH	vvH
n = MIDI channel number:	0H - FH (ch.1 - 16)	
kk = note number:	00H - 7FH (0 - 127)	
vv = Polyphonic Key Pressure:	00H - 7FH (0 - 127)	

\* Not received in Performance mode when the Receive Poly Key Pressure parameter (PERFORM/MIDI) is OFF.

#### ● Control Change

- \* If the corresponding Controller number is selected for the Patch Control Source 1, 2, 3 or 4 parameter (PATCH/CONTROL/CTRL1-4), the corresponding effect will occur.
- \* If a Controller number that corresponds to the System Control Source 1, 2, 3 or 4 parameter (SYSTEM/CTRL) is selected, the specified effect will apply if Patch Control Source 1, 2, 3 or 4 parameter (PATCH/CONTROL/CTRL1-4) is set to SYS-CTRL1, SYS-CTRL2, SYS-CTRL3 or SYS-CTRL4.

#### ○ Bank Select (Controller number 0, 32)

Status	2nd byte	3rd byte
BnH	00H	mmH
BnH	20H	llH
n = MIDI channel number:	0H - FH (ch.1 - 16)	
mm, ll = Bank number:	00 00H - 7F 7FH (bank.1 - bank.16384)	

- \* Not received in Performance mode when the Receive Bank Select (PERFORM/MIDI) is OFF.
- \* The Performances, Patches, and Rhythms corresponding to each Bank Select are as follows.
- \* The SRX series corresponding to each Bank Select are to see the SRX series owner's manual.

BANK	SELECT	PROGRAM	GROUP	NUMBER
MSB	LSB	NUMBER		
000		001 - 128	GM Patch	001 - 256
:				
063		001 - 128	GM Patch	001 - 256
085	000	001 - 064	User Performance	001 - 064
	064	001 - 064	Preset Performance	001 - 064
086	000	001 - 032	User Rhythm	001 - 032
	064	001 - 036	Preset Rhythm	001 - 036
087	000	001 - 128	User Patch	001 - 128
	001	001 - 128	User Patch	129 - 256
	064	001 - 128	Preset Patch A	001 - 128
	065	001 - 128	Preset Patch B	001 - 128
:				
092	000 -	001 -	SRX Rhythm	001 -
:				
093	000 -	001 -	SRX Patch	001 -
:				
120		001 - 057	GM Rhythm	001 - 009
121	000 -	001 - 128	GM Patch	001 - 256

#### ○ Modulation (Controller number 1)

Status	2nd byte	3rd byte
BnH	01H	vvH
n = MIDI channel number:	0H - FH (ch.1 - 16)	
vv = Modulation depth:	00H - 7FH (0 - 127)	

\* Not received in Performance mode when the Receive Modulation parameter (PERFORM/MIDI) is OFF.

#### ○ Breath type (Controller number 2)

Status	2nd byte	3rd byte
BnH	02H	vvH
n = MIDI channel number:	0H - FH (ch.1 - 16)	
vv = Control value:	00H - 7FH (0 - 127)	

\* JUNO-STAGE receives it as ACTIVE EXPRESSION.

#### ○ Foot type (Controller number 4)

Status	2nd byte	3rd byte
BnH	04H	vvH
n = MIDI channel number:	0H - FH (ch.1 - 16)	
vv = Control value:	00H - 7FH (0 - 127)	

#### ○ Portamento Time (Controller number 5)

Status	2nd byte	3rd byte
BnH	05H	vvH
n = MIDI channel number:	0H - FH (ch.1 - 16)	
vv = Portamento Time:	00H - 7FH (0 - 127)	

\* In Performance mode, the Part Portamento Time parameter (PERFORM/PART VIEW/KEY MOD) will change.

#### ○ Data Entry (Controller number 6, 38)

Status	2nd byte	3rd byte
BnH	06H	mmH
BnH	26H	llH
n = MIDI channel number:	0H - FH (ch.1 - 16)	
mm, ll = the value of the parameter specified by RPN/NRPN		
mm = MSB, ll = LSB		

#### ○ Volume (Controller number 7)

Status	2nd byte	3rd byte
BnH	07H	vvH
n = MIDI channel number:	0H - FH (ch.1 - 16)	
vv = Volume:	00H - 7FH (0 - 127)	

\* Not received in Performance mode when the Receive Volume parameter (PERFORM/MIDI) is OFF.

\* In Performance mode, the Part Level parameter (PERFORM/PART VIEW/LV&PAN) will change.

#### ○ Balance (Controller number 8)

Status	2nd byte	3rd byte
BnH	08H	vvH
n = MIDI channel number:	0H - FH (ch.1 - 16)	
vv = Balance:	00H - 7FH (0 - 127)	

#### ○ Panpot (Controller number 10)

Status	2nd byte	3rd byte
BnH	0AH	vvH
n = MIDI channel number:	0H - FH (ch.1 - 16)	
vv = Panpot:	00H - 40H - 7FH (Left - Center - Right),	

\* Not received in Performance mode when the Receive Pan parameter (PERFORM/MIDI) is OFF.

\* In Performance mode, the Part Pan parameter (PERFORM/PART VIEW/LV&PAN) will change.

# MIDI Implementation

## ○Expression (Controller number 11)

Status	2nd byte	3rd byte
BnH	0BH	vvH
n = MIDI channel number:		0H - FH (ch.1 - 16)
vv = Expression:		00H - 7FH (0 - 127)

- \* Not received when Rx Expression Tone Receive Expression parameter (PATCH/MISC or RHYTHM/RECEIVE) is OFF.
- \* Not received in Performance mode when Rx Expression parameter (PERFORM/MISC) is OFF.

## ○Hold 1 (Controller number 64)

Status	2nd byte	3rd byte
BnH	40H	vvH
n = MIDI channel number:		0H - FH (ch.1 - 16)
vv = Control value:		00H - 7FH (0 - 127) 0-63 = OFF, 64-127 = ON

- \* Not received when Rx Hold-1/Tone Receive Hold-1 parameter (PATCH/CONTROL or RHYTHM/RECEIVE) is OFF.
- \* Not received in Performance mode when Rx Hold-1 parameter (PERFORM/MISC) is OFF.
- \* When the Redamper Sw parameter (PATCH/MISC) is turned ON, 128 discrete steps are recognized for the value.

## ○Portamento (Controller number 65)

Status	2nd byte	3rd byte
BnH	41H	vvH
n = MIDI channel number:		0H - FH (ch.1 - 16)
vv = Control value:		00H - 7FH (0 - 127) 0 - 63 = OFF, 64 - 127 = ON

- \* In Performance mode, the Part Portamento Switch parameter (PERFORM/PART VIEW/KEY MOD) will change.

## ○Sostenuto (Controller number 66)

Status	2nd byte	3rd byte
BnH	42H	vvH
n = MIDI channel number:		0H - FH (ch.1 - 16)
vv = Control value:		00H - 7FH (0 - 127) 0 - 63 = OFF, 64 - 127 = ON

## ○Soft (Controller number 67)

Status	2nd byte	3rd byte
BnH	43H	vvH
n = MIDI channel number:		0H - FH (ch.1 - 16)
vv = Control value:		00H - 7FH (0 - 127) 0 - 63 = OFF, 64 - 127 = ON

## ○Legato Foot Switch (Controller number 68)

Status	2nd byte	3rd byte
BnH	44H	vvH
n = MIDI channel number:		0H - FH (ch.1 - 16)
vv = Control value:		00H - 7FH (0 - 127) 0 - 63 = OFF, 64 - 127 = ON

- \* In Performance mode, the Part Legato Switch parameter (PERFORM/PART VIEW/KEY MOD) will change.

## ○Hold-2 (Controller number 69)

Status	2nd byte	3rd byte
BnH	45H	vvH
n = MIDI channel number:		0H - FH (ch.1 - 16)
vv = Control value:		00H - 7FH (0 - 127)

- \* A hold movement isn't done.

## ○Resonance (Controller number 71)

Status	2nd byte	3rd byte
BnH	47H	vvH
n = MIDI channel number:		0H - FH (ch.1 - 16)
vv = Resonance value (relative change):		00H - 40H - 7FH (-64 - 0 - +63),

- \* In Performance mode, the Part Resonance Offset parameter (PERFORM/PART VIEW/OFFSET) will change.

## ○Release Time (Controller number 72)

Status	2nd byte	3rd byte
BnH	48H	vvH
n = MIDI channel number:		0H - FH (ch.1 - 16)
vv = Release Time value (relative change):		00H - 40H - 7FH (-64 - 0 - +63),

- \* In Performance mode, the Part Release Time Offset parameter (PERFORM/PART VIEW/OFFSET) will change.

## ○Attack time (Controller number 73)

Status	2nd byte	3rd byte
BnH	49H	vvH
n = MIDI channel number:		0H - FH (ch.1 - 16)
vv = Attack time value (relative change):		00H - 40H - 7FH (-64 - 0 - +63),

- \* In Performance mode, the Part Attack Time Offset parameter (PERFORM/PART VIEW/OFFSET) will change.

## ○Cutoff (Controller number 74)

Status	2nd byte	3rd byte
BnH	4AH	vvH
n = MIDI channel number:		0H - FH (ch.1 - 16)
vv = Cutoff value (relative change):		00H - 40H - 7FH (-64 - 0 - +63)

- \* In Performance mode, the Part Cutoff Offset parameter (PERFORM/PART VIEW/OFFSET) will change.

## ○Decay Time (Controller number 75)

Status	2nd byte	3rd byte
BnH	4BH	vvH
n = MIDI channel number:		0H - FH (ch.1 - 16)
vv = Decay Time value (relative change):		00H - 40H - 7FH (-64 - 0 - +63)

- \* In Performance mode, the Part Decay Time Offset parameter (PERFORM/PART VIEW/OFFSET) will change.

## ○Vibrato Rate (Controller number 76)

Status	2nd byte	3rd byte
BnH	4CH	vvH
n = MIDI channel number:		0H - FH (ch.1 - 16)
vv = Vibrato Rate value (relative change):		00H - 40H - 7FH (-64 - 0 - +63)

- \* In Performance mode, the Part Vibrato Rate parameter (PERFORM/PART VIEW/VIBRATO) will change.

## ○Vibrato Depth (Controller number 77)

Status	2nd byte	3rd byte
BnH	4DH	vvH
n = MIDI channel number:		0H - FH (ch.1 - 16)
vv = Vibrato Depth Value (relative change):		00H - 40H - 7FH (-64 - 0 - +63)

- \* In Performance mode, the Part Vibrato Depth parameter (PERFORM/PART VIEW/VIBRATO) will change.

## ○Vibrato Delay (Controller number 78)

Status	2nd byte	3rd byte
BnH	4EH	vvH
n = MIDI channel number:		0H - FH (ch.1 - 16)
vv = Vibrato Delay value (relative change):		00H - 40H - 7FH (-64 - 0 - +63)

- \* In Performance mode, the Part Vibrato Delay parameter (PERFORM/PART VIEW/VIBRATO) will change.

## ○General Purpose Controller 5 (Controller number 80)

Status	2nd byte	3rd byte
BnH	50H	vvH
n = MIDI channel number:		0H - FH (ch.1 - 16)
vv = Control value:		00H - 7FH (0 - 127)

- \* The Tone Level parameter (PATCH/TVA PARAMETER) of Tone 1 will change.

## ○General Purpose Controller 6 (Controller number 81)

Status	2nd byte	3rd byte
BnH	51H	vvH
n = MIDI channel number:		0H - FH (ch.1 - 16)
vv = Control value:		00H - 7FH (0 - 127)

\* The Tone Level parameter (PATCH/TVA PARAMETER) of Tone 2 will change.

## ○General Purpose Controller 7 (Controller number 82)

Status	2nd byte	3rd byte
BnH	52H	vvH
n = MIDI channel number:		0H - FH (ch.1 - 16)
vv = Control value:		00H - 7FH (0 - 127)

\* The Tone Level parameter (PATCH/TVA PARAMETER) of Tone 3 will change.

## ○General Purpose Controller 8 (Controller number 83)

Status	2nd byte	3rd byte
BnH	53H	vvH
n = MIDI channel number:		0H - FH (ch.1 - 16)
vv = Control value:		00H - 7FH (0 - 127)

\* The Tone Level parameter (PATCH/TVA PARAMETER) of Tone 4 will change.

## ○Portamento control (Controller number 84)

Status	2nd byte	3rd byte
BnH	54H	kkH
n = MIDI channel number:		0H - FH (ch.1 - 16)
kk = source note number:		00H - 7FH (0 - 127)

- \* A Note-on received immediately after a Portamento Control message will change continuously in pitch, starting from the pitch of the Source Note Number.
- \* If a voice is already sounding for a note number identical to the Source Note Number, this voice will continue sounding (i.e., legato) and will, when the next Note-on is received, smoothly change to the pitch of that Note-on.
- \* The rate of the pitch change caused by Portamento Control is determined by the Portamento Time value.

## ○Effect 1 (Reverb Send Level) (Controller number 91)

Status	2nd byte	3rd byte
BnH	5BH	vvH
n = MIDI channel number:		0H - FH (ch.1 - 16)
vv = Reverb Send Level:		00H - 7FH (0 - 127)

\* In Performance mode, the Part Reverb Send Level parameter (PERFORM/PART VIEW/OUTPUT) will change.

## ○Effect 3 (Chorus Send Level) (Controller number 93)

Status	2nd byte	3rd byte
BnH	5DH	vvH
n = MIDI channel number:		0H - FH (ch.1 - 16)
vv = Chorus Send Level:		00H - 7FH (0 - 127)

\* In Performance mode, the Part Chorus Send Level parameter (PERFORM/PART VIEW/OUTPUT) will change.

## ○RPN MSB/LSB (Controller number 100, 101)

Status	2nd byte	3rd byte
BnH	65H	mmH
BnH	64H	llH
n = MIDI channel number:	0H - FH (ch.1 - 16)	
mm = upper byte (MSB) of parameter number specified by RPN		
ll = lower byte (LSB) of parameter number specified by RPN		

<<< RPN >>>

Control Changes include RPN (Registered Parameter Numbers), which are extended. When using RPNs, first RPN (Controller numbers 100 and 101; they can be sent in any order) should be sent in order to select the parameter, then Data Entry (Controller numbers 6 and 38) should be sent to set the value. Once RPN messages are received, Data Entry messages that is received at the same MIDI channel after that are recognized as changing toward the value of the RPN messages. In order not to make any mistakes, transmitting RPN Null is recommended after setting parameters you need.

This device receives the following RPNs.

RPN	Data entry	Notes
<u>MSB, LSB</u>	<u>MSB, LSB</u>	
00H, 00H	mmH, llH	Pitch Bend Sensitivity mm: 00H - 18H (0 - 24 semitones) ll: ignored (processed as 00H) Up to 2 octave can be specified in semitone steps.
* In Performance mode, the Part Bend Range parameter (PERFORM/PART VIEW/PITCH) will change.		
00H, 01H	mmH, llH	Channel Fine Tuning mm, ll: 20 00H - 40 00H - 60 00H (-4096 x 100 / 8192 - 0 - +4096 x 100 / 8192 cent)
* In Performance mode, the Part Fine Tune parameter (PERFORM/PART VIEW/PITCH) will change.		
00H, 02H	mmH, llH	Channel Coarse Tuning mm: 10H - 40H - 70H (-48 - 0 - +48 semitones) ll: ignored (processed as 00H)
* In Performance mode, the Part Coarse Tune parameter (PERFORM/PART VIEW/PITCH) will change.		
00H, 05H	mmH, llH	Modulation Depth Range mm, ll: 00 00H - 00 06H (0 - 16384 x 600 / 16384 cent)
* Not received in Patch mode.		
7FH, 7FH	---, ---	RPN null
RPN and NRPN will be set as "unspecified." Once this setting has been made, subsequent Parameter values that were previously set will not change.		
mm, ll: ignored		

## ●Program Change

Status	2nd byte
CnH	ppH
n = MIDI channel number:	0H - FH (ch.1 - 16)
pp = Program number:	00H - 7FH (prog.1 - prog.128)

\* Not received in Performance mode when the Receive Program Change parameter (PERFORM/MIDI) is OFF.

## ●Channel Pressure

Status	2nd byte
DnH	vvH
n = MIDI channel number:	0H - FH (ch.1 - 16)
vv = Channel Pressure:	00H - 7FH (0 - 127)

\* Not received in Performance mode when the Receive Channel Pressure parameter (PERFORM/MIDI) is OFF.

## ●Pitch Bend Change

Status	2nd byte	3rd byte
EnH	llH	mmH
n = MIDI channel number:	0H - FH (ch.1 - 16)	
mm, ll = Pitch Bend value:	00 00H - 40 00H - 7F 7FH (-8192 - 0 - +8191)	

- \* Not received when the Tone Receive Bender parameter (PATCH/CONTROL) is OFF.
- \* Not received in Performance mode when the Receive Bender parameter (PERFORM/MIDI) is OFF.

# MIDI Implementation

## ■ Channel Mode Messages

\* Not received in Performance mode when the Receive Switch parameter (PERFORM/MIDI) is OFF.

### ● All Sounds Off (Controller number 120)

Status	2nd byte	3rd byte
BnH	78H	00H

n = MIDI channel number: 0H - FH (ch.1 - 16)

\* When this message is received, all notes currently sounding on the corresponding channel will be turned off.

### ● Reset All Controllers (Controller number 121)

Status	2nd byte	3rd byte
BnH	79H	00H

n = MIDI channel number: 0H - FH (ch.1 - 16)

\* When this message is received, the following controllers will be set to their reset values.

Controller	Reset value
Pitch Bend Change	+/-0 (center)
Polyphonic Key Pressure	0 (off)
Channel Pressure	0 (off)
Modulation	0 (off)
Breath Type	0 (min)
Expression	127 (max) However the controller will be at minimum.
Hold 1	0 (off)
Sostenuto	0 (off)
Soft	0 (off)
Hold 2	0 (off)
RPN	unset; previously set data will not change
NRPN	unset; previously set data will not change

### ● All Notes Off (Controller number 123)

Status	2nd byte	3rd byte
BnH	7BH	00H

n = MIDI channel number: 0H - FH (ch.1 - 16)

\* When All Notes Off is received, all notes on the corresponding channel will be turned off. However, if Hold 1 or Sostenuto is ON, the sound will be continued until these are turned off.

### ● OMNI OFF (Controller number 124)

Status	2nd byte	3rd byte
BnH	7CH	00H

n = MIDI channel number: 0H - FH (ch.1 - 16)

\* The same processing will be carried out as when All Notes Off is received.

### ● OMNI ON (Controller number 125)

Status	2nd byte	3rd byte
BnH	7DH	00H

n = MIDI channel number: 0H - FH (ch.1 - 16)

\* The same processing will be carried out as when All Notes Off is received. OMNI ON will not be turned on.

### ● MONO (Controller number 126)

Status	2nd byte	3rd byte
BnH	7EH	mmH

n = MIDI channel number: 0H - FH (ch.1 - 16)

mm = mono number: 00H - 10H (0 - 16)

\* The same processing will be carried out as when All Notes Off is received.

\* In Performance mode, the Part Mono/Poly parameter (PERFORM/PART VIEW/KEY MOD) will change.

## ● POLY (Controller number 127)

Status	2nd byte	3rd byte
BnH	7FH	00H

n = MIDI channel number: 0H - FH (ch.1 - 16)

\* The same processing will be carried out as when All Notes Off is received.

\* In Performance mode, the Part Mono/Poly parameter (PERFORM/PART VIEW/KEY MOD) will change.

## ■ System Realtime Message

### ● Timing Clock

Status
F8H

\* Received when Sync Mode parameter (SYSTEM/TEMPO/SYNC) is set to SLAVE-MIDI.

### ● Start

Status
FAH

\* Received when Sync Mode parameter (SYSTEM/TEMPO/SYNC) is set to SLAVE-MIDI or REMOTE.

### ● Continue

Status
FBH

\* Received when Sync Mode parameter (SYSTEM/TEMPO/SYNC) is set to SLAVE-MIDI or REMOTE.

### ● Stop

Status
FCH

\* Received when Sync Mode parameter (SYSTEM/TEMPO/SYNC) is set to SLAVE-MIDI or REMOTE.

### ● Active Sensing

Status
FEH

\* When Active Sensing is received, the unit will begin monitoring the intervals of all further messages. While monitoring, if the interval between messages exceeds 420 ms, the same processing will be carried out as when All Sounds Off, All Notes Off and Reset All Controllers are received, and message interval monitoring will be halted.



## ■ System Exclusive Message

Status	Data byte	Status
F0H	iiH, ddH, ....., eeH	F7H

F0H: System Exclusive Message status  
 ii = ID number: an ID number (manufacturer ID) to indicate the manufacturer whose Exclusive message this is. Roland's manufacturer ID is 41H. ID numbers 7EH and 7FH are extensions of the MIDI standard; Universal Non-realtime Messages (7EH) and Universal Realtime Messages (7FH).  
 dd, ..., ee = data: 00H - 7FH (0 - 127)  
 F7H: EOX (End Of Exclusive)

Of the System Exclusive messages received by this device, the Universal Non-realtime messages and the Universal Realtime messages and the Data Request (RQ1) messages and the Data Set (DT1) messages will be set automatically.

## ● Universal Non-realtime System Exclusive Messages

### ○ Identity Request Message

Status	Data byte	Status
F0H	7EH, dev, 06H, 01H	F7H

Byte	Explanation
F0H	Exclusive status
7EH	ID number (Universal Non-realtime Message)
dev	Device ID (dev: 10H - 1FH, 7FH)
06H	Sub ID#1 (General Information)
01H	Sub ID#2 (Identity Request)
F7H	EOX (End Of Exclusive)

\* When this message is received, Identity Reply message (p. 225) will be transmitted.

### ○ GM1 System On

Status	Data byte	Status
F0H	7EH, 7FH, 09H, 01H	F7H

Byte	Explanation
F0H	Exclusive status
7EH	ID number (Universal Non-realtime Message)
7FH	Device ID (Broadcast)
09H	Sub ID#1 (General MIDI Message)
01H	Sub ID#2 (General MIDI 1 On)
F7H	EOX (End Of Exclusive)

\* When this messages is received, this instrument will turn to the Performance mode.  
 \* Not received when the Receive GM System On parameter (SYSTEM/MIDI/RX) is OFF.

### ○ GM2 System On

Status	Data byte	Status
F0H	7EH 7FH 09H 03H	F7H

Byte	Explanation
F0H	Exclusive status
7EH	ID number (Universal Non-realtime Message)
7FH	Device ID (Broadcast)
09H	Sub ID#1 (General MIDI Message)
03H	Sub ID#2 (General MIDI 2 On)
F7H	EOX (End Of Exclusive)

\* When this messages is received, this instrument will turn to the Performance mode.  
 \* Not received when the Receive GM2 System On parameter (SYSTEM/MIDI/RX) is OFF.

### ○ GM System Off

Status	Data byte	Status
F0H	7EH, 7F, 09H, 02H	F7H

Byte	Explanation
F0H	Exclusive status
7EH	ID number (Universal Non-realtime Message)
7FH	Device ID (Broadcast)
09H	Sub ID#1 (General MIDI Message)
02H	Sub ID#2 (General MIDI Off)
F7H	EOX (End Of Exclusive)

\* When this messages is received, this instrument will return to the Performance mode.

## ● Universal Realtime System Exclusive Messages

### ○ Master Volume

Status	Data byte	Status
F0H	7FH, 7FH, 04H, 01H, llH, mmH	F7H

Byte	Explanation
F0H	Exclusive status
7FH	ID number (universal realtime message)
7FH	Device ID (Broadcast)
04H	Sub ID#1 (Device Control)
01H	Sub ID#2 (Master Volume)
llH	Master Volume lower byte
mmH	Master Volume upper byte
F7H	EOX (End Of Exclusive)

\* The lower byte (llH) of Master Volume will be handled as 00H.  
 \* The Master Level parameter (SYSTEM/GENERAL) will change.

### ○ Master Fine Tuning

Status	Data byte	Status
F0H	7FH, 7FH, 04H, 03H, llH, mmH	F7H

Byte	Explanation
F0H	Exclusive status
7FH	ID number (universal realtime message)
7FH	Device ID (Broadcast)
04H	Sub ID#1 (Device Control)
03H	Sub ID#2 (Master Fine Tuning)
llH	Master Fine Tuning LSB
mmH	Master Fine Tuning MSB
F7H	EOX (End Of Exclusive)

mm, ll: 00 00H - 40 00H - 7F 7FH (-100 - 0 - +99.9 [cents])

\* The Master Tune parameter (SYSTEM/GENERAL) will change.

### ○ Master Coarse Tuning

Status	Data byte	Status
F0H	7FH, 7FH, 04H, 04H, llH, mmH	F7

Byte	Explanation
F0H	Exclusive status
7FH	ID number (universal realtime message)
7FH	Device ID (Broadcast)
04H	Sub ID#1 (Device Control)
04H	Sub ID#2 (Master Coarse Tuning)
llH	Master Coarse Tuning LSB
mmH	Master Coarse Tuning MSB
F7H	EOX (End Of Exclusive)

llH: ignored (processed as 00H)  
 mmH: 28H - 40H - 58H (-24 - 0 - +24 [semitones])

\* The Master Key Shift parameter (SYSTEM/GENERAL) will change.

# MIDI Implementation

## ●Global Parameter Control

\* Not received in Patch mode and Piano mode.

### ○Reverb Parameters

Status	Data byte	Status
F0H	7FH, 7FH, 04H, 05H, 01H, 01H, 01H, 01H, 01H, ppH, vvH	F7H
Byte	Explanation	
F0H	Exclusive status	
7FH	ID number (universal realtime message)	
7FH	Device ID (Broadcast)	
04H	Sub ID#1 (Device Control)	
05H	Sub ID#2 (Global Parameter Control)	
01H	Slot path length	
01H	Parameter ID width	
01H	Value width	
01H	Slot path MSB	
01H	Slot path LSB (Effect 0101: Reverb)	
ppH	Parameter to be controlled.	
vvH	Value for the parameter.	
	pp=0      Reverb Type	
	vv = 00H      Small Room	
	vv = 01H      Medium Room	
	vv = 02H      Large Room	
	vv = 03H      Medium Hall	
	vv = 04H      Large Hall	
	vv = 08H      Plate	
	pp=1      Reverb Time	
	vv = 00H - 7FH      0 - 127	
F7H	EOX (End Of Exclusive)	

### ○Chorus Parameters

Status	Data byte	Status
F0H	7FH, 7FH, 04H, 05H, 01H, 01H, 01H, 01H, 02H, ppH, vvH	F7H
Byte	Explanation	
F0H	Exclusive status	
7FH	ID number (universal realtime message)	
7FH	Device ID (Broadcast)	
04H	Sub ID#1 (Device Control)	
05H	Sub ID#2 (Global Parameter Control)	
01H	Slot path length	
01H	Parameter ID width	
01H	Value width	
01H	Slot path MSB	
02H	Slot path LSB (Effect 0102: Chorus)	
ppH	Parameter to be controlled.	
vvH	Value for the parameter.	
	pp=0      Chorus Type	
	vv=0      Chorus1	
	vv=1      Chorus2	
	vv=2      Chorus3	
	vv=3      Chorus4	
	vv=4      FB Chorus	
	vv=5      Flanger	
	pp=1      Mod Rate	
	vv = 00H - 7FH      0 - 127	
	pp=2      Mod Depth	
	vv = 00H - 7FH      0 - 127	
	pp=3      Feedback	
	vv = 00H - 7FH      0 - 127	
	pp=4      Send To Reverb	
	vv = 00H - 7FH      0 - 127	
F7H	EOX (End Of Exclusive)	

## ○Channel Pressure

Status	Data byte	Status
F0H	7FH, 7FH, 09H, 01H, 0nH, ppH, rrH	F7H
Byte	Explanation	
F0H	Exclusive status	
7FH	ID number (universal realtime message)	
7FH	Device ID (Broadcast)	
09H	Sub ID#1 (Controller Destination Setting)	
01H	Sub ID#2 (Channel Pressure)	
0nH	MIDI Channel (00 - 0F)	
ppH	Controlled parameter	
rrH	Controlled range	
	pp=0      Pitch Control	
	rr = 28H - 58H      -24 - +24 [semitones]	
	pp=1      Filter Cutoff Control	
	rr = 00H - 7FH      -9600 - +9450 [cents]	
	pp=2      Amplitude Control	
	rr = 00H - 7FH      0 - 200%	
	pp=3      LFO Pitch Depth	
	rr = 00H - 7FH      0 - 600 [cents]	
	pp=4      LFO Filter Depth	
	rr = 00H - 7FH      0 - 2400 [cents]	
	pp=5      LFO Amplitude Depth	
	rr = 00H - 7FH      0 - 100%	
F7H	EOX (End Of Exclusive)	

### ○Controller

Status	Data byte	Status
F0H	7FH, 7FH, 09H, 03H, 0nH, ccH, ppH, rrH	F7H
Byte	Explanation	
F0H	Exclusive status	
7FH	ID number (universal realtime message)	
7FH	Device ID (Broadcast)	
09H	Sub ID#1 (Controller Destination Setting)	
03H	Sub ID#2 (Control Change)	
0nH	MIDI Channel (00 - 0F)	
ccH	Controller number (01 - 1F, 40 - 5F)	
ppH	Controlled parameter	
rrH	Controlled range	
	pp=0      Pitch Control	
	rr = 28H - 58H      -24 - +24 [semitones]	
	pp=1      Filter Cutoff Control	
	rr = 00H - 7FH      -9600 - +9450 [cents]	
	pp=2      Amplitude Control	
	rr = 00H - 7FH      0 - 200%	
	pp=3      LFO Pitch Depth	
	rr = 00H - 7FH      0 - 600 [cents]	
	pp=4      LFO Filter Depth	
	rr = 00H - 7FH      0 - 2400 [cents]	
	pp=5      LFO Amplitude Depth	
	rr = 00H - 7FH      0 - 100%	
F7H	EOX (End Of Exclusive)	

### ○Scale/Octave Tuning Adjust

Status	Data byte	Status
F0H	7EH, 7FH, 08H, 08H, fhH, ggH, hhH, ssH...	F7
Byte	Explanation	
F0H	Exclusive status	
7EH	ID number (Universal Non-realtime Message)	
7FH	Device ID (Broadcast)	
08H	Sub ID#1 (MIDI Tuning Standard)	
08H	Sub ID#2 (scale/octave tuning 1-byte form)	
fhH	Channel/Option byte 1	
	bits 0 to 1 = channel 15 to 16	
	bit 2 to 6 = Undefined	
ggH	Channel byte 2	
	bits 0 to 6 = channel 8 to 14	
hhH	Channel byte 3	
	bits 0 to 6 = channel 1 to 7	
ssH	12 byte tuning offset of 12 semitones from C to B	
	00H = -64 [cents]	
	40H = 0 [cents] (equal temperament)	
	7FH = +63 [cents]	
F7H	EOX (End Of Exclusive)	

## ○Key-based Instrument Controllers

Status	Data byte	Status
F0H	7FH, 7FH, 0AH, 01H, 0nH, kkH, nnH, vvH	F7H

Byte	Explanation
F0H	Exclusive status
7FH	ID number (universal realtime message)
7FH	Device ID (Broadcast)
0AH	Sub ID#1 (Key-Based Instrument Control)
01H	Sub ID#2 (Controller)
0nH	MIDI Channel (00 - 0FH)
kkH	Key Number
nnH	Control Number
vvH	Value
nn=07H	Level
vv = 00H - 7FH	0 - 200% (Relative)
nn=0AH	Pan
vv = 00H - 7FH	Left - Right (Absolute)
nn=5BH	Reverb Send
vv = 00H - 7FH	0 - 127 (Absolute)
nn=5D	Chorus Send
vv = 00H - 7FH	0 - 127 (Absolute)
:	:
F7	EOX (End Of Exclusive)

\* This parameter affects drum instruments only.

## ●Data Transmission

This instrument can use exclusive messages to exchange many varieties of internal settings with other devices.

The model ID of the exclusive messages used by this instrument is 00H 00H 25H.

### ○Data Request 1 (RQ1)

This message requests the other device to transmit data. The address and size indicate the type and amount of data that is requested.

When a Data Request message is received, if the device is in a state in which it is able to transmit data, and if the address and size are appropriate, the requested data is transmitted as a Data Set 1 (DT1) message. If the conditions are not met, nothing is transmitted.

Status	data byte	status
F0H	41H, dev, 00H, 00H, 25H, 11H, aaH, bbH, ccH, ddH, ssH, ttH, uuH, vvH, sum	F7H

Byte	Remarks
F0H	Exclusive status
41H	ID number (Roland)
dev	device ID (dev: 10H - 1FH, 7FH)
00H	model ID #1 (JUNO-STAGE)
00H	model ID #2 (JUNO-STAGE)
25H	model ID #3 (JUNO-STAGE)
11H	command ID (RQ1)
aaH	address MSB
bbH	address
ccH	address
ddH	address LSB
ssH	size MSB
ttH	size
uuH	size
vvH	size LSB
sum	checksum
F7H	EOX (End Of Exclusive)

\* The size of data that can be transmitted at one time is fixed for each type of data. And data requests must be made with a fixed starting address and size. Refer to the address and size given in **Parameter Address Map** (p. 226).

\* For the checksum, refer to p. 242.

\* Not received when the Receive Exclusive parameter (SYSTEM/MIDI/RX) is OFF.

## ○Data set 1 (DT1)

Status	Data byte	Status
F0H	41H, dev, 00H, 00H, 25H, 12H, aaH, bbH, F7H ccH, ddH, eeH, ... ffH, sum	

Byte	Explanation
F0H	Exclusive status
41H	ID number (Roland)
dev	Device ID (dev: 00H - 1FH, 7FH)
00H	Model ID #1 (JUNO-STAGE)
00H	Model ID #2 (JUNO-STAGE)
25H	Model ID #3 (JUNO-STAGE)
12H	Command ID (DT1)
aaH	Address MSB: upper byte of the starting address of the data to be sent
bbH	Address: upper middle byte of the starting address of the data to be sent
ccH	Address: lower middle byte of the starting address of the data to be sent
ddH	Address LSB: lower byte of the starting address of the data to be sent.
eeH	Data: the actual data to be sent. Multiple bytes of data are transmitted in order starting from the address.
:	:
ffH	Data
sum	Checksum
F7H	EOX (End Of Exclusive)

\* The amount of data that can be transmitted at one time depends on the type of data, and data will be transmitted from the specified starting address and size. Refer to the address and size given in **Parameter Address Map** (p. 226).

\* Data larger than 256 bytes will be divided into packets of 256 bytes or less, and each packet will be sent at an interval of about 20 ms.

\* Regarding the checksum, please refer to p. 242.

\* Not received when the Receive Exclusive parameter (SYSTEM/MIDI/RX) is OFF.

Status	Data byte	Status
F0H	41H, dev, 42H, 12H, aaH, bbH, ccH, ddH, ... eeH, sum	F7H

Byte	Explanation
F0H	Exclusive status
41H	ID number (Roland)
dev	Device ID (dev: 10H - 1FH, 7FH)
42H	Model ID (GS)
12H	Command ID (DT1)
aaH	Address MSB: upper byte of the starting address of the transmitted data
bbH	Address: middle byte of the starting address of the transmitted data
ccH	Address LSB: lower byte of the starting address of the transmitted data
ddH	Data: the actual data to be transmitted. Multiple bytes of data are transmitted starting from the address.
:	:
eeH	Data
sum	Checksum
F7H	EOX (End Of Exclusive)

\* The amount of data that can be transmitted at one time depends on the type of data, and data will be transmitted from the specified starting address and size. Refer to the address and size given in **Parameter Address Map** (p. 226).

\* Data larger than 256 bytes will be divided into packets of 256 bytes or less, and each packet will be sent at an interval of about 20 ms.

\* Regarding the checksum, please refer to p. 242.

\* Not received when the Receive Exclusive parameter (SYSTEM/MIDI/RX) is OFF.

## 2. Data Transmission

### ■ Channel Voice Messages

#### ● Note off

Status	2nd byte	3rd byte
8nH	kkH	vvH
n = MIDI channel number:	0H - FH (ch.1 - 16)	
kk = note number:	00H - 7FH (0 - 127)	
vv = note off velocity:	00H - 7FH (0 - 127)	

#### ● Note on

Status	2nd byte	3rd byte
9nH	kkH	vvH
n = MIDI channel number:	0H - FH (ch.1 - 16)	
kk = note number:	00H - 7FH (0 - 127)	
vv = note on velocity:	01H - 7FH (1 - 127)	

#### ● Control Change

\* By selecting a controller number that corresponds to the setting of parameters of controllers, the JUNO-STAGE can transmit any control change message.

##### ○ Bank Select (Controller number 0, 32)

Status	2nd byte	3rd byte
BnH	00H	mmH
BnH	20H	llH
n = MIDI channel number:	0H - FH (ch.1 - 16)	
mm, ll = Bank number:	00 00H - 7F 7FH (bank.1 - bank.16384)	

\* These messages are transmitted when Patch, Rhythm Set or Performance is selected. But not transmitted when Transmit Program Change or Transmit Bank Select parameter (SYSTEM/MIDI/TX) is OFF.

\* In Performance mode, these messages are not transmitted when External Bank Select MSB or External Program Number parameter (PERFORMANCE/CONTROL/CTRL SW/EXT) is OFF.

\* Although with the JUNO-STAGE you can select the Bank Select messages to be transmitted, be sure to refer to **Bank Select and Program Change Correspondence Chart** (p. 243) for the Bank Select messages transmitted when the JUNO-STAGE is select a Patch, Rhythm Set or Performance.

\* The Bank Select Numbers corresponding to SRX series should be referred to the SRX series owner's manual.

##### ○ Modulation (Controller number 1)

Status	2nd byte	3rd byte
BnH	01H	vvH
n = MIDI channel number:	0H - FH (ch.1 - 16)	
vv = Modulation depth:	00H - 7FH (0 - 127)	

##### ○ Breath type (Controller number 2)

Status	2nd byte	3rd byte
BnH	02H	vvH
n = MIDI channel number:	0H - FH (ch.1 - 16)	
vv = Control value:	00H - 7FH (0 - 127)	

\* JUNO-STAGE transmits this message when you operate ACTIVE EXPRESSION with the D Beam controller.

##### ○ Portamento Time (Controller number 5)

Status	2nd byte	3rd byte
BnH	05H	vvH
n = MIDI channel number:	0H - FH (ch.1 - 16)	
vv = Portamento Time:	00H - 7FH (0 - 127)	

##### ○ Data Entry (Controller number 6, 38)

Status	2nd byte	3rd byte
BnH	06H	mmH
BnH	26H	llH
n = MIDI channel number:	0H - FH (ch.1 - 16)	
mm, ll = the value of the parameter specified by RPN/NRPN		
mm = MSB, ll = LSB		

##### ○ Volume (Controller number 7)

Status	2nd byte	3rd byte
BnH	07H	vvH
n = MIDI channel number:	0H - FH (ch.1 - 16)	
vv = Volume:	00H - 7FH (0 - 127)	

\* In Performance mode, these messages are not transmitted when External Level parameter (PERFORMANCE/CONTROL/CTRL SW/EXT) is OFF.

##### ○ Panpot (Controller number 10)

Status	2nd byte	3rd byte
BnH	0AH	vvH
n = MIDI channel number:	0H - FH (ch.1 - 16)	
vv = Panpot:	00H - 40H - 7FH (Left - Center - Right),	

\* In Performance mode, these messages are not transmitted when External Pan parameter (PERFORMANCE/CONTROL/CTRL SW/EXT) is OFF.

##### ○ Expression (Controller number 11)

Status	2nd byte	3rd byte
BnH	0BH	vvH
n = MIDI channel number:	0H - FH (ch.1 - 16)	
vv = Expression:	00H - 7FH (0 - 127)	

##### ○ Hold 1 (Controller number 64)

Status	2nd byte	3rd byte
BnH	40H	vvH
n = MIDI channel number:	0H - FH (ch.1 - 16)	
vv = Control value:	00H - 7FH (0 - 127)	0-63 = OFF, 64-127 = ON

\* When Continuous Hold Pedal parameter (SYSTEM/(KBD/CTRL)/PEDAL) is OFF, just only 00H (OFF) and 7FH (ON) can be send as the control value.

##### ○ Portamento (Controller number 65)

Status	2nd byte	3rd byte
BnH	41H	vvH
n = MIDI channel number:	0H - FH (ch.1 - 16)	
vv = Control value:	00H - 7FH (0 - 127)	0 - 63 = OFF, 64 - 127 = ON

##### ○ Resonance (Controller number 71)

Status	2nd byte	3rd byte
BnH	47H	vvH
n = MIDI channel number:	0H - FH (ch.1 - 16)	
vv = Resonance value (relative change):	00H - 40H - 7FH (-64 - 0 - +63)	

##### ○ Release Time (Controller number 72)

Status	2nd byte	3rd byte
BnH	48H	vvH
n = MIDI channel number:	0H - FH (ch.1 - 16)	
vv = Release Time value (relative change):	00H - 40H - 7FH (-64 - 0 - +63)	

##### ○ Attack time (Controller number 73)

Status	2nd byte	3rd byte
BnH	49H	vvH
n = MIDI channel number:	0H - FH (ch.1 - 16)	
vv = Attack time value (relative change):	00H - 40H - 7FH (-64 - 0 - +63)	

##### ○ Cutoff (Controller number 74)

Status	2nd byte	3rd byte
BnH	4AH	vvH
n = MIDI channel number:	0H - FH (ch.1 - 16)	
vv = Cutoff value (relative change):	00H - 40H - 7FH (-64 - 0 - +63)	

##### ○ General Purpose Controller 5 (Controller number 80)

Status	2nd byte	3rd byte
BnH	50H	vvH
n = MIDI channel number:	0H - FH (ch.1 - 16)	
vv = Control value:	00H - 7FH (0 - 127)	

##### ○ General Purpose Controller 6 (Controller number 81)

Status	2nd byte	3rd byte
BnH	51H	vvH
n = MIDI channel number:	0H - FH (ch.1 - 16)	
vv = Control value:	00H - 7FH (0 - 127)	

## ○ General Purpose Controller 7 (Controller number 82)

<u>Status</u>	<u>2nd byte</u>	<u>3rd byte</u>
BnH	52H	vvH
n = MIDI channel number:		0H - FH (ch.1 - 16)
vv = Control value:		00H - 7FH (0 - 127)

## ○ General Purpose Controller 8 (Controller number 83)

<u>Status</u>	<u>2nd byte</u>	<u>3rd byte</u>
BnH	53H	vvH
n = MIDI channel number:		0H - FH (ch.1 - 16)
vv = Control value:		00H - 7FH (0 - 127)

## ○ Portamento control (Controller number 84)

<u>Status</u>	<u>2nd byte</u>	<u>3rd byte</u>
BnH	54H	kkH
n = MIDI channel number:		0H - FH (ch.1 - 16)
kk = source note number:		00H - 7FH (0 - 127)

## ● Program Change

<u>Status</u>	<u>2nd byte</u>	
CnH	ppH	
n = MIDI channel number:		0H - FH (ch.1 - 16)
pp = Program number:		00H - 7FH (prog.1 - prog.128)

\* These messages are transmitted when Patch, Rhythm Set or Performance is selected. But not transmitted when Transmit Program Change parameter (SYSTEM/MIDI/TX) is OFF.

\* In Performance mode, these messages are not transmitted when External Program Number parameter (PERFORMANCE/CONTROL/CTRL SW/EXT) is OFF.

## ● Channel Pressure

<u>Status</u>	<u>2nd byte</u>	
DnH	vvH	
n = MIDI channel number:		0H - FH (ch.1 - 16)
vv = Channel Pressure:		00H - 7FH (0 - 127)

## ● Pitch Bend Change

<u>Status</u>	<u>2nd byte</u>	<u>3rd byte</u>
EnH	llH	mmH
n = MIDI channel number:		0H - FH (ch.1 - 16)
mm, ll = Pitch Bend value:		00 00H - 40 00H - 7F 7FH (-8192 - 0 - +8191)

## ■ Channel Mode Messages

### ● MONO (Controller number 126)

<u>Status</u>	<u>2nd byte</u>	<u>3rd byte</u>
BnH	7EH	mmH
n = MIDI channel number:		0H - FH (ch.1 - 16)
mm = mono number:		00H - 10H (0 - 16)

### ● POLY (Controller number 127)

<u>Status</u>	<u>2nd byte</u>	<u>3rd byte</u>
BnH	7FH	00H
n = MIDI channel number:		0H - FH (ch.1 - 16)

## ■ System Realtime Messages

\* Sent when Sync Output parameter (SYSTEM/TEMPO/SYNC) is set to ON.

### ● Timing Clock

<u>Status</u>
F8H

### ● Start

<u>Status</u>
FAH

### ● Continue

<u>Status</u>
FBH

### ● Stop

<u>Status</u>
FCH

### ● Active Sensing

<u>Status</u>
FEH

\* This message is transmitted at intervals of approximately 250 msec.

\* This message is not sent when Transmit Active Sensing parameter (SYSTEM/MIDI/TX) is OFF.

## ■ System Exclusive Messages

Universal Non-realtime System Exclusive Message" and Data Set 1 (DT1) are the only System Exclusive messages transmitted by the JUNO-STAGE.

### ● Universal Non-realtime System Exclusive Message

#### ○ Identity Reply Message (JUNO-STAGE)

Receiving Identity Request Message (p. 221), the JUNO-STAGE send this message.

<u>Status</u>	<u>Data byte</u>	<u>Status</u>
F0H	7EH, dev, 06H, 02H, 41H, 25H, 02H, 00H, 01H, 00H, 03H, 00H, 00H	F7H

<u>Byte</u>	<u>Explanation</u>
F0H	Exclusive status
7EH	ID number (Universal Non-realtime Message)
dev	Device ID (dev: 10H - 1FH)
06H	Sub ID#1 (General Information)
02H	Sub ID#2 (Identity Reply)
41H	ID number (Roland)
25H 02H	Device family code
00H 01H	Device family number code
00H 03H 00H 00H	Software revision level
F7H	EOX (End of Exclusive)

## ● Data Transmission

### ○ Data set 1 (DT1)

Status	Data byte	Status
F0H	41H, dev, 00H, 00H, 25H, 12H, aaH, bbH, ccH, ddH, eeH, ... fFH, sum	F7H

Byte	Explanation
F0H	Exclusive status
41H	ID number (Roland)
dev	Device ID (dev: 00H - 1FH, 7FH)
00H	Model ID #1 (JUNO-STAGE)
00H	Model ID #2 (JUNO-STAGE)
25H	Model ID #3 (JUNO-STAGE)
12H	Command ID (DT1)
aaH	Address MSB: upper byte of the starting address of the data to be sent
bbH	Address: upper middle byte of the starting address of the data to be sent
ccH	Address: lower middle byte of the starting address of the data to be sent
ddH	Address LSB: lower byte of the starting address of the data to be sent
eeH	Data: the actual data to be sent. Multiple bytes of data are transmitted in order starting from the address.
:	:
fFH	Data
sum	Checksum
F7H	EOX (End Of Exclusive)

\* The amount of data that can be transmitted at one time depends on the type of data, and data will be transmitted from the specified starting address and size. Refer to the address and size given in **Parameter Address Map** (p. 226).

\* Data larger than 256 bytes will be divided into packets of 256 bytes or less, and each packet will be sent at an interval of about 20 ms.

## 3. Parameter Address Map

\* Transmission of “#” marked address is divided to some packets. For example, ABH in hexadecimal notation will be divided to 0AH and 0BH, and is sent/received in this order.

\* “<\*>” marked address or parameters are ignored when the JUNO-STAGE received them.

### 3.1 JUNO-STAGE (ModelID = 00H 00H 25H)

Start Address	Description
01 00 00 00	Setup
02 00 00 00	System
0F 00 00 00	(for editor)
10 00 00 00	Temporary Performance
11 00 00 00	Temporary Patch/Rhythm (Performance Mode Part 1)
11 20 00 00	Temporary Patch/Rhythm (Performance Mode Part 2)
:	:
14 60 00 00	Temporary Patch/Rhythm (Performance Mode Part 16)
1E 00 00 00	Temporary Rhythm Pattern
1E 01 00 00	Temporary Arpeggio (Performance Mode)
1E 02 00 00	Temporary Chord (Performance Mode)
1E 03 00 00	Temporary Rhythm Group (Performance Mode)
1E 11 00 00	Temporary Arpeggio (Patch Mode)
1E 12 00 00	Temporary Chord (Patch Mode)
1E 13 00 00	Temporary Rhythm Group (Patch Mode)
1F 00 00 00	Temporary Patch/Rhythm (Patch Mode Part 1)
1F 20 00 00	Temporary Patch/Rhythm (Patch Mode Part 2)
:	:
20 00 00 00	User Performance (01)
20 01 00 00	User Performance (02)
:	:
20 3F 00 00	User Performance (64)
:	:
30 00 00 00	User Patch (001)
30 01 00 00	User Patch (002)
:	:
31 7F 00 00	User Patch (256)
:	:
40 00 00 00	User Rhythm Set (001)
40 10 00 00	User Rhythm Set (002)
:	:
43 70 00 00	User Rhythm Set (032)
:	:
50 00 00 00	User Chord (001)
50 00 02 00	User Chord (002)
:	:
50 00 7E 00	User Chord (064)
:	:
51 00 00 00	User Arpeggio (001)
51 01 00 00	User Arpeggio (002)
:	:
51 7F 00 00	User Arpeggio (128)
:	:
58 00 00 00	User Rhythm Group (001)
58 00 01 00	User Rhythm Group (002)
:	:
58 00 1F 00	User Rhythm Group (032)
:	:
59 00 00 00	User Rhythm Pattern (001)
59 01 00 00	User Rhythm Pattern (002)
:	:
5A 7F 00 00	User Rhythm Pattern (256)

#### \* System

Offset Address	Description
00 00 00	System Common
00 40 00	System Controller

#### \* Temporary Patch/Rhythm

Offset Address	Description
00 00 00	Temporary Patch
10 00 00	Temporary Rhythm

#### \* Performance

Offset Address	Description
00 00 00	Performance Common
00 02 00	Performance Common MFX1
00 04 00	Performance Common Chorus
00 06 00	Performance Common Reverb
00 08 00	Performance Common MFX2
00 0A 00	Performance Common MFX3
00 10 00	Performance MIDI (Channel 1)
00 11 00	Performance MIDI (Channel 2)
:	:
00 1F 00	Performance MIDI (Channel 16)
00 20 00	Performance Part (Part 1)
00 21 00	Performance Part (Part 2)
:	:
00 2F 00	Performance Part (Part 16)
00 50 00	Performance Zone (Channel 1)
00 51 00	Performance Zone (Channel 2)
:	:
00 5F 00	Performance Zone (Channel 16)
00 60 00	Performance Controller

#### \* Patch

Offset Address	Description
00 00 00	Patch Common
00 02 00	Patch Common MFX
00 04 00	Patch Common Chorus
00 06 00	Patch Common Reverb
00 10 00	Patch TMT (Tone Mix Table)
00 20 00	Patch Tone (Tone 1)
00 22 00	Patch Tone (Tone 2)
00 24 00	Patch Tone (Tone 3)

00 26 00 | Patch Tone (Tone 4)

## \* Rhythm

Offset Address	Description
00 00 00	Rhythm Common
00 02 00	Rhythm Common MFX
00 04 00	Rhythm Common Chorus
00 06 00	Rhythm Common Reverb
00 10 00	Rhythm Tone (Key # 21)
00 12 00	Rhythm Tone (Key # 22)
:	:
01 3E 00	Rhythm Tone (Key # 108)

## \* Arpeggio (Rhythm Pattern)

Offset Address	Description
00 00 00	Arpeggio Common
00 10 00	Arpeggio Pattern (Note 1)
00 11 00	Arpeggio Pattern (Note 2)
:	:
00 1F 00	Arpeggio Pattern (Note 16)

## \* Chord

Offset Address	Description
00 00 00	Chord Pattern

## \* Rhythm Group

Offset Address	Description
00 00 00	Rhythm Group

## \* Setup

Offset Address	Description
00 00	0000 0aaa Sound Mode (0 - 5) PATCH, PERFORM, GM1, GM2, GS, PIANO
00 01	0aaa 0aaa Performance Bank Select MSB (CC# 0) (0 - 127)
00 02	0aaa 0aaa Performance Bank Select LSB (CC# 32) (0 - 127)
00 03	0aaa 0aaa Performance Program Number (PC) (0 - 127)
00 04	0aaa 0aaa Kbd Patch Bank Select MSB (CC# 0) (0 - 127)
00 05	0aaa 0aaa Kbd Patch Bank Select LSB (CC# 32) (0 - 127)
00 06	0aaa 0aaa Kbd Patch Program Number (PC) (0 - 127)
00 07	0aaa 0aaa Rhy Patch Bank Select MSB (CC# 0) (0 - 127)
00 08	0aaa 0aaa Rhy Patch Bank Select LSB (CC# 32) (0 - 127)
00 09	0aaa 0aaa Rhy Patch Program Number (PC) (0 - 127)
00 0A	0000 000a MFX1 Switch (0 - 1) BYPASS, ON
00 0B	0000 000a MFX2 Switch (0 - 1) BYPASS, ON
00 0C	0000 000a MFX3 Switch (0 - 1) BYPASS, ON
00 0D	0000 000a Chorus Switch (0 - 1) OFF, ON
00 0E	0000 000a Reverb Switch (0 - 1) OFF, ON
00 0F	0000 000a Input Effect Switch (0 - 1) OFF, ON
00 10	0000 000a (reserve) <*> (0 - 1) OFF, ON
00 11	0000 000a (reserve) <*> (0 - 1) OFF, ON
00 12	0000 aaaa Transpose Value (59 - 70) -5 - +6
00 13	0000 0aaa Octave Shift (61 - 67) -3 - +3
00 14	0000 0aaa D Beam Select (0 - 3) OFF, (reserv), SOLO-SYN, ASGN
00 15	0000 00aa (reserve) <*> (0 - 8) 04_, 08_, 08L, 08H, 08t.
00 16	0000 000a (reserve) <*> (0 - 9) 16_, 16L, 16H, 16t.
00 17	0aaa 0aaa Arp/Ptn Grid (0 - 9) 30, 40, 50, 60, 70, 80, 90, 100, 120, PUL
00 18	0aaa 0aaa Arp/Ptn Duration (0 - 1) OFF, ON
00 19	0000 000a Arpeggio Switch (0 - 1) USER, PRESET
00 1A	0aaa 0aaa Arpeggio Bank (0 - 127) 1 - 128
00 1B	0aaa 0aaa Arpeggio Style (0 - 127) 1 - 128
00 1C	0aaa 0aaa Arpeggio Motif (0 - 11) UP/L, UP/H, UP/_ , dn/L, dn/H, dn/_ , UG/L, UG/H, UG/_ , rn/L, rn/_ , PHRASE
00 1D	0000 0aaa Arpeggio Octave Range (61 - 67) -3 - +3
00 1E	0000 000a Arpeggio Hold (0 - 1) OFF, ON
00 1F	0aaa 0aaa Arpeggio Accent Rate (0 - 100)
00 20	0aaa 0aaa Arpeggio Velocity (0 - 127) REAL, 1 - 127
00 21	0000 000a (reserve) <*> (0 - 1) OFF, ON
00 22	0aaa 0aaa Rhythm Pattern Bank (0 - 1) USER, PRESET
00 23	0000 aaaa Rhythm Pattern Style (0 - 255) 1 - 256
00 24	0000 bbbb Rhythm Pattern Group Bank (0 - 1) USER, PRESET
00 25	0000 000a Rhythm Pattern Group Number (0 - 31) 1 - 32
00 26	0aaa 0aaa Rhythm Pattern Accent Rate (0 - 100)
00 27	0aaa 0aaa Rhythm Pattern Velocity (1 - 127)
00 28	0000 000a Chord Switch (0 - 1) OFF, ON
00 29	0000 000a Chord Bank (0 - 1) OFF, ON
00 2A	0aaa 0aaa Chord Form (0 - 63) USER, PRESET
00 2B	00aa 0aaa Chord Form (0 - 63) USER, PRESET
00 2C	0000 000a (reserve) <*> (0 - 1) OFF, ON
00 2D	0000 000a (reserve) <*> (0 - 1) OFF, ON

00 2E	0000 000a (reserve) <*> (0 - 1) OFF, ON
00 2F	0000 000a (reserve) <*> (0 - 2) UP, DOWN, ALTERNATE
00 30	0aaa 0aaa (reserve) <*> (0 - 32) AUTO, 1 - 32
00 31	0000 000a Rolled Chord (0 - 1) OFF, ON
00 32	0000 00aa Rolled Chord Type (0 - 2) UP, DOWN, ALTERNATE
00 33	00aa 0aaa Arpeggio Step (0 - 32) AUTO, 1 - 32
00 00 00 34	Total Size

## \* System Common

Offset Address	Description
00 00	0000 aaaa Master Tune (24 - 2024) 0000 bbbb -100.0 - 100.0 [cent] 0000 cccc (40 - 88) 0000 dddd (0 - 1)
00 04	00aa 0aaa Master Key Shift (0 - 127) -24 - +24
00 05	0aaa 0aaa Master Level (0 - 127)
00 06	0000 000a Scale Tune Switch (0 - 1) OFF, ON
00 07	0000 000a Patch Remain (0 - 1) OFF, ON
00 08	0000 000a Mix/Parallel <*> ---, PARALLEL
00 09	000a 0aaa Performance Control Channel (0 - 16) 1 - 16, OFF
00 0A	0000 0aaa Kbd Patch Rx/Tx Channel (0 - 15) 1 - 16
00 0B	0000 0aaa (reserve) <*> (0 - 127)
00 0C	0aaa 0aaa Patch Scale Tune for C (0 - 127) -64 - +63
00 0D	0aaa 0aaa Patch Scale Tune for C# (0 - 127) -64 - +63
00 0E	0aaa 0aaa Patch Scale Tune for D (0 - 127) -64 - +63
00 0F	0aaa 0aaa Patch Scale Tune for D# (0 - 127) -64 - +63
00 10	0aaa 0aaa Patch Scale Tune for E (0 - 127) -64 - +63
00 11	0aaa 0aaa Patch Scale Tune for F (0 - 127) -64 - +63
00 12	0aaa 0aaa Patch Scale Tune for F# (0 - 127) -64 - +63
00 13	0aaa 0aaa Patch Scale Tune for G (0 - 127) -64 - +63
00 14	0aaa 0aaa Patch Scale Tune for G# (0 - 127) -64 - +63
00 15	0aaa 0aaa Patch Scale Tune for A (0 - 127) -64 - +63
00 16	0aaa 0aaa Patch Scale Tune for A# (0 - 127) -64 - +63
00 17	0aaa 0aaa Patch Scale Tune for B (0 - 127) -64 - +63
00 18	0aaa 0aaa System Control 1 Source (0 - 97) OFF, CC01 - CC31, CC33 - CC95, BEND, APT
00 19	0aaa 0aaa System Control 2 Source (0 - 97) OFF, CC01 - CC31, CC33 - CC95, BEND, APT
00 1A	0aaa 0aaa System Control 3 Source (0 - 97) OFF, CC01 - CC31, CC33 - CC95, BEND, APT
00 1B	0aaa 0aaa System Control 4 Source (0 - 97) OFF, CC01 - CC31, CC33 - CC95, BEND, APT
00 1C	0000 000a Receive Program Change (0 - 1) OFF, ON
00 1D	0000 000a Receive Bank Select (0 - 1) OFF, ON
00 00 00 1E	Total Size

## \* System Controller

Offset Address	Description
00 00	0000 000a Transmit Program Change (0 - 1) OFF, ON
00 01	0000 000a Transmit Bank Select (0 - 1) OFF, ON
00 02	0aaa 0aaa Keyboard Velocity (0 - 127) REAL, 1 - 127
00 03	0000 00aa Keyboard Sens (0 - 2) LIGHT, MEDIUM, HEAVY
00 04	0aaa 0aaa (reserve) <*> (0 - 107)
00 05	0000 0aaa Hold Pedal Polarity (0 - 1) STANDARD, REVERSE
00 06	0000 000a Continuous Hold Pedal (0 - 1) OFF, ON
00 07	0aaa 0aaa Pedal Assign (0 - 107) CC01 - CC31, CC33 - CC95, BEND-UP, BEND-DOWN, APT, OCT-UP, OCT-DOWN, START/STOP, TAP-TEMPO, PROG-UP, PROG-DOWN, FAV-UP, FAV-DOWN, ARP-RHY-SW, CHD-SW
00 08	0000 0aaa Pedal Polarity (0 - 1) STANDARD, REVERSE
00 09	0000 aaaa Beam Sens (1 - 10) 1 - 10
00 0A	0aaa 0aaa Beam Assign (0 - 104) CC01 - CC31, CC33 - CC95, BEND-UP, BEND-DOWN, APT, START/STOP, TAP-TEMPO, ARP-GRID, ARP-DUR, ARP-MOTIF, ARP-OCT-UP, ARP-OCT-DW, ARP-STEP, APTERTOUCH
00 0B	0aaa 0aaa Beam Range Lower (0 - 127)
00 0C	0aaa 0aaa Beam Range Upper (0 - 127)
00 0D	0000 0aaa Beam Trigger Pad (0 - 15) 1 - 16
00 0E	0aaa 0aaa Beam Trigger Velo (1 - 127)
00 0F	0aaa 0aaa Beam Trigger Mode (0 - 1) MOMENTARY, LATCH
00 10	0aaa 0aaa (reserve) <*> (0 - 1) OFF, ON

# MIDI Implementation

00 11	0aaa aaaa	(reserve) <*>	
00 12	0aaa aaaa	(reserve) <*>	
00 13	0aaa aaaa	(reserve) <*>	
00 14	0aaa aaaa	Switch 1 Assign	(0 - 14) TRNS-UP, TRNS-DW, TAP-TEMPO, MONO/POLY, PORTAMENTO, HOLD1, MPX1-SW, MPX2-SW, MPX3-SW, CHO-SW, REV-SW, SYS-CTRL1, SYS-CTRL2, SYS-CTRL3, SYS-CTRL4
00 15	0aaa aaaa	Switch 2 Assign	(0 - 14) TRNS-UP, TRNS-DW, TAP-TEMPO, MONO/POLY, PORTAMENTO, HOLD1, MPX1-SW, MPX2-SW, MPX3-SW, CHO-SW, REV-SW, SYS-CTRL1, SYS-CTRL2, SYS-CTRL3, SYS-CTRL4
00 16	0aaa aaaa	(reserve) <*>	
00 17	0000 00aa	(reserve) <*>	
00 18	0aaa aaaa	(reserve) <*>	
00 19	0000 aaaa	(reserve) <*>	
00 1A	0aaa aaaa	(reserve) <*>	
00 1B	0aaa aaaa	(reserve) <*>	
00 1C	0aaa aaaa	(reserve) <*>	
00 1D	0aaa aaaa	(reserve) <*>	
00 1E	0aaa aaaa	(reserve) <*>	
00 1F	0aaa aaaa	(reserve) <*>	
00 20	0aaa aaaa	(reserve) <*>	
00 21	0aaa aaaa	(reserve) <*>	
00 22	0aaa aaaa	(reserve) <*>	
00 23	0aaa aaaa	(reserve) <*>	
00 24	0aaa aaaa	(reserve) <*>	
00 25	0aaa aaaa	(reserve) <*>	
00 26	0aaa aaaa	(reserve) <*>	
00 27	0aaa aaaa	(reserve) <*>	
00 28	0aaa aaaa	(reserve) <*>	
00 29	0aaa aaaa	(reserve) <*>	
00 2A	0aaa aaaa	(reserve) <*>	
00 2B	0aaa aaaa	(reserve) <*>	
00 2C	0aaa aaaa	(reserve) <*>	
00 2D	0aaa aaaa	(reserve) <*>	
00 2E	0aaa aaaa	(reserve) <*>	
00 2F	0aaa aaaa	(reserve) <*>	
00 30	0aaa aaaa	(reserve) <*>	
00 31	0aaa aaaa	(reserve) <*>	
00 32	0aaa aaaa	(reserve) <*>	
00 33	0aaa aaaa	(reserve) <*>	
00 34	0aaa aaaa	(reserve) <*>	
00 35	0aaa aaaa	(reserve) <*>	
00 36	0aaa aaaa	(reserve) <*>	
00 37	0aaa aaaa	(reserve) <*>	
00 38	0aaa aaaa	(reserve) <*>	
00 39	0aaa aaaa	(reserve) <*>	
00 3A	0aaa aaaa	(reserve) <*>	
00 3B	0aaa aaaa	(reserve) <*>	
00 3C	0aaa aaaa	(reserve) <*>	
00 3D	0aaa aaaa	(reserve) <*>	
00 3E	0aaa aaaa	(reserve) <*>	
00 40	0aaa aaaa	(reserve) <*>	
00 41	0aaa aaaa	(reserve) <*>	
00 42	0aaa aaaa	(reserve) <*>	
00 43	0aaa aaaa	(reserve) <*>	
00 44	0aaa aaaa	(reserve) <*>	
00 45	0aaa aaaa	(reserve) <*>	
00 46	0aaa aaaa	(reserve) <*>	
00 47	0aaa aaaa	(reserve) <*>	
00 48	0aaa aaaa	(reserve) <*>	
00 49	0aaa aaaa	(reserve) <*>	
00 4A	0aaa aaaa	(reserve) <*>	
00 4B	0aaa aaaa	(reserve) <*>	
00 4C	0000 000a	Switch 1 Type	(0 - 1) LATCH, MOMENTARY
00 4D	0000 000a	Switch 2 Type	(0 - 1) LATCH, MOMENTARY
00 00 00 4E	Total Size		

## \* Performance Common

Offset	Address	Description	
00 00	0aaa aaaa	Performance Name 1	(32 - 127) 32 - 127 [ASCII]
00 01	0aaa aaaa	Performance Name 2	(32 - 127) 32 - 127 [ASCII]
00 02	0aaa aaaa	Performance Name 3	(32 - 127) 32 - 127 [ASCII]
00 03	0aaa aaaa	Performance Name 4	(32 - 127) 32 - 127 [ASCII]
00 04	0aaa aaaa	Performance Name 5	(32 - 127) 32 - 127 [ASCII]
00 05	0aaa aaaa	Performance Name 6	(32 - 127) 32 - 127 [ASCII]
00 06	0aaa aaaa	Performance Name 7	(32 - 127) 32 - 127 [ASCII]
00 07	0aaa aaaa	Performance Name 8	(32 - 127) 32 - 127 [ASCII]
00 08	0aaa aaaa	Performance Name 9	(32 - 127) 32 - 127 [ASCII]
00 09	0aaa aaaa	Performance Name 10	(32 - 127) 32 - 127 [ASCII]
00 0A	0aaa aaaa	Performance Name 11	(32 - 127) 32 - 127 [ASCII]
00 0B	0aaa aaaa	Performance Name 12	(32 - 127) 32 - 127 [ASCII]
00 0C	00aa aaaa	Solo Part Select	(0 - 16) OFF, 1 - 16
00 0D	000a aaaa	MPX1 Control Channel	(0 - 16) 1 - 16, OFF
00 0E	0000 000a	(reserve) <*>	
00 0F	0000 000a	(reserve) <*>	
00 10	0aaa aaaa	Voice Reserve 1	(0 - 64) 0 - 63, FULL
00 11	0aaa aaaa	Voice Reserve 2	(0 - 64) 0 - 63, FULL
00 12	0aaa aaaa	Voice Reserve 3	(0 - 64) 0 - 63, FULL
00 13	0aaa aaaa	Voice Reserve 4	(0 - 64) 0 - 63, FULL
00 14	0aaa aaaa	Voice Reserve 5	(0 - 64) 0 - 63, FULL
00 15	0aaa aaaa	Voice Reserve 6	(0 - 64) 0 - 63, FULL
00 16	0aaa aaaa	Voice Reserve 7	(0 - 64) 0 - 63, FULL
00 17	0aaa aaaa	Voice Reserve 8	(0 - 64) 0 - 63, FULL
00 18	0aaa aaaa	Voice Reserve 9	(0 - 64) 0 - 63, FULL

00 19	0aaa aaaa	Voice Reserve 10	(0 - 64) 0 - 63, FULL
00 1A	0aaa aaaa	Voice Reserve 11	(0 - 64) 0 - 63, FULL
00 1B	0aaa aaaa	Voice Reserve 12	(0 - 64) 0 - 63, FULL
00 1C	0aaa aaaa	Voice Reserve 13	(0 - 64) 0 - 63, FULL
00 1D	0aaa aaaa	Voice Reserve 14	(0 - 64) 0 - 63, FULL
00 1E	0aaa aaaa	Voice Reserve 15	(0 - 64) 0 - 63, FULL
00 1F	0aaa aaaa	Voice Reserve 16	(0 - 64) 0 - 63, FULL
00 20	0aaa aaaa	(reserve) <*>	
00 21	0aaa aaaa	(reserve) <*>	
00 22	0aaa aaaa	(reserve) <*>	
00 23	0aaa aaaa	(reserve) <*>	
00 24	0aaa aaaa	(reserve) <*>	
00 25	0aaa aaaa	(reserve) <*>	
00 26	0aaa aaaa	(reserve) <*>	
00 27	0aaa aaaa	(reserve) <*>	
00 28	0aaa aaaa	(reserve) <*>	
00 29	0aaa aaaa	(reserve) <*>	
00 2A	0aaa aaaa	(reserve) <*>	
00 2B	0aaa aaaa	(reserve) <*>	
00 2C	0aaa aaaa	(reserve) <*>	
00 2D	0aaa aaaa	(reserve) <*>	
00 2E	0aaa aaaa	(reserve) <*>	
00 2F	0aaa aaaa	(reserve) <*>	
00 30	00aa aaaa	MPX1 Source	(0 - 16) PERFORM, 1 - 16
00 31	00aa aaaa	MPX2 Source	(0 - 16) PERFORM, 1 - 16
00 32	00aa aaaa	MPX3 Source	(0 - 16) PERFORM, 1 - 16
00 33	00aa aaaa	Chorus Source	(0 - 16) PERFORM, 1 - 16
00 34	00aa aaaa	Reverb Source	(0 - 16) PERFORM, 1 - 16
00 35	00aa aaaa	MPX2 Control Channel	(0 - 16) 1 - 16, OFF
00 36	00aa aaaa	MPX3 Control Channel	(0 - 16) 1 - 16, OFF
00 37	0000 aaaa	MPX Structure	(0 - 15) 1 - 16
00 00 00 38	Total Size		

## \* Performance Common MFX

Offset	Address	Description	
00 00	0aaa aaaa	MPX Type	(0 - 79)
00 01	0aaa aaaa	MPX Dry Send Level	(0 - 127)
00 02	0aaa aaaa	MPX Chorus Send Level	(0 - 127)
00 03	0aaa aaaa	MPX Reverb Send Level	(0 - 127)
00 04	0000 00aa	MPX Output Assign <*>	A, ---, ---, ---
00 05	0aaa aaaa	MPX Control 1 Source	(0 - 101) OFF, CC01 - CC31, CC33 - CC95, BEND, APT, SYS1 - SYS4
00 06	0aaa aaaa	MPX Control 1 Sens	(1 - 127) -63 - +63
00 07	0aaa aaaa	MPX Control 2 Source	(0 - 101) OFF, CC01 - CC31, CC33 - CC95, BEND, APT, SYS1 - SYS4
00 08	0aaa aaaa	MPX Control 2 Sens	(1 - 127) -63 - +63
00 09	0aaa aaaa	MPX Control 3 Source	(0 - 101) OFF, CC01 - CC31, CC33 - CC95, BEND, APT, SYS1 - SYS4
00 0A	0aaa aaaa	MPX Control 3 Sens	(1 - 127) -63 - +63
00 0B	0aaa aaaa	MPX Control 4 Source	(0 - 101) OFF, CC01 - CC31, CC33 - CC95, BEND, APT, SYS1 - SYS4
00 0C	0aaa aaaa	MPX Control 4 Sens	(1 - 127) -63 - +63
00 0D	000a aaaa	MPX Control Assign 1	(0 - 16) OFF, 1 - 16
00 0E	000a aaaa	MPX Control Assign 2	(0 - 16) OFF, 1 - 16
00 0F	000a aaaa	MPX Control Assign 3	(0 - 16) OFF, 1 - 16
00 10	000a aaaa	MPX Control Assign 4	(0 - 16) OFF, 1 - 16
# 00 11	0000 aaaa 0000 bbbb 0000 cccc 0000 dddd	MPX Parameter 1	(12768 - 52768) -20000 - +20000
# 00 15	0000 aaaa 0000 bbbb 0000 cccc 0000 dddd	MPX Parameter 2	(12768 - 52768) -20000 - +20000
# 00 19	0000 aaaa 0000 bbbb 0000 cccc 0000 dddd	MPX Parameter 3	(12768 - 52768) -20000 - +20000
# 00 1D	0000 aaaa 0000 bbbb 0000 cccc 0000 dddd	MPX Parameter 4	(12768 - 52768) -20000 - +20000
# 00 21	0000 aaaa 0000 bbbb 0000 cccc 0000 dddd	MPX Parameter 5	(12768 - 52768) -20000 - +20000
# 00 25	0000 aaaa 0000 bbbb 0000 cccc 0000 dddd	MPX Parameter 6	(12768 - 52768) -20000 - +20000
# 00 29	0000 aaaa 0000 bbbb 0000 cccc 0000 dddd	MPX Parameter 7	(12768 - 52768) -20000 - +20000
# 00 2D	0000 aaaa 0000 bbbb 0000 cccc 0000 dddd	MPX Parameter 8	(12768 - 52768) -20000 - +20000
# 00 31	0000 aaaa 0000 bbbb 0000 cccc	MPX Parameter 9	(12768 - 52768) -20000 - +20000



#	00 35	0000 dddd 0000 aaaa 0000 bbbb 0000 cccc 0000 dddd	MPX Parameter 9	(12768 - 52768) -20000 - +20000
#	00 39	0000 aaaa 0000 bbbb 0000 cccc 0000 dddd	MPX Parameter 10	(12768 - 52768) -20000 - +20000
#	00 3D	0000 aaaa 0000 bbbb 0000 cccc 0000 dddd	MPX Parameter 11	(12768 - 52768) -20000 - +20000
#	00 41	0000 aaaa 0000 bbbb 0000 cccc 0000 dddd	MPX Parameter 12	(12768 - 52768) -20000 - +20000
#	00 45	0000 aaaa 0000 bbbb 0000 cccc 0000 dddd	MPX Parameter 13	(12768 - 52768) -20000 - +20000
#	00 49	0000 aaaa 0000 bbbb 0000 cccc 0000 dddd	MPX Parameter 14	(12768 - 52768) -20000 - +20000
#	00 4D	0000 aaaa 0000 bbbb 0000 cccc 0000 dddd	MPX Parameter 15	(12768 - 52768) -20000 - +20000
#	00 51	0000 aaaa 0000 bbbb 0000 cccc 0000 dddd	MPX Parameter 16	(12768 - 52768) -20000 - +20000
#	00 55	0000 aaaa 0000 bbbb 0000 cccc 0000 dddd	MPX Parameter 17	(12768 - 52768) -20000 - +20000
#	00 59	0000 aaaa 0000 bbbb 0000 cccc 0000 dddd	MPX Parameter 18	(12768 - 52768) -20000 - +20000
#	00 5D	0000 aaaa 0000 bbbb 0000 cccc 0000 dddd	MPX Parameter 19	(12768 - 52768) -20000 - +20000
#	00 61	0000 aaaa 0000 bbbb 0000 cccc 0000 dddd	MPX Parameter 20	(12768 - 52768) -20000 - +20000
#	00 65	0000 aaaa 0000 bbbb 0000 cccc 0000 dddd	MPX Parameter 21	(12768 - 52768) -20000 - +20000
#	00 69	0000 aaaa 0000 bbbb 0000 cccc 0000 dddd	MPX Parameter 22	(12768 - 52768) -20000 - +20000
#	00 6D	0000 aaaa 0000 bbbb 0000 cccc 0000 dddd	MPX Parameter 23	(12768 - 52768) -20000 - +20000
#	00 71	0000 aaaa 0000 bbbb 0000 cccc 0000 dddd	MPX Parameter 24	(12768 - 52768) -20000 - +20000
#	00 75	0000 aaaa 0000 bbbb 0000 cccc 0000 dddd	MPX Parameter 25	(12768 - 52768) -20000 - +20000
#	00 79	0000 aaaa 0000 bbbb 0000 cccc 0000 dddd	MPX Parameter 26	(12768 - 52768) -20000 - +20000
#	00 7D	0000 aaaa 0000 bbbb 0000 cccc 0000 dddd	MPX Parameter 27	(12768 - 52768) -20000 - +20000
#	01 01	0000 aaaa 0000 bbbb 0000 cccc 0000 dddd	MPX Parameter 28	(12768 - 52768) -20000 - +20000
#	01 05	0000 aaaa 0000 bbbb 0000 cccc 0000 dddd	MPX Parameter 29	(12768 - 52768) -20000 - +20000
#	01 09	0000 aaaa 0000 bbbb 0000 cccc 0000 dddd	MPX Parameter 30	(12768 - 52768) -20000 - +20000
#	01 0D	0000 aaaa 0000 bbbb 0000 cccc 0000 dddd	MPX Parameter 31	(12768 - 52768) -20000 - +20000
#	01 11	0000 aaaa 0000 bbbb 0000 cccc 0000 dddd	MPX Parameter 32	(12768 - 52768) -20000 - +20000
00 00 01 11		Total Size		

### \* Performance Common Chorus

Offset	Address	Description	
00 00	0000 aaaa	Chorus Type	(0 - 3)
00 01	0aaa aaaa	Chorus Level	(0 - 127)
00 02	0000 00aa	Chorus Output Assign <*>	A, ---, ---, ---
00 03	0000 00aa	Chorus Output Select	(0 - 2) MAIN, REV, MAIN+REV
#	00 04	0000 aaaa 0000 bbbb 0000 cccc 0000 dddd	Chorus Parameter 1 (12768 - 52768)

#	00 08	0000 aaaa 0000 bbbb 0000 cccc 0000 dddd	Chorus Parameter 2	(12768 - 52768) -20000 - +20000
#	00 0C	0000 aaaa 0000 bbbb 0000 cccc 0000 dddd	Chorus Parameter 3	(12768 - 52768) -20000 - +20000
#	00 10	0000 aaaa 0000 bbbb 0000 cccc 0000 dddd	Chorus Parameter 4	(12768 - 52768) -20000 - +20000
#	00 14	0000 aaaa 0000 bbbb 0000 cccc 0000 dddd	Chorus Parameter 5	(12768 - 52768) -20000 - +20000
#	00 18	0000 aaaa 0000 bbbb 0000 cccc 0000 dddd	Chorus Parameter 6	(12768 - 52768) -20000 - +20000
#	00 1C	0000 aaaa 0000 bbbb 0000 cccc 0000 dddd	Chorus Parameter 7	(12768 - 52768) -20000 - +20000
#	00 20	0000 aaaa 0000 bbbb 0000 cccc 0000 dddd	Chorus Parameter 8	(12768 - 52768) -20000 - +20000
#	00 24	0000 aaaa 0000 bbbb 0000 cccc 0000 dddd	Chorus Parameter 9	(12768 - 52768) -20000 - +20000
#	00 28	0000 aaaa 0000 bbbb 0000 cccc 0000 dddd	Chorus Parameter 10	(12768 - 52768) -20000 - +20000
#	00 2C	0000 aaaa 0000 bbbb 0000 cccc 0000 dddd	Chorus Parameter 11	(12768 - 52768) -20000 - +20000
#	00 30	0000 aaaa 0000 bbbb 0000 cccc 0000 dddd	Chorus Parameter 12	(12768 - 52768) -20000 - +20000
#	00 34	0000 aaaa 0000 bbbb 0000 cccc 0000 dddd	Chorus Parameter 13	(12768 - 52768) -20000 - +20000
#	00 38	0000 aaaa 0000 bbbb 0000 cccc 0000 dddd	Chorus Parameter 14	(12768 - 52768) -20000 - +20000
#	00 3C	0000 aaaa 0000 bbbb 0000 cccc 0000 dddd	Chorus Parameter 15	(12768 - 52768) -20000 - +20000
#	00 40	0000 aaaa 0000 bbbb 0000 cccc 0000 dddd	Chorus Parameter 16	(12768 - 52768) -20000 - +20000
#	00 44	0000 aaaa 0000 bbbb 0000 cccc 0000 dddd	Chorus Parameter 17	(12768 - 52768) -20000 - +20000
#	00 48	0000 aaaa 0000 bbbb 0000 cccc 0000 dddd	Chorus Parameter 18	(12768 - 52768) -20000 - +20000
#	00 4C	0000 aaaa 0000 bbbb 0000 cccc 0000 dddd	Chorus Parameter 19	(12768 - 52768) -20000 - +20000
#	00 50	0000 aaaa 0000 bbbb 0000 cccc 0000 dddd	Chorus Parameter 20	(12768 - 52768) -20000 - +20000
00 00 00 54		Total Size		

### \* Performance Common Reverb

Offset	Address	Description	
00 00	0000 aaaa	Reverb Type	(0 - 5)
00 01	0aaa aaaa	Reverb Level	(0 - 127)
00 02	0000 00aa	Reverb Output Assign <*>	A, ---, ---, ---
#	00 03	0000 aaaa 0000 bbbb 0000 cccc 0000 dddd	Reverb Parameter 1 (12768 - 52768) -20000 - +20000
#	00 07	0000 aaaa 0000 bbbb 0000 cccc 0000 dddd	Reverb Parameter 2 (12768 - 52768) -20000 - +20000
#	00 0B	0000 aaaa 0000 bbbb 0000 cccc 0000 dddd	Reverb Parameter 3 (12768 - 52768) -20000 - +20000
#	00 0F	0000 aaaa 0000 bbbb 0000 cccc 0000 dddd	Reverb Parameter 4 (12768 - 52768) -20000 - +20000
#	00 13	0000 aaaa 0000 bbbb 0000 cccc 0000 dddd	Reverb Parameter 5 (12768 - 52768) -20000 - +20000
#	00 17	0000 aaaa 0000 bbbb	

# MIDI Implementation

#	00 1B	0000 cccc 0000 dddd	Reverb Parameter 6	(12768 - 52768) -20000 - +20000
#	00 1F	0000 aaaa 0000 bbbb 0000 cccc 0000 dddd	Reverb Parameter 7	(12768 - 52768) -20000 - +20000
#	00 23	0000 aaaa 0000 bbbb 0000 cccc 0000 dddd	Reverb Parameter 8	(12768 - 52768) -20000 - +20000
#	00 27	0000 aaaa 0000 bbbb 0000 cccc 0000 dddd	Reverb Parameter 9	(12768 - 52768) -20000 - +20000
#	00 2B	0000 aaaa 0000 bbbb 0000 cccc 0000 dddd	Reverb Parameter 10	(12768 - 52768) -20000 - +20000
#	00 2F	0000 aaaa 0000 bbbb 0000 cccc 0000 dddd	Reverb Parameter 11	(12768 - 52768) -20000 - +20000
#	00 33	0000 aaaa 0000 bbbb 0000 cccc 0000 dddd	Reverb Parameter 12	(12768 - 52768) -20000 - +20000
#	00 37	0000 aaaa 0000 bbbb 0000 cccc 0000 dddd	Reverb Parameter 13	(12768 - 52768) -20000 - +20000
#	00 3B	0000 aaaa 0000 bbbb 0000 cccc 0000 dddd	Reverb Parameter 14	(12768 - 52768) -20000 - +20000
#	00 3F	0000 aaaa 0000 bbbb 0000 cccc 0000 dddd	Reverb Parameter 15	(12768 - 52768) -20000 - +20000
#	00 43	0000 aaaa 0000 bbbb 0000 cccc 0000 dddd	Reverb Parameter 16	(12768 - 52768) -20000 - +20000
#	00 47	0000 aaaa 0000 bbbb 0000 cccc 0000 dddd	Reverb Parameter 17	(12768 - 52768) -20000 - +20000
#	00 4B	0000 aaaa 0000 bbbb 0000 cccc 0000 dddd	Reverb Parameter 18	(12768 - 52768) -20000 - +20000
#	00 4F	0000 aaaa 0000 bbbb 0000 cccc 0000 dddd	Reverb Parameter 19	(12768 - 52768) -20000 - +20000
#	00 53	0000 dddd	Reverb Parameter 20	(12768 - 52768) -20000 - +20000
00 00 00 53		Total Size		

## \* Performance MIDI

Offset Address	Description	
00 00	0000 000a	Receive Program Change (0 - 1)
00 01	0000 000a	Receive Bank Select OFF, ON (0 - 1)
00 02	0000 000a	Receive Bender OFF, ON (0 - 1)
00 03	0000 000a	Receive Polyphonic Key Pressure OFF, ON (0 - 1)
00 04	0000 000a	Receive Channel Pressure OFF, ON (0 - 1)
00 05	0000 000a	Receive Modulation OFF, ON (0 - 1)
00 06	0000 000a	Receive Volume OFF, ON (0 - 1)
00 07	0000 000a	Receive Pan OFF, ON (0 - 1)
00 08	0000 000a	Receive Expression OFF, ON (0 - 1)
00 09	0000 000a	Receive Hold-1 OFF, ON (0 - 1)
00 0A	0000 000a	Phase Lock OFF, ON (0 - 1)
00 0B	0000 0aaa	Velocity Curve Type OFF, ON (0 - 4)
00 00 00 0C		Total Size

## \* Performance Part

Offset Address	Description	
00 00	0000 aaaa	Receive Channel (0 - 15)
00 01	0000 000a	Receive Switch 1 - 16 (0 - 1)
00 02	0000 0000	(reserve) <*> OFF, ON
00 03	0000 0000	(reserve) <*> OFF, ON
00 04	0aaa aaaa	Patch Bank Select MSB (CC# 0) (0 - 127)
00 05	0aaa aaaa	Patch Bank Select LSB (CC# 32) (0 - 127)
00 06	0aaa aaaa	Patch Program Number (PC) (0 - 127)
00 07	0aaa aaaa	Part Level (CC# 7) (0 - 127)
00 08	0aaa aaaa	Part Pan (CC# 10) (0 - 127)
00 09	0aaa aaaa	Part Coarse Tune (RPN# 2) (16 - 112)
00 0A	0aaa aaaa	Part Fine Tune (RPN# 1) (-48 - +48) (14 - 114)
00 0B	0000 00aa	Part Mono/Poly (MONO ON/POLY ON) (0 - 2) MONO, POLY, PATCH

#	00 0C	0000 00aa	Part Legato Switch (CC# 68)	(0 - 2) OFF, ON, PATCH
#	00 0D	000a aaaa	Part Pitch Bend Range (RPN# 0)	(0 - 25) 0 - 24, PATCH
#	00 0E	0000 00aa	Part Portamento Switch (CC# 65)	(0 - 2) OFF, ON, PATCH
#	00 0F	0000 aaaa 0000 bbbb	Part Portamento Time (CC# 5)	(0 - 128) 0 - 127, PATCH
#	00 11	0aaa aaaa	Part Cutoff Offset (CC# 74)	(0 - 127) -64 - +63
#	00 12	0aaa aaaa	Part Resonance Offset (CC# 71)	(0 - 127) -64 - +63
#	00 13	0aaa aaaa	Part Attack Time Offset (CC# 73)	(0 - 127) -64 - +63
#	00 14	0aaa aaaa	Part Release Time Offset (CC# 72)	(0 - 127) -64 - +63
-----				
#	00 15	0000 0aaa	Part Octave Shift	(61 - 67) -3 - +3
#	00 16	0aaa aaaa	Part Velocity Sens Offset	(1 - 127) -63 - +63
#	00 17	0aaa aaaa	(reserve) <*>	(0 - 127)
#	00 18	0aaa aaaa	(reserve) <*>	(0 - 127)
#	00 19	0aaa aaaa	(reserve) <*>	(0 - 127)
#	00 1A	0aaa aaaa	(reserve) <*>	(0 - 127)
#	00 1B	0000 000a	Mute Switch	(0 - 1) OFF, MUTE
-----				
#	00 1C	0aaa aaaa	Part Dry Send Level	(0 - 127)
#	00 1D	0aaa aaaa	Part Chorus Send Level (CC# 93)	(0 - 127)
#	00 1E	0aaa aaaa	Part Reverb Send Level (CC# 91)	(0 - 127)
#	00 1F	0000 aaaa	Part Output Assign	(0 - 13) MF, A, ---, ---, ---, ---, 1, 2, ---, ---, ---, ---, ---, ---, PATCH
#	00 20	0000 00aa	Part Output MPX Select	(0 - 2) MPX1, MPX2, MPX3
-----				
#	00 21	0aaa aaaa	Part Decay Time Offset (CC# 75)	(0 - 127) -64 - +63
-----				
#	00 22	0aaa aaaa	Part Vibrato Rate (CC# 76)	(0 - 127) -64 - +63
#	00 23	0aaa aaaa	Part Vibrato Depth (CC# 77)	(0 - 127) -64 - +63
#	00 24	0aaa aaaa	Part Vibrato Delay (CC# 78)	(0 - 127) -64 - +63
-----				
#	00 25	0aaa aaaa	Part Scale Tune for C	(0 - 127) -64 - +63
#	00 26	0aaa aaaa	Part Scale Tune for C#	(0 - 127) -64 - +63
#	00 27	0aaa aaaa	Part Scale Tune for D	(0 - 127) -64 - +63
#	00 28	0aaa aaaa	Part Scale Tune for D#	(0 - 127) -64 - +63
#	00 29	0aaa aaaa	Part Scale Tune for E	(0 - 127) -64 - +63
#	00 2A	0aaa aaaa	Part Scale Tune for F	(0 - 127) -64 - +63
#	00 2B	0aaa aaaa	Part Scale Tune for F#	(0 - 127) -64 - +63
#	00 2C	0aaa aaaa	Part Scale Tune for G	(0 - 127) -64 - +63
#	00 2D	0aaa aaaa	Part Scale Tune for G#	(0 - 127) -64 - +63
#	00 2E	0aaa aaaa	Part Scale Tune for A	(0 - 127) -64 - +63
#	00 2F	0aaa aaaa	Part Scale Tune for A#	(0 - 127) -64 - +63
#	00 30	0aaa aaaa	Part Scale Tune for B	(0 - 127) -64 - +63
00 00 00 31		Total Size		

## \* Performance Zone

Offset Address	Description		
00 00	000a aaaa	(reserve) <*> (0 - 1)	
00 01	0000 000a	Zone Switch OFF, ON	
00 02	0000 000a	(reserve) <*> (0 - 1)	
#	00 03	0000 aaaa 0000 bbbb	External Bank Select MSB (CC# 0) (0 - 128) NO-SEND
#	00 05	0aaa aaaa 0000 aaaa 0000 bbbb	External Bank Select LSB (CC# 32) (0 - 127) NO-SEND
#	00 08	0000 aaaa 0000 bbbb	External Program Number (PC) (0 - 128) NO-SEND
#	00 0A	0000 aaaa 0000 bbbb	External Level (CC# 7) (0 - 128) NO-SEND
#	00 0A	0000 aaaa 0000 bbbb	External Pan (CC# 10) (0 - 128) NO-SEND
-----			
00 0C	0aaa aaaa	Keyboard Range Lower (0 - 127)	
00 0D	0aaa aaaa	Keyboard Range Upper C-1 - UPPER (0 - 127) LOWER - G9	
-----			
00 0E	0000 000a	Control Bender (0 - 1) OFF, ON	
00 0F	0000 000a	(reserve) <*> (0 - 1) OFF, ON	
00 10	0000 000a	Control Modulation (0 - 1) OFF, ON	
00 11	0000 000a	Control Hold Pedal (0 - 1) OFF, ON	
00 12	0000 000a	Control Pedal (0 - 1) OFF, ON	
00 13	0000 000a	(reserve) <*> (0 - 1) OFF, ON	
00 14	0000 000a	Control D Beam (0 - 1) OFF, ON	
00 15	0000 000a	(reserve) <*> (0 - 1) OFF, ON	
00 16	0000 000a	(reserve) <*> (0 - 1) OFF, ON	
00 17	0000 000a	(reserve) <*> (0 - 1) OFF, ON	
00 18	0000 000a	(reserve) <*> (0 - 1) OFF, ON	
00 19	0000 000a	Control Switch 1 (0 - 1) OFF, ON	
00 1A	0000 000a	Control Switch 2 (0 - 1) OFF, ON	
00 00 00 1B		Total Size	

## \* Performance Controller

Offset Address	Description
00 00	0000 000a (reserve) <*>

00 01	0aaa aaaa	Beam Assign	(0 - 104) CC01 - CC31, CC33 - CC95, BEND-UP, BEND-DOWN, START/STOP, TAP-TEMPO, ARP-GRID, ARP-DUR, ARP-MOTIF, ARP-OCT-UP, ARP-OCT-DW, ARP-STEP, APTERTOUCH
00 02	0aaa aaaa	Beam Range Lower	(0 - 127)
00 03	0aaa aaaa	Beam Range Upper	(0 - 127)
00 04	0000 aaaa	(reserve) <*>	
00 05	0aaa aaaa	(reserve) <*>	
00 06	0aaa aaaa	(reserve) <*>	
00 07	0aaa aaaa	(reserve) <*>	
00 08	0aaa aaaa	(reserve) <*>	
00 09	0aaa aaaa	(reserve) <*>	
00 0A	0aaa aaaa	(reserve) <*>	
00 0B	0aaa aaaa	Switch 1 Assign	(0 - 14) TRNS-UP, TRNS-DW, TAP-TEMPO, MONO/POLY, PORTAMENTO, HOLD1, MPX1-SW, MPX2-SW, MPX3-SW, CHO-SW, REV-SW, SYS-CTRL1, SYS-CTRL2, SYS-CTRL3, SYS-CTRL4
00 0C	0aaa aaaa	Switch 2 Assign	(0 - 14) TRNS-UP, TRNS-DW, TAP-TEMPO, MONO/POLY, PORTAMENTO, HOLD1, MPX1-SW, MPX2-SW, MPX3-SW, CHO-SW, REV-SW, SYS-CTRL1, SYS-CTRL2, SYS-CTRL3, SYS-CTRL4
00 0D	0000 000a	(reserve) <*>	
00 0E	0aaa aaaa	Arp/Ptn Grid	(0 - 8) 04_, 08_, 08L, 08H, 08L, 16_, 16L, 16H, 16T
00 0F	0aaa aaaa	Arp/Ptn Duration	(0 - 9) 30, 40, 50, 60, 70, 80, 90, 100, 120, PUL
00 10	0000 000a	Arpeggio Switch	(0 - 1) OFF, ON
00 11	0aaa aaaa	Arpeggio Bank	(0 - 1) USER, PRESET
00 12	0aaa aaaa	Arpeggio Style	(0 - 127) 1 - 128
00 13	0aaa aaaa	Arpeggio Motif	(0 - 11) UP/L, UP/H, UP/_/, dn/L, dn/H, dn/_/, UG/L, UG/H, UG/_/, rn/L, rn/_/, PHRASE
00 14	0000 0aaa	Arpeggio Octave Range	(61 - 67) -3 - +3
00 15	0000 000a	Arpeggio Hold	(0 - 1) OFF, ON
00 16	0aaa aaaa	Arpeggio Accent Rate	(0 - 100)
00 17	0aaa aaaa	Arpeggio Velocity	(0 - 127) REAL, 1 - 127
00 18	0000 aaaa	Arpeggio Zone Number	(0 - 15) ZONE1 - ZONE16
00 19	0000 000a	Rhythm Pattern Switch	(0 - 1) OFF, ON
00 1A	0aaa aaaa	Rhythm Pattern Group Bank	(0 - 1) USER, PRESET
00 1B	0aaa aaaa	Rhythm Pattern Group Number	(0 - 31) 1 - 32
00 1C	0aaa aaaa	Rhythm Pattern Accent Rate	(0 - 100)
00 1D	0aaa aaaa	Rhythm Pattern Velocity	(1 - 127)
00 1E	0000 000a	Chord Switch	(0 - 1) OFF, ON
00 1F	0aaa aaaa	Chord Group	(0 - 1) USER, PRESET
00 20	00aa aaaa	Chord Form	(0 - 63)
00 21	0aaa aaaa	(reserve) <*>	
00 22	0aaa aaaa	(reserve) <*>	
00 23	000a aaaa	(reserve) <*>	
00 24	0aaa aaaa	(reserve) <*>	
00 25	0aaa aaaa	(reserve) <*>	
00 26	0aaa aaaa	(reserve) <*>	
00 27	0aaa aaaa	(reserve) <*>	
00 28	0aaa aaaa	(reserve) <*>	
00 29	0aaa aaaa	(reserve) <*>	
00 2A	0aaa aaaa	(reserve) <*>	
00 2B	0aaa aaaa	(reserve) <*>	
00 2C	0aaa aaaa	(reserve) <*>	
00 2D	0aaa aaaa	(reserve) <*>	
00 2E	0aaa aaaa	(reserve) <*>	
00 2F	0aaa aaaa	(reserve) <*>	
00 30	0aaa aaaa	(reserve) <*>	
00 31	0aaa aaaa	(reserve) <*>	
00 32	0aaa aaaa	(reserve) <*>	
00 33	0aaa aaaa	(reserve) <*>	
00 34	0aaa aaaa	(reserve) <*>	
00 35	0aaa aaaa	(reserve) <*>	
00 36	0aaa aaaa	(reserve) <*>	
00 37	0aaa aaaa	(reserve) <*>	
00 38	0aaa aaaa	(reserve) <*>	
00 39	0aaa aaaa	(reserve) <*>	
00 3A	0aaa aaaa	(reserve) <*>	
00 3B	0aaa aaaa	(reserve) <*>	
00 3C	0aaa aaaa	(reserve) <*>	
00 3D	0aaa aaaa	(reserve) <*>	
00 3E	0aaa aaaa	(reserve) <*>	
00 3F	0aaa aaaa	(reserve) <*>	
00 40	0aaa aaaa	(reserve) <*>	
00 41	0aaa aaaa	(reserve) <*>	
00 42	0aaa aaaa	(reserve) <*>	
00 43	0aaa aaaa	(reserve) <*>	
00 44	0aaa aaaa	(reserve) <*>	
00 45	0aaa aaaa	(reserve) <*>	
00 46	0aaa aaaa	(reserve) <*>	
00 47	0aaa aaaa	(reserve) <*>	
00 48	0aaa aaaa	(reserve) <*>	
00 49	0aaa aaaa	(reserve) <*>	
00 4A	0aaa aaaa	(reserve) <*>	
00 4B	0aaa aaaa	(reserve) <*>	
00 4C	0aaa aaaa	(reserve) <*>	
00 4D	0aaa aaaa	(reserve) <*>	
00 4E	0aaa aaaa	(reserve) <*>	
00 4F	0aaa aaaa	(reserve) <*>	
00 50	0aaa aaaa	(reserve) <*>	
00 51	0aaa aaaa	(reserve) <*>	
00 52	0aaa aaaa	(reserve) <*>	
00 53	0aaa aaaa	(reserve) <*>	
# 00 54	0000 aaaa 0000 bbbb	Recommended Tempo	(20 - 250)
00 56	0000 000a	Rolled Chord	(0 - 1) OFF, ON
00 57	0000 00aa	Rolled Chord Type	(0 - 2) UP, DOWN, ALTERNATE
00 58	0000 000a	Switch 1 Type	(0 - 1) LATCH, MOMENTARY
00 59	0000 000a	Switch 2 Type	(0 - 1) LATCH, MOMENTARY

00 00 00 5A | Total Size

## \* Arpeggio Common

Offset	Address	Description	
# 00 00	0000 aaaa 0000 bbbb	End Step	(1 - 32)
00 02	0aaa aaaa	Arpeggio Name 1	(32 - 127)
00 03	0aaa aaaa	Arpeggio Name 2	(32 - 127)
00 04	0aaa aaaa	Arpeggio Name 3	(32 - 127)
00 05	0aaa aaaa	Arpeggio Name 4	(32 - 127)
00 06	0aaa aaaa	Arpeggio Name 5	(32 - 127)
00 07	0aaa aaaa	Arpeggio Name 6	(32 - 127)
00 08	0aaa aaaa	Arpeggio Name 7	(32 - 127)
00 09	0aaa aaaa	Arpeggio Name 8	(32 - 127)
00 0A	0aaa aaaa	Arpeggio Name 9	(32 - 127)
00 0B	0aaa aaaa	Arpeggio Name 10	(32 - 127)
00 0C	0aaa aaaa	Arpeggio Name 11	(32 - 127)
00 0D	0aaa aaaa	Arpeggio Name 12	(32 - 127)
00 0E	0aaa aaaa	Arpeggio Name 13	(32 - 127)
00 0F	0aaa aaaa	Arpeggio Name 14	(32 - 127)
00 10	0aaa aaaa	Arpeggio Name 15	(32 - 127)
00 11	0aaa aaaa	Arpeggio Name 16	(32 - 127)
00 00 00 12	Total Size		

## \* Arpeggio Pattern

Offset	Address	Description	
# 00 00	0000 aaaa 0000 bbbb	Original Note	(0 - 128)
# 00 02	0000 aaaa 0000 bbbb	Step1 Data	(0 - 128)
# 00 04	0000 aaaa 0000 bbbb	Step2 Data	(0 - 128)
# 00 06	0000 aaaa 0000 bbbb	Step3 Data	(0 - 128)
# 00 08	0000 aaaa 0000 bbbb	Step4 Data	(0 - 128)
# 00 0A	0000 aaaa 0000 bbbb	Step5 Data	(0 - 128)
# 00 0C	0000 aaaa 0000 bbbb	Step6 Data	(0 - 128)
# 00 0E	0000 aaaa 0000 bbbb	Step7 Data	(0 - 128)
# 00 10	0000 aaaa 0000 bbbb	Step8 Data	(0 - 128)
# 00 12	0000 aaaa 0000 bbbb	Step9 Data	(0 - 128)
# 00 14	0000 aaaa 0000 bbbb	Step10 Data	(0 - 128)
# 00 16	0000 aaaa 0000 bbbb	Step11 Data	(0 - 128)
# 00 18	0000 aaaa 0000 bbbb	Step12 Data	(0 - 128)
# 00 1A	0000 aaaa 0000 bbbb	Step13 Data	(0 - 128)
# 00 1C	0000 aaaa 0000 bbbb	Step14 Data	(0 - 128)
# 00 1E	0000 aaaa 0000 bbbb	Step15 Data	(0 - 128)
# 00 20	0000 aaaa 0000 bbbb	Step16 Data	(0 - 128)
# 00 22	0000 aaaa 0000 bbbb	Step17 Data	(0 - 128)
# 00 24	0000 aaaa 0000 bbbb	Step18 Data	(0 - 128)
# 00 26	0000 aaaa 0000 bbbb	Step19 Data	(0 - 128)
# 00 28	0000 aaaa 0000 bbbb	Step20 Data	(0 - 128)
# 00 2A	0000 aaaa 0000 bbbb	Step21 Data	(0 - 128)
# 00 2C	0000 aaaa 0000 bbbb	Step22 Data	(0 - 128)
# 00 2E	0000 aaaa 0000 bbbb	Step23 Data	(0 - 128)
# 00 30	0000 aaaa 0000 bbbb	Step24 Data	(0 - 128)
# 00 32	0000 aaaa 0000 bbbb	Step25 Data	(0 - 128)
# 00 34	0000 aaaa 0000 bbbb	Step26 Data	(0 - 128)
# 00 36	0000 aaaa 0000 bbbb	Step27 Data	(0 - 128)
# 00 38	0000 aaaa 0000 bbbb	Step28 Data	(0 - 128)
# 00 3A	0000 aaaa 0000 bbbb	Step29 Data	(0 - 128)
# 00 3C	0000 aaaa 0000 bbbb	Step30 Data	(0 - 128)
# 00 3E	0000 aaaa 0000 bbbb	Step31 Data	(0 - 128)
# 00 40	0000 aaaa 0000 bbbb	Step32 Data	(0 - 128)
00 00 00 42	Total Size		

## \* Chord Pattern

Offset	Address	Description	
00 00	0000 000a	Chord Note1	(0 - 1) OFF, ON
00 01	0000 000a	Chord Note2	(0 - 1) OFF, ON
00 02	0000 000a	Chord Note3	(0 - 1) OFF, ON

# MIDI Implementation

00 03	0000 000a	Chord Note4	(0 - 1)	00 48	0000 000a	Chord Note73	(0 - 1)
00 04	0000 000a	Chord Note5	OFF, ON	00 49	0000 000a	Chord Note74	OFF, ON
00 05	0000 000a	Chord Note6	(0 - 1)	00 4A	0000 000a	Chord Note75	(0 - 1)
00 06	0000 000a	Chord Note7	OFF, ON	00 4B	0000 000a	Chord Note76	OFF, ON
00 07	0000 000a	Chord Note8	(0 - 1)	00 4C	0000 000a	Chord Note77	(0 - 1)
00 08	0000 000a	Chord Note9	OFF, ON	00 4D	0000 000a	Chord Note78	OFF, ON
00 09	0000 000a	Chord Note10	(0 - 1)	00 4E	0000 000a	Chord Note79	(0 - 1)
00 0A	0000 000a	Chord Note11	OFF, ON	00 4F	0000 000a	Chord Note80	OFF, ON
00 0B	0000 000a	Chord Note12	(0 - 1)	00 50	0000 000a	Chord Note81	(0 - 1)
00 0C	0000 000a	Chord Note13	OFF, ON	00 51	0000 000a	Chord Note82	OFF, ON
00 0D	0000 000a	Chord Note14	(0 - 1)	00 52	0000 000a	Chord Note83	(0 - 1)
00 0E	0000 000a	Chord Note15	OFF, ON	00 53	0000 000a	Chord Note84	OFF, ON
00 0F	0000 000a	Chord Note16	(0 - 1)	00 54	0000 000a	Chord Note85	(0 - 1)
00 10	0000 000a	Chord Note17	OFF, ON	00 55	0000 000a	Chord Note86	OFF, ON
00 11	0000 000a	Chord Note18	(0 - 1)	00 56	0000 000a	Chord Note87	(0 - 1)
00 12	0000 000a	Chord Note19	OFF, ON	00 57	0000 000a	Chord Note88	OFF, ON
00 13	0000 000a	Chord Note20	(0 - 1)	00 58	0000 000a	Chord Note89	(0 - 1)
00 14	0000 000a	Chord Note21	OFF, ON	00 59	0000 000a	Chord Note90	OFF, ON
00 15	0000 000a	Chord Note22	(0 - 1)	00 5A	0000 000a	Chord Note91	(0 - 1)
00 16	0000 000a	Chord Note23	OFF, ON	00 5B	0000 000a	Chord Note92	OFF, ON
00 17	0000 000a	Chord Note24	(0 - 1)	00 5C	0000 000a	Chord Note93	(0 - 1)
00 18	0000 000a	Chord Note25	OFF, ON	00 5D	0000 000a	Chord Note94	OFF, ON
00 19	0000 000a	Chord Note26	(0 - 1)	00 5E	0000 000a	Chord Note95	(0 - 1)
00 1A	0000 000a	Chord Note27	OFF, ON	00 5F	0000 000a	Chord Note96	OFF, ON
00 1B	0000 000a	Chord Note28	(0 - 1)	00 60	0000 000a	Chord Note97	(0 - 1)
00 1C	0000 000a	Chord Note29	OFF, ON	00 61	0000 000a	Chord Note98	OFF, ON
00 1D	0000 000a	Chord Note30	(0 - 1)	00 62	0000 000a	Chord Note99	(0 - 1)
00 1E	0000 000a	Chord Note31	OFF, ON	00 63	0000 000a	Chord Note100	OFF, ON
00 1F	0000 000a	Chord Note32	(0 - 1)	00 64	0000 000a	Chord Note101	(0 - 1)
00 20	0000 000a	Chord Note33	OFF, ON	00 65	0000 000a	Chord Note102	OFF, ON
00 21	0000 000a	Chord Note34	(0 - 1)	00 66	0000 000a	Chord Note103	(0 - 1)
00 22	0000 000a	Chord Note35	OFF, ON	00 67	0000 000a	Chord Note104	OFF, ON
00 23	0000 000a	Chord Note36	(0 - 1)	00 68	0000 000a	Chord Note105	(0 - 1)
00 24	0000 000a	Chord Note37	OFF, ON	00 69	0000 000a	Chord Note106	OFF, ON
00 25	0000 000a	Chord Note38	(0 - 1)	00 6A	0000 000a	Chord Note107	(0 - 1)
00 26	0000 000a	Chord Note39	OFF, ON	00 6B	0000 000a	Chord Note108	OFF, ON
00 27	0000 000a	Chord Note40	(0 - 1)	00 6C	0000 000a	Chord Note109	(0 - 1)
00 28	0000 000a	Chord Note41	OFF, ON	00 6D	0000 000a	Chord Note110	OFF, ON
00 29	0000 000a	Chord Note42	(0 - 1)	00 6E	0000 000a	Chord Note111	(0 - 1)
00 2A	0000 000a	Chord Note43	OFF, ON	00 6F	0000 000a	Chord Note112	OFF, ON
00 2B	0000 000a	Chord Note44	(0 - 1)	00 70	0000 000a	Chord Note113	(0 - 1)
00 2C	0000 000a	Chord Note45	OFF, ON	00 71	0000 000a	Chord Note114	OFF, ON
00 2D	0000 000a	Chord Note46	(0 - 1)	00 72	0000 000a	Chord Note115	(0 - 1)
00 2E	0000 000a	Chord Note47	OFF, ON	00 73	0000 000a	Chord Note116	OFF, ON
00 2F	0000 000a	Chord Note48	(0 - 1)	00 74	0000 000a	Chord Note117	(0 - 1)
00 30	0000 000a	Chord Note49	OFF, ON	00 75	0000 000a	Chord Note118	OFF, ON
00 31	0000 000a	Chord Note50	(0 - 1)	00 76	0000 000a	Chord Note119	(0 - 1)
00 32	0000 000a	Chord Note51	OFF, ON	00 77	0000 000a	Chord Note120	OFF, ON
00 33	0000 000a	Chord Note52	(0 - 1)	00 78	0000 000a	Chord Note121	(0 - 1)
00 34	0000 000a	Chord Note53	OFF, ON	00 79	0000 000a	Chord Note122	OFF, ON
00 35	0000 000a	Chord Note54	(0 - 1)	00 7A	0000 000a	Chord Note123	(0 - 1)
00 36	0000 000a	Chord Note55	OFF, ON	00 7B	0000 000a	Chord Note124	OFF, ON
00 37	0000 000a	Chord Note56	(0 - 1)	00 7C	0000 000a	Chord Note125	(0 - 1)
00 38	0000 000a	Chord Note57	OFF, ON	00 7D	0000 000a	Chord Note126	OFF, ON
00 39	0000 000a	Chord Note58	(0 - 1)	00 7E	0000 000a	Chord Note127	(0 - 1)
00 3A	0000 000a	Chord Note59	OFF, ON	00 7F	0000 000a	Chord Note128	OFF, ON
00 3B	0000 000a	Chord Note60	(0 - 1)				
00 3C	0000 000a	Chord Note61	OFF, ON	01 00	0aaa aaaa	Chord Pattern Name 1	(32 - 127)
00 3D	0000 000a	Chord Note62	(0 - 1)	01 01	0aaa aaaa	Chord Pattern Name 2	(32 - 127)
00 3E	0000 000a	Chord Note63	OFF, ON	01 02	0aaa aaaa	Chord Pattern Name 3	(32 - 127)
00 3F	0000 000a	Chord Note64	(0 - 1)	01 03	0aaa aaaa	Chord Pattern Name 4	(32 - 127)
00 40	0000 000a	Chord Note65	OFF, ON	01 04	0aaa aaaa	Chord Pattern Name 5	(32 - 127)
00 41	0000 000a	Chord Note66	(0 - 1)	01 05	0aaa aaaa	Chord Pattern Name 6	(32 - 127)
00 42	0000 000a	Chord Note67	OFF, ON	01 06	0aaa aaaa	Chord Pattern Name 7	(32 - 127)
00 43	0000 000a	Chord Note68	(0 - 1)	01 07	0aaa aaaa	Chord Pattern Name 8	(32 - 127)
00 44	0000 000a	Chord Note69	OFF, ON	01 08	0aaa aaaa	Chord Pattern Name 9	(32 - 127)
00 45	0000 000a	Chord Note70	(0 - 1)	01 09	0aaa aaaa	Chord Pattern Name 10	(32 - 127)
00 46	0000 000a	Chord Note71	OFF, ON	01 0A	0aaa aaaa	Chord Pattern Name 11	(32 - 127)
00 47	0000 000a	Chord Note72	(0 - 1)	01 0B	0aaa aaaa	Chord Pattern Name 12	(32 - 127)
			OFF, ON	01 0C	0aaa aaaa	Chord Pattern Name 13	(32 - 127)

01 0D	0aaa aaaa	Chord Pattern Name 14	(32 - 127)
01 0E	0aaa aaaa	Chord Pattern Name 15	(32 - 127)
01 0F	0aaa aaaa	Chord Pattern Name 16	(32 - 127)
-----			
00 00 01 10	Total Size		

## \* Rhythm Group

Offset Address	Description	
00 00	0aaa aaaa	Rhythm Group Name 1 (32 - 127)
00 01	0aaa aaaa	Rhythm Group Name 2 (32 - 127)
00 02	0aaa aaaa	Rhythm Group Name 3 (32 - 127)
00 03	0aaa aaaa	Rhythm Group Name 4 (32 - 127)
00 04	0aaa aaaa	Rhythm Group Name 5 (32 - 127)
00 05	0aaa aaaa	Rhythm Group Name 6 (32 - 127)
00 06	0aaa aaaa	Rhythm Group Name 7 (32 - 127)
00 07	0aaa aaaa	Rhythm Group Name 8 (32 - 127)
00 08	0aaa aaaa	Rhythm Group Name 9 (32 - 127)
00 09	0aaa aaaa	Rhythm Group Name 10 (32 - 127)
00 0A	0aaa aaaa	Rhythm Group Name 11 (32 - 127)
00 0B	0aaa aaaa	Rhythm Group Name 12 (32 - 127)
00 0C	0aaa aaaa	Rhythm Group Name 13 (32 - 127)
00 0D	0aaa aaaa	Rhythm Group Name 14 (32 - 127)
00 0E	0aaa aaaa	Rhythm Group Name 15 (32 - 127)
00 0F	0aaa aaaa	Rhythm Group Name 16 (32 - 127)
-----		
00 10	0aaa aaaa	Recommended Rhythm Bank Select MSB (0 - 127)
00 11	0aaa aaaa	Recommended Rhythm Bank Select LSB (0 - 127)
00 12	0aaa aaaa	Recommended Rhythm Program Number (0 - 127)
-----		
00 13	0aaa aaaa	(reserve) <*>
00 14	0aaa aaaa	(reserve) <*>
00 15	0aaa aaaa	Pad 1 Velocity (1 - 127)
00 16	0000 000a	Pad 1 Rhythm Pattern Group (0 - 1) USER, PRESET
# 00 17	0000 aaaa	Pad 1 Rhythm Pattern Number (0 - 255)
00 18	0aaa aaaa	(reserve) <*>
00 1A	0aaa aaaa	Pad 2 Velocity (1 - 127)
00 1B	0000 000a	Pad 2 Rhythm Pattern Group (0 - 1) USER, PRESET
# 00 1C	0000 aaaa	Pad 2 Rhythm Pattern Number (0 - 255)
00 1F	0aaa aaaa	(reserve) <*>
00 20	0aaa aaaa	Pad 3 Velocity (1 - 127)
00 21	0000 000a	Pad 3 Rhythm Pattern Group (0 - 1) USER, PRESET
# 00 22	0000 aaaa	Pad 3 Rhythm Pattern Number (0 - 255)
00 25	0aaa aaaa	(reserve) <*>
00 26	0aaa aaaa	Pad 4 Velocity (1 - 127)
00 27	0aaa aaaa	Pad 4 Velocity (1 - 127)
00 28	0000 000a	Pad 4 Rhythm Pattern Group (0 - 1) USER, PRESET
# 00 29	0000 aaaa	Pad 4 Rhythm Pattern Number (0 - 255)
00 2B	0aaa aaaa	(reserve) <*>
00 2C	0aaa aaaa	Pad 5 Velocity (1 - 127)
00 2E	0000 000a	Pad 5 Rhythm Pattern Group (0 - 1) USER, PRESET
# 00 2F	0000 aaaa	Pad 5 Rhythm Pattern Number (0 - 255)
00 31	0aaa aaaa	(reserve) <*>
00 32	0aaa aaaa	Pad 6 Velocity (1 - 127)
00 33	0aaa aaaa	Pad 6 Velocity (1 - 127)
00 34	0000 000a	Pad 6 Rhythm Pattern Group (0 - 1) USER, PRESET
# 00 35	0000 aaaa	Pad 6 Rhythm Pattern Number (0 - 255)
00 37	0aaa aaaa	(reserve) <*>
00 38	0aaa aaaa	(reserve) <*>
00 39	0aaa aaaa	Pad 7 Velocity (1 - 127)
00 3A	0000 000a	Pad 7 Rhythm Pattern Group (0 - 1) USER, PRESET
# 00 3B	0000 aaaa	Pad 7 Rhythm Pattern Number (0 - 255)
00 3D	0aaa aaaa	(reserve) <*>
00 3E	0aaa aaaa	(reserve) <*>
00 3F	0aaa aaaa	Pad 8 Velocity (1 - 127)
00 40	0000 000a	Pad 8 Rhythm Pattern Group (0 - 1) USER, PRESET
# 00 41	0000 aaaa	Pad 8 Rhythm Pattern Number (0 - 255)
00 43	0aaa aaaa	(reserve) <*>
00 44	0aaa aaaa	(reserve) <*>
00 45	0aaa aaaa	Pad 9 Velocity (1 - 127)
00 46	0000 000a	Pad 9 Rhythm Pattern Group (0 - 1) USER, PRESET
# 00 47	0000 aaaa	Pad 9 Rhythm Pattern Number (0 - 255)
00 49	0000 bbbb	(reserve) <*>
00 4A	0aaa aaaa	(reserve) <*>
00 4B	0aaa aaaa	Pad 10 Velocity (1 - 127)
00 4C	0000 000a	Pad 10 Rhythm Pattern Group (0 - 1) USER, PRESET
# 00 4D	0000 aaaa	Pad 10 Rhythm Pattern Number (0 - 255)
00 4F	0aaa aaaa	(reserve) <*>
00 50	0aaa aaaa	(reserve) <*>
00 51	0aaa aaaa	Pad 11 Velocity (1 - 127)
00 52	0000 000a	Pad 11 Rhythm Pattern Group (0 - 1) USER, PRESET
# 00 53	0000 aaaa	Pad 11 Rhythm Pattern Number (0 - 255)
00 55	0aaa aaaa	(reserve) <*>
00 56	0aaa aaaa	(reserve) <*>
00 57	0aaa aaaa	Pad 12 Velocity (1 - 127)
00 58	0000 000a	Pad 12 Rhythm Pattern Group (0 - 1) USER, PRESET
# 00 59	0000 aaaa	Pad 12 Rhythm Pattern Number (0 - 255)

00 5B	0aaa aaaa	(reserve) <*>	
00 5C	0aaa aaaa	(reserve) <*>	
00 5D	0aaa aaaa	Pad 13 Velocity (1 - 127)	
00 5E	0000 000a	Pad 13 Rhythm Pattern Group (0 - 1) USER, PRESET	
# 00 5F	0000 aaaa	Pad 13 Rhythm Pattern Number (0 - 255)	
00 61	0aaa aaaa	(reserve) <*>	
00 62	0aaa aaaa	(reserve) <*>	
00 63	0aaa aaaa	Pad 14 Velocity (1 - 127)	
00 64	0000 000a	Pad 14 Rhythm Pattern Group (0 - 1) USER, PRESET	
# 00 65	0000 aaaa	Pad 14 Rhythm Pattern Number (0 - 255)	
00 67	0aaa aaaa	(reserve) <*>	
00 68	0aaa aaaa	(reserve) <*>	
00 69	0aaa aaaa	Pad 15 Velocity (1 - 127)	
00 6A	0000 000a	Pad 15 Rhythm Pattern Group (0 - 1) USER, PRESET	
# 00 6B	0000 aaaa	Pad 15 Rhythm Pattern Number (0 - 255)	
00 6D	0aaa aaaa	(reserve) <*>	
00 6E	0aaa aaaa	(reserve) <*>	
00 6F	0aaa aaaa	Pad 16 Velocity (1 - 127)	
00 70	0000 000a	Pad 16 Rhythm Pattern Group (0 - 1) USER, PRESET	
# 00 71	0000 aaaa	Pad 16 Rhythm Pattern Number (0 - 255)	
-----			
00 00 00 73	Total Size		

## \* Patch Common

Offset Address	Description	
00 00	0aaa aaaa	Patch Name 1 (32 - 127)
00 01	0aaa aaaa	Patch Name 2 (32 - 127) [ASCII]
00 02	0aaa aaaa	Patch Name 3 (32 - 127) [ASCII]
00 03	0aaa aaaa	Patch Name 4 (32 - 127) [ASCII]
00 04	0aaa aaaa	Patch Name 5 (32 - 127) [ASCII]
00 05	0aaa aaaa	Patch Name 6 (32 - 127) [ASCII]
00 06	0aaa aaaa	Patch Name 7 (32 - 127) [ASCII]
00 07	0aaa aaaa	Patch Name 8 (32 - 127) [ASCII]
00 08	0aaa aaaa	Patch Name 9 (32 - 127) [ASCII]
00 09	0aaa aaaa	Patch Name 10 (32 - 127) [ASCII]
00 0A	0aaa aaaa	Patch Name 11 (32 - 127) [ASCII]
00 0B	0aaa aaaa	Patch Name 12 (32 - 127) [ASCII]
00 0C	0aaa aaaa	Patch Category (0 - 127)
-----		
00 0D	0000 000a	(reserve)
00 0E	0aaa aaaa	Patch Level (0 - 127)
00 0F	0aaa aaaa	Patch Pan (0 - 127)
00 10	0000 000a	Patch Priority (0 - 1) LAST, LOUDEST
00 11	0aaa aaaa	Patch Coarse Tune (16 - 112) -48 +48
00 12	0aaa aaaa	Patch Fine Tune (14 - 114) -50 +50
00 13	0000 0aaa	Octave Shift (61 - 67) -3 +3
00 14	0000 00aa	Stretch Tune Depth (0 - 3)
00 15	0aaa aaaa	Analog Peel (0 - 127)
00 16	0000 000a	Mono/Poly (0 - 1) MONO, POLY
00 17	0000 000a	Legato Switch (0 - 1) OFF, ON
00 18	0000 000a	Legato Retrigger (0 - 1) OFF, ON
00 19	0000 000a	Portamento Switch (0 - 1) OFF, ON
00 1A	0000 000a	Portamento Mode (0 - 1) NORMAL, LEGATO
00 1B	0000 000a	Portamento Type (0 - 1) RATE, TIME
00 1C	0000 000a	Portamento Start (0 - 1) PITCH, NOTE
00 1D	0aaa aaaa	Portamento Time (0 - 127)
00 1E	0000 000a	(reserve)
00 1F	0000 aaaa	(reserve)
00 21	0000 000a	(reserve)
00 22	0aaa aaaa	Cutoff Offset (1 - 127) -63 +63
00 23	0aaa aaaa	Resonance Offset (1 - 127) -63 +63
00 24	0aaa aaaa	Attack Time Offset (1 - 127) -63 +63
00 25	0aaa aaaa	Release Time Offset (1 - 127) -63 +63
00 26	0aaa aaaa	Velocity Sens Offset (1 - 127) -63 +63
-----		
00 27	0000 aaaa	Patch Output Assign (0 - 13) MFx, A, ---, ---, ---, ---, ---, ---, ---, ---, ---, ---, ---, ---, TONE
00 28	0000 000a	TMT Control Switch (0 - 1) OFF, ON
00 29	00aa aaaa	Pitch Bend Range Up (0 - 48)
00 2A	00aa aaaa	Pitch Bend Range Down (0 - 48)
-----		
00 2B	0aaa aaaa	Matrix Control 1 Source (0 - 109) OFF, CC01 - CC31, CC33 - CC95, BEND, AFT, SVG1 - SVS4, VELOCITY, KEYFOLLOW, TEMPO, LFO1, LFO2, PIT-ENV, TVF-ENV, TVA-ENV
00 2C	00aa aaaa	Matrix Control 1 Destination 1 (0 - 33) OFF, PCH, CUT, RES, LEV, PAN, DRY, CHO, REV, PIT-LFO1, PIT-LFO2, TVF-LFO1, TVF-LFO2, TVA-LFO1, TVA-LFO2, PAN-LFO1, PAN-LFO2, LFO1-RATE, LFO2-RATE, PIT-ATK, PIT-DCY, PIT-REL, TVF-ATK, TVF-DCY, TVF-REL, TVA-ATK, TVA-DCY, TVA-REL, TMT, FXM, MFX1, MFX2, MFX3, MFX4
00 2D	0aaa aaaa	Matrix Control 1 Sens 1 (1 - 127) -63 +63



# MIDI Implementation

#	Offset	Address	Description	Value
	00 29	0000 aaaa 0000 bbbb 0000 cccc 0000 dddd	MFX Parameter 7	(12768 - 52768) -20000 - +20000
#	00 2D	0000 aaaa 0000 bbbb 0000 cccc 0000 dddd	MFX Parameter 8	(12768 - 52768) -20000 - +20000
#	00 31	0000 aaaa 0000 bbbb 0000 cccc 0000 dddd	MFX Parameter 9	(12768 - 52768) -20000 - +20000
#	00 35	0000 aaaa 0000 bbbb 0000 cccc 0000 dddd	MFX Parameter 10	(12768 - 52768) -20000 - +20000
#	00 39	0000 aaaa 0000 bbbb 0000 cccc 0000 dddd	MFX Parameter 11	(12768 - 52768) -20000 - +20000
#	00 3D	0000 aaaa 0000 bbbb 0000 cccc 0000 dddd	MFX Parameter 12	(12768 - 52768) -20000 - +20000
#	00 41	0000 aaaa 0000 bbbb 0000 cccc 0000 dddd	MFX Parameter 13	(12768 - 52768) -20000 - +20000
#	00 45	0000 aaaa 0000 bbbb 0000 cccc 0000 dddd	MFX Parameter 14	(12768 - 52768) -20000 - +20000
#	00 49	0000 aaaa 0000 bbbb 0000 cccc 0000 dddd	MFX Parameter 15	(12768 - 52768) -20000 - +20000
#	00 4D	0000 aaaa 0000 bbbb 0000 cccc 0000 dddd	MFX Parameter 16	(12768 - 52768) -20000 - +20000
#	00 51	0000 aaaa 0000 bbbb 0000 cccc 0000 dddd	MFX Parameter 17	(12768 - 52768) -20000 - +20000
#	00 55	0000 aaaa 0000 bbbb 0000 cccc 0000 dddd	MFX Parameter 18	(12768 - 52768) -20000 - +20000
#	00 59	0000 aaaa 0000 bbbb 0000 cccc 0000 dddd	MFX Parameter 19	(12768 - 52768) -20000 - +20000
#	00 5D	0000 aaaa 0000 bbbb 0000 cccc 0000 dddd	MFX Parameter 20	(12768 - 52768) -20000 - +20000
#	00 61	0000 aaaa 0000 bbbb 0000 cccc 0000 dddd	MFX Parameter 21	(12768 - 52768) -20000 - +20000
#	00 65	0000 aaaa 0000 bbbb 0000 cccc 0000 dddd	MFX Parameter 22	(12768 - 52768) -20000 - +20000
#	00 69	0000 aaaa 0000 bbbb 0000 cccc 0000 dddd	MFX Parameter 23	(12768 - 52768) -20000 - +20000
#	00 6D	0000 aaaa 0000 bbbb 0000 cccc 0000 dddd	MFX Parameter 24	(12768 - 52768) -20000 - +20000
#	00 71	0000 aaaa 0000 bbbb 0000 cccc 0000 dddd	MFX Parameter 25	(12768 - 52768) -20000 - +20000
#	00 75	0000 aaaa 0000 bbbb 0000 cccc 0000 dddd	MFX Parameter 26	(12768 - 52768) -20000 - +20000
#	00 79	0000 aaaa 0000 bbbb 0000 cccc 0000 dddd	MFX Parameter 27	(12768 - 52768) -20000 - +20000
#	00 7D	0000 aaaa 0000 bbbb 0000 cccc 0000 dddd	MFX Parameter 28	(12768 - 52768) -20000 - +20000
#	01 01	0000 aaaa 0000 bbbb 0000 cccc 0000 dddd	MFX Parameter 29	(12768 - 52768) -20000 - +20000
#	01 05	0000 aaaa 0000 bbbb 0000 cccc 0000 dddd	MFX Parameter 30	(12768 - 52768) -20000 - +20000
#	01 09	0000 aaaa 0000 bbbb 0000 cccc 0000 dddd	MFX Parameter 31	(12768 - 52768) -20000 - +20000
#	01 0D	0000 aaaa 0000 bbbb 0000 cccc 0000 dddd	MFX Parameter 32	(12768 - 52768) -20000 - +20000
		00 00 01 11	Total Size	

## \* Patch Common Chorus

Offset	Address	Description	Value
	00 00	0000 aaaa	Chorus Type (0 - 3)
	00 01	0aaa aaaa	Chorus Level (0 - 127)
	00 02	0000 00aa	Chorus Output Assign <*> A, ---, ---, ---
	00 03	0000 00aa	Chorus Output Select MAIN, REV, MAIN+REV
#	00 04	0000 aaaa 0000 bbbb 0000 cccc 0000 dddd	Chorus Parameter 1 (12768 - 52768) -20000 - +20000
#	00 08	0000 aaaa 0000 bbbb 0000 cccc 0000 dddd	Chorus Parameter 2 (12768 - 52768) -20000 - +20000
#	00 0C	0000 aaaa 0000 bbbb 0000 cccc 0000 dddd	Chorus Parameter 3 (12768 - 52768) -20000 - +20000
#	00 10	0000 aaaa 0000 bbbb 0000 cccc 0000 dddd	Chorus Parameter 4 (12768 - 52768) -20000 - +20000
#	00 14	0000 aaaa 0000 bbbb 0000 cccc 0000 dddd	Chorus Parameter 5 (12768 - 52768) -20000 - +20000
#	00 18	0000 aaaa 0000 bbbb 0000 cccc 0000 dddd	Chorus Parameter 6 (12768 - 52768) -20000 - +20000
#	00 1C	0000 aaaa 0000 bbbb 0000 cccc 0000 dddd	Chorus Parameter 7 (12768 - 52768) -20000 - +20000
#	00 20	0000 aaaa 0000 bbbb 0000 cccc 0000 dddd	Chorus Parameter 8 (12768 - 52768) -20000 - +20000
#	00 24	0000 aaaa 0000 bbbb 0000 cccc 0000 dddd	Chorus Parameter 9 (12768 - 52768) -20000 - +20000
#	00 28	0000 aaaa 0000 bbbb 0000 cccc 0000 dddd	Chorus Parameter 10 (12768 - 52768) -20000 - +20000
#	00 2C	0000 aaaa 0000 bbbb 0000 cccc 0000 dddd	Chorus Parameter 11 (12768 - 52768) -20000 - +20000
#	00 30	0000 aaaa 0000 bbbb 0000 cccc 0000 dddd	Chorus Parameter 12 (12768 - 52768) -20000 - +20000
#	00 34	0000 aaaa 0000 bbbb 0000 cccc 0000 dddd	Chorus Parameter 13 (12768 - 52768) -20000 - +20000
#	00 38	0000 aaaa 0000 bbbb 0000 cccc 0000 dddd	Chorus Parameter 14 (12768 - 52768) -20000 - +20000
#	00 3C	0000 aaaa 0000 bbbb 0000 cccc 0000 dddd	Chorus Parameter 15 (12768 - 52768) -20000 - +20000
#	00 40	0000 aaaa 0000 bbbb 0000 cccc 0000 dddd	Chorus Parameter 16 (12768 - 52768) -20000 - +20000
#	00 44	0000 aaaa 0000 bbbb 0000 cccc 0000 dddd	Chorus Parameter 17 (12768 - 52768) -20000 - +20000
#	00 48	0000 aaaa 0000 bbbb 0000 cccc 0000 dddd	Chorus Parameter 18 (12768 - 52768) -20000 - +20000
#	00 4C	0000 aaaa 0000 bbbb 0000 cccc 0000 dddd	Chorus Parameter 19 (12768 - 52768) -20000 - +20000
#	00 50	0000 aaaa 0000 bbbb 0000 cccc 0000 dddd	Chorus Parameter 20 (12768 - 52768) -20000 - +20000
		00 00 00 54	Total Size

## \* Patch Common Reverb

Offset	Address	Description	Value
	00 00	0000 aaaa	Reverb Type (0 - 5)
	00 01	0aaa aaaa	Reverb Level (0 - 127)
	00 02	0000 00aa	Reverb Output Assign <*> A, ---, ---, ---
#	00 03	0000 aaaa 0000 bbbb 0000 cccc 0000 dddd	Reverb Parameter 1 (12768 - 52768) -20000 - +20000
#	00 07	0000 aaaa 0000 bbbb 0000 cccc 0000 dddd	Reverb Parameter 2 (12768 - 52768) -20000 - +20000
#	00 0B	0000 aaaa 0000 bbbb 0000 cccc	

# MIDI Implementation

#	00 0F	0000 dddd 0000 aaaa 0000 bbbb 0000 cccc 0000 dddd	Reverb Parameter 3  Reverb Parameter 4	(12768 - 52768) -20000 - +20000 (12768 - 52768) -20000 - +20000
#	00 13	0000 aaaa 0000 bbbb 0000 cccc 0000 dddd	Reverb Parameter 5	(12768 - 52768) -20000 - +20000
#	00 17	0000 aaaa 0000 bbbb 0000 cccc 0000 dddd	Reverb Parameter 6	(12768 - 52768) -20000 - +20000
#	00 1B	0000 aaaa 0000 bbbb 0000 cccc 0000 dddd	Reverb Parameter 7	(12768 - 52768) -20000 - +20000
#	00 1F	0000 aaaa 0000 bbbb 0000 cccc 0000 dddd	Reverb Parameter 8	(12768 - 52768) -20000 - +20000
#	00 23	0000 aaaa 0000 bbbb 0000 cccc 0000 dddd	Reverb Parameter 9	(12768 - 52768) -20000 - +20000
#	00 27	0000 aaaa 0000 bbbb 0000 cccc 0000 dddd	Reverb Parameter 10	(12768 - 52768) -20000 - +20000
#	00 2B	0000 aaaa 0000 bbbb 0000 cccc 0000 dddd	Reverb Parameter 11	(12768 - 52768) -20000 - +20000
#	00 2F	0000 aaaa 0000 bbbb 0000 cccc 0000 dddd	Reverb Parameter 12	(12768 - 52768) -20000 - +20000
#	00 33	0000 aaaa 0000 bbbb 0000 cccc 0000 dddd	Reverb Parameter 13	(12768 - 52768) -20000 - +20000
#	00 37	0000 aaaa 0000 bbbb 0000 cccc 0000 dddd	Reverb Parameter 14	(12768 - 52768) -20000 - +20000
#	00 3B	0000 aaaa 0000 bbbb 0000 cccc 0000 dddd	Reverb Parameter 15	(12768 - 52768) -20000 - +20000
#	00 3F	0000 aaaa 0000 bbbb 0000 cccc 0000 dddd	Reverb Parameter 16	(12768 - 52768) -20000 - +20000
#	00 43	0000 aaaa 0000 bbbb 0000 cccc 0000 dddd	Reverb Parameter 17	(12768 - 52768) -20000 - +20000
#	00 47	0000 aaaa 0000 bbbb 0000 cccc 0000 dddd	Reverb Parameter 18	(12768 - 52768) -20000 - +20000
#	00 4B	0000 aaaa 0000 bbbb 0000 cccc 0000 dddd	Reverb Parameter 19	(12768 - 52768) -20000 - +20000
#	00 4F	0000 aaaa 0000 bbbb 0000 cccc 0000 dddd	Reverb Parameter 20	(12768 - 52768) -20000 - +20000
00 00 00 53		Total Size		

## \* Patch TMT (Tone Mix Table)

Offset	Address	Description	
00 00	0000 aaaa	Structure Type 1 & 2	(0 - 9) 1 - 10
00 01	0000 00aa	Booster 1 & 2	(0 - 3) 0, +6, +12, +18 [dB]
00 02	0000 aaaa	Structure Type 3 & 4	(0 - 9) 1 - 10
00 03	0000 00aa	Booster 3 & 4	(0 - 3) 0, +6, +12, +18 [dB]
00 04	0000 00aa	TMT Velocity Control	(0 - 3) OFF, ON, RANDOM, CYCLE
00 05	0000 000a	TMT1 Tone Switch	(0 - 1) OFF, ON
00 06	0aaa aaaa	TMT1 Keyboard Range Lower	(0 - 127) C-1 - UPPER
00 07	0aaa aaaa	TMT1 Keyboard Range Upper	(0 - 127) LOWER - G9
00 08	0aaa aaaa	TMT1 Keyboard Fade Width Lower	(0 - 127)
00 09	0aaa aaaa	TMT1 Keyboard Fade Width Upper	(0 - 127)
00 0A	0aaa aaaa	TMT1 Velocity Range Lower	(1 - 127) 1 - UPPER
00 0B	0aaa aaaa	TMT1 Velocity Range Upper	(1 - 127) LOWER - 127
00 0C	0aaa aaaa	TMT1 Velocity Fade Width Lower	(0 - 127)
00 0D	0aaa aaaa	TMT1 Velocity Fade Width Upper	(0 - 127)
00 0E	0000 000a	TMT2 Tone Switch	(0 - 1) OFF, ON
00 0F	0aaa aaaa	TMT2 Keyboard Range Lower	(0 - 127) C-1 - UPPER
00 10	0aaa aaaa	TMT2 Keyboard Range Upper	(0 - 127) LOWER - G9
00 11	0aaa aaaa	TMT2 Keyboard Fade Width Lower	(0 - 127)
00 12	0aaa aaaa	TMT2 Keyboard Fade Width Upper	(0 - 127)
00 13	0aaa aaaa	TMT2 Velocity Range Lower	(1 - 127) 1 - UPPER
00 14	0aaa aaaa	TMT2 Velocity Range Upper	(1 - 127) LOWER - 127
00 15	0aaa aaaa	TMT2 Velocity Fade Width Lower	(0 - 127)
00 16	0aaa aaaa	TMT2 Velocity Fade Width Upper	(0 - 127)

00 17	0000 000a	TMT3 Tone Switch	(0 - 1) OFF, ON
00 18	0aaa aaaa	TMT3 Keyboard Range Lower	(0 - 127) C-1 - UPPER
00 19	0aaa aaaa	TMT3 Keyboard Range Upper	(0 - 127) LOWER - G9
00 1A	0aaa aaaa	TMT3 Keyboard Fade Width Lower	(0 - 127)
00 1B	0aaa aaaa	TMT3 Keyboard Fade Width Upper	(0 - 127)
00 1C	0aaa aaaa	TMT3 Velocity Range Lower	(1 - 127) 1 - UPPER
00 1D	0aaa aaaa	TMT3 Velocity Range Upper	(1 - 127) LOWER - 127
00 1E	0aaa aaaa	TMT3 Velocity Fade Width Lower	(0 - 127)
00 1F	0aaa aaaa	TMT3 Velocity Fade Width Upper	(0 - 127)
00 20	0000 000a	TMT4 Tone Switch	(0 - 1) OFF, ON
00 21	0aaa aaaa	TMT4 Keyboard Range Lower	(0 - 127) C-1 - UPPER
00 22	0aaa aaaa	TMT4 Keyboard Range Upper	(0 - 127) LOWER - G9
00 23	0aaa aaaa	TMT4 Keyboard Fade Width Lower	(0 - 127)
00 24	0aaa aaaa	TMT4 Keyboard Fade Width Upper	(0 - 127)
00 25	0aaa aaaa	TMT4 Velocity Range Lower	(1 - 127) 1 - UPPER
00 26	0aaa aaaa	TMT4 Velocity Range Upper	(1 - 127) LOWER - 127
00 27	0aaa aaaa	TMT4 Velocity Fade Width Lower	(0 - 127)
00 28	0aaa aaaa	TMT4 Velocity Fade Width Upper	(0 - 127)
00 00 00 29	Total Size		

## \* Patch Tone

Offset	Address	Description	
00 00	0aaa aaaa	Tone Level	(0 - 127)
00 01	0aaa aaaa	Tone Coarse Tune	(16 - 112)
00 02	0aaa aaaa	Tone Fine Tune	-48 - +48 (14 - 114)
00 03	000a aaaa	Tone Random Pitch Depth	-50 - +50 (0 - 30) 0, 1, 2, 3, 4, 5, 6, 7, 8, 9, 10, 20, 30, 40, 50, 60, 70, 80, 90, 100, 200, 300, 400, 500, 600, 700, 800, 900, 1000, 1100, 1200
00 04	0aaa aaaa	Tone Pan	(0 - 127) L64 - 63R
00 05	000a aaaa	Tone Pan Keyfollow	(54 - 74)
00 06	00aa aaaa	Tone Random Pan Depth	-100 - +100 (0 - 63)
00 07	0aaa aaaa	Tone Alternate Pan Depth	(1 - 127) L63 - 63R
00 08	0000 000a	Tone Env Mode	(0 - 1) NO-SUS, SUSTAIN
00 09	0000 00aa	Tone Delay Mode	(0 - 3) NORMAL, HOLD, KEY-OFF-NORMAL, KEY-OFF-DECAY
# 00 0A	0000 aaaa 0000 bbbb	Tone Delay Time	(0 - 149) 0 - 127, MUSICAL-NOTES
00 0C	0aaa aaaa	Tone Dry Send Level	(0 - 127)
00 0D	0aaa aaaa	Tone Chorus Send Level (MFX)	(0 - 127)
00 0E	0aaa aaaa	Tone Reverb Send Level (MFX)	(0 - 127)
00 0F	0aaa aaaa	Tone Chorus Send Level (non MFX)	(0 - 127)
00 10	0aaa aaaa	Tone Reverb Send Level (non MFX)	(0 - 127)
00 11	0000 aaaa	Tone Output Assign	(0 - 12) 1, 2, ---, ---, ---, ---, MFX, A, ---, ---, ---, ---
00 12	0000 000a	Tone Receive Bender	(0 - 1) OFF, ON
00 13	0000 000a	Tone Receive Expression	(0 - 1) OFF, ON
00 14	0000 000a	Tone Receive Hold-1	(0 - 1) OFF, ON
00 15	0000 000a	Tone Receive Pan Mode	(0 - 1) CONTINUOUS, KEY-ON
00 16	0000 000a	Tone Redamper Switch	(0 - 1) OFF, ON
00 17	0000 00aa	Tone Control 1 Switch 1	(0 - 2) OFF, ON, REVERSE
00 18	0000 00aa	Tone Control 1 Switch 2	(0 - 2) OFF, ON, REVERSE
00 19	0000 00aa	Tone Control 1 Switch 3	(0 - 2) OFF, ON, REVERSE
00 1A	0000 00aa	Tone Control 1 Switch 4	(0 - 2) OFF, ON, REVERSE
00 1B	0000 00aa	Tone Control 2 Switch 1	(0 - 2) OFF, ON, REVERSE
00 1C	0000 00aa	Tone Control 2 Switch 2	(0 - 2) OFF, ON, REVERSE
00 1D	0000 00aa	Tone Control 2 Switch 3	(0 - 2) OFF, ON, REVERSE
00 1E	0000 00aa	Tone Control 2 Switch 4	(0 - 2) OFF, ON, REVERSE
00 1F	0000 00aa	Tone Control 3 Switch 1	(0 - 2) OFF, ON, REVERSE
00 20	0000 00aa	Tone Control 3 Switch 2	(0 - 2) OFF, ON, REVERSE
00 21	0000 00aa	Tone Control 3 Switch 3	(0 - 2) OFF, ON, REVERSE
00 22	0000 00aa	Tone Control 3 Switch 4	(0 - 2) OFF, ON, REVERSE
00 23	0000 00aa	Tone Control 4 Switch 1	(0 - 2) OFF, ON, REVERSE
00 24	0000 00aa	Tone Control 4 Switch 2	(0 - 2) OFF, ON, REVERSE
00 25	0000 00aa	Tone Control 4 Switch 3	(0 - 2) OFF, ON, REVERSE
00 26	0000 00aa	Tone Control 4 Switch 4	(0 - 2) OFF, ON, REVERSE
00 27	0000 00aa	Wave Group Type	(0 - 3) INT, SRX, SAMPLE, MULTISAMPLE
# 00 28	0000 aaaa 0000 bbbb 0000 cccc 0000 dddd	Wave Group ID	(0 - 16384) OFF, 1 - 16384
# 00 2C	0000 aaaa 0000 bbbb 0000 cccc 0000 dddd	Wave Number L (Mono)	(0 - 16384) OFF, 1 - 16384
# 00 30	0000 aaaa 0000 bbbb 0000 cccc 0000 dddd	Wave Number R	(0 - 16384) OFF, 1 - 16384
00 34	0000 00aa	Wave Gain	(0 - 3)







## \* Rhythm Common Reverb

Offset Address	Description	
00 00	0000 aaaa	Reverb Type (0 - 5)
00 01	00aa aaaa	Reverb Level (0 - 127)
00 02	0000 00aa	Reverb Output Assign <*> A, ---, ---, ---
# 00 03	0000 aaaa 0000 bbbb 0000 cccc 0000 dddd	Reverb Parameter 1 (12768 - 52768) -20000 - +20000
# 00 07	0000 aaaa 0000 bbbb 0000 cccc 0000 dddd	Reverb Parameter 2 (12768 - 52768) -20000 - +20000
# 00 0B	0000 aaaa 0000 bbbb 0000 cccc 0000 dddd	Reverb Parameter 3 (12768 - 52768) -20000 - +20000
# 00 0F	0000 aaaa 0000 bbbb 0000 cccc 0000 dddd	Reverb Parameter 4 (12768 - 52768) -20000 - +20000
# 00 13	0000 aaaa 0000 bbbb 0000 cccc 0000 dddd	Reverb Parameter 5 (12768 - 52768) -20000 - +20000
# 00 17	0000 aaaa 0000 bbbb 0000 cccc 0000 dddd	Reverb Parameter 6 (12768 - 52768) -20000 - +20000
# 00 1B	0000 aaaa 0000 bbbb 0000 cccc 0000 dddd	Reverb Parameter 7 (12768 - 52768) -20000 - +20000
# 00 1F	0000 aaaa 0000 bbbb 0000 cccc 0000 dddd	Reverb Parameter 8 (12768 - 52768) -20000 - +20000
# 00 23	0000 aaaa 0000 bbbb 0000 cccc 0000 dddd	Reverb Parameter 9 (12768 - 52768) -20000 - +20000
# 00 27	0000 aaaa 0000 bbbb 0000 cccc 0000 dddd	Reverb Parameter 10 (12768 - 52768) -20000 - +20000
# 00 2B	0000 aaaa 0000 bbbb 0000 cccc 0000 dddd	Reverb Parameter 11 (12768 - 52768) -20000 - +20000
# 00 2F	0000 aaaa 0000 bbbb 0000 cccc 0000 dddd	Reverb Parameter 12 (12768 - 52768) -20000 - +20000
# 00 33	0000 aaaa 0000 bbbb 0000 cccc 0000 dddd	Reverb Parameter 13 (12768 - 52768) -20000 - +20000
# 00 37	0000 aaaa 0000 bbbb 0000 cccc 0000 dddd	Reverb Parameter 14 (12768 - 52768) -20000 - +20000
# 00 3B	0000 aaaa 0000 bbbb 0000 cccc 0000 dddd	Reverb Parameter 15 (12768 - 52768) -20000 - +20000
# 00 3F	0000 aaaa 0000 bbbb 0000 cccc 0000 dddd	Reverb Parameter 16 (12768 - 52768) -20000 - +20000
# 00 43	0000 aaaa 0000 bbbb 0000 cccc 0000 dddd	Reverb Parameter 17 (12768 - 52768) -20000 - +20000
# 00 47	0000 aaaa 0000 bbbb 0000 cccc 0000 dddd	Reverb Parameter 18 (12768 - 52768) -20000 - +20000
# 00 4B	0000 aaaa 0000 bbbb 0000 cccc 0000 dddd	Reverb Parameter 19 (12768 - 52768) -20000 - +20000
# 00 4F	0000 aaaa 0000 bbbb 0000 cccc 0000 dddd	Reverb Parameter 20 (12768 - 52768) -20000 - +20000
00 00 00 53	Total Size	

## \* Rhythm Tone

Offset Address	Description	
00 00	0aaa aaaa	Tone Name 1 (32 - 127)
00 01	0aaa aaaa	Tone Name 2 (32 - 127) [ASCII]
00 02	0aaa aaaa	Tone Name 3 (32 - 127) [ASCII]
00 03	0aaa aaaa	Tone Name 4 (32 - 127) [ASCII]
00 04	0aaa aaaa	Tone Name 5 (32 - 127) [ASCII]
00 05	0aaa aaaa	Tone Name 6 (32 - 127) [ASCII]
00 06	0aaa aaaa	Tone Name 7 (32 - 127) [ASCII]
00 07	0aaa aaaa	Tone Name 8 (32 - 127) [ASCII]
00 08	0aaa aaaa	Tone Name 9 (32 - 127) [ASCII]

00 09	0aaa aaaa	Tone Name 10 (32 - 127) [ASCII]
00 0A	0aaa aaaa	Tone Name 11 (32 - 127) [ASCII]
00 0B	0aaa aaaa	Tone Name 12 (32 - 127) [ASCII]
00 0C	0000 000a	Assign Type (0 - 1) MULTI, SINGLE
00 0D	000a aaaa	Mute Group (0 - 31) OFF, 1 - 31
00 0E	0aaa aaaa	Tone Level (0 - 127)
00 0F	0aaa aaaa	Tone Coarse Tune (0 - 127) C-1 - G9
00 10	0aaa aaaa	Tone Fine Tune (14 - 114) -50 - +50
00 11	000a aaaa	Tone Random Pitch Depth (0 - 30) 0, 1, 2, 3, 4, 5, 6, 7, 8, 9, 10, 20, 30, 40, 50, 60, 70, 80, 90, 100, 200, 300, 400, 500, 600, 700, 800, 900, 1000, 1100, 1200
00 12	0aaa aaaa	Tone Pan (0 - 127) L64 - 63R
00 13	00aa aaaa	Tone Random Pan Depth (0 - 63)
00 14	0aaa aaaa	Tone Alternate Pan Depth (1 - 127) L63 - 63R
00 15	0000 000a	Tone Env Mode (0 - 1) NO-SUS, SUSTAIN
00 16	0aaa aaaa	Tone Dry Send Level (0 - 127)
00 17	0aaa aaaa	Tone Chorus Send Level (0 - 127)
00 18	0aaa aaaa	Tone Reverb Send Level (0 - 127)
00 19	0aaa aaaa	Tone Chorus Send Level (non MFX) (0 - 127)
00 1A	0aaa aaaa	Tone Reverb Send Level (non MFX) (0 - 127)
00 1B	0000 aaaa	Tone Output Assign (0 - 12) MFX, A, ---, ---, ---, ---, 1, 2, ---, ---, ---, ---
00 1C	00aa aaaa	Tone Pitch Bend Range (0 - 48)
00 1D	0000 000a	Tone Receive Expression (0 - 1) OFF, ON
00 1E	0000 000a	Tone Receive Hold-1 (0 - 1) OFF, ON
00 1F	0000 000a	Tone Receive Pan Mode (0 - 1) CONTINUOUS, KEY-ON
00 20	0000 00aa	WMT Velocity Control (0 - 2) OFF, ON, RANDOM
00 21	0000 000a	WMT1 Wave Switch (0 - 1) OFF, ON
00 22	0000 00aa	WMT1 Wave Group Type (0 - 3) INT, SRX, SAMPLE, MULTISAMPLE
# 00 23	0000 aaaa 0000 bbbb 0000 cccc 0000 dddd	WMT1 Wave Group ID (0 - 16384) OFF, 1 - 16384
# 00 27	0000 aaaa 0000 bbbb 0000 cccc 0000 dddd	WMT1 Wave Number L (Mono) (0 - 16384) OFF, 1 - 16384
# 00 2B	0000 aaaa 0000 bbbb 0000 cccc 0000 dddd	WMT1 Wave Number R (0 - 16384) OFF, 1 - 16384
00 2F	0000 00aa	WMT1 Wave Gain (0 - 3) -6, 0, +6, +12 [dB]
00 30	0000 000a	WMT1 Wave FXM Switch (0 - 1) OFF, ON
00 31	0000 00aa	WMT1 Wave FXM Color (0 - 3) 1 - 4
00 32	000a aaaa	WMT1 Wave FXM Depth (0 - 16)
00 33	0000 000a	WMT1 Wave Tempo Sync (0 - 1) OFF, ON
00 34	0aaa aaaa	WMT1 Wave Coarse Tune (16 - 112) -48 - +48
00 35	0aaa aaaa	WMT1 Wave Fine Tune (14 - 114) -50 - +50
00 36	0aaa aaaa	WMT1 Wave Pan (0 - 127) L64 - 63R
00 37	0000 000a	WMT1 Wave Random Pan Switch (0 - 1) OFF, ON
00 38	0000 00aa	WMT1 Wave Alternate Pan Switch (0 - 2) OFF, ON, REVERSE
00 39	0aaa aaaa	WMT1 Wave Level (0 - 127)
00 3A	0aaa aaaa	WMT1 Velocity Range Lower (1 - 127) 1 - UPPER
00 3B	0aaa aaaa	WMT1 Velocity Range Upper (1 - 127) LOWER, 127
00 3C	0aaa aaaa	WMT1 Velocity Fade Width Lower (0 - 127)
00 3D	0aaa aaaa	WMT1 Velocity Fade Width Upper (0 - 127)
00 3E	0000 000a	WMT2 Wave Switch (0 - 1) OFF, ON
00 3F	0000 00aa	WMT2 Wave Group Type (0 - 3) INT, SRX, SAMPLE, MULTISAMPLE
# 00 40	0000 aaaa 0000 bbbb 0000 cccc 0000 dddd	WMT2 Wave Group ID (0 - 16384) OFF, 1 - 16384
# 00 44	0000 aaaa 0000 bbbb 0000 cccc 0000 dddd	WMT2 Wave Number L (Mono) (0 - 16384) OFF, 1 - 16384
# 00 48	0000 aaaa 0000 bbbb 0000 cccc 0000 dddd	WMT2 Wave Number R (0 - 16384) OFF, 1 - 16384
00 4C	0000 00aa	WMT2 Wave Gain (0 - 3) -6, 0, +6, +12 [dB]
00 4D	0000 000a	WMT2 Wave FXM Switch (0 - 1) OFF, ON
00 4E	0000 00aa	WMT2 Wave FXM Color (0 - 3) 1 - 4
00 4F	000a aaaa	WMT2 Wave FXM Depth (0 - 16)
00 50	0000 000a	WMT2 Wave Tempo Sync (0 - 1) OFF, ON
00 51	0aaa aaaa	WMT2 Wave Coarse Tune (16 - 112) -48 - +48
00 52	0aaa aaaa	WMT2 Wave Fine Tune (14 - 114) -50 - +50
00 53	0aaa aaaa	WMT2 Wave Pan (0 - 127) L64 - 63R
00 54	0000 000a	WMT2 Wave Random Pan Switch (0 - 1) OFF, ON
00 55	0000 00aa	WMT2 Wave Alternate Pan Switch (0 - 2) OFF, ON, REVERSE
00 56	0aaa aaaa	WMT2 Wave Level (0 - 127)
00 57	0aaa aaaa	WMT2 Velocity Range Lower (1 - 127) 1 - UPPER

# MIDI Implementation

00 58	0aaa aaaa	WMT2 Velocity Range Upper	(1 - 127)
			LOWER - 127
00 59	0aaa aaaa	WMT2 Velocity Fade Width Lower	(0 - 127)
00 5A	0aaa aaaa	WMT2 Velocity Fade Width Upper	(0 - 127)
00 5B	0000 000a	WMT3 Wave Switch	(0 - 1)
			OFF, ON
00 5C	0000 00aa	WMT3 Wave Group Type	(0 - 3)
			INT, SRX, SAMPLE, MULTISAMPLE
#	00 5D	0000 aaaa 0000 bbbb 0000 cccc 0000 dddd	WMT3 Wave Group ID
			(0 - 16384)
			OFF, 1 - 16384
#	00 61	0000 aaaa 0000 bbbb 0000 cccc 0000 dddd	WMT3 Wave Number L (Mono)
			(0 - 16384)
			OFF, 1 - 16384
#	00 65	0000 aaaa 0000 bbbb 0000 cccc 0000 dddd	WMT3 Wave Number R
			(0 - 16384)
			OFF, 1 - 16384
00 69	0000 00aa	WMT3 Wave Gain	(0 - 1)
			OFF, 1 - 16384
00 6A	0000 000a	WMT3 Wave FXM Switch	(0 - 3)
			-6, 0, +6, +12 [dB]
00 6B	0000 00aa	WMT3 Wave FXM Color	(0 - 3)
			OFF, ON
			1 - 4
00 6C	000a aaaa	WMT3 Wave FXM Depth	(0 - 16)
00 6D	0000 000a	WMT3 Wave Tempo Sync	(0 - 1)
			OFF, ON
00 6E	0aaa aaaa	WMT3 Wave Coarse Tune	(16 - 112)
			-48 - +48
00 6F	0aaa aaaa	WMT3 Wave Fine Tune	(14 - 114)
			-50 - +50
00 70	0aaa aaaa	WMT3 Wave Pan	(0 - 127)
			L64 - 63R
00 71	0000 000a	WMT3 Wave Random Pan Switch	(0 - 1)
			OFF, ON
00 72	0000 00aa	WMT3 Wave Alternate Pan Switch	(0 - 2)
			OFF, ON, REVERSE
00 73	0aaa aaaa	WMT3 Wave Level	(0 - 127)
00 74	0aaa aaaa	WMT3 Velocity Range Lower	(1 - 127)
			1 - UPPER
00 75	0aaa aaaa	WMT3 Velocity Range Upper	(1 - 127)
			LOWER - 127
00 76	0aaa aaaa	WMT3 Velocity Fade Width Lower	(0 - 127)
00 77	0aaa aaaa	WMT3 Velocity Fade Width Upper	(0 - 127)
00 78	0000 000a	WMT4 Wave Switch	(0 - 1)
			OFF, ON
00 79	0000 00aa	WMT4 Wave Group Type	(0 - 3)
			INT, SRX, SAMPLE, MULTISAMPLE
#	00 7A	0000 aaaa 0000 bbbb 0000 cccc 0000 dddd	WMT4 Wave Group ID
			(0 - 16384)
			OFF, 1 - 16384
#	00 7E	0000 aaaa 0000 bbbb 0000 cccc 0000 dddd	WMT4 Wave Number L (Mono)
			(0 - 16384)
			OFF, 1 - 16384
#	01 02	0000 aaaa 0000 bbbb 0000 cccc 0000 dddd	WMT4 Wave Number R
			(0 - 16384)
			OFF, 1 - 16384
01 06	0000 00aa	WMT4 Wave Gain	(0 - 3)
			-6, 0, +6, +12 [dB]
01 07	0000 000a	WMT4 Wave FXM Switch	(0 - 1)
			OFF, ON
01 08	0000 00aa	WMT4 Wave FXM Color	(0 - 3)
			OFF, ON
			1 - 4
01 09	000a aaaa	WMT4 Wave FXM Depth	(0 - 16)
01 0A	0000 000a	WMT4 Wave Tempo Sync	(0 - 1)
			OFF, ON
01 0B	0aaa aaaa	WMT4 Wave Coarse Tune	(16 - 112)
			-48 - +48
01 0C	0aaa aaaa	WMT4 Wave Fine Tune	(14 - 114)
			-50 - +50
01 0D	0aaa aaaa	WMT4 Wave Pan	(0 - 127)
			L64 - 63R
01 0E	0000 000a	WMT4 Wave Random Pan Switch	(0 - 1)
			OFF, ON
01 0F	0000 00aa	WMT4 Wave Alternate Pan Switch	(0 - 2)
			OFF, ON, REVERSE
01 10	0aaa aaaa	WMT4 Wave Level	(0 - 127)
01 11	0aaa aaaa	WMT4 Velocity Range Lower	(1 - 127)
			1 - UPPER
01 12	0aaa aaaa	WMT4 Velocity Range Upper	(1 - 127)
			LOWER - 127
01 13	0aaa aaaa	WMT4 Velocity Fade Width Lower	(0 - 127)
01 14	0aaa aaaa	WMT4 Velocity Fade Width Upper	(0 - 127)
			---
01 15	000a aaaa	Pitch Env Depth	(52 - 76)
			-12 - +12
01 16	0aaa aaaa	Pitch Env Velocity Sens	(1 - 127)
			-63 - +63
01 17	0aaa aaaa	Pitch Env Time 1 Velocity Sens	(1 - 127)
			-63 - +63
01 18	0aaa aaaa	Pitch Env Time 4 Velocity Sens	(1 - 127)
			-63 - +63
01 19	0aaa aaaa	Pitch Env Time 1	(0 - 127)
01 1A	0aaa aaaa	Pitch Env Time 2	(0 - 127)
01 1B	0aaa aaaa	Pitch Env Time 3	(0 - 127)
01 1C	0aaa aaaa	Pitch Env Time 4	(0 - 127)
01 1D	0aaa aaaa	Pitch Env Level 0	(1 - 127)
			-63 - +63
01 1E	0aaa aaaa	Pitch Env Level 1	(1 - 127)
			-63 - +63
01 1F	0aaa aaaa	Pitch Env Level 2	(1 - 127)
			-63 - +63
01 20	0aaa aaaa	Pitch Env Level 3	(1 - 127)
			-63 - +63
01 21	0aaa aaaa	Pitch Env Level 4	(1 - 127)
			-63 - +63
			---
01 22	0000 0aaa	TVF Filter Type	(0 - 6)
			OFF, LPF, BPF, HPP, PKG, LPP2, LPP3
01 23	0aaa aaaa	TVF Cutoff Frequency	(0 - 127)
01 24	0000 0aaa	TVF Cutoff Velocity Curve	(0 - 7)
			FIXED, 1 - 7
01 25	0aaa aaaa	TVF Cutoff Velocity Sens	(1 - 127)
			-63 - +63
01 26	0aaa aaaa	TVF Resonance	(0 - 127)
01 27	0aaa aaaa	TVF Resonance Velocity Sens	(1 - 127)
			-63 - +63
01 28	0aaa aaaa	TVF Env Depth	(1 - 127)
			-63 - +63
01 29	0000 0aaa	TVF Env Velocity Curve Type	(0 - 7)
			FIXED, 1 - 7
01 2A	0aaa aaaa	TVF Env Velocity Sens	(1 - 127)
			-63 - +63
01 2B	0aaa aaaa	TVF Env Time 1 Velocity Sens	(1 - 127)
			-63 - +63
01 2C	0aaa aaaa	TVF Env Time 4 Velocity Sens	(1 - 127)
			-63 - +63

01 2D	0aaa aaaa	TVF Env Time 1	(0 - 127)
01 2E	0aaa aaaa	TVF Env Time 2	(0 - 127)
01 2F	0aaa aaaa	TVF Env Time 3	(0 - 127)
01 30	0aaa aaaa	TVF Env Time 4	(0 - 127)
01 31	0aaa aaaa	TVF Env Level 0	(0 - 127)
01 32	0aaa aaaa	TVF Env Level 1	(0 - 127)
01 33	0aaa aaaa	TVF Env Level 2	(0 - 127)
01 34	0aaa aaaa	TVF Env Level 3	(0 - 127)
01 35	0aaa aaaa	TVF Env Level 4	(0 - 127)
			---
01 36	0000 0aaa	TVA Level Velocity Curve	(0 - 7)
			FIXED, 1 - 7
01 37	0aaa aaaa	TVA Level Velocity Sens	(1 - 127)
			-63 - +63
01 38	0aaa aaaa	TVA Env Time 1 Velocity Sens	(1 - 127)
			-63 - +63
01 39	0aaa aaaa	TVA Env Time 4 Velocity Sens	(1 - 127)
			-63 - +63
01 3A	0aaa aaaa	TVA Env Time 1	(0 - 127)
01 3B	0aaa aaaa	TVA Env Time 2	(0 - 127)
01 3C	0aaa aaaa	TVA Env Time 3	(0 - 127)
01 3D	0aaa aaaa	TVA Env Time 4	(0 - 127)
01 3E	0aaa aaaa	TVA Env Level 1	(0 - 127)
01 3F	0aaa aaaa	TVA Env Level 2	(0 - 127)
01 40	0aaa aaaa	TVA Env Level 3	(0 - 127)
			---
01 41	0000 000a	One Shot Mode	(0 - 1)
			OFF, ON
01 42	0aaa aaaa	Relative Level	(0 - 127)
			-64 - +63
			---
00 00 01 43	Total Size		

## 4. Supplementary Material

### Decimal and Hexadecimal Table

(An "H" is appended to the end of numbers in hexadecimal notation.)  
 In MIDI documentation, data values and addresses/sizes of Exclusive messages, etc. are expressed as hexadecimal values for each 7 bits.  
 The following table shows how these correspond to decimal numbers.

D	H	D	H	D	H	D	H
0	00H	32	20H	64	40H	96	60H
1	01H	33	21H	65	41H	97	61H
2	02H	34	22H	66	42H	98	62H
3	03H	35	23H	67	43H	99	63H
4	04H	36	24H	68	44H	100	64H
5	05H	37	25H	69	45H	101	65H
6	06H	38	26H	70	46H	102	66H
7	07H	39	27H	71	47H	103	67H
8	08H	40	28H	72	48H	104	68H
9	09H	41	29H	73	49H	105	69H
10	0AH	42	2AH	74	4AH	106	6AH
11	0BH	43	2BH	75	4BH	107	6BH
12	0CH	44	2CH	76	4CH	108	6CH
13	0DH	45	2DH	77	4DH	109	6DH
14	0EH	46	2EH	78	4EH	110	6EH
15	0FH	47	2FH	79	4FH	111	6FH
16	10H	48	30H	80	50H	112	70H
17	11H	49	31H	81	51H	113	71H
18	12H	50	32H	82	52H	114	72H
19	13H	51	33H	83	53H	115	73H
20	14H	52	34H	84	54H	116	74H
21	15H	53	35H	85	55H	117	75H
22	16H	54	36H	86	56H	118	76H
23	17H	55	37H	87	57H	119	77H
24	18H	56	38H	88	58H	120	78H
25	19H	57	39H	89	59H	121	79H
26	1AH	58	3AH	90	5AH	122	7AH
27	1BH	59	3BH	91	5BH	123	7BH
28	1CH	60	3CH	92	5CH	124	7CH
29	1DH	61	3DH	93	5DH	125	7DH
30	1EH	62	3EH	94	5EH	126	7EH
31	1FH	63	3FH	95	5FH	127	7FH

D: decimal  
 H: hexadecimal

- \* Decimal values such as MIDI channel, bank select, and program change are listed as one greater than the values given in the above table.
- \* A 7-bit byte can express data in the range of 128 steps. For data where greater precision is required, we must use two or more bytes. For example, two hexadecimal numbers aa bbH expressing two 7-bit bytes would indicate a value of  $aa \times 128 + bb$ .
- \* In the case of values which have a +/- sign, 00H = -64, 40H = +/-0, and 7FH = +63, so that the decimal expression would be 64 less than the value given in the above chart. In the case of two types, 00 00H = -8192, 40 00H = +/-0, and 7F 7FH = +8191. For example, if aa bbH were expressed as decimal, this would be  $aa \text{ bbH} - 40 \text{ 00H} = aa \times 128 + bb - 64 \times 128$ .
- \* Data marked "Use nibbled data" is expressed in hexadecimal in 4-bit units. A value expressed as a 2-byte nibble 0a 0bH has the value of  $a \times 16 + b$ .

#### <Example1> What is the decimal expression of 5AH?

From the preceding table, 5AH = 90

#### <Example2> What is the decimal expression of the value 12 34H given as hexadecimal for each 7 bits?

From the preceding table, since 12H = 18 and 34H = 52  
 $18 \times 128 + 52 = 2356$

#### <Example3> What is the decimal expression of the nibbled value 0A 03 09 0D?

From the preceding table, since 0AH = 10, 03H = 3, 09H = 9, 0DH = 13  
 $((10 \times 16 + 3) \times 16 + 9) \times 16 + 13 = 41885$

#### <Example4> What is the nibbled expression of the decimal value 1258?

```

16 ) 1258
   )  78 ...10
   )  4  ...14
   )  0  ... 4

```

Since from the preceding table, 0 = 00H, 4 = 04H, 14 = 0EH, 10 = 0AH, the result is: 00 04 0E 0AH.

### Examples of Actual MIDI Messages

#### <Example1> 92 3E 5F

9n is the Note-on status, and n is the MIDI channel number. Since 2H = 2, 3EH = 62, and 5FH = 95, this is a Note-on message with MIDI CH = 3, note number 62 (note name is D4), and velocity 95.

#### <Example2> CE 49

EnH is the Program Change status, and n is the MIDI channel number. Since EH = 14 and 49H = 73, this is a Program Change message with MIDI CH = 15, program number 74.

#### <Example3> EA 00 28

EnH is the Pitch Bend Change status, and n is the MIDI channel number. The 2nd byte (00H = 0) is the LSB and the 3rd byte (28H = 40) is the MSB, but Pitch Bend Value is a signed number in which  $40 \text{ 00H} (= 64 \times 12 + 80 = 8192)$  is 0, so this Pitch Bend Value is  $28 \text{ 00H} - 40 \text{ 00H} = 40 \times 12 + 80 - (64 \times 12 + 80) = 5120 - 8192 = -3072$

If the Pitch Bend Sensitivity is set to 2 semitones, -8192 (00 00H) will cause the pitch to change -200 cents, so in this case  $-200 \times (-3072) \div (-8192) = -75$  cents of Pitch Bend is being applied to MIDI channel 11.

#### <Example4> B3 64 00 65 00 06 0C 26 00 64 7F 65 7F

BnH is the Control Change status, and n is the MIDI channel number. For Control Changes, the 2nd byte is the control number, and the 3rd byte is the value. In a case in which two or more messages consecutive messages have the same status, MIDI has a provision called "running status" which allows the status byte of the second and following messages to be omitted. Thus, the above messages have the following meaning.

B3	64 00	MIDI ch.4, lower byte of RPN parameter number:	00H
(B3)	65 00	(MIDI ch.4) upper byte of RPN parameter number:	00H
(B3)	06 0C	(MIDI ch.4) upper byte of parameter value:	0CH
(B3)	26 00	(MIDI ch.4) lower byte of parameter value:	00H
(B3)	64 7F	(MIDI ch.4) lower byte of RPN parameter number:	7FH
(B3)	65 7F	(MIDI ch.4) upper byte of RPN parameter number:	7FH

In other words, the above messages specify a value of 0C 00H for RPN parameter number 00 00H on MIDI channel 4, and then set the RPN parameter number to 7F 7FH.

RPN parameter number 00 00H is Pitch Bend Sensitivity, and the MSB of the value indicates semitone units, so a value of 0CH = 12 sets the maximum pitch bend range to +/-12 semitones (1 octave). (On GS sound generators the LSB of Pitch Bend Sensitivity is ignored, but the LSB should be transmitted anyway (with a value of 0) so that operation will be correct on any device.)

Once the parameter number has been specified for RPN or NRPN, all Data Entry messages transmitted on that same channel will be valid, so after the desired value has been transmitted, it is a good idea to set the parameter number to 7F 7FH to prevent accidents. This is the reason for the (B3) 64 7F (B3) 65 7F at the end.

It is not desirable for performance data (such as Standard MIDI File data) to contain many events with running status as given in <Example 4>. This is because if playback is halted during the song and then rewound or fast-forwarded, the sequencer may not be able to transmit the correct status, and the sound generator will then misinterpret the data. Take care to give each event its own status.

It is also necessary that the RPN or NRPN parameter number setting and the value setting be done in the proper order. On some sequencers, events occurring in the same (or consecutive) clock may be transmitted in an order different than the order in which they were received. For this reason it is a good idea to slightly skew the time of each event (about 1 tick for TPQN = 96, and about 5 ticks for TPQN = 480).

\* TPQN: Ticks Per Quarter Note

## ■ Example of an Exclusive Message and Calculating a Checksum

Roland Exclusive messages (RQ1, DT1) are transmitted with a checksum at the end (before F7) to make sure that the message was correctly received. The value of the checksum is determined by the address and data (or size) of the transmitted Exclusive message.

### ● How to calculate the checksum

(hexadecimal numbers are indicated by "H")

The checksum is a value derived by adding the address, size, and checksum itself and inverting the lower 7 bits.

Here's an example of how the checksum is calculated. We will assume that in the Exclusive message we are transmitting, the address is aabbccddH and the data or size is eefffH.

$$\begin{aligned} aa + bb + cc + dd + ee + ff &= \text{sum} \\ \text{sum} \div 128 &= \text{quotient} \dots \text{remainder} \\ 128 - \text{remainder} &= \text{checksum} \end{aligned}$$

### <Example> Setting CHORUS TYPE of PERFORMANCE COMMON to DELAY (DT1)

According to the **Parameter Address Map** (p. 226), the start address of Temporary Performance is 10 00 00 00H, the offset address of CHORUS at PERFORMANCE COMMON is 04 00H, and the address of CHORUS TYPE is 00 00H. Therefore the address of CHORUS TYPE of PERFORMANCE COMMON is;

$$\begin{array}{r} 10\ 00\ 00\ 00\text{H} \\ \quad 04\ 00\text{H} \\ +) \quad 00\ 00\text{H} \\ \hline 10\ 00\ 04\ 00\text{H} \end{array}$$

DELAY has the value of 02H.

So the system exclusive message should be sent is;

F0	41	10	00	00	25	12	10	00	04	00	02	??	F7
(1)	(2)	(3)	(4)	(5)	address		data		checksum		(6)		

(1) Exclusive Status                      (2) ID (Roland)                              (3) Device ID (17)  
 (4) Model ID (JUNO-STAGE)      (5) Command ID (DT1)                      (6) End of Exclusive

Then calculate the checksum.

$$\begin{aligned} 10\text{H} + 00\text{H} + 04\text{H} + 00\text{H} + 02\text{H} &= 16 + 0 + 4 + 0 + 2 = 22 \text{ (sum)} \\ 22 \text{ (sum)} \div 128 &= 0 \text{ (quotient)} \dots 22 \text{ (remainder)} \\ \text{checksum} = 128 - 22 \text{ (remainder)} &= 106 = 6\text{AH} \end{aligned}$$

This means that F0 41 10 00 00 25 12 10 00 04 00 02 6A F7 is the message should be sent.

## ■ The Scale Tune Feature (address: 40 1x 40)

The scale tune feature allows you to finely adjust the individual pitch of the notes from C through B. Though the settings are made while working with one octave, the fine adjustments will affect all octaves. By making the appropriate Scale Tune settings, you can obtain a complete variety of tuning methods other than equal temperament. As examples, three possible types of scale setting are explained below.

\* The scale tune value received by the part 1 is used in Patch mode and Piano mode.

### ○ Equal Temperament

This method of tuning divides the octave into 12 equal parts. It is currently the most widely used form of tuning, especially in occidental music. On the JUNO-STAGE, the default settings for the Scale Tune feature produce equal temperament.

### ○ Just Temperament (Tonic of C)

The principal triads resound much more beautifully than with equal temperament, but this benefit can only be obtained in one key. If transposed, the chords tend to become ambiguous. The example given involves settings for a key in which C is the keytone.

### ○ Arabian Scale

By altering the setting for Scale Tune, you can obtain a variety of other tunings suited for ethnic music. For example, the settings introduced below will set the unit to use the Arabian Scale.

#### Example Settings

Note name	Equal Temperament	Just Temperament (Key-tone C)	Arabian Scale
C	0	0	-6
C#	0	-8	+45
D	0	+4	-2
Eb	0	+16	-12
E	0	-14	-51
F	0	-2	-8
F#	0	-10	+43
G	0	+2	-4
G#	0	+14	+47
A	0	-16	0
Bb	0	+14	-10
B	0	-12	-49

The values in the table are given in cents. Convert these values to hexadecimal, and transmit them as Exclusive data.

For example, to set the tune (C-B) of the Part 1 Arabian Scale, send the following data:

F0 41 10 42 12 40 11 40 3A 6D 3E 34 0D 38 6B 3C 6F 40 36 0F 76 F7

## ■ ASCII Code Table

Patch Name and Performance Name, etc., of MIDI data are described the ASCII code in the table below.

D	H	Char	D	H	Char	D	H	Char
32	20H	SP	64	40H	@	96	60H	`
33	21H	!	65	41H	A	97	61H	a
34	22H	"	66	42H	B	98	62H	b
35	23H	#	67	43H	C	99	63H	c
36	24H	\$	68	44H	D	100	64H	d
37	25H	%	69	45H	E	101	65H	e
38	26H	&	70	46H	F	102	66H	f
39	27H	`	71	47H	G	103	67H	g
40	28H	(	72	48H	H	104	68H	h
41	29H	)	73	49H	I	105	69H	i
42	2AH	*	74	4AH	J	106	6AH	j
43	2BH	+	75	4BH	K	107	6BH	k
44	2CH	,	76	4CH	L	108	6CH	l
45	2DH	-	77	4DH	M	109	6DH	m
46	2EH	.	78	4EH	N	110	6EH	n
47	2FH	/	79	4FH	O	111	6FH	o
48	30H	0	80	50H	P	112	70H	p
49	31H	1	81	51H	Q	113	71H	q
50	32H	2	82	52H	R	114	72H	r
51	33H	3	83	53H	S	115	73H	s
52	34H	4	84	54H	T	116	74H	t
53	35H	5	85	55H	U	117	75H	u
54	36H	6	86	56H	V	118	76H	v
55	37H	7	87	57H	W	119	77H	w
56	38H	8	88	58H	X	120	78H	x
57	39H	9	89	59H	Y	121	79H	y
58	3AH	:	90	5AH	Z	122	7AH	z
59	3BH	;	91	5BH	[	123	7BH	{
60	3CH	<	92	5CH	\	124	7CH	
61	3DH	=	93	5DH	]	125	7DH	}
62	3EH	>	94	5EH	^			
63	3FH	?	95	5FH	_			

D: decimal

H: hexadecimal

\* "SP" is space.

## Bank Select and Program Change Correspondence Chart

### Patch

Group	Number	Bank Select		Program Number	
		MSB	LSB		
USER	001-128	87	0	1-128	
	129-256	87	1	1-128	
PR-A	001-128	87	64	1-128	
PR-B	001-128	87	65	1-128	
PR-C	001-128	87	66	1-128	
PR-D	001-128	87	67	1-128	
PR-E	001-128	87	68	1-128	
PR-F	001-128	87	69	1-128	
PR-G	001-128	87	70	1-128	
PR-H	001-128	87	71	1-128	
PR-I	001-003	87	72	1-3	
GM(2)	001-256	121	0-	1-128	
EXP (SRX-01)	001-	93	0	1-	
	(SRX-02)	001-	93	1	1-
	:	:	:	:	

\* The EXP group vary depending on the Wave Expansion Board you've installed. For information about an SRX series board, refer to the Owner's Manual that came with it.

### Rhythm Set

Group	Number	Bank Select		Program Number	
		MSB	LSB		
USER	001-032	86	0	1-32	
PRST	001-032	86	64	1-36	
GM(2)	001-009	120	---	1-57	
EXP (SRX-01)	001-	92	0	1-	
	(SRX-02)	001-	92	1	1-
	:	:	:	:	

\* The EXP group vary depending on the Wave Expansion Board you've installed. For information about an SRX series board, refer to the Owner's Manual that came with it.

### Performance

Group	Number	Bank Select		Program Number
		MSB	LSB	
USER	01-64	85	0	1-64
PRST	01-64	85	64	1-64

\* To switch multitimbres, the external MIDI device's transmit channel needs to be matched up with the Performance Control Channel (SYSTEM/MIDI/GENERAL) of the JUNO-STAGE.





# Specifications

## JUNO-STAGE: Synthesizer Keyboard (Conforms to General MIDI 2 System)

### ● Keyboard

76 keys (with velocity)

## ■ Sound Generator Section

### ● Maximum Polyphony

128 voices

### ● Parts

16 parts

### ● Wave Memory

128 M bytes (16-bit linear equivalent)

### ● Preset Memory

Patches: 1027 + 256 (GM2)  
Rhythm Sets: 32 + 9 (GM2)  
Performances: 64

### ● User Memory

Patches: 256  
Rhythm Sets: 32  
Performances: 64

### ● Effects

Multi-Effects: 3 systems, 79 types  
Chorus: 3 types  
Reverb: 5 types  
Mic Input Reverb: 8 types

## ■ Song Player

File Format  
Standard MIDI File: format-0/1  
Audio File: WAV, AIFF, MP3

## ■ Others

### ● Arpeggiator

Preset: 128  
User: 128

### ● Rhythm Pattern

Preset: 256 (26 groups)  
User: 256 (32 groups)

### ● Chord Memory

Preset: 64  
User: 64

### ● Controllers

D Beam Controller  
Pitch Bend/Modulation Lever  
S1/S2 Switch  
Sound Modify Knob x 7

### ● Display

240 x 64 dots graphic LCD (with backlit)

### ● Expansion Slots

SRX expansion board: 2 slot

### ● External Storage Device

USB MEMORY (supports USB 2.0 Hi-Speed Flash Memory)

### ● Connectors

Headphones Jack  
Song/Click Out Jack  
Output Jacks (L (MONO), R): 1/4 inch phone type  
Mic Input Jack: 1/4 inch phone type or XLR type (phantom power)  
MIDI Connectors (IN, OUT)  
Hold Pedal Jack  
Control Pedal Jack  
Patch Select Jack  
USB Connector (MIDI)

### ● Power Supply

DC 9 V (AC Adaptor)

### ● Current draw

2000 mA

### ● Dimensions

1251 (W) x 344 (D) x 112 (H) mm  
49-1/4 (W) x 13-9/16 (D) x 4-7/16 (H) inches

### ● Weight

9.8 kg / 21 lbs 10 oz (excluding AC Adaptor)

### ● Accessories

Owner's Manual  
CD-ROM x 2 (Editor/Librarian/USB MIDI driver, SONAR LE)  
Music Player Pad  
Music Player Cable  
USB Memory Protector  
AC Adaptor

\* In the interest of product improvement, the specifications and/or appearance of this unit are subject to change without prior notice.

# Index

## Numerics

2 BAND CHORUS .....	174
2 BAND FLANGER .....	175
2 BAND STEP FLANGER .....	175
2VOICE PITCH SHIFTER .....	185
3D CHORUS .....	173
3D DELAY .....	182
3D FLANGER .....	174
3D STEP FLANGER .....	174
3TAP PAN DELAY .....	180
4TAP PAN DELAY .....	180

## A

AC Adaptor .....	19
Accent	
Arpeggio .....	61
Rhythm Pattern .....	75
[ACTIVE EXPRESS] .....	57
A-Env Level 1–3 .....	109, 130
A-Env T1 V-Sens .....	109, 130
A-Env T4 V-Sens .....	109, 130
A-Env Time 1–4 .....	109, 130
A-Env Time KF .....	109
Alter Pan Depth .....	109
Alternate Pan Depth .....	130
Analog Feel .....	98
Arabic Scale .....	53, 143
[ARPEGGIO] .....	60
Arpeggio .....	60
Hold .....	60
Motif .....	62
Tempo .....	60
Arpeggio Style	
Arpeggio .....	62
Initializing .....	62
Saving .....	63
ARPEGGIO STYLE EDIT screen .....	62
ARPEGGIO STYLE screen .....	61
Arpeggio Styles .....	61
Asgn .....	141
Assign	
S1/S2 .....	136, 149
Assign Type .....	124
[ASSIGNABLE] .....	57
ASSIGNABLE Switch .....	148
Assigning a Name .....	44
Attack .....	142
Attack time .....	58
Attack Time Offset .....	100
Audio files .....	69
Audio Level .....	151
Auditioning a Patch [PREVIEW] .....	47

Auditioning the Sounds .....	30
AUTO PAN .....	170
AUTO WAH .....	167

## B

Bank Sel (LSB) .....	137
Bank Sel (MSB) .....	137
Bend .....	141
Bend Mode .....	146
Bias .....	108
Bias Direction .....	108
Bias Level .....	108
Bias Position .....	108
Booster .....	100
Booster 1&2, 3&4 .....	100
BS .....	138
Button .....	89

## C

[C. CANCEL/MINUS ONE] .....	73
CA .....	138
Category Group Buttons .....	28
category lock .....	45
Center cancel .....	73
Ch .....	142
Chain Play .....	72
Chord Form	
Creating .....	65
Chord Forms .....	64
Saving .....	65
[CHORD MEMORY] .....	64
CHORD MEMORY EDIT screen .....	65
Chord Memory Function .....	64
CHORUS .....	86, 171
Chorus .....	141
Chorus Level .....	81, 83
Chorus Output Select .....	81, 83
Chorus Parameters .....	190
Chorus Send Level .....	152
Chorus Source .....	83
Chorus Type .....	80, 83, 86
Click Level .....	151
Click Sound .....	151
Coarse .....	141
Coarse Tune .....	141
Compare function .....	96, 122
COMPRESSOR .....	177
Computer .....	92
Condenser Mic .....	87

## Connecting

External Equipment .....	20
Mic .....	87
Pedals .....	21
Portable Audio Device .....	21
Continuous Hold Pedal .....	147
CONTROL	
Patch .....	101
Rhythm Set .....	124
Control Change .....	89
Control Pedal .....	21, 59
Control Pedal Assign .....	147
CONTROL PEDAL jack .....	59
Control Pedal Polarity .....	147
CONTROL SW (PERF) Screen .....	137
Control Switch .....	102
Controller .....	38
Cord hook .....	19
Ctrl .....	137
CTRL 1–4 .....	110–111
CTRL 1–4 Source .....	110
CTRL SETTING (PERF) Screen .....	135
Current part .....	50
Cursor .....	43
Cursor buttons .....	43
Curve .....	142
Cutoff .....	142, 152
Cutoff Frequency .....	106, 128
Cutoff Keyfollow .....	106
[CUTOFF] knob .....	36, 58
Cutoff Offset .....	100
Cutoff V-Curve .....	107, 128
Cutoff V-Sens .....	107, 128

## D

D BEAM .....	137
V-LINK SETUP .....	67
D Beam Controller .....	56
D Beam Sens .....	152
Decay .....	142
Decay time .....	58
Delay .....	142, 178
Delay Time .....	113
Delay Time KF .....	113
Demo Song .....	24, 156
Depth .....	142
Destination .....	85
Destination 1–4 .....	110
Device ID .....	150
Display Contrast [LCD CONTRAST] Knob .....	22
DISTORTION .....	176
Double-bending .....	55

- [DUAL] ..... 32, 51  
 Dual ..... 32, 51  
 Duration  
   Arpeggio ..... 61  
   Rhythm Pattern ..... 75
- E**  
 [EDIT] ..... 94, 120  
 EDIT screen ..... 121  
 Editor ..... 93  
 EFFECT ..... 118  
 Effect  
   Piano mode ..... 27  
 EFFECT ROUTING  
   Patch mode ..... 80  
   Performance mode ..... 82  
 Effect Switch ..... 79  
 Effects ..... 79  
   On/Off ..... 79  
 Effects List ..... 163  
 End Step  
   Arpeggio Style ..... 62  
   Rhythm Pattern ..... 76  
 ENHANCER ..... 166  
 Envelope ..... 39  
 ENVELOPE [ATTACK] knob ..... 35, 58  
 ENVELOPE [RELEASE] knob ..... 35, 58  
 Equal Temperament ..... 53, 143  
 EQUALIZER ..... 59, 165  
 Error Messages ..... 162  
 Ex ..... 138  
 EXT INPUT jack ..... 73
- F**  
 Factory Reset ..... 155  
 Fade Mode ..... 114  
 Fade Time ..... 114  
 FAVORITE ..... 30, 47  
 [FAVORITE UP/ASSIGNABLE] ..... 48  
 F-Env Depth ..... 107, 129  
 F-Env Level 0–4 ..... 107, 129  
 F-Env T1 V-Sens ..... 107, 129  
 F-Env T4 V-Sens ..... 107, 129  
 F-Env Time 1–4 ..... 107, 129  
 F-Env Time KF ..... 107  
 F-Env V-Curve ..... 107, 129  
 F-Env V-Sens ..... 107, 129  
 Filter Type ..... 106, 128, 152  
 Fine ..... 141  
 FLANGER ..... 172  
 Function Buttons ..... 43  
 FXM ..... 103, 125  
 FXM Color ..... 103, 125
- FXM Depth ..... 103, 125  
 FXM Switch ..... 103, 125
- G**  
 GATE ..... 177  
 GATED REVERB ..... 186  
 GENERAL ..... 98  
   Rhythm Set ..... 124  
 GM ..... 88  
 GM (GM2)  
   Patch ..... 45, 94  
 GM2 ..... 88  
 Grid  
   Arpeggio ..... 61  
   Rhythm Pattern ..... 75  
 Group ..... 140  
 GUITAR AMP SIMULATOR ..... 176
- H**  
 Hd ..... 138  
 HEXA-CHORUS ..... 172  
 [HIGH] knob ..... 36  
 Hold ..... 137  
 Hold pedal ..... 21, 60  
 Hold Pedal Polarity ..... 147  
 HUMANIZER ..... 167
- I**  
 [INC] and [DEC] ..... 43  
 INFINITE PHASER ..... 169  
 Initializing  
   Arpeggio Style ..... 62  
   Patch ..... 96  
   Performance ..... 132  
   Rhythm Pattern ..... 76  
   Rhythm Set ..... 122  
   USB Memory ..... 155  
 Input Velocity  
   Arpeggio Style ..... 62  
   Rhythm Pattern ..... 76  
 ISOLATOR ..... 165
- J**  
 JUNO-STAGE Editor CD ..... 93  
 Just intonation ..... 53  
 Just Intonation (Tonic of C) ..... 143
- K**  
 K.L ..... 142  
 K.U ..... 142  
 Kbd ..... 140, 142  
 Kbd Patch Rx/Tx Channel ..... 90, 150  
 Key Fade Lower ..... 102  
 Key Fade Upper ..... 102
- KEY RANGE ..... 102  
 Key Range ..... 134  
 Key Range Lower ..... 102  
 Key Range Upper ..... 102  
 Key Touch Select ..... 117  
 Key Trigger ..... 114  
 Keyboard Switch ..... 134  
 Keyboard Touch ..... 54  
 Keyboard Velocity ..... 54, 147  
 Keyboard Velocity Curve ..... 54, 147  
 Keyboard Velocity Sens ..... 54, 147  
 Knob ..... 89
- L**  
 [LCD CONTRAST] Knob ..... 22  
 Legato ..... 143  
 Legato Retrigger ..... 101  
 Legato Switch ..... 101  
 Level ..... 137, 140, 152  
 LEVEL [fig.arrowdown.eps] [fig.arrowup.eps]  
 69  
 Level Adjust ..... 71  
 Level V-Curve ..... 108, 130  
 Level V-Sens ..... 108, 130  
 LFO ..... 39  
 LFO 1–2 ..... 113  
 LFO Osc 1 Pitch Depth ..... 152  
 LFO Osc 1 Pulse Width Depth ..... 152  
 LFO Osc 2 Pitch Depth ..... 152  
 LFO Osc 2 Pulse Width Depth ..... 152  
 LFO Rate ..... 152  
 Librarian ..... 93  
 Lid State ..... 26, 117  
 LIMITER ..... 177  
 Local Sw ..... 89  
 Local Switch ..... 150  
 [LOCK] ..... 59  
 Lock function ..... 59  
 LOFI COMPRESS ..... 184  
 LOFI NOISE ..... 183  
 LOFI RADIO ..... 184  
 LONG DELAY ..... 178  
 LONG TIME CTRL DELAY ..... 182  
 Loop ..... 97, 123  
 LOW BOOST ..... 165  
 Low Frequency Oscillator ..... 39  
 Lower ..... 51  
 LSB ..... 89

## M

- MASTER EQ [HIGH] knob ..... 59
  - MASTER EQ [LOW] knob ..... 59
  - Master Key Shift ..... 146
  - Master Keyboard ..... 89
  - Master Level ..... 146
  - Master Tune ..... 146
  - Matrix Control ..... 110
  - MATRIX CTRL1–4 ..... 110
  - Md ..... 138
  - Memory ..... 41
  - MFX 1–3 ..... 84
  - MFX 1–3 CTRL ..... 84
  - MFX Chorus Send Level ..... 80, 82
  - MFX Control Channel ..... 85
  - MFX Output Level ..... 80, 82
  - MFX Reverb Send Level ..... 80, 82
  - MFX Source ..... 82
  - MFX STRUCTURE ..... 86
  - MFX Structure ..... 82, 86
  - MFX Type ..... 80, 82, 84
  - MFX1–3 ..... 86, 141
  - Mic
    - Connecting ..... 87
    - Reverb ..... 87
    - Volume ..... 87
  - MIC INPUT jack ..... 154
  - MIC Input Setting ..... 154
  - Mic Mode ..... 154
  - Mic-In Reverb Level ..... 154
  - Mic-In Reverb Time ..... 154
  - Mic-In Reverb Type ..... 154
  - Microphone ..... 87
  - MIDI ..... 88
  - MIDI Ch ..... 89
  - MIDI Channels ..... 88
  - MIDI Connectors ..... 88
  - [MIDI CONTROLLER] ..... 89
  - MIDI Controller Mode ..... 89
  - MIDI CONTROLLER screen ..... 89
  - MIDI FILTER Screen ..... 138
  - Minus-One ..... 73, 154
  - Mod ..... 137
  - MODIFY ..... 100
  - Modulation ..... 33, 54
  - MODULATION DELAY ..... 179
  - Mono/Poly ..... 101, 143
  - Motif ..... 61
  - MSB ..... 89
  - MULTI STAGE PHASER ..... 168
  - MULTI TAP DELAY ..... 180
  - Multi-Effect ..... 84
  - Multi-Effect Control ..... 84
  - Multi-Effects Parameters ..... 163
  - Multitimbral Sound Generators ..... 88
  - Music Player Pad ..... 21
  - Mute ..... 139–140
  - Mute Group ..... 124
  - Muted ..... 154
- ## N
- Names ..... 44
  - Note Tx Channel A ..... 67
  - Note Tx Channel B ..... 67
  - Note Tx Channel C ..... 67
  - Number ..... 140
  - [NUMERIC] ..... 44, 46
- ## O
- Oct Range ..... 61
  - Octave ..... 141
  - OCTAVE [DOWN] [UP] ..... 33, 52
  - Octave Shift ..... 33, 52, 98, 141
  - Offset ..... 113
  - One Shot Mode ..... 124
  - One-shot ..... 97, 123
  - Osc 1 Coarse Tune ..... 152
  - Osc 1 Fine Tune ..... 152
  - Osc 1 Pulse Width ..... 152
  - Osc 1 Waveform ..... 152
  - Osc 2 Coarse Tune ..... 152
  - Osc 2 Fine Tune ..... 152
  - Osc 2 Level ..... 152
  - Osc 2 Pulse Width ..... 152
  - Osc 2 Waveform ..... 152
  - Osc Sync Switch ..... 152
  - OUTPUT
    - Patch ..... 115
    - Rhythm Set ..... 131
  - Output ..... 141
  - Output Gain ..... 146
  - OVERDRIVE ..... 176
- ## P
- P.B ..... 137
  - PA ..... 138
  - Pan ..... 137, 140
  - Pan Depth ..... 114
  - Pan Keyfollow ..... 108
  - Part ..... 38, 50, 61
  - Part 1–16 Level ..... 71
  - Part Chorus Send Level ..... 82
  - PART MIXER Screen ..... 139
  - Part Mute window ..... 139
  - Part Output Assign ..... 82
  - Part Output Level ..... 82
  - Part Output MFX Select ..... 82
  - Part Reverb Send Level ..... 82
  - Part Scale Tune for C–B ..... 143
  - Part Select ..... 82
  - PART SELECT Screen ..... 42
  - PART VIEW Screen ..... 140
  - [PATCH] ..... 45
  - Patch ..... 39
    - Copying ..... 96
    - Editing ..... 94
    - Initializing ..... 96
    - Saving ..... 97
  - Patch Category ..... 98
  - Patch Coarse Tune ..... 98
  - Patch Fine Tune ..... 98
  - Patch Level ..... 98
  - PATCH LIST screen ..... 29, 46
  - Patch Mode ..... 38, 45
  - Patch number ..... 46
  - Patch Out Assign ..... 115
  - Patch Output Assign ..... 80
  - Patch Pan ..... 98
  - Patch Parameters ..... 98
  - PATCH PLAY Screen ..... 42
  - PATCH PLAY screen ..... 45
  - Patch Priority ..... 98
  - Patch Remain ..... 146
  - Patch Scale Tune for C–B ..... 53, 146
  - Patch Select ..... 147
  - PATCH SELECT Pedal ..... 46, 48, 50
  - Patch select pedal ..... 21
  - Patch Select Polarity ..... 148
  - PB ..... 138
  - PC ..... 89, 138
  - Pedal Polarity ..... 147
  - P-Env Depth ..... 105, 126
  - P-Env Level 0–4 ..... 105, 126
  - P-Env T1 V-Sens ..... 104, 126
  - P-Env T4 V-Sens ..... 104, 126
  - P-Env Time 1–4 ..... 105, 126
  - P-Env Time KF ..... 104
  - P-Env V-Sens ..... 104, 126
  - [PERFORM] ..... 49
  - PERFORM PLAY Screen ..... 42, 49, 134
  - Performance ..... 133
    - Editing ..... 132
    - Initializing ..... 132
    - Saving ..... 133

- Performance Control Channel ..... 150  
 PERFORMANCE LIST screen ..... 49  
 Performance Mode ..... 38, 49  
 Performance number ..... 50  
 Phantom Power ..... 154  
 Phase ..... 142  
 PHASER ..... 168  
 PHONOGRAPH ..... 184  
 Phrase Loop ..... 103, 125  
 [PIANO MODE] ..... 25, 116  
 Piano Mode ..... 116, 119  
   Saving ..... 119  
 Piano mode ..... 25  
 PIANO PATCH LIST Screen ..... 117  
 Pitch bend ..... 33, 54  
 Pitch Bend Range Down ..... 101  
 Pitch Bend Range Up ..... 101  
 Pitch Bend/Modulation Lever ..... 33, 54  
 Pitch Depth ..... 114  
 Pitch Keyfollow ..... 104  
 PITCH SHIFTER ..... 185  
 Playback Mode ..... 72  
 Playing Monophonically ..... 55  
 Playlist ..... 68  
   Changing the Song Order ..... 72  
   Deleting a Song From ..... 72  
   Playing ..... 71  
 Playlist Editor ..... 68, 93  
 PLAYLIST INFORMATION Screen ..... 72  
 PLAYLIST SELECT Screen ..... 71  
 Pn ..... 138  
 Portable Audio Device ..... 73  
 Portament ..... 143  
 PORTAMENTO ..... 101  
 Portamento ..... 55  
 Portamento Mode ..... 101  
 Portamento Start ..... 101  
 Portamento Switch ..... 101  
 Portamento Time ..... 101  
 Portamento Type ..... 101  
 Power On/Off ..... 22  
 [POWER] switch ..... 22  
 Power Up Mode ..... 146  
 Preset Memory ..... 42  
 [PREVIEW] ..... 30  
 Preview 1–4 Note Number ..... 146  
 Preview 1–4 Velocity ..... 146  
 Preview Mode ..... 146  
 PRO EDIT ..... 95  
   Rhythm Set ..... 121  
 PRO EDIT screen ..... 95  
 Prog ..... 137  
 PRST (Preset)  
   Patch ..... 45, 94  
   Performance ..... 49, 132
- ## R
- Rand Pitch Depth ..... 104  
 Random Pan Depth ..... 109, 130  
 Range ..... 152  
 Range Max ..... 136, 153  
 Range Min ..... 136, 153  
 Rate ..... 113  
 Rate Detune ..... 113  
 RECEIVE ..... 124  
 Receive Bank Select ..... 90, 151  
 Receive Channel ..... 90  
 Receive Exclusive ..... 151  
 Receive GM System On ..... 151  
 Receive GM2 System On ..... 151  
 Receive GS Reset ..... 151  
 Receive Program Change ..... 90, 151  
 Receive Switch ..... 90  
 Recommended Tempo ..... 136  
 Redamper Sw ..... 112  
 Relative Level ..... 124  
 Releas ..... 142  
 Release time ..... 58  
 Release Time Offset ..... 100  
 Remote Keyboard Switch ..... 150  
 Repeat All ..... 72  
 Reso ..... 142  
 Resonance ..... 26, 106, 118, 128, 152  
 [RESONANCE] knob ..... 36, 58  
 Resonance Offset ..... 100  
 Resonance V-Sens ..... 107, 128  
 Returning to the Factory Settings ..... 155  
 REVERB ..... 86, 186  
 Reverb ..... 36, 59, 141  
   Mic ..... 87  
 [REVERB] knob ..... 36, 59  
 Reverb Level ..... 81, 83  
 Reverb Parameters ..... 191  
 Reverb Send Level ..... 152  
 Reverb Source ..... 83  
 Reverb Type ..... 81, 83, 86  
 REVERSE DELAY ..... 181  
 Rhythm Group ..... 74  
   Creating ..... 77  
   Saving ..... 78  
 RHYTHM GROUP EDIT screen ..... 77  
 RHYTHM GROUP screen ..... 74  
 Rhythm Key Select ..... 80  
 Rhythm Level ..... 124  
 Rhythm Out Assign ..... 131  
 Rhythm Output Assign ..... 80  
 [RHYTHM PATTERN] ..... 74  
 Rhythm Pattern ..... 74  
   Creating ..... 76  
   Initializing ..... 76  
   Saving ..... 77  
   Tempo ..... 74  
   Volume ..... 74  
 RHYTHM PATTERN EDIT screen ..... 76  
 RHYTHM PATTERN Screen ..... 75  
 Rhythm Set ..... 39, 123  
   Copying ..... 122  
   Editing ..... 120  
   Initializing ..... 122  
   Rhythm Patern ..... 74  
   Saving ..... 123  
 Rhythm Tone ..... 39  
   Copying ..... 122  
 Rhythm Tone Name ..... 124  
 RING MODULATOR ..... 169  
 Ring Modulator ..... 100  
 Rolled Chord ..... 64  
 Rolled Chord Type ..... 64  
 ROTARY ..... 171  
 Rotary Effect ..... 55  
 Rx ..... 138  
 Rx Bender ..... 112  
 Rx Expression ..... 112  
 Rx Hold-1 ..... 112  
 Rx Pan Mode ..... 112
- ## S
- S1 ..... 137  
 [S1] [S2] ..... 55  
 S2 ..... 137  
 Saving  
   Arpeggio Style ..... 63  
   Chord Form ..... 65  
   Patch ..... 97  
   Performances ..... 133  
   Piano Mode ..... 119  
   Playlist ..... 73  
   Rhythm Group ..... 78  
   Rhythm Pattern ..... 77  
   Rhythm Set ..... 123  
   System Settings ..... 145  
   User Data ..... 144  
 Scale Tune ..... 53  
 Scale Tune Switch ..... 53, 146  
 Scale Tuning ..... 53

- Screen saver ..... 146
  - Screen Saver Time ..... 146
  - SELECT [1]–[4] ..... 95
  - Sens ..... 85
  - Sens 1–4 ..... 111
  - SERIAL DELAY ..... 179
  - Set Parameters ..... 124
  - [SHIFT] ..... 43
  - SHUFFLE DELAY ..... 181
  - SLICER ..... 170
  - SMF ..... 69
  - SMF Level ..... 151
  - Soft Through ..... 150
  - Solo ..... 140
  - [SOLO SYNTH] ..... 57
  - Song ..... 69
    - Tempo ..... 70
  - SONG INFORMATION Screen ..... 70
  - SONG LEVEL EDIT Screen ..... 71
  - [SONG LIST] ..... 69
  - Song list ..... 68
  - SONG PLAYER ..... 68
  - Song Player ..... 38
    - Volume ..... 69
  - SONG SELECT Screen ..... 69–70
  - SONG/CLICK OUT jack ..... 78
  - Song/Click Output Level ..... 151
  - Song/Click Output Mode ..... 151
  - Sound Generator ..... 38
  - SOUND MODIFY ..... 35, 58
  - Source ..... 85
  - SPACE-D ..... 173
  - SPEAKER SIMULATOR ..... 167
  - SPECTRUM ..... 165
  - [SPLIT] ..... 31, 51
  - Split ..... 31, 51
  - Split Point ..... 32, 51
  - Step 1–16 ..... 115
  - STEP FILTER ..... 166
  - STEP FLANGER ..... 172
  - STEP LFO ..... 115
  - STEP PAN ..... 170
  - STEP PHASER ..... 168
  - STEP PITCH SHIFTER ..... 185
  - STEP RING MODULATOR ..... 169
  - Step Type ..... 115
  - Step-recording
    - Arpeggio ..... 62
    - Rhythm Pattern ..... 76
  - Stretch Tune Depth ..... 98
  - Stretched tuning ..... 98
  - Struct 1 & 2, 3 & 4 ..... 99
  - Structure ..... 99
  - SUPER FILTER ..... 166
  - Sustain level ..... 58
  - Switch 1–4 ..... 111
  - SYMPATHETIC RESONANCE ..... 189
  - Sync Mode ..... 91, 151
  - Sync Output ..... 91, 151
  - Synchronizing ..... 91
  - Sys Ctrl 1–4 Source ..... 148
  - System Control ..... 148
  - System Memory ..... 42
  - System Parameters ..... 146
  - System Settings ..... 145
    - Saving ..... 145
- ## T
- [TAP TEMPO] ..... 60, 74
  - TAPE ECHO ..... 183
  - TELEPHONE ..... 184
  - Tempo
    - Arpeggio ..... 60
    - Rhythm Pattern ..... 74
    - Song ..... 70
  - Tempo Override ..... 91, 151
  - Temporary Area ..... 42
  - The PIANO MODE Screen ..... 116
  - Time ..... 143
  - TIME CTRL DELAY ..... 182
  - Time Variant Amplifier ..... 39
  - Time Variant Filter ..... 39
  - Tone ..... 95
    - Copying ..... 96
  - Tone Chorus Send ..... 115, 131
  - Tone Chorus Send Level ..... 80
  - Tone Coarse Tune ..... 104, 126
  - Tone Delay Mode ..... 111
  - Tone Delay Time ..... 111
  - Tone Env Mode ..... 112, 124
  - Tone Fine Tune ..... 104, 126
  - Tone Level ..... 108, 130
  - Tone Mix Velo Control ..... 102
  - Tone Out Assign ..... 115, 131
  - Tone Out Level ..... 115, 131
  - Tone OUTPUT Assign ..... 80
  - Tone Output Level ..... 80
  - Tone Pan ..... 108, 130
  - Tone Pitch Bend Range ..... 124
  - Tone Random Pitch Depth ..... 126
  - Tone Receive Expression ..... 124
  - Tone Receive Hold-1 ..... 124
  - Tone Receive Pan Mode ..... 124
  - Tone Reverb Send ..... 115, 131
  - Tone Reverb Send Level ..... 80
  - Tone Select ..... 80
  - TONE SELECT [1]–[4] ..... 120–121
  - TONE SWITCH [1]–[4] ..... 95, 120–121
  - [TONE SWITCH/SELECT] ..... 95, 120–121
  - Tones ..... 39
  - Transmit Active Sensing ..... 150
  - Transmit Bank Select ..... 150
  - Transmit Channel ..... 89
  - Transmit Edit Data ..... 150
  - Transmit Program Change ..... 150
  - [TRANPOSE] ..... 34, 52
  - Transpose ..... 34, 52
  - TREMOLO ..... 169
  - TREMOLO CHORUS ..... 173
  - TVA ..... 39
    - Depth ..... 114
    - ENVELOPE
      - Patch ..... 109
      - Rhythm Set ..... 130
  - TVA PARAMETER
    - Patch ..... 108
    - Rhythm Set ..... 130
  - TVA/TVA Envelope
    - Patch ..... 108
    - Rhythm Set ..... 130
  - TVF ..... 39
    - Depth ..... 114
    - ENVELOPE
      - Patch ..... 107
      - Rhythm Set ..... 129
    - PARAMETER
      - Patch ..... 106
      - Rhythm Set ..... 128
    - TVF/TVF Envelope
      - Patch ..... 106
      - Rhythm Set ..... 128
  - Type ..... 136, 140, 148–149, 153
- ## U
- Upper ..... 51
  - USB Driver ..... 92–93, 146
  - USB Memory ..... 42
    - Initializing ..... 155
  - USB Memory Format ..... 155
  - USB Memory Protector ..... 22
  - USB MIDI ..... 150
  - USB MIDI connector ..... 92
  - USB-MIDI Thru ..... 150
  - USER ..... 94
    - Patch ..... 45
    - Performance ..... 49, 132

- User Backup ..... 144  
 User Data  
   Saving to USB Memory ..... 144  
 User Memory ..... 42  
 User Restore ..... 144  
 Utility ..... 155
- V**
- VALUE Dial ..... 43  
 Velo ..... 142  
 Velo Fade Lower ..... 102, 127  
 Velo Fade Upper ..... 102, 127  
 Velo Range Lower ..... 102, 127  
 Velo Range Upper ..... 102, 127  
 Velocity ..... 54  
   Arpeggio ..... 61  
   Rhythm Pattern ..... 75  
 Velocity Control ..... 127  
 VELOCITY RANGE ..... 102, 127  
 Velocity Sens Offset ..... 100  
 Vib Rate ..... 142  
 VK ROTARY ..... 171  
 [V-LINK] ..... 66  
 V-LINK SETUP ..... 67  
 Vo ..... 138  
 VOCODER ..... 189  
 Vocoder ..... 87  
 Voice ..... 142–143  
 Volume ..... 22  
   Mic ..... 87  
   Rhythm Pattern ..... 74  
   Song Player ..... 69  
   The entire JUNO-STAGE ..... 146  
 [VOLUME] knob ..... 22  
 VS DISTORTION ..... 176  
 VS OVERDRIVE ..... 176
- W**
- Wave Alter Pan Sw ..... 127  
 Wave Bank ..... 103, 125  
 Wave Coarse Tune ..... 127  
 Wave Expansion Board ..... 18, 29  
 Wave Fine Tune ..... 127  
 Wave Gain ..... 103, 125  
 Wave Generator ..... 39  
 Wave Group ..... 103, 125  
 Wave Level ..... 127  
 WAVE MIX LV/PN ..... 127  
 WAVE MIX TUNE ..... 127  
 Wave No. L (Mono) ..... 125  
 Wave No. L (Mono) Wave No. R ..... 103  
 Wave No. R ..... 125  
 Wave Pan ..... 127  
 WAVE PARAMETER  
   Patch ..... 103  
   Rhythm Set ..... 125  
 WAVE PITCH  
   Patch ..... 104  
   Rhythm Set ..... 126  
 WAVE PITCH ENV  
   Patch ..... 105  
   Rhythm Set ..... 126  
 Wave Rnd Pan Sw ..... 127  
 Wave Tempo Sync ..... 103, 125  
 Waveform ..... 97, 113, 123  
 WG ..... 39  
 Window ..... 43  
 [WRITE] ..... 119, 123, 133  
 WRITE  
   Arpeggio Style ..... 63  
   Chord Form ..... 65  
   Patch ..... 97  
   Piano Mode ..... 119  
   Playlist ..... 73  
   Rhythm Group ..... 78  
   Rhythm Pattern ..... 77  
   System Settings ..... 145
- X**
- XP-A, B  
   Patch ..... 45, 94
- Z**
- ZOOM EDIT  
   Patch ..... 94  
   Rhythm Set ..... 120  
 ZOOM EDIT screen ..... 95

For the U.K.

**IMPORTANT:** THE WIRES IN THIS MAINS LEAD ARE COLOURED IN ACCORDANCE WITH THE FOLLOWING CODE.

BLUE: NEUTRAL  
BROWN: LIVE

As the colours of the wires in the mains lead of this apparatus may not correspond with the coloured markings identifying the terminals in your plug, proceed as follows:

The wire which is coloured BLUE must be connected to the terminal which is marked with the letter N or coloured BLACK.  
The wire which is coloured BROWN must be connected to the terminal which is marked with the letter L or coloured RED.  
Under no circumstances must either of the above wires be connected to the earth terminal of a three pin plug.

For EU Countries



This product complies with the requirements of EMC Directive 2004/108/EC.

For the USA

## FEDERAL COMMUNICATIONS COMMISSION RADIO FREQUENCY INTERFERENCE STATEMENT

This equipment has been tested and found to comply with the limits for a Class B digital device, pursuant to Part 15 of the FCC Rules. These limits are designed to provide reasonable protection against harmful interference in a residential installation. This equipment generates, uses, and can radiate radio frequency energy and, if not installed and used in accordance with the instructions, may cause harmful interference to radio communications. However, there is no guarantee that interference will not occur in a particular installation. If this equipment does cause harmful interference to radio or television reception, which can be determined by turning the equipment off and on, the user is encouraged to try to correct the interference by one or more of the following measures:

- Reorient or relocate the receiving antenna.
- Increase the separation between the equipment and receiver.
- Connect the equipment into an outlet on a circuit different from that to which the receiver is connected.
- Consult the dealer or an experienced radio/TV technician for help.

This device complies with Part 15 of the FCC Rules. Operation is subject to the following two conditions:

- (1) this device may not cause harmful interference, and
- (2) this device must accept any interference received, including interference that may cause undesired operation.

Unauthorized changes or modification to this system can void the users authority to operate this equipment.  
This equipment requires shielded interface cables in order to meet FCC class B Limit.

For Canada

### NOTICE

This Class B digital apparatus meets all requirements of the Canadian Interference-Causing Equipment Regulations.

### AVIS

Cet appareil numérique de la classe B respecte toutes les exigences du Règlement sur le matériel brouilleur du Canada.

For the USA

## DECLARATION OF CONFORMITY Compliance Information Statement

Model Name : JUNO-STAGE  
Type of Equipment : Synthesizer  
Responsible Party : Roland Corporation U.S.  
Address : 5100 S.Eastern Avenue, Los Angeles, CA 90040-2938  
Telephone : (323) 890-3700



**For EU Countries**



- UK** This symbol indicates that in EU countries, this product must be collected separately from household waste, as defined in each region. Products bearing this symbol must not be discarded together with household waste.
- DE** Dieses Symbol bedeutet, dass dieses Produkt in EU-Ländern getrennt vom Hausmüll gesammelt werden muss gemäß den regionalen Bestimmungen. Mit diesem Symbol gekennzeichnete Produkte dürfen nicht zusammen mit dem Hausmüll entsorgt werden.
- FR** Ce symbole indique que dans les pays de l'Union européenne, ce produit doit être collecté séparément des ordures ménagères selon les directives en vigueur dans chacun de ces pays. Les produits portant ce symbole ne doivent pas être mis au rebut avec les ordures ménagères.
- IT** Questo simbolo indica che nei paesi della Comunità europea questo prodotto deve essere smaltito separatamente dai normali rifiuti domestici, secondo la legislazione in vigore in ciascun paese. I prodotti che riportano questo simbolo non devono essere smaltiti insieme ai rifiuti domestici. Ai sensi dell'art. 13 del D.Lgs. 25 luglio 2005 n. 151.
- ES** Este símbolo indica que en los países de la Unión Europea este producto debe recogerse aparte de los residuos domésticos, tal como esté regulado en cada zona. Los productos con este símbolo no se deben depositar con los residuos domésticos.
- PT** Este símbolo indica que nos países da UE, a recolha deste produto deverá ser feita separadamente do lixo doméstico, de acordo com os regulamentos de cada região. Os produtos que apresentem este símbolo não deverão ser eliminados juntamente com o lixo doméstico.
- NL** Dit symbool geeft aan dat in landen van de EU dit product gescheiden van huishoudelijk afval moet worden aangeboden, zoals bepaald per gemeente of regio. Producten die van dit symbool zijn voorzien, mogen niet samen met huishoudelijk afval worden verwijderd.
- DK** Dette symbol angiver, at i EU-lande skal dette produkt opsamles adskilt fra husholdningsaffald, som defineret i hver enkelt region. Produkter med dette symbol må ikke smides ud sammen med husholdningsaffald.
- NO** Dette symbolet indikerer at produktet må behandles som spesialavfall i EU-land, iht. til retningslinjer for den enkelte regionen, og ikke kastes sammen med vanlig husholdningsavfall. Produkter som er merket med dette symbolet, må ikke kastes sammen med vanlig husholdningsavfall.

- SE** Symbolen anger att i EU-länder måste den här produkten kasseras separat från hushållsavfall, i enlighet med varje regions bestämmelser. Produkter med den här symbolen får inte kasseras tillsammans med hushållsavfall.
- FI** Tämä merkintä ilmaisee, että tuote on EU-maissa kerättävä erillään kotitalousjätteistä kunkin alueen voimassa olevien määräysten mukaisesti. Tällä merkinnällä varustettuja tuotteita ei saa hävittää kotitalousjätteiden mukana.
- HU** Ez a szimbólum azt jelenti, hogy az Európai Unióban ezt a terméket a háztartási hulladéktól elkülönítve, az adott régióban érvényes szabályozás szerint kell gyűjteni. Az ezzel a szimbólummal ellátott termékeket nem szabad a háztartási hulladék közé dobni.
- PL** Symbol oznacza, że zgodnie z regulacjami w odpowiednim regionie, w krajach UE produktu nie należy wyrzucać z odpadami domowymi. Produktów opatrzonych tym symbolem nie można utylizować razem z odpadami domowymi.
- CZ** Tento symbol udává, že v zemích EU musí být tento výrobek sbírán odděleně od domácího odpadu, jak je určeno pro každý region. Výrobky nesoucí tento symbol se nesmí vyhazovat spolu s domácím odpadem.
- SK** Tento symbol vyjadruje, že v krajinách EÚ sa musí zber tohto produktu vykonávať oddelene od domového odpadu, podľa nariadení platných v konkrétnej krajine. Produkty s týmto symbolom sa nesmú vyhazovať spolu s domovým odpadom.
- EE** See sümbol näitab, et EL-i maades tuleb see toode olemprügist eraldi koguda, nii nagu on igas piirkonnas määratletud. Selle sümboliga märgitud tooteid ei tohi ära visata koos olmeprügiga.
- LT** Šis simbolis rodo, kad ES šalyse šis produktas turi būti surenkamas atskirai nuo buitinių atliekų, kaip nustatyta kiekviename regione. Šiuo simboliu paženklinėti produktai neturi būti išmetami kartu su buitiniems atliekomis.
- LV** Šis simbols norāda, ka ES valstīs šo produktu jāievāc atsevišķi no mājsaimniecības atkritumiem, kā noteikts katrā reģionā. Produktaus ar šo simbolu nedrīkst izmest kopā ar mājsaimniecības atkritumiem.
- SI** Ta simbol označuje, da je treba proizvod v državah EU zbirati ločeno od gospodinjskih odpadkov, tako kot je določeno v vsaki regiji. Proizvoda s tem znakom ni dovoljeno odlagati skupaj z gospodinjskimi odpadki.
- GR** Το σύμβολο αυτό υποδηλώνει ότι στις χώρες της Ε.Ε. το συγκεκριμένο προϊόν πρέπει να συλλέγεται χωριστά από τα υπόλοιπα οικιακά απορρίμματα, σύμφωνα με όσα προβλέπονται σε κάθε περιοχή. Τα προϊόντα που φέρουν το συγκεκριμένο σύμβολο δεν πρέπει να απορρίπτονται μαζί με τα οικιακά απορρίμματα.

**For China**

## 有关产品中所含有害物质的说明

本资料就本公司产品中所含的特定有害物质及其安全性予以说明。

本资料适用于 2007 年 3 月 1 日以后本公司所制造的产品。

### 环保使用期限



此标志适用于在中国国内销售的电子信息产品，表示环保使用期限的年数。所谓环保使用期限是指在自制造日起的规定期限内，产品中所含的有害物质不致引起环境污染，不会对人身、财产造成严重的不良影响。环保使用期限仅在遵照产品使用说明书，正确使用产品的条件下才有效。不当的使用，将会导致有害物质泄漏的危险。

### 产品中有毒有害物质或元素的名称及含量

部件名称	有毒有害物质或元素					
	铅(Pb)	汞(Hg)	镉(Cd)	六价铬(Cr(VI))	多溴联苯(PBB)	多溴二苯醚(PBDE)
外壳(壳体)	×	○	○	○	○	○
电子部件(印刷电路板等)	×	○	×	○	○	○
附件(电源线、交流适配器等)	×	○	○	○	○	○

○：表示该有毒有害物质在该部件所有均质材料中的含量均在 SJ/T11363-2006 标准规定的限量要求以下。  
 ×：表示该有毒有害物质至少在该部件的某一均质材料中的含量超出 SJ/T11363-2006 标准规定的限量要求。  
 因根据现有的技术水平，还没有什么物质能够代替它。





**Roland®**



\* 5 1 0 0 0 0 0 0 4 0 - 0 1 \*

510000040

1RCC