

**zoom**

# Thunderbolt™ Audio Converter **TAC-2R**

## Operation Manual

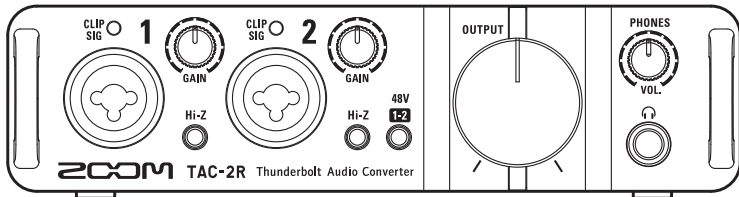

© 2014 ZOOM CORPORATION

Copying or reprinting this manual in part or in whole without permission is prohibited.

## Contents

Introduction .....	2	Playback .....	11
Usage and Safety Precautions .....	3	Connecting MIDI Devices .....	13
Part Names .....	4	Restoring Factory Default Settings .....	13
Installing the Driver .....	6	Troubleshooting .....	14
Connecting with a Computer .....	7	Specifications .....	15
Recording .....	8		

## Introduction

### 2-in/2-out Thunderbolt™ audio converter

The **TAC-2R** audio converter uses Thunderbolt™, the latest generation of high-speed interface technology. With this, we have realized a system with low latency that was not possible using USB 2.0. Since it also supports recording and playback at up to 24-bit/192kHz, it can also be used for the playback of high-resolution sound sources delivered with superior audio quality over the Internet.

### Attention to audio performance

The entire system reproduces the original audio faithfully. An asynchronous transfer system that is not impacted by computer jitter is used along with the latest AD/DA converter, which supports 192kHz.

### Built-in high-performance mic preamps

The high-performance mic preamps are based on those developed for our H Series. Each input also supports Hi-Z connections. The gain can be raised by up to 60 dB, and +48V phantom power can be supplied.



### TAC-2 MixEfx dedicated mixer application

Use this application to make internal mixer and monitoring effect settings. For details about **TAC-2 MixEfx**, see the ZOOM website (<http://www.zoom.co.jp/downloads/>).



# Usage and Safety Precautions

## SAFETY PRECAUTIONS

In this operation manual, symbols are used to highlight warnings and cautions that you must read to prevent accidents. The meanings of these symbols are as follows.

	Something that could cause serious injury or death
	Something that could cause injury or damage to the equipment

Other symbols used

	An action that is mandatory
	An action that is prohibited



## Warnings

### Alterations





-  Do not open the case or modify the product.

## Precautions



### Product handling

-  Do not drop, bump or apply excessive force to the unit.
-  Be careful not to allow foreign objects or liquids enter the unit.

### Operating environment

-  Do not use in extremely high or low temperatures.
-  Do not use near heaters, stoves and other heat sources.
-  Do not use in very high humidity or where it could be splashed by water.
-  Do not use in places with frequent vibrations.
-  Do not use in places with much dust or sand.

### Connection cables and input/output jacks

-  Always turn the power OFF for all equipment before connecting any cables.
-  Always disconnect all connection cables and the AC adapter before moving the unit.

### Volume

-  Do not use at a loud volume for a long time.

## Usage Precautions

### Interference with other electrical equipment

In consideration of safety, the **TAC-2R** has been designed to minimize its emission of electromagnetic waves and to suppress interference from external electromagnetic waves. However, equipment that is very susceptible to interference or that emits powerful electromagnetic waves could result in interference if placed nearby. If this occurs, place the **TAC-2R** and the other device farther apart. With any type of electronic device that uses digital control, including the **TAC-2R**, electromagnetic interference could cause malfunction, corrupt or destroy data and result in other unexpected trouble. Always use caution.

### Cleaning

Use a soft cloth to clean the exterior of the unit if it becomes dirty. If necessary, use a damp cloth that has been wrung out well. Never use abrasive cleansers, wax or solvents such as alcohol, benzene or paint thinner.

### Temperature considerations

Continuous use of this interface for long periods of time, for example, might cause it to become warm. This is normal as long as it does not become too hot to touch.

### Breakdown and malfunction

If the **TAC-2R** should malfunction or operate abnormally, disconnect it immediately. Then, contact the retailer where you purchased it or Zoom support and provide the following information: product model, serial number and details of the symptoms of malfunction or abnormal operation, as well as your name, address and telephone number.

### Copyrights

- Macintosh and Mac OS are trademarks or registered trademarks of Apple Inc.
- Thunderbolt and the Thunderbolt logo are trademarks of Intel Corporation in the U.S. and/or other countries.
- MIDI is a registered trademark of Association of Musical Electronics Industry (AMEI).
- All other product names, trademarks and company names in this document are the property of their respective owners.

Note: All trademarks and registered trademarks in this document are for identification purposes only and are not intended to infringe on the copyrights of their respective owners.

Recording for any purpose other than personal use from copyrighted sources, including CDs, records, tapes, live performances, video works and broadcasts, without permission of the copyright holder is prohibited by law. Zoom Corporation will not assume any responsibility related to infringements of copyrights.

# Part Names

## ■ Top Panel

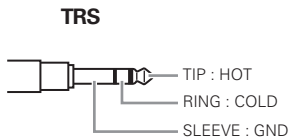
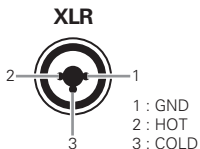
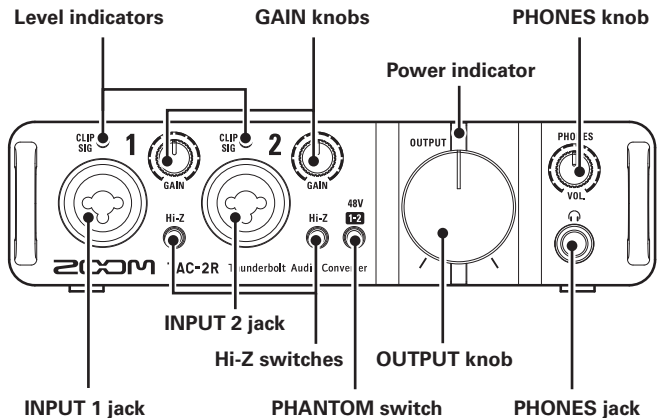

## ■ Rear Panel

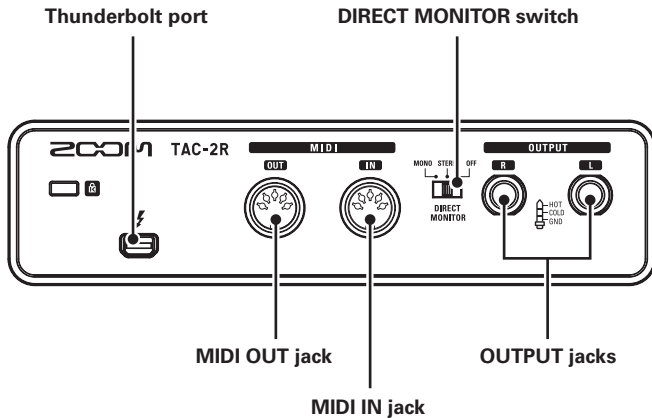

## Installing the Driver

Do not connect the **TAC-2R** until installation completes.

1. Download the ZOOM TAC-2 Driver from <http://www.zoom.co.jp/downloads/> to your computer.

### NOTE

- You can download the latest ZOOM TAC-2 Driver from the above website.
- The supported operating systems are as follows.  
Mac OS X 10.8.5 (or later)

2. Click the ZOOM TAC-2 Driver.pkg icon to launch the installer. Follow the instructions that appear on screen to install the ZOOM TAC-2 Driver.

3. Connect the **TAC-2R** and the computer using a Thunderbolt cable.

4. Open the Sound pane of the System Preferences and set both the Input and Output to ZOOM TAC-2R.

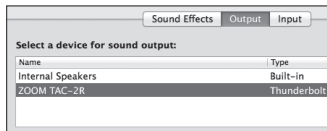

## Connecting with a Computer

1. Minimize both volume controls on the **TAC-2R**.
2. Connect the **TAC-2R** and the computer using a Thunderbolt cable.

The power indicator will light when connected correctly.

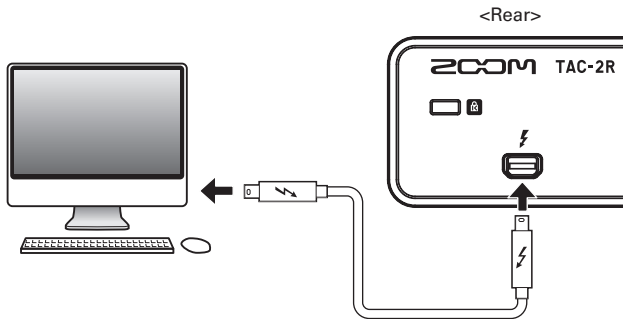

### NOTE

- The unit will not turn on if the driver is not installed.  
Follow the instruction on page 6 to install the ZOOM TAC-2 Driver.

## Connecting Instruments

Connect instruments to INPUTS 1/2 using TRS/mono phone cables.

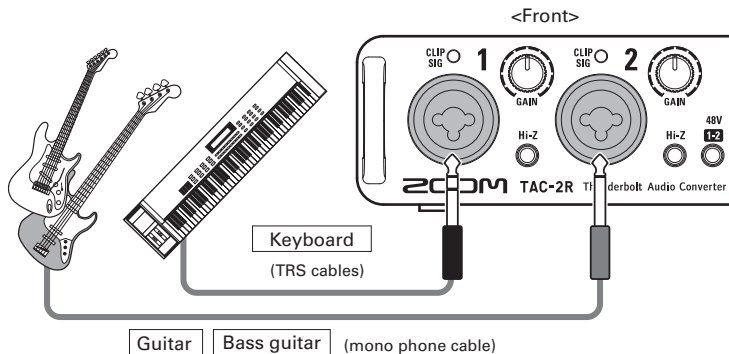

### Using the Hi-Z Function

- When connecting a passive guitar or bass guitar to an INPUT, press its **Hi-Z** so that it lights.
- When connecting a keyboard or other instrument to an INPUT, press its **Hi-Z** so that it becomes unlit.

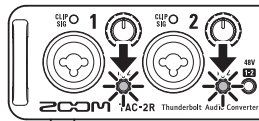



## Connecting Mics

Using XLR cables, connect mics to INPUTS 1/2.

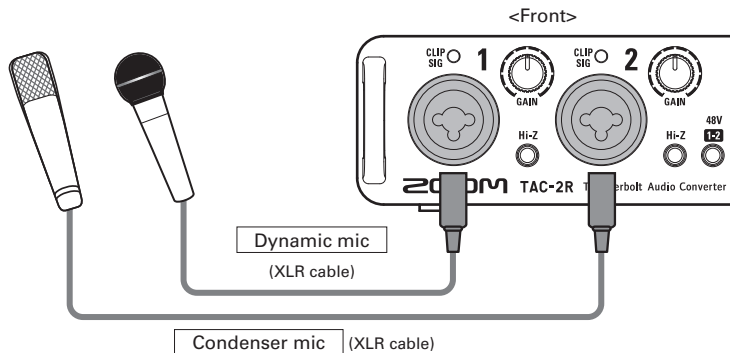

### Using Phantom Power

- When connecting a condenser mic, press  so that it lights. Phantom power is supplied when this switch is lit.
- When on, phantom power is supplied to both INPUTS 1/2.

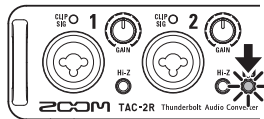

## Adjusting Input Gain

You can adjust the gain of each INPUT.

1. Check the status of the input signal.

Lit green: Input signal present.

Lit red: Input signal is clipping.

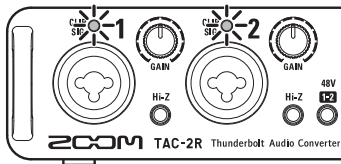

2. Adjust the input gain.

Turn the .

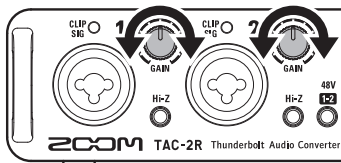

### HINT

- Set it so that the level indicator does not light red.

# Connecting Headphones and Speakers

Connect headphones to the PHONES jack and speakers to the OUTPUT jacks. Then, adjust the volume.

## 1. Connect headphones or speakers.

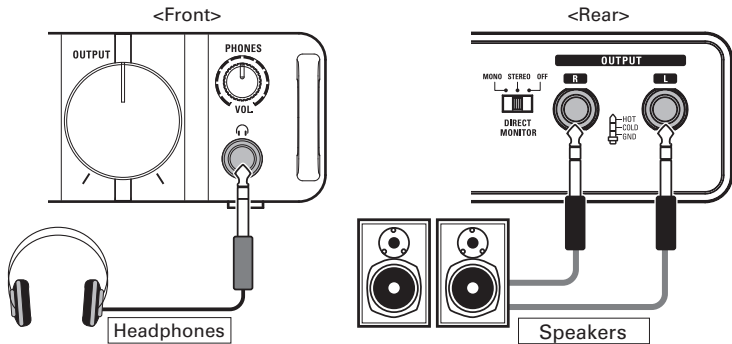

## 2. Adjust the headphones/speakers volume.

Headphones volume: Turn  .

Speakers volume: Turn  .

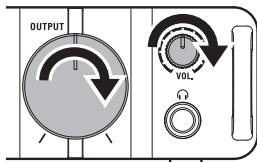

## Using Direct Monitoring

Sound inputs into the **TAC-2R** can be directly output without passing through the computer. This enables monitoring without latency.

1. Set the  .

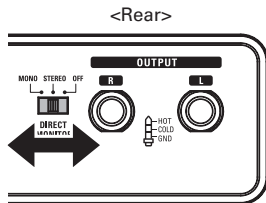

Direct monitoring setting	INPUT 1 jack	INPUT 2 jack
MONO	Output from the PHONES jack and both L/R OUTPUT jacks.	
STEREO	Output from the PHONES jack and the L OUTPUT jack.	Output from the PHONES jack and the R OUTPUT jack.
OFF	This disables direct monitoring.	

## Connecting MIDI Devices

Use MIDI cables to connect MIDI devices to the MIDI IN and MIDI OUT jacks.

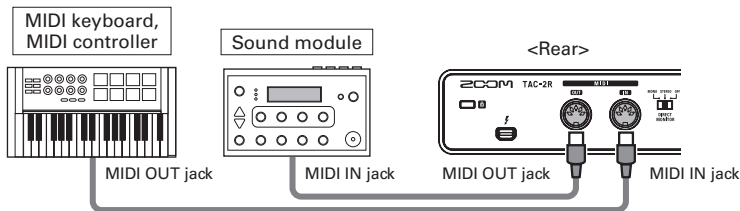

### NOTE

- When making settings in a DAW or other software, select "ZOOM TAC-2R MIDI I/O Port". Do not use "ZOOM TAC-2R Reserved Port". Doing so could cause the **TAC-2R** or **TAC-2 MixEfx** to stop functioning properly.

## Restoring Factory Default Settings

Follow these instructions to initialize settings, restoring them to their factory defaults.

- Connect the **TAC-2R** to a computer while pressing . (→P.7)

- Initialize the settings.

Execute: Press .

Cancel: Press .

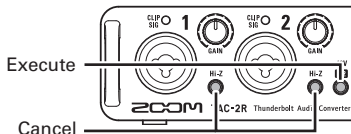

## Troubleshooting

### **Cannot select or use the TAC-2R device**

---

- Confirm that the **TAC-2R** is connected to the computer correctly.
- Quit all the software that is using the **TAC-2R** , and disconnect and reconnect the Thunderbolt cable connected to the **TAC-2R** .
- Reinstall the driver.

### **Playback sound cannot be heard or is quiet**

---

- Check the speaker connections and volume settings on the speakers.
- Adjust the OUTPUT and PHONES volume controls.
- Confirm that the Output of the Sound pane of the System Preferences is set to ZOOM TAC-2R.

### **Recorded audio is too loud, too quiet or silent**

---

- Adjust the input gain of the **TAC-2R** .
- When using a condenser mic, turn phantom power on.
- Confirm that the Input of the Sound pane of the System Preferences is set to ZOOM TAC-2R.

### **The sound of the device connected to the input jack is distorted**

---

- Confirm that the level indicators are not lighting red. If they are lighting, lower the input levels.

### **Sound skips during playback or recording**

---

- If you can adjust the audio buffer size of the software that you are using, increase the buffer size.

### **Cannot play or record**

---

- Confirm that ZOOM TAC-2R is selected in the Sound pane of the System Preferences.
- Confirm that **TAC-2R** is set for input and output in the software that you are using.
- Confirm that **TAC-2R** is connected to the computer correctly.
- Quit all the software that is using the **TAC-2R** , and disconnect and reconnect the Thunderbolt cable connected to the **TAC-2R** .

Specifications			
<b>Inputs</b>	INPUT 1/2	Connector	XLR/TRS combo jacks (XLR: 2 hot, TRS: TIP hot)
		Input gain	0–60 dB (in 1 dB steps)
		Input impedance	5 k $\Omega$ 1 M $\Omega$ (when Hi-Z ON)
		Maximum input level	+12 dBu (at 0 dBFS)
		Phantom power	+48V
<b>Outputs</b>	OUTPUT L/R	Connector	TRS jack (balanced)
		Maximum output level	+14 dBu (at 0 dBFS)
		Output impedance	100 $\Omega$
	PHONES	Connector	Standard stereo phone jack 20 mW $\times$ 2 (into 32 $\Omega$ load)
		Maximum output level	+8 dBu (at 0 dBFS)
		Output impedance	33 $\Omega$
<b>Frequency characteristics</b>		At 44.1 kHz	–1.0 dB: 20 Hz – 20 kHz
		At 96 kHz	–1.0 dB: 20 Hz – 40 kHz
		At 192 kHz	–1.0 dB: 20 Hz – 60 kHz
<b>Input conversion noise</b>		Measured EIN: –125 dBu (IHFA) (with 60dB, 150 $\Omega$ input)	
<b>Dynamic range</b>		AD: 118 dB typical (IHFA) DA: 120 dB typical (IHFA)	
<b>Number of audio recording and playback channels</b>		Recording: 2 channels Playback: 2 channels	
<b>Sampling frequencies</b>		192 kHz, 176.4 kHz, 96 kHz, 88.2 kHz, 48 kHz, 44.1 kHz	
<b>Bit depth</b>		24-bit	
<b>Interface</b>		Thunderbolt™	
<b>MIDI IN/OUT</b>		5 pin DIN jack	
<b>Power Source</b>		Thunderbolt™	
<b>Power consumption</b>		10 W maximum	
<b>Dimensions</b>		113.9 mm (D) $\times$ 176.0 mm (W) $\times$ 46.2 mm (H)	
<b>Weight (main unit only)</b>		714 g	

- 0 dBu = 0.775 Vrms

## FCC regulation warning (for U.S.A.)

This equipment has been tested and found to comply with the limits for a Class B digital device, pursuant to Part 15 of the FCC Rules. These limits are designed to provide reasonable protection against harmful interference in a residential installation. This equipment generates, uses, and can radiate radio frequency energy and, if not installed and used in accordance with the instructions, may cause harmful interference to radio communications. However, there is no guarantee that interference will not occur in a particular installation. If this equipment does cause harmful interference to radio or television reception, which can be determined by turning the equipment off and on, the user is encouraged to try to correct the interference by one or more of the following measures:

- Reorient or relocate the receiving antenna.
- Increase the separation between the equipment and receiver.
- Connect the equipment to an outlet on a circuit different from that to which the receiver is connected.
- Consult the dealer or an experienced radio/TV technician for help.

## For EU Countries



### Declaration of Conformity:

This product complies with the requirements of EMC Directive 2004/108/EC and RoHS Directive 2011/65/EU



### Disposal of Old Electrical & Electronic Equipment

(Applicable in European countries with separate collection systems)

This symbol on the product or on its packaging indicates that this product shall not be treated as household waste. Instead it shall be handed over to the applicable collection point for the recycling of electrical and electronic equipment. By ensuring this product is disposed of correctly, you will help prevent potential negative consequences for the environment and human health, which could otherwise be caused by inappropriate waste handling of this product. The recycling of materials will help to conserve natural resources. For more detailed information about recycling of this product, please contact your local city office, your household waste disposal service or the shop where you purchased the product.

# ZOOM®

## ZOOM CORPORATION

4-4-3 Kanda-Surugadai, Chiyoda-ku, Tokyo 101-0062 Japan

<http://www.zoom.co.jp>