

M3

MUSIC WORKSTATION/SAMPLER



EXB-RADIUS for M3 Owner's manual

MMT

KORG

About this manual

About the EXB-RADIAS for M3 operating manual

This EXB-RADIAS for M3 operating manual explains the RADIAS program functions and parameters that are available when the EXB-RADIAS synthesizer board is installed in the M3 music workstation/sampler.

For details about basic operation of the M3 and on the functions and parameters not related to the EXB-RADIAS, refer to the M3 operation guide and parameter guide.

Conventions in the operating manual

Abbreviations in the operating manual **OG, PG**

When indicating reference pages, the various operating manuals of the M3 may be abbreviated in the following ways.

M3 OG: M3 Operating Guide

M3 PG: M3 Parameter Guide

Parameters in the LCD display screen “ ”

Parameters displayed in the display are enclosed in double quotation marks “ ”.

Symbols , , *Note, Tips*

These symbols respectively indicate a caution, a MIDI-related explanation, a supplementary note, or a tip.

Example screen displays

The values of the parameters shown in the example screens of this manual are only for explanatory purposes, and may not necessary match the values that appear in the display of your instrument.

MIDI-related explanations

CC# is an abbreviation for Control Change Number.

In explanations of MIDI messages, numbers in square brackets [] always indicate hexadecimal numbers.

* Company names, product names, and names of formats etc. are the trademarks or registered trademarks of their respective owners.

Table of contents

| | |
|--|-----------|
| Introduction | 1 |
| Overview | 1 |
| Program structure | 1 |
| Synth programs | 1 |
| Vocoder program | 3 |
| Combination structure | 4 |
| Song structure (Sequencer mode) | 4 |
| Quick Start | 5 |
| Selecting and playing programs | 5 |
| Synth programs | 5 |
| Selecting and playing | 5 |
| Using controllers to vary the sound | 5 |
| Vocoder programs | 6 |
| Selecting and playing | 6 |
| Using controllers to vary the sound | 6 |
| Operation | 7 |
| Editing a program | 7 |
| Basic settings for the program..... | 7 |
| Voice Assign Mode | 7 |
| Oscillators..... | 7 |
| Selecting the waveform | 7 |
| Filter | 8 |
| Filter Routing | 8 |
| Filter A, Filter B (Filter settings) | 8 |
| Amp..... | 9 |
| Drive/Wave Shape | 9 |
| Amp Level | 9 |
| Pan | 9 |
| EG (Envelope Generator)..... | 10 |
| Envelope settings | 10 |
| EG Level/Time Modulation | 10 |
| LFO | 11 |
| LFO waveform | 11 |
| MIDI/Tempo Sync | 11 |
| Virtual Patch..... | 11 |
| Virtual Patch settings | 11 |
| Controlling volume | 11 |
| Controlling pan | 11 |
| Controlling filter | 11 |
| Modulation Sequencers | 12 |
| SEQ Common | 12 |
| Editing the steps | 12 |

| | |
|--|-----------|
| Editing a vocoder program..... | 13 |
| Vocoder on/off | 13 |
| Carrier Input | 13 |
| Modulator, Out Mix (modulator and vocoder output settings) | 13 |
| Filter settings | 13 |
| Formant Motion function | 14 |
| Creating your own program..... | 15 |
| Saving a program..... | 15 |
| Editing a combination (Combination mode) | 16 |
| Timbre settings | 16 |
| Editing a song (Sequencer mode) | 17 |
| MIDI track settings | 17 |
| Restoring the factory settings (Global mode) | 18 |
| Restoring the RADIUS program data to the factory-set state | 18 |
| Restoring the formant motion data to the factory-set state | 18 |
| | |
| Parameter guide | 19 |
| Program mode | 19 |
| Page Select | 19 |
| PROG P0: Play | 19 |
| 0-1: Main..... | 19 |
| 0-5: KARMA GE..... | 19 |
| 0-6: KARMA RTC..... | 19 |
| 0-7: Sampling/Audio In | 20 |
| 0-8: Control Surface..... | 20 |
| OSC Mix..... | 20 |
| 0-8c: RADIUS Play/Mute | 20 |
| 0-8d: RADIUS Volume | 21 |
| Tone Adjust..... | 21 |
| 0-8g: Tone Adjust | 21 |
| Common Tone Adjust Parameters | 22 |
| RADIUS Tone Adjust Parameters | 23 |
| Tone Adjust Default Settings | 24 |
| PROG P1: Basic/DT/Ctrls | 25 |
| 1-1: Program Basic..... | 25 |
| 1-1a: Voice Assign Mode | 25 |
| 1-1b: Scale | 25 |
| 1-1c: AudioIn (OSC&Vocoder) Source | 26 |
| 1-2: Virtual Patch | 28 |
| 1-2a: Virtual Patch | 28 |
| 1-3: DrumTrk Pattern (Drum Track Pattern) | 29 |
| 1-4: DrumTrk Program(Drum Track Program) | 29 |
| 1-5: X-Y Setup..... | 29 |
| 1-6: Controllers Setup | 29 |
| 1-7: Pads 1-4 Setup, 1-8: Pads 5-8 Setup..... | 29 |

| | |
|--|-----------|
| PROG P2: OSC/Pitch | 30 |
| 2-1: OSC Basic | 30 |
| 2-1a: OSC1 | 30 |
| 2-1b: OSC2 | 32 |
| 2-1c: Mixer | 33 |
| 2-2: OSC1 Pitch | 33 |
| 2-2a: Pitch | 33 |
| 2-2b: Portamento | 33 |
| PROG P3: Filter | 34 |
| 3-1: Filter | 34 |
| 3-1a: Filter Routing | 34 |
| 3-1b: Filter A | 34 |
| 3-1c: Filter B | 35 |
| PROG P4: Amp/EQ | 36 |
| 4-1: Amp/WaveShape/Driver | 36 |
| 4-1a: Driver/Wave Shape | 36 |
| 4-1b: Amp Level | 37 |
| 4-1c: Pan | 37 |
| 4-8: EQ | 37 |
| PROG P5: EG/LFO/MSEQ | 38 |
| 5-1: EG1 (Filter), 5-2: EG2 (Amp), 5-3: EG3 | 38 |
| 5-1(2)(3)a: Envelope | 38 |
| 5-1(2)(3)b: EG Level/Time Modulation | 38 |
| 5-4: LFO1, 5-5: LFO2 | 39 |
| 5-4(5)a: LFO 1, LFO2 | 39 |
| 5-4(5)b: Frequency MIDI/Tempo Sync. | 40 |
| 5-6: MSEQ1, 5-7: MSEQ2, 5-8: MSEQ3 | 40 |
| 5-6(7)(8)a: SEQ Common | 40 |
| 5-6(7)(8)b: SEQ1, SEQ2, SEQ3 | 41 |
| 5-6, 7, 8: Menu Command | 41 |
| PROG P6: Vocoder | 42 |
| 6-1: Carrier/Modulator | 42 |
| 6-1a: Vocoder On/Off, Formant Motion REC On/Off | 42 |
| 6-1b: Carrier Input | 42 |
| 6-1c: Modulator | 42 |
| 6-1d: Out Mix | 43 |
| 6-1: Menu Command | 43 |
| 6-2: Vocoder | 44 |
| 6-2a: Filter | 44 |
| 6-2b: Band1-16: Pan and Level | 44 |
| 6-2: Menu Command | 44 |
| PROG P7: KARMA | 45 |
| PROG P8: IFX | 45 |
| PROG P9: MFX/TFX | 45 |
| Menu Command | 45 |
| Initialize MOD SEQ | 45 |
| Copy MOD SEQ | 46 |
| Write Formant Motion Data | 46 |
| Copy Vocoder | 46 |

| | |
|--|-----------|
| Combination mode | 47 |
| Combi Page Select | 47 |
| COMBI P0: Play | 47 |
| 0-1: Program T01-08, 0-2: Program T09-16 | 47 |
| 0-3: Mixer T01-08, 0-4: Mixer T09-16 | 47 |
| 0-5: KARMA GE | 48 |
| 0-6: KARMA RTC | 48 |
| 0-7: Sampling/Audio In | 48 |
| 0-8: Control Surface | 48 |
| Tone Adjust | 49 |
| 0-8g: Tone Adjust | 49 |
| COMBI P1: DT/X-Y/Ctrls | 49 |
| COMBI P2: EQ / Option | 50 |
| 2-1: EQ Trim T01-08, 2-2: EQ Trim T09-16 | 50 |
| 2-3: EQ Gain T01-08, 2-4: EQ Gain T09-16 | 50 |
| 2-5: RADIUS T01-08, 2-6: RADIUS T09-16 | 50 |
| 2-5(6)c: Enable RADIUS (Total Max: 4 Timbres) | 50 |
| 2-5(6)d: Audio In (OSC&Vocoder) Source | 50 |
| 2-7: RADIUS Vocoder1 | 52 |
| 2-7a: Vocoder On/Off, Formant Motion REC On/Off | 52 |
| 2-7b: Carrier Input | 52 |
| 2-7c: Modulator | 52 |
| 2-7d: Out Mix | 52 |
| 2-7: Menu Command | 52 |
| 2-8: RADIUS Vocoder2 | 53 |
| 2-8a: Filter | 53 |
| 2-8b: Band1-16: Pan and Level | 53 |
| 2-8: Menu Command | 53 |
| COMBI P3: Timbre Parameters | 54 |
| 3-1: MIDI T01-08, 3-2: MIDI T09-16 | 54 |
| 3-3: OSC T01-08, 3-4: OSC T09-16 | 54 |
| 3-3c: OSC | 54 |
| 3-5: Pitch T01-08, 3-6: Pitch T09-16 | 54 |
| 3-5(6)a: Combination Name, Tempo, 3-5(6)b: Timbre Info | 54 |
| 3-5(6)c: Pitch | 54 |
| 3-7: Other T01-08, 3-8: Other T09-16 | 55 |
| 3-7(8)c: KARMA/Scale | 55 |
| COMBI P4: Zone/Delay | 55 |
| COMBI P5: MIDI Filter | 55 |
| COMBI P7: KARMA | 55 |
| COMBI P8: IFX (Insert Effects) | 55 |
| COMBI P9: MFX/TFX (Master/Total Effects) | 55 |
| Menu Command | 56 |
| Copy from Program | 56 |
| Write Formant Motion Data | 56 |
| Copy Vocoder | 56 |

| | |
|---|-----------|
| Sequencer mode | 57 |
| SEQ Page Select | 57 |
| SEQ P0: Play | 58 |
| SEQ P0-1: Play/REC | 58 |
| SEQ P0-2: Play/REC | 58 |
| 0-2-1: KARMA GE..... | 58 |
| 0-2-2: KARMA RTC..... | 58 |
| 0-2-8: Control Surface | 58 |
| Tone Adjust..... | 59 |
| 0-2-8f: Tone Adjust | 59 |
| SEQ P1: DT/X-Y/Ctrls | 59 |
| SEQ P2: EQ/Option | 60 |
| 2-1: EQ Trim T01-08, 2-2: EQ Trim T09-16 | 60 |
| 2-3: EQ Gain T01-08, 2-4: EQ Gain T09-16 | 60 |
| 2-5: RADIUS T01-08, 2-6: RADIUS T09-16 | 60 |
| 2-5(6)c: Enable RADIUS (Total Max: 4 Tracks) | 60 |
| 2-5(6)d: Audio In (OSC&Vocoder) Source | 60 |
| 2-7: RADIUS Vocoder1 | 60 |
| 2-7a: Vocoder On/Off, Formant Motion REC On/Off | 60 |
| 2-7b: Carrier Input | 60 |
| 2-7c: Modulator | 61 |
| 2-7d: Out Mix | 61 |
| 2-7: Menu Command | 61 |
| 2-8: RADIUS Vocoder2 | 61 |
| 2-8a: Filter | 61 |
| 2-8b: Band1-16: Pan and Level | 61 |
| 2-8: Menu Command | 61 |
| SEQ P3: Track Parameters | 62 |
| 3-1: MIDI T01-08, 3-2: MIDI T09-16 | 62 |
| 3-3: OSC T01-08, 3-4: OSC T09-16 | 62 |
| 3-3(4)a: OSC | 62 |
| 3-5: Pitch T01-08, 3-6: Pitch T09-16 | 62 |
| 3-5(6)a: Pitch | 62 |
| 3-7: Other T01-08, 3-8: Other T09-16 | 63 |
| 3-7(8)a: KARMA/Scale | 63 |
| SEQ P4: Zone/Delay | 63 |
| SEQ P5: MIDI Filter | 63 |
| SEQ P6: Track Edit | 63 |
| SEQ P7: KARMA | 63 |
| SEQ P8: IFX (Insert Effects) | 63 |
| SEQ P9: MFX/TFX (Master/Total Effects) | 63 |
| SEQ P10: Pattern/RPPR | 64 |
| SEQ P11: Cue List | 64 |

| | |
|--|-----------|
| Menu Command | 64 |
| Copy from Program | 64 |
| Write Formant Motion Data | 64 |
| Copy Vocoder | 64 |
| Global mode | 65 |
| Menu Command | 65 |
| Load Preload/Demo Data | 65 |
| Set Program User-Bank Type | 66 |
| Media mode | 67 |
| Menu Command | 67 |
| Load selected..... | 67 |
| Appendices | 69 |
| EXB-RADIAS Specifications | 69 |

Introduction

Overview

The EXB-RADIUS is a synthesizer/vocoder option board that uses Korg MMT (Multiple Modeling Technology) to provide a wide range of tonal variety and 24 voices of polyphony.

When the EXB-RADIUS is installed, you'll be able to use 128 RADIUS programs in program bank INT-F. You'll also be able to save original RADIUS programs you've created in bank INT-F or user banks that you've assigned as bank type RADIUS.

Up to four RADIUS programs can be assigned to timbres in a combination or MIDI tracks in a song, allowing you to create combinations or songs that use them in conjunction with the programs of banks INT-A-E, INT-G, and USER A-G.

Program structure

RADIUS programs can be synth programs that are based mainly on an oscillator algorithm, or vocoder programs that use the vocoder function.

Synth programs

A synth program uses three oscillators (including a noise generator) to produce waveforms which are then processed by filters, amp, EGs, LFOs, and modulation sequencer to create sounds with a wide range of expressive character.

Oscillators (OSC1, OSC2, NOISE)

Oscillator 1 (OSC1) lets you choose from eight types of oscillator algorithm (ranging from basic analog synthesizer waveforms such as sawtooth and triangle to DWGS digital synthesizer waveforms), as well as the signals from the AUDIO INPUT, S/P DIF, and EXB-FW (separately sold option) jacks or signals from the AUX bus. You can also apply cross modulation, unison, or VPM (Variable Phase Modulation) to basic analog synthesizer waveforms such as sawtooth or triangle wave.

Oscillator 2 (OSC2) lets you choose from four different oscillator waves - sine, triangle, square, and sawtooth. Oscillator 2 can be used as the modulating oscillator for the sync modulation (SYNC) or ring modulation (RING) that are such classic analog synthesizer techniques. The best elements of SYNC and RING modulation can be combined using a third option: RING SYNC.

The noise generator (NOISE) generates white noise. You can use this for a variety of sound shaping situations, such as

Synth program

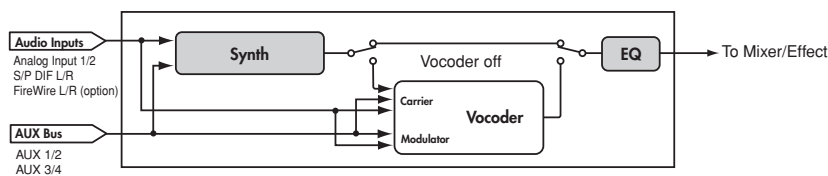

Synth

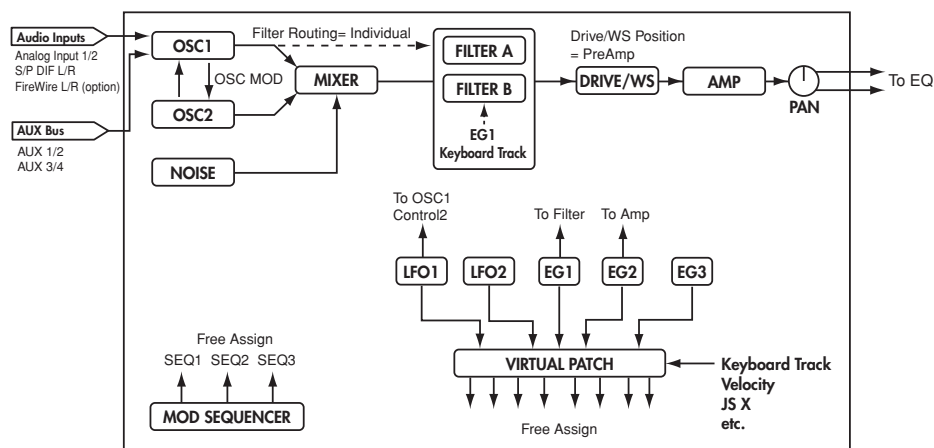

adding breath noise for a wind instrument sound, or as part of a special effect sound.

Mixer (MIXER)

The mixer adjusts the volume levels of oscillator 1 (OSC1), oscillator 2 (OSC2), and the noise generator (NOISE), and sends the combined signal to the filter (FILTER).

Filter (FILTER A, FILTER B)

The filter section consists of two multi-mode, resonant filters. The two filters can be routed in series or parallel, or even side by side in a "one oscillator per filter" arrangement. The filters adjust the tone of the sound coming from the oscillators by boosting or cutting specific frequency regions. Filter settings will have a major impact on the sound. By default, envelope generator 1 (EG1) is set to vary the cutoff frequency of the filters over time.

Amp (AMP)

Traditionally, the amp section controls the output volume (AMP) and the panning (PAN), or the position in the stereo field. The RADIAS program provides additional features to add more tonal complexity and "edge" to the sound - including Drive, Wave Shape control (DRIVE/WS), and Punch Level.

Drive/Wave Shape does not simply apply an effect to the oscillator waveform; it modifies the waveform itself to create hard-edged tones. By adjusting the filter cutoff or resonance you can create even more dramatic effects.

By default, envelope generator 2 (EG2) is set to vary the volume level over time.

Envelope generators (EG1/EG2/EG3)

Envelope generators (EG) are used to apply time-varying change to the sound parameters.

You can create the desired envelope by using the four basic parameters attack time, delay time, sustain level, and release time. You can also choose linear, logarithmic, or exponential curves.

EG1 is assigned to control the filter cutoff frequency, and EG2 is assigned to control the volume of the amp. You can also use virtual patching (VIRTUAL PATCH) to assign these EGs as envelope sources for other parameters.

LFO (LFO1, LFO2)

LFO (Low Frequency Oscillator) is used to apply cyclic change to the sound parameters.

RADIAS program contains two LFOs, and for each LFO you can choose one of four waveforms. Shape control, key sync and phase controls extend well beyond traditional LFO offerings.

LFO1 is assigned to the oscillator 1 waveform (depending on the selected waveform), and LFO2 is assigned as a pitch modulation source controlled by the joystick +Y axis.

You can also make virtual patch settings (VIRTUAL PATCH) to assign the LFOs as modulation sources for other parameters.

Virtual Patch (VIRTUAL PATCH)

The virtual patch section lets you freely assign modulation sources to modulate-able parameters, giving you even more flexibility for creating sounds. You can make eight virtual patch assignments in each RADIAS program.

Modulation Sequencer (MOD SEQUENCER)

Using a modulation sequencer, you can apply up to sixteen discrete values (steps) to a modulate-able parameter over time, in a manner similar to vintage analog synthesizers. The modulation sequence can play once, repeat, loop front to back, etc. - providing movement and complexity to the sound. The value can change abruptly at each step, or it can

smoothly transition from value to value. Each RADIAS program provides three sequencers, allowing you to create extremely complex tonal changes.

Equalizer (EQ)

You can use a three-band equalizer with sweepable mid-range.

Mixer, Effects

The signal that has passed through the EQ can be processed by effects via a highly flexible mixer. As with EDS programs, you can use five insert effects (IFX), two master effects (MFX), and one total effect (TFX).

KARMA, Drum Track, X-Y Mode, Controllers

You can use this functionality in the same way as you can with EDS programs.

Vocoder program

A vocoder applies the spectral character of the “modulator” (e.g., a signal received from the AUDIO INPUT 2 jack) to the “carrier” (e.g., a signal received from the AUDIO INPUT 1 jack).

The most popular way to use this is to input your voice from a mic connected to the AUDIO INPUT 2 jack, creating the impression that an instrumental sound is “talking.”

Vocoder program

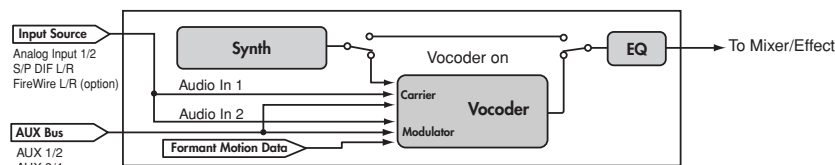

Vocoder

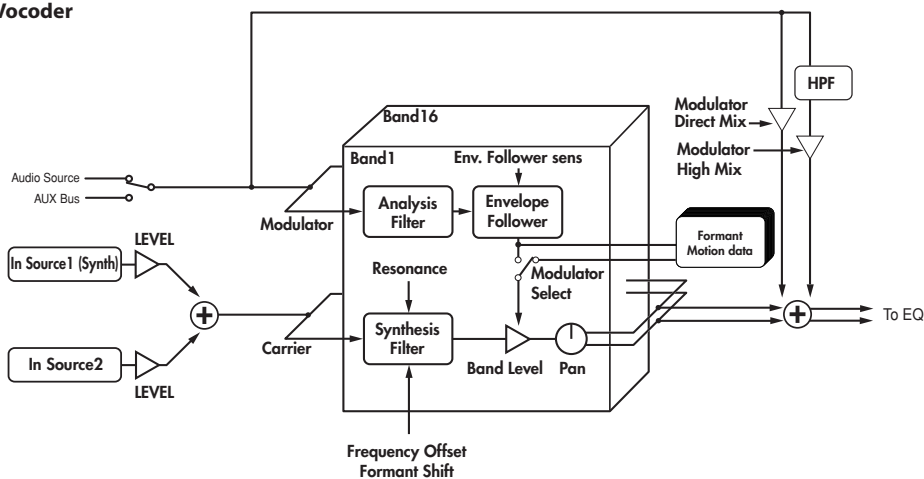

Vocoder section (VOCODER)

The vocoder divides the audio spectrum into “bands”. In the RADIAS program, the vocoder uses 16 bands. There are actually two sets of 16 bands; the first is used to analyze the tonal characteristics of one sound (the Modulator), and the second set is used to apply the same characteristics to another sound (the Carrier). Each analysis band contains a bandpass filter and an envelope follower. Each synthesis band contains a band pass filter whose output is controlled by the matching envelope follower in the analysis band. The modulator’s audio signal is sent through the sixteen bandpass filters (the analysis filters), and the envelope follower detects the volume envelope (change over time) for each of these frequency bands.

The carrier’s audio signal is sent through the other set of sixteen bandpass filters (the synthesis filters), and the envelope detected from each analysis filter is applied to each synthesis filter to modulate the sound, producing the impression that the carrier sound is “talking” (the typical vocoder effect).

You can use the **Formant Shift** and **Frequency Offset** parameters to shift the frequencies of the carrier bandpass filters. This will raise or lower the frequency response while preserving the character of the modulator, creating major changes in the sound.

Carrier (CARRIER)

A sawtooth wave (SAW) or other waveform rich in overtones is the best choice for the carrier. As the carrier, you can use a combination of two sources (In Source1 and In Source 2).

As the In Source1 you can use the mono-mixed signal from the output of the amp section (the signal before it is sent to the insert effects). In Program mode, the synth sound of the program is fixed as In Source 1.

As the In Source 2 you can use an external input (e.g., AUDIO INPUT 1 jack) or the AUX bus (insert effect output).

Modulator (MODULATOR)

Most commonly, you will input your voice as the modulator, but interesting results can also be obtained by inputting a rhythm sound as the modulator waveform. You can use either an external input (AUDIO INPUT 2 jack) or AUX bus (an external input processed by an insert effect, or a program sound such as rhythm) as the modulator. There is also a Formant Motion function that lets you record Formant Motion Data to capture the moving characteristics of a voice or other sound, and use this data to drive the vocoder.

Combination structure

You can combine RADIAS programs and EDS programs to create more complex sounds.

RADIAS programs can be used in four timbres simultaneously.

The structure of a combination and the functionality in Combination mode is the same as for combinations that use EDS programs.

Song structure (Sequencer mode)

You can use RADIAS programs in the MIDI tracks of a song. RADIAS programs can be used in up to four MIDI tracks simultaneously.

The structure of a song and the functionality in Sequencer mode is the same as for songs that use EDS programs.

About the vocoder function in combinations and songs

You can use the vocoder in each combination or song. Only one instance of the vocoder variation can be used in each combination or song.

If you want to use a vocoder program in a combination or song, you'll need to use the menu command **Copy from program** or **Copy Vocoder** to copy the vocoder settings of the program. You can use this for the timbre or song of one RADIAS program.

⚠ Even if you've assigned four timbres or MIDI tracks to play programs in which the RADIAS vocoder is turned on, it is not the case that four vocoders are operating.

Note: Timbres or MIDI tracks using multiple RADIAS programs, or timbres or MIDI tracks using EDS programs, can be used via the AUX bus as the carrier and modulator of the vocoder.

Combination/Song

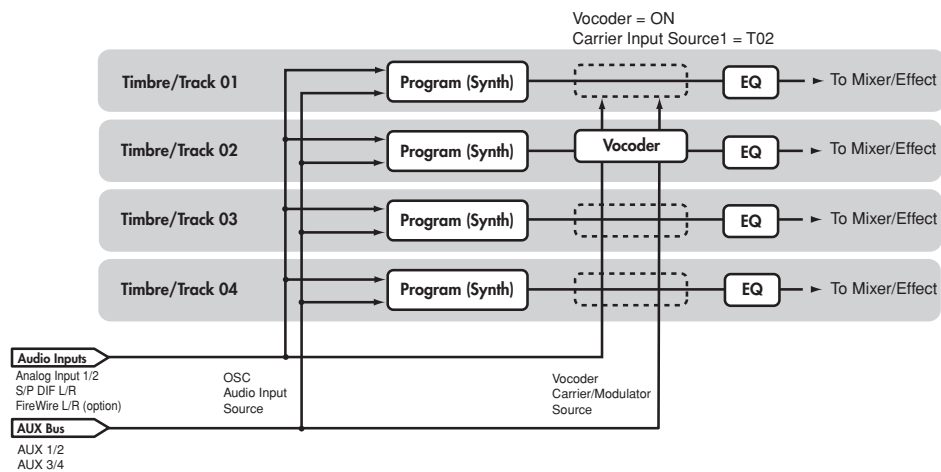

Quick Start

Selecting and playing programs

For details on connecting external devices and setting up, refer to “M3 operation guide.”

Synth programs

Here’s how to select synth programs and try out various sounds.

Selecting and playing

1. Press the PROG switch to enter Program mode.

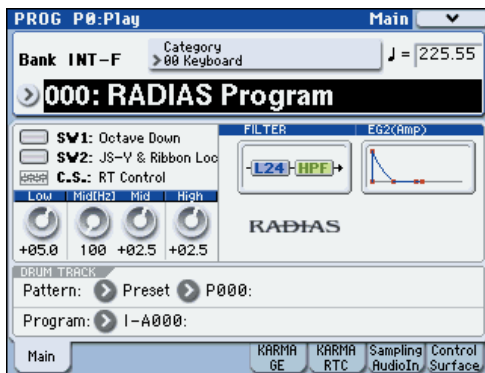

2. Press the BANK SELECT I-F switch to select programs from bank INT-F.
3. Use the Δ and ∇ switches, the VALUE dial, or the numeric switches to select a program.
4. Play the keyboard or pads to hear the sound of the program.

There are also other ways to select programs, such as by category. For more about other ways to select programs, please see “Selecting Programs” on page 37 of the M3 operation guide.

Using controllers to vary the sound

1. Numerous controllers are located in the left side of the M3’s front panel. While you play the keyboard, operate the joystick, ribbon controller, and SW1 and SW2 switches to vary the sound.

The result will differ for each program, so try them all out to see what each controller does for the particular program you’ve selected.

For details on these controllers, please see “Using Controllers” on page 41 of the M3 operation guide.

2. Use the Realtime Controller function of the control surface to control the sound parameters. Press the CONTROL ASSIGN REALTIME CONTROLLER switch (the LED will light).

You can control the sound parameters that are assigned to the sliders and switches.

For details on Realtime Controller, please see “Using realtime control to edit sounds or effects” on page 48 of the M3 operation guide.

3. Use the Tone Adjust function of the control surface to control the sound programs of the RADIUS program.

Press the CONTROL ASSIGN TONE ADJUST switch (the LED will light).

You can control the sound parameters that are assigned to the sliders and switches.

For details on the default Tone Adjust settings for a RADIUS program, please see “Tone Adjust Default Settings” on page 24.

Note: You can use the switches and sliders to control the parameters assigned to Realtime Controller and Tone Adjust even when you’re in the main page of the screen. However since it’s most convenient to be able to see the values change in the display while you adjust them, you’ll probably want to be viewing the PROG P08: Control Surface page. Press the Control Surface tab located in the lower right of the display. When you operate the eight switches and sliders, they will perform the functions assigned to them, and the sound will change. The objects in the display will also change accordingly.

Vocoder programs

Let's select a vocoder program and try out the vocoder function.

You'll need to connect a mic to the AUDIO INPUT 2 jack. Before you connect the mic, set the AUDIO INPUT LEVEL knob to MIN.

Selecting and playing

1. Connect your mic to the rear panel AUDIO INPUT 2 jack.
2. Set the MIC/LINE switch to MIC.
3. Select vocoder program 127 from program bank INT-F.
4. Access the PROG P0-7: Sampling/Audio In page.

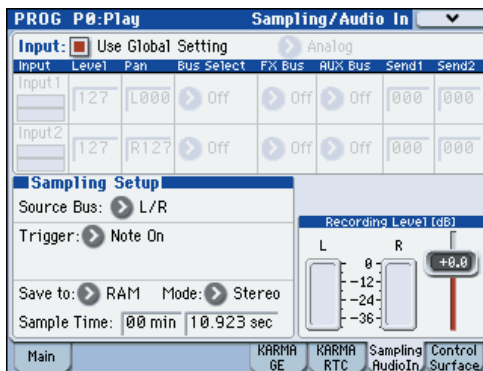

5. Set the following parameters.
 - Use Global setting: Off (unchecked)
 - Input: Analog
 - Input 2 BUS Select: L/R

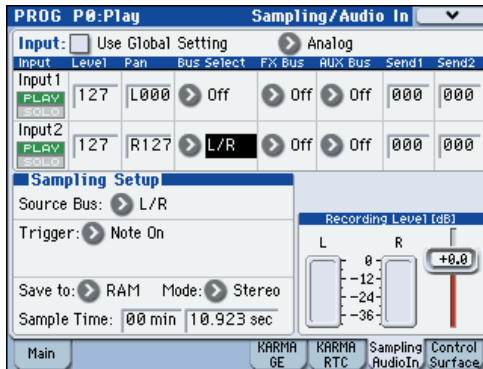

6. While vocalizing into your mic, use the AUDIO INPUT LEVEL knob to adjust the input level.

The optimum input level is a point slightly below the level where the "ADC OVER!" (AD converter input overload) indication appears.

When you've finished adjusting the level, turn Input 2 BUS Select Off.

7. While vocalizing into your mic, play the keyboard. You'll hear the vocoder sound.

Using controllers to vary the sound

For vocoder programs as well, various sound parameters are assigned to the Realtime Controller and Tone Adjust functions of the control surface. Try operating the switches and sliders, and see how they affect the sound.

Operation

Editing a program

In the PROG P0: Play page, you can select and play RADIAS programs, use the control surface to perform quick editing, and adjust the KARMA settings in the same way as for EDS programs. In other pages, you can make more detailed edits to the sound.

Basic settings for the program

To edit a RADIAS program, you'll start in the PROG P1-1: Program Basic page, where you can specify settings such as scale type and audio input source.

Here we'll explain how to make a RADIAS program play monophonically.

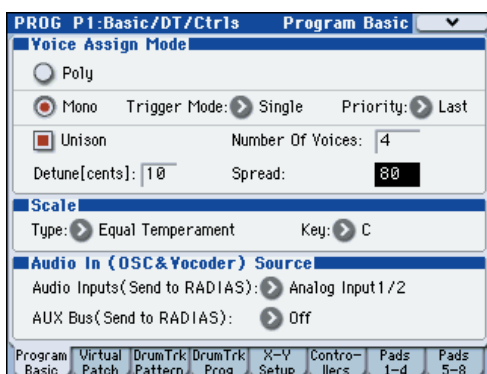

Voice Assign Mode

1. Set the "Voice Assign Mode" to Mono.

Voice Assign Mode specifies how the oscillators will produce sound.

With the Mono setting, only one note will be heard even if you play a chord on the keyboard. This setting is suitable if you're performing a synth bass, synth lead, or other solo instrument sound.

2. Set "Trigger Mode" to Multi.

Trigger Mode specifies how the sound will be triggered. With the Multi setting, the sound is retriggered each time you play a note.

3. Set "Priority" to Last.

With the Last setting, priority will be given to sounding the last-played note if you've held down two or more keys simultaneously.

4. Set "Unison" On (checked).

Unison selects whether multiple voices will be sounded in unison when you play a single note.

Note: If you want to produce a richer sound, turn **Unison** on so that multiple voices will be "stacked." The **Number of Voices** specifies the number of voices that will be stacked.

5. Use "Number of Voices" to specify the number of voices that you want to sound simultaneously.
6. Use "Detune [cents]" to specify the amount of detuning (pitch difference) between the voices that are sounded simultaneously.

The number of simultaneously-sounded voices specified by **Number of Voices** will be equally spread apart in pitch by the specified **Detune [cents]** amount.

7. Use "Spread" to specify the stereo position of the simultaneously-sounded voices.

The simultaneously-sounded voices specified by **Number of Voices** will be evenly spread across the stereo field according to the **Spread** setting.

Oscillators

RADIAS programs consist of three oscillators: oscillator 1, oscillator 2, and a noise generator.

Here's how to select the oscillator waveform and adjust the output level.

Selecting the waveform



OSC1 (Oscillator 1)

1. Use the "Waveform" to select the waveform for oscillator 1.

You can choose one of nine different waveforms, including an external audio input (Audio In).

2. Use the "OSC Mod" to select the type of modulation being applied to oscillator 1.

You can choose one of four modulation types.

⚠ If you've selected Formant, Noise, DWGS, or AudioIn as the waveform, the only available modulation type will be Waveform (Waveform modulation).

3. Use the "Control 1" and "Control 2" to specify the waveform parameters.

The parameters that are controlled by the **Control 1** and **Control 2** will depend on the waveform and the modulation type you've selected.

For details on the oscillator parameters, please see "2-1a: OSC1" on page 30.

OSC2 (Oscillator 2)

1. Use the "Waveform" to select the waveform of oscillator 2.

You can choose one of four different waveforms. The most common way to use this is to select the same waveform as oscillator 1, and change its pitch slightly to create a rich sound.

2. Use the "OSC Mod" to select the modulation type for oscillator 2.

You can choose one of three modulation types.

3. Use the "Semitone" to adjust the pitch of oscillator 2 in semitone steps.

Some of the more common ways to set this parameter is to lower the pitch by one octave (-12) or two octaves (-24) relative to the pitch of oscillator 1. Vintage analog synthesizer players would sometimes set the oscillators a fourth (+5) or fifth (+7) apart in pitch.

4. Use the "Tune" to adjust the pitch of oscillator 2.

You can produce a richer sound by slightly changing the pitch to create a detuned effect.

Mixer

The mixer lets you adjust the output level of each oscillator. This setting will determine the input level to the filters.

1. Use the "OSC1 Level" to adjust the volume of oscillator 1.
2. Use the "OSC2 Level" to adjust the volume of oscillator 2.
3. Use the "Noise Level" to adjust the volume of the noise generator.

You can use the noise generator to simulate the breath noise of a wind or brass instrument, or to create sound effects.

The oscillator waveform you select here can be processed by the filters, drive/waveshaping, EG, and LFO etc. to create the sound you want.

Filter

The filters allows you to diminish or emphasize specified frequency areas of the sound. The tone of the sound will depend significantly on the filter settings.

RADIAS programs provide the three basic filter types low pass filter, high pass filter, and band pass filter, as well as intermediate types that interpolate between the characters of adjacent filters.

The basic filter settings, including the filter routing, filter type, cutoff frequency, and resonance, are set on the PROG P3: Filter page.

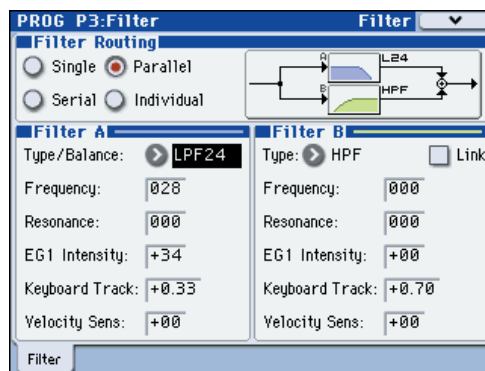

Filter Routing

1. Use "Filter Routing" to select the filter routing.

RADIAS programs provide two filters (filter A and filter B). You can choose to use one or both filters, and how the two will be connected if both are used.

For more information, please see "Filter Routing" on page 34.

Filter A, Filter B (Filter settings)

1. Use the "Type/Balance" select the type of filter.

You can adjust the knob to obtain intermediate characters between these filter types. The filter type will have a major effect on the character of the sound.

If **Filter Routing** is Serial, Parallel, or Individual, you can adjust this independently for filters A and B.

For more information, please see "3-1: Filter" on page 34.

2. Use the "Frequency" to adjust the cutoff frequency of filter.

Higher settings will make the sound brighter. The result will depend on the filter type.

For more information, please see "Frequency (Cutoff Frequency)" on page 35.

3. Use the "Resonance" to adjust the resonance of filter 1.

Higher settings will increasingly emphasize the region around the cutoff frequency, producing a nasal tone or a whistle.

4. Use the "EG1 Intensity" to adjust the depth of the effect that EG1 will have on the cutoff frequency of filter.

You can adjust this independently for filters A and B.

If you turn the knob toward the right of the center position ("+" values), the EG will move the filter in the positive direction (i.e., if the filter type is LPF, the sound will become brighter).

If you turn the knob toward the left of the center position ("-" values), the EG will move the filter in the negative

direction (i.e., if the filter type is LPF, the sound will become darker).

Note: EG1 envelope settings are made in the PROG P5: EG/LFO/SEQ page. (p.38“5-1: EG1 (Filter), 5-2: EG2 (Amp), 5-3: EG3”)

5. Use “Keyboard Track” to specify how keyboard tracking (the keyboard position on which you play) will affect the cutoff frequency.

For more information, please see “Keyboard Track” on page 35.

6. Use “Velocity Sens” to specify how velocity (the force with which you play the keys) will affect the cutoff frequency.

For more information, please see “Velocity Sens (Velocity Sensitivity)” on page 35.

Amp

Amp is where you specify drive and wave shape, adjust the volume, and set the pan.

These settings are made in the PROG P4-1: Amp/WaveShape/Driver page.

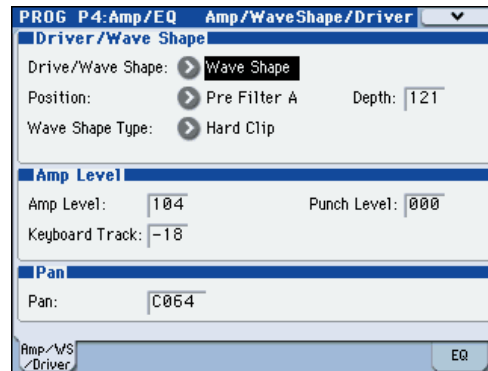

Drive/Wave Shape

Drive/Wave Shape modifies the waveform itself – it is not an effect that is applied to the oscillator waveform. Here’s how to select the wave shape.

1. Set “Drive/Wave Shape” to Wave Shape.
2. Use “Wave Shape Type” to select the type of wave shaping.

This choice is available if **Drive/Wave Shape** is set to Wave Shape. You can choose from a wide variety of wave shape types.

For more information, please see “Wave Shape Type” on page 36.

3. Use “Position” to select the position at which wave shaping will be applied.

You can apply drive and wave shaping before filter A or before the amp section.

For more information, please see “Position” on page 36.

4. Use “Depth” to specify the depth of drive or wave shaping.

Amp Level

1. Use “Amp Level” to specify the basic volume level. The volume level you specify here will be changed by EG2 and other modulation sources.
2. Use “Punch Level” to adjust the mixing amount of the pulse waveform added to the oscillator output.

Higher settings will emphasize the attack.

3. Use “Keyboard Track” to specify how keyboard tracking will affect the volume.

This lets you make the volume change as you play higher or lower on the keyboard.

Pan

1. Use “Pan” to specify the stereo position.

Note: You can produce an auto pan effect by using a virtual patch to modulate this with an LFO.

For more information, please see “Virtual Patch” on page 11.

EG (Envelope Generator)

An EG (envelope generator) applies time-varying change to a parameter of the sound.

EG1 is assigned as the envelope source for filter cutoff frequency, and EG2 is assigned as the envelope source for the amp volume.

You can also use a virtual patch to assign an EG as an envelope source for another parameter.

For more information, please see “Virtual Patch” on page 11.

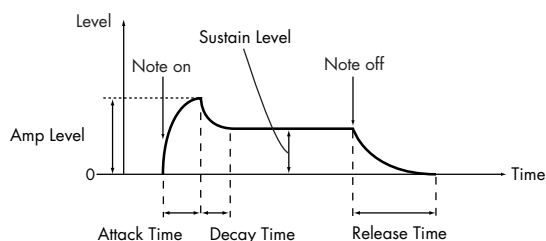

The five parameters (attack time, decay time, release time, sustain level, and curve) that make up each envelope can be edited in the PROG 5-1: EG1, P5-2: EG2, and P5-3: EG3 pages.

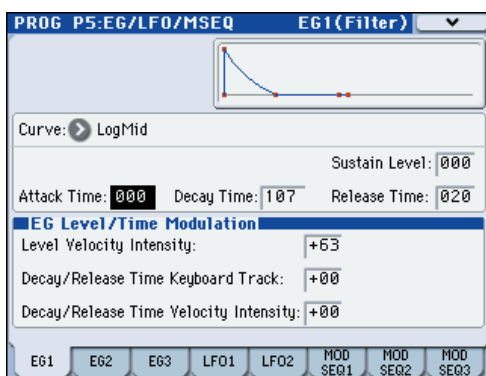

3. Use “Decay/Release Time Velocity Intensity” to specify how velocity will affect decay time and release time.

Higher values will allow velocity to affect the EG time settings more greatly.

Envelope settings

1. Edit the “Attack Time”, “Decay Time”, “Release Time”, and “Sustain Level”.

Higher values for **Attack Time**, **Decay Time**, and **Release Time** will lengthen the time over which the tone or volume will change.

2. Use “Curve” to select the curve by which the decay and release time will change.

You can choose linear, logarithmic, or exponential curve. This will affect the way in which the envelope changes.

EG Level/Time Modulation

You can use velocity and keyboard tracking to modulate the EG.

1. Use “Level Velocity” Intensity to specify how velocity will affect the amount of amplitude change produced by the EG.

Higher values will allow variations in your playing velocity to produce greater change in the amplitude.

2. Use “Decay/Release Time Keyboard Track” to specify how keyboard tracking will affect the decay time and release time.

Higher values allow keyboard tracking to affect the EG time settings more greatly.

LFO

These are the parameters for the LFOs (Low Frequency Oscillators). An LFO can apply cyclic change to the sound. LFO1 is internally connected as the modulation source for oscillator 1 waveform.

LFO2 is internally connected as the modulation source for the oscillator pitch modulation controlled by the joy-stick. You can also use a virtual patch to assign an LFO as a modulation source for other parameters. For more information, please see “Virtual Patch” on page 11.

Waveform, speed (frequency), and tempo synchronization can be edited in the PROG P5-4: LFO1 or P5-5: LFO2 pages.

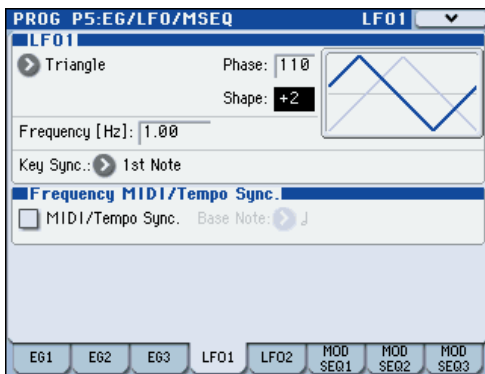

LFO waveform

1. Use “Waveform” to select the basic waveform of the LFO.

The change produced by the LFO depends on the waveform. Select various waveforms and notice the difference in how they affect the sound.

2. Use “Phase” to specify the starting position of the waveform.

Notice that this setting moves the waveform to left or right. You can create interesting effects by offsetting the phase of one LFO relative to the other LFO.

This parameter is available when Key Sync is 1st Note or Each Note.

3. Use “Shape” to modify the basic waveform of the LFO.

The change produced by this parameter will depend on the Waveform you’ve selected.

4. Use “Frequency [Hz]” to specify the frequency of the formant motion.

This parameter is valid if MIDI/Tempo Sync. is Off (unchecked).

MIDI/Tempo Sync

1. Use “MIDI/Tempo Sync.” to specify how the LFO will synchronize.

If this is On (checked), the LFO will synchronize to the system tempo specified by the TEMPO knob or TAP TEMPO switch, or to the MIDI Clock from an external device.

2. Use “Base Note” to specify the LFO cycle.

This specifies the ratio of the LFO cycle relative to the system tempo or external MIDI clock. This parameter is valid if MIDI/Tempo Sync. is On (checked).

Virtual Patch

These are the parameters for the Virtual Patch function.

Virtual Patch is a function that lets you assign modulation sources such as EG or LFO to a variety of parameters. For each timbre you can create up to eight of these combinations.

Make these settings in the PROG P1-2: Virtual Patch page.

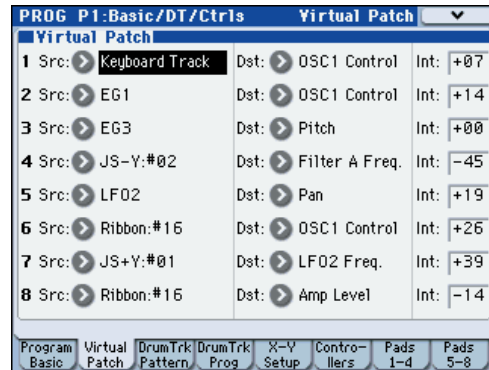

Virtual Patch settings

1. Use “Src (Source)” to select a modulation source.

You can select EG, LFO, or various controllers as a modulation source.

For more information, please see “Src (Source)” on page 28.

2. Use “Dst (Destination)” to select the parameter that will be modulated.

For more information, please see “Dst (Destination)” on page 28.

3. Use “Int (Intensity)” to specify the depth of modulation.

Controlling volume

If you set Src (Source) to LFO2, Dst (Destination) to Amp Level, and adjust Int (Intensity) as desired, LFO2 will produce a tremolo effect.

Controlling pan

If you set Src (Source) to LFO2, Dst (Destination) to Pan, and adjust Int (Intensity) as desired, LFO2 will move the sound between left and right to produce an auto pan effect.

Controlling filter

If you set Src (Source) to LFO2, Dst (Destination) to Filter A Frequency, and adjust Int (Intensity) as desired, LFO2 will vary the filter cutoff frequency to produce an auto wah effect.

You can use an LFO to modulate a wide range of parameters in addition to those listed above.

Source and Destination settings, and their effect

| Src (Source) | Dst (Destination) | Modulation effect |
|--------------|--------------------|-------------------|
| LFO2 | Amp Level | Tremolo effect |
| LFO2 | Pan | Auto pan effect |
| LFO2 | Filter A Frequency | Auto wah effect |

Modulation Sequencers

The Modulation Sequencers let you apply time-varying change to sound parameters in a way similar to analog sequencers of the past. A modulation sequencer stores a discreet value for each of sixteen individual steps, and consecutively applies these values to vary the sound over time. Since three modulation sequencers are provided for each program, you can create sounds that change in very complex ways.

Make these settings in the PROG P5-6: MOD SEQ1, P5-7: MOD SEQ2, and P5-8: MOD SEQ3 pages.

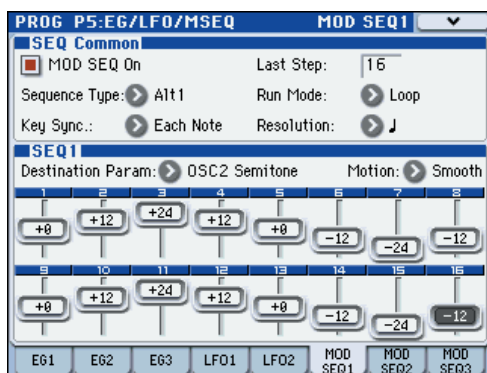

Here we'll explain how to use modulation sequencer 1 to modulate the oscillator pitch.

SEQ Common

Before we specify each step of the actual sequence data itself, we'll need to specify the number of steps in the sequence, and the playback method. These parameters are common to all three modulation sequencers.

1. Access the **PROG P5-6: MOD SEQ1** page.
2. Turn on **"MOD SEQ" On (checked)**.

If this is **On (checked)**, the three modulation sequencers will be on, and the values stored in each step of each modulation sequencer will modulate the sound parameters.

3. Set **"LastStep"** to 16.

The sequence will begin playing when a note-on occurs, and will proceed for sixteen steps.

4. Set **"Sequence Type"** to **Alt1**.

☞ "Sequence Type" on page 40

5. Set **"Run Mode"** to **Loop**.

☞ "Run Mode" on page 41

6. Set **"KeySync"** to **1st Note**.

☞ "Key Sync." on page 41

7. Set **"Resolution"** to \downarrow .

The sequencer will advance one step for each note value you specify here, relative to the tempo. If this is set to \downarrow , the sequencer will advance one step for each quarter-note beat.

Editing the steps

1. Set **"Destination Param"** to **Pitch**.
2. Use **"Motion"** to specify how the values stored in each step will change when the modulation sequencer plays. For this example, choose **Smooth**.
3. While playing the keyboard so that you can hear the sound, specify the sequence data for each step. If you want to adjust the value in detail, use the **VALUE** dial etc.

The value of each step is applied as an amount of relative change to the parameter's assigned value.

Editing a vocoder program

Here's how to make settings for the vocoder's carrier, modulator, and output.

These settings are made in the PROG P6-1: Carrier/Modulator page.

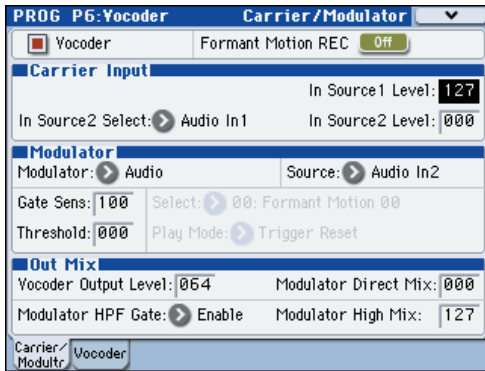

Vocoder on/off

1. Use "Vocoder" to turn the vocoder on/off. If this is on (checked), the vocoder will be on.

Carrier Input

As the vocoder's carrier, you can use two audio signals: the mono-mixed signal output from the amp section (the signal before entering the EQ) and the audio signal from an external input or the AUX bus.

1. Use "In Source 1 Level" to specify the volume of the oscillator input to the carrier.

Input source 1 is the mono-mixed signal from the amp section output (the signal before entering the EQ).

2. Use "In Source 2 Select" to select input source 2 to the carrier.
3. Use "In Source 2 Level" to specify the volume of input source 2 to the carrier.

Modulator, Out Mix (modulator and vocoder output settings)

As the modulator of the vocoder, you can use the external input from the AUDIO INPUT 2 jack, the R-channel of the S/P DIF or FireWire (if the EXB-FW option is installed), the audio signal from the AUX bus, or formant motion data.

In this example, we'll explain how to use a mic connected to the AUDIO INPUT 2 jack as the modulator.

1. Set "Modulator" to Audio.
2. Set "Source" to Audio In2.

The mic or other device connected to the AUDIO INPUT 2 jack will be the modulator.

Note: If you're using a signal from the AUDIO INPUT jack as an input source, make sure that the PROG P1: Program Basic page Audio In (OSC&Vocoder) Source Audio Inputs (Send to RADIAS) parameter is set to Analog Input 1/2.

3. Use "Vocoder Output Level" to specify the volume of the vocoder output.
4. Use "Modulator Direct Mix" to adjust the level of the modulator input source that is mixed into the vocoder output.

5. Use "GateSens" to adjust the gate sensitivity. Adjust this so that the vocoder sound output is not interrupted in an unnatural way.
6. Use "Threshold" to cut the noise when there is no input. Raising this setting will make it easier for the sound to be cut. Adjust this so that noise is not obtrusive when you're not speaking into the mic.
7. Use "Modulator HPF Gate" and "Modulator High Mix" to adjust the high-frequency portion of the input source that will be mixed into the vocoder output.

Use Modulator HPF Gate to specify whether the high-frequency portion of the input source mixed into the vocoder output will be heard only while the internal sound generator is heard, or whether it will always be heard as long as there is an input from Source.

Use Modulator High Mix to specify the amount of the high-frequency portion of the input source that will be mixed into the vocoder output. Raising this setting will emphasize the consonants of your voice.

Filter settings

Here you'll make settings for the modulator's envelope follower and the carrier's band-pass filters (synthesis filters). These settings are made in the PROG P6-2: Vocoder page.

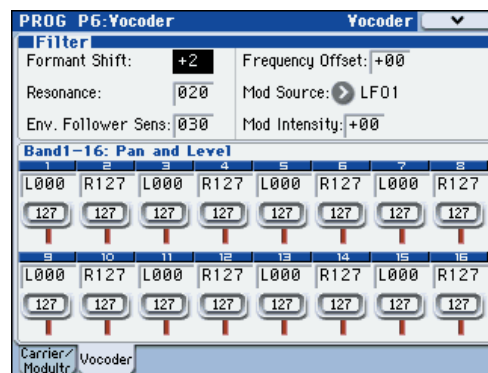

Filter (synthesis filter and envelope follower settings)

1. Use "Formant Shift" to change the shift amount for the band-pass filters. By shifting the filters you can produce dramatic changes in the character of the vocoder output.
2. Use "Frequency Offset" to adjust the offset to the cutoff frequency of the band-pass filters.

You can adjust the filter shift amount in a range of +/-2 steps. In conjunction with Formant Shift, this lets you shift the cutoff frequency in a range of +/-4 steps. (p.44)

3. Use "Resonance" to specify the amount of resonance for the band-pass filters.
4. Use "Mod Source" to select the modulation source that will be applied to the cutoff frequency offset ("Frequency Offset"), and use "Mod Intensity" to specify the depth of modulation.
5. Use "Env. Follower Sens" to adjust the sensitivity of the envelope follower.

Higher settings will produce a smoother rise in the vocoder output and a longer release sound.

Band 1-16: Pan and Level (output level and pan setting for each band of the synthesis filter)

1. Use "Level" to adjust the output level of each filter.
2. Use "Pan" to adjust the pan of each filter.

Formant Motion function

The formant motion function lets you use data such as a previously-recorded voice as the input to the modulator, causing the vocoder to produce sound. This lets you play the vocoder without having to vocalize into the mic. The EXB-RADIAS contains preloaded data for sixteen formant motions.

Assigning a formant motion to the modulator

Here's how to play the vocoder by using the factory-set formant motion data.

1. In Program mode, select a vocoder program.
 ⌘ "Vocoder program" on page 3
2. Access the PROG P1: Carrier/Modulator page.

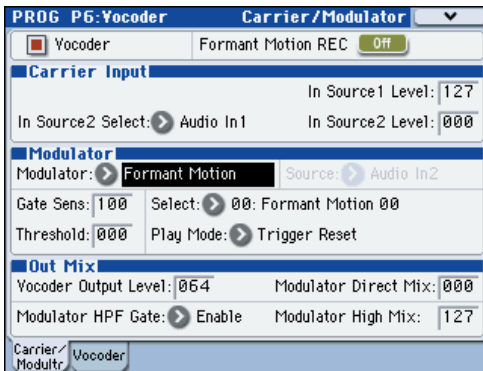

3. Set "Modulator" to Formant Motion.
4. Use "Select" to select the desired formant motion data. You can select from sixteen choices: Formant Motion 00–15.
5. Use "Play Mode" to specify how the formant motion data will play back.

If you select Trigger Reset, the formant motion data will reset to its beginning each time you play a note.

6. Play the keyboard. The vocoder will sound using the formant motion data.

Recording your own formant motion data

Here's how you can connect a mic to the rear panel AUDIO INPUT 2 jack and record your own formant motion data.

1. Connect a mic to the rear panel AUDIO INPUT 2 jack, and use "Program Select" to select a vocoder program.
 ⌘ "Vocoder program" on page 3
2. Adjust the mic input level.
 ⌘ "Vocoder program" on page 3
3. Access the PROG P6-1: Carrier/Modulator page.

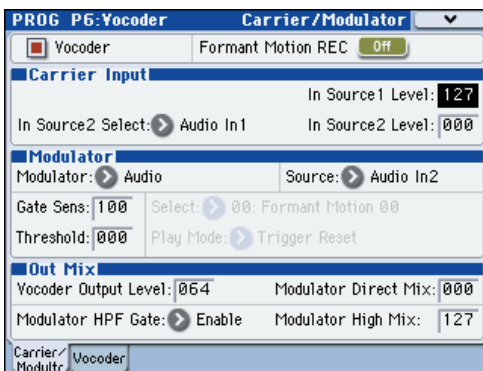

4. Turn "Formant Motion REC" On, and speak into the mic.

Recording will begin when you turn Formant Motion REC On.

5. Turn "Formant Motion REC" Off to stop recording. Recording will stop automatically if the memory capacity assigned to the data becomes full (approximately 7.5 seconds).
6. Set "Modulator" to Formant Motion.
7. Play the keyboard.

The vocoder will sound using the formant motion data you recorded.

If you want to keep the data you recorded, you'll need to write the formant motion data. For more information, please see "Write Formant Motion Data" on page 46.

Writing formant motion data

Here's how the formant motion data you recorded can be written into internal memory. The internal memory can hold sixteen sets of formant motion data.

⚠ We recommend that you write the formant motion data immediately after you've recorded it. The data will be lost if you perform any of the following operations before writing.

- Selecting other formant data
- Selecting another program
- Turning off the power
- Receiving a MIDI dump of the corresponding data from an external connected device

1. In the PROG P6: Vocoder page, choose the menu command "Write Formant Motion Data" to access the dialog box.

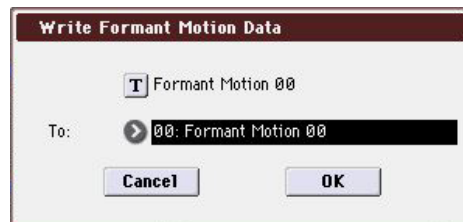

2. The upper line shows the name of the formant motion data.

If you want to edit the name of the formant motion data, press the text edit button to access the text edit dialog box, and enter the desired name.

3. Use the "To" field to select the writing destination.
4. Press the OK button to write the formant motion data, or press the Cancel button if you decide not to write the data.

⚠ Never turn off the power while the data is being written. Doing so may damage the data.

Note: The data that is written will be held in internal memory even when the power is off. You can also use the Media mode menu command "Save PCG" to save it on an external memory device. The data is saved as part of the PCG file.

Creating your own program

You can create original sounds by editing a preloaded program or by editing an initialized program from scratch. These programs you create can be saved (written) to bank INT-F or to a user bank that has been assigned for saving RADIAS programs.

Saving a program

RADIAS programs can be saved in bank INT-F and in user banks whose bank type has been set to RADIAS by the Global mode menu command "Set Program User-Bank Type." For more information, please see "Set Program User-Bank Type" on page 66.

The save procedure is the same as for EDS programs. For more information, please see "Saving your edits" on page 50 of the M3 operation guide.

Editing a combination (Combination mode)

You can use RADIUS programs in the timbres of a combination, and create combinations that use them together with the programs of banks INT-A-E, INT-G, and USER-A-G. Up to four RADIUS programs can be used in one combination. The maximum polyphony of the RADIUS programs will be 24 voices.

However, the following parameters will operate in a different way than when you're using an EDS program. Refer to the parameter guide.

- COMBI P3-3(4)c: **Force OSC Mode, OSC Select, Portamento** (p.54)
- COMBI P3-5(6)c: **Pitch Transpose, Detune (Use BPM Adjust in Menu)** (p.54)
- COMBI P3-7(8)c: **Type (Combi's Scale)** (p.55)
- The Keyboard Zones / Velocity Zones "Top Slope" and "Bottom Slope" settings will have no effect. (COMBI P4: Zone/Delay)

Timbre settings

Here we'll explain how to select bank INT-F programs so they can be played.

1. Select the combination that you want to edit.
2. Access the COMBI P2-5: RADIUS T01-08 or P2-6: RADIUS T09-16 page.

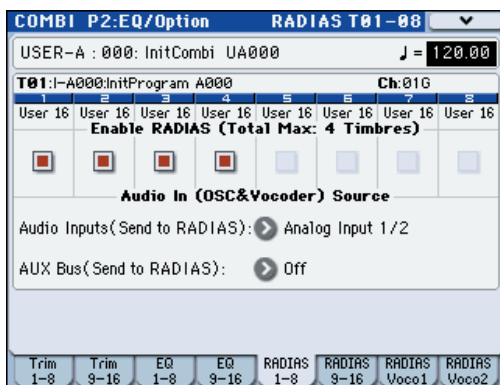

3. In "Program Select," turn "Enable RADIUS" on (checked) for the timbres in which you want to use a RADIUS program. When you play the keyboard, you'll hear the RADIUS program.

Note: You can turn up to four Enable RADIUS settings on. Timbres for which this is off (unchecked) will not sound.

4. Access the COMBI P0-1: Combination Select T01-08 or P0-2: Combination Select T09-16 page.

An indication of "☑" is shown above the category for timbres whose "Enable RADIUS" On (checked).



5. Use "Program Select" to select a bank INT-F program.
6. Edit the parameters of each timbre, make arpeggiator settings, and make settings for routing, insert effects, master effects, and total effects.

Editing a song (Sequencer mode)

You can use RADIUS programs in MIDI tracks of a song. As for a combination, up to four RADIUS programs can be used in one song. The maximum polyphony of the RADIUS programs will be 24 voices.

MIDI track settings

The way in which to make settings, the operation of the parameters, and the points of caution are the same as for a combination.

For more information, please see "Editing a combination (Combination mode)" on page 16.

Restoring the factory settings (Global mode)

Here's how to restore the RADIUS programs and the RADIUS formant motion data to the state in which it was when the EXB-RADIUS was installed. You can restore the EXB-RADIUS to its initially installed state by loading the preloaded data.

- ⚡ Never turn off the power while the data is being loaded.
- ⚡ Before you load the preload data, go to the Global mode P0: Basic Setup, System Preference page, and uncheck the **Memory Protect** settings for the data that you want to load. If you execute this operation with these settings checked, a message of "Memory Protected" will appear, and the data will not be loaded.
- ⚡ When you load a data, the data in the M3's internal memory will be overwritten. If you want to keep the data that is currently in internal memory, use "Save All" or "Save PCG" to save it before you continue.

Restoring the RADIUS program data to the factory-set state

1. Access the Global mode P0: Basic Setup, Basic page. Press the GLOBAL switch to enter Global mode. If the Global P0: Basic Setup, Basic page is not shown, press the EXIT switch and then press the Basic tab.
2. Press the menu button, and choose "Load Preload/Demo Data."
A dialog box will appear.
3. Specify the "Kind" and bank.
Set **Kind: Program**, and **Bank: I-F To I-F** (see the illustration)

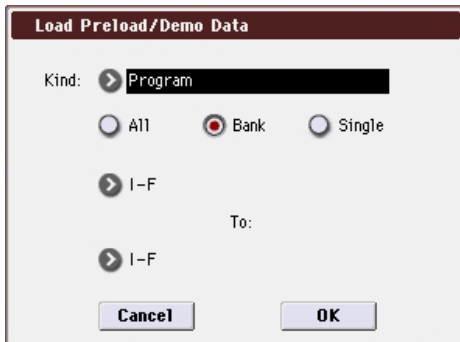

Note: RADIUS programs can be saved in bank INT-F and in user banks whose bank type is set to RADIUS.

☞ "Set Program User-Bank Type" on page 66

4. Press the OK button to execute loading. If you decide to cancel, press the Cancel button.

When you press the OK button, a dialog box will ask you for confirmation. Press the OK button to execute loading.

Restoring the formant motion data to the factory-set state

1. Perform steps 1 and 2 of "Restoring RADIUS programs to the factory settings" to access the Load Preload/Demo Data dialog box.
2. Set "Kind" to RADIUS Formant Motion Data, and specify All as the range of data to be loaded.

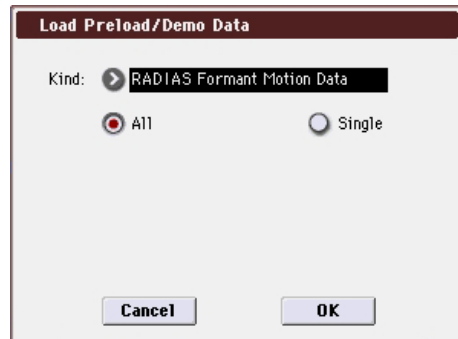

3. Press the OK button to execute loading. If you decide to cancel, press the Cancel button.
When you press the OK button, a dialog box will ask you for confirmation. Press the OK button to execute loading.

Parameter guide

Program mode

Page Select

For details on how to select each page, refer to the “M3 operation guide.”

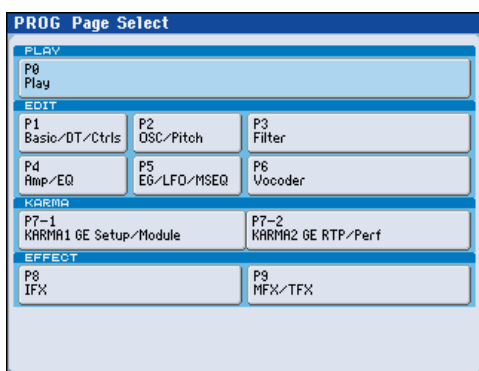

| | Page | Main content |
|--------|------------------------------|---|
| PLAY | P0: Play | Select and play RADIAS programs. Simple KARMA editing. Audio input settings and resampling settings. Editing from the control surface. (☞ M3 PG p.2) |
| | P1: Basic/DT/Ctrl | Basic RADIAS program settings, such as voice assign mode. (☞ p.25) Drum track settings. X–Y control settings. SW1, 2, and slider function settings.) Pad note and velocity settings. (☞ M3 PG p.25) |
| EDIT | P2: OSC/Pitch | Oscillator selection and pitch settings. (☞ p.30) |
| | P3: Filter | Filter (tone) settings. (☞ p.34) |
| | P4: Amp/EQ | Amp (volume) settings. (☞ p.37) Drive/Wave shape settings. (☞ p.36) 3-band parametric EQ settings. (☞ M3 PG p.58) |
| | P5: EG/LFO/M SEQ | EG settings. (☞ p.38) LFO settings. (☞ p.39) Modulation Sequencer settings (☞ p.40) |
| | P6: Vocoder | Vocoder settings. (☞ p.42) |
| KARMA | P7-1: KARMA1-GE Setup/Module | Overall settings for KARMA, and settings for each module. (☞ M3 PG p.77) |
| | P7-2: KARMA2-GE RTP/Perf | KARMA realtime parameter settings and performance parameter settings. (☞ M3 PG p.90) |
| EFFECT | P8: IFX | Oscillator output bus and master effect send level settings. Insert effect routing, selection, and settings. (☞ M3 PG p.98) |
| | P9: MFX/TFX | Master effect routing, selection, and settings. Total effect selection and settings. (☞ M3 PG p.103) |

PROG P0: Play

In this page you can select and play programs. Here you can also perform simple editing of the drum track, EQ, and KARMA function, make settings for the audio inputs and resampling, and view the control surface.

0-1: Main

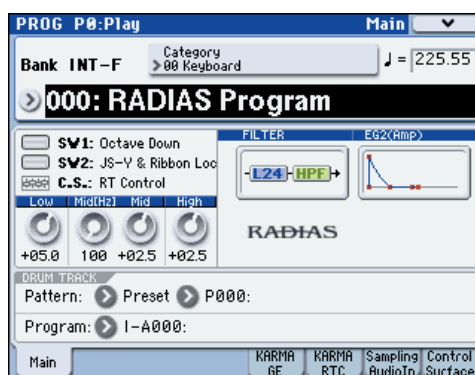

Here you can select a program and specify the tempo. You can also specify the drum track pattern, program, and EQ. These settings are linked with the parameters shown in P1-3, 4, and P4-8.

The screen shows the settings for SW1, SW2, the control surface, the filters, and EG2 (amp).

For details on the available parameters and menu commands, refer to the “M3 parameter guide.”

0-5: KARMA GE

Here you can make settings for the KARMA function in Program mode. A RADIAS program can use one KARMA module (module [A]).

For details on the available parameters and menu commands, please see “0-5: KARMA GE” on page 4 of the M3 parameter guide.

0-6: KARMA RTC

Here you can view the names of the KARMA Sliders 1-8 and KARMA Switches 1-8, and the values that are written to the parameters. The number and value of the GE realtime parameters and performance realtime parameters controlled when you operate these controllers is also shown.

For details on the available parameters and menu commands, please see “0-6: KARMA RTC” on page 6 of the M3 parameter guide.

0–7: Sampling/Audio In

Here you can make settings for analog/digital audio signal input (Analog, S/P DIF), and make settings for sampling in Program mode.

For details on the available parameters and menu commands, please see “0–7: Sampling/Audio In” on page 8 of the M3 parameter guide.

0–8: Control Surface

The Control Surface is the set of 8 sliders and 8 switches to the left of the display. It looks like a mixer, but it can do other things as well, including editing sounds, controlling KARMA, and sending MIDI messages to external devices.

This page shows you the current values for each of the sliders and switches, along with information about what they are controlling. For instance, you can:

- Control the volume, Play/Mute and Solo On/Off settings for RADIAS oscillators and the drum track.
- Modulate sounds and effects using the sliders and switches.
- Control KARMA, and select KARMA scenes, using the sliders and switches.
- Edit sounds using Tone Adjust.
- Assign sliders and switches to different Tone Adjust parameters.

Control Assign Switches and parameters

You can switch the Control Surface between its different functions using **Control Assign** on the display, or the front-panel Control Assign switches. The parameters on the display and the front-panel switches mirror one another; when you change one of them, the other changes as well.

In Program mode, you can select one of five different functions:

MIXER (OSC Mix): The control surface will control the volume, Play/Mute and Solo On/Off status for RADIAS oscillators and the drum track. (In Combination mode and Sequencer mode, you can use this switch to alternate between timbres or tracks 1–8 and 9–16.

MIXER (Mixer Input): The control surface will control the audio input volume, Play/Mute and Solo On/Off status of the analog inputs, S/P DIF inputs, and FireWire inputs (if the EXB-FW is installed).

REALTIME CONTROL (RT Control): Use the sliders to control the sound or effects. Use the switches to turn effects on/off.

EXTERNAL lets you send MIDI messages to external MIDI devices. Use the GLOBAL P1: MIDI– External Mode 1/2 page to specify the MIDI message that will be transmitted.

TONE ADJUST gives you hands-on access to sound editing, using the sliders, and switches.

KARMA: Use the sliders and switches to control the KARMA function.

You can freely change back and forth between the different functions, without losing any of your edits.

For control surface functionality other than MIXER (OSC Mix) and TONE ADJUST, please see “0–8: Control Surface” on page 20 of the M3 parameter guide.

OSC Mix

In OSC Mix you can switch the Play/Mute and Solo On/Off status of the RADIAS oscillators and the drum track.

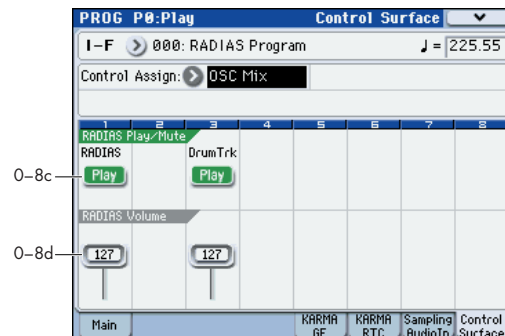

0-8c: RADIAS Play/Mute

OSC Play/Mute:

MIX PLAY/MUTE 1, 3 switches

The MIX PLAY/MUTE 1 switch will mute RADIAS oscillator. This is convenient when you’re editing a RADIAS program. The 3 switch mutes the drum track.

The switch LED will light to indicate Play status, or be dark to indicate Mute status.

RADIAS

[Play, Mute]

When this switch is on (LED = on), RADIAS oscillator will play. When the switch is off (LED = off), RADIAS oscillator will be muted.

DrumTrk

[Play, Mute]

When this switch is on (LED = on), Drum Track will play. When the switch is off (LED = off), Drum Track will be muted.

OSC Solo:

If the menu command **Panel-SW Solo Mode On** is checked, the switches will control Solo for the respective item. Solo operation applies to the RADIAS, drum track, and mixer inputs.

Panel-Switch Solo Mode On and MIX PLAY/MUTE 1, 3 switches

Use the menu command **Panel-Switch Solo Mode On** to specify whether the MIX PLAY/MUTE 1, 3 switches will control Play/Mute or the Solo On/Off. If **Panel-Switch Solo Mode On** is on (checked), the switches will control Solo On/Off.

Tip: You can turn **Panel-Switch Solo Mode On** on/off by holding down the ENTER switch and pressing numeric switch 1.

RADIAS Solo

[Off, On]

Switches the Solo status on/off for RADIAS oscillator.

Drum Trk Solo

[Off, On]

Switches the Solo status on/off for the drum track.

Note: Solo applies to oscillators 1 and 2, the drum track, and the audio inputs.

Note: OSC2 Solo cannot be set for a program whose **Oscillator Mode** is Single or Drums.

The Solo On/Off setting is not saved when you write the program.

Exclusive Solo menu parameter

The menu’s Exclusive Solo parameter also affects the way that Solo works.

When Exclusive Solo is Off (unchecked), you can solo RADIUS oscillator, Drum Track, and audio inputs at once.

When Exclusive Solo is On (checked), only RADIUS oscillator or Drum Track can be soloed at a time. In this mode, pressing a Solo switch automatically disables any previous solos.

Tips: You can also toggle Exclusive Solo by holding ENTER and pressing [2] on the numeric keypad

0–8d: RADIUS Volume

OSC Volume:

MIX VOLUMES slider 1, 3

Here you can adjust the output level of RADIUS oscillator. This is a volume control that is independent of the Amp Level parameter. You can also adjust the output level of the drum track.

RADIUS Volume [000...127]

This slider adjusts the volume of RADIUS oscillator.

Drum Trk Volume [000...127]

Adjusts the volume of the drum track.

Tone Adjust

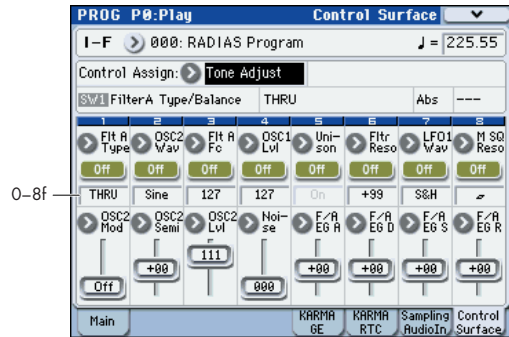

Tone Adjust lets you use all of the sliders and switches on the Control Surface to edit Program parameters, like the knobs on an analog synth. Each physical control can be assigned to any one of a number of Program parameters.

Absolute, Relative, and Meta parameters

For more information, please see “Absolute, Relative, and Meta parameters” on page 21 of the M3 parameter guide.

Saving Tone Adjust Edits

For more information, please see “Saving Tone Adjust Edits” on page 21 of the M3 parameter guide.

Tone Adjust and MIDI SysEx

For more information, please see “Tone Adjust and MIDI SysEx” on page 21 of the M3 parameter guide.

Interaction between Tone Adjust and MIDI CCs

For more information, please see “Interaction between Tone Adjust and MIDI CCs” on page 21 of the M3 parameter guide.

0–8g: Tone Adjust

Selected parameter information

Switches 1...8

Sliders 1...8

For details on these parameters, please see “0–8g: Tone Adjust” on page 20 of the M3 parameter guide.

Common Tone Adjust Parameters

Unless otherwise noted, all of the Common Tone Adjust parameters are **Relative**.

Note: In the list below, the items in parentheses are (value, edit type) respectively.

Off. This means that the Tone Adjust control has no effect.

Filter Cutoff. (-99...+99, CC#74)

This scales the cutoff frequency of all of the filters at once. For instance, in the RADIUS program, it affects both Filters A and B.

Filter Resonance. (-99...+99, CC#71)

This scales the resonance of all of the filters at once - for instance, in the RADIUS program, it affects both Filters A and B.

Filter EG Intensity. (-99...+99, CC#79)

This scales the effect of the EG1 on the cutoff frequency. It affects all of the filters at once; for instance, in the RADIUS program, it affects both Filters A and B. -99 means no modulation. +99 means maximum modulation in the same direction, positive or negative, as the original Program. For instance, if the original Program's **EG1 Intensity** was set to 25, then setting the Tone Adjust to +99 moves the **EG1 Intensity** to -99.

Amp Velocity Intensity. (-99...+99)

This scales the effect of velocity on the Amp level. -99 removes the velocity modulation entirely. +99 means maximum modulation in the same direction, positive or negative, as the original Program.

F/A EG Attack Time. (-99...+99, CC#73)

This scales the attack times of the EG1 and EG2.

F/A EG Decay Time. (-99...+99, CC#75)

This scales the decay and slope times of the EG1 and EG2.

F/A EG Sustain Level. (-99...+99, CC#70)

This scales the sustain levels of the EG1 and EG2.

F/A EG Release Time. (-99...+99, CC#72)

This scales the release times of the EG1 and EG2.

Filter EG Attack Time. (-99...+99)

This scales the attack times of the EG1.

Filter EG Decay Time. (-99...+99)

This scales the decay and slope times of the EG1.

Filter EG Sustain Level. (-99...+99)

This scales the sustain levels of the EG1.

Filter EG Release Time. (-99...+99)

This scales the release times of the EG1.

Amp EG Attack Time. (-99...+99)

This scales the attack times of the EG2.

Amp EG Decay Time. (-99...+99)

This scales the decay and slope times of the EG2.

Amp EG Sustain Level. (-99...+99)

This scales the sustain levels of the EG2.

Amp EG Release Time. (-99...+99)

This scales the release times of the EG2.

Pitch EG (EG3) Attack Time. (-99...+99)

This scales the attack times of the EG3.

Pitch EG (EG3) Decay Time. (-99...+99)

This scales the decay and slope times of the EG3.

Pitch EG (EG3) Sustain Level. (-99...+99)

This scales the sustain levels of the EG3.

Pitch EG (EG3) Release Time. (-99...+99)

This scales the release times of the EG3.

▲ Pitch EG Attack Time–Pitch EG Release Time are named **Pitch EG**, but are actually controlling EG3. RADIUS programs do not have a fixed EG that controls the pitch. If you want to use EG3 to control the pitch, set a virtual patch source (**Src**) to EG3, and set the destination (**Dst**) to Pitch.

Pitch LFO1 Intensity. (-99...+99, CC#77)

This scales the effect of LFO1 on the Pitch.

This is not valid for the RADIUS program.

LFO1 Speed. (-99...+99, CC#76)

This scales LFO1's frequency. When the LFO is in **MIDI/Tempo Sync**, is on, this adjusts the **Base Note**. For more information, please see "Frequency [Hz]," on page 39 and "Base Note (Sync. Base Note)," on page 40.

LFO1 Fade. (-99...+99)

LFO1 Delay. (-99...+99, CC#78)

LFO1 Stop. (PROG/Off/On, Absolute)

This is not valid for the RADIUS program.

LFO2 Speed. (-99...+99)

This scales LFO2's frequency. When the LFO is in **MIDI/Tempo mode**, this adjusts the **Base Note**. For more information, please see "Frequency [Hz]," on page 39 and "Base Note (Sync. Base Note)," on page 40.

LFO2 Fade. (-99...+99)

LFO2 Delay. (-99...+99, CC#78)

LFO2 Stop. (PROG/Off/On, Absolute)

This is not valid for the RADIUS program.

Unison. (Off/On, Absolute)

This **Absolute** parameter turns **Unison** on and off. For more information, please see "Unison," on page 25.

Number Of Voices. (2...16, Absolute)

This **Absolute** parameter sets the number of Unison voices. If **Unison** is not **On**, this parameter has no effect. For more information, please see "Number of Voices," on page 25.

Detune. (00...99, Absolute)

This **Absolute** parameter sets amount of detuning between the Unison voices. If **Unison** is not **On**, this parameter has no effect. For more information, please see "Detune[cents]," on page 25.

Thickness. (Off/01...09, Absolute)

This is not valid for the RADIUS program.

RADIUS Tone Adjust Parameters

OSC1 Waveform (Saw/Square/Tri/Sine/Formant/Noise/

DWGS/AudioIn, Absolute):

Selects the waveform for oscillator 1.

OSC1 Mod (Waveform/Cross/Unison/VPM, Absolute):

Selects the modulation type for oscillator 1.

OSC1 Control1 (000...127/-63...+63, Absolute):

Controls a parameter appropriate for the modulation type of oscillator 1.

Waveform Modulation (000...127):

Controls the oscillator 1 waveform when **OSC1 Mod** is **Waveform**.

Cross Modulation Depth (000...127):

Controls the depth of cross modulation for oscillator 1 when **OSC1 Mod** is **Cross**.

Unison Detune (000...127):

Controls the pitch difference between unison oscillators when **OSC1 Mod** is **Unison**.

VPM Depth (000...127):

Controls the depth of the VPM effect. This can be controlled if **OSC1 Mod** is **VPM**.

Formant Width (000...127):

Controls the frequency components of the formant. This can be controlled if **OSC1 Waveform** is **Formant**.

Resonance (000...127):

Controls the amount of resonance for the noise generator. This can be controlled if the **OSC1 Waveform** is **Noise**.

Gain (-63...+63):

Controls the volume of the audio input. This can be controlled if the **OSC1 Waveform** is **AudioIn**.

OSC1 Control2 (000...127/-63...+63/01...32/LPF63...CNT...HPF63/01...64/L63...CNT...R63, Absolute):

Controls a parameter appropriate for the modulation type of oscillator 1.

LFO1 Modulation Int. (000...127):

Controls the amount of change in the oscillator 1 waveform. This can be controlled if the **OSC1 Mod** is **Waveform** or **Cross**.

Unison Phase (000...127):

Controls the relative phase of the oscillators at note-on. This can be controlled if **OSC1 Mod** is **Unison**.

VPM Harmonics (01...32):

Controls the VPM modulator frequency. This can be controlled if **OSC1 Mod** is **VPM**.

Formant Offset (-63...+63):

Shifts the frequency spectrum of all formants. This can be controlled if **OSC1 Waveform** is **Formant**.

LPF/HPF Mix (LPF...CNT...HPF):

Controls the mix balance between the low pass filter and high pass filter inside the noise generator. This can be controlled if **Waveform** is **Noise**.

Wave Select (00...63):

Selects the DWGS waveform. This can be selected if the **OSC1 Waveform** is **DWGS**.

Balance (L001...C064...R127):

Controls the left/right channel balance of the input signal. This can be controlled if the **OSC1 Waveform** is **AudioIn**.

OSC2 Waveform (Saw...Sine, Absolute):

Selects the oscillator 2 waveform.

OSC2 Mod (Off/Ring...RingSync, Absolute):

Selects the modulation type for the oscillator.

OSC2 Semitone (-24...+24, Absolute):

Controls the amount of detune (semitone units) relative to oscillator 1.

OSC2 Tune (-63...+63, Absolute):

Controls the amount of detune relative to oscillator 1.

OSC1 Level (000...127, Absolute):

Controls the output level of oscillator 1.

OSC2 Level (000...127, Absolute):

Controls the output level of oscillator 2.

Noise Level (000...127, Absolute):

Controls the output level of the noise generator.

FilterA Type/Balance

(LPF24...LPF12...HPF...BPF...THRU, Absolute):
Selects the filter type for filter A.

FilterA Cutoff (000...127, Absolute):

Controls the cutoff frequency of filter A.

FilterA Resonance (000...127, Absolute):

Controls the resonance of filter A.

FilterA EG1 Intensity (-63...+63, Absolute):

Controls the depth by which EG1 will modulate the cutoff frequency of filter A.

FilterA Velocity Sens (-63...+63, Absolute):

Controls the depth by which velocity will modulate the cutoff frequency of filter A.

FilterB Type (LPF...COMB, Absolute):

Selects the filter type for filter B.

FilterB Cutoff (000...127, Absolute):

Controls the cutoff frequency of filter B.

FilterB Resonance (000...127, Absolute):

Controls the resonance of filter B.

FilterB EG1 Intensity (-63...+63, Absolute):

Controls the depth by which EG1 will modulate the cutoff frequency of filter B.

FilterB Velocity Sens (-63...+63, Absolute):

Controls the depth by which velocity will modulate the cutoff frequency of filter B.

Drive/Wave Shape SW (Off/Drive/Wave Shape, Absolute):

Selects drive or wave shape.

Drive/WS Position (Pre Filter1/Pre Amp, Absolute):

Selects the position at which drive or wave shaping will be applied.

Drive/WS Depth (000...127, Absolute):

Controls the depth of drive or wave shaping.

Wave Shape Type (Decimator...Level Boost, Absolute):

Controls the wave shape type.

Punch Level (000...127, Absolute):

Controls the mix amount of pulse wave added to the oscillator output.

LFO1 Waveform (Saw/Square/Triangle/S&H, Absolute):

Selects the LFO1 waveform.

LFO1 Shape (-63...+00...+63, Absolute):

Controls the LFO1 waveform.

LFO2 Waveform (Saw/Square+/Sine/S&H, Absolute):

Selects the LFO2 waveform.

LFO2 Shape (-63...+00...+63, Absolute):

Controls the LFO2 waveform.

Mod SEQ SW (Off/On, Absolute):

Controls the on/off status of the modulation sequence.

MSEQ Seq Type (Forward/Reverse/Alt1/Alt2, Absolute):

Selects the sequence type for the modulation sequence.

MSEQ Last Step (01...16, Absolute):

Controls the number of steps in the modulation sequence.

MSEQ Resolution (3, ..., Absolute):

Controls the playback speed of the modulation sequence as a timing resolution relative to the tempo.

Tone Adjust Default Settings

Tone Adjust provides an elegant physical interface to the parameters. Most of the factory sounds use the default layout, as shown above. You can also customize the layout for individual sounds, if desired.

For more information about Tone Adjust, please see “0–8g: Tone Adjust” on page 21 of the M3 parameter guide.

RADIAS Tone Adjust parameters

The EXB-RADIAS supports all of the Common Tone Adjust parameters, as described under “Common Tone Adjust Parameters,” on page 22. It also adds a number of its own original RADIAS Tone Adjust parameters.

RADIAS Tone Adjust default Settings

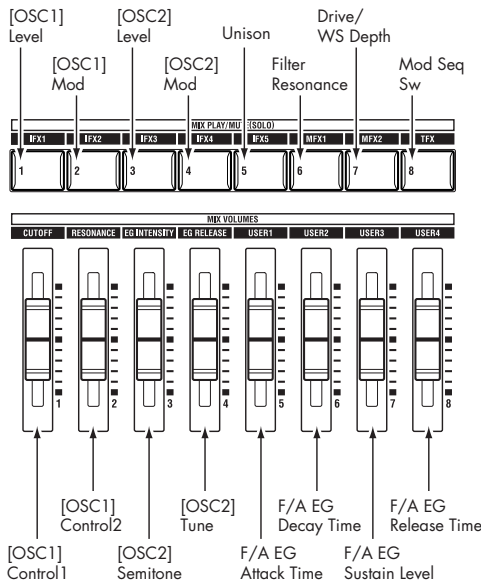

PROG P1: Basic/DT/Ctrls

Here you can make basic settings for RADIUS program. Here you can:

- Select the voice assign mode.
- Specify unison and detune.
- Select the basic scale for the program.
- Select an audio input source for the vocoder or the RADIUS oscillator.
- Make virtual patch settings.
- Make drum track settings.
- Make X-Y mode settings.
- Make controller and pad settings.

1-1: Program Basic

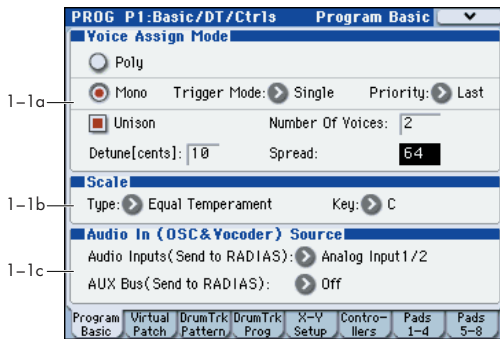

1-1a: Voice Assign Mode

Voice Assign Mode [Poly, Mono]

Selects monophonic or polyphonic operation.

Poly: The program will play polyphonically, allowing you play chords.

Mono: The program will play monophonically, producing only one note at a time.

Trigger Mode [Single, Multi]

This specifies whether the EGs will retrigger when you play a second note before releasing a previously played note. This parameter is shown if **Voice Assign Mode** is set to Mono.

Single: The second and subsequent notes will not retrigger the EG. Use this setting if you want to play legato.

Multi: The EG will be retriggered each time a new key is pressed.

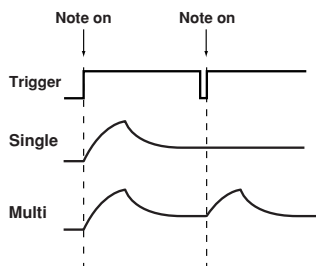

Priority [Low, High, Last]

Priority is available when the **Voice Assign Mode** is set to **Mono**.

This parameter determines what happens when more than one note is being held down.

Low: The lowest note will sound. Many vintage, monophonic analog synths work this way

High: The highest note will sound.

Last: The most recently played note will sound.

Unison [On, Off]

Switches unison on/off.

On (checked): When Unison is on, the Program still plays only one note at a time, but uses two or more stacked, detuned voices to create a thick sound. Use the **Number of Voices** and **Detune[cents]** parameters to set the number of voices and amount of detuning.

Off (unchecked): The Program plays normally.

Number of Voices [2...6]

Specifies the number of voices that are stacked when using the Unison function. When you play a note, the specified number of voices will be heard, producing a richer tone.

Depending on other voice-related settings, the number of voices you specify here may not actually sound.

Detune[cents] [00...99]

Specifies the amount of detuning (pitch spread) that will be applied between each stacked voice when using the Unison function.

Spread [000...127]

Specifies how far the panning of the voices is spread apart when using the Unison function. The panning of each stacked voice will be spread by the amount you specify here

1-1b: Scale

Scale[Equal Temperament...User Octave Scale15]

Selects the type of scale that the current program will use. You can choose one of ten different scale types.

Equal Temperament: Equal temperament, which is the most commonly used scale. Every semitone is spaced an equal pitch distance from the next.

Pure Major: Pure major scale. Major chords in the key specified by **Scale Key** will be completely harmonious.

Pure Minor: Pure minor scale. Minor chords in the key specified by **Scale Key** will be completely harmonious.

Arabic: Arabic scale. It includes the quarter-tone scale characteristic of Arabian music.

Pythagoras: Pythagorean scale, a scale based on ancient Greek musical theory. It is particularly effective when playing melodies.

Werkmeister: Werkmeister scale, an equal tempered scale used in the late Baroque period.

Kimberger: Kimberger scale, created in the 18th century, and used mainly for tuning harpsichords.

Slendro: Slendro scale, an Indonesian gamelan scale that divides the octave into five notes. If the **Scale Key** is C, use the C, D, F, G, and A keys.

Pelog: Pelog scale, an Indonesian gamelan scale that divides the octave into seven notes. If the **Scale Key** is C, use the C, D, E, F, G, A, and B keys.

User Octave Scale: The scale you created in the **User Octave Scale** (Global P3: 3–1a).

Key (Scale Key) [C...B]

Selects the key of the specified scale.

This setting does not apply to the **Equal Temperament** scale.

 If you're using a scale other than Equal Temperament, the combination of the selected scale and the **Key** setting may skew the tuning of the note. For example, A above middle C might become 442 Hz, instead of the normal 440 Hz. You can use the Global Mode's **Master Tune** parameter (Global P0: 0–1a) to correct this, if necessary.

If the RADIUS oscillator output passes through the insert effects and is sent both to the AUX buses and the FX Control Bus, a feedback loop will be created by these settings and the effects listed below, potentially producing loud noise. Please use caution.

- When using 002: Stereo Limiter, if this effect's **Envelope Source** is **FX Control 1** or **FX Control 2**, and **Trigger Monitor** is **On**.
- When using 005: Stereo Gate, if this effect's **Envelope Source** is **FX Control 1** or **FX Control 2**, and **Trigger Monitor** is **On**.
- When using 150: Vocoder, if this effect's **Modulator Source** is **FX Control 1** or **FX Control 2**, and **Modulator High Mix** is other than 0.

1–1c: AudiIn (OSC&Vocoder) Source

Note: In order to use the AUX buses, you'll need to first assign a signal to the AUX buses by editing the AUX setting for an audio input following the insert effect AUX (8-2) or the AUX setting for the drum track (1-4).

For more information, see the diagram "RADIUS program Audio In (OSC&Vocoder) Source" on 27 page.

Audio Inputs (Send to RADIUS) [Off, Analog Input1/2, S/P DIF L/R, Firewire L/R]

Selects the audio in that will be the input source to the EXB-RADIUS. The signal of the selected source will be routed to the following.

- **OSC 1 Waveform: Audio In** (Program 2–1a)
- **Vocoder Carrier: In Source 2** (Program 6–1b)
- **Vocoder Modulator: Source (Audio Source)** (6–1c)

Analog Input1/2: The signal from the AUDIO INPUT 1,2 jacks will directly be the input source. The input from the AUDIO INPUT1 jack will be sent to the L-channel of the oscillator, and the input from the AUDIO INPUT 2 jack will be sent to the R-channel.

S/P DIF L/R: The signal from the S/P DIF jack will directly be the input source.

FireWire L/R: The signal from the FireWire connector will directly be the input source. This can be selected if the EXB-FW option is installed.

For more information, see the diagram "RADIUS program Audio In (OSC&Vocoder) Source" on 27 page.

Note: The signals will be mixed to monaural if the **Unison** parameter is **Off**.

AUX Bus (Send to RADIUS) [Off, AUX1/2, AUX3/4]

Selects the AUX bus that will be the input source to the EXB-RADIUS.

For more information, see the diagram "RADIUS program Audio In (OSC&Vocoder) Source" on 27 page.

AUX1/2: The signal from AUX1 and AUX2 will be the input source.

AUX3/4: The signal from AUX3 and AUX4 will be the input source.

Note: The AUX buses specified by the AUX setting following the insert effect (Program 8-2) or specified by the drum track AUX setting (Program 1-4c) will be input to the EXB-RADIUS if you select them here.

 If the EXB-RADIUS oscillator output Bus Select (Program 8-1) or the oscillator output following the insert effect is sent via the AUX buses back to the RADIUS oscillator or vocoder, a feedback loop will be created. If this occurs, the input signal will automatically be disconnected internally so that a loop does not occur. Be aware that there will be no sound if this occurs.

RADIAS program Audio In (OSC&Vocoder) Source

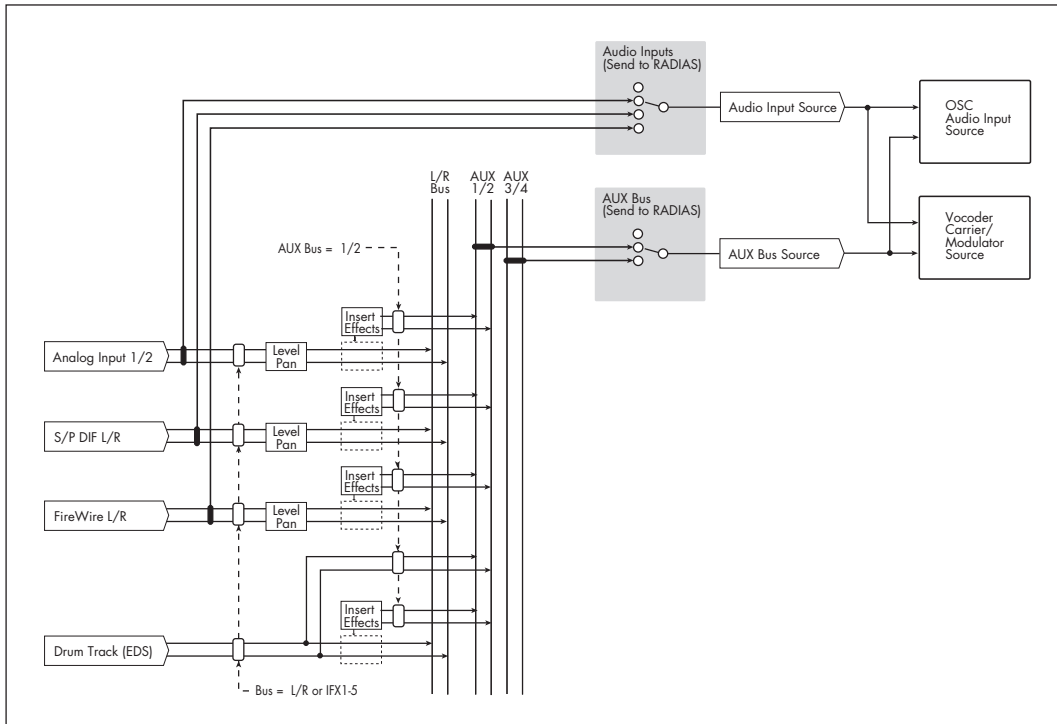

1-2: Virtual Patch

These are the parameters for the Virtual Patch function. Virtual Patch is a function that lets you assign modulation sources such as EG or LFO to a variety of parameters. For each program you can create up to eight of these combinations.

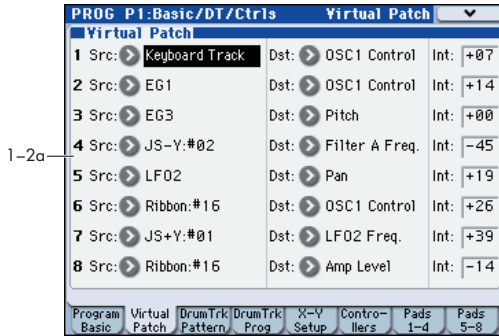

1-2a: Virtual Patch

Src (Source) [EG1...X-Y -Y Mod:#88]

Selects the modulation source.

| | |
|------------------|--|
| EG1, EG2, EG3 | EG1, EG2, EG3 |
| LFO1, LFO2 | LFO1, LFO2 |
| Keyboard Track | note number |
| Velocity | velocity |
| JS X | joystick X (horizontal) direction |
| JS+Y:#01 | joystick+Y (Vertical upward) direction (CC#01) |
| JS-Y:#02 | joystick-Y (Vertical downward) direction (CC#02) |
| After Touch | after touch (channel after touch) |
| Foot Pedal:#04 | foot pedal (CC#04) |
| Ribbon:#16 | ribbon controller (CC#16) |
| Value Slider:#18 | value slider (CC#18) |
| Slider Mod5:#17 | realtime slider 5 (Slider modulation CC#17) |
| Slider Mod6:#19 | realtime slider 6 (Slider modulation CC#19) |
| Slider Mod7:#20 | realtime slider 7 (Slider modulation CC#20) |
| Slider Mod8:#21 | realtime slider 8 (Slider modulation CC#21) |
| Slider Mod5 [+] | realtime slider 5 [+] |
| Slider Mod6 [+] | realtime slider 6 [+] |
| Slider Mod7 [+] | realtime slider 7 [+] |
| Slider Mod8 [+] | realtime slider 8 [+] |
| Damper:#64 | damper pedal (CC#64) |
| SW1 Mod:#80 | assignable panel switch 1 (SW1 modulation CC#80) |
| SW2 Mod:#81 | assignable panel switch 2 (SW2 modulation CC#81) |
| Foot Switch:#82 | foot switch (CC#82) |
| Controller:#83 | MIDI Control Change (CC#83) |
| X-Y +X Mod:#85 | X-Y mode +X (X-Y modulation CC#85) |
| X-Y -X Mod:#86 | X-Y mode -X (X-Y modulation CC#86) |
| X-Y +Y Mod:#87 | X-Y mode +Y (X-Y modulation CC#87) |
| X-Y -Y Mod:#88 | X-Y mode -Y (X-Y modulation CC#88) |

Note: Keyboard tracking works according to the pitch as controlled by pitch bend, transpose, and modulation sequencer. It does not reflect pitch changes produced by vibrato or virtual patching.

Dst (Destination) [Pitch...LFO2 Freq.]

Selects the parameter that will be the modulation destination.

Pitch: The pitch of the entire timbre will be modulated.

OSC2 Pitch: The P2: OSC Basic page **OSC2 Tune** parameter will be modulated.

OSC1 Control: The P2: OSC Basic page **OSC1 Control1** parameter will be modulated.

OSC1 Level, OSC2 Level, Noise Level: The P2: OSC Basic page Mixer **OSC1 Level, OSC2 Level, or Noise Level** parameter will be modulated.

Filter A Type: The P3: FILTER page **Filter A Type/Balance** parameter will be modulated.

Filter A Freq.: The P3: FILTER page **Filter A Frequency** parameter will be modulated.

Filter A Reso.: The P3: FILTER page **Filter A Resonance** parameter will be modulated.

Filter B Freq.: The P3: FILTER page **Filter B Frequency** parameter will be modulated.

Drive/WS Dep: The P4: Amp/WaveShape/Driver page Driver/WaveShape **Depth** parameter will be modulated.

Amp Level: The P4: Amp/WaveShape/Driver page **Amp Level** parameter will be modulated.

Pan: The P4: Amp/WaveShape/Driver page **Pan** parameter will be modulated.

LFO1 Freq., LFO2 Freq.: The P5: LFO1, LFO2 page **LFO1, LFO2 Frequency [Hz]** parameter will be modulated.

Note: If **MIDI/TempoSync** is turned On for LFO1 or LFO2, selecting LFO1 Freq. or LFO2 Freq. respectively will have no effect.

Int (Intensity) [-63...+63]

Specifies the depth of the modulation produced by the modulation source. If this is set to 0, no modulation will occur.

1-3: DrumTrk Pattern (Drum Track Pattern)

Here you can select a drum track pattern and specify how it will sound.

For details on the available parameters and menu commands, please see "1-3: DrumTrk Pattern (DrumTrack Pattern)" on page 28 of the M3 parameter guide.

1-4: DrumTrk Program (Drum Track Program)

Here you can select the drum program that will be used by the drum track.

For details on the available parameters and menu commands, please see "1-4: DrumTrk Program (DrumTrack Program)" on page 29 of the M3 parameter guide.

1-5: X-Y Setup

Here you can make settings for X-Y control.

For details on the available parameters and menu commands, please see "1-5: X-Y Setup" on page 31 of the M3 parameter guide.

1-6: Controllers Setup

Here you can specify the SW1 and SW2 switch and 5-8 slider functions of the program when Control Assign REALTIME CONTROL is selected.

For details on the available parameters and menu commands, please see "1-6: Controllers Setup" on page 35 of the M3 parameter guide.

1-7: Pads 1-4 Setup, 1-8: Pads 5-8 Setup

There are eight velocity-sensitive trigger pads below the display. These look like drum machine pads, and playing drum sounds is certainly one use for them.

For details on the available parameters and menu commands, please see "1-7: Pads 1-4 Setup, 1-8: Pads 5-8 Setup" on page 36 of the M3 parameter guide.

PROG P2: OSC/Pitch

These pages control the first and most basic elements of RADIUS program's sounds: the waveform that the oscillators play, the pitch, and output level at which it plays them. For instance, you can:

- Select the oscillator 1 waveform and modulation type, and specify waveform parameters according to the modulation type.
- Select the oscillator 2 waveform and modulation type, and specify the pitch.
- Specify the output level of each oscillator, including the noise generator.
- Specify the oscillator pitch.
- Specify the vibrato effect applied by the +Y axis of the joystick.
- Specify the pitch bend range.
- Specify the portamento.

2-1: OSC Basic

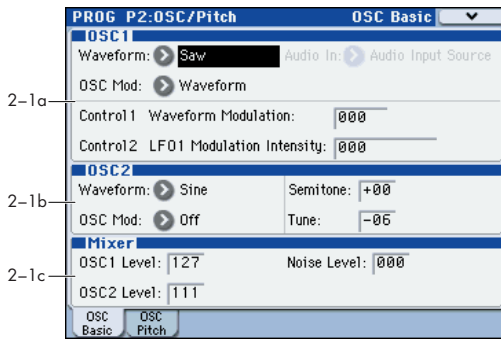

These parameters affect the waveform and output of each oscillator. You can create complex waveforms by using the two oscillators 1 and 2.

2-1a: OSC1

Waveform (Oscillator1 Waveform) [Saw, Square, Tri, Sine, Formant, Noise, DWGS, AudioIn]

Selects the waveform of oscillator 1. The parameters controlled by the **Control1** knob and **Control2** knob will be different based on the waveform you select here and on the **OSC Mod** setting.

Saw: This sawtooth wave is appropriate for creating a wide range of sounds typical of analog synthesizers, including basses and pads.

Square: This is a pulse wave suitable for electronic sounds and wind instruments. By adjusting the pulse width you can produce sounds reminiscent of clavi or sax.

Tri: Triangle wave has fewer overtones than sawtooth wave or square wave, and is suitable for mild tone such as bass or pads.

Sine: Sine wave is a mild tone that contains only the fundamental frequency with no overtones.

Formant: The formant waveform has a tonal character reminiscent of a human voice.

Noise: Generates noise. **Control1** boosts the pitched component within the noise, and **Control2** adjusts the brightness.

DWGS: This provides various DWGS waveforms taken from acoustic instruments and digital synthesizers. You can choose one of 64 different DWGS waveforms.

AudioIn: This lets you use the input source specified by **Audio In** as the oscillator output.

Audio In [Audio Input Source, AUX Bus Source]

Selects the audio input source. This is valid only if **Waveform** is set to **AudioIn**. Use **Control1 Gain** to adjust the input volume, and **Control2 Balance** to adjust the balance.

Audio Input Source: The audio input source will be the signal from the input jack selected by **Audio Inputs (Send to RADIUS)** (Program 1-1c). If the P1: Program Basic page **Unison** parameter is **Off**, the signal will be mixed to mono.

AUX Bus Source: The audio input source will be the signal from the AUX bus selected by **AUX Bus (Send to RADIUS)**.

Note: In order to use the AUX buses, you must first assign audio signals to the AUX buses using the audio in post-IFX AUX setting (Program 8-2) or the drum track AUX setting (Program 1-4c "AUX Bus (Send to RADIUS)" on page 26). If the P1: Program Basic page **Unison** setting is **Off**, the signal will be mixed to mono.

OSC Mod (Oscillator Modulation Type) [Waveform, Cross, Unison, VPM]

Selects the modulation type for oscillator 1.

⚠ The maximum number of voices will change depending on the combination of **Waveform** and **OSC Mod** settings.

⚠ You can't apply modulation if **Waveform** is set to **Formant, Noise, DWGS, or AudioIn**. This field will be shown as **Waveform**.

Waveform (Waveform Modulation): Use **Control1** to modify the waveform.

Cross (Cross Modulation): Cross Modulation uses the output waveform of oscillator 2 (the modulator) to modulate the frequency of oscillator 1 (the carrier) at high speed to produce a modulated sound. The waveform selected by **Waveform** will be the carrier.

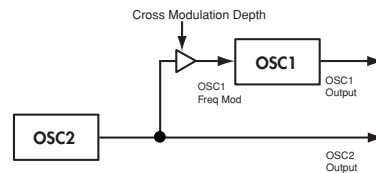

Unison: Unison skews the pitch of five oscillators within a single oscillator and outputs them together to create a richer sound.

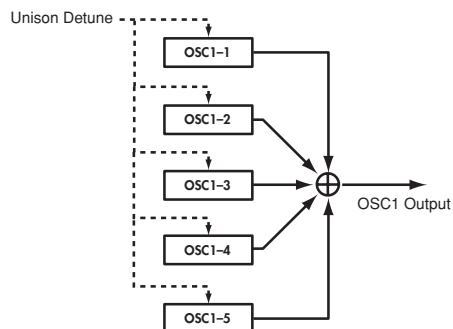

VPM (Variable Phase modulation): VPM (Variable Phase Modulation) uses a sine wave at a harmonic (integer) multiple of the oscillator 1 fundamental to modulate the phase of oscillator 1, producing metallic-sounding overtones. In contrast to Cross Modulation which produces sounds that have a modulating character in the waveform, VPM uses a sine wave at a harmonic multiple of oscillator 1 to modulate the phase of oscillator 1, meaning that the waveform will remain static while overtones are added. The sine wave used for modulation is built into oscillator 1, so the waveform of oscillator 2 will not affect the sound of oscillator 1.

Control1
Control2

Control1 and Control2 adjust parameters of the selected waveform. The parameters and the available values will depend on the waveform that is selected.

 Some settings may produce noise.

When Waveform: Saw/Square/Tri/Sine,
OSC Mod: Waveform

Control1: Waveform Modulation [000...127]

Adjusting the value will modify the waveform. A setting of 0 produces a simple sawtooth wave, and a setting of 127 produces a sawtooth wave one octave higher.

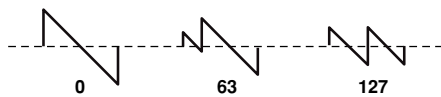

Adjusts the pulse width. A setting of 0 produces a simple square wave. At a setting of 127, the pulse width will disappear completely, and there will be no sound.

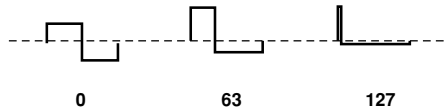

A setting of 0 produces a simple triangle wave, and a setting of 127 produces a triangle wave that is one octave and a fifth higher (i.e., the third harmonic).

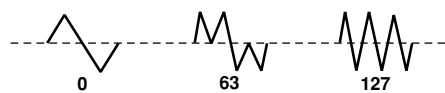

Sine wave is a mild tone that contains only the fundamental frequency with no overtones.



Control2: LFO1 Modulation Intensity [000...127]

LFO1 will vary the Control1 effect (Waveform Modulation). Control2 adjusts the depth of this change. By setting the LFO1 waveform (Program 5-4a **Waveform**) to Triangle and applying this effect, you can produce a result similar to detuning the waveform, producing a richer sound. By setting the LFO1 waveform to Triangle and applying this effect, you can create a pulse width modulation effect, giving the sound more depth.

When Waveform: Saw/Square/Tri/Sine,
OSC Mod: Cross

When you're using cross modulation, the waveform selected by **Waveform** will be the carrier.

Control1: Cross Modulation Depth [000...127]

Adjusts the depth of cross modulation.

Control2: LFO1 Modulation Intensity [000...127]

LFO1 will vary the depth of cross modulation. Control2 adjusts the depth of this change. Pitch Modulation varies the pitch from the basic pitch for an equal distance up/down in terms of musical notes. In contrast, Cross Modulation varies the pitch from the basic pitch for an equal distance up/down in terms of frequency.

When Waveform: Saw/Square/Tri/Sine,
OSC Mod: Unison

Unison detunes the pitch of five oscillators within oscillator 1 and outputs them together to create a richer sound

Control1: Unison Detune [000...127]

Adjusts the pitch distance between the unison oscillators. Higher settings produce a greater spread between oscillators, giving a richer sound.

Control2: Unison Phase [000...127]

Specifies the phase of each oscillator at note-on. This will affect the tone of the attack. A setting of 127 will change the pitch and volume.

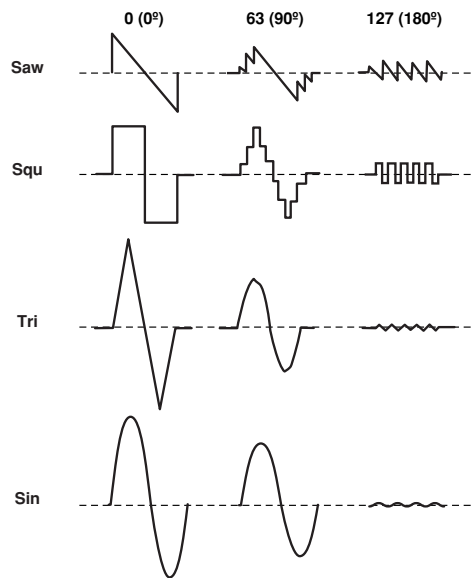

When Waveform: Saw/Square/Tri/Sine,
OSC Mod: VPM

Control1: VPM Depth [000...127]

Adjusts the depth of the VPM effect.

Control2: VPM Harmonics [01...32]

Specifies the frequency of the VPM modulator as a multiple (harmonic) of the oscillator 1 fundamental.

When Waveform: Formant

Control1: Formant Width [000...127]

Adjusts the frequency components that are characteristic of vocal formants. This is equivalent to changing the shape of your mouth (i.e., changing the vowel sound).

Control2: Formant Offset [-63...+63]

Moves the entire formant frequency spectrum upward or downward. This is equivalent to changing the size of your mouth. A setting of 0 produces the standard formant locations.

When Waveform: Noise

Control1: Resonance [000...127]

Adjusts the amount of resonance for the filter provided within the noise oscillator. Higher values will emphasize the frequency points for the pitched component within the noise.

Control2: LPF/HPF Mix
[LPF, 002...063, CNT, 065...126, HPF]

Adjusts the mix balance between the low-pass and high-pass filters; this will vary the brightness of the sound.

When Waveform: DWGS

Control1: --- [---]

Control2: Wave Select [01...64]

This provides various DWGS waveforms taken from acoustic instruments and digital synthesizers. You can choose one of 64 different DWGS waveforms.

| No | Name | No | Name | No | Name |
|----|----------|----|----------|----|----------|
| 0 | SynSine1 | 22 | Digi3 | 44 | Bell1 |
| 1 | SynSine2 | 23 | Digi4 | 45 | Bell2 |
| 2 | SynSine3 | 24 | Digi5 | 46 | Bell3 |
| 3 | SynSine4 | 25 | Digi6 | 47 | Endless* |
| 4 | SynSine5 | 26 | Digi7 | 48 | SynVox1 |
| 5 | SynSine6 | 27 | Digi8 | 49 | SynVox2 |
| 6 | SynSine7 | 28 | Digi9 | 50 | VoxPad1 |
| 7 | SynWave1 | 29 | E.Piano1 | 51 | VoxPad2 |
| 8 | SynWave2 | 30 | E.Piano2 | 52 | VoxPad3 |
| 9 | SynWave3 | 31 | E.Piano3 | 53 | FlutePad |
| 10 | SynWave4 | 32 | Organ1 | 54 | EP Pad1 |
| 11 | SynWave5 | 33 | Organ2 | 55 | EP Pad2 |
| 12 | SynWave6 | 34 | Organ3 | 56 | Noise1 |
| 13 | SynWave7 | 35 | Organ4 | 57 | Noise2 |
| 14 | SynWire1 | 36 | Organ5 | 58 | Noise3 |
| 15 | SynWire2 | 37 | Clav1 | 59 | Noise4 |
| 16 | SynWire3 | 38 | Clav2 | 60 | Noise5 |
| 17 | SynWire4 | 39 | Guitar1 | 61 | Noise6 |
| 18 | 5thSaw | 40 | Guitar2 | 62 | Noise7 |
| 19 | 5thSqu | 41 | E.Bass1 | 63 | Noise8 |
| 20 | Digi1 | 42 | E.Bass2 | | |
| 21 | Digi2 | 43 | E.Bass3 | | |

*: The 48: Endless waveform simulates the “infinite staircase” sound which produces the same perceived pitch in each different octave. The “infinite staircase” produces the sensation that you never get any higher, no matter how long you continue playing the notes C, D, E, F, G, A, B, C, D, E, upward.

When Waveform: Audioln

Control1: Gain [-63...+63]

Adjusts the volume of the audio input.

Control2: Balance [L001...C064...R127]

Adjusts the balance between the L-channel (e.g., AUDIO INPUT 1 jack) and R-channel (e.g., AUDIO INPUT 2 jack) of the input signal selected by **Audio In** (Program 2-1a).

Note: If the P1: Program Basic page **Unison** setting (Program 1-1a) is **On**, certain parameters will automatically be set to allow the input audio to be handled in stereo. In this case, please note the following points.

- Regardless of the **Balance** (Control 2) setting, the signal from AUX buses 1,3 or audio in 1 (L) will be fixed at **Balance=L001**, and the signal from AUX buses 2,4 or audio in 2 (R) will be fixed at **Balance=R127**.
- Regardless of the **Number of Voices** setting (Program 1-1a), it will be fixed at two voices.
- If you set **Spread** (Program 1-1a) to 0, the **Balance** for both the L-ch and the R-ch of the output will be C064 (Center). If you set **Spread** to 127, the L-ch and R-ch of the oscillator output will be set to **Balance** of L001 and R127 respectively.

2-1b: OSC2

These are the parameters for the oscillator 2 waveform.

Waveform (Oscillator2 Waveform)
[Saw, Square, Tri, Sine]

Selects the waveform for oscillator 2.

Saw: Sawtooth wave is suitable for creating a broad range of typical analog synthesizer sounds such as synth bass and synth brass.

Square: Square wave is suitable for electronic sounds or woodwind sounds such as clarinet.

Tri: Triangle wave has fewer overtones and a stronger fundamental than sawtooth wave or square wave. It is suitable for mild bass sounds.

Sine: This is a sine wave.

OSC Mod (Oscillator Modulation Type)
[Off, Ring, Sync, RingSync]

Selects the oscillator modulation type.

Off: Some settings may produce noise.

Off: The sound will be output without any modulation being applied. You can adjust **Semitone** and **Tune** to produce a spacious-sounding detune effect. For fuller synth bass sounds, set the pitch of oscillator 1 and 2 one octave apart.

Ring: This type of modulation generates frequencies at the sum and difference of oscillators 1 and 2. You can adjust **Semitone** and **Tune** to create metallic sounds with little sense of pitch. This is useful for sound effects.

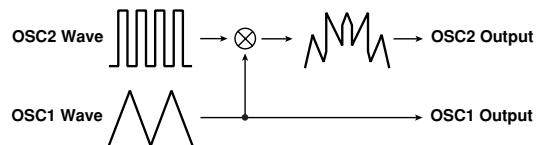

Sync: This type of modulation synchronizes oscillator 2 to the phase of oscillator 1, forcibly resetting the phase of oscillator 2. This is effective on lead synth sounds. Use **Semitone** and **Tune** to adjust the overtones.

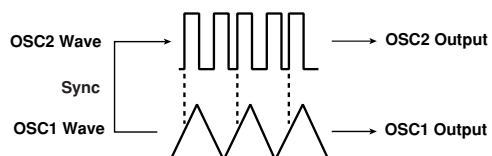

RingSync: This applies Ring and Sync modulation simultaneously.

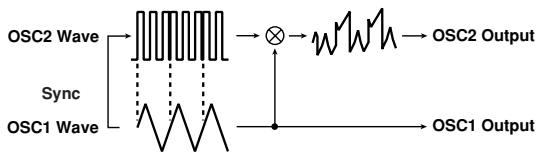

Semitone [-24...+24]

Specifies the amount of detuning relative to oscillator 1 in semitone steps. Values of ± 12 produce a pitch difference of one octave, and values of ± 24 produce a pitch difference of two octaves. At a value of 0, the pitch will be the same as oscillator 1.

Tune [-63...+63]

Specifies the amount of detuning relative to oscillator 1. Values of ± 63 produce a pitch difference of ± 2 octaves, and values of ± 48 produce a pitch difference of ± 1 octave. Values near 0 produce fine adjustments in the pitch.

Note: If **OSC Mod** is set to Sync, adjusting the **Semitone** or **Tune** parameters will change the pitch of the overtones. The pitch of the fundamental will not change.

2-1c: Mixer

These parameters specify the output level of each oscillator. The settings you make here will determine the input level to the filter.

OSC1 Level [000...127]

Specifies the output level of oscillator 1.

OSC2 Level [000...127]

Specifies the output level of oscillator 2.

Noise Level [000...127]

Specifies the output level of the noise generator.

2-2: OSC1 Pitch

These are the pitch-related parameters.

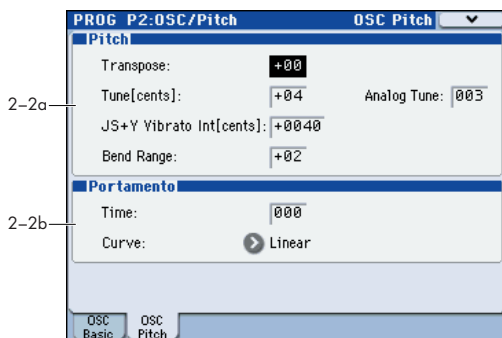

2-2a: Pitch

Transpose [-48...+48]

Shifts the pitch produced by the oscillators in steps of a semitone (100 cents). You can adjust this in a range of four octaves upward or downward.

Tune[cents] [-50...+50]

Adjusts the pitch produced by the oscillators in steps of one cent. You can adjust this in a range of -50 - +50 cents.

Analog Tune [000...127]

By adding a slight randomness to the pitch of each note as it is played, this lets you simulate the pitch instability and oscillator "drift" that was characteristic of analog synthesizers. Higher settings will produce greater variations in pitch.

JS+Y Vibrato Int [cents] (JS+Y Vibrato Intensity) [-2400...+2400]

Moving the joystick "up" from the center detent position, away from yourself, produces the JS+Y controller. You can use this to scale the amount of the LFO2 applied to the pitch. This parameter sets the maximum amount of LFO2 modulation added by JS+Y, in semitones.

As this value is increased, moving the joystick in the +Y direction will cause the LFO2 to produce deeper pitch modulation.

Bend Range [-12...+12]

This sets the maximum amount of pitch bend, in semitones, when you move the joystick to the right. For normal pitch bend, set this to a positive value.

For example, if you set this to +12 and move the joystick all the way to the right, the pitch will rise one octave above the original pitch.

Note: The RADIAS EXB Option is not capable of responding to KARMA Bend Range Messages outside of the range of 0 to +12 Semitones. Values outside of that range will be limited to stay within that range.

2-2b: Portamento

Time (Portamento Time) [000...127]

Specifies the portamento time. Portamento is a function that creates a smooth transition in pitch between one note and the next. With a setting of 000 there will be no portamento. With higher settings, it will take longer to reach the pitch of the next note played.

Curve (Portamento Curve) [LogHard, LogMid, LogSoft, Linear, Expo]

Specifies the curve used by the portamento effect.

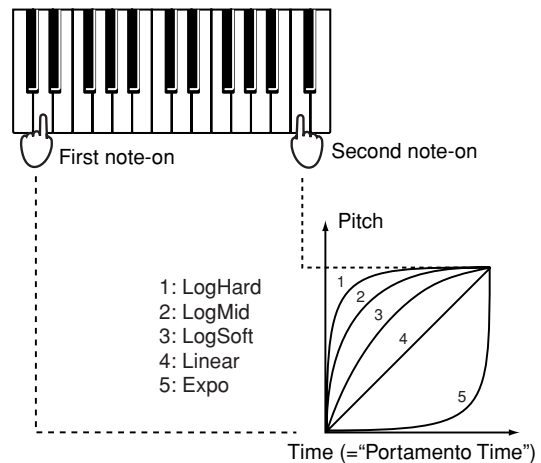

PROG P3: Filter

Here you can make the basic settings for RADIUS oscillator's Filter A and Filter B. Here you can:

- Specify the filter routing, select the filter type, and set the cutoff frequency and resonance.
- Specify filter modulation by keyboard tracking, velocity, and EG1.

3-1: Filter

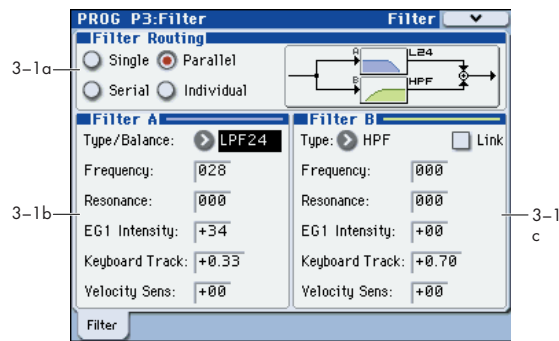

Individual: Filter A and filter B will be used. The oscillator 1 output is sent to filter A, the oscillator 2 and noise output is sent to filter B, and the outputs of both filters are summed.



3-1b: Filter A

Type/Balance (Filter Type/Balance)

[LPF24...LPF12...HPF...BPF...THRU]

Selects the filter type for filter A. The effect that you obtain will depend on the filter type. Intermediate values other than LPF24, LPF12, HPF, BPF, and THRU will provide a response that is interpolated between the two filters.

LPF12 (-12dB/oct), LPF24 (-24dB/oct): LPF (Low Pass Filter) is the most common type of filter; it passes the frequencies below the cutoff frequency and cuts the region above. Raising the cutoff frequency (**Frequency** value) will produce a brighter tone. The 24dB/octave filter (also known as a 4-pole; versus the 12dB/octave also known as a 2-pole filter) cuts the sound below the cutoff frequency at steeper curve and is useful for bass sounds with more "punch."

3-1a: Filter Routing

Filter Routing [Single, Serial, Parallel, Individual]

RADIUS oscillator has two filters, Filter A and Filter B. This parameter controls whether one or both of the filters are used, and if both are used, it controls how they are connected to each other.

Single: Only filter A is used.

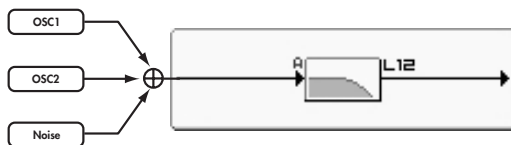

Serial. This uses both Filter A and Filter B. The oscillator first goes through Filter A, and then the output of Filter A is processed through Filter B.

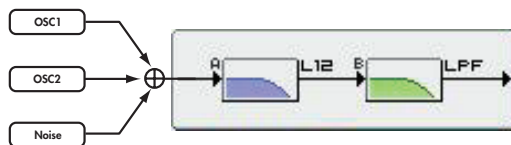

Parallel. This also uses both Filter A and Filter B. The oscillator feeds both filters directly, and the outputs of the two filters are then summed together.

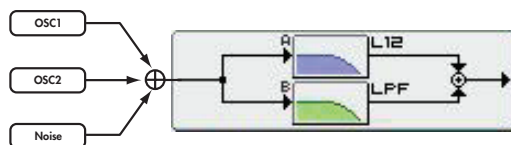

Low Pass: -12dB/oct

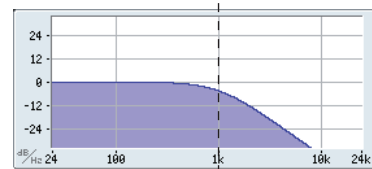

Low Pass: -24dB/oct

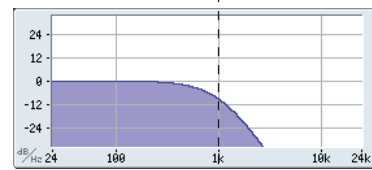

BPF (-12dB/oct): BPF (Band Pass Filter) passes the frequencies in the region of the cutoff frequency, and cuts all other frequency regions. Use this when you want to emphasize just a specific portion of the sound.

Band Pass (-12dB/oct)

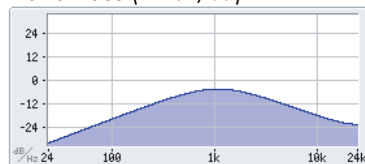

HPF (-12dB/oct): HPF (High Pass Filter) passes the frequencies above the cutoff frequency and cuts the region below. Use this when you want to make the tone thinner. However, raising the cutoff frequency too far will drastically reduce the volume.

High Pass (-12dB/oct)

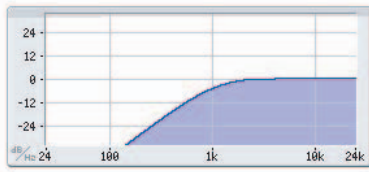

THRU: The sound will output directly, without passing through the filter.

Frequency (Cutoff Frequency) [000...127]

Specifies the cutoff frequency. Higher settings will raise the cutoff frequency.

Note: **Frequency** can be modified by the time-varying changes produced by EG1, position of the notes on the keyboard (keyboard tracking), or keyboard dynamics (velocity). The **EG 1 Intensity**, **Keyboard Track**, and **Velocity Sens** parameters specify the degree to which these will affect **Frequency**.

With some **Frequency** settings, the volume may be extremely low or there may be no sound at all.

Resonance [000...127]

Specifies the resonance. This boosts the region near the **Frequency** frequency, giving a distinctive character to the sound. Increasing this value will produce a greater effect.

The effect of resonance

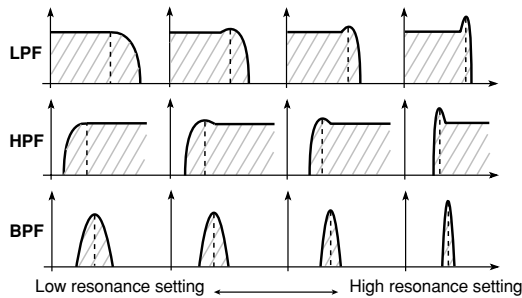

High settings of **Resonance** may cause distortion for some cutoff frequencies or input sounds.

EG1 Intensity [-63...+63]

Specifies the degree to which EG 1 will modulate the cutoff frequency. This will cause the cutoff frequency to change over time. Increasingly positive (+) values will produce a greater effect.

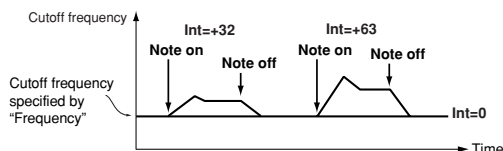

Increasingly negative (-) values will produce a greater effect in the opposite direction.

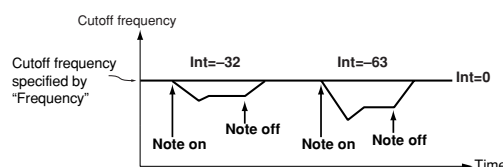

Keyboard Track [-2.00...+2.00]

Specifies how keyboard tracking (location on the keyboard) will modulate the cutoff frequency.

With a setting of 0, keyboard tracking will have no effect. Positive (+) settings will cause the cutoff frequency to rise as you play above the C4 key, or fall as you play below the C4 key. With a setting of +1.0, the change in cutoff frequency will be proportional to the change in pitch. Negative (-) settings will cause the cutoff frequency to fall as you play above the C4 key, or rise as you play below the C4 key.

Note: Keyboard tracking is based on the pitch as controlled by pitch bend, transpose, and modulation sequencer. It does not reflect pitch changes produced by vibrato or virtual patching.

Velocity Sens (Velocity Sensitivity) [-63...+63]

Specifies how velocity (keyboard playing dynamics) will affect the cutoff frequency.

Positive (+) values will cause the cutoff frequency to rise as you play more strongly. Negative (-) values will cause the cutoff frequency to fall as you play more strongly

3-1c: Filter B

These are the parameters for filter B.

These parameters are available if filter A **Routing** is **Serial**, **Parallel**, or **Individual**.

Type (Filter B Type) [LPF, HPF, BPF, COMB]

Selects the filter type.

This setting will affect the maximum number of voices.

LPF, HPF, BPF: These are the same -12 dB/oct type filters as for filter A.

For more information, please see "Type/Balance (Filter Type/Balance)" on page 34.

COMB: In a comb filter (so named for its resemblance to the teeth of a comb), alternating bands pass and cut the signal, giving a unique character to the sound. Increasing the cutoff frequency (**Frequency** value) will space the teeth of the comb farther apart, so that more regions are cut.

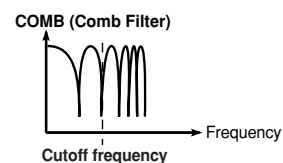

Link [Off, On]

Causes filter B to operate using the settings of filter A parameters.

Off: Filter A and filter B parameters can be set independently.

On: Filter B will operate using the settings of the filter A parameters. Parameters following **Frequency** will use the filter A settings.

Frequency (Cutoff Frequency) [000...127]

Resonance [000...127]

EG1 Intensity [-63...+63]

Keyboard Track [-2.0...+2.0]

Velocity Sens (Velocity Sensitivity) [-63...+63]

These are the same as for FILTER A. For details on these parameters, please see "3-1b: Filter A" on page 34.

PROG P4: Amp/EQ

This page controls the settings for the Drive/Wave Shape, Amp, 3 band EQ section. Here, you can:

- Specify drive or wave shaping.
- Specify the amp volume level and keyboard tracking.
- Specify the pan (stereo position).
- Make settings for the three-band EQ.

4-1: Amp/WaveShape/Driver

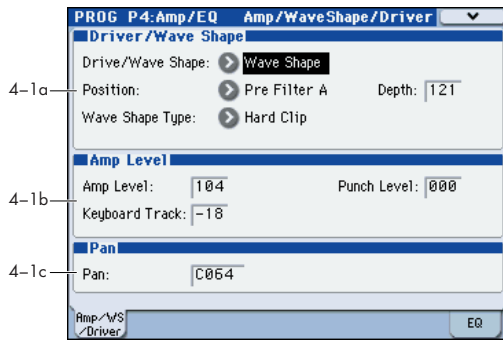

4-1a: Driver/Wave Shape

Drive/Wave Shape [Off, Drive, Wave Shape]

Activates the drive or wave shape functions.

This setting will affect the maximum number of voices.

Off: Drive and wave shape functions will be off.

Drive: Drive will be applied. This produces a distinctive saturation or low-frequency boost effect. The depth of distortion is adjusted by **Depth** and by the output levels of each oscillator in the P2-1: OSC Basic page Mixer.

Wave Shape: Applies wave shaping. Wave shaping is applied with the wave shape type selected by **Wave Shape Type**. This deforms the input waveform to generate numerous overtones that were not present in the original signal.

Position [PreFiltA, PreAmp]

Pre Filter A: Drive or wave shaping will be applied to the oscillator waveform before filter A. This setting is typically used to directly modify the waveform by applying wave shaping to the oscillator waveform.



Pre Amp: Drive or wave shaping will be applied to the oscillator waveform before the amp. This setting is typically used to apply drive to the output of the filter in which the resonance has been boosted, producing a distinctive distortion.



Depth [000...127]

Specifies the depth at which the drive or wave shape functions will be applied.

Wave Shape Type [Decimator...Level Boost]

Selects the type of wave shape. This is shown and can be edited if **Drive/WS** is set to Wave Shape.

This setting will affect the maximum number of voices.

Some settings may produce noise.

Decimator: Lowers the sampling frequency.

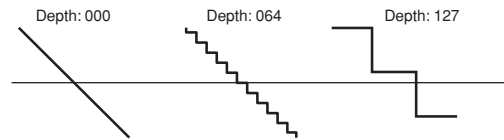

Hard Clip: Flattens any portion of the waveform above the limit.

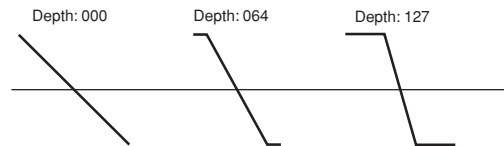

Oct Saw: Cuts the portion of the waveform above the threshold level and moves it within the limits to the inverse position upward or downward.

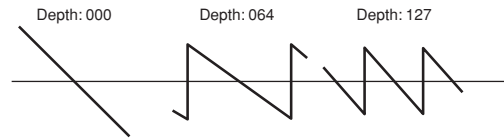

Multi Tri: Sending a sawtooth wave through this will produce a triangle wave.

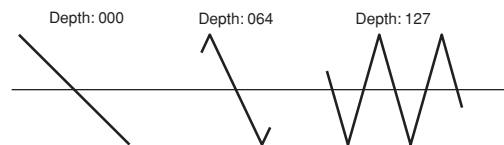

Multi Sin: Sending a sawtooth wave through this will produce a sine wave.

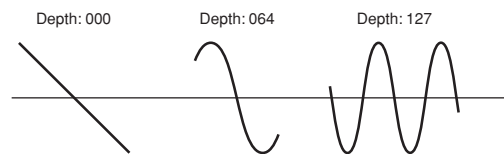

Sub OSC Saw, Sub OSC Squ, Sub OSC Tri, Sub OSC Sin: The selected waveform will sound one octave below oscillator 1. **Depth** adjusts the mix amount relative to oscillator 1.

Pickup: This simulates an electromagnetic pickup. **Depth** adjusts the depth.

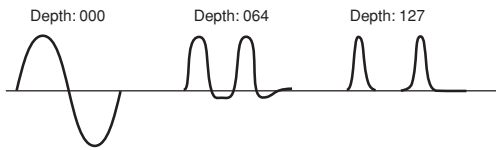

Note: The above illustration for Pickup shows differences in the output waveform when a sine wave at C4 is input. The transformation will vary depending on the input pitch.

Level Boost: Boosts the output level. **Depth** adjusts the amount of boost.

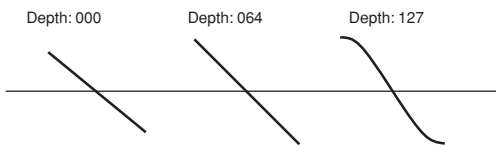

 This may produce high output volumes than other wave shape types.

4-8: EQ

Here you can make the Mid sweep EQ settings.

For details on the available parameters and menu commands, please see “4-8: EQ” on page 65 of the M3 parameter guide.

4-1b: Amp Level

Amp Level [000...127]

This controls the basic volume level of Oscillator 1, before keyboard tracking, velocity, and other modulation.

Punch Level [000...127]

Creates a more “snappy” attack by adjusting the amount of pulse waveform that is added to the oscillator output only during the attack. Increasing this value will emphasize the attack.

 If the attack is slowed down by the EG etc., this will have no effect.

Keyboard Track [-63...+63]

Specifies how keyboard tracking will affect the volume.

With positive (+) settings, the volume will increase as you play upward from the C4 key, and decrease as you play downward.

With negative (-) settings, the volume will decrease as you play upward from the C4 key, and increase as you play downward.

If this value is 0, keyboard tracking will not affect the volume.

Note: Keyboard tracking works according to the pitch as controlled by pitch bend, transpose, and modulation sequencer. It does not reflect pitch changes produced by vibrato or virtual patching.

4-1c: Pan

Pan [L000...C064...R127]

This controls the stereo pan of RADIAS oscillator. A setting of **L001** places the sound at the far left, **C064** in the center, and **R127** to the far right.

PROG P5: EG/LFO/MSEQ

These parameters let you make EG (Envelope Generator) settings to produce time-varying change in the oscillator pitch, filter, and amp, make LFO settings to produce cyclic changes in the sound, and make settings for the modulation sequencer which applies time-varying change to sound parameters in ways typical of analog sequencers of the past.

5-1: EG1 (Filter), 5-2: EG2 (Amp), 5-3: EG3

Here you can make settings for the EG (Envelope Generator).

EG1 is internally connected as the envelope source that controls the cutoff frequency of filter.

EG2 is internally connected as the envelope source that controls the volume of the amp.

Note: You can also use virtual patching (VIRTUAL PATCH) to assign these EGs as envelope sources for other parameters.

Here, you can:

- Specify the envelope curve.
- Select the curve for the decay and release segments of the envelope.
- Make modulation settings.

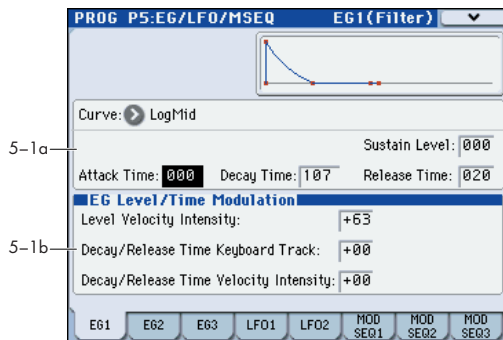

5-1(2)(3)a: Envelope

These parameters specify how the EG will change over time.

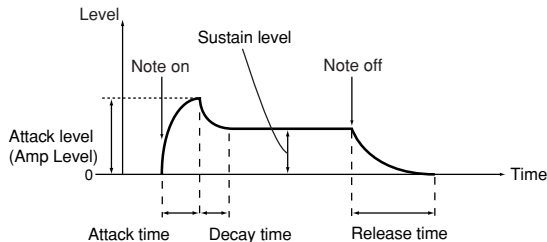

Curve

[LogHard...Expo]

Selects the curve for the decay and release segments of the envelope.

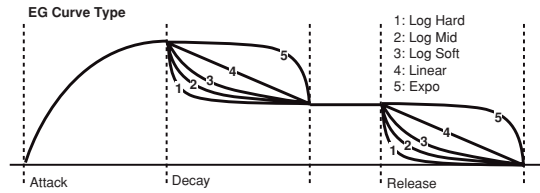

Attack Time

[000...127]

Specifies the time from note-on until the attack level (the maximum value of the envelope) is reached

Decay Time

[000...127]

Specifies the time from when the attack level is reached until the sustain level is reached.

Sustain Level

[000...127]

Specifies the sustain level.

Release Time

[000...127]

Specifies the time from note-off until the level reaches 0.

5-1(2)(3)b: EG Level/Time Modulation

Level Velocity Intensity

[-63...+63]

This allows the amplitude of the EG to be controlled by the velocity of the note-on. Greater values allow velocity to have more of an effect on the amplitude.

With positive (+) settings, When you play softly, the EG amplitude will decrease; when you play strongly, the EG amplitude will increase.

With negative (-) settings, When you play strongly, the EG amplitude will decrease; when you play softly, the EG amplitude will increase.

Decay/Release Time Keyboard Track

[-63...+63]

This allows keyboard tracking to affect the EG's decay time and release time. As you increase this value, keyboard position will make a greater difference in the EG times. The keyboard position is relative to the C4 key.

With positive (+) settings, EG time parameters will become shorter as you play above C4, and longer as you play below C4.

With negative (-) settings, EG time parameters will become shorter as you play below C4, and longer as you play above C4.

Decay/Release Time Velocity Intensity

[-63...+63]

This allows velocity to affect the EG's decay time and release time. As you increase this value, velocity will make a greater difference in the EG times.

With positive (+) settings, EG times will become longer when you play softly, and will become shorter when you play strongly.

With negative (-) settings, EG times will become longer when you play strongly, and will become shorter when you play softly.

5-4: LFO1, 5-5: LFO2

Here you can make settings for the LFO (Low Frequency Oscillator).

LFO1 is internally connected as the oscillator 1 **Control 1** modulation source.

LFO2 is internally connected as the modulation source for the oscillator pitch controlled by the joystick +Y axis (or MIDI control change message CC#01 received from a connected external MIDI device)

Here you can:

- Select the LFO waveform and make settings such as its frequency.
- Specify whether the LFO will be reset by note-on. (Key Sync)
- Make settings for synchronizing LFO to the tempo.

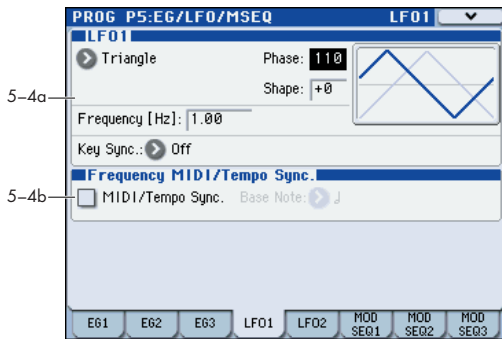

5-4(5)a: LFO 1, LFO2

Waveform

[Saw, Square, Square+, Triangle, Sine, S&H]

Selects the LFO waveform.

For LFO1 you can choose from Saw, Square, Triangle, and S/H.

For LFO2 you can choose from Saw, Square+, Sine, and S/H.

Phase (Initial Phase)

[000...180]

Specifies the starting position of the LFO waveform. This parameter is valid if **KeySync** is set to 1st Note or Each Note.

With a setting of 0, modulation will start from the “zero point” and begin ascending the positive portion of the LFO wave. A setting of 90 will begin at the highest point of the LFO wave.

With a setting of 180, modulation will start from the “zero point” and begin descending the negative portion of the LFO wave.

Shape

[-63...+63]

Modifies the shape of the waveform selected by **Waveform**. (See p.39 Fig. “LFO Waveform and Shape”)

Frequency [Hz]

[0.01...100.0Hz]

Specifies the frequency of the LFO. This is shown and can be edited if **TempoSync** is Off. Higher values will make the LFO faster.

Key Sync

[Off, 1st Note, Each Note]

Specifies whether the LFO will reset at each new note-on message.

Off: The phase of the LFO will not be reset when a note-on occurs.

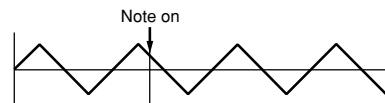

LFO Waveform and Shape

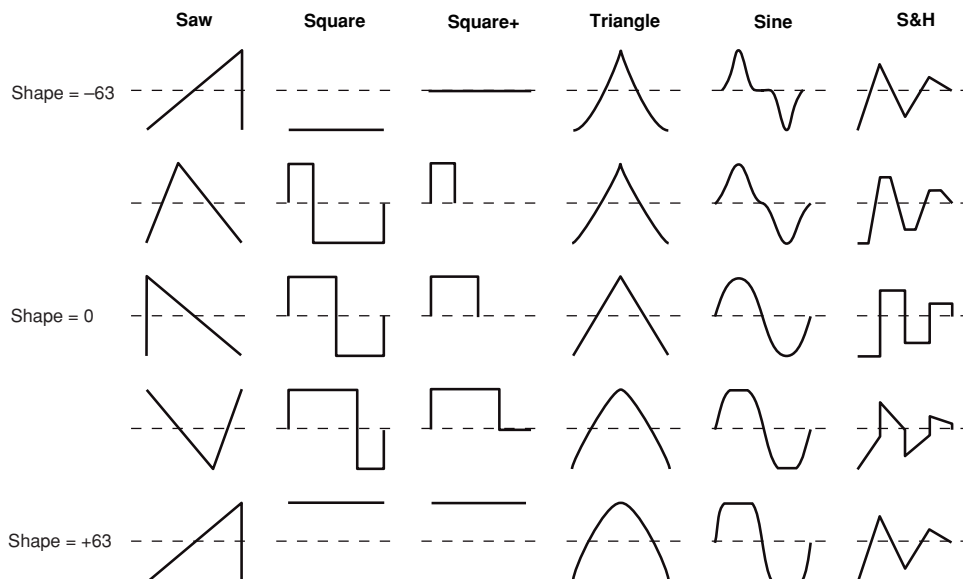

1st Note: The phase of the LFO will be reset at the first note-on that occurs when no other keys are being pressed, and will continue to affect all the notes played by that timbre in the same way, until once again no keys are being held down.

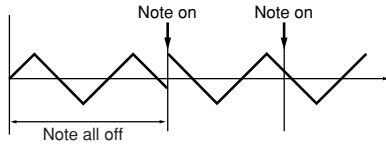

Each Note: The phase of the LFO will be reset for each individual note-on, and each voice will be modulated at an independent phase.

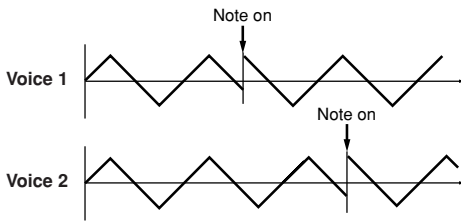

5-4(5)b: Frequency MIDI/Tempo Sync.

MIDI/Tempo Sync. [Off, On]

Specifies the LFO frequency. This lets you produce vibrato, wah, auto-pan, or tremolo effects that are synchronized to the modulation sequencer, KARMA, the internal sequencer, or an external sequencer.

On (checked): The LFO frequency will synchronize to the specified tempo (MIDI clock). Use the **Base Note** parameter below to specify the LFO speed. The **Frequency** setting is ignored.

Off (unchecked): The LFO speed will be determined by the **Frequency** setting, and will not be affected by the tempo setting.

 If **MIDI/Tempo Sync** is **On**, setting a virtual patch modulation destination (**Dst**) to **LFO1 (LFO1 Freq)** will have no effect.

Base Note (Sync. Base Note) [8/1... ♩]

Specifies the LFO frequency as a note value based on the tempo. This is shown and can be edited if **MIDI/Tempo Sync** is **On**.

Relative to the tempo, the length of the note value specified here will be one cycle of the LFO. For example if this is set to ♩ each cycle of the LFO will occupy one quarter note.

5-6: MSEQ1, 5-7: MSEQ2, 5-8: MSEQ3

Here you can make settings for the modulation sequencer. Here you can:

- Specify the number of steps, the type, and playback method for a modulation sequence.
- Select the parameter that will be modulated, and specify the value of each step.

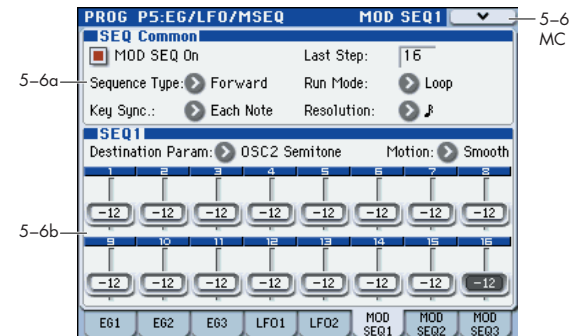

5-6(7)(8)a: SEQ Common

These parameters are common to SEQ1, SEQ2, and SEQ3.

MOD SEQ On (Modulation Sequencer On) [Off, On]

Switches the modulation sequencer on/off.

Last Step [01...16]

Specifies the length of the sequence in steps (i.e., the maximum number of steps).

Sequence Type [Forward, Reverse, Alt1, Alt2]

Specifies the sequence type (the direction in which the sequence will play).

Forward: Play from the first step (Step01).

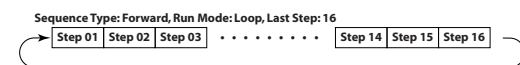

Reverse: Play from the last step (the step number specified by **Last Step**) in reverse.

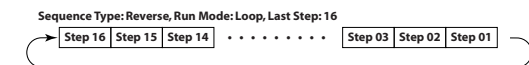

Alt1, Alt2: Alternately play in Forward and Reverse directions. Alt 1 immediately changes direction at the end points, so the first step and last steps are played only once per loop. Alt 2 plays the first step and the last step on both the way up and on the way down, so these steps will be played twice per loop.

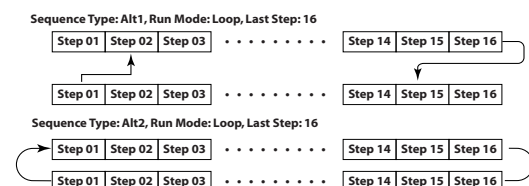

Run Mode [One Shot, Loop]

Specifies the loop setting for playback.

One Shot: The sequence will play for only one cycle, and will maintain the value of the last step.

Loop: The sequence will play as a loop, using the sequence type specified by **Seq Type**.

Key Sync. [Off, 1st Note, Each Note]

Specifies how the sequence will be reset when note-on occurs (i.e., when a key is played).

Off: The sequence will not be reset when note-on occurs.

1st Note: The sequence will be reset only by the first note-on that occurs from a state in which no keys are being played.

Each Note: The sequence will be reset by each note-on.

Note: When using the KARMA function to play a phrase, we recommend that you select Off or 1st Note. If you select Each Note, each note generated by the KARMA function will reset the sequence, and you may not obtain the desired effect. If you select 1st Note, the sequence will be reset each time you play the keyboard, and the sequence will be synchronized to the phrase generated by the KARMA function. In this case, if the phrase generated by the KARMA function consists of notes or is a phrase of non-overlapping single notes, or if **Thru In Z** (Program 7-1-1) is Off and notes are not being input from the keyboard, each note will cause a reset with the 1st Note setting, so there will be no modulation sequence effect. Thus, you should use the Off setting (see the illustration below).

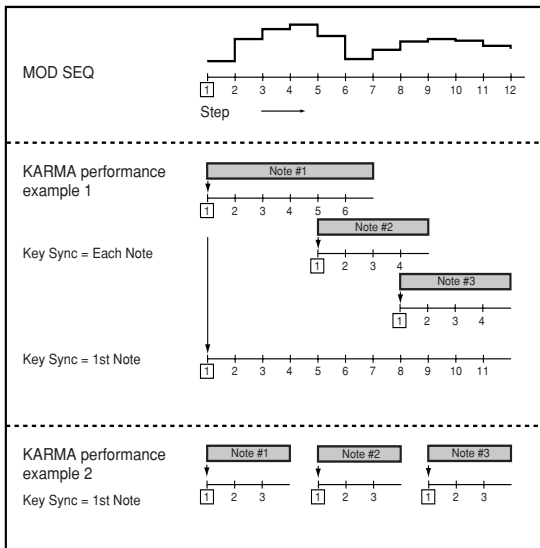

Resolution [1/8, 1/4, 1/2, 1, 2, 4]

Specifies the playback speed of the sequence relative to the tempo (MIDI clock). The sequence will advance by one step for each note value you specify here, relative to the tempo. For example if you set this to 1/4, the sequence will advance one step for each quarter note.

5-6(7)(8)b: SEQ1, SEQ2, SEQ3

Destination Param (Destination Parameter)

[None, Pitch...Patch8 Int.]

Selects the modulation sequence destination parameter.

None: The modulation sequence will do nothing.

Pitch: The modulation sequence will modify the overall pitch of the sounding oscillators over a range of ±24 semitones.

Other: The modulation sequence will modify the parameter assigned to a specific panel knob over a range of ±63 (±24 for OSC2 Sem).

Note: If you've specified the same parameter for more than one sequence, the setting of the higher-numbered sequence will be used, in the order of SEQ 3, SEQ 2, and SEQ 1.

Motion [Smooth, Step]

Specifies how the recorded values will change when the sequence is played

Smooth: The change will be continuous, with the values recorded at each step connected by straight lines.

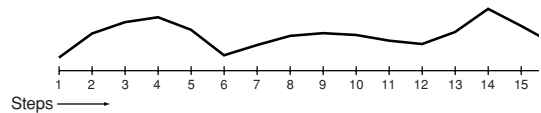

Note: If you set **Destination Param** to OSC1Ctrl2 (OSC1 Control 2) when **OSC1 Waveform** is set to DWGS, the operation will be the same as Step even if this parameter is set to **Smooth**.

Step: The value recorded at each step will be held until the next step plays.

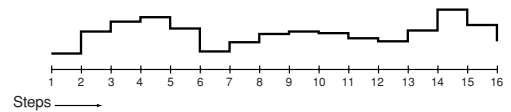

Step01...Step16

Step Value [-24...+24, -63...+63]

Specifies the value of the parameter that is assigned to the modulation sequence in each steps

The value specified here will be an offset applied to the current value of the parameter that is assigned to the modulation sequence. For example if the current value is +10, and the sequence data contains +10, +10, +20... starting at step 1, the resulting value of the parameter will change as +20, +20, +30... when playback begins.

▼ 5-6, 7, 8: Menu Command

- Initialize MOD SEQ p.45
- Copy MOD SEQ p.46

PROG P6: Vocoder

The EXB-RADIAS features a sophisticated vocoder that can be used not just to simulate the classic vocoder sounds of the past, but also to take advantage of advanced possibilities such as shifting the filter frequencies of each band or adjusting their level and panning to create new and original vocoder sounds.

The Formant Motion function uses filter banks to analyze the input signal (the modulator), and records up to seven seconds of formant motion data. By using the play back of this recorded formant motion data, you can create complex moving (or even “talking”) vocoder programs that don’t require any mic input.

Here you can:

- Turn the vocoder on/off, and record formant motion data.
- Edit the carrier parameters.
- Edit the modulator parameters.
- Edit the vocoder output parameters.
- Edit the bandpass filter of the carrier and the envelope follower of the modulator.

6-1: Carrier/Modulator

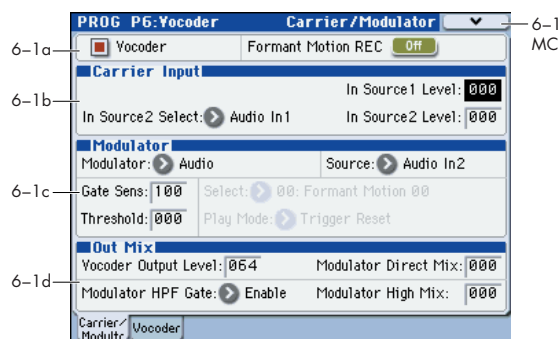

6-1a: Vocoder On/Off, Formant Motion REC On/Off

Vocoder (Vocoder On/Off) [Off, On]

Switches the vocoder function on/off.

On (checked): Vocoder function is on. The RADIAS program will use the vocoder.

Formant Motion REC [Off, On]

This records format motion data for use with the Formant Motion function.

6-1b: Carrier Input

These are the parameters that relate to the vocoder carrier signal.

You can input two sources to the carrier. Normally, you will raise **In Source 1 Level** so that the program’s oscillator output will be the input.

In Source 1 Level [000...127]

Sets the volume of input source 1 to the carrier. In Program mode, input source 1 is fixed as the mono-mixed signal of the amp section output (the signal before entering the EQ).

In Source 2 Select
[Audio In1, AUX Send L+R, AUX Send L, AUX Send R]

Selects input source 2.

Note: You must first assign the input source using the P1: Program Basic page Audio In (OSC & Vocoder) Source parameter.

For more information, please see “1-1c: AudioIn (OSC&Vocoder) Source” on page 26.

Audio In1: The signal of audio input 1 (L) specified by Audio Inputs (Send to RADIAS) (Program 1-1c), such as the AUDIO INPUT 1 jack.

AUX Send L+R: The mono-mixed signal of AUX buses 1+2 or 3+4 specified by Audio Inputs (Send to RADIAS) (Program 1-1c).

AUX Send L: The signal of AUX bus 1 or 3.

AUX Send R: The signal of AUX bus 2 or 4.

In Source 2 Level [000...127]

Sets the volume of input source 2.

6-1c: Modulator

These are the parameters for the modulator. The most popular way to use a vocoder is to use a voice as the modulator, creating the impression that an instrument is speaking.

Modulator (Modulator Select)
[Audio, Formant Motion]

This setting will affect the maximum number of voices.

Audio: The input source selected by **Source** will be the modulator.

Formant Motion: Formant motion data recorded by the formant motion function will be the modulator.

For details on recording formant motion data, please see “Formant Motion function,” on page 14.

Source (Audio Source)
[Audio In2, AUX Send L+R, AUX Send L, AUX Send R]

Selects the source that is input to the modulator.

Note: You must first assign the input source using the P1: Program Basic page Audio In (OSC & Vocoder) Source parameter (Program 1-1c).

For more information, please see “1-1c: AudioIn (OSC&Vocoder) Source” on page 26.

Audio In2: The signal of audio input 2 (R) specified by Audio Inputs (Send to RADIAS), such as the AUDIO INPUT 2 jack.

AUX Send L+R: The mono-mixed signal of AUX buses 1+2 or 3+4 specified by Audio Inputs (Send to RADIAS).

AUX Send L: The signal of AUX bus 1 or 3.

AUX Send R: The signal of AUX bus 2 or 4.

Gate S7ens (Gate Sensitivity) [000...127]

Specifies how fast the gate will respond to the input source.

Decreasing this setting will make the gate respond more quickly, and the vocoder sound will decay faster.

Increasing this setting will make the gate operate more slowly, and the vocoder sound will have a longer decay.

Note: Gate operation is affected by the **Threshold** setting. The effect will be more apparent if the **Threshold** value is high, and there will be no effect if the value is zero.

Threshold [000...127]

Sets the level at which the input source will be cut.

By setting this to an appropriate level you can cut the noise that might be present during times of no input.

Higher settings will make it more likely that the input source will be cut.

 With excessively high settings, there will be more chance that the audio input signal itself will be cut, making it difficult for you to apply the vocoder effect as intended.

Select (Formant Motion Select) [Formant Motion 00...Formant Motion 16]

Selects the formant motion data.

This is available for editing only if **Modulator** is set to **Formant Motion**.

 If you select other formant motion data without writing, any formant motion data you had been editing will be lost. (see "Writing formant motion data" on page 14)

Note: If you use the "To" field of the dialog box to change the data number when writing formant data, the Formant will also change to the number you specified in the dialog box. (see "Writing formant motion data" on page 14)

Play Mode (Formant Motion Play Mode) [Free Run, Trigger Reset]

Specifies how the formant motion data will be played back.

This is shown and can be edited if **Modulator** is set to **Formant Motion**.

Free Run: The formant motion data will play as a loop from the beginning to the end.

Trigger Reset: The formant motion data will play from the beginning to the end each time you press a note.

 The formant motion data can be triggered by the Global MIDI channel.

6-1d: Out Mix

Vocoder Output Level [000...127]

Sets the output level of the vocoder.

Modulator Direct Mix [000...127]

Sets the volume level at which the modulator input source will be output directly (unaffected).

Modulator HPF Gate [Disable, Enable]

If the high-frequency portion of the modulator is mixed into the output of the vocoder, this setting specifies whether this high-frequency portion will be output only while the internal sound generator is producing sound, or be output whenever there is an input to **Source**.

Disable: Even when the internal sound generator is not producing sound, the audio source being input to the modulator will be mixed into the output. For example if you're using a guitar connected to the AUDIO INPUT 1 jack as the carrier, you can use this setting so that the vocoder will be applied at all times even when you're not playing the keyboard. The input source to the modulator will always be output.

Enable: The audio source being input to the modulator will be mixed into the output only when the internal sound generator is producing sound. Normally, you will choose this setting if you're applying the vocoder to the internal sound generator being played from the keyboard, or if the output of an external synthesizer etc. connected to the AUDIO INPUT 1 jack is being input to the carrier, mixed with the internal sound generator, and processed by the vocoder.

Modulator High Mix [000...127]

Sets the level at which the high-frequency components of the input source will be mixed into the output of the vocoder. Higher settings will emphasize the consonants in your voice.

▼ 6-1: Menu Command

- Write Formant Motion Data ^{see}p.46
- Copy Vocoder ^{see}p.46

6-2: Vocoder

Here you can edit the parameters for all the band pass filters of the carrier, and the envelope follower of the modulator.

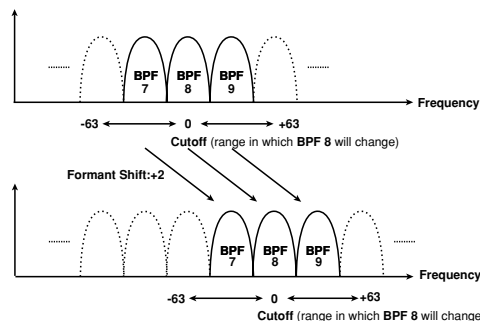
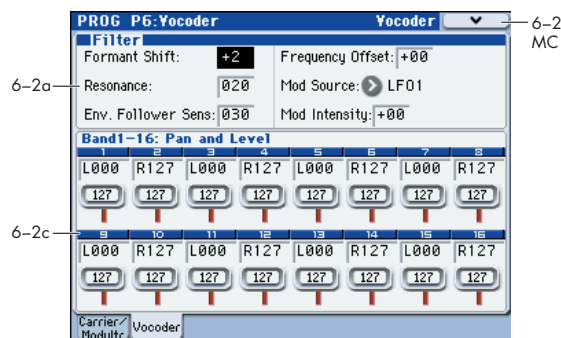

6-2a: Filter

Formant Shift [-2...+2]

Shifts the cutoff frequencies of each of the carrier's band pass filters. This will significantly change the character of the vocoder output.

Resonance [000...127]

Sets the amount of resonance for each band pass filter. Higher values will boost the region near the cutoff frequency.

Env. Follower Sens (Envelope Follower Sensitivity) [000...127]

Sets the envelope follower sensitivity for the modulator. Lower values will allow the rise and fall of the input signal specified by **Source** (Program 6-1c) to be detected more quickly.

Higher values will produce slower change, creating a sound with a slow attack and a long release. With a setting of 127, the tonal response of the first signal that is input will be held, and the sound will continue with this character regardless of whether there is an input signal.

If you set this to a value of 127 when there is no input, there will be no output even if you subsequently input an audio signal.

Frequency Offset [-63...+63]

Adjusts the cutoff frequency of each of the carrier's band pass filters.

How Formant Shift and Frequency Offset are related

When **Formant Shift=0** and **Frequency Offset=0**, the response of the carrier filters will match the cutoff frequency of the modulator filters. The filter response is shifted upward or downward in two discrete steps by the **Formant Shift**. This can be adjusted upward or downward another two steps by using **Frequency Offset**, giving you a total of four steps of adjustment upward or downward.

Mod Source (Fc Modulation Source)

[EG1...X-Y -Y Mod:#88]

Selects the modulation source that will be applied to **Frequency Offset**. The available modulation sources are the same as the modulation sources for program parameter virtual patches. (See "Src (Source)" on page 28)

Mod Intensity (Fc Modulation Intensity)

[-63...+63]

Sets the depth of modulation that is applied to **Frequency Offset**.

6-2b: Band1-16: Pan and Level

Selects the filter whose output level or panning you will edit.

Band1...Band16

Pan [L001...C064...R127]

Sets the panning of the filter.

Level [000...127]

Sets the output level of the filter.

▼ 6-2: Menu Command

- Write Formant Motion Data p.46
- Copy Vocoder p.46

PROG P7: KARMA

Here you can make KARMA function settings for the RADIAS program.

For details on the available parameters and menu commands, please see "PROG P7: KARMA" on page 45 of the M3 parameter guide.

PROG P8: IFX

Here you can make settings for the insert effects.

You can use insert effects for RADIAS programs in the same way as for EDS programs.

For details on the available parameters and menu commands, please see "PROG P8: IFX" on page 45 of the M3 parameter guide.

PROG P9: MFX/TFX

Here you can make settings for the master effects and total effects.

You can use insert effects for RADIAS programs in the same way as for EDS programs.

For details on the available parameters and menu commands, please see "PROG P9: MFX/TFX" on page 45 of the M3 parameter guide.

Menu Command

The menu commands explained here are those that are displayed and available only if the EXB-RADIAS is installed.

For details on the other commands, refer to the "M3 parameter guide."

Initialize MOD SEQ

This command initializes the modulation sequence settings.

1. Choose "Initialize MOD SEQ" to access the dialog box.

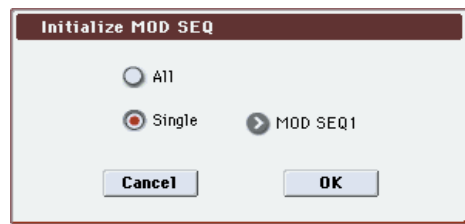

2. Select the modulation sequence that you want to initialize.

All: All modulation sequences 1–3 will be initialized. The following parameters will be initialized.

Last Step (Program 5–6(7)(8)a): **16**

Sequence Type (Program 5–6(7)(8)a): **Forward**

Run Mode (Program 5–6(7)(8)a): **Loop**

KeySync (Program 5–6(7)(8)a): **1st Note**

Resolution (Program 5–6(7)(8)a): **♪**

Destination Param (Program 5–6(7)(8)b): **Pitch**

Motion (Program 5–6(7)(8)b): **Smooth**

Step Value (Program 5–6(7)(8)b): **0**

Single: One modulation sequence will be initialized. You can specify the modulation sequence that you want to initialize. The following parameters of the specified modulation sequence will be initialized.

Destination Param (Program 5–6(7)(8)b): **None**

Motion (Program 5–6(7)(8)b): **Smooth**

Step Value (Program 5–6(7)(8)b): **0**

3. Press the OK button to execute the initialization. If you decide not to execute, press the Cancel button.

Copy MOD SEQ

This command copies modulation sequence settings from another RADIAS program to the currently selected RADIAS program.

1. Choose “Copy MOD SEQ” to access the dialog box.

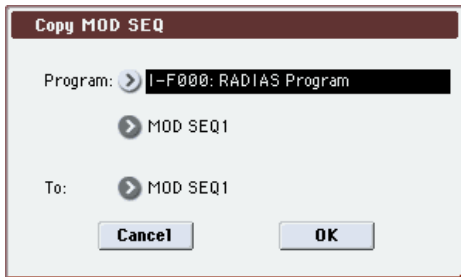

2. Use the “Program” field to choose the copy-source program and modulation sequence.

Choose the program in the upper line, and in the lower line choose the modulation sequence that you want to copy.

⚠ When selecting a program, you’ll only be able to select from bank INT-F and user program banks whose bank type is set to RADIAS.

3. Use the “To” field to select the copy-destination modulation sequence.
4. Press the OK button to execute the copy. If you decide not to execute, press the Cancel button.

Write Formant Motion Data

This command saves your recorded formant motion data into internal memory.

⚠ Be sure to save important data that you want to keep. Formant motion data you’ve recorded will be lost if you select other formant motion data or turn off the power before you’ve saved it.

1. Choose “Write Formant Motion Data” to access the dialog box.

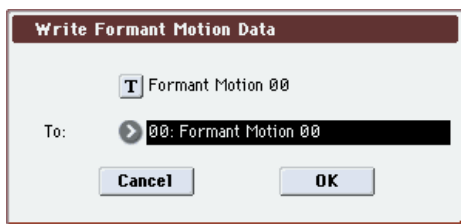

2. The upper line shows the formant motion name.

If you want to change the formant motion name, press the text edit button to access the text edit dialog box, and enter the desired name.

3. In the “To” field, select the save-destination.
4. Press the OK button to write the formant motion data. If you decide not to execute, press the Cancel button.

⚠ If you want to save the formant motion data you recorded, you must write it. If you perform any of the following actions before writing it, the formant motion data you recorded will be lost.

- Select other formant motion data.
- Select another program.
- Turn off the power.
- Receive a MIDI dump of the corresponding data from an external connected device.

Copy Vocoder

This command copies the vocoder setting from the specified program, combination, or song into the currently selected RADIAS program.

1. Choose “Copy Vocoder” to access the dialog box.

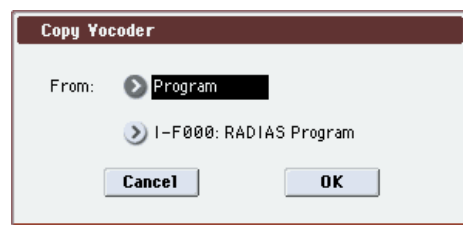

2. In the “From” field, choose the copy-source.

Select the mode in the upper line, and in the lower line select the program, combination, or song.

⚠ When selecting a program, you’ll only be able to select from bank INT-F and user program banks whose bank type is set to RADIAS.

⚠ The settings will not change if you execute this command after selecting a combination or song that does not use a RADIAS program.

3. Press the OK button to execute the copy. If you decide not to execute, press the Cancel button.

Combination mode

Combi Page Select

For details on how to select each page, refer to the “M3 operation guide.”

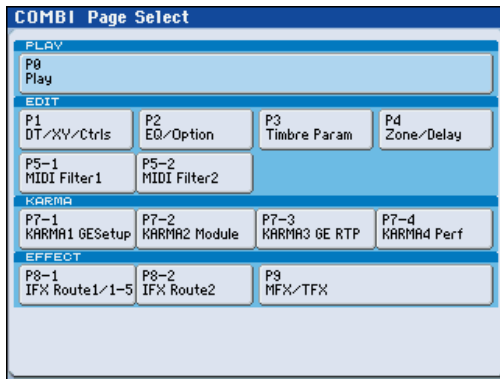

| | Page | Main content |
|----------------------|-----------------------|---|
| PLAY | P0: Play | Select and play combinations. Program selection for each timbre. Pan and volume settings etc. for each timbre. Simple KARMA editing. Audio input settings and resampling settings. Editing from the control surface. (☞M3 PG p.120) |
| | P1: DT/X-Y/Ctrls | Drum track settings. X-Y control settings. SW1, 2, and slider function settings. Pad note and velocity settings (☞M3 PG p.138) |
| EDIT | P2: EQ/Option | EQ settings for each timbre. (☞M3 PG p.147) Settings for the EXB-RADIAS option. (☞p.50) |
| | P3: Timbre Param | Various parameter settings for each timbre (MIDI channel, OSC selection, Pitch setting, etc.) (☞M3 PG p.149) |
| | P4: Zone/Delay | Key split and layer settings. (Key zone and velocity zone) Time delay from note-on to beginning of sound. (☞M3 PG p.153) |
| | P5-1: MIDI Filter 1 | MIDI transmit/receive filter 1 settings. (☞M3 PG p.157) |
| | P5-2: MIDI Filter 2 | MIDI transmit/receive filter 2 settings. (☞M3 PG p.160) |
| | KARMA | P7-1: KARMA1- GE |
| P7-2: KARMA2- Module | | Settings for each KARMA module. (☞M3 PG p.169) |
| P7-3: KARMA3- GE RTP | | KARMA GE realtime parameter settings. (☞M3 PG p.171) |
| P7-4: KARMA4- Perf | | KARMA performance parameter settings. (☞M3 PG p.173) |
| EFFECT | P8-1: IFX Route1/ 1-5 | Oscillator output bus and master effect send level settings. Insert effect routing, selection, and settings. (☞M3 PG p.177) |
| | P8-2: IFX Route2 | Bus settings for oscillator output. Common FX LFO 1, 2 settings (☞M3 PG p.181) |
| | P9: MFX/TFX | Master effect routing, selection, and settings. Total effect selection and settings. (☞M3 PG p.183) |

COMBI P0: Play

In this page you can select and play combinations.

In Combination mode, you can use four RADIAS programs.

0-1: Program T01-08, 0-2: Program T09-16

Here you can specify the program, Play/Mute, and Solo On/off settings for timbres 1-8 and 9-16.

For details on selecting combinations, selecting programs, the editable parameters, and the display, refer to the M3 operation guide and parameter guide.

R (EXB-RADIAS)

Timbres for which a RADIAS program can be used are indicated by “”. If you select a program from bank INT-F etc. for a timbre indicated by “”, a RADIAS program played by the EXB-RADIAS will sound.

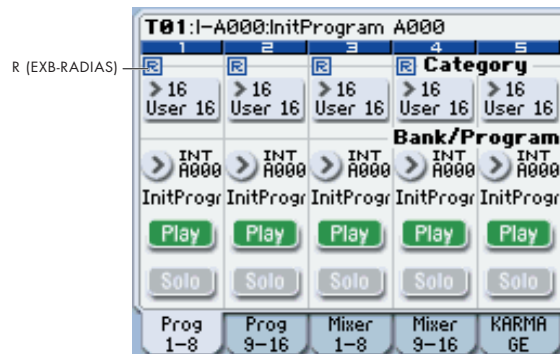

Use the **ENABLE RADIAS** setting to specify the timbres for which a RADIAS program can be used. (☞ “Enable RADIAS” on page 50)

Note: You can turn on **Enable RADIAS** for up to four timbres. Even if you select a RADIAS program for a timbre whose **ENABLE RADIAS** setting is turned **off**, it will not sound.

0-3: Mixer T01-08, 0-4: Mixer T09-16

Here you can adjust the volume and pan settings for Timbres 1-16.

For details on the available parameters and menu commands, please see “0-3: Mixer T01-08, 0-4: Mixer T09-16” on page 123 of the M3 parameter guide.

0-5: KARMA GE

Here you can make KARMA function settings for the Combination mode.

In Combination mode you can use four KARMA Modules (Modules [A], [B], [C], and [D]).

For details on the available parameters and menu commands, please see “0-5: KARMA GE” on page 125 of the M3 parameter guide.

0-6: KARMA RTC

Here you can view the names and the stored parameter values for the KARMA Sliders 1-8 and KARMA switches 1-8. When you operate these, the screen will show the number and value of the GE realtime parameters and performance realtime parameters being controlled.

For details on the available parameters and menu commands, please see “0-6: KARMA RTC” on page 126 of the M3 parameter guide.

0-7: Sampling/Audio In

Here you can adjust the settings for the analog/digital audio signal input (AUDIO INPUT, S/P DIF), and the sampling-related settings for Combination mode.

As in Program mode, sampling in Combination mode allows you to sample an incoming audio signal or to sample a M3 performance. The M3 can also be used as a 4-in 6-out effect processor.

For details on the available parameters and menu commands, please see “0-7: Sampling/Audio In” on page 128 of the M3 parameter guide.

0-8: Control Surface

The Control Surface is the set of 8 sliders and 8 switches to the left of the display. It looks like a mixer, but it can do other things as well, including editing sounds, controlling KARMA, and sending MIDI messages to external devices.

This page shows you the current values for each of the sliders, knobs, and buttons, along with information about what they are controlling. For instance, you can:

- Adjust the volume and pan for all 16 Timbres
- Control each Timbre’s EQ settings and Master Effects Send levels.
- Modulate sounds and effects using the Real Time Knobs.
- Control KARMA, and select KARMA scenes, using the sliders and switches.
- Edit sounds using Tone Adjust.
- Assign sliders, knobs, and switches to different Tone Adjust parameters.

For details on the control surface, please see “0-8: Control Surface” on page 130 of the M3 parameter guide.

In Combi mode, you can select one of five different functions:

MIXER (Mixer T1-8, T9-16): This lets you use the control surface to adjust the volume of timbres 1-16, and switch the Play/Mute and Solo On/Off status. (In Combination mode and Sequencer mode, you can use this switch to alternate between timbres or tracks 1-8 and 9-16.)

MIXER (Mixer Input): The control surface will control the audio input volume, Play/Mute and Solo On/Off status of the analog inputs, S/P DIF inputs, and FireWire inputs (if the EXB-FW is installed).

REALTIME CONTROL (RT Control): Use the sliders to control the sound or effects. Use the switches to turn effects on/off.

EXTERNAL lets you send MIDI messages to external MIDI devices. Use the GLOBAL P1: MIDI- External Mode 1/2 page to specify the MIDI message that will be transmitted.

TONE ADJUST lets you edit Programs within the context of the Combi, and without making any changes to the original Program data. You also get hands-on access to these edits, using the sliders, and switches.

KARMA: Use the sliders and switches to control the KARMA function.

You can freely change back and forth between the different functions, without losing any of your edits.

Tone Adjust

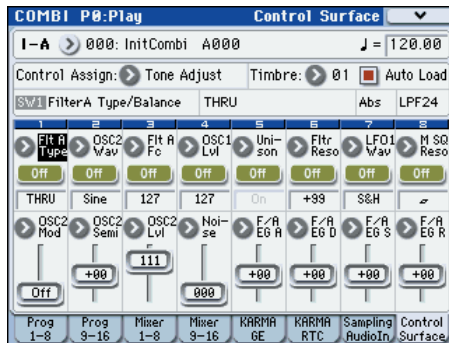

COMBI P1: DT/X-Y/Ctrls

Here you can select a pattern for the drum track and make settings for it, as well as make settings for X-Y control and pads 1-8.

For details on the available parameters and menu commands, please see “COMBI P1: DT/XY/Ctrls” on page 138 of the M3 parameter guide.

0-8g: Tone Adjust

For details on the Tone Adjust function, refer to “M3 parameter guide.”

Common Tone Adjust Parameters

These are the same as the Common Tone Adjust Parameters in Program mode.

For more information, please see “Common Tone Adjust Parameters” on page 22.

RADIUS Tone Adjust Parameters

These are the same as the RADIUS Tone Adjust Parameters in Program mode.

For more information, please see “RADIUS Tone Adjust Parameters” on page 23.

COMBI P2: EQ / Option

2-1: EQ Trim T01-08, 2-2: EQ Trim T09-16

Here you can adjust the volume level going into the EQ.

For details on the available parameters and menu commands, please see "2-1: EQ Trim T01-08, 2-2: EQ Trim T09-16" on page 147 of the M3 parameter guide.

2-3: EQ Gain T01-08, 2-4: EQ Gain T09-16

Here you can make the Mid sweep EQ settings for Timbres 1-16.

For details on the available parameters and menu commands, please see "2-3: EQ Gain T01-08, 2-4: EQ Gain T09-16" on page 148 of the M3 parameter guide.

2-5: RADIAS T01-08, 2-6: RADIAS T09-16

Here you can make settings that specify how RADIAS programs will sound and how the audio will be routed.

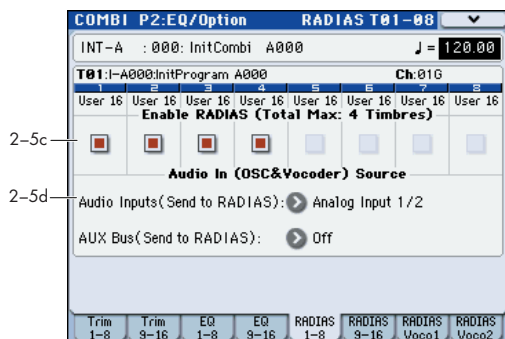

2-5(6)c: Enable RADIAS (Total Max: 4 Timbres)

Enable RADIAS [Off, On]

This specifies whether a RADIAS program selected in **Program Select** will sound. Up to four RADIAS programs can be sounded in one combination.

On (checked): The RADIAS program selected in **Program Select** will sound. Turn this setting on for each timbre in which you want to use a RADIAS program. You can turn this on for up to four timbres. Timbres for which this is on will show the "  " indication. (☞ "R (EXB-RADIAS)" on page 47)

Note: You can turn **Enable RADIAS** on for up to four timbres. Timbres for which this is off (unchecked) will not sound.

Off (unchecked): Even if a RADIAS program is selected in **Program Select**, it will not sound.

⚠ If you used a timbre bank/program change to switch to a RADIAS program from something other than a RADIAS program, the RADIAS program will not sound if this setting is off for the corresponding timbre. You must turn this on beforehand for timbres in which you intend to use a RADIAS program.

2-5(6)d: Audio In (OSC&Vocoder) Source

Audio Inputs (Send to RADIAS)

[Off, S/PDIF L/R, FireWire L/R]

Here you can select the audio input that will be the input source to the EXB-RADIAS. (☞ "AUX Bus (Send to RADIAS)" on page 26)

Analog Input 1/2: The signal coming directly from the AUDIO INPUT 1,2 jacks will be the input source. The input from the AUDIO INPUT 1 jack will be input to the L-channel of the oscillator, and the input from the AUDIO INPUT 2 jack to the R-channel.

S/P DIF L/R: The signal coming directly from the S/P DIF connector will be the input source.

FireWire L/R: This can be selected if the optional EXB-FW is installed. The input signal directly from the FireWire connector will be the input source.

Note: If the P1-1: Basic Program page **Unison** parameter of the RADIAS program used by the timbre is Off, the input will be mixed to monaural.

For more information, see the diagram "Combination Audio In (OSC&Vocoder) Source" on 51 page.

AUX Bus (Send to RADIAS) [Off, AUX 1/2, AUX 3/4]

This selects the AUX buses that will be the input source to the EXB-RADIAS.

AUX 1/2: The signal from AUX1 and AUX2 will be the input source.

AUX 3/4: The signal from AUX3 and AUX4 will be the input source.

Note: If you want the AUX bus signal to be input to the EXB-RADIAS, you should first use the P8-2-1(2): Routing2, AUX/FX Control Bus parameter **AUX Bus** to select the post-IFX AUX. This allows you to route the timbre of an EDS program via the AUX bus to an EXB-RADIAS oscillator or vocoder.

⚠ If you send the post-IFX RADIAS oscillator output via the AUX bus back into the same RADIAS oscillator or vocoder, a feedback loop will be created. If this occurs, the input signal will automatically be cut internally to prevent a loop from occurring. Please be aware that if this occurs, there will be no sound.

For more information, see the diagram "Combination Audio In (OSC&Vocoder) Source" on 51 page.

Combination Audio In (OSC&Vocoder) Source

An example of using the AUX bus to input an EDS program into the RADIUS vocoder:

- The RADIUS program of timbre 1 is input to the carrier of the vocoder.
- The EDS program of timbre 2 is sent via the AUX bus to the carrier of the vocoder.
- The mic connected to the AUDIO INPUT 2 jack is sent to the modulator of the vocoder.

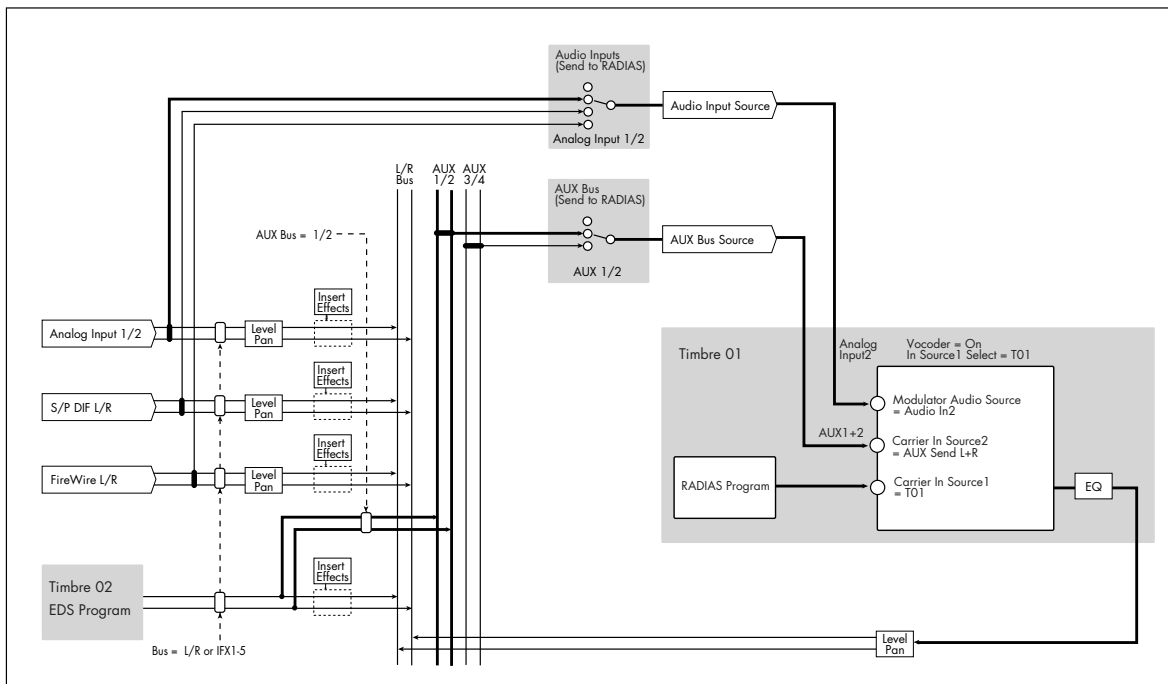

An example of using the AUX bus to input an EDS program and mic input to the RADIUS vocoder’s carrier and modulator:

- The RADIUS program of timbre 1 is input to the carrier of the vocoder.
- The EDS program of timbre 2 is input via AUX bus 2 (mono) to the carrier of the vocoder.
- The mic connected to the AUDIO INPUT2 jack is processed by an insert effect, and sent via AUX bus 1 (mono) to the modulator of the vocoder.

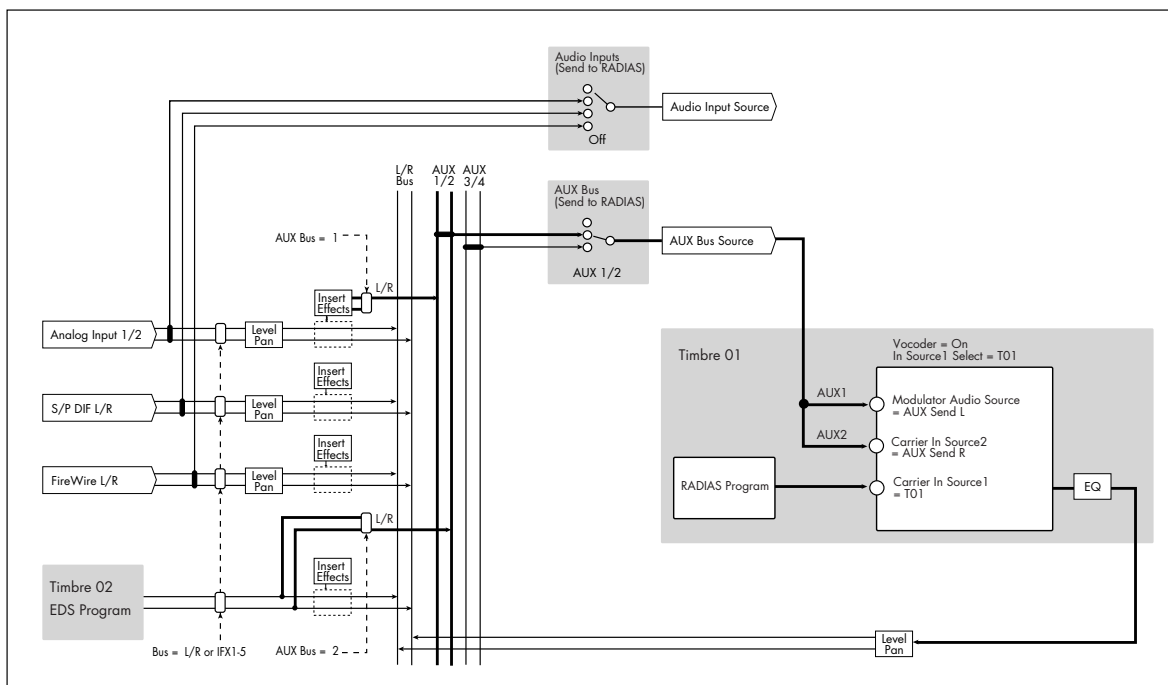

2-7: RADIUS Vocoder1

Here you can make vocoder-related settings for the combination.

⚠ Only one instance of the vocoder function can be used in each combination. It can be used on only one timbre. Even if you've selected a RADIUS vocoder program in four timbres, it is not the case that all four vocoders will operate.

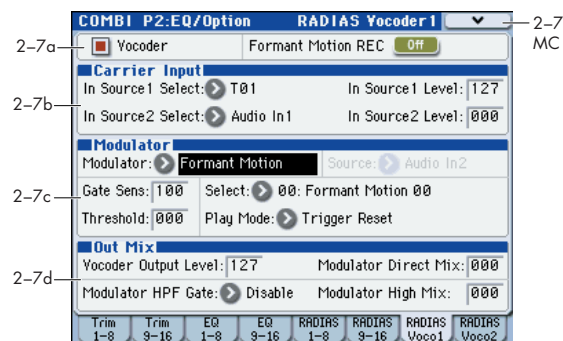

2-7a: Vocoder On/Off, Formant Motion REC On/Off

Vocoder [Off, On]

Formant Motion REC [Off, On]

For details on these parameters, please see "6-1a: Vocoder On/Off, Formant Motion REC On/Off" on page 42.

2-7b: Carrier Input

In Source 1 Select [Off, T01...T16]

This selects the timbre of the RADIUS program that will be the input source to the carrier. Timbres whose **Enable RADIUS** is on can be selected as input sources.

⚠ There will be no input if the program (P0: Play Program) of the timbre you select here is not a RADIUS program. If you want the input to the carrier to be a timbre that's not using a RADIUS program, or a timbre other than the one selected here, you should use the AUX bus. (☞ "AUX Bus (Send to RADIUS)" on page 50)

For more information, see the diagram "Combination Audio In (OSC&Vocoder) Source" on 51 page.

In Source 1 Level [000...127]

In Source 2 Select
[Audio In1, AUX Send L+R, AUX Send L, AUX Send R]

In Source 2 Level [000...127]

For details on these parameters, please see "6-1b: Carrier Input" on page 42.

2-7c: Modulator

Modulator (Modulator Select)
[Audio, Formant Motion]

Source (Audio Source)
[Audio In2, AUX Send L+R, AUX Send L, AUX Send R]

Gate Sens (Gate Sensitivity) [000...127]

Threshold [000...127]

Select (Formant Motion Select)
[Formant Motion 00...Formant Motion 16]

Play Mode (Formant Motion Play Mode)
[Free Run, Trigger Reset]

For details on these parameters, please see "6-1c: Modulator" on page 42.

2-7d: Out Mix

Vocoder Output Level [000...127]

Modulator Direct Mix [000...127]

Modulator HPF Gate [Disable, Enable]

Modulator High Mix [000...127]

For details on these parameters, please see "6-1d: Out Mix" on page 43.

▼ 2-7: Menu Command

- Write Formant Motion Data ☞p.56
- Copy Vocoder ☞p.56

2-8: RADIAS Vocoder2

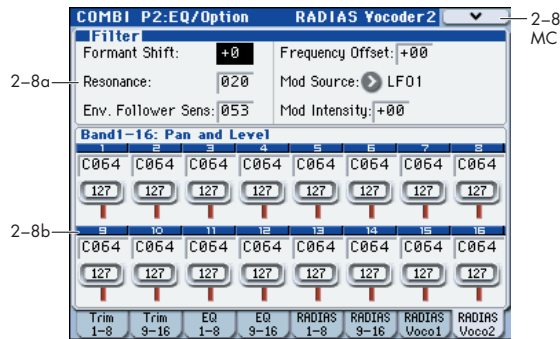

2-8a: Filter

| | |
|---|-------------------------------|
| Formant Shift | [-2...+2] |
| Resonance | [000...127] |
| Env. Follower Sens (Envelope Follower Sensitivity) | [000...127] |
| Frequency Offset | [-63...+63] |
| Mod Source (Fc Modulation Source) | [EG1...X-Y -Y Mod:#88] |
| Mod Intensity (Fc Modulation Intensity) | [-63...+63] |

For details on these parameters, please see “6-2a: Filter” on page 44.

2-8b: Band1-16: Pan and Level

Band1...Band16

| | |
|--------------|-----------------------------|
| Pan | [L000...C064...R127] |
| Level | [000...127] |

For details on these parameters, please see “6-2b: Band1-16: Pan and Level” on page 44.

▼ 2-8: Menu Command

- Write Formant Motion Data p.56
- Copy Vocoder p.56

COMBI P3: Timbre Parameters

3-1: MIDI T01-08, 3-2: MIDI T09-16

Here you can make MIDI settings for each timbre 1-16. For details on the available parameters and menu commands, please see “3-1: MIDI T01-08, 3-2: MIDI T09-16” on page 149 of the M3 parameter guide.

3-3: OSC T01-08, 3-4: OSC T09-16

These settings specify how each timbre will be played.

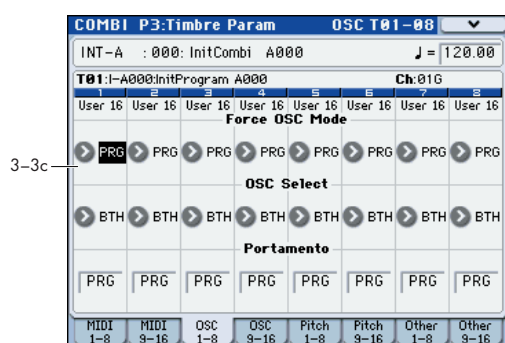

3-3c: OSC

Timbre 01... 16 (Timbre Number):

Force OSC Mode [PRG, Poly, MN, LGT]

Specifies the Voice Assign Mode (Program 1-1a) of the RADIUS program selected

PRG: The Voice Assign Mode (p.25) settings of the RADIUS program will be used.

Poly: The timbre will play polyphonically, regardless of the settings of the RADIUS program.

MN (Mono): The timbre will play using a Voice Assign Mode of Mono and a Trigger Mode of Multi, regardless of the settings of the RADIUS program.

LGT (Legato): The timbre will play using a Voice Assign Mode of Mono and a Trigger Mode of Single (p.25), regardless of the settings of the RADIUS program.

If you've selected MN or LGT, the note priority order when you play two or more keys will be according to the Priority (Program 1-1a) setting of the program.

OSC Select [BTH, OS1, OS2]

This has no effect for RADIUS programs used by a timbre. For more information, please see “OSC Select” on page 54 of the M3 parameter guide.

Portamento [PRG, Off, 001...127]

Specifies the portamento for the RADIUS program used by the timbre.

PRG: Portamento will be applied as specified by the program settings.

Off: Portamento will be off, even if the original program settings specified for it to be on.

001...127: Portamento will be applied with the portamento time you specify here, even if it is turned off by the program settings

MIDI If the Status (Combination 3-1a) is set to INT, CC#05 (portamento time) message will be received and will control and change these settings. These messages will be received on the MIDI channel specified for each timbre by MIDI Channel (Combination 2-1a).

3-5: Pitch T01-08, 3-6: Pitch T09-16

Here you can make pitch-related settings for each timbre 1-16.

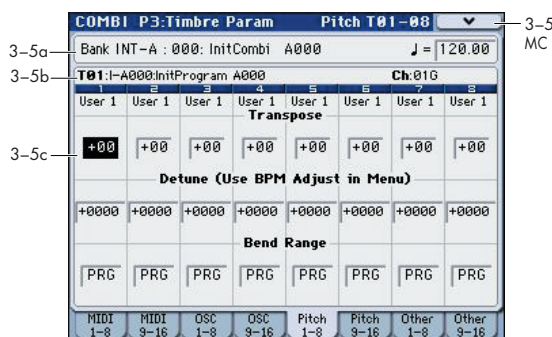

3-5(6)a: Combination Name, Tempo 3-5(6)b: Timbre Info

For details on these parameters, please see “3-5(6)a: Combination Name, Tempo 3-5(6)b: Timbre Info” on page 151 of the M3 parameter guide.

3-5(6)c: Pitch

Timbre 01 (Timbre Number):

Transpose [-60...+00...+60]

Adjusts the pitch in semitone steps for the RADIUS program used by the timbre. A setting of +12 is one octave.

The actual pitch sounded by the program is determined by adding this value to the Transpose setting (Program 2-2a) of the RADIUS program used by the timbre. However, a RADIUS program cannot be transposed farther than +/-48. Values below -48 are treated as -48, and values above +48 are treated as +48.

For more information, please see “Transpose” on page 151 of the M3 parameter guide.

Detune (Use BPM Adjust in Menu) [-1200...+0000...+1200]

Adjusts the pitch in one-cent units from the normal pitch for the RADIUS program used by the timbre.

The actual pitch sounded by the program is determined by adding this value to the Tune (cents) setting (Program 2-2a)

of the RADIAS program used by the timbre. However, a RADIAS program cannot be detuned farther than +/-50 cents. Values below -50 are treated as -50, and values above +50 are treated as +50.

For more information, please see “Detune (Use BPM Adjust in Menu)” on page 151 of the M3 parameter guide.

Bend Range [PRG, -24...+00...+24]

Specifies the amount of pitch change that will occur when the pitch bender is operated, in semitone units.

PRG: The pitch range specified by the program will be used.

-24...+24: This setting will be used regardless of the setting in the program.

The actual bend range is determined by adding this value to the **Bend Range** (Program 2-2a) of the RADIAS program used by the timbre. However, a RADIAS program cannot have a bend range greater than +/-12. Values below -12 are treated as -12, and values above +12 are treated as +12.

Timbre 02...08, 09...16 (Timbre Number):

Here you can make pitch-related settings for each timbre 2–16. The settings are the same as for timbre 1. See “Timbre 01 (Timbre Number)”.

3-7: Other T01-08, 3-8: Other T09-16

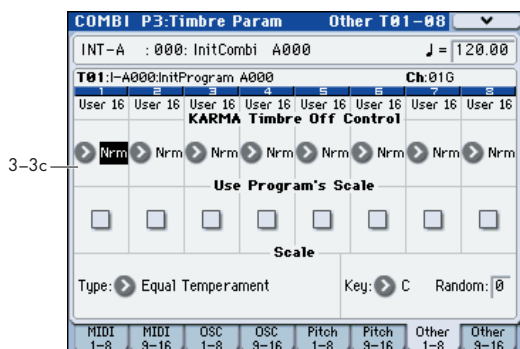

3-7(8)c: KARMA/Scale

Timbre 01...16 (Timbre Number):

KARMA Timbre Off Control

[Normal, Timbre Off by KARMA Off, Timbre Off by KARMA On]

Use Program's Scale [Off, On]

For details on these parameters, please see “3-7(8)c: KARMA/Scale” on page 152 of the M3 parameter guide.

Scale:

Specifies the scale that the combination will use.

Type (Combi's Scale)

[Equal Temperament...User Octave Scale15]

Selects the scale.

If you select a scale that cannot be specified for a RADIAS program, such as Stretch, User All Notes Scale, or User Octave Scale 01–15, the program will play using Equal Temperament.

Key [C...B]

Random [0...7]

For more information, please see “3-7(8)c: KARMA/Scale” on page 152 of the M3 parameter guide.

COMBI P4: Zone/Delay

Here you can specify the key range and velocity range for which timbres 1–8 and 9–16 will sound, and specify the delay time until the sound will be heard.

For details on the available parameters and menu commands, please see “COMBI P4: Zone/Delay” on page 153 of the M3 parameter guide.

The Keyboard Zones / Velocity Zones “Top Slope” and “Bottom Slope” settings will have no effect for RADIAS program.

COMBI P5: MIDI Filter

These settings allow you to apply filters to the MIDI data that will be transmitted and received by each timbre 1–16.

For details on the available parameters and menu commands, please see “COMBI P5: MIDI Filter” on page 157 of the M3 parameter guide.

COMBI P7: KARMA

Here you can make KARMA function settings for the Combination mode.

For details on the available parameters and menu commands, please see “COMBI P7: KARMA” on page 161 of the M3 parameter guide.

COMBI P8: IFX (Insert Effects)

Here you can specify the bus and insert effect for timbres 1–16.

For details on the available parameters and menu commands, please see “COMBI P8: IFX (Insert Effect)” on page 177 of the M3 parameter guide.

COMBI P9: MFX/TFX (Master/Total Effects)

Here you can make settings for the master effects and total effects.

For details on the available parameters and menu commands, please see “COMBI P9: MFX/TFX (Master/Total Effect)” on page 183 of the M3 parameter guide.

Menu Command

The menu commands explained here are the commands that are displayed and available if the EXB-RADIAS option is installed.

For details on other commands, refer to the “M3 parameter guide.”

Copy from Program

This command copies settings from a specified program to the currently selected combination. If you select a RADIAS program from the INT-F bank etc. as the copy-source, the **RADIAS Vocoder** check box in the dialog box will be enabled.

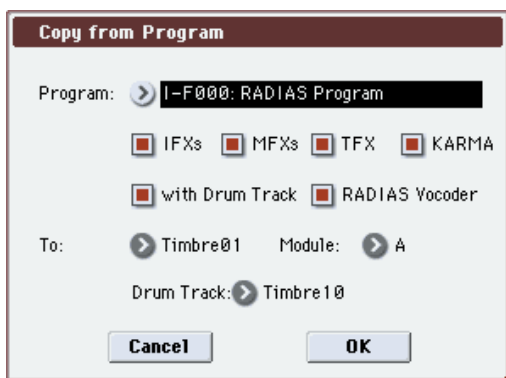

If you check **RADIAS Vocoder** and execute the copy, the vocoder parameter settings of the copy-source RADIAS program will also be copied.

⚠ This is invalid if you've selected an EDS program as the copy-source.

For the procedure and other settings, please see “Copy from Program” on page 185 of the M3 parameter guide.

Write Formant Motion Data

This command saves the recorded formant motion data into internal memory. If you turn off the power before saving formant motion data you've recorded, the data cannot be recovered.

For the procedure, please see “Write Formant Motion Data,” on page 46.

Copy Vocoder

This command copies the vocoder settings from a specified program, combination, or song to the currently selected combination.

For the procedure, please see “Copy Vocoder,” on page 46.

Sequencer mode

For details on how to select each page, refer to the “M3 operation guide.”

SEQ Page Select

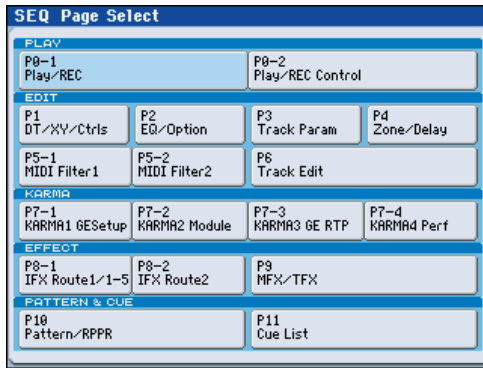

| | Page | Main content |
|-------------|-------------------|--|
| EFFECT | P8-1:IFX-Routing1 | Oscillator output bus and master effect send level settings. Insert effect routing, selection, and settings. (M3 PG p.257) |
| | P8-2:IFX-Routing2 | Bus settings for oscillator output. Common FX LFO 1, 2 settings (M3 PG p.261) |
| | P9: MFX/TFX | Master effect routing, selection, and settings. Total effect selection and settings. (M3 PG p.263) |
| PATTERN&CUE | P10: Pattern/RPPR | Pattern recording and editing. RPPR settings. Converting a pattern to a drum track pattern. (M3 PG p.265) |
| | P11: Cue List | Cue list settings. Consecutive playback of multiple songs. Converting to a song. (M3 PG p.269) |

| | Page | Main content |
|-------|------------------------|---|
| PLAY | P0-1: Play/REC | Song selection, playback, and recording. Program selection for each track. Pan and volume settings etc. for each track. Track playback loop settings. Audio input settings and resampling settings. Recording method selection. (M3 PG p.195) |
| | P0-2: Play/REC Control | Simple KARMA editing. Editing from the control surface. (M3 PG p.205) |
| EDIT | P1: DT/X-Y/Ctrls | Drum track settings. X-Y control settings. SW1, 2, and slider function settings. Pad note and velocity settings. (M3 PG p.215) |
| | P2: EQ/Option | EQ settings for each track. (M3 PG p.224) Settings for the EXB-RADIAS option. (p.60) |
| | P3: Track Param | Various parameter settings for each track (MIDI channel, OSC selection, Pitch setting, etc.) (M3 PG p.226) |
| | P4: Zone/Delay | Key split and layer settings. (Key zone and velocity zone) Time delay from note-on to beginning of sound. (M3 PG p.231) |
| | P5-1: MIDI Filter1 | MIDI transmit/receive filter 1 settings. (M3 PG p.235) |
| | P5-2: MIDI Filter2 | MIDI transmit/receive filter 2 settings. (M3 PG p.239) |
| | P6: Track Edit | Step recording. Event recording. Copy, delete, and other track editing. (M3 PG p.241) |
| KARMA | P7-1: KARMA1-GE | Overall KARMA settings. (M3 PG p.243) |
| | P7-2: KARMA2-Module | Settings for each KARMA module. (M3 PG p.250) |
| | P7-3: KARMA3-GE RTP | KARMA GE realtime parameter settings. (M3 PG p.252) |
| | P7-4: KARMA4-Perf | KARMA performance parameter settings. (M3 PG p.254) |

SEQ P0: Play



SEQ P0-1: Play/REC

Here you can make basic settings for MIDI track recording and playing back in the song, and can select the program that will be used by each track.

In Sequencer mode, you can use four RADIAS programs.

For details on selecting a song, selecting the program used by each track, and the editable parameters and the display, please see “SEQ P0-1: Play/REC” on page 195 of the M3 parameter guide.

R (EXB-RADIAS)

MIDI tracks for which a RADIAS program can be used are indicated by “”. If you select a program from bank INT-F etc. for a track indicated by “”, a RADIAS program played by the EXB-RADIAS will sound.

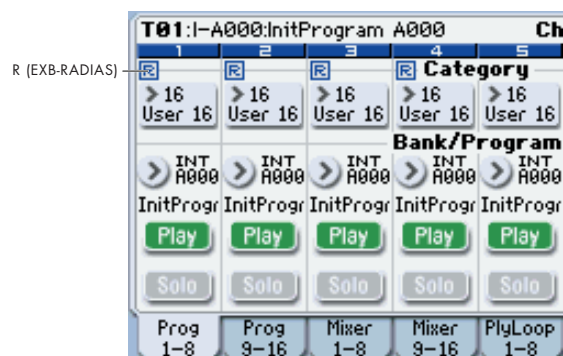

Use the **ENABLE RADIAS** setting to specify the tracks for which a RADIAS program can be used. (☞ “Enable RADIAS” on page 50)

Note: You can turn on **Enable RADIAS** for up to four tracks. Even if you select a RADIAS program for a track whose **ENABLE RADIAS** setting is turned **off**, it will not sound.

SEQ P0-2: Play/REC

0-2-1: KARMA GE

Here you can make KARMA function settings for the Sequencer mode.

In Sequencer mode you can use four KARMA Modules (Modules [A], [B], [C], and [D]).

For details on the available parameters and menu commands, please see “0-2-1: KARMA GE” on page 205 of the M3 parameter guide.

0-2-2: KARMA RTC

Here you can view the names and the stored parameter values for the KARMA Sliders 1-8 and KARMA switches 1-8. When you operate these, the screen will show the number and value of the GE realtime parameters and performance realtime parameters being controlled.

For details on the available parameters and menu commands, please see “0-2-2: KARMA RTC” on page 206 of the M3 parameter guide.

0-2-8: Control Surface

The Control Surface is the set of 8 sliders and 8 switches to the left of the display. It looks like a mixer, but it can do other things as well, including editing sounds, controlling KARMA, and sending MIDI messages to external devices.

This page shows you the current values for each of the sliders, knobs, and buttons, along with information about what they are controlling.

For details on the control surface, please see “0-2-8: Control Surface” on page 207 of the M3 parameter guide.

In Sequencer mode, you can select one of five different functions:

MIXER (Mixer T1-8, T9-16): This lets you use the control surface to adjust the volume of tracks 1-16, and switch the Play/Mute and Solo On/Off status. (In Combination mode and Sequencer mode, you can use this switch to alternate between timbres or tracks 1-8 and 9-16.)

MIXER (Mixer Input): The control surface will control the audio input volume, Play/Mute and Solo On/Off status of the analog inputs, S/P DIF inputs, and FireWire inputs (if the EXB-FW is installed).

REALTIME CONTROL (RT Control): Use the sliders to control the sound or effects. Use the switches to turn effects on/off.

EXTERNAL lets you send MIDI messages to external MIDI devices. Use the GLOBAL P1: MIDI- External Mode 1/2 page to specify the MIDI message that will be transmitted.

TONE ADJUST lets you edit Programs within the context of the Song, and without making any changes to the original Program data. You also get hands-on access to these edits, using the sliders, and switches.

KARMA: Use the sliders and switches to control the KARMA function.

You can freely change back and forth between the different functions, without losing any of your edits.

Tone Adjust



SEQ P1: DT/X-Y/Ctrls

Here you can select a pattern for the drum track and make settings for it, as well as make settings for X-Y control and pads 1-8.

For details on the available parameters and menu commands, please see “SEQ P1: DT/XY/Ctrls” on page 215 of the M3 parameter guide.

0-2-8f: Tone Adjust

For details on the Tone Adjust function, refer to “M3 parameter guide.”

Common Tone Adjust Parameters

These are the same as the Common Tone Adjust Parameters in Program mode.

For more information, please see “Common Tone Adjust Parameters” on page 22.

RADIAS Tone Adjust Parameters

These are the same as the RADIAS Tone Adjust Parameters in Program mode.

For more information, please see “RADIAS Tone Adjust Parameters” on page 23.

SEQ P2: EQ/Option

2-1: EQ Trim T01-08, 2-2: EQ Trim T09-16

Here you can adjust the volume level going into the EQ.
For details on the available parameters and menu commands, please see “2-1: Trim T01-08, 2-2: Trim T09-16” on page 224 of the M3 parameter guide.

2-3: EQ Gain T01-08, 2-4: EQ Gain T09-16

Here you can make the Mid sweep EQ settings for MIDI tracks 1-16.
For details on the available parameters and menu commands, please see “2-3: EQ T01-08, 2-4: EQ T09-16” on page 225 of the M3 parameter guide.

2-5: RADIUS T01-08, 2-6: RADIUS T09-16

Here you can make settings that specify how RADIUS programs will sound and how the audio will be routed.

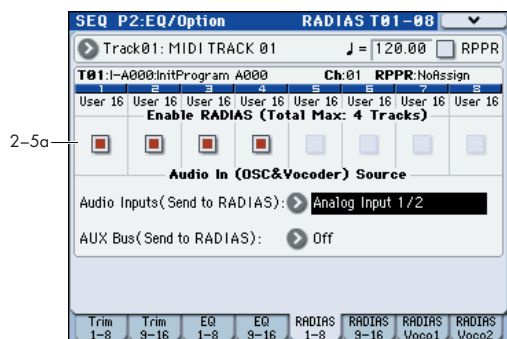

2-5(6)c: Enable RADIUS (Total Max: 4 Tracks)

Enable RADIUS [Off, On]

This specifies whether a RADIUS program selected in Program Select will sound. Up to four RADIUS programs can be sounded in one combination.

For more information, please see “Enable RADIUS” on page 50.

2-5(6)d: Audio In (OSC&Vocoder) Source

Audio Inputs (Send to RADIUS)
[Off, S/PDIF L/R, FireWire L/R]

AUX Bus (Send to RADIUS)
[Off, AUX 1/2, AUX 3/4]

Here you can select the audio input and AUX buses that will be the input source to the EXB-RADIUS.

For more information, please see “1-1c: AudioIn (OSC&Vocoder) Source” on page 26.

2-7: RADIUS Vocoder1

Here you can make vocoder-related settings for the song.

⚠ Only one instance of the vocoder function can be used in each song. It can be used on only one track. Even if you’ve selected a RADIUS vocoder program in four tracks, it is not the case that all four vocoders will operate.

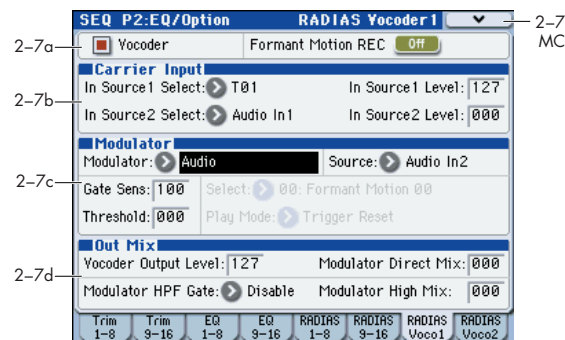

2-7a: Vocoder On/Off, Formant Motion REC On/Off

Vocoder [Off, On]

Formant Motion REC [Off, On]

For details on these parameters, please see “6-1a: Vocoder On/Off, Formant Motion REC On/Off” on page 42.

2-7b: Carrier Input

In Source 1 Select [Off, T01...T16]

This selects the MIDI track of the RADIUS program that will be the input source to the carrier. Tracks whose Enable RADIUS is on can be selected as input sources.

In Source 1 Level [000...127]

In Source 2 Select
[Audio In1, AUX Send L+R, AUX Send L, AUX Send R]

In Source 2 Level [000...127]

For details on these parameters, please see “6-1b: Carrier Input” on page 42.

2-7c: Modulator

Modulator (Modulator Select)
[Audio, Formant Motion]

Source (Audio Source)
[Audio In2, AUX Send L+R, AUX Send L, AUX Send R]

Gate Sens (Gate Sensitivity) [000...127]

Threshold [000...127]

Select (Formant Motion Select)
[Formant Motion 00...Formant Motion 16]

Play Mode (Formant Motion Play Mode)
[Free Run, Trigger Reset]

For details on these parameters, please see "6-1c: Modulator" on page 42.

2-7d: Out Mix

Vocoder Output Level [000...127]

Modulator Direct Mix [000...127]

Modulator HPF Gate [Disable, Enable]

Modulator High Mix [000...127]

For details on these parameters, please see "6-1d: Out Mix" on page 43.

▼ 2-7: Menu Command

- Write Formant Motion Data p.64
- Copy Vocoder p.64

2-8: RADIAS Vocoder2

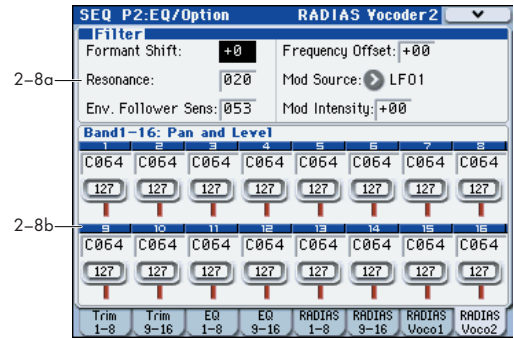

2-8a: Filter

Formant Shift [-2...+2]

Resonance [000...127]

Env. Follower Sens (Envelope Follower Sensitivity) [000...127]

Frequency Offset [-63...+63]

Mod Source (Fc Modulation Source)
[EG1...X-Y -Y Mod:#88]

Mod Intensity (Fc Modulation Intensity)
[-63...+63]

For details on these parameters, please see "6-2a: Filter" on page 44.

2-8b: Band1-16: Pan and Level

Band1...Band16

Pan [L000...C064...R127]

Level [000...127]

For details on these parameters, please see "6-2b: Band1-16: Pan and Level" on page 44.

▼ 2-8: Menu Command

- Write Formant Motion Data p.64
- Copy Vocoder p.64

SEQ P3: Track Parameters

3-1: MIDI T01-08, 3-2: MIDI T09-16

These settings specify how each track will be played. For details on the available parameters and menu commands, please see “3-1: MIDI ch T01-08, 3-2: MIDI ch T09-16” on page 226 of the M3 parameter guide.

3-3: OSC T01-08, 3-4: OSC T09-16



3-3(4)a: OSC

Track 01...16 (Track Number):

Force OSC Mode [PRG, Poly, MN, LGT]

Selects the Voice Assign Mode (Program 1-1a) of the RADIAS program selected.

For more information, please see “Force OSC Mode” on page 54.

OSC Select [BTH, OS1, OS2]

This has no effect for RADIAS programs used by a MIDI track.

For more information, please see “OSC Select” on page 227 of the M3 parameter guide.

Portamento [PRG, Off, 001...127]

Specifies the portamento for the RADIAS programs used by the MIDI track.

For more information, please see “Portamento” on page 54.

3-5: Pitch T01-08, 3-6: Pitch T09-16

Here you can make pitch-related settings for each MIDI track 1-16.

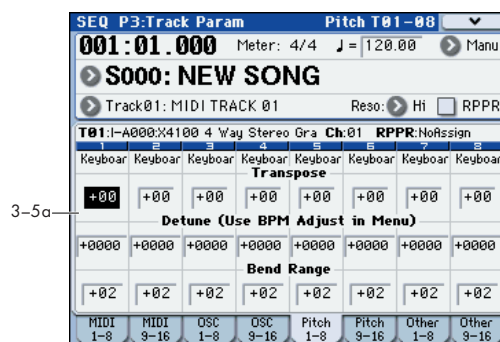

3-5(6)a: Pitch

Track 01 (Track Number):

Transpose [-60...+00...+60]

Adjusts the pitch in semitone steps for the RADIAS program used by the MIDI track. A setting of +12 is one octave.

The actual pitch sounded by the program is determined by adding this value to the **Transpose** setting (Program 2-2a) of the RADIAS program used by the track. However, a RADIAS program cannot be transposed farther than +/-48. Values below -48 are treated as -48, and values above +48 are treated as +48.

For more information, please see “Transpose” on page 54.

Detune (Use BPM Adjust in Menu) [-1200...+0000... +1200]

Adjusts the pitch in one-cent units from the normal pitch for the RADIAS program used by the MIDI track.

The actual pitch sounded by the program is determined by adding this value to the **Tune (cents)** setting (Program 2-2a) of the RADIAS program used by the track. However, a RADIAS program cannot be detuned farther than +/-50 cents. Values below -50 are treated as -50, and values above +50 are treated as +50.

For more information, please see “Detune (Use BPM Adjust in Menu)” on page 228 of the M3 parameter guide.

Bend Range [PRG, -24...+00...+24]

Specifies the amount of pitch change that will occur when the pitch bender is operated, in semitone units.

The actual bend range is determined by adding this value to the **Bend Range** (Program 2-2a) of the RADIAS program used by the MIDI track. However, a RADIAS program cannot have a bend range greater than +/-12. Values below -12 are treated as -12, and values above +12 are treated as +12.

For more information, please see “Bend Range” on page 55.

Track 02...08, 09...16 (Track Number):

Here you can make pitch-related settings for each MIDI track 2-16. The settings are the same as for track 1. See "Track 01 (Track Number)".

**3-7: Other T01-08,
3-8: Other T09-16**

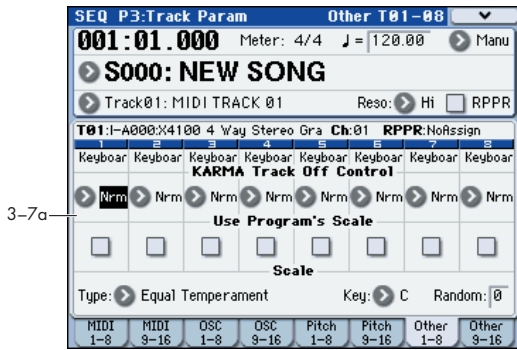

3-7(8)a: KARMA/Scale

Track 01...16 (Track Number):

KARMA Track Off Control

[Normal, Track Off by KARMA Off, Track Off by KARMA On]

Use Program's Scale [Off, On]

Type (Song's Scale) [Equal Temperament...User Octave Scale15]

Key [C...B]

Random [0...7]

For details on the available parameters and menu commands, please see "3-7: Other T01-08, 3-8: Other T09-16" on page 229 of the M3 parameter guide.

SEQ P4: Zone/Delay

Here you can specify the key range and velocity range for which MIDI tracks 1-16 will sound, and specify the delay time until the sound will be heard.

For details on the available parameters and menu commands, please see "SEQ P4: Zones/Delay" on page 231 of the M3 parameter guide.

▲ The Keyboard Zones / Velocity Zones "Top Slope" and "Bottom Slope" settings will have no effect for RADIAS program.

SEQ P5: MIDI Filter

Here you can select whether or not to apply filtering to the MIDI data received by MIDI tracks 1-16.

For details on the available parameters and menu commands, please see "SEQ P5: MIDI Filter" on page 235 of the M3 parameter guide.

SEQ P6: Track Edit

Here you can edit MIDI tracks and the master track.

For details on the available parameters and menu commands, please see "SEQ P6: Track Edit" on page 241 of the M3 parameter guide.

SEQ P7: KARMA

Here you can make settings for the KARMA functions used in Sequencer mode.

For details on the available parameters and menu commands, please see "SEQ P7: KARMA" on page 243 of the M3 parameter guide.

SEQ P8: IFX (Insert Effects)

Here you can specify the bus and insert effect for MIDI tracks 1-16.

For details on the available parameters and menu commands, please see "SEQ P8: IFX (Insert Effect)" on page 257 of the M3 parameter guide.

SEQ P9: MFX/TFX (Master/Total Effects)

Here you can make settings for the master effects and total effects.

For details on the available parameters and menu commands, please see "SEQ P9: MFX/TFX (Master/Total Effect)" on page 263 of the M3 parameter guide.

SEQ P10: Pattern/RPPR

Here you can record patterns, edit them, assign them to song tracks, and make RPPR (Realtime Pattern Play / Recording) settings

For details on the available parameters and menu commands, please see “SEQ P10: Pattern/RPPR” on page 265 of the M3 parameter guide.

SEQ P11: Cue List

Here you can create cue lists.

For details on the available parameters and menu commands, please see “SEQ P11: Cue List” on page 269 of the M3 parameter guide.

Menu Command

The menu commands explained here are the commands that are displayed and available if the EXB-RADIAS option is installed.

For details on other commands, refer to the “M3 parameter guide.”

Copy from Program

This command copies settings from a specified program to the currently selected song. If you select a RADIAS program from the INT-F bank etc. as the copy-source, the **RADIAS Vocoder** check box in the dialog box will be enabled.

If you check **RADIAS Vocoder** and execute the copy, the vocoder parameter settings of the copy-source RADIAS program will also be copied.

⚠ This is invalid if you’ve selected an EDS program as the copy-source.

For the procedure and other settings, please see “Copy from Program” on page 273 of the M3 parameter guide.

Write Formant Motion Data

This command saves the recorded formant motion data into internal memory. If you turn off the power before saving formant motion data you’ve recorded, the data cannot be recovered.

For the procedure, please see “Write Formant Motion Data,” on page 46.

Copy Vocoder

This command copies the vocoder settings from a specified program, combination, or song to the currently selected combination.

For the procedure, please see “Copy Vocoder,” on page 46.

Global mode

Here we will explain only the menu commands “Load Preload/Demo Data” and “Set Program User-Bank Type.” For details on the other parameters and menu commands, refer to “Global mode” in the M3 parameter guide. (M3 parameter guide p.355)

Menu Command

Load Preload/Demo Data

This command loads the preload data and demo song data into the M3.

Here we will explain only how to load RADIUS programs and formant motion data. For details on loading other data, please see “Load Preload/Demo Data” on page 382 of the M3 parameter guide.

 Before you load this data, uncheck Program in **Memory Protect** (M3 parameter guide p.359). If you execute with this item still checked, a message of “Memory Protected” will appear, and the data will not be loaded.

1. Select “Load Preload/Demo Data” to open the dialog box.
2. Use “Kind” to select the type of data you want to load.

Loading RADIUS programs

In the “Kind” field, select Program.

If you specify Bank as the range to be loaded, select I-F as the load-source data, and I-F or a user bank set to the RADIUS bank type as the load-destination (“To:”). (M3 parameter guide p.66)

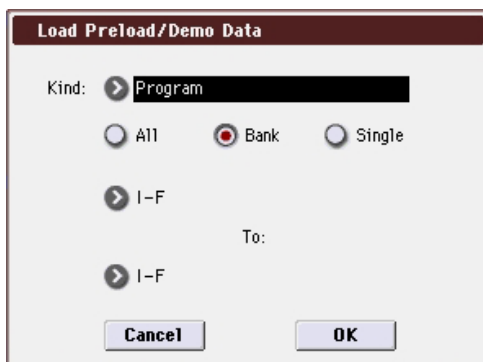

If you specify Single as the range to be loaded, select a program from bank I-F as the load-source, and a program number in I-F or a user bank set to the RADIUS bank type as the load-destination (“To”).

Loading formant motion data

In the “Kind” field, select RADIUS Formant Motion Data. If you specify All as the range of data to be loaded, all formant motion data will be loaded.

If you specify Single as the range of data to be loaded, a single formant motion will be loaded. In this case, you’ll need to specify the load-source and load-destination (“To:”).

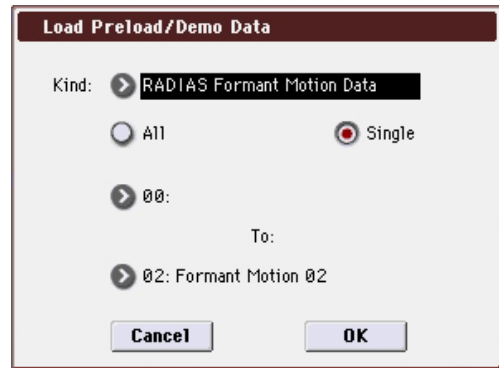

3. Press the OK button to execute, or press the Cancel button to cancel.

Set Program User-Bank Type

This specifies the bank type for Program mode program banks USER-A through G.

If you've set the bank type to RADIUS, the RADIUS programs you create can be saved in the corresponding user bank.

As an example, here's how to set the USER-F bank type to RADIUS.

 Before you execute, uncheck Program in **Memory Protect** (M3 parameter guide p.359). If you execute with this item still checked, a message of "Memory Protected" will appear, and the data will not be loaded.

1. Select "Set Program User-Bank Type" to open the dialog box.

This indicates the current type for each user bank.

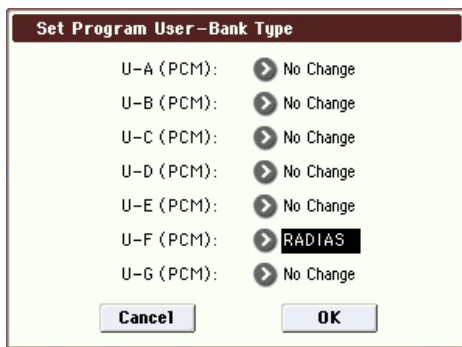

2. Select RADIUS as the bank type for USER-F.

Note: If you execute with a setting other than No Change, all data in that bank will be initialized – even if you have specified the same bank type as before. If you want to keep your data, you must first use "Save All" or "Save PCG" to save it.

3. Press the OK button to execute, or press the Cancel button to cancel.

A dialog box will ask you to confirm.

4. Verify the settings. Then press the OK button to execute, or press the Cancel button to cancel.

Media mode

Here we will explain only the menu commands "Load RADIAS Formant Motions" and "Load a RADIAS Formant Motion."

For details on the other parameters and menu commands, refer to "Media mode" in the M3 parameter guide. (M3 parameter guide p.389)

Menu Command

Load selected

11) Load RADIAS Formant Motions



All formant motion data from a .PCG file will be loaded.

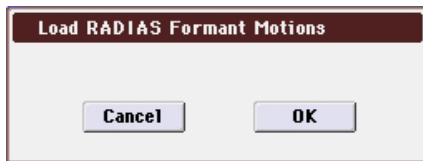

1. To load the data, press the OK button. To cancel without loading, press the Cancel button.

12) Load a RADIAS Formant Motion



Data for the selected formant motion will be loaded into the number you specify.

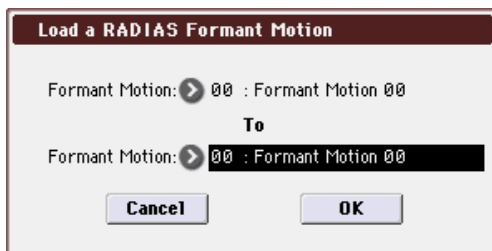

1. If you wish to load a formant motion data other than the one already selected, use "Formant Motion" (upper line) to select the formant motion data that you wish to load.
2. In "Formant Motion," (lower line) select formant motion data into which the data will be loaded.
3. To load the data, press the OK button. To cancel without loading, press the Cancel button.



Appendices

EXB-RADIAS Specifications

| EXB-RADIAS (RADIAS synthesizer board) | | | | |
|--|---|---|---|--|
| System | MMT (Multiple Modeling Technology) | | | |
| Sound generator | Polyphony | 24 voices *The actual maximum polyphony will depend on the settings of the parameters that make up the sound. | | |
| | Synthesizer section | Oscillator | 2 oscillators + noise generator Oscillator 1: eight basic waveforms (Saw/Square/Tri/Sine/Formant/Noise/DWGS/Audio In) Four types of modulation (Waveform/Cross/Unison/VPM) Oscillator 2: four basic waveforms (Saw/Square/Tri/Sine) Two types of modulation (Ring/Sync) | |
| | | Filter | Four types of filter routing (single, serial parallel, individual) Two multi-mode filters per voice Filter 1: Variable -24 dB LPF -- -12 dB LPF - HPF - BPF - Thru Filter 2: Switchable LPF/HPF/BPF/Comb | |
| | | Driver/Wave shape | For each voice, one non-linear driver or wave shape (11 types) can be inserted | |
| | | EQ | 3-band EQ (adjustable frequency for the mid-range) | |
| | | Modulation | For each voice, three envelope generators, two LFOs, and three 16-step modulation sequencers Eight virtual patches Envelope generators, LFOs, and the M3's selectors can modulate major parameters | |
| | | Vocoder section | 16-band vocoder (level and pan adjustable for each band) | |
| | | | Formant Motion function (sixteen sets of formant motion data can be recorded) | |
| | Formant Shift function, Formant Hold function | | | |
| | Structure | Program | Synth programs (synthesizer section) | |
| Vocoder programs (synthesizer section + vocoder section) | | | | |
| Combination, Sequencer | | 128 preloaded (I-F bank) | I-F bank: dedicated RADIAS bank U-A - U-G banks: assignable to EDS/RADIAS by bank | |
| | | Up to four synth programs + vocoder section (maximum 16 timbres/tracks, can be combined with EDS programs) The M3's effects, X-Y control, KARMA, drum track, and controllers etc. can be used in the same way as for the EDS system. | | |
| Audio input | Audio input | One stereo source can be routed from the M3's audio input sources The audio inputs AUDIO INPUT 1/2, S/P DIF L/R, and FireWire L/R (if the EXB-FW is installed) can be input to the RADIAS oscillators or vocoder. | | |
| | AUX bus | One stereo source from the M3's AUX bus 1/2 or 3/4 can be routed. The audio input following an insert effect, the drum track, or an EDS timbre etc. can be input to the RADIAS oscillator or vocoder. | | |
| Included items | Owner's manual, screws | | | |

Appearance and specifications of this product are subject to change without notice. (January /'07)

IMPORTANT NOTICE TO CONSUMERS

This product has been manufactured according to strict specifications and voltage requirements that are applicable in the country in which it is intended that this product should be used. If you have purchased this product via the internet, through mail order, and/or via a telephone sale, you must verify that this product is intended to be used in the country in which you reside.

WARNING: Use of this product in any country other than that for which it is intended could be dangerous and could invalidate the manufacturer's or distributor's warranty.

Please also retain your receipt as proof of purchase otherwise your product may be disqualified from the manufacturer's or distributor's warranty.

KORG KORG INC.

4015-2 Yanokuchi, Inagi-city, Tokyo 206-0812 Japan