

USER'S MANUAL

DRUMBRUTE
ANALOG DRUM SYNTHESIZER

ARTURIA®
YOUR EXPERIENCE • YOUR SOUND

Direction

Frédéric Brun

Adrien Courdavault

Engineering

Mickey Delp of Delptronics

Valentin Lepetit

Yannick Bellance

Nicolas Dubois

Olivier Delhomme

Adrien Courdavault

Design

Glen Darcey

Morgan Perrier

DesignBox

Sound Design

Glen Darcey

Baptiste Le Goff

Victor Morello

Jean-Baptiste Arthus

Manual

Randy Lee

© ARTURIA SA – 2016 – All rights reserved.

11 Chemin de la Dhuy

38240 Meylan

FRANCE

<http://www.arturia.com>

Information contained in this manual is subject to change without notice and does not represent a commitment on the part of Arturia. The software described in this manual is provided under the terms of a license agreement or non-disclosure agreement. The software license agreement specifies the terms and conditions for its lawful use. No part of this manual may be reproduced or transmitted in any form or by any purpose other than purchaser's personal use, without the express written permission of ARTURIA S.A.

All other products, logos or company names quoted in this manual are trademarks or registered trademarks of their respective owners. **15th of October 2016 edition**

Thank you for purchasing the Arturia DrumBrute!

This manual covers the features and operation of Arturia's **DrumBrute**, a full-featured analog drum synthesizer, pattern sequencer and live performance device.

In this package you will find:

- One DrumBrute analog drum synthesizer, with a serial number and an unlock code on the bottom. You will need this information in order to register your DrumBrute online.
- One DC power supply. Use only the included supply or else the unit could be damaged.
- One USB cable
- The Quick Start Guide

Be sure to register your DrumBrute as soon as possible! There is a sticker on the bottom panel that contains the serial number of your unit and an unlock code. These are required during the online registration process. You may want to record these elsewhere or take a photo of the sticker in case it becomes damaged.

Registering your DrumBrute provides the following benefits:

- It enables you to download the DrumBrute user manual and the latest version of the MIDI Control Center software
- It allows you to receive special offers restricted to DrumBrute owners.

Special Message Section

SPECIFICATIONS SUBJECT TO CHANGE:

The information contained in this manual is believed to be correct at the time of printing. However, Arturia reserves the right to change or modify any of the specifications without notice or obligation to update the hardware that has been purchased.

IMPORTANT:

The product and its software, when used in combination with an amplifier, headphones or speakers, may be able to produce sound levels that could cause permanent hearing loss. DO NOT operate for long periods of time at a high level or at a level that is uncomfortable.

If you encounter any hearing loss or ringing in the ears, you should consult an audiologist.

NOTICE:

Service charges incurred due to a lack of knowledge relating to how a function or feature works (when the product is operating as designed) are not covered by the manufacturer's warranty, and are therefore the owner's responsibility. Please study this manual carefully and consult your dealer before requesting service.

PRECAUTIONS INCLUDE, BUT ARE NOT LIMITED TO, THE FOLLOWING:

1. Read and understand all the instructions.
2. Always follow the instructions on the instrument.
3. Before cleaning the instrument, always remove the USB cable. When cleaning, use a soft and dry cloth. Do not use gasoline, alcohol, acetone, turpentine or any other organic solutions; do not use a liquid cleaner, spray or cloth that's too wet.
4. Do not use the instrument near water or moisture, such as a bathtub, sink, swimming pool or similar place.
5. Do not place the instrument in an unstable position where it might accidentally fall over.
6. Do not place heavy objects on the instrument. Do not block openings or vents of the instrument; these locations are used for air circulation to prevent the instrument from overheating. Do not place the instrument near a heat vent at any location with poor air circulation.
7. Do not open or insert anything into the instrument that may cause a fire or electrical shock.
8. Do not spill any kind of liquid onto the instrument.
9. Always take the instrument to a qualified service center. You will invalidate your warranty if you open and remove the cover, and improper assembly may cause electrical shock or other malfunctions.
10. Do not use the instrument with thunder and lightning present; otherwise it may cause long distance electrical shock.
11. Do not expose the instrument to hot sunlight.
12. Do not use the instrument when there is a gas leak nearby.
13. Arturia is not responsible for any damage or data loss caused by improper operation of the instrument.

Table of Contents

1	INTRODUCTION	9
2	DRUMBRUTE OVERVIEW	10
2.1	MAKING THE CONNECTIONS	10
2.1.1	...with a computer	10
2.1.2	...with external devices	11
2.1.2.1	MIDI devices	11
2.1.2.2	Clock sources/destinations	11
2.2	TRANSPORT + PATTERNS	12
2.2.1	Tempo/Value display	12
2.2.2	Rate/Fine/Tap Tempo	12
2.2.3	Transport buttons	12
2.2.4	Synchronization	13
2.2.5	DrumBrute modes	13
2.2.6	Step buttons	13
2.2.7	Copy/Erase	14
2.2.8	Pattern length/Last step	14
2.2.9	Save button	14
2.3	FILTER + PATTERN EFFECTS	15
2.3.1	Output filter	15
2.3.2	Master volume	16
2.3.3	Pattern effects	16
2.3.4	Roller/Looper/Step Repeat	16
2.3.4.1	Roller	16
2.3.4.2	Looper	17
2.3.4.3	Step Repeat	17
2.3.5	Global BPM	17
2.3.6	Polyrhythm	17
2.4	INSTRUMENTS + PADS	18
2.4.1	Instrument controls	18
2.4.2	Instrument select buttons	18
2.4.3	Pads	18
2.5	METRONOME, MUTE/SOLO + SHIFT	19
2.5.1	Metronome	19
2.5.2	Mute/Solo buttons	19
2.5.3	Shift button	19
2.6	REAR PANEL, PART 1	20
2.6.1	Power	20
2.6.2	USB	20
2.6.3	MIDI input/output	20
2.6.4	Clock input/output	20
2.7	REAR PANEL, PART 2	21
2.7.1	Individual Outs	21
2.7.2	Metronome Output	21
2.7.3	Mix Output	21
2.7.4	Headphone Level Control	21
2.7.5	Headphones	22
3	BASIC OPERATIONS	23
3.1	WORKING WITH PATTERNS	23
3.1.1	Select a bank	23
3.1.2	Select a pattern	23
3.1.3	Set the tempo	23
3.1.4	Enable the metronome	24
3.1.5	Record a pattern	24
3.1.6	Save what you've done!	24
3.2	CREATIVE PLAYBACK OPTIONS	25
3.2.1	Output Filter	25

3.2.2	<i>Swing</i>	25
3.2.3	<i>Randomness</i>	25
3.2.4	<i>Looper</i>	25
3.2.4.1	Loop length	26
3.2.4.2	Loop start point	26
3.2.5	<i>Pause or Restart</i>	26
3.3	ALL NOTES OFF.....	26
4	SONG MODE	27
4.1	WHAT'S A SONG?	27
4.2	SELECTING A SONG	27
4.3	CREATING A SONG.....	28
4.4	SAVING A SONG.....	28
4.5	ERASING A SONG	28
4.6	LIVE PERFORMANCE FEATURES	29
4.6.1	<i>Song-level features</i>	29
4.6.1.1	Output Filter.....	29
4.6.1.2	The Looper Strip	29
4.6.1.3	Pause or Restart.....	29
4.6.2	<i>Pattern-level features</i>	29
4.6.2.1	Tempo	29
4.6.2.2	Swing/Randomness	30
5	PATTERN MODE	31
5.1	PATTERN CREATION	31
5.1.1	<i>Set the tempo</i>	31
5.1.1.1	Fine-tuning the Tempo	31
5.1.1.2	Tap tempo	31
5.1.2	<i>Time Division</i>	31
5.1.3	<i>Recording a Pattern</i>	31
5.1.3.1	The Metronome.....	32
5.1.3.2	Quantize Record.....	32
5.1.3.3	Non-quantize mode	32
5.1.4	<i>Mute/Solo features</i>	32
5.1.4.1	Create a Group	32
5.1.4.2	Clear the Group.....	33
5.1.5	<i>Using the Roller</i>	33
5.1.5.1	How it works	33
5.1.5.2	Sync settings	33
5.1.6	<i>Spot Erase</i>	33
5.1.7	<i>Swing</i>	33
5.1.7.1	Current Track button	34
5.1.8	<i>Randomness</i>	34
5.1.8.1	Current Track button	35
5.2	PATTERN EDITING	35
5.2.1	<i>Step Mode</i>	35
5.2.2	<i>Accent Mode</i>	36
5.2.3	<i>Red state, Blue state</i>	36
5.2.4	<i>Selecting a Drum</i>	36
5.2.4.1	...while paused.....	36
5.2.4.2	...while recording	36
5.2.5	<i>Step Repeat</i>	36
5.2.6	<i>Shift timing</i>	38
5.2.7	<i>Copy a Drum Track</i>	38
5.2.7.1	Within a pattern.....	38
5.2.7.2	Between patterns	39
5.2.7.3	Between banks	39
5.2.8	<i>Erasing a Drum Track</i>	40
5.2.9	<i>Pattern Length</i>	40
5.2.9.1	Pattern Follow mode	40
5.2.9.2	Lengths > 16 steps.....	40
5.2.9.3	Editing steps 17-32.....	41
5.3	SAVE THE PATTERN!.....	41

5.4	COPY A PATTERN	42
6	COPY/ERASE FUNCTIONS	43
6.1	COPY BANK TO BANK	43
6.2	COPY PATTERN TO PATTERN	43
6.2.1	<i>Within a Bank</i>	43
6.2.2	<i>Between Banks</i>	43
6.3	COPY DRUM TO DRUM	44
6.4	ERASING A BANK	44
6.5	ERASING A PATTERN	44
6.6	ERASING A DRUM TRACK	45
7	ADVANCED FEATURES	46
7.1	EXTEND A PATTERN	46
7.1.1	<i>Adding blank steps</i>	46
7.1.2	<i>Copy and append</i>	46
7.2	SHORTEN A PATTERN	47
7.3	POLYRHYTHM MODE	47
7.3.1	<i>What is Polyrythm mode?</i>	47
7.3.2	<i>What it does</i>	47
7.3.3	<i>Make a polyrythm</i>	48
7.4	SHIFT BUTTON CHART	49
8	SYNCHRONIZATION	50
8.1	AS MASTER	50
8.2	AS SLAVE	50
8.2.1	<i>Clock In/Out rates</i>	50
8.2.2	<i>Clock connectors</i>	51
9	MIDI CONTROL CENTER BASICS	52
9.1	SYSTEM REQUIREMENTS	52
9.2	INSTALLATION AND LOCATION	52
9.3	CONNECTION	52
9.4	BACK UP YOUR SEQUENCES	53
9.5	WHERE TO FIND THE MANUAL	53
10	USING MIDI CONTROL CENTER	54
10.1	THE SYNC OPTION	54
10.1.1	<i>Sync operations</i>	54
10.1.2	<i>Non-sync operations</i>	54
10.2	DEVICE TEMPLATES	55
10.2.1	<i>The Working Memory</i>	55
10.2.1.1	<i>Live editing</i>	55
10.2.1.2	<i>Drag and drop</i>	56
10.3	PROJECT BROWSER	56
10.3.1	<i>Building a library</i>	56
10.3.2	<i>Revise a Template</i>	57
10.3.2.1	<i>While synced</i>	57
10.3.2.2	<i>Not synced</i>	57
10.3.3	<i>Send one pattern to DrumBrute</i>	58
10.3.3.1	<i>When synced</i>	58
10.3.3.2	<i>When not synced</i>	58
10.4	STORE TO/RECALL FROM	59
10.4.1	<i>The 'Store To' button</i>	59
10.4.2	<i>Recall edited patterns from the DrumBrute</i>	60
10.4.3	<i>Save, Delete, Import/Export, etc.</i>	60
10.5	IMPORT/EXPORT DEVICE SETTINGS	60
10.5.1	<i>Export Device Settings</i>	60
10.5.2	<i>Import Device Settings</i>	61
10.6	EDITING BASICS	61
10.6.1	<i>Data entry</i>	61

10.6.2	Selecting the tabs	61
10.6.3	Bank tabs	62
10.6.4	Device Settings tab.....	62
10.7	PATTERN WINDOW.....	62
10.7.1	Navigation.....	62
10.7.1.1	Scroll	62
10.7.1.2	Zoom	63
10.7.2	Pattern-level parameters	63
10.7.3	Pattern length.....	63
10.7.4	Pattern events	64
10.7.4.1	Enter/delete events.....	64
10.7.4.2	Move events.....	64
10.7.4.3	Copy/paste events	64
10.7.4.4	Event velocity	65
10.7.4.5	Shift Timing.....	65
10.7.4.6	Step Repeat.....	66
10.7.5	Track-level settings.....	66
10.7.5.1	Swing.....	67
10.7.5.2	Randomness.....	67
10.8	POLYRHYTHM.....	67
10.9	DEVICE SETTINGS.....	68
10.9.1	MIDI Channel.....	68
10.9.2	Global settings.....	68
10.9.2.1	Clock In/Out Settings	68
10.9.2.2	Auto-Sync.....	68
10.9.2.3	Tap Tempo.....	68
10.9.2.4	Global BPM.....	68
10.9.2.5	Wait to Load Pattern.....	68
10.9.2.6	Accent Velocity Threshold	68
10.9.2.7	Pads send MIDI notes.....	69
10.9.2.8	Metronome	69
10.9.2.9	Step Repeat Randomizer.....	69
10.9.2.10	Step Repeat Probability	69
10.9.2.11	Vegas mode	69
10.9.2.12	Pause mode.....	69
10.9.2.13	Next bank.....	69
10.9.3	Transport settings	69
10.9.4	Drum Map.....	70
11	ARTURIA DRUMBRUTE – LEGAL INFORMATION	71
11.1	SOFTWARE LICENSE AGREEMENT	71
11.2	FCC INFORMATION (USA).....	73
11.3	CANADA	74
11.4	EUROPE.....	74

1 INTRODUCTION

Congratulations on your purchase of the Arturia DrumBrute!

This is truly a product that has been born a legend. DrumBrute is an analog drum synthesizer, which means it follows in the time-honored tradition of the classic drum machines of the 1970s and '80s by generating a truly organic, analog sound and then providing nearly infinite analog control over each of the tone-shaping parameters.

And though its roots are squarely planted in the rich, analog past, DrumBrute reaches for the future by incorporating the most advanced technological developments of the modern era. And so it is able to integrate and synchronize with any computer system, MIDI rig or vintage setup.

But most importantly, we have taken great care to make sure DrumBrute will enhance your creative experience. And we're proud of what we've accomplished.

Who are we kidding? We're thrilled! DrumBrute is a ton of fun to use. You're going to have a blast with it.

Be sure to visit the www.arturia.com website and check for the latest firmware, download the MIDI Control Center and check out the tutorials and FAQs. We are sure you'll be making killer grooves before you know it.

Musically yours,

The Arturia team

2 DRUMBRUTE OVERVIEW

2.1 Making the connections

DrumBrute provides many ways to connect with other types of equipment, from vintage to modern. Below are examples of potential setups:

2.1.1 ...with a computer

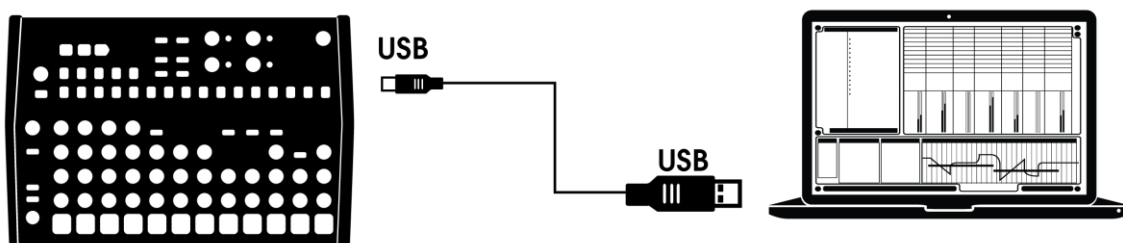

DrumBrute is more than a classic drum machine: it's also a USB class-compliant device. So at its most basic level it can be connected to any computer with a USB port, and its pads can be used as input devices for various applications. The included MIDI Control Center software allows you to specify which MIDI notes and commands will be transmitted by the pads and transport buttons, respectively.

! DrumBrute does not draw its power from the USB port on your computer. To supply power to the DrumBrute, simply connect the included DC power adapter to the DrumBrute and to an external power source, then set the power switch on the back of the DrumBrute to the On position.

2.1.2 ...with external devices

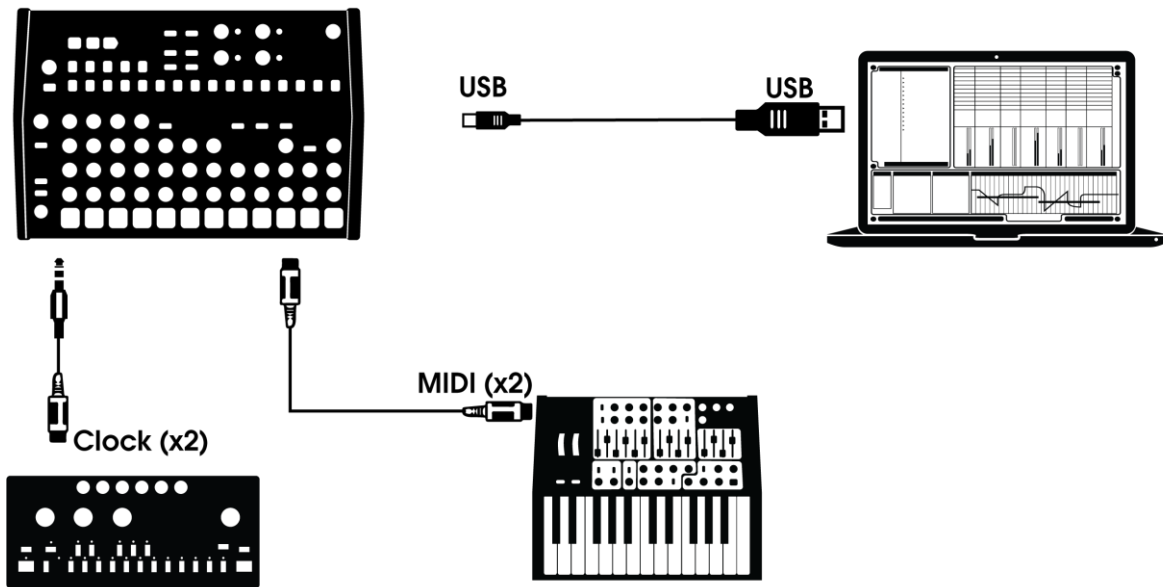

As you can see, the DrumBrute can be the backbone of some amazing systems.

2.1.2.1 *MIDI devices*

There are lots of great devices that only have MIDI ports (no clock sync, no USB). DrumBrute will fit right in with these systems: it will sync with MIDI sequencers, arpeggiators, and other drum machines, and its own drum sounds may be played from a MIDI keyboard. And of course it can send and receive MIDI data using the USB port of your computer.

2.1.2.2 *Clock sources/destinations*

The Clock input and output can synchronize with older clock types such as 24 pulses per quarter note (ppqn), 48 ppqn, 2 ppqn (Korg), or even a single pulse per step.

See section 8.2.2 for information about what cables to use with other sync connections and formats.

2.2 Transport + Patterns

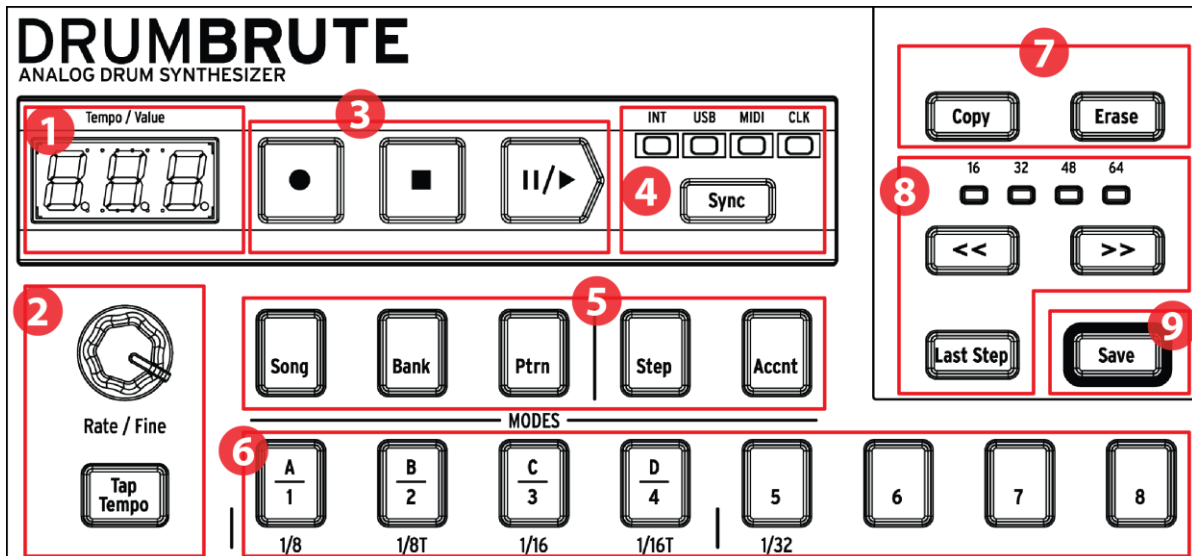

- | | |
|-----------------------------|-------------|
| 1. Tempo/Value display | (see 2.2.1) |
| 2. Rate/Fine/Tap Tempo | (see 2.2.2) |
| 3. Transport buttons | (see 2.2.3) |
| 4. Synchronization | (see 2.2.4) |
| 5. DrumBrute modes | (see 2.2.5) |
| 6. Step buttons/Step values | (see 2.2.6) |
| 7. Copy/Erase | (see 2.2.7) |
| 8. Pattern length/Last step | (see 2.2.8) |
| 9. Save button | (see 2.2.9) |

2.2.1 Tempo/Value display

Most of the time the display will show the tempo value in beats per minute (BPM), but it will also change temporarily to show the values of the Pattern Effects while they are being edited.

2.2.2 Rate/Fine/Tap Tempo

The tempo can be set using the Rate/Fine encoder or by tapping the Tap Tempo button. To fine-tune the tempo, press Shift and turn the encoder. The display will change to show the decimal values of the tempo (.00-.99) as soon as the Shift button is pressed.

2.2.3 Transport buttons

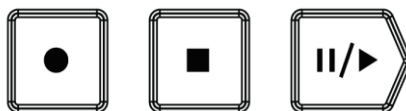

The Transport buttons control the DrumBrute sequencer as well as external MIDI devices using standard MIDI messages or MIDI Machine Control (MMC). Use the MIDI Control Center software to make any necessary changes.

The Record button is used to create songs and patterns, and the Stop button will cancel recording or playback.

The Play button doubles as a Pause/Continue button, which allows you to pause a sequence in mid-stream, tweak the sound of an instrument, and then press Play again to resume recording or playback.

 Record mode allows both quantized and unquantized recording. See section 5.1.3 for more information.

2.2.4 Synchronization

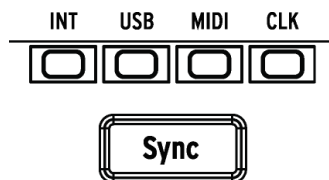

There are four Sync options which are accessed by pressing the Sync button repeatedly. These determine whether DrumBrute will be the master or the slave in a multi-device setup.

For descriptions of the sync features see chapter 8.

2.2.5 DrumBrute modes

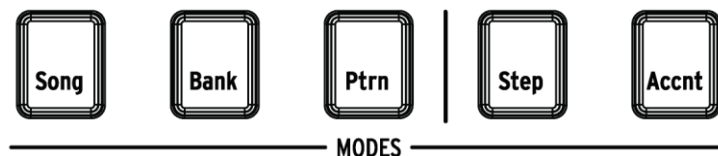

These five buttons determine the operational mode of the DrumBrute: Song, Bank, or Pattern mode. The Step and Accent buttons are used to edit a Pattern.

Everything you need to know about creating a pattern is in chapter 5. To learn how to build a song, see chapter 4.

2.2.6 Step buttons

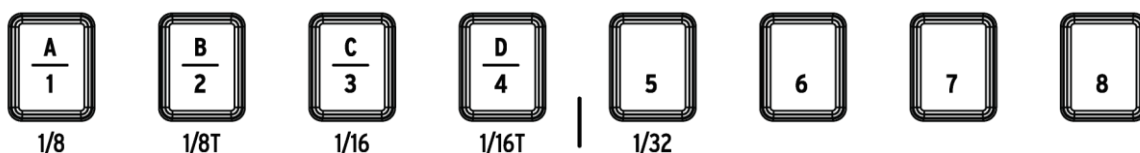

One main use for the sixteen Step buttons is to select patterns in Pattern mode. But they serve many other purposes as well. For example, in Step mode they are used to enable/disable events in a pattern.

In this manual you will learn how to use the Step buttons to select a song (see 4.2), select a bank or pattern (see 3.1), to edit a pattern (see 5.2), to set the pattern length (see 5.2.9), and much more.

2.2.7 Copy/Erase



These two buttons are used in every mode to copy or erase large amounts of pattern data at the same time. For example, you can copy a pattern to a new location or erase it completely.

You can also copy sequence data from one instrument to another within the same pattern, or erase all of the data for one instrument within a pattern.

The Copy/Erase functions are covered in greater detail in chapter 6.

2.2.8 Pattern length/Last step

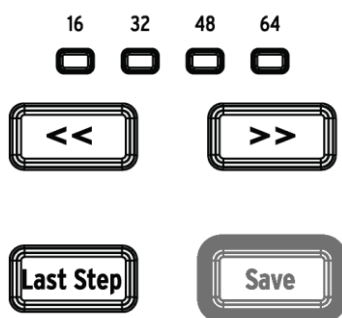

DrumBrute patterns can be up to 64 steps long, consisting of up to four 16-step subdivisions that play one after the other. Those are called the Step Groups.

The four LEDs above the double arrow buttons (<< >>) are used to indicate the pattern length and which Step Group is currently playing.

The Last Step button is used with the Step buttons and the << >> buttons to change the length of the current pattern.

For a complete description of these features, see section 5.2.9.

2.2.9 Save button



The Save button is used in conjunction with the Mode buttons and the Step buttons to preserve the patterns you have created. When your patterns have been saved to the internal memory then they will be loaded back into the memory when the DrumBrute is powered up.

! Your new pattern data will be lost during a power-cycle unless you have used the Save button to store it to the DrumBrute internal memory.

There are two levels of the Save function: Pattern and Bank. Details about these operations are found in section 3.1.6.

2.3 Filter + Pattern effects

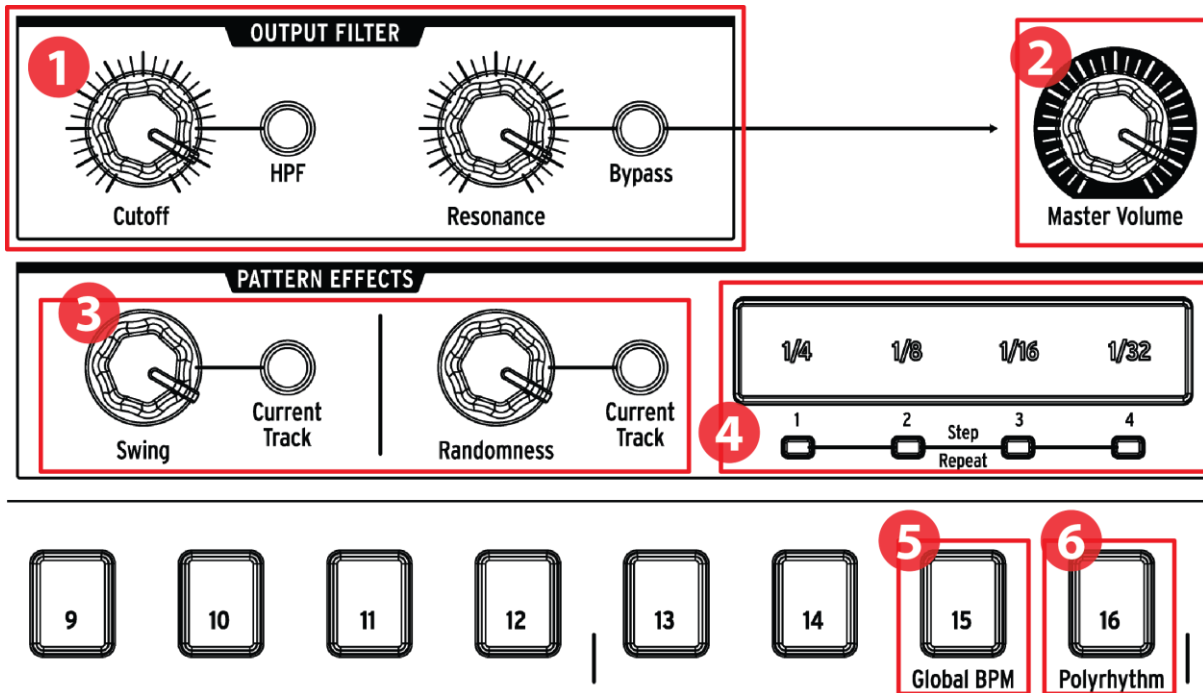

- | | |
|------------------------------|-------------|
| 1. Output filter | (see 2.3.1) |
| 2. Master volume | (see 2.3.2) |
| 3. Pattern effects | (see 2.3.3) |
| 4. Roller/looper/Step Repeat | (see 2.3.4) |
| 5. Shift+15: Global BPM | (see 2.3.5) |
| 6. Shift+16: Polyrhythm | (see 2.3.6) |

2.3.1 Output filter

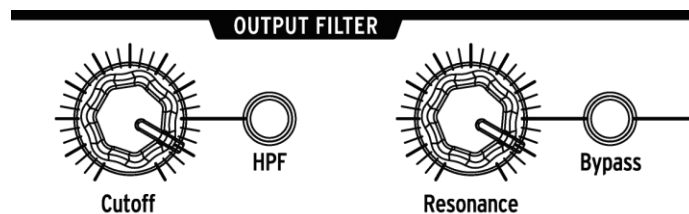

These knobs and buttons add a fun and expressive way to control the overall sound of the DrumBrute during performance. Select the filter type with the HPF button (off = LPF,

or Low Pass Filter), sweep the filter frequency with the Cutoff knob, and use the Resonance knob to control the filter emphasis.

To hear the unfiltered signal, press the Bypass button.

To learn more about the Output Filter options, see section 3.2.1.

2.3.2 Master volume



This knob controls the master output level of the DrumBrute. It does not affect the headphone level; that is controlled by a recessed knob on the rear panel.

! The Master Volume knob will not affect the level of an instrument when a cable is plugged into the rear panel output of that instrument. In this case, use the Level knob above that instrument's drum pad. See section 2.7 for more information.

2.3.3 Pattern effects

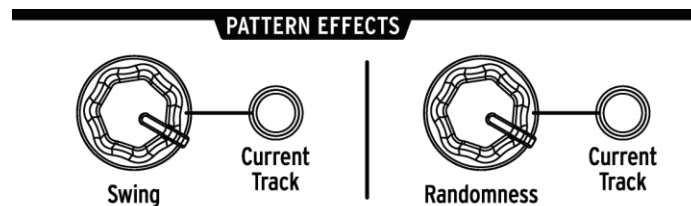

Swing introduces a "shuffle" feel to the patterns. It can affect the entire pattern (all instruments at once) or only the current instrument track, leaving the others untouched.

Randomness introduces an increasing amount of unpredictability to the patterns. As with the Swing setting, this control can affect the entire pattern or only the current instrument track, leaving the others untouched.

For more details on these features, see sections 5.1.7 and 5.1.8.

2.3.4 Roller/Looper/Step Repeat

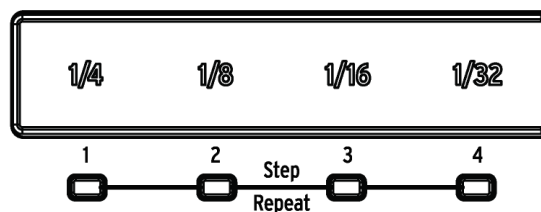

2.3.4.1 Roller

When DrumBrute is recording a pattern the Roller strip can be used to generate drum rolls. Place your finger somewhere within the strip while recording, press a pad, and

DrumBrute will repeat (“roll”) that instrument into the pattern. The rate of the repeat is determined by where you press your finger (1/4, 1/8, etc.).

! The smallest drum roll the pattern can record is set by the timing division you have selected for the pattern. In other words, if the timing division of the pattern is 1/16, DrumBrute will not record 1/32 rolls played on the Roller strip.

2.3.4.2 *Looper*

When a pattern is playing back (i.e., not being recorded) this strip can be used to loop sections of the current pattern. The size of the loop is determined by the time division selected within the Looper strip area. The start and end points of the loop are based on the playback location of the pattern at the time the Looper strip is pressed.

2.3.4.3 *Step Repeat*

The touch strip is also used in Step Mode to enter Step Repeat data. This feature allows you to enter rapid, repeating notes without having to alter the timing value for the pattern. Details about this feature are found in section 5.2.5.

2.3.5 **Global BPM**



Global BPM

It is possible for all patterns to have their own tempo, or you can use this parameter to force them all to play back at the same tempo. To toggle this feature, hold the Shift button and press step button 15.

2.3.6 **Polyrhythm**



Polyrhythm

Individual instrument tracks within a pattern can loop independently when the Polyrhythm feature is enabled. This setting is stored separately for each pattern. To enable this feature, hold the Shift button and press step button 16.

To learn more about the Polyrhythm feature, see section 7.3.

2.4 Instruments + Pads

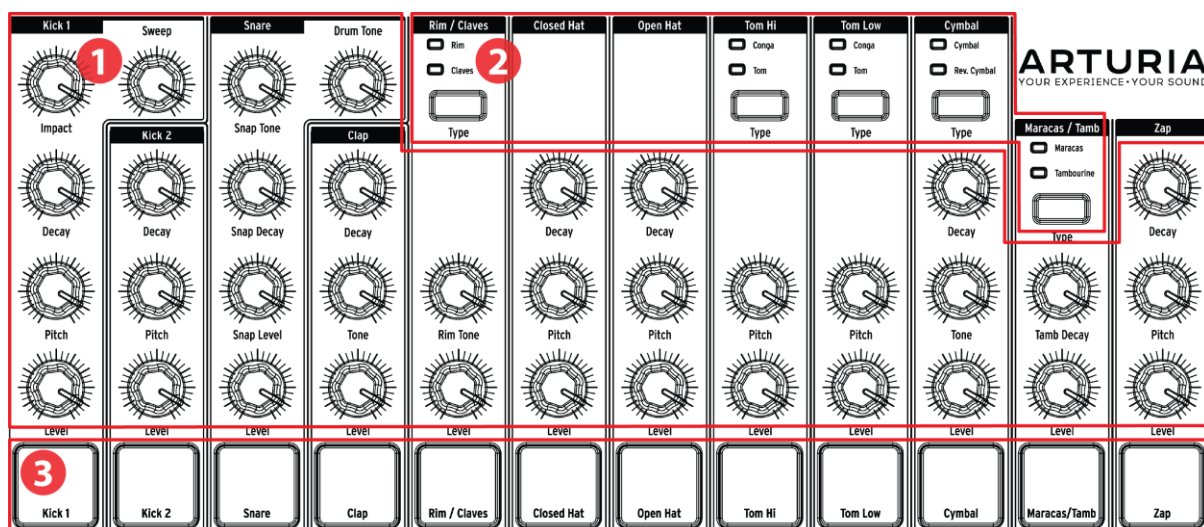

1. Instrument controls (see 2.4.1)
2. Instrument select buttons (see 2.4.2)
3. Pads (see 2.4.3)

2.4.1 Instrument controls

Each instrument has its own set of sound-sculpting parameters. The lines between the instruments indicate which knobs belong to which instrument. Each instrument and its knobs are called an **instrument channel**.

Some instrument channels are shared by two instruments. For example, the Maracas and the Tambourine instruments are both found within the Maracas/Tamb channel. This is known as a **shared channel**.

! The movements of the instrument controls are not recorded as part of a pattern.

2.4.2 Instrument select buttons

These buttons toggle between the instruments in a shared channel. Each instrument in a shared channel can be recorded independently into a pattern.

However, as a general rule the instruments share the instrument controls. For example, if you change the tuning on the Tom Hi instrument the tuning will also change for the Hi Conga.

2.4.3 Pads

The 12 velocity-sensitive pads are used to input note data into a pattern. But they will always trigger their instruments whether DrumBrute is running or not.

Remember that some pads provide access to more than one instrument, each of which has its own track in the pattern sequencer. Counting all of the shared channels, there are actually 16 separate instruments available from the 12 pads.

2.5 Metronome, Mute/Solo + Shift

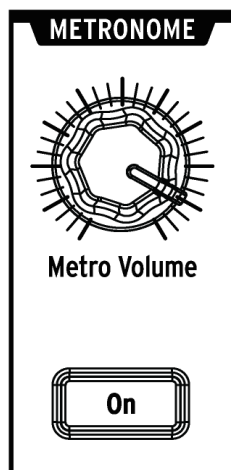

Metronome controls

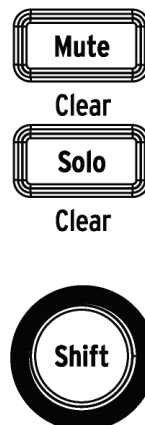

Mute/Solo/Shift buttons

2.5.1 Metronome

To enable the metronome, press the On button. This will provide a timing reference while DrumBrute is running. Various timing values are available for the click. See section 3.1.4 for information about this.

The click level is controlled by the Metro Volume knob. The metronome also has a dedicated output jack on the rear panel.

For a description of the output options for the Metronome see section 2.7.

2.5.2 Mute/Solo buttons

These buttons allow you to silence one or more instruments or isolate specific instruments while recording a pattern or playing it back.

For more information about using the Mute and Solo buttons, see section 5.1.4.

2.5.3 Shift button

The Shift button is used in conjunction with other controls to perform secondary functions such as Fine Tempo adjustment or clearing the Mute group.

Each specific use of the Shift button will be described in the appropriate section of this manual. For a complete list of Shift functions see section 7.4.

2.6 Rear panel, part 1

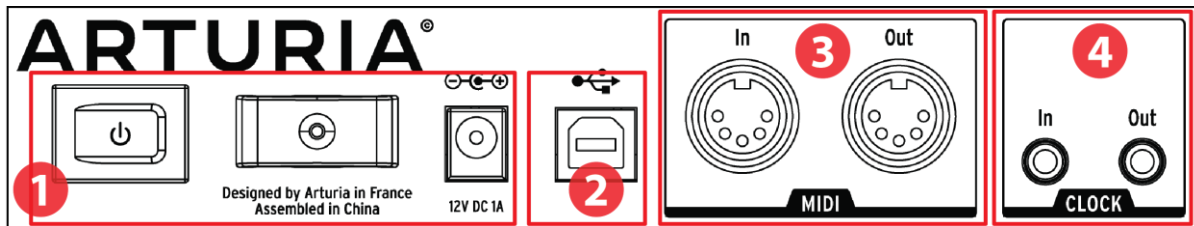

- | | |
|-----------------------|-------------|
| 1. Power | (see 2.6.1) |
| 2. USB | (see 2.6.2) |
| 3. MIDI input/output | (see 2.6.3) |
| 4. Clock input/output | (see 2.6.4) |

2.6.1 Power

From left to right in this section are the power switch, the power cable strain relief, and the 12V DC power connector. Use only the included power supply to avoid damage to the DrumBrute.

2.6.2 USB

This jack provides the data connections to a computer. In addition to working with your DAW, the USB connection enables you to use the MIDI Control Center software to configure extra parameters and to update the DrumBrute software.

2.6.3 MIDI input/output

Use standard MIDI cables to send and receive MIDI note and clocking data between DrumBrute and MIDI-compatible devices.

2.6.4 Clock input/output

The included 5-pin DIN sync adapter allows DrumBrute to interface with pre-MIDI devices that used these connectors for synchronization, such as early drum machines by Korg and Roland. Other vintage devices may use different types of connectors which should be readily available.

2.7 Rear panel, part 2

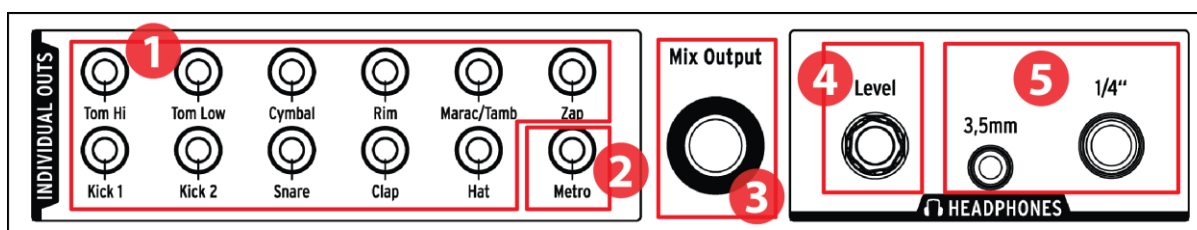

1. Individual Outs (see 2.7.1)
2. Metronome Output (see 2.7.2)
3. Mix Output (see 2.7.3)
4. Headphone Level Control (see 2.7.4)
5. Headphone Outputs (see 2.7.5)

2.7.1 Individual Outs

Each DrumBrute instrument channel has a dedicated 3.5mm output jack on the rear panel. Both instruments of a shared channel will share that channel's output.

When a cable is connected to one of the individual outputs, that instrument channel will be removed from the Mix Output. This is true for the Metronome output as well.

The output level of each instrument channel is set by the corresponding Level knob on the front panel.

2.7.2 Metronome Output

The metronome has its own individual output because the metronome's output circuitry behaves in a slightly different manner than the other instruments. See section 2.7.5 for details.

2.7.3 Mix Output

This output jack carries the output signal for every instrument channel. When a cable is connected to one of the individual outputs, that instrument channel will be removed from the Mix Output. This is true for the Metronome output as well.

The Mix Output level is controlled by the Master Volume knob on the front panel.

2.7.4 Headphone Level Control

This knob is recessed into the rear panel to avoid an accidental change in level. Push the knob inward to release it for adjustment, and push it back in to protect it from further changes.

2.7.5 Headphones

The headphone outputs carry the same signal as the Mix Output and operate the same way, with one exception: When one of the headphone jacks is connected, the metronome will be removed from the Mix Output but will remain in the headphones until its individual output is used.

The behavior of all other connection options is the same for the headphones and the Mix Output, including the metronome: When a cable is plugged into one of the individual outputs, that instrument channel's signal will be removed from both the headphones and the Mix Output.

3 BASIC OPERATIONS

3.1 Working with Patterns

DrumBrute holds 64 patterns, arranged in four banks of 16 patterns each.

3.1.1 Select a bank

In addition to the numbers 1-4, the first four Step buttons are silkscreened with the letters A, B, C, and D. Each one represents a bank of 16 patterns.

To switch between banks, press the Bank button and then select one of the first four Step buttons. After this, press the Ptrn button and select one of the 16 patterns within that bank using the Step buttons.

There is a setting in the MIDI Control Center software that allows you to switch between banks without the additional step of selecting a pattern. See section 10.9.2.13 to learn more about this feature.

3.1.2 Select a pattern

To select a pattern within the current bank simply press one of the Step buttons 1-16. If you are still in Bank mode you will need to press the Ptrn button first and then select the pattern.

DrumBrute will respond in one of two ways if it is running when the selection is made: it will either change immediately to the new pattern or wait until the end of the current pattern. Use the "Wait to Load Pattern" setting in the MIDI Control Center software to specify which behavior you prefer. This is described in section 10.9.2.5.

3.1.3 Set the tempo

When Sync is set to Internal, the tempo range of DrumBrute is 30-300 beats per minute (bpm).

There are three ways to set the tempo for your pattern:

- Turn the Rate/Fine encoder.
- Use the Tap Tempo button.
- For fine tempo adjustment, hold Shift and then turn the Rate/Fine encoder.

Each pattern can have its own tempo, but you can make DrumBrute use the same tempo for all patterns and songs. To do this, hold the Shift button and press Step button 15 (Global BPM). When Step button 15 is lit blue, Global BPM is active.

The MIDI Control Center allows you to specify all features related to tempo and the metronome. See section 10.9.2 for details.

If the DrumBrute Sync parameter is set to something other than Internal clock then you must set the tempo on the master device. For information about all of the Sync settings, see chapter 8.

3.1.4 Enable the metronome

To enable the metronome, press the On button. You will hear a click only when DrumBrute is running. Its output level is controlled with the Metro Volume knob.

The timing value of the metronome may be changed from the front panel. To do so, hold the On button and select a value between 1/8 and 1/32. You will see the selected button turn blue.

Note that it is also possible to “deselect” whichever timing value button is lit. This will result in a 1/4 note click while the unit is running.

There are additional metronome timing values available using the MIDI Control Center.

For a description of the audio output options for the Metronome see section 2.7.

3.1.5 Record a pattern

If you’ve gone through all the steps in this section then let’s make a quick drum pattern. For a more detailed explanation of Record mode, see section 5.1.

- Select an empty pattern, hold the Record button and press the Play button. The Tap Tempo button will begin flashing, and the Step buttons will turn white one at a time to indicate the current position in the pattern.
- Play the pads. The next time DrumBrute crosses that point in the pattern you will hear what you added. Press Stop to exit Record mode.
- If you want to figure out a beat before you begin recording, you can press Play and practice on the pads while the other instruments play their parts.
- When you’re ready, you can enter Record mode ‘on the fly’ while the pattern is looping by pressing the Record button. Or if you prefer, you can stop the pattern and then press Record + Play to start from the beginning.

! If you want to keep what you’ve created, be sure to save the pattern right away or you could lose your work. See the next section to learn how.

3.1.6 Save what you’ve done!

Your new patterns can be lost unless you save them to the flash memory before you change to a different bank, switch to Song mode, or turn off the DrumBrute.

There are two different Save operations:

1. Save the current pattern: hold the Save button and press Ptrn.
2. Save a bank of patterns: hold the Save button and press Bank.

It’s a good idea to back up the DrumBrute memory using the MIDI Control Center, too. Section 10.4 will tell you what you need to know about that.

3.2 Creative Playback Options

Once you have captured the basic pattern idea you want, there are many ways to experiment with it during playback. All four of the following options may be used at the same time, so have fun!

3.2.1 Output Filter

These knobs and buttons allow you to make massive adjustments to the overall sound of the DrumBrute. There are two Filter types available: Low Pass and High Pass.

A Low Pass filter allows you to roll off the higher frequencies of the sound, leaving the lower frequencies untouched until you roll them off also.

A High Pass filter removes the lower frequencies of the sound, leaving the higher frequencies untouched until you remove them also.

The Resonance knob allows you to control the emphasis level of the filter at the corner frequency (i.e., the value you've selected with the Cutoff knob).

 The movements and settings of the Output Filter controls are not saved with the pattern.

Select the filter type you want by toggling the HPF button. When the button is dark (i.e., off), that means the Low Pass filter has been selected.

To switch between the filtered and unfiltered signals, toggle the Bypass button.

3.2.2 Swing

The Swing feature can take a straight, mechanical-sounding beat and make it more interesting by adding increasing amounts of shuffle to the feel. The default Swing setting is 50% and the maximum value is 75%.

Section 5.1.7 covers everything about the Swing feature. For example, it is possible for each pattern and instrument within the pattern can have its own Swing % setting.

3.2.3 Randomness

Increasing the Randomness setting will introduce spontaneous changes in note data and dynamics into the pattern. It can be as subtle or as extreme as you like.

And as with the Swing setting, each pattern and instrument within the pattern can have its own Randomness setting. See the description of the Current Track button in section 5.1.8 for more information.

3.2.4 Looper

The Looper strip allows you to alter the playback of the whole pattern in real time. It will generate smaller loops based on where you touch the Looper strip and when you do it.

3.2.4.1 *Loop length*

The length of the loop is determined by the placement of your finger on the strip, with 1/4 being the largest loop and 1/32 being the smallest. Changing the location of your finger changes the size of the loop.

3.2.4.2 *Loop start point*

The start point of the loop is based on when you touch the strip during playback. You can jump to a different loop position by pressing one of the Step buttons while holding your finger on the strip.

 The Looper strip can be used while recording a pattern to enter drum rolls for individual instruments. See section 5.1.5.

3.2.5 Pause or Restart

The MIDI Control Center allows you to specify the behavior of the Play/Pause button. That setting is called Pause mode.

You'll want to try both options to see which you prefer: one will restart the pattern from the beginning every other time you press the Play button, and the other will pause and resume playback of the pattern from the current position.

See section 10.9.2.12 to learn more about these MIDI Control Center settings.

3.3 All Notes Off

It's possible for a MIDI message to be interrupted for some reason. This can result in a stuck or 'hanging' note on the target device.

If this happens, just press the Stop button quickly three times in a row. It will then send an All Notes Off command over MIDI.

4 SONG MODE

The internal memory of the DrumBrute holds 16 songs, each of which can be up to 16 patterns in length.

4.1 What's a Song?

A song allows you to set up a sequence of patterns that will play back in a specific order. The patterns can be chosen from any one of the four pattern banks.

When a song is selected, the Step buttons will light to indicate how many patterns are in the song. As the song plays the display will show the bank letter and pattern number of each pattern within the song, and the Step buttons will blink in turn to indicate the current position of the song.

The song inherits the tempo setting of each of the patterns it contains, unless the Global BPM feature has been enabled. See section 3.1.3 to learn about this.

When the song reaches its end it will loop back to its beginning and continue to play until the Stop or Play/Pause button is pressed.

The song also uses the Swing and Randomness values from each pattern. Live edits of these parameters are possible, but these are not global edits and they could change between patterns. They will be reset to their individual Pattern Mode values when the song loops or is restarted.

4.2 Selecting a Song

To select a song, press the Song Mode button and then press the Step button that corresponds to the number of the desired song. The Step button will light to indicate your choice.

All of the other Step buttons are used to indicate the number of patterns the song contains. Here's how to interpret what they mean:

- Step buttons that are not lit mean the song uses fewer than 16 patterns. Four dark buttons, for example, means the song uses 12 patterns.
- Similarly, if there are 12 red Step buttons that also means the song uses 12 patterns.
- The Step button that represents the song number will be blue, unless it is also being used to indicate the number of patterns in the song. Then it will be purple (blue + red).

It is possible to switch into a song from Pattern mode or switch between songs while the DrumBrute is running.

 The MIDI Control Center allows you to specify whether the new pattern should load instantly or wait until after DrumBrute reaches the end of its current pattern. See section 10.9.2.5 to learn about this feature.

4.3 Creating a Song

The process of creating a song is very straightforward. Here is how to do it:

- Press the Song button to enter Song mode.
- Choose the location for your song by pressing one of the Step buttons.
- Press the Record button to enter Song writing mode. The Ptrn and Record buttons will blink.
- If you'd like to hear the song as it takes shape, press the Play button.
- Press the Step buttons one after the other to choose their playback order. You can press the same step button multiple times to repeat that pattern.
- You can use patterns from other banks by pressing the bank button and choosing one (A-D). Then press Ptrn to select patterns within the new bank.
- You can enter up to 16 patterns, including the ones you repeated.
- When you have finished building your song, press the Record button to drop out of Song writing mode.

If DrumBrute isn't already running, press the Play button and your song will start.

! Your song will be erased if you press the Record button to leave Song writing mode and then press the Record button again. See section 4.5.

4.4 Saving a Song

To exit Song writing mode, press the Record button a second time. It will go dark, which means you have exited Song writing mode. The song is saved automatically, so there is no need to save the song. It just happens.

4.5 Erasing a Song

If you want to construct a new version of an existing song, here's what to do:

- Press the Song button to enter Song mode.
- Choose the song to be erased by pressing one of the Step buttons.
- Press the Record button to enter Song writing mode.
- **Warning!** The next step will erase your song. If you change your mind, press the Record button again to exit Song writing mode. No change will be made.

- Select a pattern. As soon as you do that, the original song will be erased.

Now you can begin creating a new song (see section 4.3).

4.6 Live performance features

Many of the same playback options are available for Song mode that are found in Pattern mode. There are some differences, so we'll point those out when we get to them.

Some of the performance features are what we call "song-level" features, and others are "pattern-level". Here's a description of each:

- **Song-level** features are not affected when the song loops or when patterns shift banks within the song.
- **Pattern-level** features are embedded in the patterns, so when these patterns are recalled during playback they might be reset to their stored values. They also will be reset if the song is stopped and restarted.

4.6.1 Song-level features

4.6.1.1 Output Filter

The filter controls are always active. Choose between the High Pass and Low Pass filters with the HPF button, set Resonance to the desired level, and sweep the filter frequency with the Cutoff knob.

To toggle the filter on and off, press the Bypass button.

4.6.1.2 The Looper Strip

The Looper strip will generate smaller loops based on where you touch the strip and when you do it.

The length of the loop is determined by the position of your finger on the strip. Changing the location of your finger changes the size of the loop.

4.6.1.3 Pause or Restart

There's a setting called Pause mode in the MIDI Control Center. It lets you decide if the Play/Pause button will restart the song from the beginning or continue from the current position when you resume playback.

See section 10.9.2.12 to learn more about these MIDI Control Center settings.

4.6.2 Pattern-level features

4.6.2.1 Tempo

Each pattern can be saved with its own tempo setting, and as a result it is possible for a song to contain a different tempo every time a different pattern is used.

But there is a front panel parameter that allows you to override these individual tempo values: Global BPM. To activate this feature is simple: just hold the Shift button and press Step button 15.

After this, every song and pattern in the DrumBrute will play at the same tempo, which you may then set to whichever value you like as described in section 5.1.1.

4.6.2.2 *Swing/Randomness*

These features are described in greater detail in chapter 5. When using them in Song mode, keep in mind that any edits you make with the Swing and Randomness encoders could reset to the Pattern mode values when a pattern boundary is crossed, if the next pattern is from a different bank.

These parameters are always reset to the values stored with the patterns when the song is stopped and restarted.

5 PATTERN MODE

5.1 Pattern Creation

5.1.1 Set the tempo

The Rate/Fine encoder controls the Tempo value, which is stored per pattern. It's also possible to override the per-pattern settings with a Global tempo by holding the Shift button and pressing Step button 15. This parameter is called Global BPM, and it is also available in the MIDI Control Center (see section 10.9.2.4).

5.1.1.1 *Fine-tuning the Tempo*

If you want to change the tempo in increments smaller than 1 bpm (to 100.33 bpm, for example), hold the Shift button and turn the Rate/Fine encoder clockwise. Once you've reached the desired value between .00 and .99, release the Shift button.

To reset the fine-tune value to zeroes, turn the Rate/Fine encoder without holding the Shift button.

5.1.1.2 *Tap tempo*

You can set the tempo of your Song using the Tap Tempo button. All you have to do is tap the button at the desired rate and the tempo will change to match your rhythm.

You can set the number of taps it takes to set the Tempo using the MIDI Control Center.

 Tap tempo will not function when the DrumBrute is set to one of the external sync sources.

5.1.2 Time Division

Depending on the current setting, this parameter can be a quick way to double the playback rate of your pattern or cut it in half. Triplet options are available, too.

To set the time division, press and hold the Shift button and then press the Step button that corresponds to the timing you want:

- Eighth notes (1/8)
- Eighth note triplets (1/8T)
- Sixteenth notes (1/16)
- Sixteenth note triplets (1/16T)
- Thirty-second notes (1/32)

The default setting is 1/16.

5.1.3 Recording a Pattern

To record a pattern, hold the Record button and press the Play button. If the pattern is already playing, use the Record button to drop in and out of Record mode.

If DrumBrute isn't running, check the Sync settings (see chapter 8).

Now play one or more pads. Whatever you play will be captured as a part of the pattern. You can toggle individual events on and off in Step mode using the Step buttons. Step mode is covered in section 5.2.

You can also record using an external MIDI/USB source, but the only steps that will be recorded are the ones that correspond to the current drum note mapping. For more about drum maps see section 10.9.4.

5.1.3.1 The Metronome

If you want to hear a timing reference while recording, press the Metronome On button and set the click level with the Metro Volume knob. The metronome features are described more thoroughly in section 3.1.4.

5.1.3.2 Quantize Record

By default, when you are recording in real time the notes will be quantized according to the time division you have selected.

For example, if 1/16 is the time division value then the recorded notes will quantize forward or backward to the nearest sixteenth note. And as the pattern loops you can replace certain notes by playing new ones within the timing range of those notes.

5.1.3.3 Non-quantize mode

It is possible to override the automatic quantizing to some extent. What this will do is widen the time window for capturing the notes you play. The time division setting is still in effect, and notes can only fall within +/- 50% of the time division value.

So it's not exactly real-time recording, but it does allow quite a bit of freedom. And the cool thing is that you can shift individual events forward or backward in time. See section 5.2.6 to learn about that.

If you would like to try this method, hold Shift and press Record. You can re-enable the quantization feature the same way.

5.1.4 Mute/Solo features

The Mute/Solo buttons are great for live performances and creative sessions. They can help you focus on the interactions of any combination of drums at a time, or you can use them to work on one of the drum tracks without hearing the other instruments.

The status of the Mute/Solo buttons is Global, so they affect all patterns and songs. Their settings are not preserved during a power-cycle. There is only one Solo group and one Mute group available.

Mute and Solo do very different things but they work in exactly the same way, so we'll describe them at the same time.

5.1.4.1 Create a Group

Setting up a Mute/Solo Group is very simple. Let's say you want to focus on the Kick 2 and Closed/Open Hat tracks for a few minutes:

- Press the Solo button to enter Solo mode. When it is lit, the Solo group is active.
- Tap the Kick 2, Closed Hat and Open Hat pads. When lit, they are part of the group.

- To toggle the Solo group on and off, press the Solo button. It will flash so you know there's a group being held in the active memory.

The process for setting up a Mute group is identical. So if you want to hear everything but the percussion tracks for a minute, use the Mute button and the appropriate pads to put them into the Mute group.

Keep in mind that you can mute or solo the instruments on a shared channel independently. Simply toggle the Instrument select button for that channel to access the other instrument.

5.1.4.2 *Clear the Group*

Rather than entering Mute/Solo mode and de-selecting each pad in the group, you can clear the group immediately by holding the Shift button and pressing the Mute/Solo button. Then make a new group by selecting the instruments you want in it.

5.1.5 **Using the Roller**

The Roller strip is a quick way to input drum rolls into a pattern. This feature is only available while recording.

5.1.5.1 *How it works*

Using the Roller is simple. Just start recording, place your finger on the Roller strip, and touch a drum pad to create a roll.

The Roller repeats the note at a rate determined by a combination of factors: the clock source, the time division and the position of your finger on the Roller strip.

The output is based on 4/4 time, too. So if your song has a bar of 7/8 and you have your finger on the strip at 1/4, the Roller output will be off by an eighth note after that bar.

5.1.5.2 *Sync settings*

The Roller works even when an external sync source is used. The results may vary depending on the source, though.

If the time division of the pattern is set to a triplet value the roller will play various divisions of triplet beats.

5.1.6 **Spot Erase**

Notes can be erased while the pattern is looping in record mode. To do this, hold the Erase button and then tap the desired pads whenever you hear something you don't want. The next time the pattern loops the notes will be removed from that location.

5.1.7 **Swing**

The Swing setting can change the rhythmic relationship between the first note of a pair and the second note. To experiment with this, start a pattern and turn the Swing encoder to a value between 50 and 75.

Assuming the time division is set to 1/8, here's what will happen:

- With Swing set to 50% each note gets 'equal time', resulting in a 'straight 1/8th note' feel.

- As the Swing value exceeds 50% the first 1/8th note is not affected and the second note is played later. You'll notice the sequence starts to 'shuffle' a bit and perhaps sounds less 'mechanical' to your ear.
- The maximum Swing setting is 75%, at which point the 1/8th notes sound more like a 1/16th note figure than 'shuffled' 1/8th notes.

Here's a graphic showing the minimum and maximum Swing values in musical notation:



5.1.7.1 Current Track button

The Current Track button enables each instrument to have its own Swing setting. After you press that button, changes to the swing percentage will affect only the current instrument. Then you can select the other instruments and edit their Swing settings also.

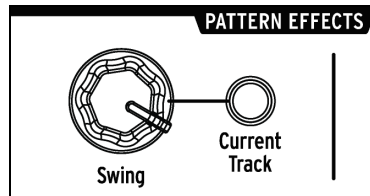

If the current instrument does not have its Current Track button lit and the Swing encoder is turned, the Swing percentage becomes a "Global edit" for the entire pattern. Instruments that previously had no Swing value will begin to swing, and instruments with the Current Track button enabled will have their swing amount increased by the change in the Global value.

In other words, if the Global value goes from 50 to 52, a Current Track value of 63 will rise to 65.

Here is some information to remember about how the pattern Swing value and the Current Track swing values interact:

- The maximum possible swing value is 75, so an instrument's Current Track swing value amount will never rise above that.
- The minimum swing value for an individual instrument track cannot be a lower value than the overall Swing value for the pattern.

The MIDI Control Center can be used to set Swing % values for all instruments and the pattern as well. See section 10.7.5 for information about these parameters.

🎵 To return the entire pattern to the same Swing % you must toggle the Current Track button off for each instrument.

5.1.8 Randomness

The Randomness encoder lets you to add an element of unpredictability to your patterns. The following features will be affected:

- The rhythmic pattern
- The status of note events (Step on/off)

- The velocity of note events (Accent on/off)

The Randomness encoder has a range of 0-100%, with 0% having no effect on the music.

But at 100% the rhythm, velocity and even the existence of note data within the pattern will be entirely random.

To put it bluntly, the pattern will become increasingly disturbed as you increase the Randomness values. You never know what you'll get, but that's exactly the point.

5.1.8.1 Current Track button

Each instrument track can have an independent setting for the Randomness parameter. To experiment with this, press the Current Track button: any changes to the Randomness setting after this will affect only the current instrument. Then you can select the other instruments and edit their Randomness settings as well.

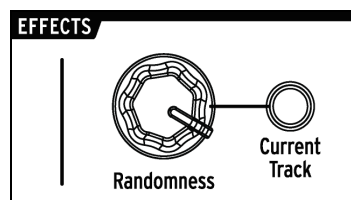

🎵 To return the entire pattern to the same Randomness value you must toggle the Current Track button off for each instrument.

5.2 Pattern Editing

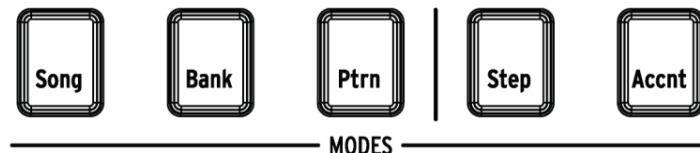

There are two ways to make precision edits to a pattern: Step mode and Accent mode. Each method allows you to make specific edits inside the pattern, and they also can be used to build a pattern from the ground up if you like.

You can make edits to a pattern in either mode whether the pattern is recording or paused.

5.2.1 Step Mode

To enter Step mode, press the Step mode button.

The Step buttons will display the events that exist in the pattern for the selected instrument. A Step button that is lit contains an event, while a dark Step button means that step is not yet being used in the pattern.

Use the Step buttons to toggle events on and off as needed. Events that you toggle from Off to On within Step mode will always be blue.

5.2.2 Accent Mode

Accent mode is a quick way to increase the velocity of a particular step inside an instrument track. A Step button that is lit red indicates that an Accent event occurs at that step.

Use the Step buttons to enter Accent events. Events that you toggle from Off to On within Accent mode will always be red. Events that are blue indicate that an event already exists in the pattern at that step but it has not yet been accented.

The MIDI Control Center allows you to define what the MIDI velocity of accented steps will be. See section 10.9.2.6 for information about this MIDI Control Center feature.

5.2.3 Red state, Blue state

Step buttons will display one of three states whether you are in Step mode or Accent mode. They can be dark (no event), lit blue (event present), or lit red (accented event).

The behavior in each mode may be confusing at first. Here's a chart that should help explain what is happening:

Step mode	Button press 1	Button press 2	Button press 3
Off	Blue (new event)	Off	Blue
Blue	Off	Blue	Off
Red	Blue	Off	Blue
Accent mode			
Off	Red (new event)	Off	Red
Blue	Red	Off	Red
Red	Off	Red	Off

5.2.4 Selecting a Drum...

5.2.4.1 ...while paused

To select an instrument track for individual editing, simply tap a pad. When the pad is lit solid that means the instrument has been selected.

5.2.4.2 ...while recording

It can be useful to both hear and see what various instruments are contributing to a pattern. But if you touch a pad while the pattern is recording it will enter a note.

To select an instrument without entering a note while recording, hold the Shift button and tap the desired pad. Its track data will now be displayed by the Step buttons.

5.2.5 Step Repeat

This feature lets you use the Roller/Looper strip to enter quick, glitchy events into your patterns without having to switch to a different time division and tempo. It works by adding triggers between existing steps.

You may have noticed the LEDs and numbers outside of the area of the Roller/Looper strip where you place your finger:

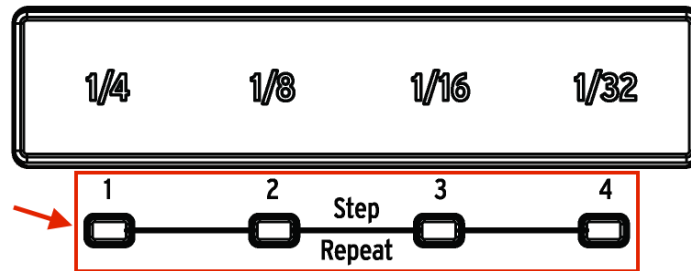

When you touch the strip one of the LEDs will light, and as you move your finger different LEDs will activate. While recording or playing back a pattern the position of your finger will trigger loops or drum rolls and divide the beat by "halves": cut 1/4 in half and you get 1/8, cut 1/8 in half and you get 1/16, and so on.

But in Step mode there is a triplet trigger option, too! So you can subdivide the step in several ways without having to change the time division for the entire pattern.

Here are a couple of screen shots from the MIDI Control Center that should help illustrate the concept:

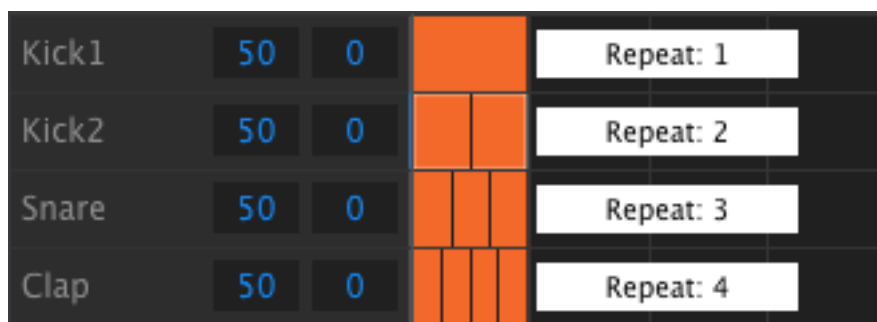

Step repeat events subdivide a step.



Step repeat used on alternating instruments

The Step Repeat feature is only available in Record mode. Here's how to use it:

- Create a pattern with a simple Kick 1 pattern on each beat. Let it loop.
- Enter Step mode mode and select the kick drum (press Shift + Kick 1).
- Press and hold one of the lit Step buttons. A white LED will light beneath the Roller/Looper strip at the default value of 1.
- While holding the Step button, slide your finger along the strip to select a value of 2. The next time the pattern reaches that point you will hear the kick drum play twice in the space of a single step.

- Try the same process with Step Repeat values of 3 and 4 on other steps to hear the difference between them.

You will quickly see how easy it is to create exciting and innovative patterns using the Step Repeat feature!

5.2.6 Shift timing

Sometimes the secret to a killer groove is when one or more instruments are landing consistently behind the beat. Alternately, if one of the instruments is always a bit ahead of the beat it can increase the sense of urgency in the music.

DrumBrute allows you to shift the timing of any step forward or backward by up to 50% of the pattern's timing value. It's easy to do:

- Create a pattern with a kick and snare, and add 1/8th notes on the Closed Hat. Let the pattern loop.
- Enter Step mode mode and select the closed hat (press Shift + Closed Hat).
- Press and hold one of the lit Step buttons.
- While holding the Step button, turn the Swing encoder counter-clockwise. The display will begin to show negative numbers from -1 to -50. The selected event is being shifted so it will play slightly earlier in the pattern, as you will hear the next time the pattern loops.
- Repeat the process using a different event, only this time turn the encoder clockwise. The display will show positive numbers from 1 to 50, which means the selected event is being shifted to play slightly later in the pattern, as you will hear the next time the pattern loops.

Once you have the groove sounding exactly right, remember to save the pattern (hold Shift and press the Ptrn button).

5.2.7 Copy a Drum Track

Once you have the timing and dynamics exactly right for a certain instrument you might want to use that track in another pattern, or maybe even double that track on another instrument within the same pattern. The following procedures will save you the time it would take to recreate the part somewhere else.

 If the time division of the target pattern is different from the source pattern then they will not sound the same at first. You may want to change the time division of the target pattern until it matches the source pattern. See section 5.1.2 for information.

5.2.7.1 *Within a pattern*

Let's say you'd like to copy the Closed Hat track to the Tambourine track. This is a bit trickier than normal, because you'll be copying from a single instrument to a shared instrument channel. But even this process is so easy that you'll have no trouble with copying between single-channel instruments.

Select a pattern with an interesting Closed Hat part and then follow these steps:

- Press and release the Copy button. The Bank and Ptrn buttons and all of the pads will flash.
- Press the Closed Hat pad. This is the track that will be copied.
- Press the instrument select button for the Maracas/Tamb shared channel until the Tambourine LED is lit.
- Tap the Maracas/Tamb pad. It will flash quickly so you will know the process is complete.

When copying between single-channel instruments, simply skip the third step in the process.

5.2.7.2 *Between patterns*

The process of copying an instrument track between patterns in the same bank is almost identical to the one described above. We'll only copy tracks between single-channel instruments this time.

! The following procedure will overwrite the Closed Hat track in the target pattern.

Select a pattern with an interesting Closed Hat part and then follow these steps:

- Press and release the Copy button. The Bank and Ptrn buttons and all of the pads will flash.
- Press the Closed Hat pad. This is the track that will be copied.
- Press the Ptrn button.
- Select the target pattern by pressing one of the Step buttons.
- Tap the Closed Hat pad. It will flash quickly so you will know the process is complete.

To copy the Closed Hat track to a different instrument in the target pattern, select that instrument's pad in the final step instead of the Closed Hat pad.

♪ The copy procedure in section 5.2.7.2 happens "behind the scenes" in the Flash memory, not in the active RAM. So if you want to audition the copied track(s) in the target pattern immediately, you will need to load the pattern into RAM from the Flash memory. To do so, select the pattern, hold the Shift button and press Ptrn.

5.2.7.3 *Between banks*

The process of copying an instrument track between patterns in different banks is almost identical to the procedures described above. We'll only copy tracks between single-channel instruments this time.

! The following procedure will overwrite the Closed Hat track in the target pattern.

Select a pattern with an interesting Closed Hat part and then follow these steps:

- Press and release the Copy button. The Bank and Ptrn buttons and all of the pads will flash.

- Press the Closed Hat pad. This is the track that will be copied.
- Press the Bank button.
- Select the target bank by pressing one of the first four Step buttons.
- Press the Ptrn button.
- Select the target pattern by pressing one of the Step buttons.
- Tap the Closed Hat pad. It will flash quickly so you will know the process is complete.

To copy the Closed Hat track to a different instrument in the target pattern, select that instrument's pad in the final step instead of the Closed Hat pad.

5.2.8 Erasing a Drum Track

If you've decided you don't want a certain instrument track to be part of the pattern any more, the process couldn't be simpler:

! Be sure you've selected the correct pattern. This process cannot be undone.

- Press and release the Erase button. The Bank and Ptrn buttons and all of the pads will flash.
- Tap the pad of the instrument track you want to erase. It will flash quickly and then stop, so you will know the process is complete.

5.2.9 Pattern Length

The default length is 16 steps, but a pattern can be up to 64 steps long.

If you'd like your pattern to be less than 16 steps long, simply hold the Last Step button and then press the Step button that corresponds to the desired setting.

5.2.9.1 Pattern Follow mode

When working with patterns longer than 16 steps there is an important feature to know. When the double arrow buttons (« ») are pressed at the same time, their LEDs will toggle off and on. This takes DrumBrute into and out of Pattern Follow mode.

When this mode is active during playback, the Step Group LEDs and the Step buttons will show steps 1-16, then steps 17-32, then return to steps 1-16, and so on.

When « » LEDs are	Pattern Follow mode is
Dark	OFF
Lit	ON

Remember: the playback of the pattern itself is not affected when Pattern Follow mode is enabled. This only affects what you are seeing, which can make it easier to edit particular sections of the pattern.

5.2.9.2 Lengths > 16 steps

To make your pattern longer than 16 steps will involve the Last Step button, the « » buttons, the Step Group LEDs, and the Step buttons.

For example, let's lengthen a 16-step pattern to 32 steps.

Here's what to do:

- Select a 16-step pattern.
- Hold the Last Step button.
- Press the >> button once. A white LED will appear above the number 32.
- Press Step button 16 (technically it's button 32 now). It will turn blue.
- Release the Last Step button. Step 32 has now been defined as the last step in the pattern.

Now press << and >> at the same time to enter Pattern Follow mode (the buttons should be lit).

Next, press Play. You should see the Step buttons cycling through two sets of 16 steps, one with data and one without.

You should also see the Step Group LEDs changing every 16 steps:

- Steps 1-16: Red LED over #16, White LED over #32
- Steps 17-32: dark LED over #16, Pink LED over #32 (White + Red)

The Red LED indicates the current Step Group within the pattern. The White LED means that the last step in the pattern is in that Step Group.

If you decide you want more than 32 steps for this pattern, hold the Last Step button and press >> until the White LED is over the correct Step Group number. Then press the appropriate Step button and you're ready to create.

5.2.9.3 *Editing steps 17-32*

If you want to focus on steps 17-32 while editing, here's what to do:

- Disable Pattern Follow mode (turn off the << >> buttons).
- Press >> once to move the Red LED over #32.

The Step buttons now show the status of steps 17-32. You can play the pattern while editing, if you want; it will play all 32 steps, but the Step buttons will stay focused on steps 17-32.

Simply edit the steps as desired with the Step buttons, or play them on the pads. When you're finished you can re-enter Pattern Follow mode with the << >> buttons if you like.

5.3 **Save the Pattern!**

! If you switch between banks you will lose any edits you have made to the patterns within the original bank. This will also happen if you switch to Song mode.

It's a good idea to save your patterns often while you are working on them.

To save the current pattern, hold the Save button and then press the Ptrn button. Both buttons will flash quickly to indicate that your pattern has been saved to the internal memory.

5.4 Copy a Pattern

There may be times when you would like to have a pattern become the basis for another section within a song, only with a few modifications. Copying the pattern into a different location can be a quick way to accomplish this.

! The following procedure will erase pattern #8 in the current bank. Be sure that pattern location is available before proceeding.

Let's say you'd like to copy pattern #1 to pattern location #8 within the current bank. Here are the steps to follow:

- Select pattern #1 by pressing Step button 1.
- Press the Copy button. Lots of buttons will flash to indicate you are in Copy mode. Step button 1 should be lit solid, which means it is the pattern being copied.
- You want to copy a pattern, not a bank, so press the Ptrn button. The Copy and Ptrn buttons will flash, and Step button 1 will now flash also.
- Step buttons 2-15 will be lit solid, which means they are potential destinations for the pattern being copied.
- Press Step button 8. It will flash for half a second, and then Step buttons 2-15 will go dark so you'll know the process is complete.

To learn how to copy a pattern between banks, see section 6.2.2.

6 COPY/ERASE FUNCTIONS

6.1 Copy Bank to Bank

! The following procedure will overwrite all 16 patterns in the target bank. Be sure this is what you want to do before you proceed.

It is possible to copy all 16 patterns from one bank to another bank.

Let's say you want to copy the patterns from bank C into bank D. Here's how:

- Press the Bank button.
- Select bank C by pressing Step button 3.
- Press the Copy button. Lots of buttons and pads will flash.
- Press the Bank button again. Step button 3 will flash, which means it is the bank being copied.
- Select bank D by pressing Step button 4. That button will flash rapidly for about a second.

When the flashing stops the process is complete. The source bank (bank C in this case) will still be the selected bank.

6.2 Copy Pattern to Pattern

6.2.1 Within a Bank

This procedure was covered more extensively in section 5.4, but here are the basics. To copy a pattern to a new location within the current bank:

- Select the source pattern.
- Press the Copy button.
- Press the Ptrn button.
- Press the Step button for the target location. It will flash for half a second, and then all Step buttons will go dark except one for the original source button.

6.2.2 Between Banks

The following procedure will allow you to copy a single pattern from one bank into a different bank.

Let's say you'd like to copy pattern #7 from Bank A to pattern location #15 in Bank B:

- Select Bank A, pattern #7.
- Press the Copy button.

- Press the Ptrn button.
- Press the Bank button.
- Press Step button 2 to select Bank B.
- Press the Ptrn button.
- Press Step button 15. It will flash for about a second so you'll know the process was successful.

6.3 Copy Drum to Drum

These procedures were covered extensively in section 5.2.7:

- To copy an instrument track to another instrument within the same pattern, see section 5.2.7.1.
- To copy an instrument track into a different pattern in the same bank, see section 5.2.7.2.
- To copy an instrument track into a pattern in a different bank, see section 5.2.7.3.

6.4 Erasing a Bank

To erase all 16 patterns in a bank:

- Be sure you know which bank you want to erase. This process cannot be undone.
- Press the Erase button. Lots of buttons and pads will flash.
- Press the Bank button. The Step button for the currently selected bank will flash.
- Use the Step buttons to select the bank you want to erase. It will flash rapidly for about a second.

When the flashing stops, the process is complete.

6.5 Erasing a Pattern

To erase one of the patterns in a bank:

- Be sure you know which pattern you want to erase. This process cannot be undone.
- Press the Erase button. Lots of buttons and pads will flash.
- Press the Ptrn button. The Step button for the currently selected pattern will flash.
- Use the Step buttons to select the pattern you want to erase. It will flash rapidly for about half of a second.

When the flashing stops, the process is complete.

6.6 Erasing a Drum Track

This process was covered in section 5.2.8. Here are the highlights:

- Press the Erase button. Lots of buttons will flash.
- Tap the pad of the drum track you want to erase. It will flash quickly and then stop, so you will know the process is complete.

7 ADVANCED FEATURES

7.1 Extend a pattern

A pattern can be lengthened in two different ways: by adding blank steps, or by taking the data from the first 16 steps and copying it to the end of the pattern.

7.1.1 Adding blank steps

The process of adding blank steps involves using the >> button and the Last Step button. This was covered in section 5.2.9.

7.1.2 Copy and append

It's also possible to extend a pattern by copying up to 16 steps of pattern data and attaching it to the end of the existing pattern. Patterns can be extended up to the maximum length of 64 steps.

To extend a pattern, hold Shift and then press the >> button. This will copy the first 16 steps of the pattern into the next Step Group, making the pattern 32 steps long.

Here are some rules to keep in mind:

- If the pattern has 16 or more steps, only the first 16 steps are copied and appended to the end.
- If the pattern is shorter than 16 steps, then that number of steps is copied and the sequence is doubled in length.

Here are some examples of this process in action:

Example 1

Original size	Action	New size	Reason
16 steps	Shift + >>	32 steps	Steps 1-16 were copied / appended to step 17
	Shift + >>	48 steps	Steps 1-16 were copied / appended to step 33

Example 2

Original size	Action	New size	Reason
32 steps	Shift + >>	48 steps	Steps 1-16 were copied / appended to step 33

Example 3

Original size	Action	New size	Reason
7 steps	Shift + >>	14 steps	Steps 1-7 were copied / appended to step 8
	Shift + >>	28 steps	Steps 1-14 were copied / appended to step 15
	Shift + >>	44 steps	Steps 1-16 were copied / appended to step 29

7.2 Shorten a pattern

To make a 64-step pattern shorter uses a slightly different procedure. Let's say you want the pattern to be 48 steps long instead:

- Hold the Last Step button until the process is complete.
- Press the << button to select Step Group 3. The "48" LED will light.
- Still holding the Last Step button, press Step button 16. It will turn blue, which means the pattern is now 48 steps long.
- If you want the pattern to be even shorter, start over and press the << button until the proper Step Group is selected.

To select a pattern length other than a multiple of 16, use the Last Step button and press the appropriate Step button to define the final step in the pattern. This process is described in section 5.2.9.

7.3 Polyrhythm mode

This feature is as interesting as it is unusual. And it has the potential to unleash creative explorations you might never have considered otherwise.

7.3.1 What is Polyrhythm mode?

Usually a drum machine pattern will operate within a single time signature, such as 4/4 or 12/8. For example, with a single measure of 4/4 there are sixteen 16th notes, and if a drum only plays on the downbeat it must wait another 15 steps before it plays again.

But with the DrumBrute's polyrhythm feature you can specify a different time signature for each instrument track! This could mean you'd have 16 loops of different lengths all happening at the same time.

7.3.2 What it does

Here's an example: What if you wanted a pattern with this mixture of time signatures:

Instrument	Kick 1	Kick 2	Snare	Clap	Rim
Time signature	3/16	1/4	5/16	3/8	4/4

The Rim track is the longest, so we'll use that as the timing reference for our discussion. Here's how those tracks would look in the MIDI Control Center:



But here's a visual representation of how they would sound during the first bar:

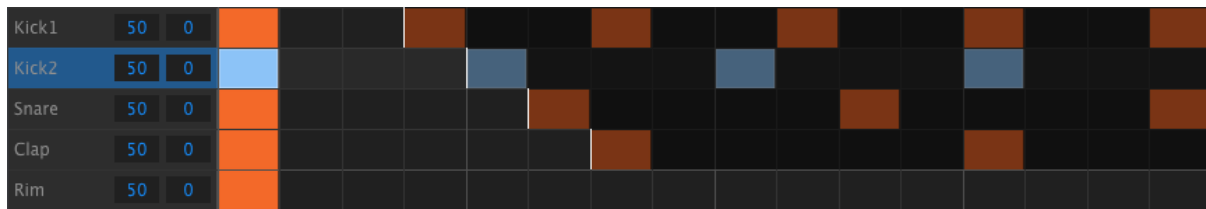

And during the second bar:

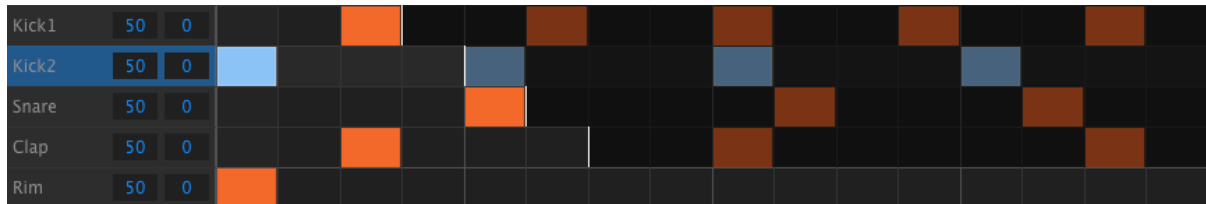

The second loop, Kick 2, is highlighted as a rhythmic reference. It plays on quarter notes 1, 2, 3, and 4, and the Rim will play on beat 1 every time.

But the other instruments will continue their shorter loops: Kick 1 will play its cycle of 3, the snare a cycle of 5, and the clap a cycle of 6. They will play at different times in relationship to each other for quite a while.

In this example it will be 360 bars of 4/4 time before the first bar is heard again!

To toggle Polyrhythm on and off, hold the Shift button and press Step button 16.

7.3.3 Make a polyrhythm

Here's how to start building the example from the previous section.

1. Select an empty pattern.
2. Hold Shift and press Step button 16. It will turn blue to show that the pattern is in Polyrhythm mode.
3. Tap the Kick 1 pad to select it.
4. Press Step to enter Step mode.
5. Hold the Last Step button and press Step button 3. Kick 1 now has a 3-step loop.
6. Press Step button 1 to add an event to the first step of the Kick 1 loop.
7. Press Play to confirm. If the pattern was blank before, it should now be only 3 steps long. If so, stop the pattern.
8. Tap the Kick 2 pad to select it.
9. Hold the Last Step button and press Step button 4. Kick 2 now has a 4-step loop.
10. Press Step button 1 to add an event to the first step of the Kick 2 loop.
11. Tap the Snare pad to select it.
12. Hold the Last Step button and press Step button 5. Snare now has a 5-step loop.
13. Press Step button 1 to add an event to the first step of the Snare loop.

14. Press Play to confirm. The pattern is now 5 steps long, and you should hear the intersecting rhythms of all three instruments.

Try your own experiments! Just be sure to save the pattern if you like what you're hearing.

7.4 Shift button chart

The Shift button allows you to access important features. Here's a chart of the available Shift functions:

Shift+	Function
Step buttons 1-5	Sets the time division for the pattern
Step button 15	Toggles Global BPM on and off
Step button 16	Enables Polyrythm mode for the pattern
Pad	Choose current Drum to edit without triggering the sound
Rate/Fine	Increments or decrements the tempo to the 100th decimal place
Record	Turn off Quantize recording
Mute	Clear Mute group
Solo	Clear Solo group
>>	Extends the length of the sequence
<<	Shortens the length of the sequence
Bank	Revert bank to last saved state (i.e., load from Flash memory)
Ptrn	Revert pattern to last saved state (see section 5.2.7.2)

8 SYNCHRONIZATION

DrumBrute can be the master clock for an entire MIDI rig, or it can just as happily serve as a slave to any one of several sources. See section 2.1 for connection diagrams.

You can cycle through the various Sync options using the Sync button. A white LED will let you know which mode you've selected.

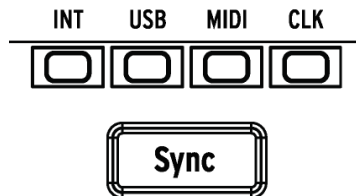

 The Sync setting cannot be changed while DrumBrute is playing a pattern.

8.1 As Master

DrumBrute is the master clock when the INT button is lit. When this is the case:

- The transport section will control the internal sequencer.
- MIDI clock messages are sent to MIDI out, USB MIDI, and the Clock output.
- The tempo can be set using the Rate/Fine encoder and the Tap Tempo button.
- Hold Shift and turn the Rate/Fine encoder to fine-tune the tempo.

8.2 As Slave

DrumBrute functions as a slave to an external clock when one of the other three Sync LEDs are lit (USB, MIDI or CLK). When DrumBrute is in Slave mode:

- The Tempo controls will not control the internal sequencer while the external source is running.
- The DrumBrute transport section will work the same way: you can still stop, start and pause the internal sequencer, and you can still record patterns.
- When the external source is not running, DrumBrute will function according to its own internal clock at the last known tempo.
- DrumBrute will pass the synchronization messages it receives from the external source to its USB, MIDI and Clock outputs.

8.2.1 Clock In/Out rates

The MIDI Control Center can be used to configure DrumBrute to send and receive one of the following clock signals at the Clock input and output connectors:

- 1step (one pulse per quarter note , or ppqn)
- 2PPQ (Korg standard)
- 24PPQ (standard DIN sync)
- 48PPQ

The default rate is 1step.

8.2.2 Clock connectors

There are several types of connectors that have been used for musical synchronization purposes over the years. Here's a chart that indicates the best kinds to use when connecting older devices to DrumBrute:

<i>Connector type</i>	<i>Signal(s) sent</i>
1/8" mono (TS)	Clock pulse only
1/8" stereo (TRS)	Clock pulse and start/stop
1/8" stereo (TRS) plus DIN sync adapter	Clock pulse and start/stop

Check the owner's manual for your device if you are not sure which sort of sync capabilities it has.

9 MIDI CONTROL CENTER BASICS

The MIDI Control Center is an application that allows you to configure the MIDI settings of your DrumBrute. It works with most of Arturia's devices, so if you have an earlier version of the software you'll want to download the DrumBrute version. It will work with those products as well.

9.1 System requirements

PC: 2 GB RAM; CPU 2 GHz (Windows 7 or higher)

Mac: 2 GB RAM; CPU 2 GHz (OS X 10.7 or higher)

9.2 Installation and location

After downloading the appropriate MIDI Control Center installer for your computer from the Arturia website, double-click on the file. Then all you have to do is start the installer and follow the instructions. The process should be trouble-free.

The installer puts MIDI Control Center with the other Arturia applications you have. In Windows, check the Start menu. On an OS X Macintosh computer you'll find it inside the Applications/Arturia folder.

9.3 Connection

Connect DrumBrute to your computer using the included USB cable. It'll be ready to go after its LEDs go through the startup cycle.

Now launch the MIDI Control Center. DrumBrute will be in the list of connected devices:

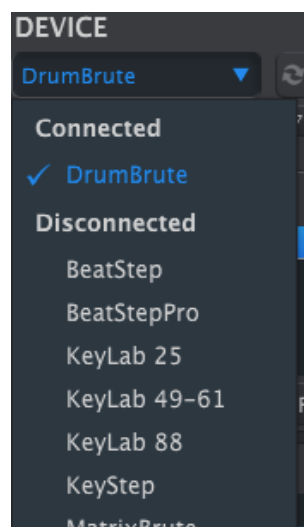

9.4 Back up your sequences

If you want to make a quick backup of your DrumBrute memory, click the Sync button:

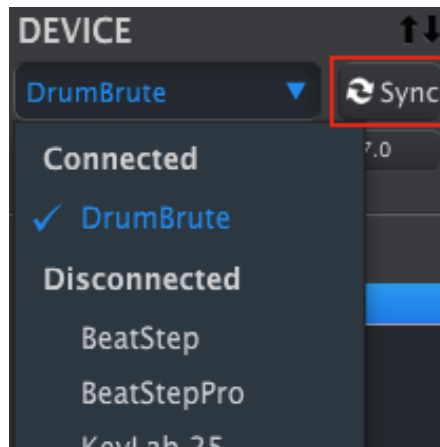

This will grab whatever has been saved to the flash memory and pull it into your computer. MIDI Control Center will give this file the current date/time stamp for a name, but you can name it something else if you like.

After this, every change made in the software will also be made inside DrumBrute.

🎵 It's possible to use most functions of the MIDI Control Center even when it has not been synced to DrumBrute. There may be times you prefer not to sync the two.

We'll go through these concepts in greater detail in chapter 10.

9.5 Where to find the manual

There is a built-in help file for the MIDI Control Center in its Help menu, as shown below:

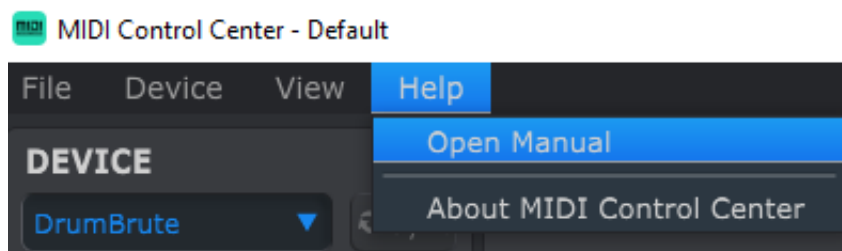

It's a good introduction to the MIDI Control Center, describing each section of the software window and defining important terms you will need to know while using the MIDI Control Center, such as 'Working Memory' and 'Template'.

The next chapter explains how to use the MIDI Control Center software to configure the DrumBrute so you can optimize your workflow.

10 USING MIDI CONTROL CENTER

The built-in MIDI Control Center manual has general descriptions of the features that are common to all Arturia products. To learn how to access the manual, see section 9.5.

This chapter will cover only the MIDI Control Center features that are unique to DrumBrute.

10.1 The Sync option

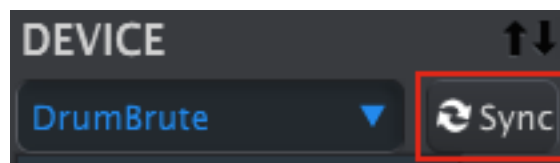

As mentioned in section 9.4, clicking the Sync button is a quick way to back up your DrumBrute patterns. It also allows you to do other things we'll cover later in this chapter.

However, there are some things you can do even if you don't click the Sync button. Here's a quick overview of the different states:

10.1.1 Sync operations

The MIDI Control Center (MCC) does the following when you click the Sync button:

- It automatically makes a backup copy of the internal DrumBrute patterns. This is known as a Template.
- It updates the Device Settings window with the settings from the DrumBrute. These must be saved using the Device Settings Export button (see section 10.5).
- It allows live editing of patterns from within the MCC window. This is an extremely useful feature, which we'll cover in section 10.7.4.

! If the MCC and DrumBrute are synced, every time you click on a Template in the Project Browser window it will be sent to the DrumBrute internal memory. Any changes you have made from the DrumBrute front panel will be lost.

10.1.2 Non-sync operations

When the MIDI Control Center and DrumBrute are not synced there are plenty of features available. For example, you are able to:

- drag and drop one of the patterns in the Project Browser to one of the Bank tabs
- send a single pattern to the DrumBrute internal memory
- use the Store To and Recall From buttons to transmit an entire set of 64 patterns

- edit the Device Settings
- perform other MCC functions such as pattern editing, file management and Template creation, among other things.

Note: The MCC will do all of these things when the MCC and DrumBrute are synced also.

10.2 Device Templates

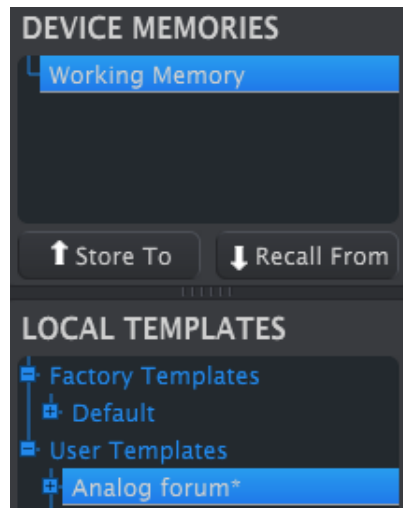

10.2.1 The Working Memory

When the MCC and DrumBrute are in sync, the Working Memory is the internal memory of the DrumBrute. Edits made to patterns inside the MCC are made simultaneously to the DrumBrute.

When they are not in sync the Working Memory functions as a sort of 'target' onto which Templates or patterns can be dragged and then transmitted to the DrumBrute memory. But edits made to patterns inside the MCC when not in sync do not edit the patterns inside the DrumBrute.

10.2.1.1 Live editing

After you click the Sync button the internal DrumBrute memory is shown inside the MCC in the Seq Editor window. Any edits you make to these patterns will also be made in the DrumBrute. This is called "live editing."

! Live editing works in one direction: from the MCC to DrumBrute. Changes made from the DrumBrute front panel are not detected by the MCC. Use the Recall From button to back them up to your computer before selecting another Template.

Important: When you make a change in the Seq Editor window an asterisk (*) will appear next to the name of the selected Template. These changes are not automatically saved, so you will need to use the Save or Save As... buttons to preserve your new pattern data.

10.2.1.2 Drag and drop

It's possible to drag a single pattern or a Template from the Project Browser onto the Working Memory. When you do, the pattern(s) will be sent to the DrumBrute internal memory. See section 10.3 for information about this.

10.3 Project Browser

The Template Browser shows a list of all the Templates that have been archived using the MIDI Control Center. These are divided into two main groups: Factory and User.

The User Templates are the ones you have recalled from the DrumBrute using the MIDI Control Center. See section 10.4 to learn how to do this.

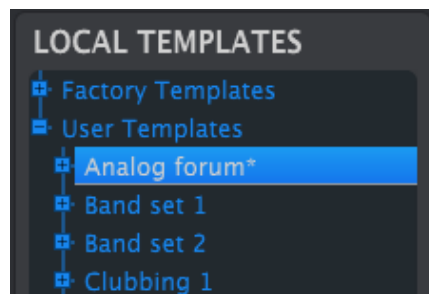

The Template Browser window

A Template in the MCC contains the same number of patterns as the internal memory of the DrumBrute, and it also has them arranged into four banks of 16 patterns each.

! A Template does not contain the Device Settings. We'll show you how to save those separately in section 10.5.

Here's an expanded view of the banks inside a Template named "Analog Forum", with a secondary view of the patterns inside Bank A.

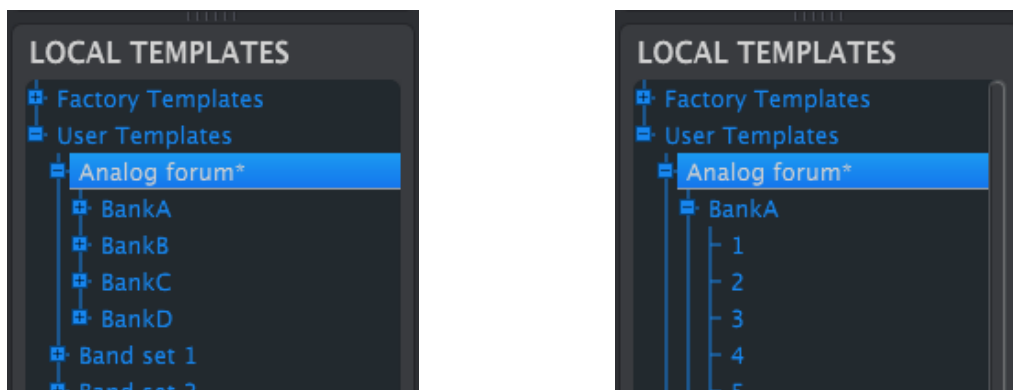

User Templates: click +/- to expand or collapse Template view

10.3.1 Building a library

You can build a limitless library of patterns in the User Templates area.

Make as many patterns as you like, wherever you are. Then the next time you use the MIDI Control Center, simply press the Recall From button. This will transfer the DrumBrute pattern memory into the Working Memory of the MCC.

At the same time the MCC will also create a new Template in the User Templates area. The Template will be named automatically with a date/time stamp, but you can give it a more descriptive name if you like.

10.3.2 Revise a Template

10.3.2.1 While synced

If the MIDI Control Center and DrumBrute are already in sync, it's easy to modify an archived Template. Simply select one and its patterns will appear in the Pattern Editor window. They will also be transmitted to the DrumBrute internal memory.

As long as DrumBrute and the MCC are in sync, any changes made to the patterns inside the MCC will also be made in the DrumBrute. You can actually have the pattern running inside the DrumBrute while you make edits with the MCC, and then hear the edited pattern the next time the pattern loops.

 When an edit is made an asterisk will appear next to the name of the source Template. This means you need to use the Save or Save As... buttons to preserve your new sequence data.

See sections 10.6 and 10.7 to learn about editing patterns in the Pattern Editor window.

10.3.2.2 Not synced

If the MIDI Control Center and the DrumBrute are not in sync you can still edit the patterns of an archived Template. Simply select that Template and its patterns will appear in the MCC Pattern Editor window, ready for editing.

If you would like to confirm the results by having the patterns played on the DrumBrute, there are two ways.

 The following process will **overwrite** the Working Memory and the pattern memory of the DrumBrute. Be sure to save what you were doing before you transfer the file!

First use the Save or Save As... buttons to save your changes, then:

- drag the revised Template from the Local Templates window and drop it on the Working Memory, or
- press the Store To button (see section 10.4).

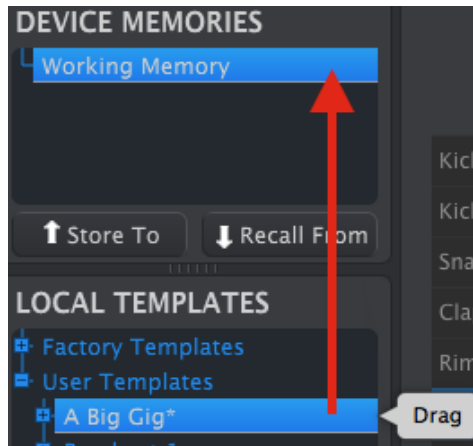

Sending an edited Template to DrumBrute (not synced)

10.3.3 Send one pattern to DrumBrute

10.3.3.1 When synced

Important: The following process will send a single pattern to DrumBrute **and will overwrite the pattern** in the target memory location.

There are two ways to send a single pattern to the DrumBrute when it is synced to the MIDI Control Center.

First use the +/- buttons in the Local Templates window to open the Template and locate the pattern you want to send. Then you can do one of two things:

- drag the pattern on the Working Memory. It will be sent into the DrumBrute at the same pattern location as the source pattern (i.e., #1 will go to #1)
- drag the selected pattern to one of the 16 pattern tabs in the Editor window. That way you can specify exactly which pattern location in the DrumBrute will receive the pattern. This can only be done within the selected bank tab, though.

10.3.3.2 When not synced

Important: The following process will send a single pattern to DrumBrute **and will overwrite the pattern** in that memory location.

If you'd like to transfer only one pattern from a Template to the DrumBrute, find that pattern in the Local Templates window and drop it onto the Working Memory. This will send the selected pattern directly into the DrumBrute at that same pattern location.

In the example below, pattern #1 from Bank A of the "A Big Gig" Template will overwrite pattern #1 in Bank A of the DrumBrute internal memory.

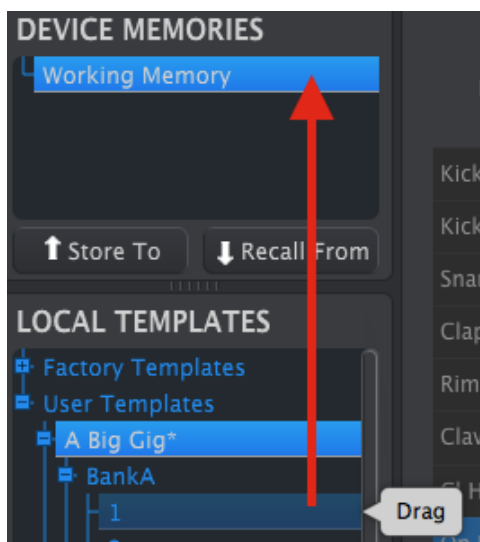

Sending an edited pattern to DrumBrute (not synced)

10.4 Store To/Recall From

10.4.1 The 'Store To' button

The upper left-hand section of the MIDI Control Center has a button called "Store To". It is used to transmit a Template from the Local Templates window to the DrumBrute.

! The following process will overwrite the internal memory of the DrumBrute. If you are not sure those patterns have been backed up, be sure to archive them to your computer using the Recall From button.

If there is a particular Template you would like to transmit to your DrumBrute, select it in the Local Templates window.

If DrumBrute and the MCC have been synced, all 64 patterns from the Template will be transmitted to your DrumBrute as soon as you select the Template.

But if DrumBrute and the MCC have not been synced, you will need to use the Store To button to transmit the Template.

The process is similar to the one described previously:

- Select the desired Template as shown below
- Click the Store To button at the bottom of the window.

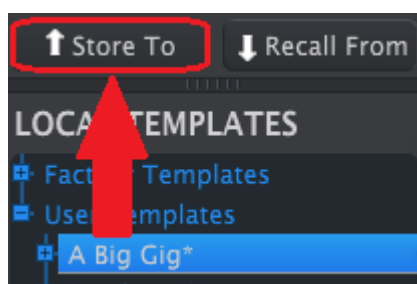

This process will store all of the patterns from the selected Template into the DrumBrute.

10.4.2 Recall edited patterns from the DrumBrute

If you changed any patterns inside the DrumBrute you need to pull those patterns into the MIDI Control Center to back them up. To do that, click the Recall From button. A new file containing all 64 patterns will appear in the Local Templates window with the current time/date stamp for a name. You can rename it if you like.

10.4.3 Save, Delete, Import/Export, etc.

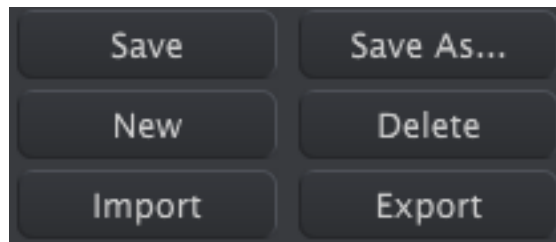

These important features have been documented in the MIDI Control Center manual, which you will find in the software Help menu. Look in section 7.1 of the Help file for information about Save, Save As..., New, Delete, Import and Export.

🎵 The Import / Export buttons pictured above perform a different function from those at the top of the Device Settings window (see section 10.5 below). These files will have the extension **.drumbrute**. They contain all of the internal DrumBrute parameters: a complete set of 64 patterns and all of the Device Settings. Use these files to share settings and patterns with other users.

10.5 Import/Export Device Settings

When the Device Settings tab is selected in the MIDI Control Center window you will see two buttons on the upper right labeled Import and Export. The function of these buttons is to manage files containing only the Device Settings. They are different from the buttons described in section 10.4.3, which are used to generate a file containing both the Device Settings and the patterns.

The Device Settings files carry the extension **.drumbrute_ds**. You can swap these files with other users or build a library of configurations for the different systems you encounter in different locations.

10.5.1 Export Device Settings

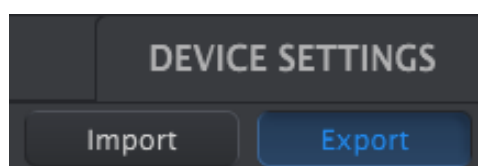

To export the Device Settings, click the Export button. Then navigate to the appropriate location in your computer and follow the prompts to save the **.drumbrute_ds** file.

10.5.2 Import Device Settings

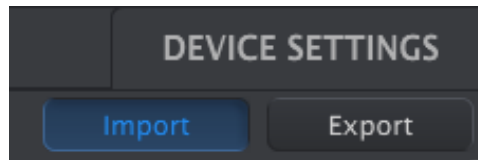

To import the Device Settings, click the Import button. Then navigate to the appropriate location in your computer and follow the prompts to load in the **.drumbrute_ds** file.

10.6 Editing basics

10.6.1 Data entry

There are two main ways to enter new parameter values in the MIDI Control Center: click something and move it, or type a number into a field.

To edit Swing %, for example, click and drag the knob graphic or double-click in the value field and enter a new value:

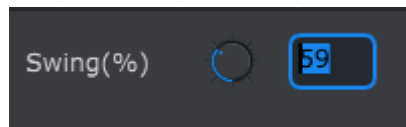

Editing a knob value

To edit a parameter such as Pause Mode, click its pull-down menu and make a selection:

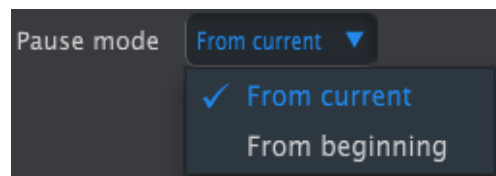

Selecting a pull-down menu option

10.6.2 Selecting the tabs

The middle window of the MIDI Control Center has five tabs: Banks A-D and Device Settings. Each bank contains 16 patterns, and Device Settings has all of the parameters for the various DrumBrute functions.



The DrumBrute tabs: Banks A-D and Device Settings

Simply click on a tab to select its window.

10.6.3 Bank tabs

Each Bank tab contains sixteen numbered pattern tabs:

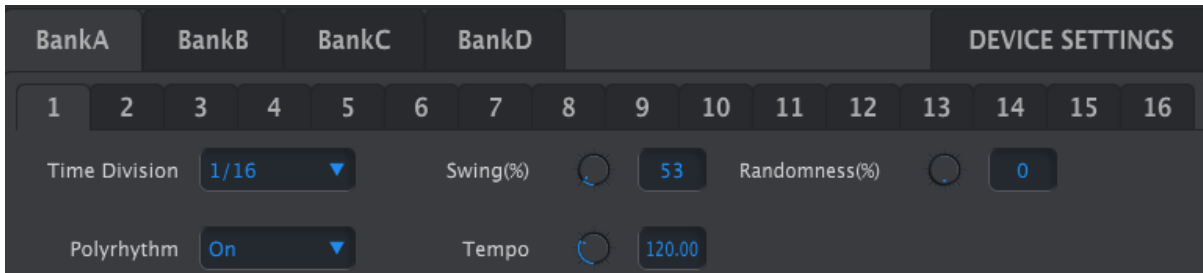

The Bank A tab

These tabs allow you to select each of the patterns and fine-tune their event data. You can even create brand new patterns here.

In the graphic above pattern #1 is selected. From here you can view and edit the Time Division, Swing % and other settings for this pattern. It is also possible to edit the velocity, timing shift and Step Repeat of individual notes. You can also add and delete notes, and more.

We'll go through each of the pattern editing features in section 10.7.

10.6.4 Device Settings tab

All of the Device Settings are contained within this tab. To view them within the MIDI Control Center, use the scroll bar on the right side of the window.

We'll go through each group of parameters in section 10.9.

10.7 Pattern window

10.7.1 Navigation

10.7.1.1 Scroll

If you have a scroll wheel you can move the pattern view horizontally. Place the cursor in the pattern field (not over the instrument names), then hold the Shift key on your computer keyboard and use the scroll wheel. The pattern view will move sideways.

You can also click/drag the scroll bar at the bottom of the window to reposition the pattern view.

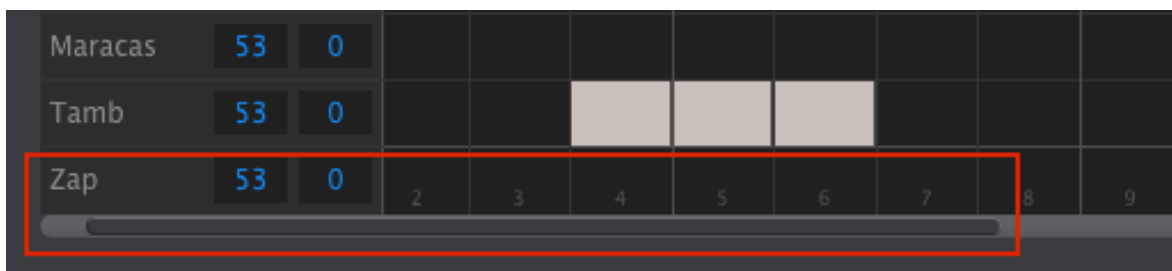

Scroll bar location

10.7.1.2 Zoom

To zoom in and out of the horizontal view, place the cursor in the pattern field. Then press Command (Mac) or Control (Windows) and use the scroll wheel to adjust the view.

10.7.2 Pattern-level parameters

Below the Pattern tabs are five parameters that operate on the entire pattern. We went through these in chapter 5, and the Polyrythm feature is covered in section 7.3 and section 10.8.

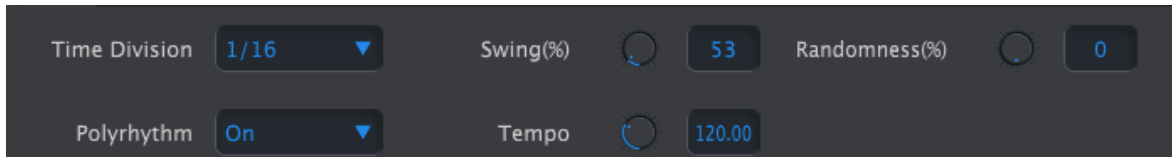

Pattern-level parameters for the Pattern tabs

10.7.3 Pattern length

Here's how a pattern window looks when the length is set to 12 steps:

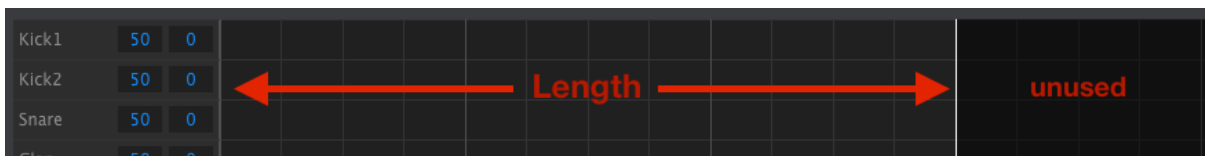

Some steps are darkened because they are outside the pattern length area. These steps can contain data but they will not play unless the pattern length is changed to include them.

The steps are numbered along the bottom of the window:

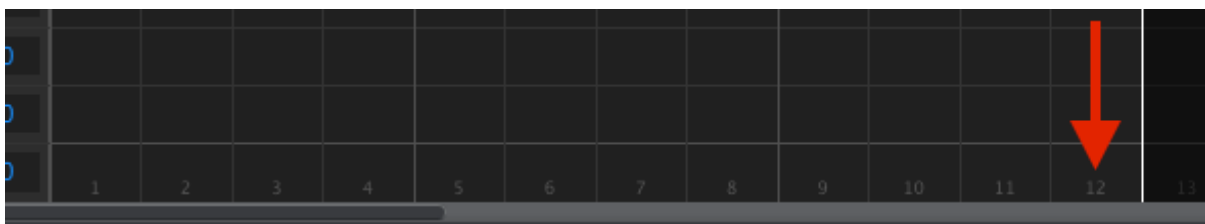

The pattern length may be changed by dragging the white line to the left or to the right:



Changing the pattern length

Patterns can be up to 64 steps long.

10.7.4 Pattern events

10.7.4.1 Enter/delete events

Double-click on a square inside the pattern view to enter an event. To delete events, select one event with a single click or drag a box around several events. Then press the Delete key on your computer keyboard.

10.7.4.2 Move events

To move an existing event to a different instrument, click and hold the middle of that event. The cursor will become a hand icon. Then drag the event up or down to place it in the instrument track you want.

You can also drag the event to the left or right to place it anywhere within the pattern. If an event already exists at the new location, it will be replaced by the event you are moving.

It's also possible to move several events at the same time. To do this, first drag a box around the events with the cursor:

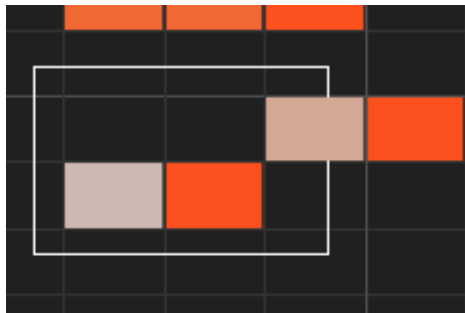

Selecting multiple events

Next, click on the middle of one of the events and drag the selected events up, down, left or right.

🎵 If one of the selected events moves beyond the Kick 1 or Zap instruments the entire pattern field will glow red. The same thing happens when an event is moved beyond the 1st or 64th steps.

10.7.4.3 Copy/paste events

After selecting a group of events you can make another copy of them in another section of the pattern. Just hold the Alt key (Option on a Mac), select one of the events, and drag them all into the new area.

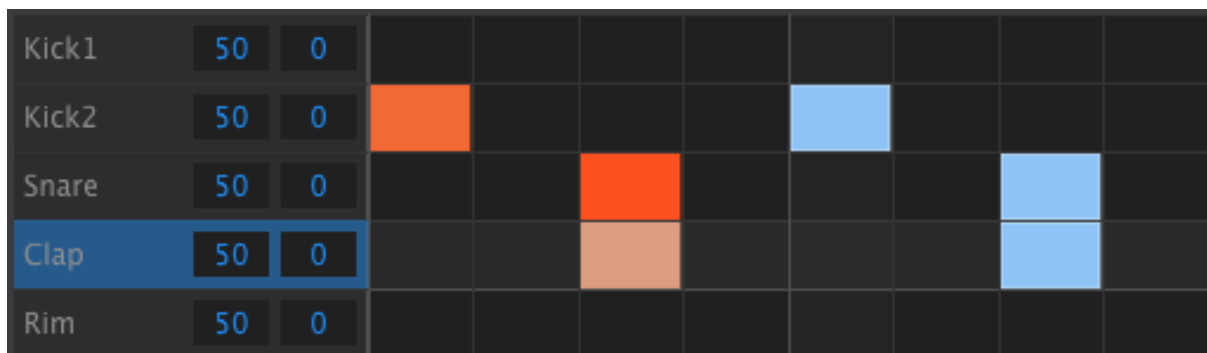

The new events will have the same velocity values as the original events.

10.7.4.4 Event velocity

If you click on the top of an event you will see the cursor become a vertical arrow icon. Drag the cursor up and down to change the velocity of that event to a value between 1 and 127.

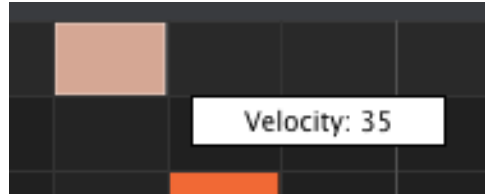

The color of the selected event will change to indicate the velocity value: white is the lowest velocity value and red is the highest velocity value.

When the velocities of multiple events are edited at the same time they will all change to the same value.

10.7.4.5 Shift Timing

The shift timing feature was described more fully in section 5.2.6. In this section we will show how to use this feature inside the MCC Pattern window.

To shift the timing of an event, hold the Shift key on your computer keyboard and then click on an event. A small window will appear and show the current time shift value.

Drag the cursor left and right to change the time shift value of that event. The range is from -/+50%.

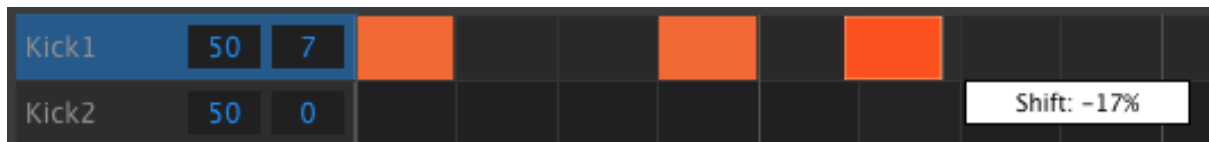

Shift timing value of -17% applied to an event.

In the image above the Kick drum has two events that are not shifted, while the third event has been shifted ahead of the beat by a value of -17%.

🎵 Shift timing is measured in terms of percentage of the pattern's time division setting. It is not shifted by a fixed unit of time (msec, pulses, clocks, etc.).

It is also possible to shift the timing of several events at the same time, even events from different instrument tracks.

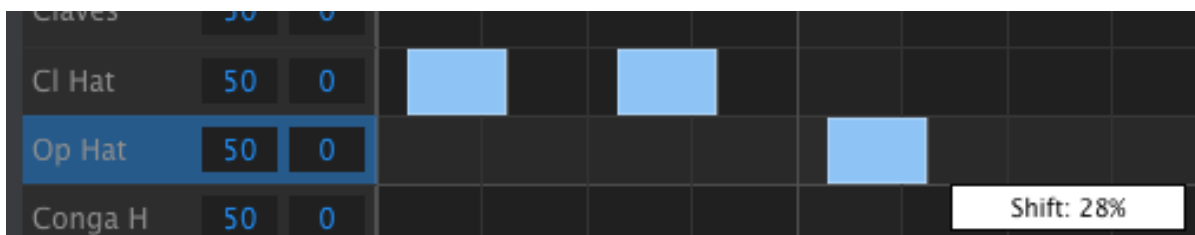

Three events shifted +28%

In the image above three Hat events from two tracks have been shifted "late" by a value of 28%.

10.7.4.6 Step Repeat

The Step Repeat feature was covered extensively in section 5.2.5. The focus in this section will be on the unique uses of this feature available within the MIDI Control Center.

If you click on the right edge of an event you will see the cursor become a horizontal arrow icon. Drag the cursor left and right to change the Step Repeat value of that event to a value between 1 and 4.

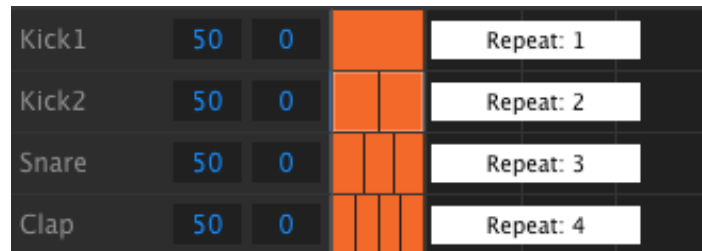

Four different Step Repeat values are available.

When all four Step Repeat values are used in the same track, the result can be an accelerated kick or snare fill, for example:



An accelerated kick fill using the Step Repeat feature

When multiple events are selected they will all change to the same Step Repeat value.



Simultaneous Step Repeat edits are possible.

10.7.5 Track-level settings

Each instrument track in the MIDI Control Center has independent settings for Swing and Randomness. They are the Current Track values described elsewhere in this manual.

🎵 In order for these settings to take effect you must enable the Current Track button for the same tracks on the DrumBrute.

10.7.5.1 Swing



Click and drag inside the left track window to edit the Swing value.

10.7.5.2 Randomness



Click and drag the right window value to edit the Randomness setting.

10.8 Polyrhythm

The Polyrhythm feature was explained in section 7.3. In this section we will focus on how to utilize that feature from with the Pattern window of the MCC.

To toggle the Polyrhythm feature on and off, use the pull-down menu in the Pattern tab window:

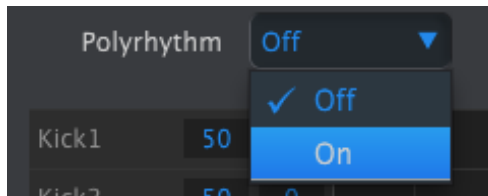

When the Polyrhythm feature is active, you can click on the white line at the end of the pattern length boundary and drag it left or right for any track independently.

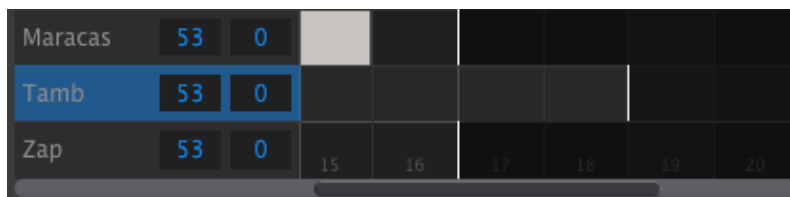

Extending the length of a single Polyrhythm track

In the image above the Tambourine track has been extended from 16 steps to 18, while the Maracas and Zap tracks remain at 16 steps.

To return all tracks to the same pattern length value, select the Off value in the Polyrhythm pull-down menu.

10.9 Device Settings

The Device Settings tab on the upper right side of the MIDI Control Center window contains essential parameters that enable you to optimize DrumBrute for your setup and your working style.

10.9.1 MIDI Channel

Use the pull-down menu to select the Global MIDI Channel for DrumBrute.

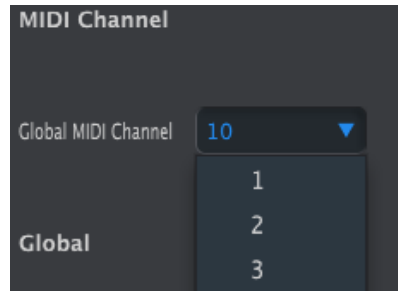

10.9.2 Global settings

We'll go through the Global settings left to right and top to bottom.

10.9.2.1 *Clock In/Out Settings*

This is where you determine which clocking signal will be transmitted and recognized by the Clock input and output connectors. Settings: 1step, 2PPQ (Korg), 24 PPQ, and 48 PPQ.

10.9.2.2 *Auto-Sync*

This parameter tells the DrumBrute what to do if it is not running and it receives a clock signal from an external source. When Auto-Sync is On the unit will respond to the first clocking signal it receives, and when the clock signal stops the DrumBrute will switch to Internal clock.

When Auto-sync is Off the DrumBrute will wait until it receives a signal from the front panel Sync selection.

10.9.2.3 *Tap Tempo*

Choose whether it will take 2, 3, or 4 taps to set the Tempo.

10.9.2.4 *Global BPM*

This parameter allows you to override the independent Tempo settings of each pattern. When set to Global each pattern will play at the current Tempo value on the front panel.

10.9.2.5 *Wait to Load Pattern*

With this parameter you can specify whether a new pattern will be loaded as soon as you select it or not. If not, DrumBrute will wait until the end of the current pattern before switching to the next one.

10.9.2.6 *Accent Velocity Threshold*

This sets the MIDI velocity value for the Accents you add when editing a pattern.

10.9.2.7 Pads send MIDI notes

You can choose whether the pads will send MIDI note data or not. The actual note values they will send are determined by the Drum Map. See section 10.9.4 to learn about this.

10.9.2.8 Metronome

Seven metronome values are available, including one that cannot be accessed from the front panel (1/4T, or quarter-note triplets).

10.9.2.9 Step Repeat Randomizer

This setting will apply increasing amounts of random behavior to the pattern steps that use the Step Repeat feature. The higher the setting, the more extreme the random jumps will be: there will be more jumps from 1 Step to 4 Steps, for example.

10.9.2.10 Step Repeat Probability

The Probability parameter allows you to increase or decrease the likelihood that a random Step Repeat event will occur. At higher levels it also can generate Step Repeats where none existed before.

10.9.2.11 Vegas mode

When this setting is active the DrumBrute front panel will begin to flash its buttons and pads if no activity has occurred for 5 minutes.

10.9.2.12 Pause mode

This parameter dictates the function of the Play/Pause button. There are two settings:

- From current: when playback resumes it will do so from the place in the pattern where the Pause button was pressed.
- From beginning: the pattern will start from the beginning when playback resumes.

10.9.2.13 Next bank

You can instruct DrumBrute to switch between banks without having to perform the second step of also selecting a pattern.

For example, if DrumBrute is playing pattern Bank A #12 and you switch to Bank B without specifying a pattern, it will play pattern Bank B #12 without waiting for further instruction. Exactly when it will change to the second pattern is determined by the setting of the Wait to Load Pattern parameter (see section 10.9.2.5).

10.9.3 Transport settings

You can define the MIDI channel and CC number for each of the three main Transport commands independently. All three must transmit the same type of MIDI information, though: MMC, MIDI CC or both.

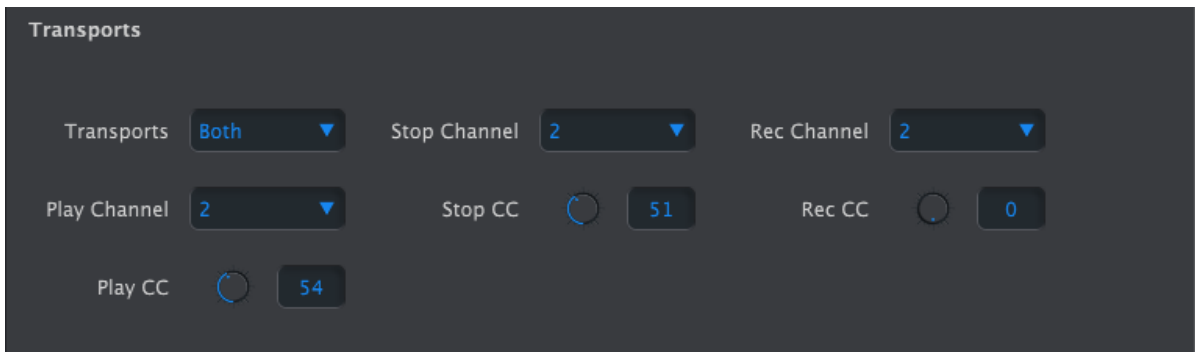

The transport control parameters

10.9.4 Drum Map

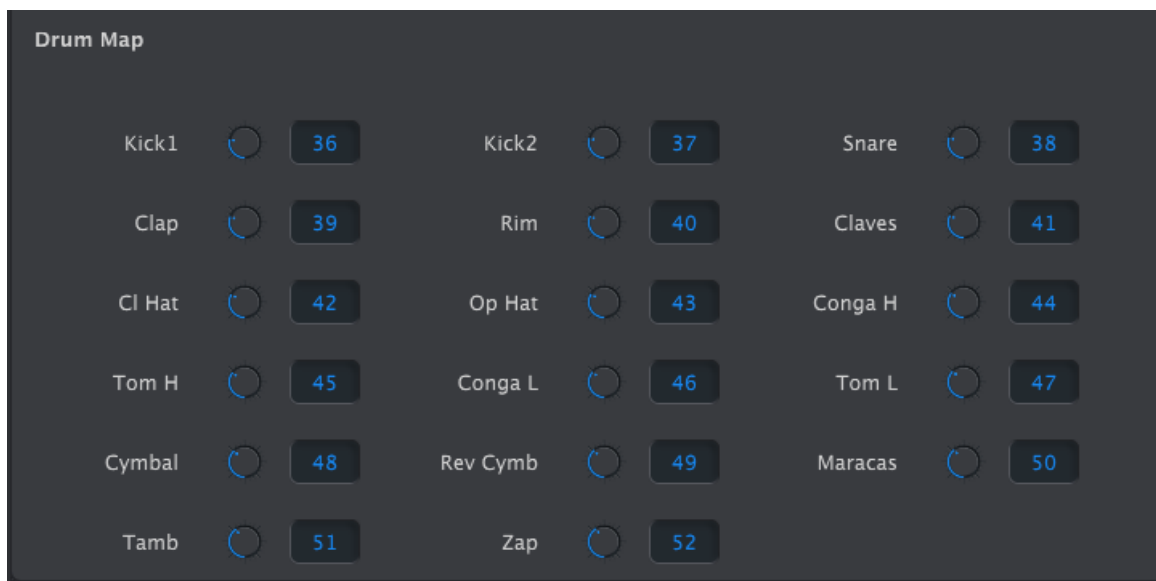

The drum map settings

The settings shown are the default MIDI note number values for each instrument, but you can set them to any note number between 0-127.

To edit a value, turn the appropriate knob or double-click a field and type in the desired number.

11 ARTURIA DRUMBRUTE – LEGAL INFORMATION

11.1 SOFTWARE LICENSE AGREEMENT

In consideration of payment of the Licensee fee, which is a portion of the price you paid, Arturia, as Licensor, grants to you (hereinafter termed "Licensee") a nonexclusive right to use this copy of the Analog Lab Software (hereinafter the "SOFTWARE").

All intellectual property rights in the software belong to Arturia SA (hereinafter: "Arturia"). Arturia permits you only to copy, download, install and use the software in accordance with the terms and conditions of this Agreement.

The product contains product activation for protection against unlawful copying. The OEM software can be used only following registration.

Internet access is required for the activation process. The terms and conditions for use of the software by you, the end-user, appear below. By installing the software on your computer you agree to these terms and conditions. Please read the following text carefully in its entirety. If you do not approve these terms and conditions, you must not install this software. In this event give the product back to where you have purchased it (including all written material, the complete undamaged packing as well as the enclosed hardware) immediately but at the latest within 30 days in return for a refund of the purchase price.

1. Software Ownership

Arturia shall retain full and complete title to the SOFTWARE recorded on the enclosed disks and all subsequent copies of the SOFTWARE, regardless of the media or form on or in which the original disks or copies may exist. The License is not a sale of the original SOFTWARE.

2. Grant of License

Arturia grants you a non-exclusive license for the use of the software according to the terms and conditions of this Agreement. You may not lease, loan or sub-license the software.

The use of the software within a network is illegal where there is the possibility of a contemporaneous multiple use of the program.

You are entitled to prepare a backup copy of the software which will not be used for purposes other than storage purposes.

You shall have no further right or interest to use the software other than the limited rights as specified in this Agreement. Arturia reserves all rights not expressly granted.

3. Activation of the Software

Arturia may use a compulsory activation of the software and a compulsory registration of the OEM software for license control to protect the software against unlawful copying. If you do not accept the terms and conditions of this Agreement, the software will not work.

In such a case the product including the software may only be returned within 30 days following acquisition of the product. Upon return a claim according to § 11 shall not apply.

4. Support, Upgrades and Updates after Product Registration

You can only receive support, upgrades and updates following the personal product registration. Support is provided only for the current version and for the previous version during one year after publication of the new version. Arturia can modify and partly or completely adjust the nature of the support (hotline, forum on the website etc.), upgrades and updates at any time.

The product registration is possible during the activation process or at any time later through the Internet. In such a process you are asked to agree to the storage and use of your personal data (name, address, contact, email-address, and license data) for the purposes specified above. Arturia may also forward these data to engaged third parties, in particular distributors, for support purposes and for the verification of the upgrade or update right.

5. No Unbundling

The software usually contains a variety of different files which in its configuration ensure the complete functionality of the software. The software may be used as one product only. It is not required that you use or install all components of the software. You must not arrange components of the software in a new way and develop a modified version of the software or a new product as a result. The configuration of the software may not be modified for the purpose of distribution, assignment or resale.

6. Assignment of Rights

You may assign all your rights to use the software to another person subject to the conditions that (a) you assign to this other person (i) this Agreement and (ii) the software or hardware provided with the software, packed or preinstalled thereon, including all copies, upgrades, updates, backup copies and previous versions, which granted a right to an update or upgrade on this software, (b) you do not retain upgrades, updates, backup copies and previous versions of this software and (c) the recipient accepts the terms and conditions of this Agreement as well as other regulations pursuant to which you acquired a valid software license.

A return of the product due to a failure to accept the terms and conditions of this Agreement, e.g. the product activation, shall not be possible following the assignment of rights.

7. Upgrades and Updates

You must have a valid license for the previous or more inferior version of the software in order to be allowed to use an upgrade or update for the software. Upon transferring this previous or more inferior version of the software to third parties the right to use the upgrade or update of the software shall expire.

The acquisition of an upgrade or update does not in itself confer any right to use the software.

The right of support for the previous or inferior version of the software expires upon the installation of an upgrade or update.

8. Limited Warranty

Arturia warrants that the disks on which the software is furnished is free from defects in materials and workmanship under normal use for a period of thirty (30) days from the date of purchase. Your receipt shall be evidence of the date of purchase. Any implied warranties on the software are limited to thirty (30) days from the date of purchase. Some states do not allow limitations on duration of an implied warranty, so the above limitation may not apply to you. All programs and accompanying materials are provided "as is" without warranty of any kind. The complete risk as to the quality and performance of the programs is with you. Should the program prove defective, you assume the entire cost of all necessary servicing, repair or correction.

9. Remedies

Arturia's entire liability and your exclusive remedy shall be at Arturia's option either (a) return of the purchase price or (b) replacement of the disk that does not meet the Limited Warranty and which is returned to Arturia with a copy of your receipt. This limited Warranty is void if failure of the software has resulted from accident, abuse, modification, or misapplication. Any replacement software will be warranted for the remainder of the original warranty period or thirty (30) days, whichever is longer.

10. No other Warranties

The above warranties are in lieu of all other warranties, expressed or implied, including but not limited to, the implied warranties of merchantability and fitness for a particular purpose. No oral or written information or advice given by Arturia, its dealers, distributors, agents or employees shall create a warranty or in any way increase the scope of this limited warranty.

11. No Liability for Consequential Damages

Neither Arturia nor anyone else involved in the creation, production, or delivery of this product shall be liable for any direct, indirect, consequential, or incidental damages arising out of the use of, or inability to use this product (including without limitation, damages for loss of business profits, business interruption, loss of business information and the like) even if Arturia was previously advised of the possibility of such damages. Some states do not allow limitations on the length of an implied warranty or the exclusion or limitation of incidental or consequential damages, so the above limitation or exclusions may not apply to you. This warranty gives you specific legal rights, and you may also have other rights which vary from state to state.

11.2 FCC INFORMATION (USA)

Important notice: DO NOT MODIFY THE UNIT!

This product, when installed as indicate in the instructions contained in this manual, meets FCC requirement. Modifications not expressly approved by Arturia may avoid your authority, granted by the FCC, to use the product.

IMPORTANT: When connecting this product to accessories and/or another product, use only high quality shielded cables. Cable (s) supplied with this product **MUST** be used. Follow all installation instructions. Failure to follow instructions could void your FCC authorization to use this product in the USA.

NOTE: This product has been tested and found to comply with the limit for a Class B Digital device, pursuant to Part 15 of the FCC rules. These limits are designed to provide a reasonable protection against harmful interference in a residential environment. This equipment generate, use and radiate radio frequency energy and, if not installed and used according to the instructions found in the users manual, may cause interferences harmful to the operation to other electronic devices. Compliance with FCC regulations does not guarantee that interferences will not occur in all the installations. If this product is found to be the source of interferences, witch can be determined by turning the unit "OFF" and "ON", please try to eliminate the problem by using one of the following measures:

- Relocate either this product or the device that is affected by the interference.

- Use power outlets that are on different branch (circuit breaker or fuse) circuits or install AC line filter(s).

- In the case of radio or TV interferences, relocate/ reorient the antenna. If the antenna lead-in is 300 ohm ribbon lead, change the lead-in to coaxial cable.

- If these corrective measures do not bring any satisfied results, please the local retailer authorized to distribute this type of product. If you cannot locate the appropriate retailer, please contact Arturia.

The above statements apply **ONLY** to those products distributed in the USA.

11.3 CANADA

NOTICE: This class B digital apparatus meets all the requirements of the Canadian Interference-Causing Equipment Regulation.

AVIS: Cet appareil numérique de la classe B respecte toutes les exigences du Règlement sur le matériel brouilleur du Canada.

11.4 EUROPE

CE This product complies with the requirements of European Directive 89/336/EEC. This product may not work correctly by the influence of electro-static discharge; if it happens, simply restart the product.