

DB-90 METRONOME Dr. Beat Owner's Manual



Thank you, and congratulations on your choice of the BOSS DB-90 METRONOME Dr. Beat.

Before using this unit, carefully read the sections entitled: "USING THE UNIT SAFELY" and "IMPORTANT NOTES" (separate sheet). These sections provide important information concerning the proper operation of the unit. Additionally, in order to feel assured that you have gained a good grasp of every feature provided by your new unit, this manual should be read in its entirety. The manual should be saved and kept on hand as a convenient reference.

As shipped, the DB-90's battery is not yet installed. Be sure to read "Changing the Battery" and then follow the instructions to install the battery.

Copyright © 2005 BOSS CORPORATION. All rights reserved. No part of this publication may be reproduced in any form without the written permission of BOSS CORPORATION.

Main Features

- Large backlit LCD panel, easy-to-follow and highly visible pendulum-style tempo indicator
- PCM count sound plus internal drum sounds

In addition to high-quality PCM count sounds, human voice and drum sounds are also provided as metronome sounds.

- Note Mixing function

The four different rhythms (quarter-note, eighth-note, sixteenth-note, and triplet) and accent volume are completely adjustable, allowing you to create original rhythm styles quickly and easily.

- Loop Play

You can call up stored metronome settings in predetermined sequences, and have them play for a specified number of times. This gives you the freedom to practice using various combinations of rhythms as well as irregular rhythms.

- Amp Simulator

The DB-90 is equipped with an input jack, which allows you to connect your guitar or bass directly to the unit and do rhythm training with the metronome. Also featured is an amp simulator function, which allows you to use the DB-90 as a simple monitor amp.

- Includes Rhythm Coach function, perfect for individualized practice

The DB-90 features a Rhythm Coach function, which provides effective rhythm training using trigger pads and the DB-90's internal mic.

- Count In function

You can set the metronome to give a lead-in count before the metronome count itself starts.

- Reference Tone function

The DB-90 includes a chromatic sound generating function, which produces tones in a five-octave range (C2-B6).

- Memory function

The memory is capable of storing 50 different metronome settings and ten reference tone settings.

- START/STOP jack

You can connect an FS-5U (or FS-6) pedal to the START/STOP jack and start and stop operation with the pedal.

- MEMORY UP/DOWN jack

An FS-5U (or FS-6) pedal can be connected to the MEMORY UP/DOWN jack and then used to shift up and down through the memories and make your selection.

- MIDI IN Connector

You can connect an external MIDI device to the MIDI IN connector, synchronize to and display the tempo for the external device, and use the device to start and stop the metronome.

■ Printing conversions in this manual

Text or numerals enclosed in square brackets [] indicates buttons; i.e. [TAP]...TAP button

[COACH] Switches the unit to Coach mode.

Press the button to switch among the four practice modes.

[BEAT/PATTERN] Switches between metronome Beat and Pattern.

[VOICE] This changes the tone used for the Beat you select.

* This does not change the tone when Patterns are selected.

[PITCH] Switches the unit to Reference Tone mode. Changes the reference pitch.

[TRIG/GUIDE] Switches the unit to Coach mode.

Set the pad sensitivity and Time Check difficulty settings here.

7. Rhythm Level sliders

Adjust the volume of the accent on the first beat and the volume of each rhythm.

* This setting is enabled in Metronome mode (excluding the count-in operation), and MIDI mode.

8. Master Volume slider

Adjusts the overall volume.

* The master volume setting is not stored in memory.

9. Display

Information in the display is changed depending on the modes.

10. Tempo indicators

Light in time with the tempo.

11. MIDI IN connector

Used to connect to the MIDI OUT connector on a MIDI sequencer.

12. DC IN jack

This is for connecting an AC adaptor (PSA-series).

13. MEMORY ▲▼ jack (stereo jack)

A foot switch (such as the optional FS-5U or FS-6) is connected here.

You can use a foot switch to shift the memories up and down.

14. START/STOP jack (monaural jack)

A foot switch (the optional FS-5U or FS-6) is connected here.

You can use a foot switch to start and stop the metronome, Loop Play, reference note, and Rhythm Coach.

15. PHONES jacks

Connect headphones here. Both the 1/4" phone and stereo miniature phone jacks can be used simultaneously.

16. INPUT jack (monaural jack)

Connect an electric guitar or bass here.

* When connection cables with resistors are used, the volume level of equipment connected to the inputs may be low. If this happens, use connection cables that do not contain resistors, such as those from the Roland PCS series.

17. INPUT LEVEL volume

Adjusts the volume for the device connected to the input jack.

18. TRIG IN jack (monaural jack)

Connect a trigger pad (such as the optional Roland PD-8 or V-Pad) here.

19. Cymbal stand attachment hole (M6)

20. Security Slot

<http://www.kensington.com/>

Making Connections

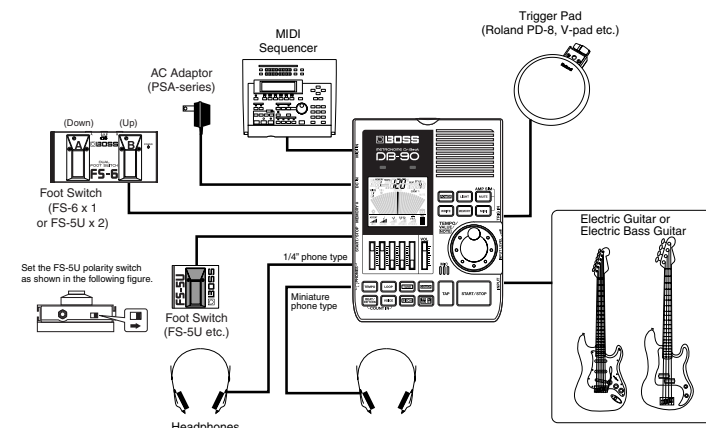

Using the Metronome

■ Metronome Mode

1. Press [TEMPO].

The tempo value flashes a number of times.

2. Use the TEMPO/VALUE dial to set the tempo.

3. Press [BEAT/PATTERN].

"BEAT" or "PATTERN" flashes.

If you select "BEAT," the note icon appears in the display.

If you select "PATTERN," then KICK, SNARE, and other drum tone names are displayed.

4. Use the TEMPO/VALUE dial to select the "BEAT" or "PATTERN" number.

"BEAT" is the setting for a single quarter-note beat (pressing [VOICE] while selecting the "BEAT" setting permits you to choose one of four tones).

Select "PATTERN" to play rhythms ("PATTERN" drum tones and performance data are fixed).

* With some "PATTERN" types, there may be some drum sounds that do not have a sound assigned to them.

5. Press [START/STOP] to start the metronome. To stop the metronome, press [START/STOP] once more.

■ Changing the Metronome Tone

You can select from four different tones (only when "BEAT" is selected).

1. Press [VOICE].

"BEAT" in Metronome mode is selected automatically, and "VOICE" flashes.

2. Use the TEMPO/VALUE dial to select the tone.

1. Wind-up metronome sound
2. Electronic metronome sound
3. Electronic click sound
4. Human voice

■ Setting the Tempo with Tap Input

You can set the tempo by pressing [TAP] button two or more times in Metronome mode; the tempo is set to the timing you use in tapping the button. You can set the tempo within the range of ♩ = 30-250.

You can also set the tempo with tap input in Coach mode.

■ Create Original Rhythm Styles

In Metronome mode you can use the 5 sliders under the display (ACCENT and ♩, ♪, ♫, ♬, ♮ sliders) to change the way the metronome plays.

The volume for the accent on the first beat and for each rhythm is indicated on a five-level scale.

You can store the changed settings to memory. Refer to the section "Using the Memory," which follows.

* "EDIT" is displayed when you change settings from content stored in the memory.

■ Count-In Function

You can set the metronome to give a lead-in count before the metronome count itself starts. (This setting is enabled in Metronome mode, Loop Play mode, Coach mode, and MIDI mode.)

1. Press [BEAT/PATTERN] and [VOICE] simultaneously.

2. Press [START/STOP] to start the metronome.

The count is played for the set number of times, and then the performance starts.

To cancel the Count-in function, press [BEAT/PATTERN] and [VOICE] simultaneously once more.

* Performances always start with a count-in when you start the metronome with the count-in function set.

* The count-in function is canceled the next time the DB-90 is turned on.

* The count-in tone is not selectable.

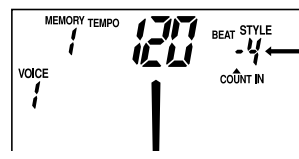
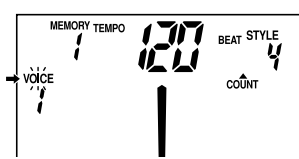
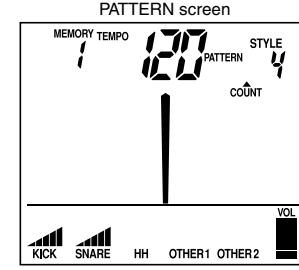
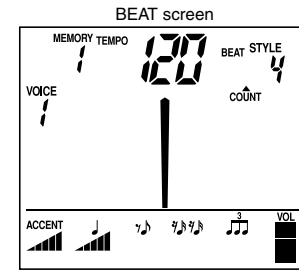

Changing the Number of Times the Count-In is Played

When [BEAT/PATTERN] and [VOICE] are pressed simultaneously, the count-in repeat number is displayed.

Use the TEMPO/VALUE dial to select a number from -1 to -8.

■ Mute Function

You can temporarily mute sounds while a performance is playing.

1. Press [MUTE].

"MUTE" appears in the display. The sound being played back is muted.

2. Press [MUTE] again.

The sound plays again, and "MUTE" disappears from the display.

* The Mute status is not stored in memory.

■ Using Loop Play (Loop Play Mode)

You can have metronome settings that are stored in memory automatically play back in sequence. Storing settings with various tempos and rhythms to different memories and then playing these back with Loop Play is effective for rhythm training. You can also use this to practice irregular rhythms.

1. Press [LOOP].

The DB-90 is switched to Loop Play mode. "LOOP" appears in the display.

2. Press [START/STOP] to start Loop Play.

During Loop Play, the number in the center of the display indicates the number of repeats for each memory. The number above "COUNT" is the number of times the material is repeated.

When [MEMORY] is pressed, "MEMORY" flashes; now the memory number can be changed with the TEMPO/VALUE dial.

Press [MEMORY] once more; "MEMORY" lights steadily, and the DB-90 returns to Loop Play.

3. Press [START/STOP] once again.

Loop Play is stopped and the DB-90 is in Loop Play standby.

Changing the Number of Times Playback of the Memory is Repeated

Using TEMPO/VALUE dial while Loop Play is in standby switches the number of repeats to any value from 0 to 255. When set to 0, the data for that memory number is not played back.

Practicing in Coach Mode

The DB-90's Coach mode is a set of exercise modes developed for maximizing the practice experience. These modes are specifically designed to help build speed, accuracy and stamina, as well as develop better timing skills.

In each of the four Coach modes, you can conduct practices appropriate for different skill levels.

Using the internal mic, you can check your rhythm with acoustic drums, practice rhythms by clapping your hands, and so on.

You can also practice using a trigger pad by connecting the trigger pad to the TRIG IN jack.

■ Setting the Mic and Trigger Pad Sensitivity

Setting the Mic Sensitivity

1. Make sure nothing is plugged into the TRIG IN jack.
2. Press [TRIG/GUIDE] so that "SENS" is flashing.
3. Set the "SENS" value with the TEMPO/VALUE dial until a dot (●) appears in the TRIG section when the drum or practice pad is struck.

* Setting the "SENS" value too high may cause the input to react to the metronome sound. If this occurs, readjust the "SENS" value.

* If the trigger reacts to the metronome sound when the Rhythm Coach is started, lower the volume of the metronome sound using the master volume slider until the trigger no longer reacts to the sound.

Setting the Trigger Pad Sensitivity

1. Connect a trigger pad to the TRIG IN jack.
2. Press [TRIG/GUIDE] so that "SENS" is flashing.
3. Set the "SENS" value with the TEMPO/VALUE dial until a dot (●) appears in the TRIG section when the trigger pad is struck.

The sensitivity increases as the "SENS" value is raised.

"SENS" Value 1, 2,16
Sensitivity Low-----High

A dot appears at the same time the DB-90 is triggered.

* Tones are fixed and cannot be changed. Adjust the volume with the master volume slider.

* Note that the DB-90 does not support the use of rim shots even though you may be using pads that can produce rim shots.

Panel Descriptions

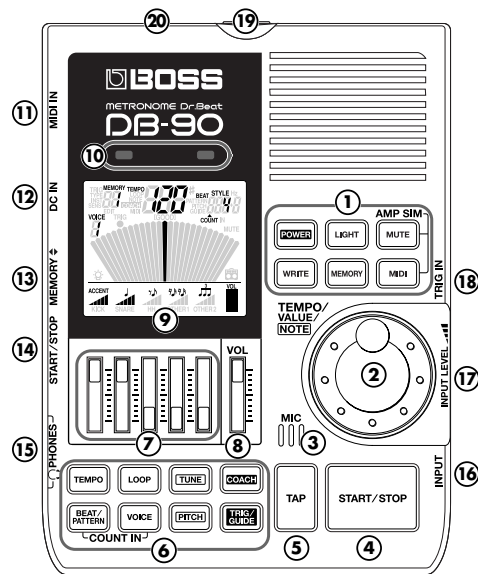

1. [POWER] Turns the power on and off.

* Always make sure to have the volume level turned down before switching on power. Even with the volume all the way down, you may still hear some sound when the power is switched on, but this is normal, and does not indicate a malfunction.

[LIGHT] Switches the backlight on and off.

[MUTE] Mutes the sound being played.

* The Mute status is not stored in memory.

[WRITE] Used when storing settings to memory.

[MEMORY] Switches the memory number.

[MIDI] Switches the unit to MIDI mode.

2. TEMPO/VALUE dial Changes the tempo and the setting values.

3. MIC

You can practice rhythms with the DB-90 set to respond to the sound from drums, practice pads, and other mic input. You can use this in Coach mode.

4. [START/STOP]

Starts and stops the metronome, Loop Play, reference tone and Rhythm Coach.

5. [TAP]

Sets the metronome tempo.

* This setting is ignored in Loop Play mode, Reference Tone mode, and MIDI mode.

6. [TEMPO] Changes the tempo.

[LOOP] Switches the unit to Loop Play mode.

[TUNE] Switches the unit to Reference Tone mode. Changes the note name.

■ Practicing with the Rhythm Coach

- Press [COACH].

“COACH” appears in the display and the DB-90 is switched to Coach mode.

Press the [COACH] button to switch among the four practice modes.

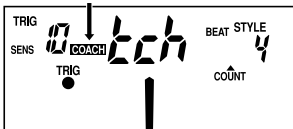

	1. Time Check	Accuracy and Timing Exercise
	2. Quiet Count	
	3. Gradual Up/Down	Endurance and Stamina Exercise
	4. Step Up/Down	

- Press [START/STOP] to start the metronome and begin the exercise.

- Metronome patterns are played in accordance with the Metronome mode settings.
- The sound is switched to the Rhythm Coach tone and is not selectable.
- Adjust the volume with the master volume slider.
- Pressing [COACH] or [TRIG/GUIDE] stops the metronome, while a performance is playing.
- Using TEMPO/VALUE dial or pressing [TAP] can change the tempo.

* The trigger sound is enabled only in Coach mode.

Time Check()

This mode is designed to provide extensive practice in drumming with the proper rhythm in time with the guide sound as counted out by the metronome.

The display indicates whether or not the source for the mic input or pad is struck with the same timing as the metronome. The timing for quarter notes () is checked.

- Press [COACH] to select “”
- Press [START/STOP] to begin to exercise.



Behind the beat (too slow) ← On the beat (perfect timing) → Ahead of the beat (too fast)

* If [GOOD] continues to appear in the display after you press [START/STOP] to start the time check, even when you do not strike the pad, it means that the trigger is reacting to the metronome sound. Refer to the instructions in “Setting the Mic Sensitivity” above and adjust the “SENS” value and the volume of the metronome sound.

Quiet Count (

Quiet Count mode is a timing exercise designed to develop and learn “internal” timing. In this mode, the metronome will play at the set volume level for the first four measures then play the second four measures at a reduced volume. The four measure cycle of loud and soft counts will continue until stopped.

- Press [COACH] to select “”
- Press [START/STOP] to begin to exercise.

Gradual Up/Down (

Practice in “Gradual Up/Down” mode is designed to increase stamina and endurance by gradually increasing and decreasing the tempo. The speed increases 1 BPM every two beats until the maximum metronome value is reached. Once you hit the maximum value, the speed decreases 1 BPM every two beats until you return to the original tempo. The process is then repeated. When “PATTERN” is selected, the speed changes 1 BPM every two measures.

- Press [COACH] to select “”
- Press [START/STOP] to begin to exercise.

When you press [WRITE] during a performance, the tempo in effect at that time is set as the maximum metronome value (initial setting: 250). The minimum metronome value is set according to the tempo set with the TEMPO/VALUE dial or tap input.

* Changing the minimum value resets the maximum value to the initial setting (250).

Step Up/Down (

Step Up/Down mode is designed to increase playing endurance by slowly increasing and decreasing the speed of the metronome. In this mode, the metronome’s tempo will increase by five beats per minute (5 BPM) after every four measures until it reaches the metronome’s maximum tempo. After the maximum tempo is achieved, the metronome’s tempo will decrease by five beats per minute (5 BPM) after every four measures. This will continue until it reaches back to the metronome’s starting tempo and then repeat the process.

- Press [COACH] to select “”
- Press [START/STOP] to begin to exercise.

When you press [WRITE] during a performance, the tempo in effect at that time is set as the maximum metronome value (initial setting: 250). The minimum metronome value is set according to the tempo set with the TEMPO/VALUE dial or tap input.

* Changing the minimum value resets the maximum value to the initial setting (250).

■ Changing the Time Check Standard

You can change the standard used in determining your accuracy as measured against the metronome sound to any of three levels.

This allows you to practice with the timing suited to your level of skill.

- Press [TRIG/GUIDE] so that “GUIDE” is flashing.
- Make the setting with the TEMPO/VALUE dial.
 - EASY
 - NORMAL
 - HARD (Accuracy is determined even more precisely)

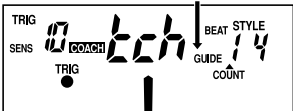

Using the Memory

You can store up to fifty different metronome setting and ten different reference tone setting configurations in the memory.

■ Calling Up Stored Settings (Memory)

- When “MEMORY” is lit, press [MEMORY] to start “MEMORY” flashing.

- While “MEMORY” is flashing, change the memory number with the TEMPO/VALUE dial.

* Pressing [WRITE] while the memory is being selected (while “MEMORY” is flashing) switches the DB-90 to selection of the write destination (the memory number flashes).

● Storing Settings to Memory

- When the memory number is lit, press [WRITE].

The memory number flashes.

- While the memory number is flashing, select the write-destination memory number with the TEMPO/VALUE dial.

* Pressing [START/STOP] cancels the procedure, and the memory number remains lit.

- Press [WRITE] once more to store settings to memory; the memory number starts flashing rapidly. Once the memory number lights steadily, you’ll know that the data has been successfully stored in memory.

* Do not turn off the power while data is being stored to memory (when the memory number is flashing rapidly).

* “EDIT” is displayed when you change settings from content stored in the memory.

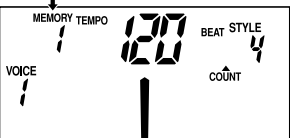

Playing the Reference Tone

- Press [TUNE] to switch to Reference Tone mode.

When the DB-90 is in Reference Tone mode, “NOTE,” and “PITCH” appears in the display.

- Set the note name with the TEMPO/VALUE dial.

You can set the note name in semitone increments in the range from C2 to B6.

- Press [START/STOP] to play the reference tone.

“MUTE” disappears from the display.

Press the button again to stop the sound. “MUTE” appears in the display.

* You can also play or stop the reference tone by pressing [MUTE].

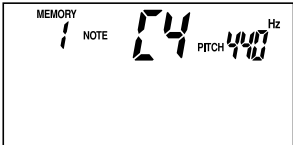

■ Setting the Reference Pitch

- Press [PITCH] in Reference Tone mode so that “PITCH” flashes in the display.

- Set the reference pitch with the TEMPO/VALUE dial.

The reference pitch is set in terms of the value of A4, which can be any frequency from 438 to 445 Hz.

* You cannot change the note name with the TEMPO/VALUE dial while “PITCH” is flashing in the display. If you want to change the note name, press [TUNE] so “PITCH” stops flashing and remains lit in the display.

* What is the reference pitch?

The frequency for A4 (the middle A on a piano) of a note played by an instrument (a piano, for example) as the pitch to which all other performers tune their instruments for performances is called the “reference pitch.”

Using MIDI (MIDI Mode)

MIDI (Musical Instrument Digital Interface) is a universal standard that allows for the exchange of performance data and other information among electronic musical instruments and computers. Once MIDI cables are used to connect together devices equipped with MIDI connectors, each device can send data to, or receive data from any of the others.

The DB-90 starts, stops, and displays the tempo in synchronization with the external MIDI device (device equipped with MIDI OUT).

When the master device is started or stopped, a MIDI message for that operation is transmitted.

The slave then starts or stops in accordance with the transmitted MIDI message.

Furthermore, timing clock data corresponding to the tempo is transmitted by the master device.

Slave device synchronizes its performance to this timing clock.

■ Data Synchronized with the DB-90

The following MIDI messages are handled during synchronization with the DB-90.

- Start
- Continue
- Timing Clock
- Stop
- Active Sensing

- Press [MIDI].

The DB-90 switches to Metronome mode and MIDI mode, with MIDI reception enabled.

“MIDI” lights steadily.

When the external MIDI device is started or stopped, the DB-90 then starts or stops.

- Press [MIDI] once again.

MIDI mode is cancelled, and the DB-90 returns to Metronome mode.

* You cannot change the tempo with the TEMPO/VALUE dial or through tap input while the DB-90 is in MIDI mode.

Pressing [TEMPO], [LOOP], [TUNE], [PITCH], [COACH], or [TRIG/GUIDE] cancels MIDI mode.

* If the MIDI cable is disconnected during synchronized play, the DB-90 will stop playing.

* Depending on the VOICE for the Beat, the metronome may not sound correctly when the tempo is set to more than 220. In such cases, select VOICE 3.

* In MIDI mode, you cannot select from memory during performance.

Other Functions

■ Amp Simulator Function

The DB-90 is equipped with amp simulator circuitry.

This feature allows you to plug your electric guitar or bass directly to the DB-90 and use it as a simple monitor amp.

Switching the Amp Simulator Circuit On/Off

- Simultaneously press [MUTE] and [MIDI].

“” appears in the display, indicating that the amp simulator circuit is switched on.

- Once more, simultaneously press [MUTE] and [MIDI].

The amp icon disappears from the display, and the amp simulator circuit is switched off.

* The amp simulator on/off setting is stored in memory.

■ Auto Power Off

The Auto Power Off function works to help prevent unnecessary battery drainage by automatically turning off the DB-90’s power if no operation or adjustment is made within 60 minutes after any button is pressed.

Disabling the Auto Power Off Function

To disable the Auto Power Off function, first turn off the DB-90’s power, then hold down the [TAP] as you press [POWER] to turn the power back on again.

The Auto Power Off function is disabled. “” is indicated in the display while [TAP] is held down.

The Auto Power Off function is enabled again the next time the DB-90 is turned on again.

■ Auto Backlight Off

Press [LIGHT] to turn on the backlighting.

The backlighting automatically turns off in approximately five seconds (Auto Backlight Off function). “” disappears from the display when Auto Backlight Off is enabled.

Disabling the Auto Backlight Off Function

If you want the backlighting to stay on, first turn off the DB-90’s power, then hold down [LIGHT] as you press [POWER] to turn the power back on again.

The Auto Backlight Off function is disabled, and “” appears in the display.

The Auto Backlight Off function is enabled again the next time the DB-90 is turned on again.

* You cannot store the disabled status for Auto Power Off and Auto Backlight Off to memory.

Changing the Battery

The display and LED indicators dim when the battery begin to run down.

Replace the battery as soon as possible.

* If there is battery in the unit while an AC adaptor is being used, normal operation will continue should the line voltage be interrupted (power blackout or power cord disconnection).

* The settings stored by the memory function are reset to the default factory settings if the battery is removed from the DB-90, or if the battery gets completely depleted.

* When turning the unit upside-down, handle with care to avoid dropping it, or damaging the buttons and controls.

- Remove the lid of the battery compartment (located on the bottom of the unit).
- Remove the old battery from the compartment and remove the snap cord connected to it.
- Connect the snap cord to the new battery, and place the battery inside the compartment.
 - * Make sure the “+” and “-” ends of the battery are oriented correctly.
- Securely close the battery cover.

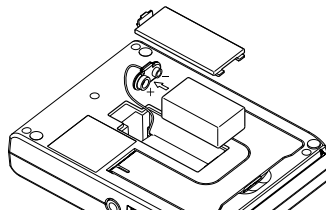

Attachment to a Cymbal Stand

To attach the DB-90 to the separately available MDY-10U cymbal holder, follow the illustration below. Use the washer and wing nut that are supplied with the MDY-10U.

For a stationary installation, turn the DB-90 for approximately five complete revolutions to attach it to the MDY-10U. Then, after adjusting the DB-90 so it faces the appropriate direction, fasten it using the wing nut.

If you wish to attach the DB-90 to a cymbal stand, use the included boss nut (hole diameter: 8 mm) if the cymbal stand is larger than the attachment hole (diameter 6 mm) of the DB-90. (See the following figure.)

* Do not apply undue force to any of the objects involved in the installation, as damage could result.

Example of using the boss nut

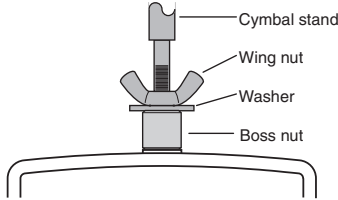

■ How to Use the Stand

You can use the DB-90’s stand by setting it up as shown in the figure.

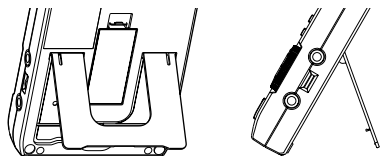

Restoring the Factory Settings

This returns all settings on the DB-90 to the values they had when the unit shipped from the factory.

Hold down [MEMORY] as you press [POWER] to turn the power on.

“” is indicated in the display while [MEMORY] is held down.

All of the settings are restored to their original factory status.

Main Specifications

Metronome

- Tempo: =30-250, Accuracy: ±0.1% - BEAT1: 1-9 - BEAT2: OFF, 1-9

- PATTERN: 30 kinds (8-BEAT x 4, 16-BEAT x 3, SHUFFLE x 3, FUNK x 2, JAZZ x 2, BLUES, TECHNO, HOUSE, COUNTRY, REGGAE, CLAVE 3-2, CLAVE 2-3, SALSA, RUMBA, BOSSA NOVA, SAMBA, WALTZ, TANGO, MAMBO, CHACHACHA, MARCH)

-BEAT Tone: Voice 1 (Standard metronome sound), Voice 2 (Electronic metronome sound), Voice 3 (Electronic click sound), Voice 4 (Human voice)

Rhythm Coach: Time Check, Quiet Count, Gradual Up/Down, Step Up/Down

Reference Tone: - Reference Pitch: A4=438 Hz-445 Hz (1 Hz steps) - Reference Tone Range: C2-B6 (5 octaves, 12 semitones), Accuracy: ±1 cent

Auto Power Off function: Turns unit off after 60 min.

Memory: - Metronome: 50 - Reference Tone: 10

Indicators: LCD Display, Tempo Indicator LED x 2

Connector: TRIG IN, START/STOP, MEMORY UP/DOWN, MIDI IN, PHONES x 2 (Stereo 1/4” phone type, Stereo miniature phone type), INPUT, AC Adaptor jack (for PSA adaptor)

Speaker: 50 mm x 1

Power Supply: DV 9 V: Dry battery 6LR61 (9V) type (alkaline),

Dry battery 6F22 (9V) type (carbon)

AC adaptor (PSA-series)

Power Consumption: 85 mA or less (with reference tone sounding)

190 mA or less (with signals input to the INPUT jack)

- Expected battery life under continuous use:

Carbon: Approximately 1.5 hours, Alkaline: Approximately 6 hours

* These figures will vary depending on the actual conditions of use.

Dimensions: 122 (W) x 164 (D) x 37.5 (H) mm / 4-3/4 (W) x 6-1/2 (D) x 1-1/2 (H) inches

Weight: 450 g / 1 lb (including a battery)

Accessories: Dry battery (6F22 (9V) Type), Soft case, Owner’s Manual, Leaflet (“USING THE UNIT SAFELY,” “IMPORTANT NOTES” and “Information”), Boss nut (M8)

* In the interest of product improvement, the specifications and/or appearance of this unit are subject to change without prior notice.

* Use a cable from Roland to make the connection. If using some other make of connection cable, please note the following precautions.

- Some connection cables contain resistors. Do not use cables that incorporate resistors for connecting to this unit. The use of such cables can cause the sound level to be extremely low, or impossible to hear. For information on cable specifications, contact the manufacturer of the cable.

MIDI Implementation Version: 1.00

1. Receive Data

■ System Real-Time Message

● Timing Clock	Status	F8H
● Start	Status	FAH
● Continue	Status	FBH
● Stop	Status	FCH
● Active Sensing	Status	FEH

For the U.K.

IMPORTANT: THE WIRES IN THIS MAINS LEAD ARE COLOURED IN ACCORDANCE WITH THE FOLLOWING CODE.

BLUE: NEUTRAL
BROWN: LIVE

As the colours of the wires in the mains lead of this apparatus may not correspond with the coloured markings identifying the terminals in your plug, proceed as follows:

The wire which is coloured BLUE must be connected to the terminal which is marked with the letter N or coloured BLACK. The wire which is coloured BROWN must be connected to the terminal which is marked with the letter L or coloured RED. Under no circumstances must either of the above wires be connected to the earth terminal of a three pin plug.

For EU Countries



This product complies with the requirements of European Directive 89/338/EEC.

For the USA

FEDERAL COMMUNICATIONS COMMISSION RADIO FREQUENCY INTERFERENCE STATEMENT

This equipment has been tested and found to comply with the limits for a Class B digital device, pursuant to Part 15 of the FCC Rules. These limits are designed to provide reasonable protection against harmful interference in a residential installation. This equipment generates, uses, and can radiate radio frequency energy and, if not installed and used in accordance with the instructions, may cause harmful interference to radio communications. However, there is no guarantee that interference will not occur in a particular installation. If this equipment does cause harmful interference to radio or television reception, which can be determined by turning the equipment off and on, the user is encouraged to try to correct the interference by one or more of the following measures:

- Reorient or relocate the receiving antenna.
- Increase the separation between the equipment and receiver.
- Connect the equipment into an outlet on a circuit different from that to which the receiver is connected.
- Consult the dealer or an experienced radio/TV technician for help.

This device complies with Part 15 of the FCC Rules. Operation is subject to the following two conditions:

- (1) This device may not cause harmful interference; and
- (2) This device must accept any interference received, including interference that may cause undesired operation.

Unauthorized changes or modification to this system can void the users authority to operate this equipment. This equipment requires shielded interface cables in order to meet FCC class B Limit.

For Canada

NOTICE

This Class B digital apparatus meets all requirements of the Canadian Interference-Causing Equipment Regulations.

AVIS

Cet appareil numérique de la classe B respecte toutes les exigences du Règlement sur le matériel brouilleur du Canada.