

VOCOPro®

Trusted by
Professionals
Since 1991

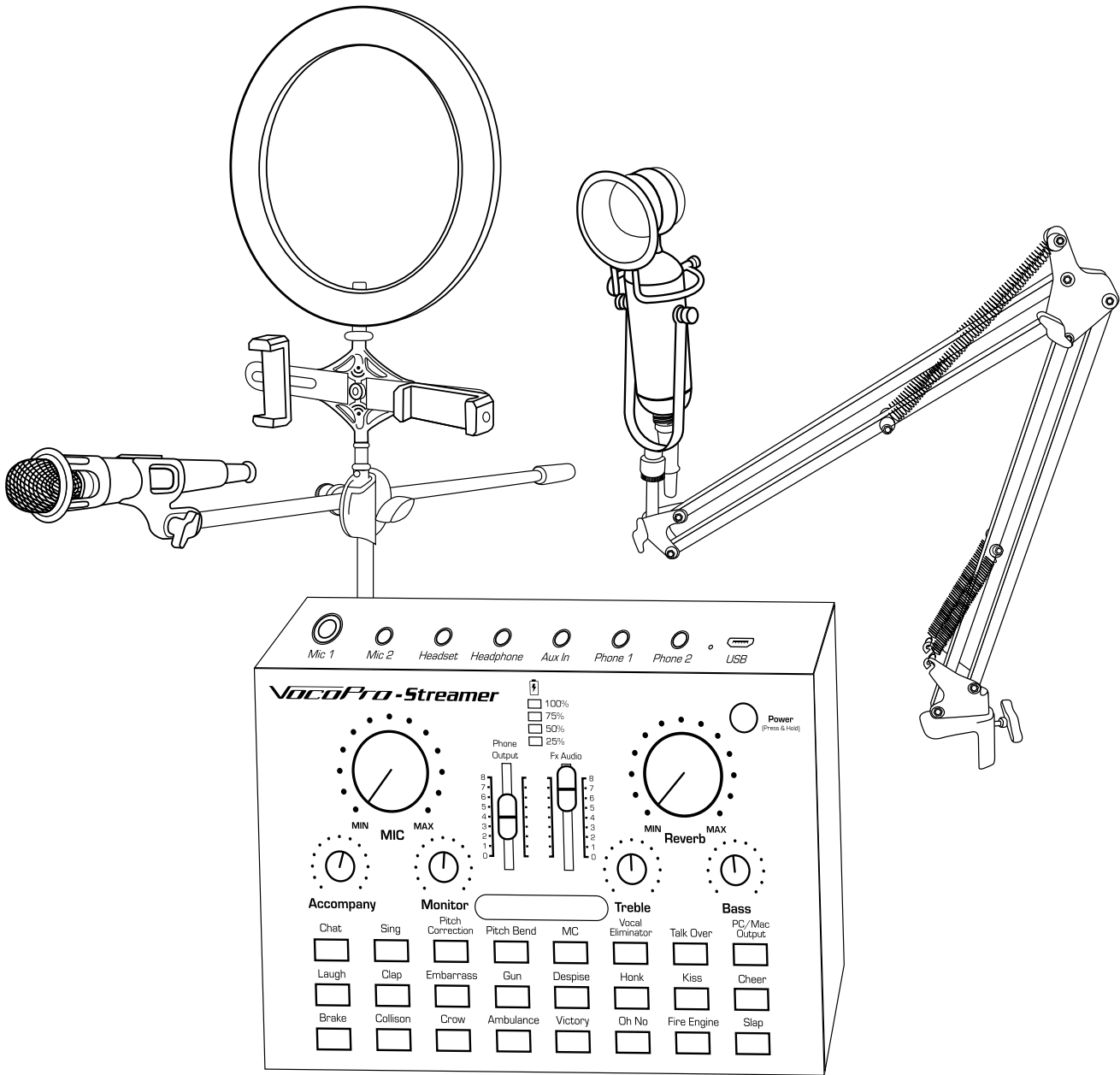

STREAMER-LIVE

STREAMER-STUDIO

USB audio interface package for content creators

OWNER'S MANUAL

WELCOME

And thank you for purchasing the Streamer-Live or Streamer-Studio Package from VocoPro. Along with quality products our commitment to customer satisfaction means we have technical support professionals ready to assist you. Be sure to visit our website- www.vocopro.com for the latest information on new products.



We are at:

VocoPro
1728 Curtiss Court
La Verne, CA 91750



Phone:

Toll Free: 800-678-5348
TEL: 909-593-8893
FAX: 909-593-8890

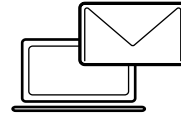

Tech Support:

techsupport@vocopro.com

Customer Service:

info@vocopro.com

Legal Disclaimer

All rights reserved. Information, specifications, diagrams, images, and instructions herein are subject to change without notice. VocoPro Products, logo and identifying product names and numbers herein are trademarks of VocoPro. Copyright protection claimed includes all forms and matters of copyrightable materials and information now allowed by statutory or judicial law or hereinafter granted. Product names used in this document may be trademarks or registered trademarks of their respective companies and are hereby acknowledged. All non-VocoPro Products, brands and product names are trademarks or registered trademarks of their respective companies.

VocoPro hereby disclaims any and all liabilities for property, equipment, building, and electrical damages, injuries to any persons, and direct or indirect economic loss associated with the use or reliance of any information contained within this document, and/or as a result of the improper, unsafe, insufficient and negligent assembly, installation, rigging, and operation of this product.

Please record the model number and serial number below, for easy reference, in case of loss or theft. These numbers are located on the packaging the item came in. Space is also provided for other relevant information.

This is not considered a receipt. Please keep a copy of your purchase receipt, provided by the dealer, in your records. A receipt is required for all warranty work.

Model Number

Serial Number

Date of Purchase

Place of Purchase

Listening for a Lifetime

Selecting fine audio equipment such as the unit you've just purchased is only the start of your musical enjoyment. Now it's time to consider how you can maximize the fun and excitement your equipment offers. VocoPro and the Electronic Industries Association's Consumer Electronics Group want you to get the most out of your equipment by playing it at a safe level. One that lets the sound come through loud and clear without annoying blaring or distortion and, most importantly, without affecting your sensitive hearing.

Sound can be deceiving. Over time your hearing "comfort level" adapts to a higher volume of sound. So what sounds "normal" can actually be loud and harmful to your hearing. Guard against this by setting your equipment at a safe level BEFORE your hearing adapts.

To establish a safe level:

- Start your volume control at a low setting.
- Slowly increase the sound until you can hear it comfortably and clearly, and without distortion.

Once you have established a comfortable sound level:

- Set the dial and leave it there.
- Pay attention to the different levels in various recordings.

Taking a minute to do this now will help to prevent hearing damage or loss in the future. After all, we want you listening for a lifetime.

Used wisely, your new sound equipment will provide a lifetime of fun and enjoyment. Since hearing damage from loud noise is often undetectable until it is too late, this manufacturer and the Electronic Industries Association's Consumer Electronics Group recommend you avoid prolonged exposure to excessive noise. This list of sound levels is included for your protection.

| Level | Example |
|--------------|---|
| 30 | Quiet library, Soft whispers |
| 40 | Living room, Refrigerator, Bedroom away from traffic |
| 50 | Light traffic, Normal Conversation |
| 60 | Air Conditioner at 20 ft., Sewing machine |
| 70 | Vacuum cleaner, Hair dryer, Noisy Restaurant |
| 80 | Average city traffic, Garbage disposals, Alarm clock at 2 ft. |

The following noises can be dangerous under constant exposure:

| Level | Example |
|--------------|---|
| 90 | Subway, Motorcycle, Truck traffic, Lawn Mower |
| 100 | Garbage truck, Chainsaw, Pneumatics drill |
| 120 | Rock band concert in front of speakers |
| 140 | Gunshot blast, Jet plane |
| 180 | Rocket launching pad |

-Information courtesy of the Deafness Research Foundation

Safety Instructions



CAUTION RISK OF SHOCK



CAUTION: To reduce the risk of electric shock, do not remove cover (or back). No user-serviceable parts inside. Only refer servicing to qualified service personnel.

Explanation of Graphical Symbols



The lightning flash & arrowhead symbol, within an equilateral triangle, is intended to alert you to the presence of danger.



The exclamation point within an equilateral triangle is intended to alert you to the presence of important operating and servicing instructions.

WARNING: To reduce the risk of fire or electric shock, do not expose this unit to rain or moisture.

1. Read Instructions - All the safety and operating instructions should be read before the appliance is operated.
2. Retain Instructions - The safety and operating instructions should be retained for future reference.
3. Heed Warnings - All warnings on the appliance and in the operating instructions should be adhered to.
4. Follow Instructions - All operating and use instructions should be followed.
5. Attachments - Do not use attachments not recommended by the product manufacturer as they may cause hazards.
6. Water and Moisture - Do not use this unit near water. For example, near a bathtub or in a wet basement and the like.
7. Carts and Stands - The appliance should be used only with a cart or stand that is recommended by the manufacturer.
 - 7 A. An appliance and cart combination should be moved with care. Quick stops, excessive force, and uneven surfaces may cause an overturn.
8. Ventilation - The appliance should be situated so its location does not interfere with its proper ventilation. For example, the appliance should not be situated on a bed, sofa, rug, or similar surface that may block the ventilation slots.
9. Heat - The appliance should be situated away from heat sources such as radiators, heat registers, stoves, or other appliances (including amplifiers) that produce heat.



10. Power Sources - The appliance should be connected to a power supply only of the type described in the operating instructions or as marked on the appliance.

11. Grounding or Polarization - Precautions should be taken so that the grounding or polarization means of an appliance is not defeated.

12. Power-Cord Protection - Power-supply cords should be routed so that they are not likely to be walked on or pinched by items placed upon or against them, paying particular attention to cords at plugs, convenience receptacles, and the point where they exit from the appliance.

13. Cleaning - Unplug this unit from the wall outlet before cleaning. Do not use liquid cleaners or aerosol cleaners. Use a damp cloth for cleaning.

14. Power lines - An outdoor antenna should be located away from power lines.

15. Non-use Periods - The power cord of the appliance should be unplugged from the outlet when left unused for a long period of time.

16. Object and Liquid Entry - Care should be taken so that objects do not fall and liquids are not spilled into the enclosure through openings.

17. Damage Requiring Service - The appliance should be serviced by qualified service personnel when:

- A. The power supply cord or plug has been damaged; or
- B. Objects have fallen into the appliance; or
- C. The appliance has been exposed to rain; or
- D. The appliance does not appear to operate normally or exhibits a marked change in performance; or
- E. The appliance has been dropped, or the enclosure damaged.

18. Servicing - The user should not attempt to service the appliance beyond that described in the operating instructions. All other servicing should be referred to qualified service personnel.

Note: To CATV system installer's (U.S.A.): This reminder is provided to call the CATV system installer's attention to Article 820-40 of the NEC that provides guidelines for proper grounding and, in particular, specifies that the cable ground shall be connected as close to the point of cable entry as practical.



This device complies with Part 15 of the FCC rules. Operation is subject to the condition that this device may not cause harmful interference.

FCC license may be required

FCC Information

1. IMPORTANT NOTICE: DO NOT MODIFY THIS UNIT!
This product, when installed as indicated in the instructions contained in this manual, meets FCC requirements. Modifications not expressly approved by Vocopro may void your authority, granted by the FCC, to use this product.

2. IMPORTANT: When connecting this product to accessories and/or another product use only high quality shielded cables. Cable(s) supplied with this product **MUST** be used. Follow all installation instructions. Failure to follow instructions could void your FCC authorization to use this product in the U.S.A.

3. NOTE: This product has been tested and found to comply with the requirements listed in FCC Regulations, Part 15 for Class "B" digital devices. Compliance with these requirements provides a reasonable level of assurances that your use of this product in a residential environment will not result in harmful interference with other electronic devices. This equipment generates/uses radio frequencies and, if not installed and used according to the instructions found in the owner's manual, may cause interference harmful to the operation of other electronic devices. Compliance with FCC regulations does not guarantee that interference will not occur in all installations. If this product is found to be the source of interference, which can be determined by turning the unit "Off" and "On", please try to eliminate the problem by using one of the following measures:

Relocate either this product or the device that is being affected by the interference.

Use power outlets that are on different branch (circuit breaker or fuse) circuits or install AC line filter(s).

In the case of radio or TV interference, relocate/reorient the antenna. If the antenna lead-in is 300-ohm ribbon lead, change the lead-in to coaxial type cable.

If these corrective measures do not produce satisfactory results, please contact your local retailer authorized to distribute Vocopro products. If you can not locate the appropriate retailer, please contact Vocopro, 1728 Curtiss Court, La Verne, CA 91750.

CAUTION:
READ THIS BEFORE OPERATING YOUR UNIT

1. To ensure the finest performance, please read this manual carefully. Keep it in a safe place for future reference.
2. Install your unit in a cool, dry, clean place - away from windows, heat sources, and too much vibration, dust, moisture or cold. Avoid sources of hum (transformers,

CALIFORNIA PROP 65 WARNING

⚠ WARNING: Cables, Cable Assemblies, and Printed Circuit Boards can expose you to chemicals including lead and lead compounds which are known to the State of California to cause cancer and birth defects or other reproductive harm. For more information, go to www.P65Warnings.ca.gov

electric motors). To prevent fire or electrical shock, do not expose to rain and water.

3. Do not operate the unit upside-down.
4. Never open the cabinet. If a foreign object drops into the set, contact your dealer.
5. Place the unit in a location with adequate air circulation. Do not interfere with its proper ventilation; this will cause the internal temperature to rise and may result in a failure.
6. Do not use force on switches, knobs or cords. When moving the unit, first turn the unit off. Then gently disconnect the power plug and the cords connecting to other equipment. Never pull the cord itself.
7. Do not attempt to clean the unit with chemical solvents; this might damage the finish. Use a clean, dry cloth.
8. Be sure to read the "Troubleshooting" section on common operating errors before concluding that your unit is faulty.
9. This unit consumes a fair amount of power even when the power switch is turned off. We recommend that you unplug the power cord from the wall outlet if the unit is not going to be used for a long time. This will save electricity and help prevent fire hazards. To disconnect the cord, pull it out by grasping the plug. Never pull the cord itself.
10. To prevent lightning damage, pull out the power cord and remove the antenna cable during an electrical storm.
11. The general digital signals may interfere with other equipment such as tuners or receivers. Move the system farther away from such equipment if interference is observed.

NOTE: Please check the copyright laws in your country before recording from records, compact discs, radio, etc. Recording of copyrighted material may infringe copyright laws.

Voltage Selector (General Model Only)

Be sure to position the voltage selector to match the voltage of your local power lines before installing the unit.

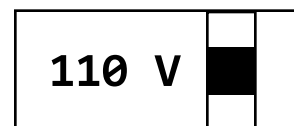

CAUTION: The apparatus is not disconnected from the AC power source so long as it is connected to the wall outlet, even if the apparatus itself is turned off. To fully ensure that the apparatus is indeed fully void of residual power, leave unit disconnected from the AC outlet for at least fifteen seconds.

What's in the Box

Streamer Studio

1. STREAMER USB Audio Interface
2. Studio Condenser Microphone
3. Tabletop Boom Arm Stand
4. Micro USB cable
5. TRRS 1/8 inch Audio Cable (2x)

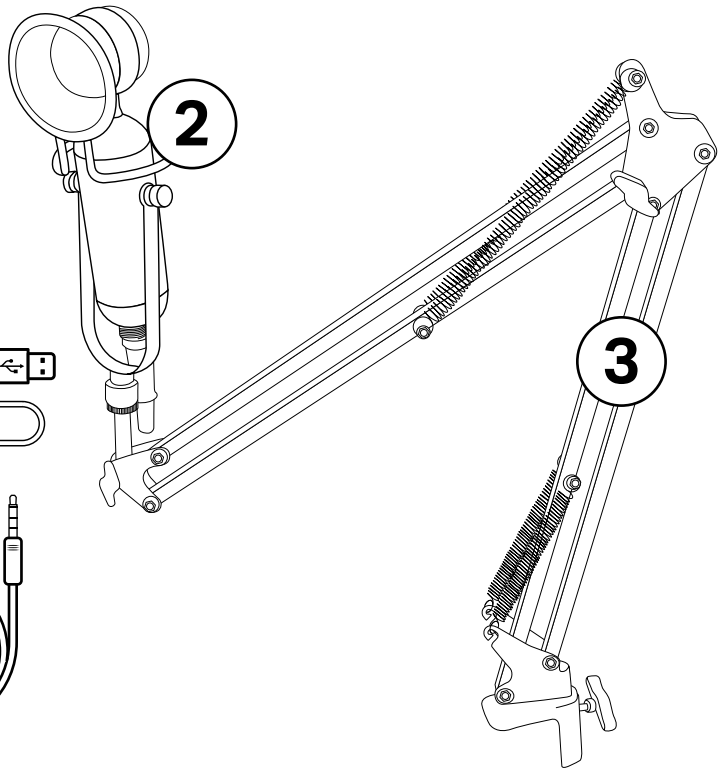
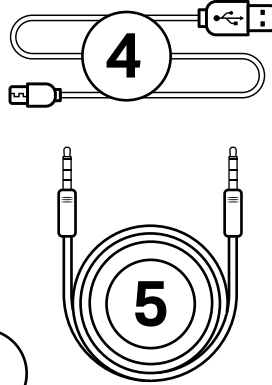
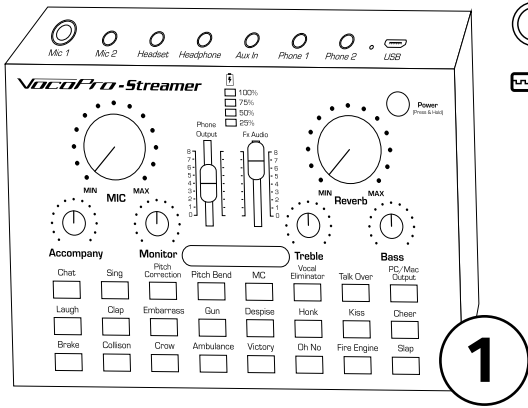

Streamer Live

1. STREAMER USB Audio Interface
2. Condenser Microphone
3. Dual Phone Mount and Stand
4. LED Light ring
5. Micro USB cable
6. TRRS 1/8 inch Audio Cable (2x)

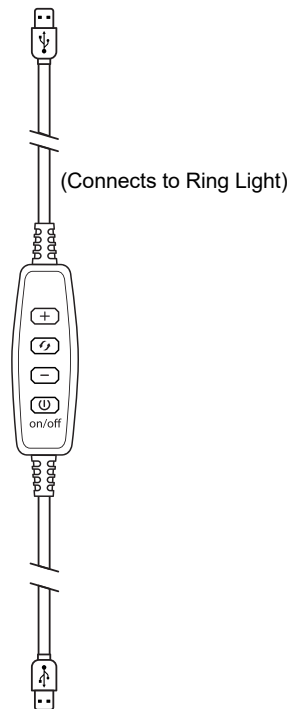
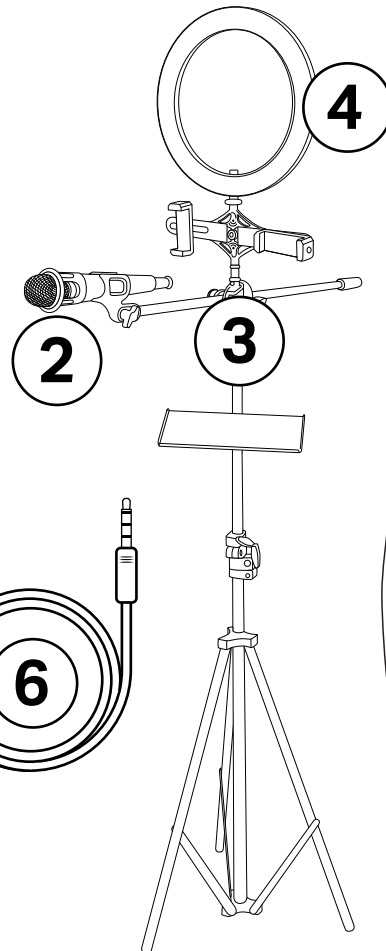
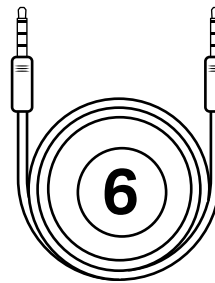
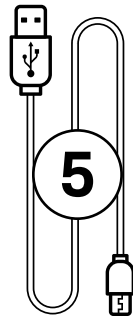
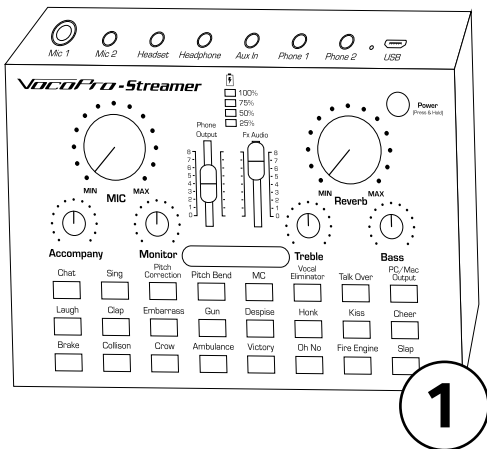

Getting Connected

Streamer-Live

Here we will go over an example of how to connect to a phone for recording, or streaming through a social media app. This example will use multiple devices which will allow you to take advantage of the dual phone mount and stand included in the Streamer Live package, we will use the Condenser microphone from the Live package in this example as well.

1. Connect the microphone to the 1/8 inch Mic 2 input, which will supply phantom power to the mic.

2. Connect a pair of headphones to the Headphone output to listen to music playback.

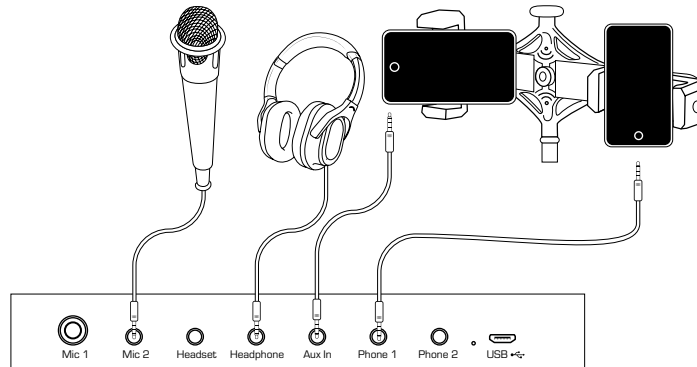

3. Connect a phone/ laptop/ MP3 player to the Aux In for music playback using the TRRS 1/8 inch Audio Cable. Connecting to the Aux In will allow you to control the music volume with the Accompany knob, as well as allow you to take advantage of the Vocal Eliminator and Talk Over functions.

4. Connect a phone to the Phone 1 input/output jack for recording or streaming using the TRRS 1/8 inch Audio Cable. If your phone does not have a headphone jack you will need an adapter made by the phone's manufacturer.

5. Turn on the Streamer USB.

6. Turn the Phone Output volume up high to ensure you are sending a strong signal to the Phone outputs

7. Turn the Mic volume knob up high to ensure you are sending strong signal to the phone.

8. Turn the Monitor knob up to a comfortable listening volume.

9. Turn the Accompany volume up to match the music volume to your performance.

10. Open the camera app to record onto your phone, or open the recording/ streaming app of your choice.

11. Hit Record and GO!

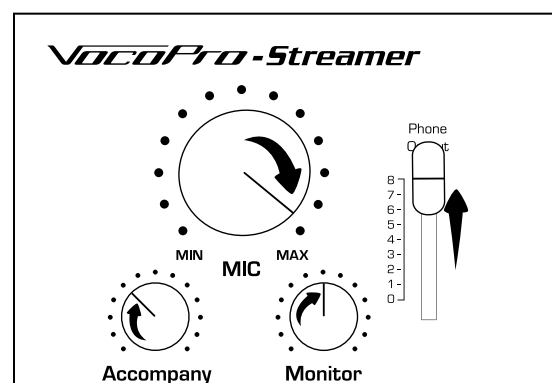

Getting Connected

Helpful Tips:

If you want to use the LED Light Ring it will need to be plugged into power via a USB wall plug or USB battery pack.

If you want to add a second singer or instrument player into the mix, simply connect a dynamic microphone (that does not require phantom power), or an instrument to the Mic 1 input on the Streamer USB using a 1/4 inch audio cable.

Streamer-Studio

Here we will go over an example of how to connect to a computer to record vlogs, voice-overs, vocal performances, etc. The example here will use the Studio Condenser microphone included in the Streamer Studio package.

1. Connect the microphone to the 1/8 inch Mic 2 input, which will supply phantom power to the mic.

2. Connect a pair of headphones to the Headphone output to monitor the performance.

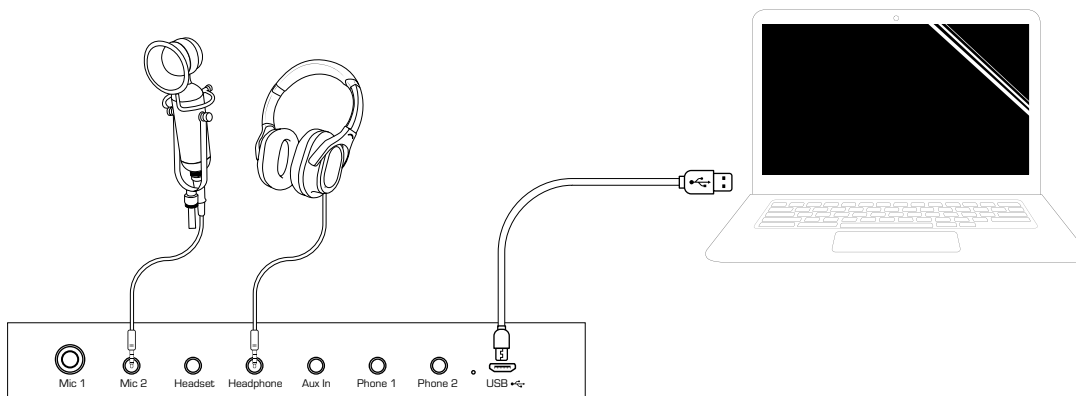

You may need to go into your computer's System Settings or System Preferences and go to the Sound settings and change the Input Device and Output Device. For many computers this will be done automatically upon connecting and turning on the Streamer USB.

3. Connect the Streamer USB to your computer using the Micro USB cable, and power it on.

4. Open the Recording application of your choice on the computer.

5. Turn the Mic volume knob up high to ensure you are sending strong signal to the computer.

6. Turn the Monitor knob up to a comfortable listening volume.

7. Hit record and GO!

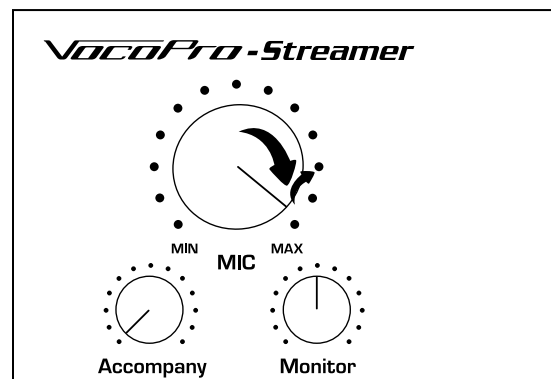

Getting Connected

Getting Connected: Streamer to Computer for Virtual Meetings

If you use the instructions on the last page to connect the Streamer to your computer, you can also use the Streamer with its microphone during virtual meetings. Here we will cover changing your input and output settings for your computer.

You must change the Input device for the computer to accept the audio coming from the microphone. On the Input list you want to select the device listed as "USB 2.0 Device".

Sound Input

Choose your input device

Microphone (USB2.0 Device)

Certain apps may be set up to use different sound devices than the one selected here. Customize app volumes and devices in advanced sound options.

[Device properties](#)

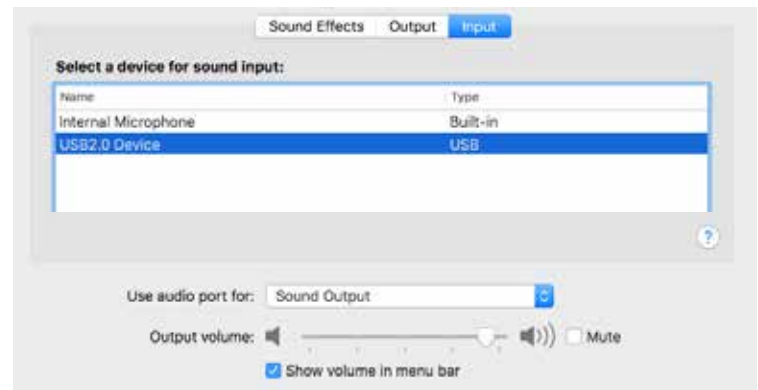

For the Output device, if it is set to Speakers, the audio from your computer will continue to come out of the computer's speakers. If you set the Output device to the USB 2.0 Device, the audio from the computer will be sent to the Streamer, and you will need to connect a pair of headphones to the Headphone output on the Streamer.

Sound Output

Speakers (Realtek High Definition Audio)

Speakers (USB2.0 Device)

Certain apps may be set up to use different sound devices than the one selected here. Customize app volumes and devices in advanced sound options.

[Device properties](#)

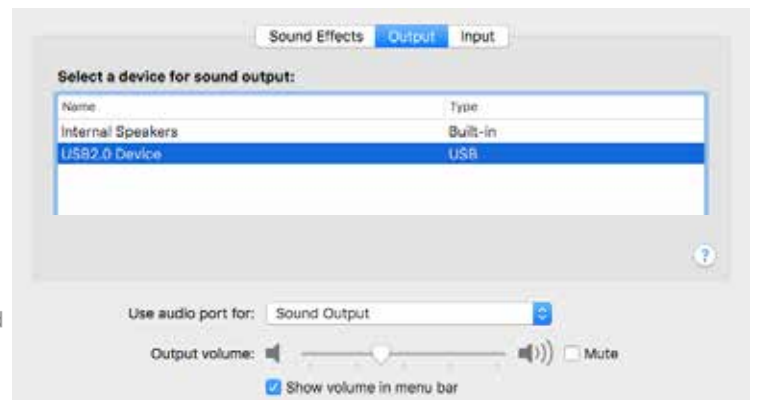

Please note, your microphone audio will not come out of the computer speakers, regardless of your output setting. You will hear yourself if you are using headphones connected to the Streamer.

Getting Connected

Changing the Mic Input in Common Video Applications

Below we will go over some of the common software apps and where you can change the mic input settings within those apps if needed. Just like with the computer itself, many of the apps we use will automatically change the input source, but here is what to look for if you have issues.

Zoom

The most popular video conference app of 2020, Zoom will actually perform a step by step set-up with you to select your output and input if you select "Test Speaker and Microphone" before joining a meeting.

For speakers (output) set to USB 2.0 Device if you want to hear the audio through headphones connected to the streamer.

If you've already changed your computer's input and output device as stated on the previous page of this manual, you can also select "Same as System".

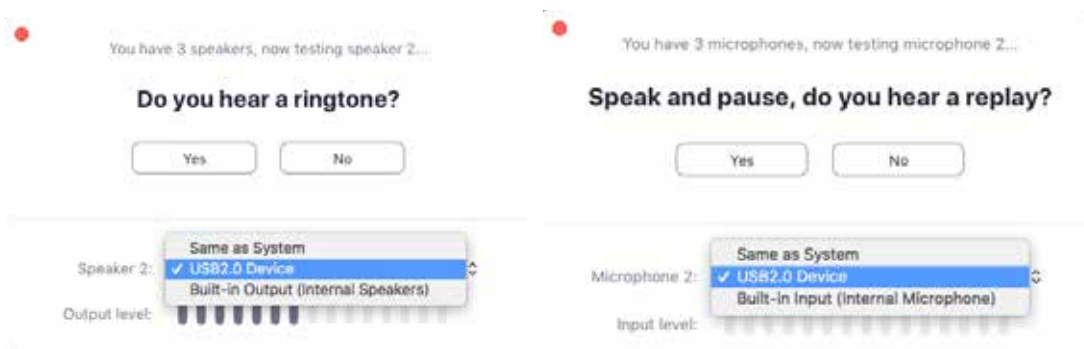

Speak into the microphone briefly, you should see the microphone meter light up, and it will playback your voice for the purpose of testing the mic.

If you need to change the mic input while you are already in a meeting for any reason, look for the microphone symbol on the bottom left of the Zoom window. Click the up arrow to bring up a menu and see your current microphone and speaker selections. Select "USB2.0 Device" for your microphone, or if you have changed the input setting for your computer you can select "Same as System"

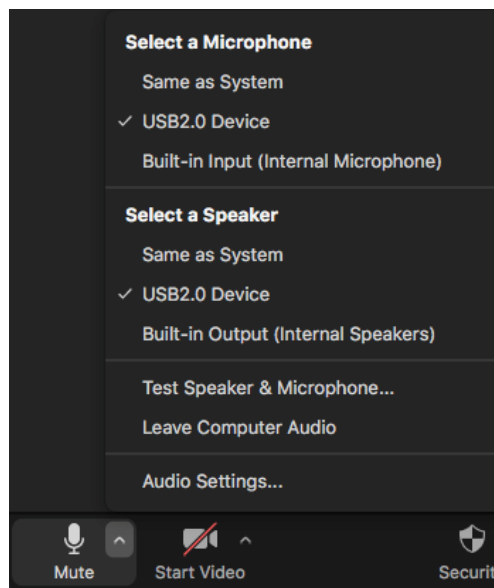

Getting Connected

Google Meet

Recently made available free to all, Google Meet is a video conference software you can run directly on your computer's web browser, no need to download and install a separate application.

To change the microphone input, first open the menu by clicking on the three vertical dots, then select settings. Before joining a meeting, the dots to access the menu will be on the top right of the window, after joining they will be on the bottom right.

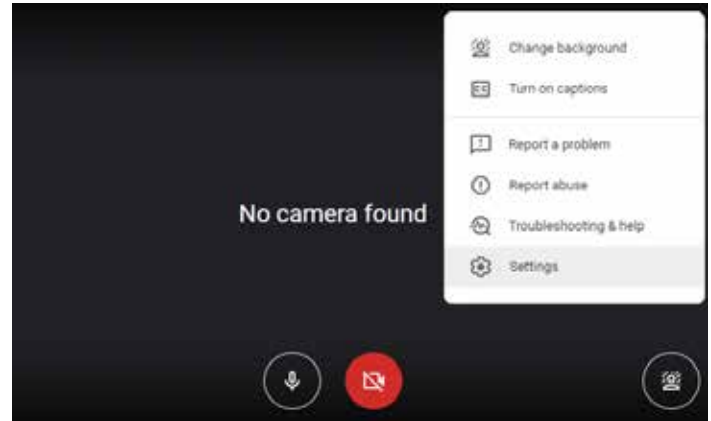

Once you are in the audio settings, under Microphone there will be a drop-down menu, make sure "USB2.0 Device" is selected. Once selected, when you speak into the mic the small meter to the right should move showing it is receiving the signal.



Facetime

An apple exclusive software, Facetime comes pre-installed on all iPhones and Mac computers. If everyone in your group is on an Apple device, Facetime is a perfectly fine application to use for group video calls.

After you open Facetime on your Mac, on the toolbar at the top of the screen, click on Video to drop down a menu. In this menu there is Microphone section where you can select your option. Make sure to select "USB2.0 Device". This menu can be accessed before or after joining a call.



Functions/Controls

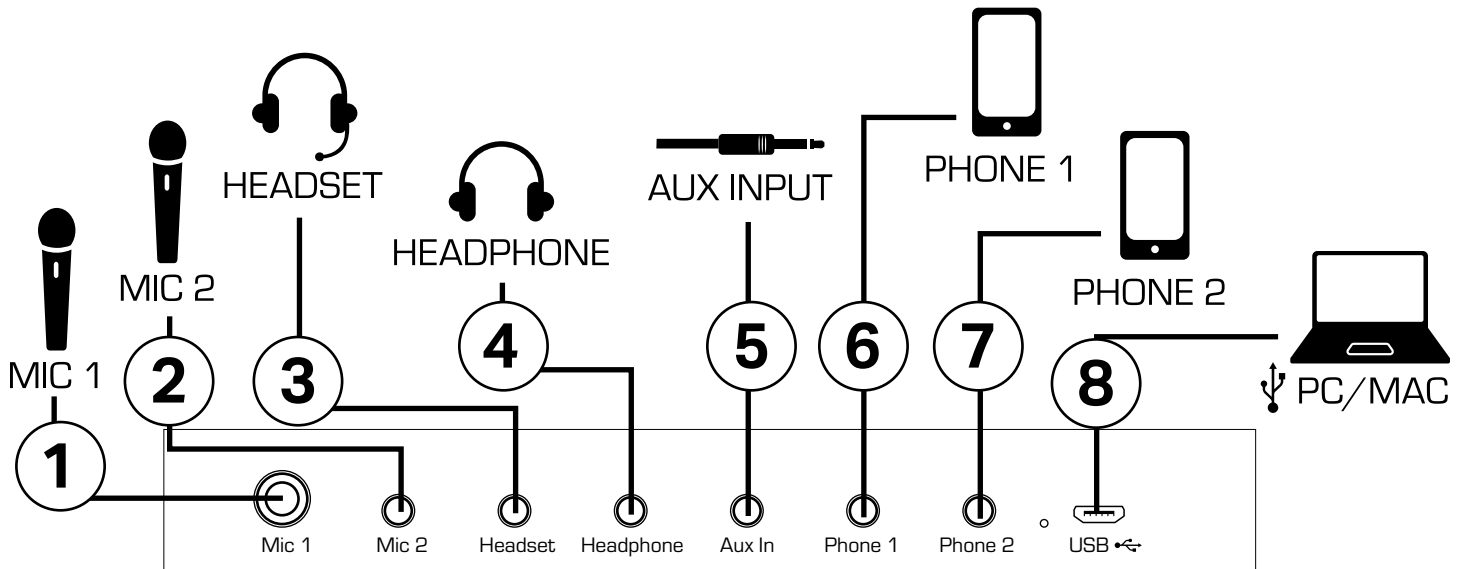

Streamer USB Rear Panel

- 1. Mic 1:** 1/4 inch input for dynamic microphones and instruments.
- 2. Mic 2:** 1/8 inch input for condenser mics that require phantom power.
- 3. Headset:** 1/8 inch input/output jack for a stereo headset mic.
- 4. Headphone:** 1/8 inch output for headphone monitoring.
- 5. Aux In:** 1/8 inch input for line level sources such as a phone or laptop.
- 6. Phone 1:** 1/8 inch input/output for connecting a phone.
- 7. Phone 2:** 1/8 inch input/output for connecting a phone.
- 8. USB:** Micro USB connection to connect to a computer. You can also charge the internal battery by connecting it to a computer, outlet, or power bank.

****Note--** When playing media while connected to either of the phone inputs, use controls on the phone to set the incoming volume.

Controls for LED Light Ring (only included in the STREAMER LIVE package)

- +** Increase light strength.
- ↻** Cycle through light settings; white light only, yellow light only, both on.
- Decrease light strength.
- ⏻** Turn light on and off.

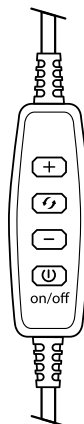

Functions/Controls

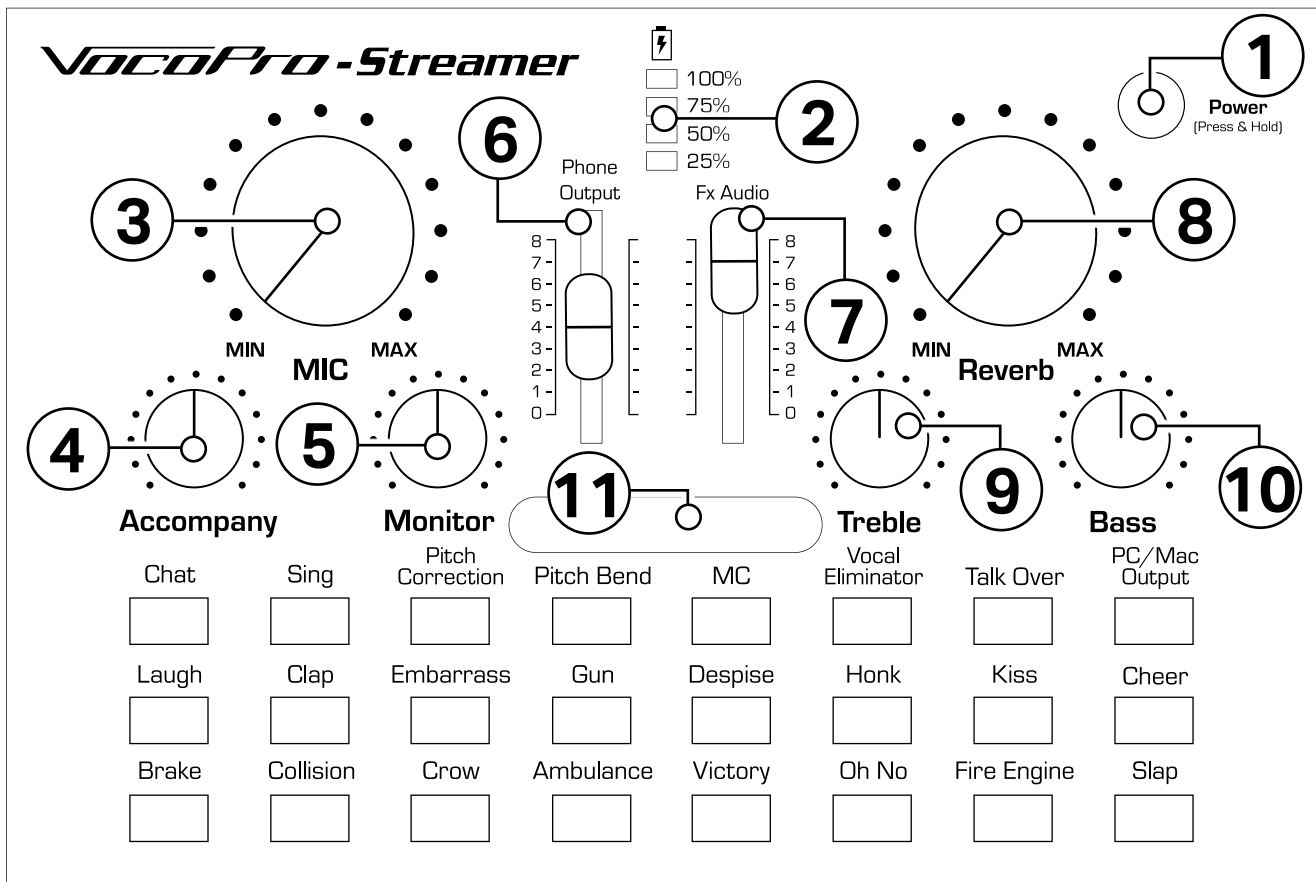

Streamer USB Top Panel

- 1. Power:** Hold to turn the Streamer on and off.
- 2. Battery:** These lights indicate how much power is left in the internal battery. When charging the battery, the lights will flash. If all lights are solid, the battery is fully charged.
- 3. MIC:** Volume control for sources plugged into the Mic 1, Mic 2, and Headset inputs.
- 4. Accompany:** Volume control for source plugged into the Aux In, or connected via Bluetooth.
- 5. Monitor:** Volume control for the Headphone and Headset outputs.
- 6. Phone Output:** Volume control for the output through the Phone 1 and Phone 2 jacks.
- 7. FX Audio:** Volume control for the built-in effects through all outputs.
- 8. Reverb:** Controls the amount of reverb added to the Mic 1, Mic 2, and Headset inputs.
- 9. Treble:** Use to increase or decrease the treble for the microphone audio.
- 10. Bass:** Use to increase or decrease the bass for the microphone audio.
- 11. Power Indicator:** The light will flash green and blue when the unit is on.
- 12. Bluetooth (📶):** The streamer is always Bluetooth enabled when powered on. When you open Bluetooth settings on your device it will be listed as VP streamer. Connect with your device and control the volume with the Accompany knob.

Functions/Controls

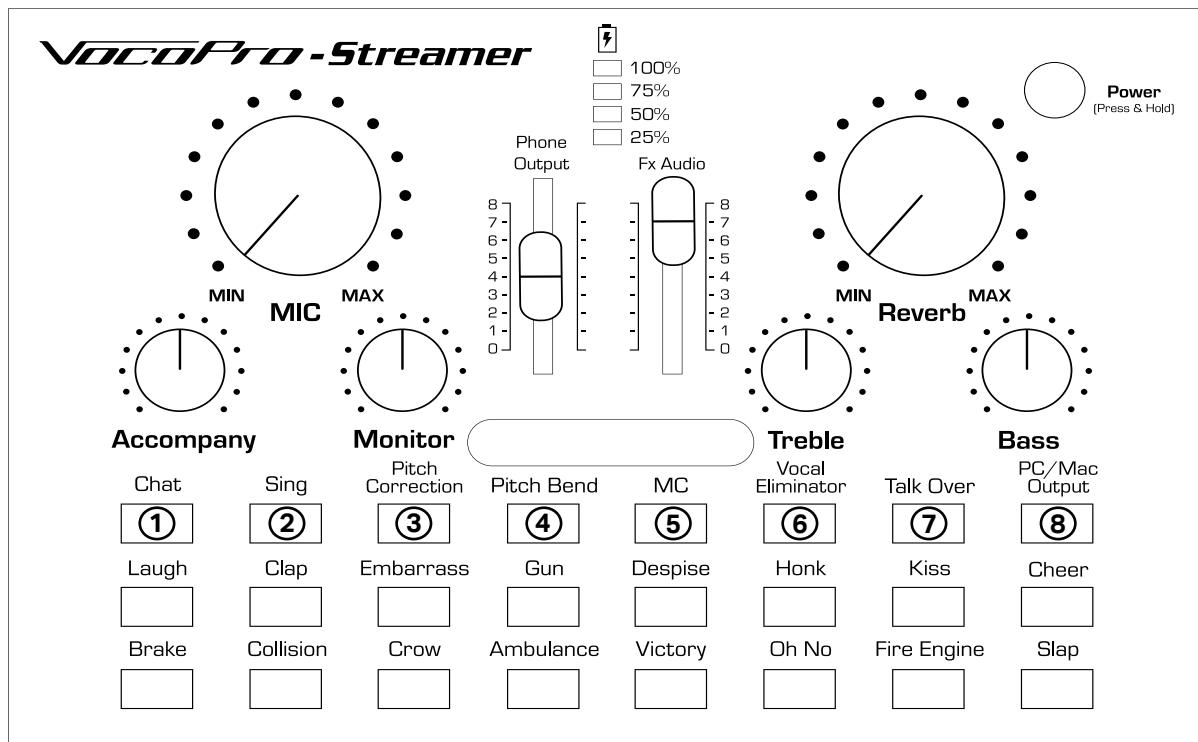

Streamer USB Top Panel

- 1. Chat:** Setting to Chat will have a natural EQ applied to your voice and disable the reverb.
- 2. Sing:** Setting to Sing will have a natural EQ applied to your voice and the reverb will be enabled.
- 3. Pitch Correction:** Press the pitch correction button to cycle through keys, starting with C major. If you have the FX Audio volume up, a voiceover will tell you what key you are in. Set the pitch correction to the key of your song and it will correct your pitch to the closest note in that key. Reverb will become enabled.
- 4. Pitch Bend:** Press to cycle through 4 pitch bending settings. Very high, high, very low, and low. The Pitch Bend setting has its own reverb applied and will disable the reverb setting on the Streamer.
- 5. MC:** Setting to MC will have a bass-heavy EQ and a different reverb applied to your voice.

** (Please note the above vocal effect buttons will flash when you are connected to the device via Bluetooth)

- 6. Vocal Eliminator:** Turning on the vocal eliminator will attempt to remove the vocals from the music playing through the Aux In or Bluetooth only. Vocals are almost entirely made up of mid-range frequencies. This setting will remove most mid-range frequencies from the music. This will eliminate all or most of the vocals, but the music is affected by the EQ as well.
- 7. Talk Over:** Turning on the Talk Over function will turn down the music playing through the Aux In or Bluetooth only, when you speak into the microphone. There is a threshold to activate Talk Over, meaning if you speak quietly into the microphone it will not activate.
- 8. PC/Mac Output:** When connected to a computer for recording, turning this on will allow you to record audio that is playing from the computer. If you are playing a song on your computer and want to record the music along with the vocals, turn this on. If you are singing to a pre-recorded track and want to record the vocals only, keep this off.

There are 16 pre-recorded sound effects built into the Streamer Interface. Plug in a pair of headphones, turn up the FX Audio, and try them for yourself!

Troubleshooting/FAQ

For many of the Troubleshooting tips below, we recommend to have headphones plugged in and the Monitor knob turned up so you can make sure audio is going through the Streamer USB.

The Streamer USB will not power on or stay on.

To turn the streamer USB on you must hold the power button for 2-3 seconds.

The battery indicator lights will show how much power the internal battery has, see if it needs to be charged. If you plug it into power and all 4 lights are flashing the power is very low.

The Streamer USB will not charge.

The Streamer USB can charge while connected to, and interfacing with, your computer. Occasionally it may connect but not charge the battery, simply disconnect and reconnect the Micro USB cable to the Streamer USB and it should begin to charge.

The Streamer USB is connected to the computer but I hear no audio from the computer.

You may need to go into your computer's System Settings or System Preferences and go to the Sound settings and change the Output Device. For many computers this will be done automatically upon connecting and turning on the Streamer USB.

The Streamer USB is connected to the computer but I get no audio when recording into my recording software/ DAW.

You may need to go into your computer's System Settings or System Preferences and go to the Sound settings and change the Input Device. For many computers this will be done automatically upon connecting and turning on the Streamer USB.

I have no microphone audio or the mic sounds odd.

Ensure the mic is connected to the Streamer USB, turned on, and MIC volume is turned up.

If you are using one of the condenser microphones that come with these packages, ensure it is connected to the 1/8 inch Mic 2 input which supplies phantom power.

If you are using a dynamic mic, connect it to the 1/4 inch Mic 1 input.

I cannot hear the built in FX or the Pitch Correction's voice over.

Ensure the FX Audio slider is turned up. It must be up to hear those effects, even through the headphones.

The audio going through the Streamer USB is not recording onto the phone.

Ensure you are using a TRRS 1/8 inch audio cable like the one included in the box. If you are using an 1/8 inch adapter to your phone's input such as Apple's Lightning to 3.5mm(1/8 inch) adapter, make sure it is a certified product. The Phone Output slider must be up to send audio through the Phone 1 and 2 connections.

Sometimes the phone will still default back to using the internal microphone for the input. Even if you can play audio from the phone and monitor with headphones, it may still try to record using the phone's internal mic. We recommend to try disconnecting and reconnecting the cable at the end to the Streamer USB and at the end to the phone.

Here is a quick way to test the connection before starting a long recording: Open your camera to take a video. Ensure everything is connected and the FX Audio and Phone Output sliders are both up. Hit record on your phone, play an effect, and stop. If you can hear the effect in your video, you are good to go for recording or streaming through any app on your phone.

LIMITED DOMESTIC WARRANTY

VOCOPRO WARRANTS ALL PRODUCTS PURCHASED IN U.S. AGAINST DEFECTS IN MATERIAL OR WORKMANSHIP FOR A PERIOD OF ONE YEAR FROM THE INITIAL DATE OF RETAIL PURCHASE FROM AN AUTHORIZED VOCOPRO DEALER, OR, ONE YEAR FROM THE DATE OF MANUFACTURE IF THE PROOF OF PURCHASE DATE IS NOT AVAILABLE. This limited warranty extends to all purchasers or owners of the product during the warranty period with the original retail purchase. VocoPro does not, however, warrant it's products against any and all defects: 1) arising out of material or workmanship not provided or furnished by VocoPro, 2) resulting from abnormal use of the product or caused by use in violation of product instructions, 3) in products repaired or serviced by other service technicians other than authorized VocoPro repair facilities, 4) in products with removed or defaced serial numbers or 5) in components, parts or products expressly warranted by another manufacturer. VocoPro agrees to supply all parts and labor to repair or replace defects covered by this limited warranty with parts or products of original or improved design, at its option in each respect, if the defective product is shipped prior to the end of warranty period to any authorized VocoPro warranty repair facility in U.S., or to the VocoPro, in the original packaging or a replacement supplied by VocoPro, with all transportation costs and full insurance paid each way by the purchaser or owner.

LIMITED WARRANTY OUTSIDE THE U.S.

VOCOPRO PRODUCTS ARE WARRANTED ONLY IN THE COUNTRY WHERE PURCHASED THROUGH AN AUTHORIZED VOCOPRO DISTRIBUTOR IN THAT COUNTRY AGAINST DEFECTS IN MATERIAL OR WORKMANSHIP. THE SPECIFIC PERIOD OF THIS LIMITED WARRANTY SHALL BE THAT WHICH IS DESCRIBED TO THE ORIGINAL RETAIL PURCHASER BY THE AUTHORIZED DEALER OR DISTRIBUTOR AT THE TIME OF PURCHASE.

VocoPro does not, however, warrant it's products against any and all defects: 1) arising out of material or workmanship not provided or furnished by VocoPro, 2) resulting from abnormal use of the product or caused by use in violation of product instructions, 3) in products repaired or serviced by other service technicians other than authorized VocoPro repair facilities, 4) in products with removed or defaced serial numbers or 5) in components, parts or products expressly warranted by another manufacturer. VocoPro agrees through the applicable authorized distributor, to repair or replace defects covered by this limited warranty with parts or products of original or improved design, at its option in each respect, if the defective product is shipped prior to end of warranty period to designated authorized VocoPro warranty repair facility in the country where purchased, or to the VocoPro Headquarter in the U.S., in the original packaging or a replacement supplied by VocoPro, with all transportation costs and full insurance paid each way by the purchaser or owner.

ALL REMEDIES AND THE MEASURE OF DAMAGES ARE LIMITED TO THE ABOVE SERVICES. IT IS POSSIBLE THAT ECONOMIC LOSS OR INJURY TO PERSON OR PROPERTY MAY RESULT FROM THE FAILURE OF THE PRODUCT; HOWEVER, EVEN IF VOCOPRO HAS BEEN ADVISED OF THIS POSSIBILITY, THIS LIMITED WARRANTY DOES NOT COVER ANY SUCH CONSEQUENTIAL OR INCIDENTAL DAMAGES. SOME STATES OR COUNTRIES DO NOT ALLOW THE LIMITATIONS OR EXCLUSIONS OF INCIDENTAL OR CONSEQUENTIAL DAMAGES, SO THE ABOVE LIMITATION MAY NOT APPLY TO YOU.

ANY AND ALL WARRANTIES, EXPRESSED OR IMPLIED, ARISING BY LAW, COURSE OF DEALING, COURSE OF PERFORMANCE, USAGE OF TRADE, OR OTHERWISE, INCLUDING BUT NOT LIMITED TO IMPLIED WARRANTIES OF MERCHANTABILITY AND FITNESS FOR A PARTICULAR PURPOSE, ARE LIMITED TO A PERIOD OF ONE YEAR FROM EITHER THE DATE OF ORIGINAL RETAIL PURCHASE OR, IN THE EVENT OF NO PROOF OF PURCHASE DATE IS AVAILABLE, THE DATE OF MANUFACTURE. SOME STATES OR COUNTRIES DO NOT ALLOW LIMITATIONS ON HOW LONG AN IMPLIED WARRANTY LASTS, SO THE ABOVE LIMITATIONS MAY NOT APPLY TO YOU.

THE LIMITED WARRANTY GIVES YOU SPECIFIC LEGAL RIGHTS, AND YOU MAY ALSO HAVE OTHER RIGHTS THAT VARY FROM STATE TO STATE, COUNTRY TO COUNTRY.

LIMITED DOMESTIC WARRANTY

From:

Place
Stamp
Here

To: VOCOPRO HEADQUARTER
1728 CURTISS COURT
LA VERNE, CA 91750

WARRANTY PROCEDURE

TO VALIDATE YOUR WARRANTY: Fill out the attached warranty card, being sure to include the model and serial number of the unit since this is how warranty cards are tracked. If your VocoPro product was purchased in the U.S., mail the completed card directly to VocoPro within 10 days of the date of purchase. If you purchased the product outside the U.S. you must file your warranty registration card with the distributor in that country. It is advised that you keep your bill of sale as proof of purchase, should any difficulties arise concerning the registration of the warranty card.

WARRANTY REGISTRATION is made and tracked by MODEL AND SERIAL NUMBER ONLY, not by the purchaser's or owner's name. Therefore any warranty correspondence or inquiries MUST include the model and serial number of the product in question. Be sure to fill in the model and serial number in the space provided below and keep this portion of the warranty card in a safe place for future reference.

WARRANTY SERVICE MUST BE PERFORMED ONLY BY AN AUTHORIZED VOCOPRO SERVICE FACILITY LOCATED IN THE COUNTRY WHERE THE UNIT WAS PURCHASED, OR AT THE VOCOPRO HEADQUARTERS IN THE U.S. It is recommended that advance notice be given to the repair facility to avoid needless shipment in case the problem can be solved over the phone. UNAUTHORIZED SERVICE PERFORMED WILL VOID ANY EXISTING FACTORY WARRANTY ON THAT PRODUCT.

FACTORY SERVICE: If you wish your product to be serviced at the factory, it must be shipped FULLY INSURED, IN THE ORIGINAL PACKING OR EQUIVALENT. This warranty will NOT cover repairs on products damaged through improper packaging. If possible, avoid sending products through the mail. Be sure to include in the package:

1. Complete return shipping address (P.O. Box number are NOT acceptable).
2. A detailed description of any problems experienced, including the make and model numbers of any other equipment in the system.

Repaired products will be returned freight C.O.D. unless sufficient return shipment funds are included with the unit.

Products sent to the factory from outside the U.S. MUST include return freight funds, and the sender is fully responsible for all, customs procedures, duties, tariffs and deposits.

RECORD THE MODEL AND SERIAL NUMBER BELOW AND RETAIN THIS PORTION OF THE WARRANTY CARD FOR YOUR FILES:

MODEL

SERIAL NUMBER

DATE OF PURCHASE

PLACE OF PURCHASE

LIMITED DOMESTIC WARRANTY

Detach this portion and mail it to the factory

MODEL _____ MANUFACTURE DATE _____ SERIAL NO. _____

OWNER'S NAME _____ ADDRESS _____

CITY _____ STATE _____ ZIP _____

The following information is appreciated, but not required:

Dealer's name and address: _____

What other products and/or product changes would you like to see Manufactured? _____

Any other comments: _____

Our Team is Here to Help



Please do not return to the retailer if you are having a technical issue operating or connecting the unit. If you need additional help, have questions, or need support with your VocoPro product contact us:

Toll Free: 800-678-5348

TEL: 909-593-8893

FAX: 909-593-8890

Email Tech Support at:
techsupport@vocopro.com

