

DENON

CD/MP3 DRIVE UNIT / CD/MP3 驱动设备

BU4500

OPERATING INSTRUCTIONS

BEDIENUNGSANLEITUNG

MODE D'EMPLOI

ISTRUZIONI PER L'USO

INSTRUCCIONES DE FUNCIONAMIENTO

GEBRUIKSAANWIJZING

BRUKSANVISNING

操作说明书

IMPORTANT TO SAFETY

WARNING:

TO PREVENT FIRE OR SHOCK HAZARD, DO NOT EXPOSE THIS APPLIANCE TO RAIN OR MOISTURE.

CAUTION

1. Handle the power supply cord carefully

Do not damage or deform the power supply cord. If it is damaged or deformed, it may cause electric shock or malfunction when used. When removing from wall outlet, be sure to remove by holding the plug attachment and not by pulling the cord.

2. Do not open the rear cover

In order to prevent electric shock, do not open the top cover.

If problems occur, contact your DENON DEALER.

3. Do not place anything inside

Do not place metal objects or spill liquid inside the system.

Electric shock or malfunction may result.

Please, record and retain the Model name and serial number of your set shown on the rating label.

Model No. BU4500

Serial No. _____



CAUTION:

TO REDUCE THE RISK OF ELECTRIC SHOCK, DO NOT REMOVE COVER (OR BACK). NO USER-SERVICEABLE PARTS INSIDE. REFER SERVICING TO QUALIFIED SERVICE PERSONNEL.

The lightning flash with arrowhead symbol, within an equilateral triangle, is intended to alert the user to the presence of uninsulated "dangerous voltage" within the product's enclosure that may be of sufficient magnitude to constitute a risk of electric shock to persons.



The exclamation point within an equilateral triangle is intended to alert the user to the presence of important operating and maintenance (servicing) instructions in the literature accompanying the appliance.



NOTE:

This CD player uses the semiconductor laser. To allow you to enjoy music at a stable operation, it is recommended to use this in a room of 5°C (41°F) ~ 35°C (95°F).

LABELS (for U.S.A. model only)

CERTIFICATION

THIS PRODUCT COMPLIES WITH DHHS RULES 21 CFR SUBCHAPTER J APPLICABLE AT DATE OF MANUFACTURE.

CAUTION:

USE OF CONTROLS OR ADJUSTMENTS OR REFORMATION OF PROCEDURES OTHER THAN THOSE SPECIFIED HEREIN MAY RESULT IN HAZARDOUS RADIATION EXPOSURE.

THE COMPACT DISC PLAYER SHOULD NOT BE ADJUSTED OR REPAIRED BY ANYONE EXCEPT PROPERLY QUALIFIED SERVICE PERSONNEL.

This device complies with Part 15 of the FCC Rules. Operation is subject to the following two conditions: (1) This device may not cause harmful interference, and (2) this device must accept any interference received, including interference that may cause undesired operation.

This Class B digital apparatus meets all requirements of the Canadian Interference-Causing Equipment Regulations.

Cet appareil numérique de la classe B respecte toutes les exigences du Règlement sur le matériel brouilleur du Canada.

• FOR CANADA MODEL ONLY

CAUTION

TO PREVENT ELECTRIC SHOCK, MATCH WIDE BLADE OF PLUG TO WIDE SLOT, FULLY INSERT.

• POUR LES MODELE CANADIENS UNIQUEMENT

ATTENTION

POUR ÉVITER LES CHOCS ÉLECTRIQUES, INTERDUIRE LA LAME LA PLUS LARGE DE LA FICHE DANS LA BORNE CORRESPONDANTE DE LA PRISE ET POUSSER JUSQU' AU FOND.

SAFETY INSTRUCTIONS

1. Read Instructions – All the safety and operating instructions should be read before the product is operated.
2. Retain Instructions – The safety and operating instructions should be retained for future reference.
3. Heed Warnings – All warnings on the product and in the operating instructions should be adhered to.
4. Follow Instructions – All operating and use instructions should be followed.
5. Cleaning – Unplug this product from the wall outlet before cleaning. Do not use liquid cleaners or aerosol cleaners.
6. Attachments – Do not use attachments not recommended by the product manufacturer as they may cause hazards.
7. Water and Moisture – Do not use this product near water – for example, near a bath tub, wash bowl, kitchen sink, or laundry tub; in a wet basement; or near a swimming pool; and the like.
8. Accessories – Do not place this product on an unstable cart, stand, tripod, bracket, or table. The product may fall, causing serious injury to a child or adult, and serious damage to the product. Use only with a cart, stand, tripod, bracket, or table recommended by the manufacturer, or sold with the product. Any mounting of the product should follow the manufacturer's instructions, and should use a mounting accessory recommended by the manufacturer.
9. A product and cart combination should be moved with care. Quick stops, excessive force, and uneven surfaces may cause the product and cart combination to overturn.
10. Ventilation – Slots and openings in the cabinet are provided for ventilation and to ensure reliable operation of the product and to protect it from overheating, and these openings must not be blocked or covered. The openings should never be blocked by placing the product on a bed, sofa, rug, or other similar surface. This product should not be placed in a built-in installation such as a bookcase or rack unless proper ventilation is provided or the manufacturer's instructions have been adhered to.
11. Power Sources – This product should be operated only from the type of power source indicated on the marking label. If you are not sure of the type of power supply to your home, consult your product dealer or local power company. For products intended to operate from battery power, or other sources, refer to the operating instructions.
12. Grounding or Polarization – This product may be equipped with a polarized alternating-current line plug (a plug having one blade wider than the other). This plug will fit into the power outlet only one way. This is a safety feature. If you are unable to insert the plug fully into the outlet, try reversing the plug. If the plug should still fail to fit, contact your electrician to replace your obsolete outlet. Do not defeat the safety purpose of the polarized plug.
13. Power-Cord Protection – Power-supply cords should be routed so that they are not likely to be walked on or pinched by items placed upon or against them, paying particular attention to cords at plugs, convenience receptacles, and the point where they exit from the product.
15. Outdoor Antenna Grounding – If an outside antenna or cable system is connected to the product, be sure the antenna or cable system is grounded so as to provide some protection against voltage surges and built-up static charges. Article 810 of the National Electrical Code, ANSI/NFPA 70, provides information with regard to proper grounding of the mast and supporting structure, grounding of the lead-in wire to an antenna discharge unit, size of grounding conductors, location of antenna-discharge unit, connection to grounding electrodes, and requirements for the grounding electrode. See Figure A.
16. Lightning – For added protection for this product during a lightning storm, or when it is left unattended and unused for long periods of time, unplug it from the wall outlet and disconnect the antenna or cable system. This will prevent damage to the product due to lightning and power-line surges.
17. Power Lines – An outside antenna system should not be located in the vicinity of overhead power lines or other electric light or power circuits, or where it can fall into such power lines or circuits. When installing an outside antenna system, extreme care should be taken to keep from touching such power lines or circuits as contact with them might be fatal.
18. Overloading – Do not overload wall outlets, extension cords, or integral convenience receptacles as this can result in a risk of fire or electric shock.
19. Object and Liquid Entry – Never push objects of any kind into this product through openings as they may touch dangerous voltage points or short-out parts that could result in a fire or electric shock. Never spill liquid of any kind on the product.
20. Servicing – Do not attempt to service this product yourself as opening or removing covers may expose you to dangerous voltage or other hazards. Refer all servicing to qualified service personnel.
21. Damage Requiring Service – Unplug this product from the wall outlet and refer servicing to qualified service personnel under the following conditions:
 - a) When the power-supply cord or plug is damaged,
 - b) If liquid has been spilled, or objects have fallen into the product,
 - c) If the product has been exposed to rain or water,
 - d) If the product does not operate normally by following the operating instructions. Adjust only those controls that are covered by the operating instructions as an improper adjustment of other controls may result in damage and will often require extensive work by a qualified technician to restore the product to its normal operation,
 - e) If the product has been dropped or damaged in any way, and
 - f) When the product exhibits a distinct change in performance – this indicates a need for service.
22. Replacement Parts – When replacement parts are required, be sure the service technician has used replacement parts specified by the manufacturer or have the same characteristics as the original part. Unauthorized substitutions may result in fire, electric shock, or other hazards.
23. Safety Check – Upon completion of any service or repairs to this product, ask the service technician to perform safety checks to determine that the product is in proper operating condition.
24. Wall or Ceiling Mounting – The product should be mounted to a wall or ceiling only as recommended by the manufacturer.
25. Heat – The product should be situated away from heat sources such as radiators, heat registers, stoves, or other products (including amplifiers) that produce heat.

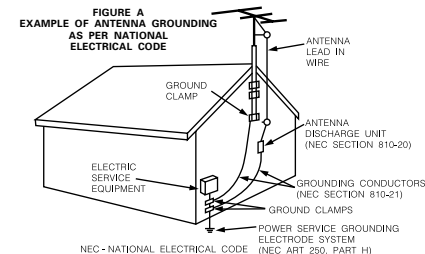

FRONT PANEL / FRONTPLATTE / PANNEAU AVANT / PANNELLO ANTERIORE /
 PANEL FRONTAL / VOORPANEEL / FRONT PANELEN / 前面板

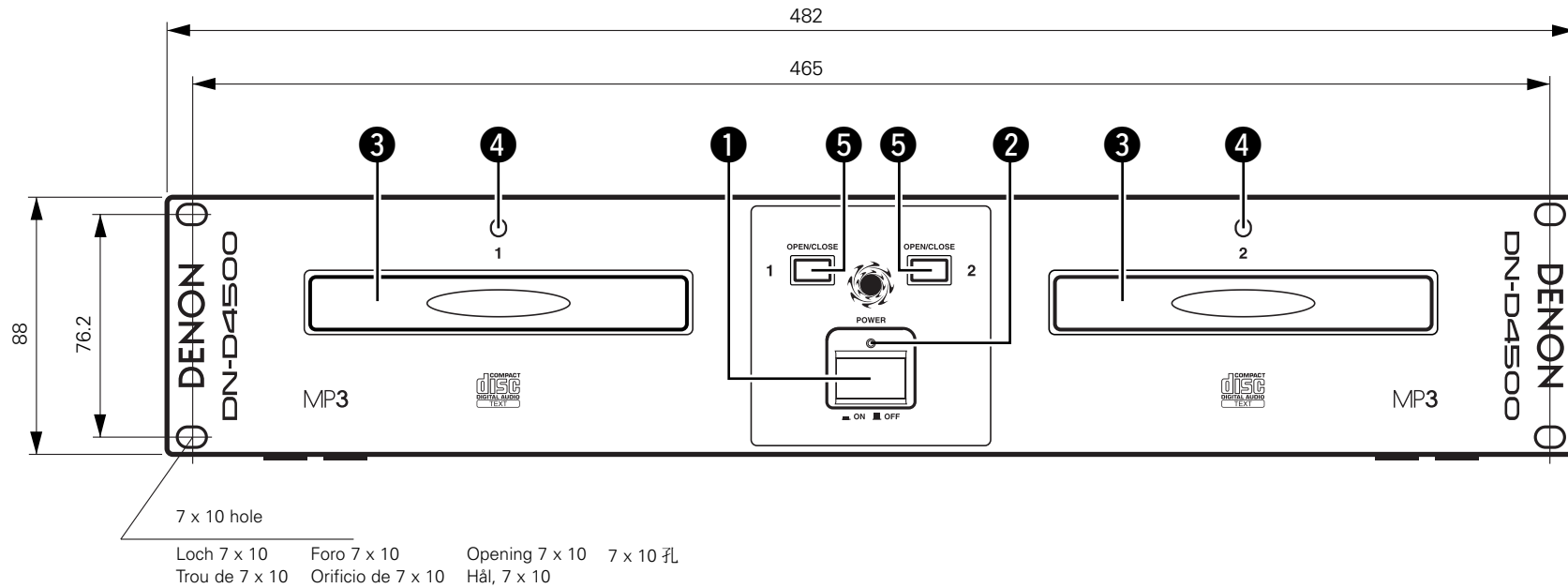





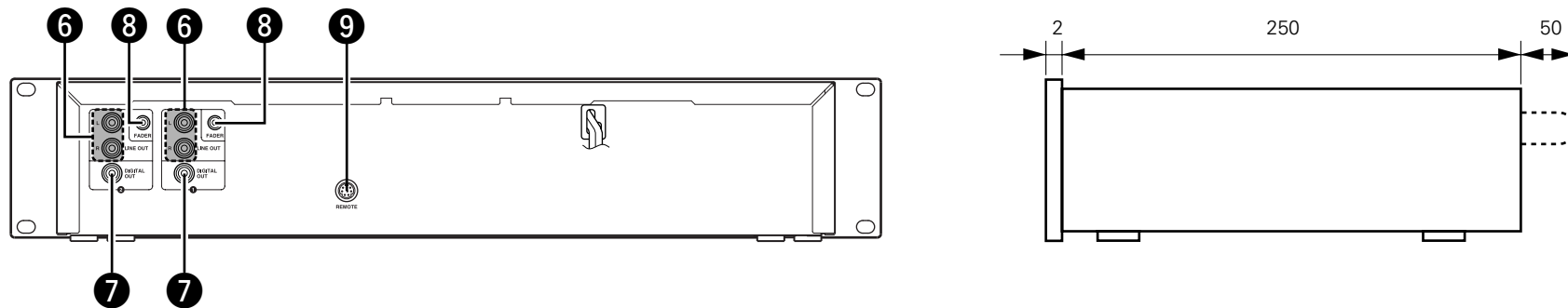

This model is DN-D4500 without remote control unit (RC-D45). / Dieses Model ist das Modell DN-D4500 ohne Fernbedienung (RC-D45). / Ce modèle est le DN-D4500 sans télécommande (RC-D45). / Questo è il modello DN-D4500 senza telecomando (RC-D45). / Este modelo es DN-D4500 sin mando a distancia (RC-D45). / Dit model is identiek aan de DN-D4500 maar heeft geen afstandsbediening (RC-D45). / Detta är modell DN-D4500 utan fjärrkontrollen (RC-D45). / 该型号为 DN-D4500, 不含遥控器 (RC-D45)。

REAR PANEL / RÜCKWAND / PANNEAU ARRIERE / PANNELLO POSTERIORE /
 PANEL TRASERO / ACHTERPANEEL / BAKSIDA / 后面板

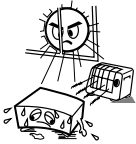

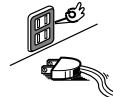
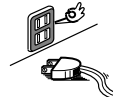
Unit: mm
 Gerät: mm
 Unité: mm
 Unità: mm
 Unidad: mm
 Eenheid: mm
 Enhet: mm
 单位: mm

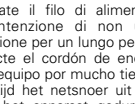
**NOTE ON USE / HINWEISE ZUM GEBRAUCH /
OBSERVATIONS RELATIVES A L'UTILISATION / NOTE SULL'USO /
NOTAS SOBRE EL USO / ALVORENS TE GEBRUIKEN / OBSERVERA**

 <ul style="list-style-type: none"> • Avoid high temperatures. Allow for sufficient heat dispersion when installed in a rack. • Vermeiden Sie hohe Temperaturen. Beachten Sie, daß eine ausreichend Luftzirkulation gewährleistet wird, wenn das Gerät auf ein Regal gestellt wird. • Eviter des températures élevées. Tenir compte d'une dispersion de chaleur suffisante lors de l'installation sur une étagère. • Evitate di esporre l'unità a temperature alte. Assicuratevi che ci sia un'adeguata dispersione del calore quando installate l'unità in un mobile per componenti audio. • Evitate altas temperaturas. Permite la suficiente dispersión del calor cuando está instalado en la consola. • Vermijd hoge temperaturen. Zorg voor een degelijk hitteafvoer indien het apparaat op een rek wordt geplaatst. • Undvik höga temperaturer. Se till att det finns möjlighet till god värmeavledning vid montering i ett rack. 	 <ul style="list-style-type: none"> • Keep the apparatus free from moisture, water, and dust. • Halten Sie das Gerät von Feuchtigkeit, Wasser und Staub fern. • Protéger l'appareil contre l'humidité, l'eau et la poussière. • Tenete l'unità lontana dall'umidità, dall'acqua e dalla polvere. • Mantenga el equipo libre de humedad, agua y polvo. • Laat geen vochtigheid, water of stof in het apparaat binnendringen. • Utsätt inte apparaten för fukt, vatten och damm. 	 <ul style="list-style-type: none"> • Do not let foreign objects in the set. • Keine fremden Gegenstände in das Gerät kommen lassen. • Ne pas laisser des objets étrangers dans l'appareil. • E' importante che nessun oggetto è inserito all'interno dell'unità. • No deje objetos extraños dentro del equipo. • Laat geen vreemde voorwerpen in dit apparaat vallen. • Se till att främmande föremål inte tränger in i apparaten.
 <ul style="list-style-type: none"> • Unplug the power cord when not using the apparatus for long periods of time. • Wenn das Gerät eine längere Zeit nicht verwendet werden soll, trennen Sie das Netzkabel vom Netzstecker. • Débrancher le cordon d'alimentation lorsque l'appareil n'est pas utilisé pendant de longues périodes. • Disinnestate il filo di alimentazione quando avete l'intenzione di non usare il filo di alimentazione per un lungo periodo di tempo. • Desconecte el cordón de energía cuando no utilice el equipo por mucho tiempo. • Neem altijd het netsnoer uit het stopcontact wanneer het apparaat gedurende een lange periode niet wordt gebruikt. • Koppla ur nätkabeln om apparaten inte kommer att användas i lång tid. 	 <ul style="list-style-type: none"> • Do not let insecticides, benzene, and thinner come in contact with the set. • Lassen Sie das Gerät nicht mit Insektiziden, Benzin oder Verdünnungsmitteln in Berührung kommen. • Ne pas mettre en contact des insecticides, du benzène et un diluant avec l'appareil. • Assicuratevi che l'unità non venga in contatto con insetticidi, benzolo o solventi. • No permita el contacto de insecticidas, gasolina y diluyentes con el equipo. • Laat geen insektenverdelgende middelen, benzine of ververdunner met dit apparaat in contact komen. • Se till att inte insektsmedel på spraybruk, bensin och thinner kommer i kontakt med apparatens hölje. 	 <ul style="list-style-type: none"> • Do not let insecticides, benzene, and thinner come in contact with the set. • Lassen Sie das Gerät nicht mit Insektiziden, Benzin oder Verdünnungsmitteln in Berührung kommen. • Ne pas mettre en contact des insecticides, du benzène et un diluant avec l'appareil. • Assicuratevi che l'unità non venga in contatto con insetticidi, benzolo o solventi. • No permita el contacto de insecticidas, gasolina y diluyentes con el equipo. • Laat geen insektenverdelgende middelen, benzine of ververdunner met dit apparaat in contact komen. • Se till att inte insektsmedel på spraybruk, bensin och thinner kommer i kontakt med apparatens hölje.
 <ul style="list-style-type: none"> • Handle the power cord carefully. Hold the plug when unplugging the cord. • Gehen Sie vorsichtig mit dem Netzkabel um. Halten Sie das Kabel am Stecker, wenn Sie den Stecker herausziehen. • Manipuler le cordon d'alimentation avec précaution. Tenir la prise lors du débranchement du cordon. • Maneggiare il filo di alimentazione con cura. Agite per la spina quando scollegate il cavo dalla presa. • Maneje el cordón de energía con cuidado. Sostenga el enchufe cuando desconecte el cordón de energía. • Hankeer het netsnoer voorzichtig. Houd het snoer bij de stekker vast wanneer deze moet worden aan- of losgekoppeld. • Hantera nätkabeln varsamt. Håll i kabeln när den kopplas från el-uttaget. 	 <ul style="list-style-type: none"> • Do not obstruct the ventilation holes. • Die Belüftungsöffnungen dürfen nicht verdeckt werden. • Ne pas obstruer les trous d'aération. • Non coprite i fori di ventilazione. • No obstruya los orificios de ventilación. • De ventilatieopeningen mogen niet worden beblokkeerd. • Täpp inte till ventilationsöppningarna. 	 <ul style="list-style-type: none"> • Never disassemble or modify the apparatus in any way. • Versuchen Sie niemals das Gerät auseinander zu nehmen oder auf jegliche Art zu verändern. • Ne jamais démonter ou modifier l'appareil d'une manière ou d'une autre. • Non smontate mai, nè modificate l'unità in nessun modo. • Nunca desarme o modifique el equipo de ninguna manera. • Nooit dit apparaat demonteren of op andere wijze modificeren. • Ta inte isär apparaten och försök inte bygga om den.
	<p>* (For apparatuses with ventilation holes)</p>	

CAUTION:

- The ventilation should not be impeded by covering the ventilation openings with items, such as newspapers, tablecloths, curtains, etc.
- No naked flame sources, such as lighted candles, should be placed on the apparatus.
- Attention should be drawn to the environmental aspects of battery disposal.
- Do not expose the set to dripping or splashing fluids.
- No objects filled with liquids, such as vases, shall be placed on the apparatus.

ACHTUNG:

- Die Belüftung sollte auf keinen Fall durch das Abdecken der Belüftungsöffnungen durch Gegenstände wie beispielsweise Zeitungen, Tischtücher, Vorhänge o. Ä. behindert werden.
- Auf dem Gerät sollten keinerlei direkten Feuerquellen wie beispielsweise angezündete Kerzen aufgestellt werden.
- Bitte beachten Sie bei der Entsorgung der Batterien die geltenden Umweltbestimmungen.
- Das Gerät sollte keinerlei Flüssigkeit, also keinem Tropfen oder Spritzen ausgesetzt werden.
- Auf dem Gerät sollten keinerlei mit Flüssigkeit gefüllten Behälter wie beispielsweise Vasen aufgestellt werden.

ATTENTION:

- La ventilation ne doit pas être gênée en recouvrant les ouvertures de la ventilation avec des objets tels que journaux, rideaux, tissus, etc.
- Aucune flamme nue, par exemple une bougie, ne doit être placée sur l'appareil.
- Veillez à respecter l'environnement lorsque vous jetez les piles usagées.
- L'appareil ne doit pas être exposé à l'eau ou à l'humidité.
- Aucun objet contenant du liquide, par exemple un vase, ne doit être placé sur l'appareil.

PRECAUZIONI:

- Le aperture di ventilazione non devono essere ostruite coprendole con oggetti, quali giornali, tovaglie, tende e così via.
- Non posizionare sull'apparecchiatura fiamme libere, come ad esempio le candele accese.

- Prestare attenzione agli aspetti legati alla tutela dell'ambiente quando si smaltisce la batteria.
- L'apparecchiatura non deve essere esposta a gocciolii o spruzzi.
- Non posizionare sull'apparecchiatura nessun oggetto contenete liquidi, come ad esempio i vasi.

PRECAUCIÓN:

- La ventilación no debe quedar obstruida por hacerse cubierto las aperturas con objetos como periódicos, manteles, cortinas, etc.
- No debe colocarse sobre el aparato ninguna fuente inflamable sin protección, como velas encendidas.
- A la hora de deshacerse de las pilas, respete la normativa para el cuidado del medio ambiente.
- No se expondrá el aparato al goteo o salpicaduras cuando se utilice.
- No se colocarán sobre el aparato objetos llenos de líquido, como jarros.

WAARSCHUWING:

- De ventilatie mag niet worden belemmerd door de ventilatieopeningen af te dekken met bijvoorbeeld kranten, een tafelkleed, gordijnen, enz.
- Plaats geen open vlammen, bijvoorbeeld een brandende kaars, op het apparaat.
- Houd u steeds aan de milieuvoorschriften wanneer u gebruikte batterijen wegdoet.
- Stel het apparaat niet bloot aan druppels of spatten.
- Plaats geen voorwerpen gevuld met water, bijvoorbeeld een vaas, op het apparaat.

OBSERVERA:

- Ventilationen bör inte förhindras genom att täcka för ventilationsöppningarna med föremål såsom tidningar, bordsdukar, gardiner osv.
- Inga blottade brandkällor, såsom tända ljus, bör placeras på apparaten.
- Tänk på miljöaspekterna när du bortskaffar batteri.
- Apparaten får inte utsättas för vätska.
- Inga objekt med vätskor, såsom vaser, får placeras på apparaten.

DECLARATION OF CONFORMITY

We declare under our sole responsibility that this product, to which this declaration relates, is in conformity with the following standards:
EN60065, EN55013, EN55020, EN61000-3-2 and EN61000-3-3. Following the provisions of 73/23/EEC, 2004/108/EC and 93/68/EEC Directive.

ÜBEREINSTIMMUNGSERKLÄRUNG

Wir erklären unter unserer Verantwortung, daß dieses Produkt, auf das sich diese Erklärung bezieht, den folgenden Standards entspricht:
EN60065, EN55013, EN55020, EN61000-3-2 und EN61000-3-3. Entspricht den Verordnungen der Direktive 73/23/EEC, 2004/108/EC und 93/68/EEC.

DECLARATION OF CONFORMITE

Nous déclarons sous notre seule responsabilité que l'appareil, auquel se réfère cette déclaration, est conforme aux standards suivants:
EN60065, EN55013, EN55020, EN61000-3-2 et EN61000-3-3. D'après les dispositions de la Directive 73/23/EEC, 2004/108/EC et 93/68/EEC.

DICHIARAZIONE DI CONFORMITÀ

Dichiaro con piena responsabilità che questo prodotto, al quale la nostra dichiarazione si riferisce, è conforme alle seguenti normative:
EN60065, EN55013, EN55020, EN61000-3-2 e EN61000-3-3. In conformità con le condizioni delle direttive 73/23/EEC, 2004/108/EC e 93/68/EEC.
QUESTO PRODOTTO E' CONFORME
AL D.M. 28/08/95 N. 548

DECLARACIÓN DE CONFORMIDAD

Declaramos bajo nuestra exclusiva responsabilidad que este producto al que hace referencia esta declaración, está conforme con los siguientes estándares:
EN60065, EN55013, EN55020, EN61000-3-2 y EN61000-3-3. Siguiendo las provisiones de las Directivas 73/23/EEC, 2004/108/EC y 93/68/EEC.

EENVORMIGHEIDSVERKLARING

Wij verklaren uitsluitend op onze verantwoordelijkheid dat dit product, waarop deze verklaring betrekking heeft, in overeenstemming is met de volgende normen:
EN60065, EN55013, EN55020, EN61000-3-2 en EN61000-3-3. Volgens de bepalingen van de Richtlijnen 73/23/EEC, 2004/108/EC en 93/68/EEC.

ÖVERENSSTÄMMELSESINTYG

Härmed intygats helt på eget ansvar att denna produkt, vilken detta intyg avser, uppfyller följande standarder:
EN60065, EN55013, EN55020, EN61000-3-2 och EN61000-3-3. Enligt stadgarna i direktiv 73/23/EEC, 2004/108/EC och 93/68/EEC.

A NOTE ABOUT RECYCLING:

This product's packaging materials are recyclable and can be reused. Please dispose of any materials in accordance with the local recycling regulations.

When discarding the unit, comply with local rules or regulations.

Batteries should never be thrown away or incinerated but disposed of in accordance with the local regulations concerning chemical waste.

This product and the accessories packed together constitute the applicable product according to the WEEE directive except batteries.

**HINWEIS ZUM RECYCLING:**

Das Verpackungsmaterial dieses Produktes ist für zum Recyceln geeignet und kann wieder verwendet werden. Bitte entsorgen Sie alle Materialien entsprechend der örtlichen Recycling-Vorschriften.

Beachten Sie bei der Entsorgung des Gerätes die örtlichen Vorschriften und Bestimmungen.

Die Batterien dürfen nicht in den Hausmüll geworfen oder verbrannt werden; bitte geben Sie die Batterien gemäß örtlichen Bestimmungen an den Sammelstellen oder Sondermüllplätzen ab.

Dieses Produkt zusammen mit den Zubehörteilen ist das geltende Produkt der WEEE-Direktive, davon ausgenommen sind die Batterien.

UNE REMARQUE CONCERNANT LE RECYCLAGE:

Les matériaux d'emballage de ce produit sont recyclables et peuvent être réutilisés. Veuillez disposer de tout matériau conformément aux règlements de recyclage locaux.

Lorsque vous mettez cet appareil au rebut, respectez les lois ou réglementations locales.

Les piles ne doivent jamais être jetées ou incinérées, mais mises au rebut conformément aux règlements locaux concernant les déchets chimiques.

Ce produit et les accessoires emballés ensemble sont des produits conformes à la directive DEEE sauf pour les piles.

NOTA RELATIVA AL RICICLAGGIO:

I materiali di imballaggio di questo prodotto sono riutilizzabili e riciclabili. Smaltire i materiali conformemente alle normative locali sul riciclaggio.

Per smaltire l'unità, osservare la normativa in vigore nel luogo di utilizzo.

Non gettare le batterie, né incenerirle, ma smaltirle conformemente alla normativa locale sui rifiuti chimici.

Questo prodotto e gli accessori inclusi nell'imballaggio sono applicabili alla direttiva RAEE, ad eccezione delle batterie.

ACERCA DEL RECICLAJE:

Los materiales de embalaje de este producto son reciclables y se pueden volver a utilizar. Disponga de estos materiales siguiendo los reglamentos de reciclaje de su localidad.

Cuando se deshaga de la unidad, cumpla con las reglas o reglamentos locales.

Las pilas nunca deberán tirarse ni incinerarse. Deberá disponer de ellas siguiendo los reglamentos de su localidad relacionados con los desperdicios químicos.

Este producto junto con los accesorios empaquetados es el producto aplicable a la directiva RAEE excepto pilas.

EEN AANTEKENING WAT BETREFT HET RECYCLEREN:

Het inpakmateriaal van dit product is recycleerbaar en kan opnieuw gebruikt worden. Er wordt verzocht om zich van elk afvalmateriaal te ontdoen volgens de plaatselijke voorschriften.

Volg voor het wegdoen van de speler de voorschriften voor de verwijdering van wit- en bruingoed op.

Batterijen mogen nooit worden weggegooid of verbrand, maar moeten volgens de plaatselijke voorschriften betreffende chemisch afval worden verwijderd.

Op dit product en de meegeleverde accessoires, m.u.v. de batterijen is de richtlijn voor afgedankte elektrische en elektronische apparaten (WEEE) van toepassing.

EN KOMMENTAR OM ÅTERTVINNING:

Produktens emballage är återvinningsbart och kan återanvändas. Kassera det enligt lokala återvinningsbestämmelser.

När du kasserar enheten ska du göra det i överensstämmelse med lokala regler och bestämmelser.

Batterier får absolut inte kastas i soporna eller brännas. Kassera dem enligt lokala bestämmelser för kemiskt avfall.

Denna apparat och de tillbehör som levereras med den är de som uppfyller gällande WEEE-direktiv, med undantag av batterierna.

CAUTION:

To completely disconnect this product from the mains, disconnect the plug from the wall socket outlet.

The mains plug is used to completely interrupt the power supply to the unit and must be within easy access by the user.

VORSICHT:

Um dieses Gerät vollständig von der Stromversorgung abzutrennen, trennen Sie bitte den Netzstecker von der Wandsteckdose ab. Die Hauptstecker werden verwendet, um die Stromversorgung zum Gerät völlig zu unterbrechen; er muss für den Benutzer gut und einfach zu erreichen sein.

PRECAUTION:

Pour déconnecter complètement ce produit du courant secteur, débranchez la prise de la prise murale.

La prise secteur est utilisée pour couper complètement l'alimentation de l'appareil et l'utilisateur doit pouvoir y accéder facilement.

ATTENZIONE:

Per scollegare definitivamente questo prodotto dalla rete di alimentazione elettrica, togliere la spina dalla relativa presa.

La spina di rete viene utilizzata per interrompere completamente l'alimentazione all'unità e deve essere facilmente accessibile all'utente.

PRECAUCIÓN:

Para desconectar completamente este producto de la alimentación eléctrica, desconecte el enchufe del enchufe de la pared.

El enchufe de la alimentación se utiliza para interrumpir por completo el suministro de alimentación a la unidad y debe de encontrarse en un lugar al que el usuario tenga fácil acceso.

VOORZICHTIGHEID:

Om de voeding van dit product volledig te onderbreken moet de stekker uit het stopcontact worden getrokken.

De netstekker wordt gebruikt om de stroomtoevoer naar het toestel volledig te onderbreken en moet voor de gebruiker gemakkelijk bereikbaar zijn.

FÖRSIKTIGHETSMÅTT:

Koppla loss stickproppen från eluttaget för att helt skilja produkten från nätet.

Stickproppen används för att helt bryta strömförsörjningen till apparaten, och den måste vara lättillgänglig för användaren.

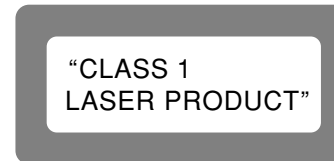
**CLASS 1 LASER PRODUCT
 LUOKAN 1 LASERLAITE
 KLASS 1 LASERAPPARAT**

ADVARSEL: USYNLIG LASERSTRÅLING VED ÅBNING, NÅR SIKKERHEDSAFBRYDERE ER UDE AF FUNKTION. UNDGÅ UDSAETTELSE FOR STRÅLING.

VAROITUS! LAITTEEN KÄYTTÄMINEN MUULLA KUIN TÄSSÄ KÄYTTÖOHJEESSA MAINITULLA TAVALLA SAATTA ALTISTAA KÄYTTÄJÄN TURVALLISUUSLUOKAN 1 YLITTÄVÄLLE NÄKYMÄMTTÖMÄLLE LASERSÄTEILYLLE.

VARNING- OM APPARATEN ANVÄNDS PÅ ANNAT SÄTT ÄN I DENNA BRUKSANVISNING SPECIFICERATS, KAN ANVÄNDAREN UTSÄTTAS FÖR OSYNLIG LASERSTRÅLNING SOM ÖVERSKRIDER GRÄNSEN FÖR LASERKLASS 1.

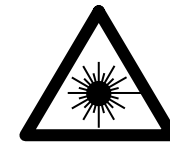



- Use compact discs that include the mark.
CD's with special shapes (heart-shaped CD's, octagonal CD's etc.) cannot be played on this set. Attempting to do so may damage the set. Do not use such CD's.
- Benutzen Sie Compact Discs, die das Zeichen tragen.
Speziell geformte CD's (herzförmige CD's, achteckige CD's, usw.) können auf dieser Anlage nicht abgespielt werden. Der Versuch derartige CD's abzuspielen kann die Anlage beschädigen. Verzichten Sie auf die Benutzung solcher CD's.
- Utiliser des disques compacts portant le logo .
Des CD avec des formes spéciales (CD en forme de coeur, des CD octogonaux, etc.) ne peuvent pas être lus sur cet appareil.
Le fait de l'essayer, risque d'endommager le lecteur. Ne pas utiliser de tels CD.
- Utilizzare compact disc contrassegnati con .
Non è possibile eseguire in questa unità CD con forme speciali (CD a forma di cuore, ottagonali, ecc.), poiché possono danneggiare il prodotto. Non utilizzare tali CD.
- Use discos compactos con la marca .
En este equipo no es posible reproducir CDs con formas especiales (CDs con forma de corazón, CDs octogonales, etc.). Si intenta hacerlo, el equipo podrá resultar dañado. No use este tipo de CDs.
- Gebruik compact discs voorzien van het logo .
CD's met speciale vormen (bijv. CD's in de vorm van een hart, achthoekige CD's, enz.) kunnen met dit toestel niet worden afgespeeld.
Wanneer u dit toch probeert, zal u het toestel beschadigen. Speel dergelijke CD's dus niet af.
- Använd CD-skivor med -märket.
Specialformade CD-skivor (hjärtformade, åttkantiga, m m) går inte att spela på den här apparaten.
Utrustningen kan skadas om du försöker göra detta. Använd inte CD-skivor av denna typ.

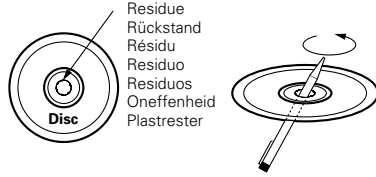

- The disc may not play normally if there is residue along the edges of the center hole.
- When using new discs in particular, use a pen, etc., to remove the residue.
- Die Disk kann nicht normal abgespielt werden, wenn sich ein Rückstand entlang der Mittellochenden befindet.
- Insbesondere, wenn Sie neue Disks benutzen, dann entfernen Sie mit einem Stift, etc. den Rückstand.
- Le disque peut ne pas être lu normalements s'il y a un résidu le long des bord du trou central.
- Lors de l'utilisation de nouveaux disques en particulier, utiliser un stylo à bille, etc., pour enlever le résidu.
- Il disco non viene eseguito in modo corretto se sono presenti residuo ai bordi del foro centrale.
- Quando si utilizzano dischi nuovi, utilizzare una penna o uno strumento simile, per rimuovere i residui.
- El disco no puede ser reproducido normalmente debido a la terminación deficiente de los bordes del agujero central.
- Para quitar estos residuos de material, especialmente cuando vaya a re-reproducir discos nuevos, utilice un bolígrafo, o algo similar.
- Het is mogelijk dat de disc niet normaal wordt weergegeven als de randen van het middengat van de schijf oneffenheden vertonen.
- Verwijder vooral bij gebruik van nieuwe discs de oneffenheden met een pen of iets dergelijks.
- Det kan uppstå fel vid CD-avspelingen om det finns plastrer kvar i mitthålet.
- Tänk på att bort dessa med en penna, e d, särskilt om CD-skivan är ny.



- This unit can display text information on the display when playing CD text discs which contain text information in English category.
The CD text disc includes the mark shown at the right.
NOTE:
This unit can provide a text display of the following types of characters. Other types of characters will result in " " being displayed.
• Alphabet
ABCDEFGHIJKLMNPOQRSTUVWXYZ
abcdefghijklmnopqrstuvwxyz
• Numbers
0123456789
• Symbols
!"#\$%&'()*+,-./:;<=>
?@[]`~{}~ SPACE^#
- Bei der Wiedergabe von CD-Textdiscs, die Funktionstasten in englischer Kategorie enthalten, kann dieses Gerät auf dem Display Funktionstasten anzeigen.
Die CD-Textdiscs sind mit dem rechts dargestellten Logo versehen.
HINWEIS:
Dieses Gerät kann aus den nachfolgend aufgeführten Zeichenarten bestehende Texte anzeigen. Bei anderen Zeichenarten wird " " angezeigt.
• Alphabet
ABCDEFGHIJKLMNPOQRSTUVWXYZ
abcdefghijklmnopqrstuvwxyz
• Zahlen
0123456789
• Symbole
!"#\$%&'()*+,-./:;<=>
?@[]`~{}~ SPACE^#
- Cet appareil peut afficher les textes d'information lors de la lecture de CD qui comportent ces textes, dans la catégorie anglaise.
Les CD avec texte se repèrent à la marque indiquée à droite.
REMARQUE:
Cet appareil permet l'affichage de textes composés avec les types de caractères suivants. Tous les autres types de caractères seront affichés ainsi " " .
• Alphabétiques
ABCDEFGHIJKLMNPOQRSTUVWXYZ
abcdefghijklmnopqrstuvwxyz
• Chiffres
0123456789
• Symboles
!"#\$%&'()*+,-./:;<=>
?@[]`~{}~ SPACE^#
- Quest'unità può visualizzare dei testi sul display durante la riproduzione di CD che contengono dei testi in inglese.
Il disco CD con testi include il marchio mostrato qui a destra.
NOTA:
Quest'unità è in grado di fornire una visualizzazione dei testi usando i seguenti tipi di caratteri. Altri tipi di caratteri causeranno la visualizzazione dell'indicazione " " .
• Alfabeto
ABCDEFGHIJKLMNPOQRSTUVWXYZ
abcdefghijklmnopqrstuvwxyz
• Numeri
0123456789
• Simboli
!"#\$%&'()*+,-./:;<=>
?@[]`~{}~ SPACE^#

- Esta unidad puede mostrar información de texto en la pantalla cuando se reproducen discos CD de Texto que contengan información de texto en la categoría de Inglés.
Los discos CD de Texto incluyen la marca indicada a la derecha.
NOTA:
Esta unidad puede mostrar visualizaciones de texto de los siguientes tipos de caracteres. Otros tipos de caracteres harán que se visualice " " .
• Alfabeto
ABCDEFGHIJKLMNPOQRSTUVWXYZ
abcdefghijklmnopqrstuvwxyz
• Números
0123456789
• Símbolos
!"#\$%&'()*+,-./:;<=>
?@[]`~{}~ SPACE^#
- Dit toestel kan tekstinformatie op het display tonen bij het weergeven van CD-Text discs met tekstinformatie in de categorie Engels.
Een CD-Text disc is voorzien van het logo rechts.
OPMERKING:
Dit toestel kan de volgende tekens als tekst weergeven. Voor andere types van tekens verschijnt " " op het display.
• Alfabet
ABCDEFGHIJKLMNPOQRSTUVWXYZ
abcdefghijklmnopqrstuvwxyz
• Getallen
0123456789
• Symbolen
!"#\$%&'()*+,-./:;<=>
?@[]`~{}~ SPACE^#
- Denna apparat kan visa text på displayen när du spelar CD-textskivor innehållande information på engelska.
CD text-skivor bär märket som anges på höger sida.
OBSERVERA:
Apparaten kan visa text med följande teckentyper. För övriga tecken kommer " " att visas.
• Alfabetiska
ABCDEFGHIJKLMNPOQRSTUVWXYZ
abcdefghijklmnopqrstuvwxyz
• Siffror
0123456789
• Symboler
!"#\$%&'()*+,-./:;<=>
?@[]`~{}~ SPACE^#

– TABLE OF CONTENTS –

1 Main features1	4 Compact discs2
2 Connections/Installation1	5 MP3 Playback3
3 Part names and functions2	6 Specifications4

■ ACCESSORIES

Check that the following parts are included in addition to the main unit:

① Operating instructions.....1	③ Remote control connection cable1
② Connection cords for signal output (RCA).....2	④ Service Station List1

1 MAIN FEATURES

The BU4500 is a CD/MP3 drive unit equipped with a variety of functions and high performance characteristics, specifically designed for Mobile and Club DJ's around the world.

1. The BU4500 can be easily mounted on a standard 19-inch rack.

2. Shockproof function protecting against external vibrations

3. MP3 Playback

It is possible to play MP3 files created in the specified format found on page 3.

Files can be searched for easily either manually, or by scanning or using a number of file search functions (File search, File/Folder search, Artist name search, Title name search, File name search).

4. CD-R/RW Playback

This player can play CD-R/RW discs, but only if they are finalized.

Note: However that depending on the recording quality, the player may not be able to play some finalized CD-R/RW discs.

2 CONNECTIONS/INSTALLATION

1. Turn off the POWER switch.
2. Connect the RCA pin cords to the inputs on your mixer.
3. Connect the control cord to the REMOTE connector on the DN-HD2500.

The BU4500 will work normally when the player unit is mounted within 10 degrees off the vertical plane at the front panel. If the unit is tilted excessively, the disc may not be loaded or unloaded properly.

CAUTION:

- Be sure to use the supplied control cord. Using another type of cable may result in damage.
- Be sure the power is off when connecting the control cord. Otherwise the units may not work properly.
- Never connect any remote controllers other than the RC-D45 and DN-HD2500. Doing so can damage the equipment.

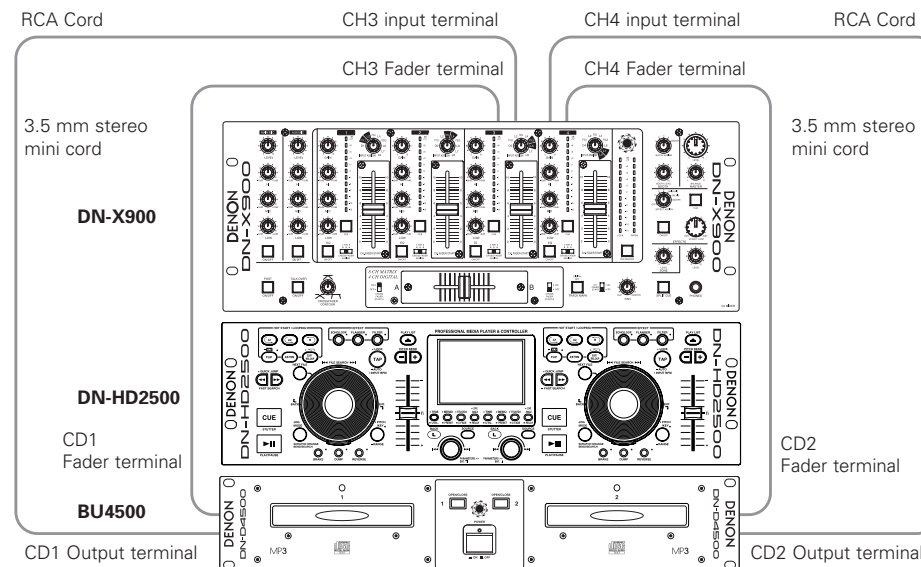
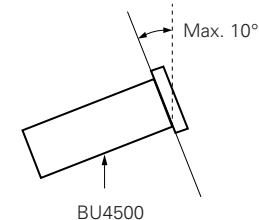

NOTE:

- Use a commercially available 3.5mm stereo mini cord for the Fader terminal connections.

3 PART NAMES AND FUNCTIONS (Refer to page III.)

(1) BU4500 Front panel

1 POWER button (ON OFF)

- Push this button to turn the power on.

NOTE:

- Be sure to close the disc trays before turning off the power.

2 POWER indicator

- This lights when the power is on.

3 Disc tray

- Place discs in this tray.
- Push the disc tray OPEN/CLOSE button to open and close the disc tray.

CAUTION:

- Do not place foreign objects in the disc trays. Doing so could damage the player.
- Do not push the disc tray in manually when the power is off, as this may result in malfunction and damage the player.

4 Disc tray indicator

- This flashes while the disc tray is opening and closing.
- The indicator lights when the disc tray is open and serves as the disc tray illumination.

5 Disc tray OPEN/CLOSE button

- Push this button to open and close the disc tray.
- The disc tray will not open during playback. Stop playback before pushing this button.

(2) BU4500 Rear panel

6 Analog output terminals 1, 2 (ANALOG OUT 1, 2)

- These are unbalanced output terminals. The audio signals from the both players are output from these terminals.

7 Digital output terminals 1, 2 (DIGITAL OUT 1, 2)

- Digital data is available from this terminal.
- Use 75 Ω /ohms pin cord for connection.
- We recommend you use braided wire type shielded cable.

NOTE: The playback level after analog conversion is set to -6 dB below the usual level to avoid digital distortion.

8 Fader input terminals 1, 2 (FADER 1, 2)

- Use this when your mixer has Fader Start function with 3.5 mm stereo mini cord.

9 Remote control connector (REMOTE)

- Connect the supplied 8 pin din cable to the RC-D45 and DN-HD2500.

4 COMPACT DISCS

(1) Precautions on handling compact discs

- Do not allow fingerprints, oil or dust on the surface of the compact disc. If the signal surface is dirty, wipe it off with a soft, dry cloth. Wipe in circular motions from the center and out.
- Do not use water, benzene, thinner, record sprays, electrostatic proof chemicals, or silicone-treated cloth to clean discs. Do not clean the disc using your shirt or pants, as this will cause damage to the disc.
- Always use care when handling discs to prevent damaging the surface, in particular when removing a disc from the case and returning it.
- Do not bend compact discs.
- Do not apply heat to compact discs.
- Do not enlarge the hole in the center of the disc.
- Do not write on the disc and do not attach any labels.
- Condensation will form on the disc surface if it is brought into a warm room from a cold area, such as outdoors during winter. Wait until the condensation disappears. Never dry discs with hair dryers, etc.

(2) Precautions on storage

- After playing a disc, always return it to its case.
- Keep discs in the cases when they are not to be played. This will protect them from dust and dirt and prolong their service life.
- Do not store discs in the following places:
 - 1) Places exposed to direct sunlight for a considerable time.
 - 2) Places subject to accumulation of dust or high humidity.
 - 3) Places exposed to high temperatures, such as close to heater outlets.

5 MP3 PLAYBACK

The BU4500 can playback MP3 files via CD-R/RW media made according to the following conditions.

* MP3 disc's made by formats other than below settings cannot be played back on our system.

* In most cases, you can find the below settings within the properties of your burners PC software.

Please refer to your manual or contact your software vendor for assistance regarding these settings.

- NOTE:**
- Depending on the type of MP3 encoding or writing software, with some files noise may be generated or it may not be possible to play the file.
 - Recordings you make are for your personal use and should not be used in ways infringing upon the copyright holder as per copyright laws.

MP3 FORMAT

Disc Format	Applicable file extensions	.mp3 .MP3 .mP3 .Mp3
	ISO9660	Level 1(max. 8/"8.3" character style)
		Level 2 (max. 31/30 character style)
	Joliet	max. 63/63 character style
	Romeo	max. 63/63 character style
	CD-ROM sector format	mode-1 only
	Folder/directory hierarchical level	max. 8 levels down (* note #1)
	Max. number of Folders	No limit (* note #2)
Max. number of files	max. 999 files (* note #3)	
MP3 Format	MPEG-1	Audio Layer-3 32-320kbps, f/s 44.1kHz
	ID-3 Tag	V1.0, V1.1, V2.2, V2.3, V2.4
	Encoding	C.B.R , V.B.R
	NOTE : .m3u Play List are not supported.	
Disc Writing Method	Disc at Once and Track at Once	
	Multi Session	If the 1st session is CDDA, you can playback only CDDA track. If the 1st session is MP3, you can playback only MP3 file.
	NOTE : Packet Write is not supported.	

note #1 Cannot playback files in a folder located further from the specified Folder/directory hierarchical level.

note #2 The number of total folders is not limited, while the number of total files is limited.

note #3 If the number of files exceeds 999, the unit can play first 999 files, and no further files are recognized.

6 SPECIFICATIONS

GENERAL

Type:	Compact disc player
Disc type:	Standard compact disc (12 cm disc), CD-TEXT CD-R, CD-RW discs
	NOTE: Finalized CD-R or CD-RW discs can be played back in this unit. However, according to recording quality, some CD-R/RW discs cannot be played.
Maximum external dimensions:	482 (W) x 88 (H) x 252 (D) mm (without feet) 18-31/32" (W) x 3-15/32" (H) x 9-59/64" (D)
Installation:	19-inch rack mountable : 2U
Mass:	6.2 kg (13 lbs 7 oz)
Power supply:	U.S.A., Canada and Taiwan R.O.C. models: AC 120 V \pm 10 %, 60 Hz European models: AC 230 V \pm 10 %, 50 Hz
Power consumption:	19 W
Environmental conditions:	Operational temperature: 5 to 35 °C (41 to 95 °F) Operational humidity: 25 to 85 % (no condensation) Storage temperature: -20 to 60 °C (-4 to 140 °F)

AUDIO SECTION

Main out, Monitor out	
Quantization:	16-bit linear per channel
Sampling frequency:	44.1 kHz at normal pitch
Oversampling rate:	8 times
Total harmonic distortion:	0.01 % or less
Signal to noise ratio:	90 dB or more
Channel separation:	85 dB or more
Frequency response:	20 to 20,000 Hz
Analog output	
Output level:	2.0 V r.m.s.
Load impedance:	10 k Ω /kohms or more
Digital output	
Signal format:	IEC958-Type 2
Output level:	0.5 Vp-p 75 Ω /ohms

* Specifications and design are subject to change without notice for purpose of improvement.

D&M Holdings Inc.

PROFESSIONAL BUSINESS COMPANY

TOKYO, JAPAN

<http://www.dm-pro.jp>

Printed in Japan 00D 511 4616 000