

KORG

Pa 9000
professional arranger

Quick Guide

Important safety instructions

- Read these instructions.
- Keep these instructions.
- Heed all warnings.
- Follow all instructions.
- Do not use this apparatus near water.
- If the exterior becomes dirty, wipe it with a clean, dry cloth. Do not use liquid cleaners such as benzene or thinner, or cleaning compounds or flammable polishes.
- Do not block any ventilation openings, install in accordance with the manufacturer's instructions.
- Do not install near any heat sources such as radiators, heat registers, stoves, or other apparatus (including amplifiers) that produce heat.
- Protect the power cord from being walked on or pinched particularly at plugs, convenience receptacles, and the point where they exit from the apparatus.
- Only use attachments/accessories specified by the manufacturer.
- Unplug this apparatus during lightning storms or when unused for long periods of time.
- Refer all servicing to qualified service personnel. Servicing is required when the apparatus has been damaged in any way, such as power-supply cord or plug is damaged, liquid has been spilled or objects have fallen into the apparatus, the apparatus has been exposed to rain or moisture, does not operate normally, or has been dropped.
- Turning off the standby switch does not completely isolate this product from the power line so remove the plug from the socket if not using it for extended periods of time, or before cleaning. Please ensure that the mains plug or appliance couple remains readily accessible.
- Mains powered apparatus shall not be exposed to dripping or splashing and that no objects filled with liquids, such as vases, shall be placed on the apparatus.
- Install this product near the wall socket and keep the power plug easily accessible.
- Do not install this equipment on the far position from wall outlet and/or convenience receptacle.
- WARNING – Date/time Lithium button cell battery inside. Danger of explosion if battery is incorrectly replaced. Replace only with the same or equivalent type. The internal date/time Lithium button cell battery is user replaceable.

- Do not expose batteries to excessive heat, such as direct sunshine, fire or the like.
- Dispose of used batteries according to the battery manufacturer's instructions.
- Do not install this equipment in a confined space such as a box for the conveyance or similar unit.
- When a cart is used, use caution when moving the cart/apparatus combination to avoid injury from tip-over.



WARNING:
TO REDUCE THE RISK OF FIRE OR ELECTRIC SHOCK DO NOT
EXPOSE THIS PRODUCT TO RAIN OR MOISTURE.

	CAUTION RISK OF ELECTRIC SHOCK DO NOT OPEN	
AVERTISSEMENT: RISQUE DE CHOC ÉLECTRIQUE—NE PAS OUVRIR.		
注意 感電の恐れあり、キャビネットをあけるな		



The lightning flash with arrowhead symbol within an equilateral triangle, is intended to alert the user to the presence of uninsulated “dangerous voltage” within the product's enclosure that may be of sufficient magnitude to constitute a risk of electric shock to persons.



The exclamation point within an equilateral triangle is intended to alert the user to the presence of important operating and maintenance (servicing) instructions in the literature accompanying the product.

THE FCC REGULATION WARNING (USA)

This equipment has been tested and found to comply with the limits for a Class B digital device, pursuant to Part 15 of the FCC Rules. These limits are designed to provide reasonable protection against harmful interference in a residential installation. This equipment generates, uses, and can radiate radio frequency energy and, if not installed and used in accordance with the instructions, may cause harmful interference to radio communications. However, there is no guarantee that interference will not occur in a particular installation. If this equipment does cause harmful interference to radio or television reception, which can be determined by turning the equipment off and on, the user is encouraged to try to correct the interference by one or more of the following measures:

- Reorient or relocate the receiving antenna.
- Increase the separation between the equipment and receiver.
- Connect the equipment into an outlet on a circuit different from that to which the receiver is connected.
- Consult the dealer or an experienced radio/TV technician for help.

Unauthorized changes or modification to this system can void the user's authority to operate this equipment.

CE MARK FOR EUROPEAN HARMONIZED STANDARDS

CE mark which is attached to our company's products of AC mains operated apparatus until December 31, 1996 means it conforms to EMC Directive (89/336/EEC) and CE mark Directive (93/68/EEC).

And, CE mark which is attached after January 1, 1997 means it conforms to EMC Directive (89/336/EEC), CE mark Directive (93/68/EEC) and Low Voltage Directive (73/23/EEC).

Also, CE mark which is attached to our company's products of Battery operated apparatus means it conforms to EMC Directive (89/336/EEC) and CE mark Directive (93/68/EEC).

IMPORTANT NOTICE TO CONSUMERS

This product has been manufactured according to strict specifications and voltage requirements that are applicable in the country in which it is intended that this product should be used. If you have purchased this product via the internet, through mail order, and/or via a telephone sale, you must verify that this product is intended to be used in the country in which you reside.

WARNING: Use of this product in any country other than that for which it is intended could be dangerous and could invalidate the manufacturer's or distributor's warranty.

Please also retain your receipt as proof of purchase otherwise your product may be disqualified from the manufacturer's or distributor's warranty.



NOTICE REGARDING DISPOSAL (EU)

If this symbol is shown on the product, manual, battery, or package, you must dispose of it in the correct manner to avoid harm to human health or damage to the environment. Contact your local administrative body for details on the correct disposal method. If the battery contains heavy metals in excess of the regulated amount, a chemical symbol is displayed below the symbol on the battery or battery package.



PERCHLORATE (CALIFORNIA, USA)

Perchlorate Material – special handling may apply.
See www.dtsc.ca.gov/hazardouswaste/perchlorate.

Automatic Power-Off

To avoid wasting power, Pa900 will by default automatically turns to standby after two hours of non-active use (playing, pressing buttons or using the touch-screen). Please save your data (Performances, Styles, Songs, and so on) before taking a prolonged pause.

Data Handling

Data in memory may sometimes be lost due to incorrect user action. Be sure to save important data to the internal hard disk or to an external USB device. Korg will not be responsible for damages caused by data loss.

Cleaning

If the exterior becomes dirty, wipe it with a clean, dry cloth. Do not use liquid cleaners such as benzene or thinner, or cleaning compounds or flammable polishes.

Use a soft cotton cloth to clean the display. Some materials, such as paper towels, could cause scratches and damage it. Computer wipes are also suggested, provided they are specifically designed for LCD screens.

Do not spray any liquids on the LCD screen directly. Always apply the solution to your cloth first, then clean the screen.

Example screens

Some pages of the manuals show LCD screens along with an explanation of functions and operations. All sound names, parameter names, and values are merely examples and may not always match the actual display you are working on.

Disclaimer

The information contained in this manual have been carefully revised and checked through. Due to our constant efforts to improve our products, the specifications might differ to those in the manual. Korg is not responsible for any eventual differences found between the specifications and the contents of the instruction manual – the specifications being subject to change without prior notice.

Trademarks

Mac is a registered trademark of Apple, Inc. MS-DOS and Windows are registered trademarks of Microsoft Corporation. TC-Helicon is a registered trademark of TC-Helicon Vocal Technologies Ltd. All other trademarks or registered trademarks are the property of their respective holders.

Open Source notice

Portions of this product's software are copyright ©2007 "The FreeType Project" (www.freetype.org). All rights reserved.

Liability

Korg products are manufactured under strict specifications and voltages required by each country. These products are warranted by the Korg distributor only in each country. Any Korg product not sold with a warranty card or carrying a serial number disqualifies the product sold from the manufacturer's/distributor's warranty and liability. This requirement is for your own protection and safety.

Service and User's Assistance

For service, please contact your nearest Authorized Korg Service Center. For more information on Korg products, and to find software and accessories for your keyboard, please contact your local Authorized Korg distributor. For up-to-date information, please point your web browser to www.korg.com.

Table of Contents

Introduction

Welcome!	4
What's in the box	5
About this manual	5
Contacts	5
Making a safety copy of your data	5
Restoring the original factory data	5
Loading the Operating System	5
Overview	6
Front Panel	6
Rear Panel	16
Start up	18
Connecting the AC power cord	18
Turning the instrument on (or in standby)	18
Controlling the Volume	18
The X-Fader slider	18
Headphones	18
Loudspeakers	19
Audio Outputs	19
MIDI connections	19
Damper pedal	19
Assignable pedal	19
The music stand	19
Glossary of Terms	20
Sound	20
Style	20
Pad	20
Keyboard tracks	20
Performance	21
Sequencer	21
Player	21
The LOGO decoder	21
Interface basics	22
Color TouchView graphical user interface	22
Operative modes	24
Selected, highlighted items	24
Non-available, grayed-out parameters	24
Shortcuts	24
Easy Mode	25
The Style Play page in detail	26
The Song Play page in detail	27
Quick Guide	
Turning the instrument on	30
Turning the instrument on and viewing the main screen	30
Connecting and calibrating the Damper pedal	31
Programming the Damper pedal	31
Playing the Demo	33
Starting and stopping the Demo	33
Playing Sounds	35
Selecting a Sound and playing it on the keyboard	35
Playing two or three Sounds at the same time	37
Playing different Sounds with your left and right hand	39
Changing the split point	41

Raising or lowering the Upper octave	42
Selecting and saving Performances	43
Selecting a Performance	43
Saving your settings to a Performance	44
Selecting and saving the "My Setting" Performance	46
Selecting the startup parameters (the "My Setting" Performance)	46
Saving the startup parameters into the "My Setting" Performance	46
Drawbars	47
Choosing a Drawbars Preset	47
Editing the Drawbars Preset	48
Selecting and playing Styles	50
Selecting and playing a Style	50
Tempo	52
Intro, Variation, Fill, Break, Ending	53
Single Touch Settings (STS)	54
The Pads	55
Adjusting the balance between the Style and the keyboard	56
Adjusting the volume of the separate tracks	56
Turning the Style tracks on/off	57
Adding harmony notes to your right-hand melody with the ENSEMBLE function	59
The Chord Sequencer	61
Song Play	63
Selecting a Song to play	63
Playing back a Song	65
Changing the tracks' volume	66
Turning the Song tracks on/off	68
Soloing a track	69
Removing the Melody track from a Standard MIDI File or the Lead Vocal from an MP3 file	69
Mixing two Songs	71
The SongBook	72
Selecting the desired Entry from the Main List	72
Displaying Artist or Genre	73
Sorting Entries	74
Searching for Entries	74
Adding Entries	76
Editing the Entries	76
Creating a Custom List	78
Selecting and using a Custom List	80
Singing with a microphone	81
Connecting a microphone	81
Setting up your voice tone	82
Choosing a Voice Processor Preset	84
Applying harmony to your voice while playing with the Styles	85
Applying harmony to your voice while playing with a Song	85
Balancing the voice, effects and tracks level	86
Soloing your voice (Talk)	86
Recording a new Song (Standard MIDI File)	87
Preparing the Style and Sounds	87
Accessing the Backing Sequence (Quick Record) mode	88
Setting the Record parameters	89
Recording	89

Second-take recording (Overdubbing)	90
Saving a Song	91
Recording a new Song (MP3 file)	93
Searching files and musical resources	95
How to use the Search function	95
Notes about searching	97

Appendix

Replacing the clock backup battery	100
Precautions	100
Installation	100
Installing a microSD card	102
Precautions	102
Installation	102
Accessing the microSD card	103
Removal	103
Technical specifications	104
MIDI Implementation Chart	105

Introduction

Welcome!

Welcome to the world of Korg Pa900 Professional Arranger! Pa900 is one of the most powerful arrangers available today, both for professional and home entertainment use.

Here are some of the features of your new instrument:

Physical Features and User Experience

- 61 semi-weighted keys with velocity and aftertouch.
- Slim and compact, lightweight, elegant cabinet design.
- Wide 7" TFT graphic touch screen display. Professional TouchView™ graphic interface for direct access to the on-screen controls and to the musical resources.
- High-quality two-way integrated amplification, and high-quality output (DAC) audio converters.
- RX (Real eXperience) Technology, the cutting edge engine that drives every aspect of the Pa900 – from the synthesis to the display and how it all works together.
- Three assignable switches, an assignable knob, a joystick and an assignable pedal ensure total control for all the various levels of articulation of the sound.

Sounds and Effects

- Powerful sound generation system, for crystal-clear, realistic sounds.
- DNC (Dynamic Nuance Control) Sounds, more realistic and vivid than ever.
- 192 MB of Sample memory for User PCM Samples. Sampling function to edit imported Samples.
- 128 voices of polyphony.
- General MIDI Level 2 Sound-compatible. Enhanced Sound compatibility for GM Songs.
- More than 1,100 Sounds, including a Stereo Piano and 77 Drum Kits.
- 320 Performance locations, plus 4 Single Touch Settings (STS) for each Style and SongBook Entry, for fast setting of keyboard sounds and effects.
- Four Stereo Master FX, with 125 effect types, including a selection of fine guitar effects created using Korg's REMS™ (Resonant structure and Electronic circuit Modeling System) technology, to deliver truly great sounding effects.
- Mastering Limiter and Final 4-band Parametric EQ

Styles and Songs

- Over 400 Factory Styles with 4 Variations and 4 Fill In + Break, plus 12 Favorite and 3 User Style banks for unlimited storage of your custom Styles and settings.
- Style and Pad Record, including the enhanced "Guitar Mode 2" for even more realistic guitar parts.
- "Chord Sequencer" function to record on-the-fly any chord progression.
- XDS Double Player with X-Fader. Plays Standard MIDI Files and MP3 files.
- Full-featured 16-track sequencer. Quick Record function to record playing with the Styles.
- Lyrics, Score and Marker display. Multi-lingual extended character set. Enhanced compatibility with Lyrics in graphical format (+G) for Standard MIDI Files and MP3 files.
- MP3 recorder. MP3 player with Vocal Remover.
- Fully editable SongBook music database, for fast song retrieving.

Microphone and Vocal Effects

- High-quality microphone preamplifier, to connect a dynamic microphone.
- Sophisticated TC-Helicon Voice Processor, with dedicated professional effects, including a 3-voice harmonizer.

Other Features

- Search function, for instant retrieving of any musical resource or file.
- Operating System updates, to load new features and enhancements. Don't let your instrument get old!
- Generous internal memory, to store the greatest amount of data, including a slot for an (optional) microSD card.
- USB 2.0 High Speed Host port, for connecting external devices like hard disks, CD-ROM drives, USB memory sticks, etc.
- USB 2.0 High Speed Device port, to connect a personal computer to your Pa900. This port can be used for file transfer or for MIDI connection (without the need of a dedicated MIDI interface for the personal computer).

What's in the box

After you buy your Pa900, please check that all the following items are included in the package. If any of the following items is missing, please contact your Korg dealer immediately.

- Pa900
- Music stand
- Power cable
- Quick Guide
- Accessory Disc (containing the Video manuals, additional manuals, an USB driver)

About this manual

In addition, in the DVD that comes with the instrument (as well as in our web site) you will find a multilingual **Video Manual**, showing how to use your Pa900 in easy steps.

Contacts

Your preferred Korg dealer not only delivers this keyboard, but also a whole bunch of hardware and software accessories, as well as service information. You should ask them for any help should you eventually need.

Our international web site is www.korg.com. Korg distributors around the world may have their own web page on the internet. A list of all Korg Distributors can be found in our dedicated web site (www.korg.co.jp/English/Distributors/).

Making a safety copy of your data

Making a safety copy

In case you like to customize your Musical Resources (Sounds, Performances and Styles), we suggest you use the Media > Utility > Backup Resources command to make frequent backup copies into compact archives.

Also, you can use the Media > Save All command to save files that you can separately reload one by one.

Restoring a safety copy

To restore a backup, use the Media > Utility > Restore Resources.

If you saved your data with the Media > Save All command, use the Media > Load operations to reload them.

Restoring the original factory data

In case you want to restore the original factory data, use the Media > Utility > Factory Restore command.

Warning: *This operation will overwrite all the Factory, Local, Favorite and User data!*

Loading the Operating System

Your Pa900 can be constantly updated as new versions of the operating system are released by Korg. You can download the operating system from our. Please, read the instructions supplied with the operating system on the site.

You can see which version of the operating systems is installed in your Pa900 by going to the Media > Utility page.

Warning: *Do not install an OS other than the official OS supplied by Korg for the Pa900. Trying to install an OS created for different models or downloaded from unofficial web sites may cause data loss and permanent damage to the instrument. Korg is not responsible for any damage caused by improper installation of the OS.*

Overview

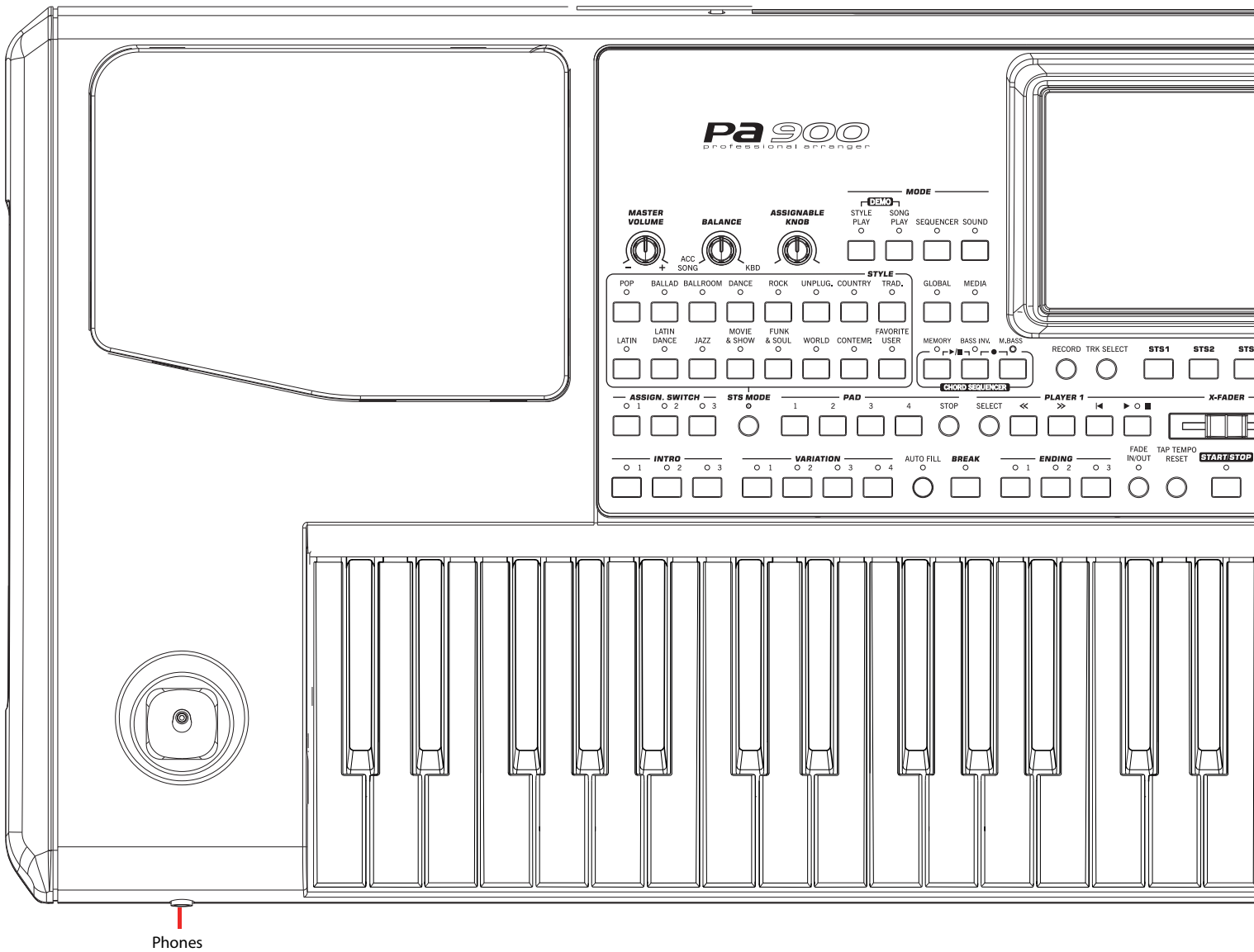

Front Panel

Speakers

The integrated speakers give a faithful reproduction of the sound of Pa900. They are automatically deactivated when inserting a jack into the PHONES connector. They can be manually deactivated with the “Speakers On/Off” parameter you can find in the Global > Audio & Video > MP3/Speakers page.

Headphones

PHONES

Connect a pair of headphones to this output. You can use headphones with an impedance of 16-200 Ohms (50 Ohms sug-

gested). Use a headphone splitter to connect more than one pair of headphones.

When connecting a jack to this connector, the integrated speakers are automatically turned off. The AUDIO OUT will however continue to work.

Joystick Lever

The joystick is on the left side of the front panel.

JOYSTICK

This joystick triggers different functions, depending on the direction it is moved towards.

X (+/-)

Move the joystick towards the left (-) to lower the pitch, or towards the right (+) to raise it. This effect is called the Pitch Bend.

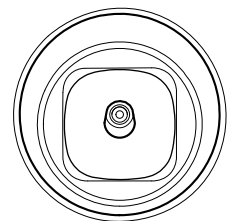

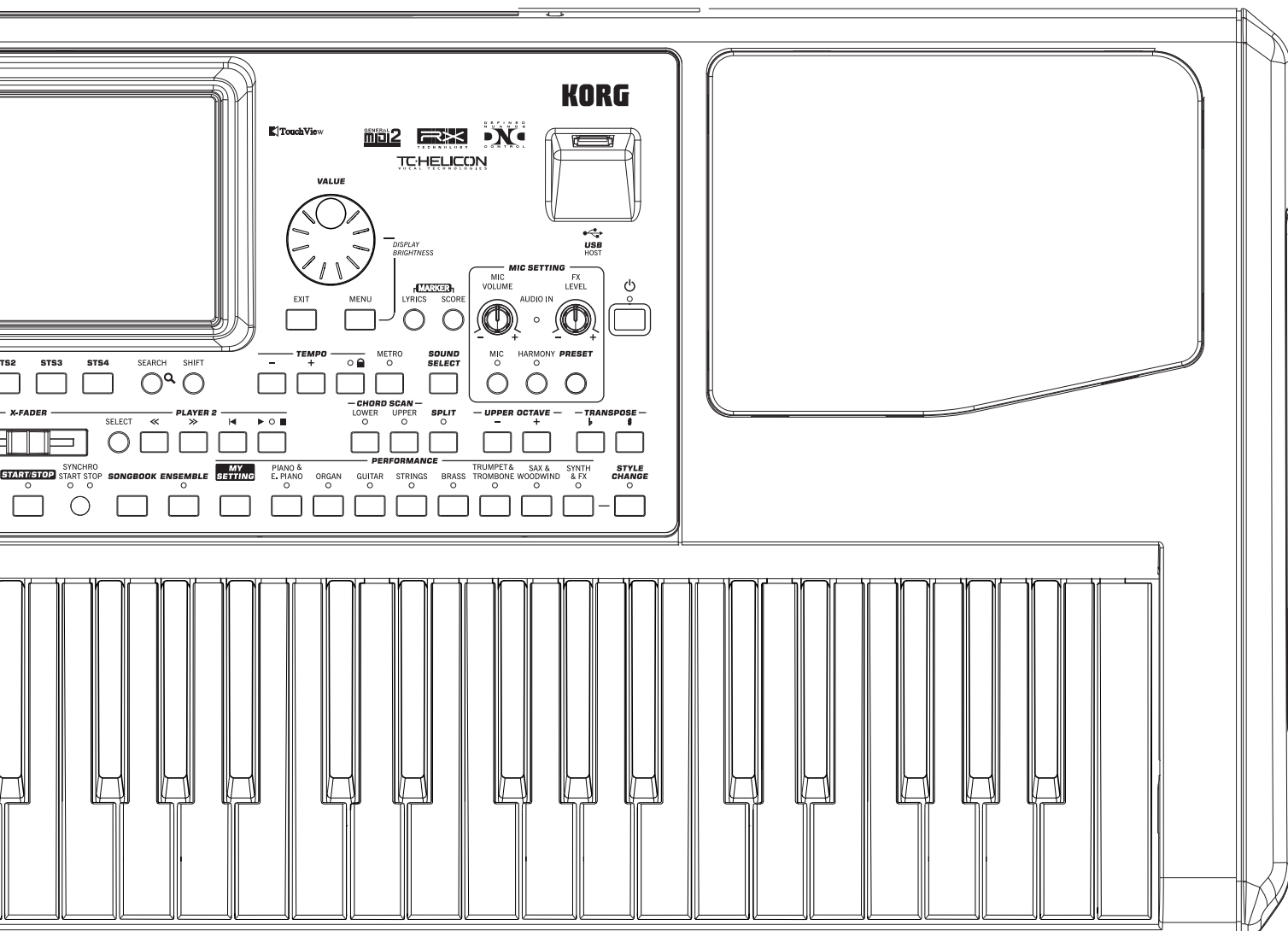

- Y+ Move the joystick forward to trigger Modulation
- Y- Move the joystick backward, to trigger the function assigned in Sound mode.

Volume Controls

Use these knobs to control the master volume, and to balance between the Keyboard and the Style or the Song.

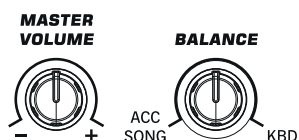

MASTER VOLUME

This knob controls the overall volume of the instrument, both of the integrated speakers, the AUDIO OUT and the PHONES outputs. It also controls the volume of the AUDIO IN inputs in the final mix.

BALANCE

While in Style Play and Song Play mode, this knob usually balances the volume of the Keyboard (KBD) tracks against the Style

(ACC, Accompaniment), Song and Pad tracks. This is a relative control, whose effective maximum value is determined by the MASTER VOLUME knob position.

When moved, a magnified version of a virtual slider appears in the display, for more accurate adjustment.

It can be programmed to work as the volume control for the Accompaniment/Song tracks only, leaving the Keyboard tracks unchanged (in the Controllers > Hand Controllers page of the Global mode).

Note: This does not work in the Sequencer and Sound modes.

Assignable Knob

ASSIGNABLE KNOB

Freely assignable knob, that can be programmed in the Global > Controllers > Hand Controllers page.



Mode Selection

Each of these buttons recalls one of the instrument's operating modes. When selected, each mode excludes all the others.

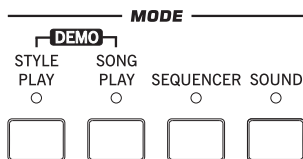

STYLE PLAY

Style Play mode, where you can play Styles (eight tracks of automatic accompaniments) and play up to four Keyboard tracks and four Pad tracks. In the main page, Keyboard tracks are shown on the right half of the display.

You can recall the main page by pressing EXIT from any of the Style Play edit pages. If you are in a different operating mode, press STYLE PLAY to recall the Style Play mode. If Keyboard tracks are not shown in the display, press the TRACK SELECT button to see them.

This operating mode is automatically selected when turning the instrument on. The "My Setting" Performance will be automatically selected.

SONG PLAY

Song Play mode, where you can play back Songs in Standard MIDI File (MID or KAR) or MP3 format. In addition to the Song tracks, you can play up to four Keyboard tracks and four Pads along with the Song(s). In the main page, Keyboard tracks are shown in the right half of the display.

You can recall the main page of this mode by pressing EXIT from any of the Song Play edit pages. If you are in a different operating mode, press SONG PLAY to recall the Song Play mode. Use the TRACK SELECT button to cycle between the Keyboard and Song tracks.

SEQUENCER

Sequencer mode, where you can play, record or edit Songs (in Standard MIDI File format). The Backing Sequence (Quick Record) mode lets you record a new Song based on the Keyboard and Style tracks, and save it as a Standard MIDI File.

Note: While in this mode, you cannot play MP3 files.

SOUND

Sound Edit mode, to play single Sounds on the keyboard, or edit them.

User Sounds may be based on User PCM Samples to be loaded into the dedicated Sample RAM memory.

Note: Pa900 cannot load compressed User PCM Samples from other Pa-Series models.

[SHIFT] While in any other operating mode, keep the SHIFT button pressed and press this button, to send the Sound assigned to the selected track to the Sound Edit mode.

DEMO

Press the STYLE PLAY and SONG PLAY buttons together to select the Demo mode. This mode lets you listen to some Demo

Songs, to let you experience the sonic power of the Pa900. To exit from this mode, press any of the MODE buttons.

Special Mode Buttons

These buttons are used to recall global settings and manage files.

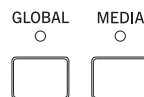

GLOBAL

This button recalls the Global mode, where you can adjust various global settings. Most Global settings are automatically memorized as soon as you edit them. This mode overlaps any operating mode, that will still remain active in the background. Press EXIT to go back to the underlying operating mode.

MEDIA

This button recalls the Media mode, where you can perform various operations on files and storage devices (Load, Save, Format, etc...). This mode overlaps any operating mode, that still remains active in the background. Press EXIT to go back to the underlying operating mode.

The internal memory contains an area where to save data ("DISK [KORG DISK]").

You can install an (optional) microSD card in the dedicated slot on the back of the instrument, and gain access to the SD unit ("SD [KORG SD]"). See for information on how to install a microSD card.

Style Section

Here you can select a Style, and activate the automatic selection of STSs.

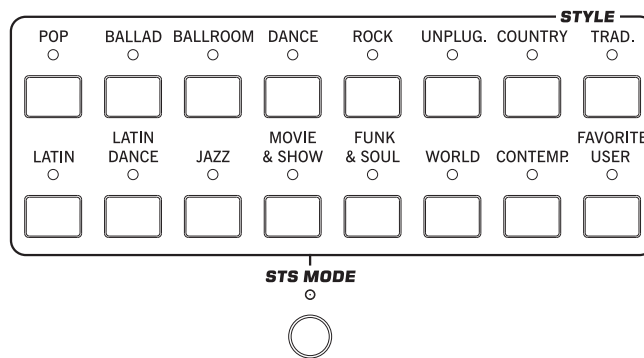

STYLE buttons

Use these buttons to open the Style Select window and choose a Style.

The FAVORITE/USER button gives access to twelve Favorite Style banks and three User Style banks. You can use User locations to temporarily load new Styles from an external device, or save newly created or edited Styles.

Favorite locations, too, can be used to load new Styles from an external device, or to save newly created or edited Styles, but in addition you can edit the names of these Style banks, so that you can create a custom set of Styles.

Each button (Style banks) contains five pages, each with up to eight Styles. Repeatedly press a STYLE button to cycle between the available pages.

 By keeping one of these buttons pressed for about one second, the “Write Current Style Settings” dialog box will appear.

STS MODE

This button lets you cycle between the following functions.

- On** When a Style is selected, STS 1 is also automatically selected. The Keyboard’s sounds and effects will change, along with the Style’s sounds and effects.
- Flashing** Variation/STS Link function activated. This function makes each Variation recall the corresponding STS when selected. For example, select Variation 2, and STS 2 will be automatically recalled; select Variation 3, and STS 3 will be automatically recalled.
- Off** When you select a Style, the Style’s sounds and effects will change. The Keyboard’s sounds and effects will not change.

Memory, Bass Inversion, Manual Bass, Chord Sequencer

These buttons let you decide what should remain in memory, and how to play the bass. In addition, they have the Chord Sequencer as a second function.

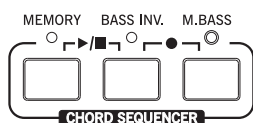

MEMORY

This button allows you to choose whether the Lower notes and/or chord triggering the accompaniment will remain in memory after raising your hand from the keyboard.

- On** Depending on the setting of the “Memory Mode” parameter (in the Global > Mode Preferences > Style), the sound on the left of the split point (Lower), and/or the chords for the automatic accompaniment can kept in memory even when you raise your hand from the keyboard.
- Off** Both the sound and chord are released as soon as you raise your hand from the keyboard.

Note: This function can be automatically activated by playing the keyboard harder, by setting the “Velocity Control” parameter (in the Global > Mode Preferences > Style page).

SHIFT You can jump to the Global > Mode Preferences > Style page by keeping SHIFT pressed and pressing the MEMORY button.

BASS INV. (Bass Inversion)

This button turns the Bass Inversion function on or off.

- On** The lowest note of a chord played in inverted form will always be detected as the root note of

the chord. Thus, you can specify to the arranger composite chords such as “Am7/G” or “F/C”.

- Off** The lowest note is scanned together with the other chord notes, and is not always considered as the root note.

M. BASS (Manual Bass)

This button turns the Manual Bass function on or off.

- On** The automatic accompaniment stops playing (except for the Drum and Percussion tracks), and you can manually play the Bass track on the Lower part of the keyboard. You can start the automatic accompaniment again after pressing this button to turn off the Manual Bass function.
- Off** The bass track is automatically played by the Style.

Note: When you press the MANUAL BASS button, the Bass track volume is automatically set to its maximum value. The volume is automatically set back to the original value when the MANUAL BASS button is deactivated.

CHORD SEQUENCER (PLAY/STOP AND RECORD)

While a Style is in play, you can use this section as a Chord Sequencer and record a looping sequence of chords. The chords will drive the arranger, leaving your hands free for solo playing.

RECORD (BASS INV. + M. BASS): Press these buttons together to start recording the Chord Sequence. Recording will start from the next measure. Press these buttons again to stop recording.

PLAY/STOP (MEMORY + BASS INV.): Press these buttons together to let the Chord Sequence play in loop, and automatically drive the arranger. The Chord Sequence will start on the next measure. Press these buttons again to stop the sequence.

The Chord Sequence will remain in memory up until you record a new Chord Sequence, or you turn the Pa900 off.

Record, Track Select

Use the RECORD and TRACK SELECT buttons to create or edit Styles, Songs or Sounds, or select track groups.



RECORD

This button sets the instrument to the Record mode (which one depends on the current operating mode).

TRACK SELECT

Depending on the operating mode, this button switches between the various track views.

STYLE PLAY MODE

Toggles between Keyboard and Style tracks.

SONG PLAY MODE

Toggles between Keyboard tracks, Song tracks 1-8, and Song tracks 9-16.

SEQUENCER MODE

Toggles between Song tracks 1-8 and Song tracks 9-16.

STS Section

Use the STS (Single Touch Settings) buttons to assign Sounds to the keyboard.

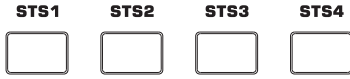

STS 1-4 buttons

These buttons allow to select up to four Single Touch Settings (abbreviated as STS). Each of the Styles and SongBook Entries includes four Single Touch Settings (STS), to automatically configure Keyboard tracks and effects at the touch of a finger.

By keeping one of these buttons pressed for about one second, the “Write Single Touch Setting” dialog box will appear.

Note: STS contained inside Factory Styles are usually write-protected (unless you uncheck the “Factory Style and Pad Protect” option in the Global > Mode Preferences > Media page)

Search, Shift

Use the SEARCH and SHIFT buttons to search the memory’s content or activate a button’s seconds function.

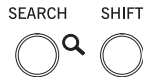

SEARCH

Press this button to open the Search window, and look for a specified file or musical resource. The Search window appears slightly different depending on the context.

SHIFT

With this button held down, pressing certain other buttons gives access to a second function. The list of shortcuts is in the Appendix.

Assignable Switches

ASSIGNABLE SWITCH

Freely assignable switches, that can be programmed in the Pad/Assignable Switch > Switch page of the Style Play or Song Play mode.

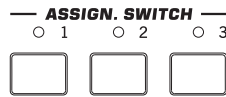

Pads

Here you can play (and stop) the Pads, i.e. single sounds or looping sequences.

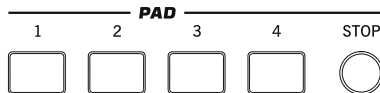

PAD 1-4 STOP

Each Pad button corresponds to a dedicated Pad track. Use these buttons to trigger up to four sounds or sequences at the same time.

- Press a single PAD button to trigger a single sound or sequence.
- Press more PAD buttons to trigger several sounds or sequences.

Sequences will play up to the end. Then, they will stop or continue repeating, depending on their “One Shot/Loop” status (see the “Pad Type” parameter in the Pad Record mode).

You can stop all sounds or sequences at the same time, or just some of them:

- Press STOP (in the PAD section) to stop all sequences at once.
- Press a single PAD button to stop the corresponding sequence.

About Pad synchronization. In Style Play mode, Pads are synchronized to the Style’s Tempo. In Song Play mode, they are synchronized to the latest Player you set to play. For example, assume you pressed PLAYER 2-PLAY; when pressing one of the PAD buttons, it will play in sync with Player 2.

Note: There is no synchronization with MP3 files. Pads can only be synchronized to the Tempo of the latest selected Standard MIDI Files. Therefore, when an MP3 file is assigned to the latest select Player, Pads will synchronize to the Tempo of the latest Standard MIDI File that has been played back.

About the Play command of Players and the Pads. When you press one of the PLAY buttons to start the corresponding Player, all Pads will stop playing.

SHIFT You can jump to the Style Play > Pad/Assignable Switch page by keeping SHIFT pressed, and pressing one of the PAD buttons.

Players Controls

Pa900 is equipped with two players (Player 1 and Player 2), each with its own set of transport controls. The Player 1 group is also used for the Sequencer mode.



SELECT

Press this button to open the Song Select window and choose a Song. This is the same as touching the Song name in the display.

<< and >>

Rewind and Fast Forward commands. If you use them while the Song is in play, they make it scroll back or forward.

When pressed once, these buttons move the Song to the previous or following measure (with a Standard MIDI File) or to the previous or next second (with an MP3 file). When kept pressed, they make the Song scroll continuously, until you release them.

In Sequencer mode, if you set a “Start from” measure other than 1, when pressing the << button the Song rewinds up to that measure instead of the first one.

(SHIFT) In Jukebox mode (Player 1), keep the SHIFT button pressed, and press these buttons to scroll to the previous or next Song in the Jukebox list.

◀ (HOME)

Sends the Song Position back to the beginning of the Song.

In Sequencer mode, if you set a “Start from” measure other than 1, the Song Position goes back to that measure.

▶/■ (PLAY/STOP)

Starts or stops the Song from the current Song Position.

(SHIFT) In Song Play mode, pressed while keeping SHIFT pressed, starts both players at the same time.

X-FADER



In Song Play mode, this slider balances the volume of the two on-board Players. When fully on the left, only Player 1 can be heard. When fully on the right, only Player 2 can be heard. When in the middle, both Players play at full volume.

This slider also selects the Lyrics, Score and Markers from one of the Players.

Note: This slider does not work in Style Play, Sequencer or Sound mode.

PLAYER 2 TRANSPORT CONTROLS

Transport controls for Player 2. See instructions for Player 1 above.

Style Elements

This section contains the separate elements of a Style (Intro, Variation, etc.).



INTRO 1-3 buttons

These buttons turn the corresponding Intro on. After pressing one of these buttons, start the Style, and it will begin with the selected Intro. The INTRO LED will automatically go off at the end of the Intro.

At the end of the Intro, the Variation whose LED was blinking will be selected.

Press one of the INTRO buttons twice (LED blinking) to let the corresponding Intro play in loop, and select any other Style element (Intro, Variation, Ending) to exit the loop (or press the same button again).

Note: Intro 1 plays a sequence including a chord progression, while Intro 2 plays a fixed chord. Intro 3 is usually a one-bar Count In.

VARIATION 1-4 buttons

Each of these buttons selects one of the four Variations of the current Style. The higher the Variation number, the denser the arrangement.

(SHIFT) You can jump to the Style Play > Drum Map page by keeping SHIFT pressed and pressing one of the VARIATION buttons.

AUTO FILL

This button allows to turn the Auto Fill function on or off.

On When selecting a different Variation, the Fill having the same number of the previous Variation is automatically selected. For example, if going from Variation 2 to Variation 3, Fill 2 is automatically selected.

Off When choosing a Variation, no fill is selected.

BREAK

This button triggers a break. Press it twice (LED blinking) to let it play in loop. Press it again or select any other Style Element (Intro, Variation, Ending) to exit from the loop.

ENDING 1-3 buttons

While the Style is running, these three buttons trigger an Ending, and stop the Style. Press one of them, and the Style will stop running with an Ending.

Press them twice (LED blinking) to let them play in loop, and select any other Style element (Intro, Variation...) to exit the loop (or press the same button again).

Note: Ending 1 plays a sequence including a chord progression, while Ending 2 plays a fixed chord. Ending 3 starts immediately, and is just two measures long.

Style Controls

Use these buttons to start/stop the accompaniment.



FADE IN/OUT

When a Style or Song is not playing, press this button to start it with the volume “fading in” (the volume goes from zero to maximum).

When a Style or Song is playing back, press this button to stop it with the volume “fading out” (the volume gradually decreases).

You don't need to press START/STOP or PLAY/STOP to start or stop the Style or Song.

Note: This does not work in Sequencer mode.

(SHIFT) You can jump to the Global > General Controls page by keeping SHIFT pressed and pressing the FADE IN/OUT button.

TAP TEMPO/RESET

This is a double-function button, acting in a different way depending on whether the Style is running or not.

Note: This button only works while in Style Play mode.

Tap Tempo: When the Style is not playing, you can “beat” the tempo on this button. Tap as many times as the Time Signature's numerator (for example, four times with a 4/4 Time Signature, or

three times with a 3/4 one). At the end, the accompaniment starts playing, using the “tapped in” tempo.

Reset: If you press this button while the Style is playing back, the Style pattern goes immediately back to the beginning of measure 1.

START/STOP

Starts or stops the Style.

Note: This function can be automatically activated by playing the keyboard harder, by setting the “Velocity Control” parameter (in the Global > Mode Preferences > Style page).

SHIFT You can reset all ‘frozen’ notes and controllers on the Pa900 and any instrument connected to its MIDI OUT or the USB Device port, by using the “Panic” (**SHIFT + START/STOP**) key combination. Just press SHIFT + START/STOP to stop all notes and reset all controllers.

SYNCHRO START / STOP button

These buttons turn the Synchro Start and Synchro Stop functions on or off. With this feature, you can choose to press the START/STOP button to start and/or stop a Style, or just play the keyboard in the Chord Scan area.

Note: This button only works while in Style Play mode.

Start On, Stop Off

In this situation, just play a chord in the chord recognition area to automatically start the Style. If you like, turn one of the INTROs on before starting the Style.

Start On, Stop On

When both LEDs are lit, raising your hands from the keyboard will momentarily stop the Style. If you play a chord again, the Style will start again.

Start Off, Stop On

In this case, raising your hands from the keyboard will stop the Style.

Start Off, Stop Off

All Synchro functions are turned off.

SHIFT You can jump to the Global > MIDI > General Control by keeping the SHIFT button pressed and pressing the SYNCHRO START/STOP button.

SongBook

SONGBOOK

The SongBook is a database of song titles, that can automatically choose the more appropriate Style, Standard MIDI File or MP3 file for you.

SONGBOOK

While you are in Style Play or Song Play mode, press this button to open the SongBook. While the SongBook is shown on the display, you can browse through the music database.

 By keeping this button pressed for about one second, a new SongBook Entry with the current settings is added to the database. You will be able to give it a name and save.

SHIFT You can jump to the SongBook > Custom List page by keeping SHIFT pressed and pressing the SONGBOOK button.

Ensemble

ENSEMBLE

The Ensemble function automatically harmonizes the melody you play with your right hand.



ENSEMBLE

This button turns the Ensemble function on or off. When on, the right-hand melody is harmonized with the left-hand chords.

Note: The Ensemble function only works when the keyboard is in SPLIT mode.

SHIFT You can jump to the Style Play > Keyboard/Ensemble page by keeping SHIFT pressed and pressing the ENSEMBLE button.

Display and Brightness Controls

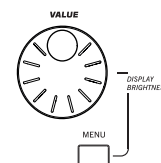

COLOR TOUCHVIEW™ GRAPHICAL DISPLAY

Use this display to interact with the instrument. To adjust the display brightness, keep the MENU button pressed, and turn the DIAL counter-clockwise to make the display darker, or clockwise to make it brighter.

Data Entry and Navigation

The VALUE DIAL can be used to assign a different value to the parameter selected in the display, or to scroll a list of files in the Song Select, SongBook, Search and Media pages.

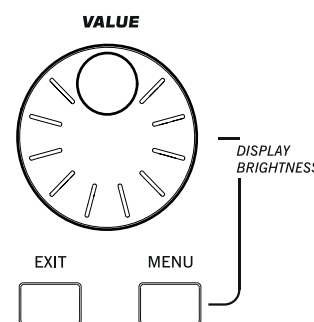

VALUE DIAL

Turn the dial clockwise to increase the value of the selected parameter. Turn it counter-clockwise to decrease its value.

MENU When used while pressing the MENU button, this control always acts as a Display Brightness control.

EXIT

Use this button to perform various actions, leaving from the current status:

- Exit the Edit menu page, without selecting any item.

- Make the page menu disappear, without selecting any item.
- Return to the main page of the current operating mode.
- Exit the Global or Media edit environment, and return to the current page of the current operating mode.
- Exit from the SongBook mode.
- Exit from the Lyrics, Score and Marker pages.
- Exit from a Style, Pad, Performance or Sound Select window.

MENU

This button opens the edit menu page for the current operating mode. After opening an edit menu, you can jump to one of the edit sections by touching the corresponding button in the display.

Otherwise, press EXIT to return to the main page of the current operating mode, or the current page of the underlying operating mode.

Lyrics, Score, Marker

Use these buttons to access the Lyrics, Score or Marker pages. Use the X-Fader to select either Player 1 or Player 2.



LYRICS

This button recalls the Lyrics page for the Song or the Style.

SCORE

Press this button to open the Score page (in Song Play mode).

MARKER

Press both the LYRICS and SCORE buttons together to open the Marker page (in Song Play mode).

Tempo Section

The TEMPO and METRO buttons can be used to control the Tempo and the Metronome.

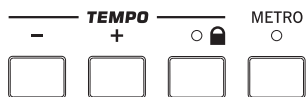

TEMPO +/- buttons

TEMPO- decreases the speed of the Style or Song. TEMPO+ increases it.

Press both buttons together to reset the Tempo to the value memorized in the Style or Standard MIDI File. With MP3 files, the original speed of the file is recalled (value reset to “0”).

TEMPO LOCK

This button turns the Tempo Lock function on or off.

On When you select a different Style or Performance, or select a different Song, the Tempo will not change. You can still manually change it, by using

the TEMPO +/- buttons, or select the Tempo value and change it by using the VALUE dial.

Off

When you select a different Style or Performance, or select a different Song, the memorized Tempo will be automatically selected.

Note: This button does not work with MP3 files.

[SHIFT] You can jump to the Global > General Controls > Lock page by keeping SHIFT pressed and pressing this button.

METRO

Use this button to turn the Metronome on or off.

[SHIFT] You can jump to the Global > General Controls > Basic page by keeping SHIFT pressed, and pressing this button.

Sound Select

SOUND SELECT

Use this button to open the Sound Select window and select a Sound to be assigned to the selected track. This is the same as touching a Sound name in the display. Repeatedly press it to cycle between the Sound bank pages.

For each type of Sounds there are several Sound banks, that can be selected by touching the side tabs. Each Sound bank contains various pages, each with up to eight Sounds, that can be selected by touching the lower tabs.

Sounds of the **Factory** type are usually write-protected (unless you uncheck the “Factory Sound Protect” option in the Global > Mode Preferences > Media page). Sounds of the **Legacy** type are standard Factory Sounds allowing greater compatibility with older Pa-Series instruments. Factory Sounds of the **GM** type allow for compatibility with General MIDI sounds. Sounds of the **User** type are locations where you can load new Sounds from an external device, or save new or edited Sounds. The **User DK** type is where you can load new Drum Kits, or save new or edited Drum Kits.

Chord Scan and Keyboard Split

Use these buttons to choose chord recognition and keyboard splitting.

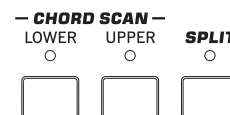

CHORD SCAN section

In Style Play, Song Play and Sequencer-Backing Sequence mode, use these buttons to define the way chords are recognized.

LOWER Chords are detected below the split point. The number of notes you should play to form a chord is defined by the Chord Scan Mode parameter.

UPPER Chords are detected above the split point. You must always play three or more notes to let the arranger recognize a chord.

FULL (both LEDs On) Chords are detected on the full keyboard range. You must always play three or more notes to let the arranger recognize a chord. (You can use this

mode even when the Split keyboard mode is selected). The “Fingered” Chord Recognition Mode is automatically selected.

OFF No chords detected. After pressing START/STOP, only the Drum and Percussion accompaniment tracks will play.

SPLIT

In Style Play, Song Play and Sequencer-Backing Sequence mode, use this button to define how the four Keyboard tracks are positioned on the keyboard, and how chords are recognized by the arranger.

Note: One of the Chord Scan options must be selected for the accompaniment to play.

On The Lower track plays below the split point, while the Upper 1, Upper 2 and Upper 3 tracks play above it. This is called the **Split** keyboard mode.

By default, turning on the Split mode automatically selects the Lower chord scanning mode (see above). In this mode, chords are detected below the split point. The number of notes you should play to form a chord is defined by the “Chord Recognition” parameter.

Off The Upper 1, Upper 2 and/or Upper 3 tracks play over the whole keyboard range. The Lower track does not play. This is also called the **Full** keyboard mode.

By default, turning off the Split mode automatically selects the Full chord scanning mode (see above). In this mode, chords are detected over the full keyboard range. You must always play three or more notes to let the arranger recognize a chord.

By keeping this button pressed for about one second, the Split Point window appears. When there, play the new split point on the keyboard.

Transpose Section

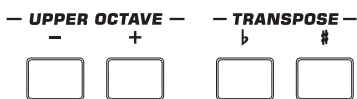

Use these buttons to transpose the Sounds.

UPPER OCTAVE

Use these buttons to transpose the Upper tracks in steps of one whole octave (12 semitones; max ±3 octaves). The octave transposition value is always shown (in octaves) next to the Sound’s name.



Press both buttons together, to reset the Octave Transpose to the saved value.

- Lowers the selected track by one octave.
- + Raises the selected track by one octave.

SHIFT You can jump to the Style Play > Mixer/Tuning > Tuning page by keeping SHIFT pressed and pressing one of the UPPER

OCTAVE buttons. **Hint:** Go to the Tuning page to separately transpose each track.

TRANPOSE

These buttons transpose the whole instrument in steps of one semitone (Master Transpose). The transpose value is usually shown in the page header.



Press both buttons together, to reset the Master Transpose to zero.

Note: You can also transpose MP3 files. Keep in mind, however, that transposition always remains inside the range -5...+6 semitones. This range is enough to cover all keys, but allows to avoid excessive audio degradation. Any further transposing will be reversed to fit the range. So, you might see a +7 transpose value (Just Fifth Up) shown in the display, but the MP3 will actually play 5 semitones lower (Just Fourth Down).

- b** Lowers the Master Transpose in steps of one semitone.
- #** Raises the Master Transpose in steps of one semitone.

SHIFT You can jump to the Global > Tuning > Transpose Control page by keeping SHIFT pressed, and pressing one of the TRANPOSE buttons.

Performance Select Section

Use these buttons to select a Performance. Performances memorize all Sounds assigned to the keyboard, most control panel settings, and an associated Style.

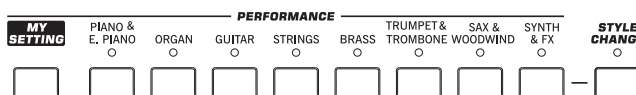

MY SETTING

This is a special direct-access Performance, that is automatically selected when the instrument is turned on. When pressing this button, the Performance is immediately selected.

Keep this button pressed for about one second to save the current settings into the My Setting Performance.

PERFORMANCE buttons

Use these buttons to open the Performance Select window, and select a Performance.

Each Performance bank contains five pages, each with up to eight Performances. Repeatedly press a PERFORMANCE button to cycle between the available pages.

All Performances can be freely customized, by accessing the edit pages of the Style Play and Song Play modes by pressing the MENU button.

By keeping one of these buttons pressed for about one second, the “Write Performance” dialog box will appear.

STYLE CHANGE

This button turns the Style Change function on or off.

- On: When you select a Performance, the Style might change according to which Style is memorized onto the Performance.
- Off: When you select a Performance, the Style will remain the same. Only Keyboard tracks (Sounds, Effects...) will be changed.

Mic Setting Section

Use these buttons to check the audio input level, set the volume of the microphone input and effects, and turn the microphone and harmony voices on or off.

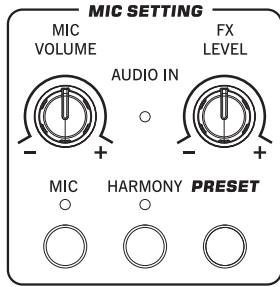

AUDIO IN LED

This LED shows the level of the audio signal entering the AUDIO IN connectors (either mic or line). Three different colors (green, orange, red) show the level. Try to keep the level so that this LED remains on green most of the time, with orange appearing at signal peaks. Never go to red.

- Off: No signal entering.
 - Green: Low- to mid-level signal entering. If the LED turns off too often, the input gain is too low. When a microphone is connected to the LEFT connector, use the MIC GAIN control to increase the input level. When a line-level device is connected, use the source device's own volume control.
 - Orange: Slight overload in the signal path. This is fine if it turns on only on signal peaks.
 - Red: Clipping is occurring in the signal path. Use the MIC GAIN control and/or the source device's volume control to lower the input level.
- See "AUDIO IN Section" on page 17 for more information on the AUDIO IN connectors.

MIC VOLUME

Use this knob to set the overall volume of the microphone signal (including the Voice Processor effects). This is equivalent to the MIC/IN track you can see in the Volume pane of the main display.

FX LEVEL

Use this knob to set the volume of the Delay and Reverb sections of the Voice Processor.

MIC ON/OFF

Press this button to turn the microphone input on or off. The LED shows the status of the microphone section.

SHIFT If you keep the SHIFT button pressed, and press this button, the Global > Mic > Global Setup page will appear.

HARMONY

Turns the Voice Harmony effect on or off. This adds harmonization voices to the lead voice.

SHIFT If you keep the SHIFT button pressed, and press this button, the Global > Mic > Harmony page will appear.

PRESET

Use this button to open the Voice Processor Preset Select window and select a Preset to be assigned to the microphone signal entering the LEFT input. This is the same as touching a Preset name in the display.

For each type of Preset there are several Preset banks, that can be selected by touching the side tabs. Each Preset bank may contain up to eight Presets.

Hold By keeping this button pressed for about one second, the "Write Voice Processor Preset" dialog box will appear.

USB Host connector

Use this connector to connect USB mass storage devices.

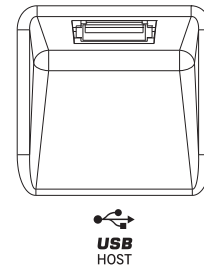

USB HOST(F) CONNECTOR

This is a USB Type A (Master/Host) connector, USB 2.0 compliant (High Speed). Use it to connect to the Pa900 an USB Flash Memory stick, an external CD-ROM drive, an USB hard disk. To access the connected device, go to the Media edit mode.

Standby On/Off

STANDBY

Use this button to let the instrument exit (LED off) or enter (LED on) standby.

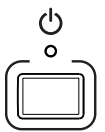

Press it briefly to let the instrument exit standby. In case there are User Sounds based on User PCM Samples, loading may take some time.

Keep it pressed for about one second to let it enter standby.

Warning: When the instrument is in standby mode, it is still connected to the power line. Accessing the inside of the instrument can be dangerous. To completely disconnect the instrument from the power, unplug the power plug from the power socket on the wall.

Note: To avoid wasting power, Pa900 will by default automatically enter standby mode after two hours of non-active use (playing, pressing buttons or using the touch-screen). Please save your data (Performances, Styles, Songs, and so on) before taking a prolonged pause. You can change the auto power-off timer in Global > General Controls > Clock & Power.

Rear Panel

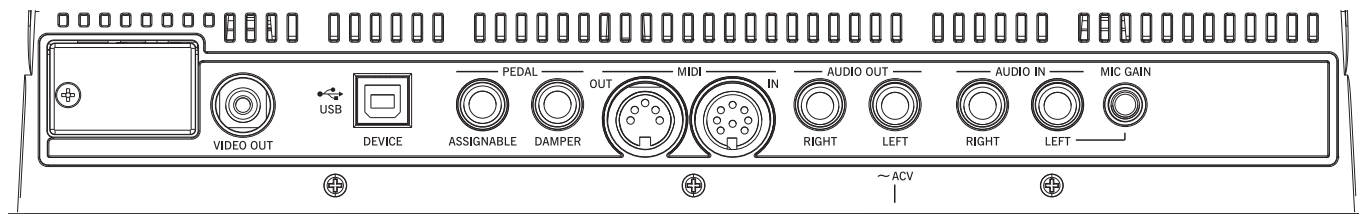

Music stand

Music stand holes

A music stand comes standard with your Pa900. Insert its legs into these two dedicated holes.

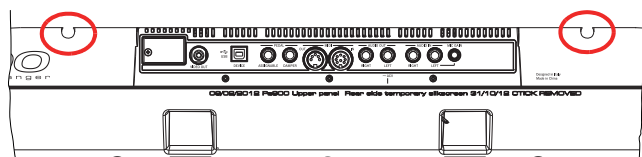

Video

VIDEO OUT

You can connect Pa900 to a TV or video monitor.

Pa900 is compatible with the NTSC, PAL and SECAM TV standard. When connecting a SECAM-compliant TV set, select the PAL standard. However, in this latter case, the image will be shown in black and white.

1. Connect the instrument's video output to the video input of the television set. Depending on the type of television set, you can use a cable of the type "RCA-to-RCA" (if the television set is equipped with a Video Composite input), or "RCA-to-SCART" (if the television set is equipped with a SCART connector). You can buy the needed cables at a store that sells television equipment.

2. Turn the instrument on, and press the GLOBAL button to gain access to the Global mode. Go to the Audio & Video > Video Out page, and select the video standard (PAL or NTSC).

3. Turn the television set on, and tune it on the correct AV input.

4. In the same page of the Global, use the Colors parameter to choose the preferred set of colors for the lyrics and the background.

USB Device Connector

Use this connector to connect Pa900 to a personal computer.



DEVICE

This is a USB Type B (Slave/Device) connector, USB 2.0 (High Speed). Use it to connect the Pa900 to a personal computer, and transfer data to/from its internal memory (Disk). You can enable USB connection in the "USB" page of the Media mode.

MIDI over USB is supported, so you can use this connector instead of the MIDI ports. The drivers for PC and Mac, needed to make full use of this type of connection, are supplied in the Accessory Disc that comes with the instrument, or can be downloaded from our.

Pedals

Use these connectors to connect various types of pedals.

ASSIGNABLE

Use this port to connect a continuous- or footswitch-type pedal, like the (optional) Korg EXP-2, XVP10, PS-1 or PS-3. To program and calibrate it, go to the Controllers > Foot Controllers page of the Global mode.

DAMPER

Use this to connect a Damper pedal, like the (optional) Korg PS1, PS3 or DS1H. To change its polarity and calibrate it, go to the Controllers > Foot Controllers page of the Global mode.

Note: Half-peddalling on Piano Sounds is available when connecting a DS1H Damper pedal.

MIDI Interface

The MIDI interface allows your Pa900 to be connected to external controllers (master keyboard, MIDI guitar, wind controller, MIDI accordion...), to a series of expanders, or to a computer running a sequencer.

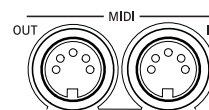

OUT

This connector sends MIDI data generated by Pa900's keyboard, controllers, and/or the internal player. Connect it to an expander's or computer's MIDI IN.

IN

This connector receives MIDI data from a computer or a controller. Connect it to an external controller's or computer's MIDI OUT.

AUDIO OUT Section

Use these connectors to send the audio signal (sound) to a mixer, a PA system, a set of powered monitors, or your hi-fi system.



LEFT, RIGHT

Use these line-level outputs to send the final stereo mix to an external device. Connect either of them to output the signal in mono. Adjust the output level with the MASTER VOLUME knob.

Connect two mono cables to these outputs. Connect the other end of the cables to a stereo channel of your mixer, two mono channels, two powered monitors, or the CD, LINE IN or TAPE/AUX input of your audio system. Don't use the PHONO inputs of your audio system!

Connecting a jack to these outputs will not deactivate the integrated speakers. This way, you can continue to monitor your playing, while the signal is sent to the main mixer.

AUDIO IN Section

Use these connectors to connect a dynamic microphone, another keyboard/synthesizer, or a CD player.

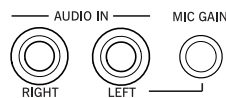

LEFT, RIGHT

Use these connectors to connect a line-level input source, such as a CD player or a synthesizer, or a dynamic microphone. The signal routing, and the correct impedance for these inputs, can be selected with the “Input Routing” parameter in the Global > Audio & Video > Audio In page.

- When the “Input Routing” parameter is set to “Left In to Voice Processor”, you can connect a dynamic microphone to the LEFT audio input. Use the MIC GAIN knob to adjust the input gain. Set the volume level of the AUDIO IN signal in the mix by using the MIC VOLUME knob, while watching at the AUDIO IN LED on the control panel (see “Mic Setting Section” on page 15).
- When the “Input Routing” parameter is set to “Audio Ins to Direct Out”, you can connect a line-level input source to the LEFT and RIGHT audio inputs. Use the source's output volume control to adjust the input level, while watching at the AUDIO IN LED on the control panel.

MIC GAIN

Use this controls to adjust the input sensitivity of the LEFT connector (from 0 to +40dB) when it is set to the microphone input sensitivity (see above). You can check the input level by watching at the AUDIO IN LED on the control panel (see “Mic Setting Section” on page 15).

Power

This is where you connect Pa900 to the power line.

ACV cable connector

Plug the supplied AC cable into this connector. When the cable is connected, the instrument is in standby mode. To let it enter or exit standby, use the STANDBY switch located on the front panel.

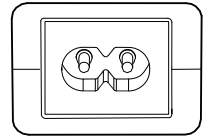

Warning: When the instrument is in standby mode, it is still connected to the power line. Accessing the inside of the instrument can be dangerous. To completely disconnect the instrument from the power, unplug the power plug from the power socket on the wall.

Start up

Connecting the AC power cord

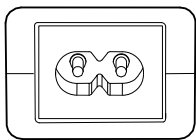

Connect the supplied power cord to the dedicated socket on the rear of the instrument. Then, plug it into a wall socket. You don't need to worry about the local voltage, since the Pa900 uses a universal power adapter.

When the cable is connected to the power, the instrument automatically enters standby mode.

Turning the instrument on (or in standby)

Press the STANDBY button on the front panel to let the instrument exit standby. The display will light up, showing the boot procedure.

Note: When the instrument exits standby, User PCM Samples used by some User Sounds may be automatically loaded. Loading them may take some time.

Keep the STANDBY button pressed for about one second to let the instrument enter standby.

Warning: When putting the instrument in standby, all data contained in RAM (Song recorded or edited in Sequencer mode, the Chord Sequence, Samples in edit and not yet saved) will be lost. MIDI Grooves generated by the Time Slice function will be lost, too.

On the contrary, data contained in the internal memory (Factory data, User Sounds, Performances, Styles and Multisamples) will be preserved. Saved Samples will be preserved as well.



Controlling the Volume

Master Volume



Use the MASTER VOLUME knob to control the overall volume of the instrument. This knob controls the volume of the sound going to the integrated speakers, the AUDIO OUT and PHONES connectors.

Note: Begin at a moderate level, then raise the MASTER VOLUME up. Don't keep the volume at an uncomfortable level for too long.

Keyboard, Style Accompaniment and Song Volume

By default, the BALANCE knob balances the volume of the Keyboard (KBD) tracks, against the Style's Accompaniment (ACC), Song and Pad tracks.



- When in Style Play mode, this knob balances between the Keyboard tracks, and the Style and Pad tracks.
- When in Song Play mode, this knob balances between the Keyboard tracks, and the Player and Pad tracks.

This is a relative control, whose effective maximum level is determined by the MASTER VOLUME knob position.

When moved, a magnified version of the virtual slider appears in the display, for more accurate positioning.

As an alternative, the knob can be used to control the Style/Song Volume without affecting the Keyboard tracks (choose the desired behavior by editing the "Balance Control" parameter in the Global > Controllers > Hand Control page).

Note: This knob only works in Style Play and Song Play mode; it does not work in Sequencer mode.

The X-Fader slider

The X-FADER slider sets the relative volume of the two onboard players (Player 1 and Player 2).



- Move it fully to the left to set Player 1 to the maximum level and Player 2 to zero.
- Move it fully to the right to set Player 1 to zero and Player 2 to the maximum level.
- Move it to the center to set both Players at the same level.

This slider also selects the Harmony source, as well as the Lyrics, Score and Markers of one of the two players.

Headphones

Connect a pair of headphones to the PHONES output, on the left side of the keyboard (under the joystick). You can use headphones with an impedance of 16-200 Ohms (50 Ohms suggested). Use a headphone splitter to connect more than one pair of headphones.

Note: When connecting the headphones, the speakers are automatically deactivated.

Loudspeakers

Pa900 is fitted with four powerful, high-quality integrated speakers and a bass-reflex box, powered by a 20+20 Watt amplification system.

The overall volume can be controlled via the MASTER VOLUME knob.

Speakers can be deactivated with the “Speakers On/Off” parameter, that you can find in the Global > Audio & Video: MP3/Speakers page.

Audio Outputs

Audio outputs allow for connecting Pa900 to an external amplification system. The overall volume can be controlled via the MASTER VOLUME knob.

MIDI connections

You can play the internal sounds of your Pa900 with an external controller, i.e. a master keyboard, a MIDI guitar, a wind controller, a MIDI accordion, or a digital piano.

You can also control other MIDI devices with Pa900, or connect it to a computer for use with an external sequencer.

As an alternative to the MIDI connectors, you can use the USB Device port for direct connection to a personal computer.

Damper pedal

Connect a Damper (Sustain) pedal to the DAMPER connector on the back panel. Use an (optional) Korg PS1, PS3 or DS1H footswitch pedal, or a compatible one. With the Korg DS1H, half-peddaling can be used on some Grand Piano sounds. To calibrate and switch the Damper polarity, go to the Controllers > Foot Controller page of the Global mode.

Assignable pedal

Connect either a footswitch or an expression pedal to the ASSIGNABLE connector on the back panel. Use an (optional) Korg PS1 or PS3 footswitch pedal, a Korg EXP-2 expression pedal, a Korg XVP-10 volume pedal, or a compatible one. To calibrate the pedal, go to the Controllers > Foot Controller page of the Global mode.

The music stand

A music stand comes standard with your Pa900. Insert its legs into the two dedicated holes on the rear panel, as shown in the illustration:

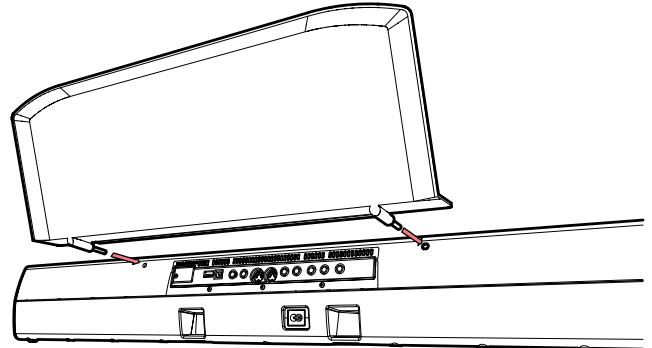

Glossary of Terms

Before you begin, take a few moments to familiarize yourself with the names and terms we will be using to talk about the various elements of the Pa900.

In this section, you will find a brief description of various key elements of the Pa900. A professional arranger (Pa) keyboard uses different terminology than a traditional synthesizer or workstation. By familiarizing yourself with the names and functions in this section, you will get a better understanding of how all the different parts of the Pa900 work together to create a realistic musical performance. This will also help you to get the most out of the rest of the manual.

Sound

A Sound is the most basic unit of an Arranger Keyboard performance. A Sound is basically a playable instrument timbre (piano, bass, sax, guitar...) that can be edited, saved, recalled and assigned to any track. An individual Sound can be played on the keyboard in the Sound mode. In the Style Play, Song Play or Sequencer mode, Sounds may be freely assigned to Sequencer tracks, Style tracks, or Keyboard tracks.

Style

The Style is the heart of a professional arranger keyboard. At its basic level, a Style will consist of up to eight parts, or "Tracks".

Drums

The Drum track will provide a repeating rhythmic phrase, played by the standard instruments of a Drum Kit.

Percussion

An additional rhythmic phrase played by various percussion instruments (conga, shaker, cowbell, etc.) is provided by the Percussion track.

Bass & Accompaniment

The Bass track and the (up to) five additional Accompaniment tracks will each play musical phrases that are musically related to and in sync with the Drum and Percussion tracks. However, the notes being played by these tracks *will* change to follow the chord progression that you play on the keyboard.

Again, any Sound you choose may be assigned to any track in a Style.

Variation

For each Style, there are four Variations, to be used for the Verse, Bridge and Chorus of a song. In general, each Variation is a slightly different version of the others. As you progress from Variation one to Variation four, the arrangements will become more complex, and more parts (Tracks) may be added. This allows your performance to have a more dynamic arrangement, without losing the original "feel" of the Style.

Fill-in & Break

During a performance, a drummer may often perform a "fill" - such as when transitioning from a verse to a chorus - adding extra dynamics and keeping the beat from getting too repetitive. The Pa900 offers four Fill-ins specifically programmed for each Style, that may be automatically recalled when choosing the corresponding Variation (Auto Fill). A Fill-in may be drums alone or drums with instrumentation. Then, there is even a silent "break".

Intro & Ending

Each Style also allows you to complete your performance with a set of musical introductions and endings. A long and short version of the Intro and Ending are usually provided, with the former more harmonically elaborated, and the latter with a fixed chord. A "count-in" Style Intro is also provided, as well as the quick Ending 3.

Pad

Pads are single sounds or single-track patterns, that can be triggered by using the dedicated PAD buttons. They can be used to play in realtime single sounds, as well as short, cycling sequences that play in time with the Style or Standard MIDI File, and are transposed according to the recognized chords.

Keyboard tracks

In addition to the Style and Pad tracks, up to four additional parts can be played on the keyboard in real-time. Each of these Keyboard tracks can be limited to a particular range of keys or velocities, but in general up to three can be assigned to play above the split point (Upper), and one below (Lower). This allows the Upper Sounds to be layered together. The split point can be set to any note on the keyboard. In addition to performing along with a Style, these same Keyboard tracks will allow you to play along with the Players.

STS (Single Touch Settings)

Single Touch Settings allow you to instantly change the sounds assigned to each of the Keyboard tracks with a single button press, allowing for wide variation in sounds during a performance. Four STS (Single Touch Settings) can be saved with each Style or SongBook Entry.

Ensemble

By turning the Ensemble feature on, a single note played on one of the Keyboard tracks will be embellished by additional notes to create a complete chord voicing. The Ensemble knows which notes to add by looking at the chord that you are playing. In addition, the Ensemble parameters allow you to select the type of voicing that will be added – from a simple one-note harmony to a full “Brass” section – even a marimba-style trill!

Performance

The Performance is the most encompassing setting on the Pa900 – a single setting that can remember a Style (with all the appropriate sounds), the Keyboard tracks (with all the appropriate sounds) and all their Tempo, transposition, effects, etc... A Performance can be stored in one of the Performance bank locations, or it can be saved in a “database” format using the SongBook function.

Sequencer

The Sequencer acts as a recorder, so you can capture and playback your performances. The Pa900 sequencer can function in different modes. In the Backing Sequence mode, each Style element and each Keyboard and Pads element can be recorded on a separate track in a single pass. This can be a big help in getting a song recorded quickly. The sequencer can also behave as a traditional 16-track linear sequencer, where each track is recorded individually one at a time.

Player

The Player lets you playback your performances or any Standard MIDI File or MP3 file.

The LOGO decoder

On the front panel of your Pa900 you have probably noticed a series of logos, and may have even wondered what they stand for. Well, here is a quick explanation of each one.



General MIDI (GM) is a standard that ensures the compatibility of sounds and messages between GM compatible instruments available from different manufacturers. For example, sequenced songs created on any GM equipped product and saved in the GM format will playback correctly on the Pa900.

General MIDI 2 extends the basic features of the General MIDI, allowing for 256 Sounds and 9 Drum Kits (instead of 128 and 1).



RX Technology is the cutting edge engine that drives every aspect of the Pa900 – from the synthesis to the display and how it all works together.



DNC (Defined Nuance Control) is the way of fine-controlling Korg's powerful sound engine. Every nuance and every detail of the sound can be assigned to a different control, be it the keyboard velocity or a physical controller.



TouchView is the sophisticated technology allowing for touching the objects in the display, instead of pointing to them through an external device (a mouse, a series of buttons). Go straight to the musical elements, instead of catching keys somewhere on the control panel.



TC-Helicon is the world's leading company in vocal processing. Korg partnered with them for the outstanding Voice Processor technologies included in our Pa-Series instruments.

Interface basics

Color TouchView graphical user interface

Pa900 features our exclusive easy-to-use TouchView graphic interface, based on a touch-panel LCD screen. By touching items on the LCD screen, you can select pages, tabs, and parameters, and set parameter values via on-screen menus and buttons. Here are the basic elements of the user interface.

Menus and sections

Pages are grouped in sections, to be selected by touching the corresponding buttons in the Edit menu that opens up when you press the MENU button.

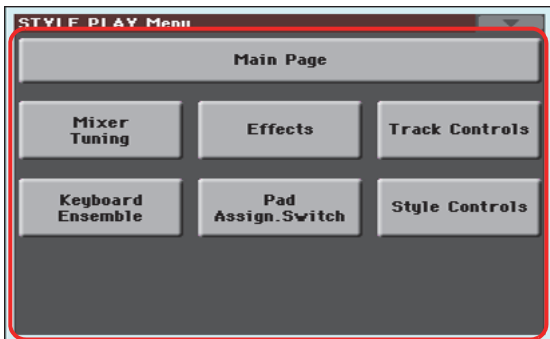

Pages

Parameters are grouped into separate pages, to be selected by touching the corresponding tabs on the lower area of the display.



Overlapping windows

Several windows, like the Style Select or Pad Select, the Global, the Media, or the Lyrics, overlap the current window. After you select an item in the window, or press the EXIT button, the window closes, and the underlying page is shown again. (The following example is the Sound Select window).

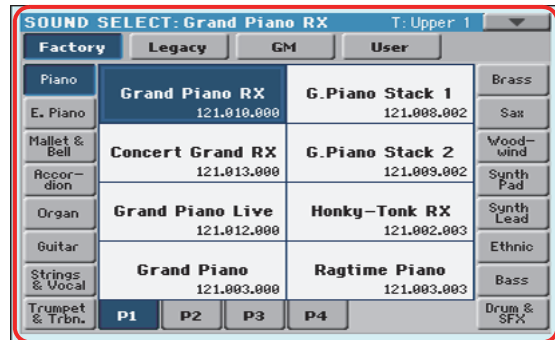

Dialog boxes

Similar to selecting windows, dialog boxes overlap the underlying page. Touch one of the buttons on the display to give Pa900 an answer, and the dialog box will close.

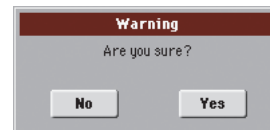

Page menus

Touch the icon on the upper right corner of each page, and a menu with suitable commands for the current page will appear. Touch one of the available commands to select it. (Or, touch anywhere else on the screen to make it disappear, with no command selected).

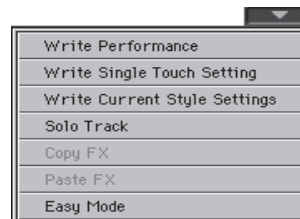

Pop-up menus

When an arrow appears next to a parameter name, touch it to open a pop-up menu. Select any of the available options (or anywhere else on the screen to make the menu disappear).

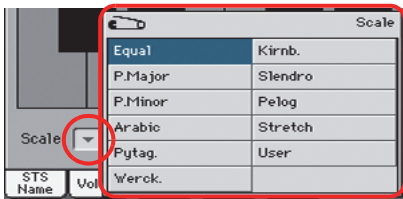

Checkboxes

This kind of parameters are on/off switches. Touch them to change their status.

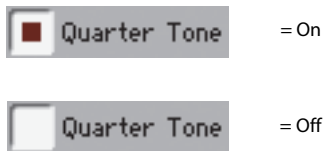

Numeric fields

When a numeric value can be edited, touch it a second time to open the Numeric Keypad.

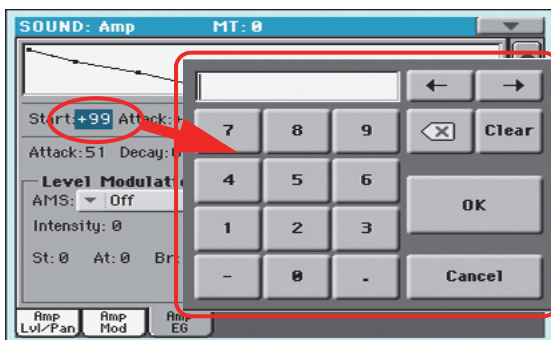

The virtual numeric keypad works exactly as the numeric keypad of a personal computer.

As an alternative, touch a numeric field and keep it held. Then move your fingers up (or right) to increase the value, or move it down (or left) to decrease it.



This also includes the Tempo numeric field in the main page of the Style Play, Song Play, and Sequencer modes.

Editable names

When the **T** (Text Edit) button appears next to a name, touch it to open the Text Edit window and edit the name.



The virtual keyboard works exactly as a personal computer's keyboard. Some of the symbols are context-sensitive, and only appear when they can actually be used.

Lists and scrollbars

Files on storage media, as well as other kinds of data, are shown as lists. Use the scrollbar to scroll the list content. Also, you can use the VALUE DIAL to scroll.



List

Scrollbar

When the Name label is selected, keep the SHIFT button pressed while touching one of the arrows on the scrollbar, to scroll to the next or previous alphabetic section.

Virtual sliders

To change a virtual slider's position, select it, then use the VALUE dial to change its position. As an alternative, touch a slider with your fingers and keep it held; then move it up or down to change its position.

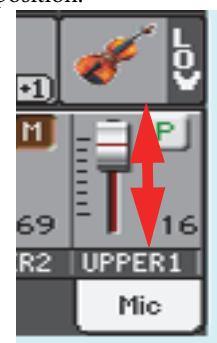

Virtual knobs

To change a virtual knob's position, select it, then use the VALUE dial to change its position. As an alternative, touch a knob with your finger and keep it held; then move your fingers up (or right) to rotate it clockwise, or move it down (or left) to rotate the knob counter-clockwise.

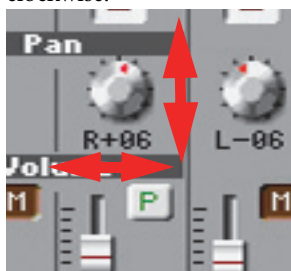

Virtual drawbars

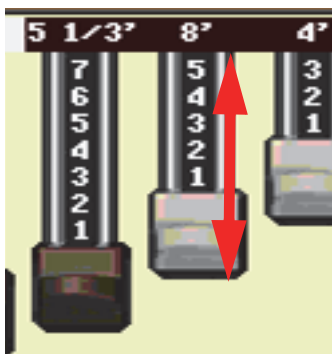

To change a virtual drawbar's position, touch it with your fingers and keep it held. Then move it up or down to change its position.

As an alternative, select it, then use the VALUE DIAL to change its position.



Icons

Various icons help identifying the type of a file, a Song, a folder. For example:

-  Folder
-  File of Style bank
-  Standard MIDI File

Operative modes

The pages of Pa900 are grouped in various operating modes. Each mode is accessed by pressing the corresponding button in the MODE section on the control panel.

Each operating mode is marked with a different *color code*, that helps you understand at first sight where you are.

Two special modes (Global and Media) overlap the current operating mode, that remains active in the background.

The Record mode can be accessed from the Style Play and Sequencer modes, and allows for creating new Styles or Songs. It can also be accessed from the Sound mode, where allows you to edit Samples.

Selected, highlighted items

Any operation on parameters, data or list entries, is executed on highlighted items. First select the parameter or item, then execute the operation.



Non-available, grayed-out parameters

When a parameter or command is not currently available, it is shown in grey on the display. This means it cannot be selected, but may become available when a different option is selected, or you switch to a different page.



Shortcuts

Some commands or pages can be recalled by keeping the SHIFT button pressed, and pressing other buttons or elements in the display.

Easy Mode

If you have never used an arranger before, we suggest you to switch to the Easy Mode. Easy Mode allows you to play Styles and Songs with a simple user interface, free from the many advanced parameters that you will want to learn at a later date.

Turning the Easy Mode on

Touch the little rectangle on the top right corner of the display, to open the *page menu*:

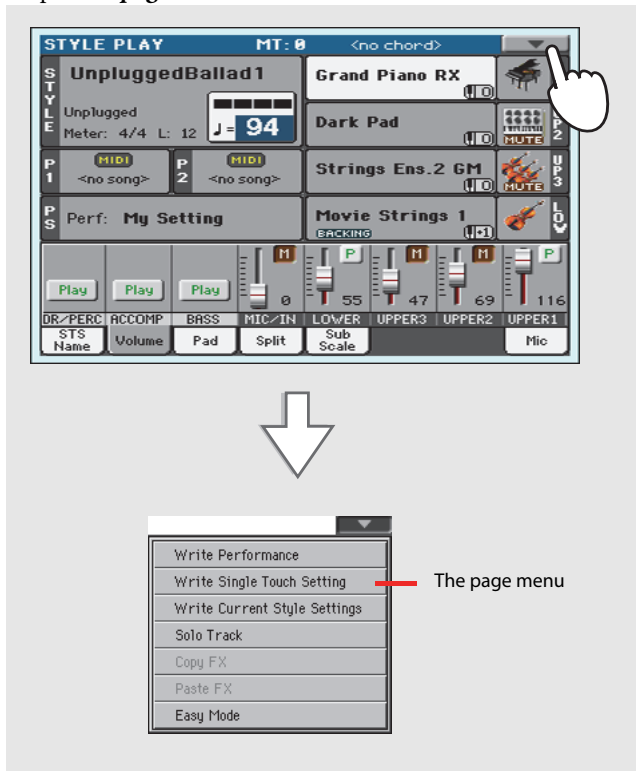

Touch the "Easy Mode" menu item, to make the checkmark appear:

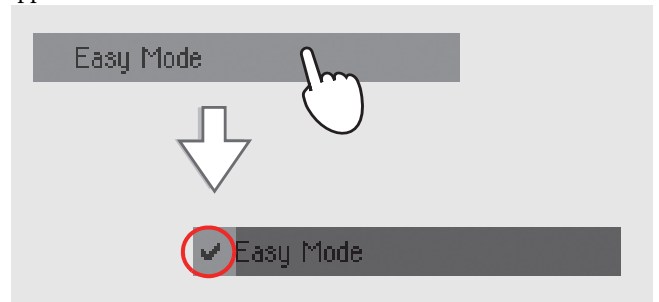

At this point, the Easy Mode has been activated, and the elements in the display appear less crowded:



Turning the Easy Mode off

Reverse the above operation when you want to deactivate the Easy Mode.

The Style Play page in detail

To see this page, press the STYLE PLAY button.

The screenshot shows the 'STYLE PLAY' interface with the following elements and annotations:

- Style name and info:** 'UnpluggedBallad1', Bank: Unplugged, Meter: 4/4. Annotation: 'Style name and info. Touch the Style's name to open the Style Select window and choose a different Style.'
- Tempo:** 'L: 12', 'J = 94'. Annotation: 'Tempo. Use the TEMPO buttons to change it.'
- Accompaniment pattern:** 'L: 12' and a progress bar. Annotation: 'Length of the accompaniment pattern, and current beat.'
- Performance:** 'Perf: My Setting'. Annotation: 'Performance or STS. Touch it to open the Performance Select window and choose a different Performance. Sounds on the keyboard will change.'
- Voice Processor Preset:** 'TC-Helicon'. Annotation: 'Voice Processor Preset. Touch here to choose a different Preset.'
- Single Touch Settings (STS):** 'STS 1' (Nylon Guitar), 'STS 2' (Distortion Gtr), 'STS 3' (Trumpet & Muted), 'STS 4' (Electric Piano). Annotation: 'Single Touch Settings (STS). Touch one of them to choose it, or use the dedicated buttons on the control panel. Sounds on the keyboard will change.'
- Sounds assigned to the right hand (UP1 to UP3) and to the left hand (LOW):** 'Grand Piano RX', 'Dark Pad', 'Strings Ens.2 GM', 'Movie Strings 1'. Annotation: 'Sounds assigned to the right hand (UP1 to UP3) and to the left hand (LOW). Touch the Sound's name to open the Sound Select window and choose a different Sound.'
- Sound icon and status:** 'MUTE' icons are shown next to 'Dark Pad' and 'Strings Ens.2 GM'. Annotation: 'Sound icon and status. If the MUTE icon appears, the Sound is in mute and cannot be heard. If the icon does not appear, the Sound is in play and can be heard. See page 37'
- Split Point:** 'Split point C4'. Annotation: 'Split Point. Touch here and play a note to set the new split point. See page 41'
- Mic Talk:** 'Mic Talk' button. Annotation: 'Mic Talk. Touch here to lower the background music and talk to your audience.'

- Notes:**
- There are three Sounds for the right hand (Upper 1, Upper 2, Upper 3), and a single Sound for the left hand (Lower). Their names are abbreviated as UP1, UP2, UP3, LOW, and are shown on the right side of the display.
 - Right hand (Upper) and left hand (Lower) Sounds are separated by the Split Point.
 - Performances and STSs are collections of Sounds. Just choose one of them to change all the keyboard's Sounds.
 - Choose a Style to change the musical style of the accompaniment patterns.

The Song Play page in detail

To see this page, press the SONG PLAY button.

The screenshot shows the SONG PLAY interface with the following elements and annotations:

- Tempo:** A control for changing the tempo, with a current value of 248.
- Meter (or Time Signature) and current beat:** A control showing the current meter (1/4) and beat.
- Song assigned to Player 1:** "LoveSong" with a MIDI icon and a tempo of 248.
- Song assigned to Player 2:** "<no song>" with a MIDI icon and a tempo of 120.
- Performance or STS:** "Perf: My Setting" and "Voice Processor Preset".
- Voice Processor Preset:** "TC-Helicon" with four STS options: STS 1 (Nylon Guitar), STS 2 (Distortion Gtr), STS 3 (Trumpet & Muted), and STS 4 (Electric Piano).
- Sounds assigned to the right hand (UP1 to UP3) and the left hand (LOW):** "Grand Piano RX", "Dark Pad", "Strings Ens.2 GM", and "Movie Strings 1".
- Sound icon and status:** A "MUTE" icon is shown next to "Dark Pad" and "Strings Ens.2 GM".
- Split Point:** A control labeled "Split point C4".
- Mic Talk:** A control labeled "Mic Talk".

Annotations provide detailed instructions for each of these elements, such as "Touch it to open the Song Select window" for the song names and "Touch here to lower the background music and talk to your audience" for the Mic Talk button.

Notes:

- As in Style Play mode, there are three Sounds for the right hand (Upper 1, Upper 2, Upper 3), and one Sound for the left hand (Lower). Their names are abbreviated as UP1, UP2, UP3, LOW, and are shown in the right side of the display.
- Right hand (Upper) and left hand (Lower) Sounds are separated by the Split Point.
- Performances and STSs are collections of Sounds. Just choose one of them to change all the keyboard's Sounds.
- Available STSs depend on the Style or SongBook Entry you last selected.
- Since there are two onboard Players, you can play two Songs at the same time. Mix them using the X-Fader on the control panel.
- Touching a Song name in the display is the same as to press one of the SELECT buttons on the control panel. Each Player has its own SELECT and transport buttons.

Quick Guide

Turning the instrument on

First of all, turn the instrument on and familiarize with the main screen. You can also listen to the demos.

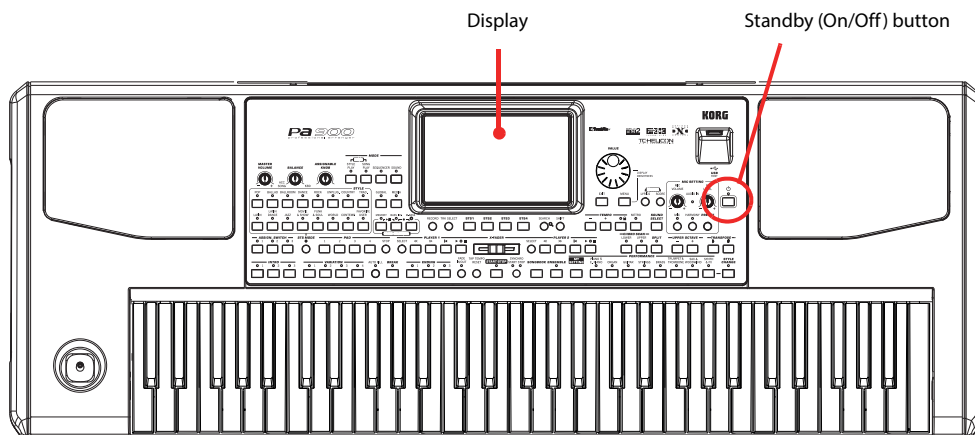

Turning the instrument on and viewing the main screen

- 1 Turn Pa900 on (exit from standby) by pressing the **STANDBY** button located in the control panel.

After you turn the instrument on, a welcome screen is shown for some seconds, then the main display appears.

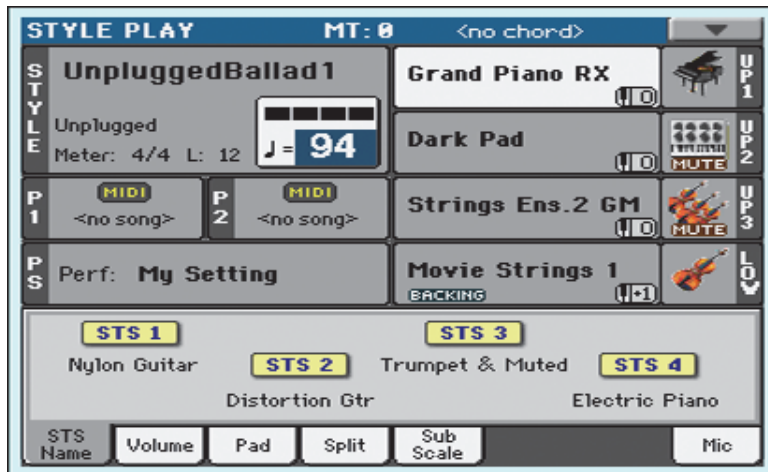

- 2 When you want to put Pa900 to standby, keep the **STANDBY** button pressed for about one second, and release it when the screen appears dimmed.

After having pressed the **STANDBY** button, the display brightness will be dimmed. At this point, the shutdown procedure will begin and last for a few seconds. Please do not disconnect the power cable during this procedure.

Connecting and calibrating the Damper pedal

If you want to play Piano, you will want to connect a Damper pedal to sustain notes while playing. You can connect a Korg PS1, PS3 or DS1H to the DAMPER connector on the back of the instrument.

The difference between the PS1/PS3 footswitch, and a dedicated Damper pedal like the DS1H, is that this latter also supports all the nuances of half-peddalling; you can experiment how it works by gradually pressing it down, and gradually depressing it up while playing the Grand Piano RX Sound.

Damper and Assignable pedal connectors

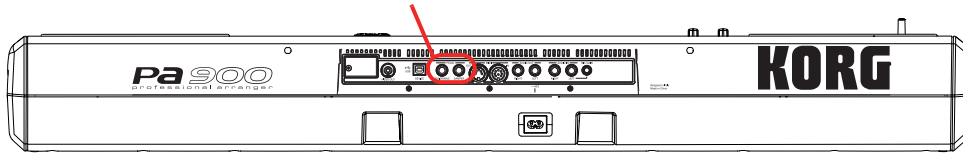

Programming the Damper pedal

Calibrating the Damper pedal will let you use the full run of the pedal, without “dead spots”. Also, this might be the only way to connect a third-party Damper pedal that seems to work in reverse, sustaining the notes when they are not pressed!

- 1 Connect the Damper pedal to the DAMPER connector on the back of the instrument.**
- 2 Press the GLOBAL button to access the Global mode.**

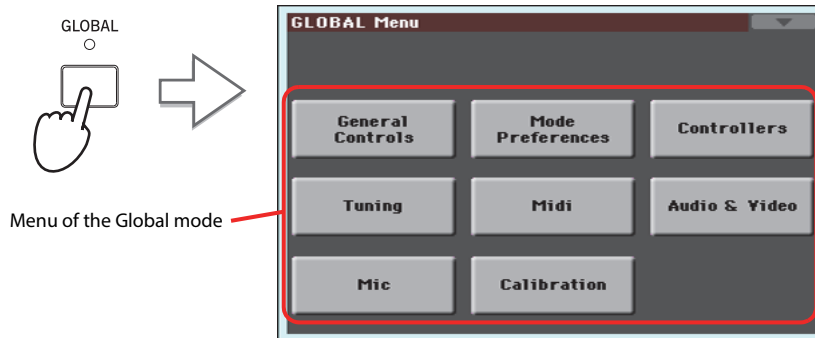

Global mode is where you can set some global parameters, like this one, the Master Tuning or the Date & Time. These settings are not tied to any specific operative mode, so they are programmed in these separate pages.

- 3 Touch the Controllers button to access the Controllers section of the Global mode.**

If you have not yet chosen a different page, the “Hand Controller” page will appear (being the first one in the Controllers section).

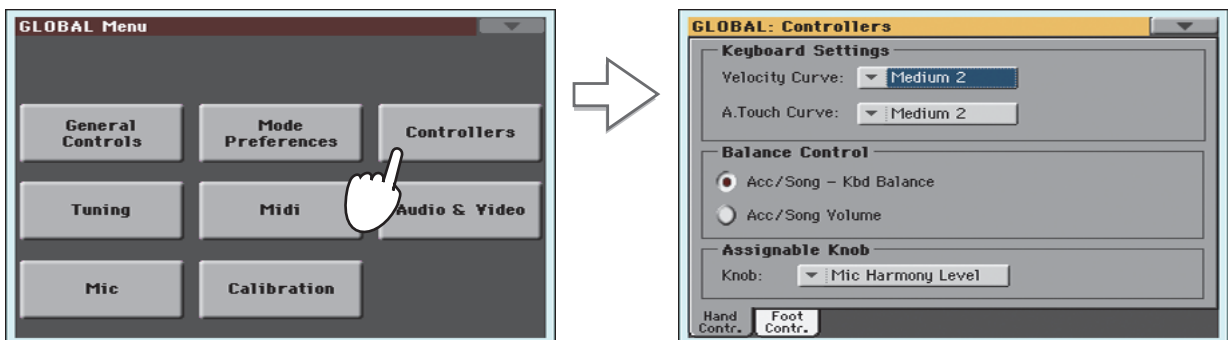

4 Touch the Foot Contr. tab to select the “Foot Controllers” page.

This is the page where you can program the Assignable Pedal/Footswitch and the Damper pedals.

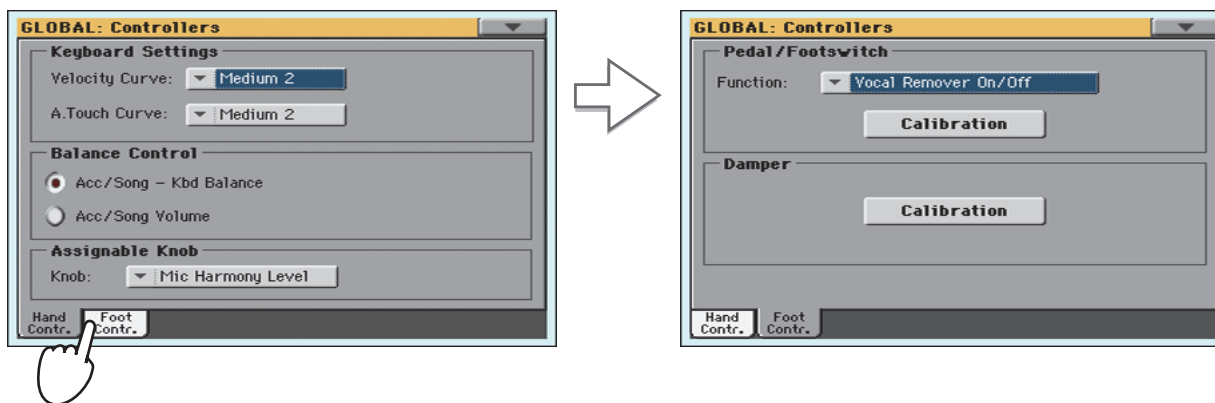

5 Touch the “Calibration” button in the Damper section, to make the “Damper & Pedal/Footswitch Calibration” dialog box appear.

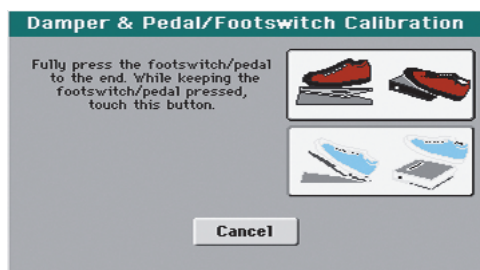

6 Fully press the Damper pedal down, and while continuing to press touch the “Push” button to confirm the maximum value.

7 When the following dialog box appears, release the pedal.

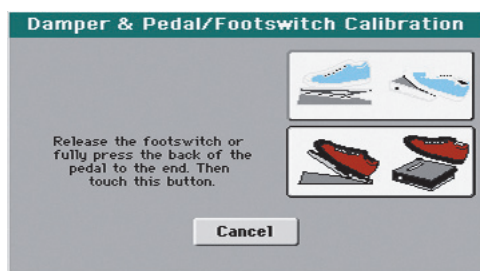

8 Touch the “Push” button in the display to confirm the minimum value.

Check if the pedal is working properly. In case it isn't, repeat the procedure.

9 Press the EXIT button to return to the previous operative mode.

Playing the Demo

Listen to the built-in Demo Songs to appreciate the power of Pa900. There are several Demo Songs to choose from.

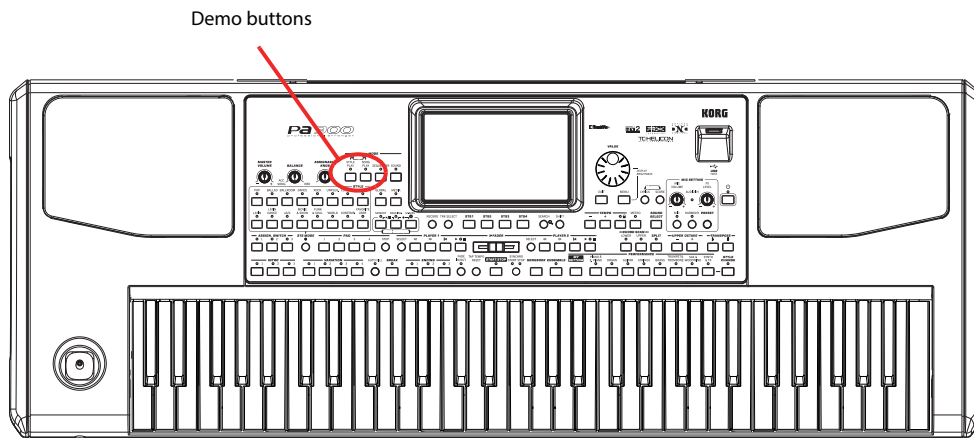

Starting and stopping the Demo

Here is how to start, choose and stop the Demo Songs.

- 1 Press the STYLE PLAY and SONG PLAY buttons together.**

The LED of the two buttons will start blinking. Pa900 will be set in Demo mode.



At this point, if no other button is pressed, all the Demo Songs will be played back.

- 2 In case you want to listen to a specified Demo Song, select one of the available options on the display (Full Songs, Solo Instruments, Styles).**

- 3** Choose one of the Demo. To stop it, touch the **STOP** button on the display.

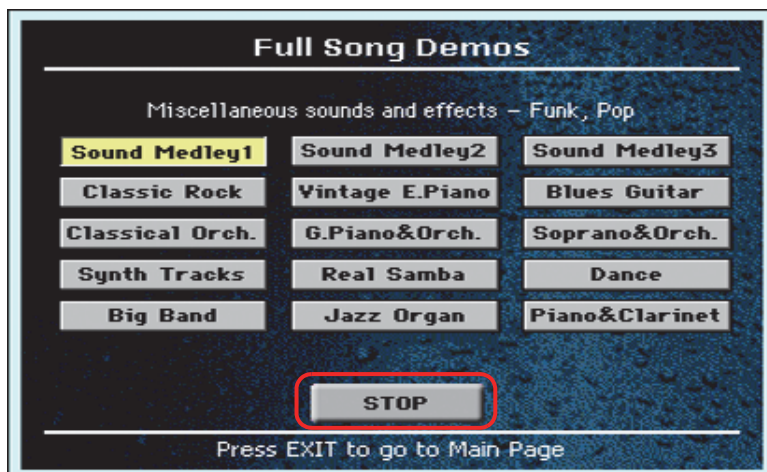

- 4** Exit from the Demo mode by pressing any one of the **MODE** buttons.

Playing Sounds

You can play up to three sounds at the same time on the keyboard. You can also split the keyboard in two parts, to play up to three sounds with your right hand (Upper) and one with your left hand (Lower).

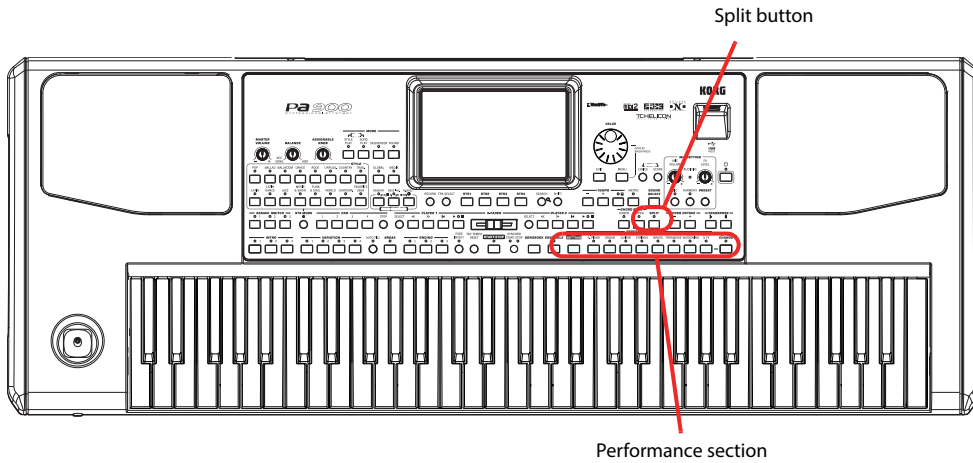

Selecting a Sound and playing it on the keyboard

1 Be sure the Upper 1 track is selected and set to play.



A selected track is shown with a white background. In this example, the Upper 1 track is selected. **If it is not selected, touch it once to select it.**

The fact that there isn't a **MUTE** icon over the bank icon means that the Upper 1 track is set to play. **If it is muted, touch the bank icon to set it to play.**

i Note: Be sure tracks Upper 2 and Upper 3 are muted and are not playing. If you hear more than one sound, see also page 37 for how to mute tracks.

2 If you want to play the Sound on the whole keyboard, be sure the keyboard is in Full Upper mode (i.e., the SPLIT LED is turned off). If it is split in two parts, press the SPLIT button to turn its LED off.

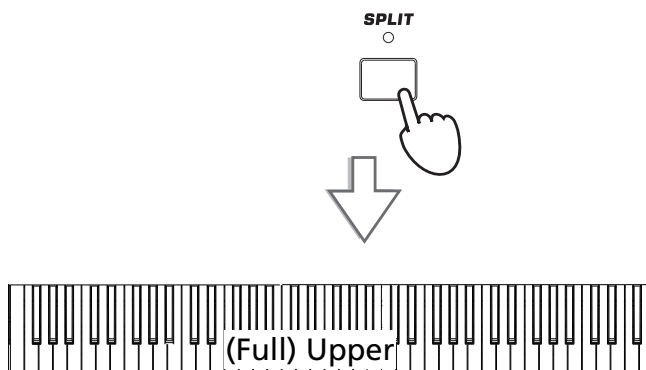

3 Touch the Upper 1 track's area in the display to open the Sound Select window.

The currently selected Sound appears in the page header.

Target track for the selected Sound

Sound's name

Sound bank icon

Type of Sounds.

The selected Sound is highlighted. Touch a Sound's name to select it.

Touch one of the side tabs to select a different Sound bank.

Touch one of the lower tabs to select a different Sound page.

A Previous and Next Page pair of button may appear in this area, when more than six pages are available. As an alternative, repeatedly press the SOUND button to cycle between the pages.

i Note: You can also open the Sound Select window by first touching the track to which to assign the new Sound, then pressing the SOUND SELECT

4 Select a Sound from the Sound Select window, then press the EXIT button to close the window.

EXIT

The Sound Select window closes, and the main screen appears again, with the selected Sound assigned to the Upper 1 track.

5 Play the Sound on the keyboard.

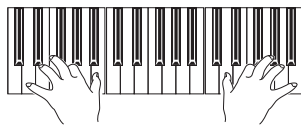

i Note: Selection windows may automatically close after a selection. To do this, uncheck the "Display Hold" box in the Global > General Controls > Interface page. In this case, press the EXIT button only if you don't make any selection but want to close the window.

Playing two or three Sounds at the same time

You can layer all three Upper tracks and play them on the keyboard.



Please note how the **MUTE** icon appears in the Upper 2 and Upper 3 status boxes. These tracks will not be heard.

- 1 Touch the **MUTE** icon in the Upper 2 status box, to set the Upper 2 track to play.

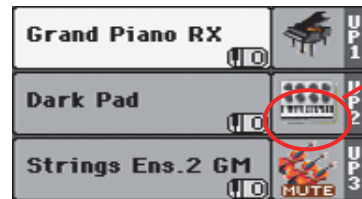

After touching in this area, the **MUTE** icon disappears. The Upper 2 track will be set to play and will be heard.

- 2 Play the keyboard.

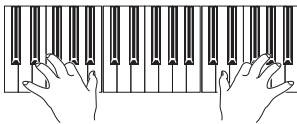

Note how the 'Dark Pad' Sound (assigned to the Upper 2 track) has been layered with the 'Grand Piano RX' (assigned to the Upper 1 track).

- 3 Touch the **MUTE** icon in the Upper 3 status box, to set the Upper 3 track to play.

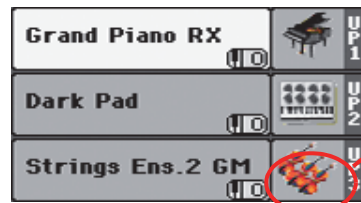
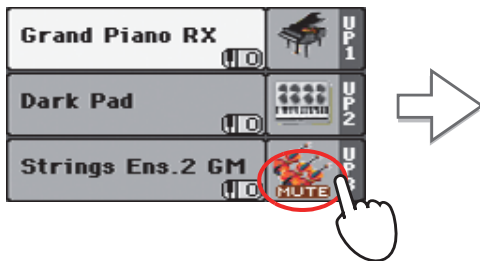

As above, after touching in this area, the **MUTE** icon disappears. The Upper 3 track will be set to play and will be heard.

- 4 Play the keyboard.

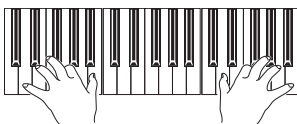

Note how the 'Strings Ens.2 GM' Sound (assigned to the Upper 3 track) has been added to the 'Dark Pad' (assigned to the Upper 2 track) and the 'Grand Piano RX' (assigned to the Upper 1 track).

- 5 Touch the bank icon in the Upper 3 status box, to mute the Upper 3 track again.

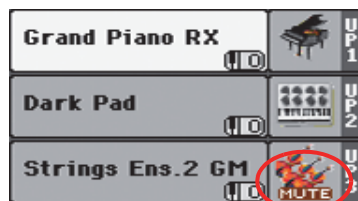
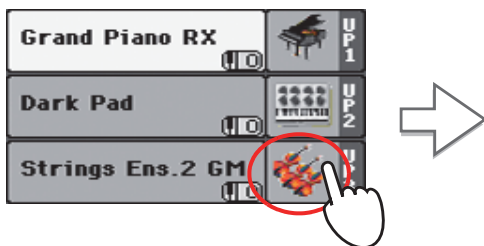

6 Play the keyboard.

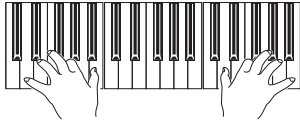

Note how the 'Strings Ens.2 GM' Sound (assigned to the Upper 3 track) has been muted again. Only tracks Upper 1 and Upper 2 can be heard at this time.

7 Touch the bank icon in the Upper 2 status box, to mute the Upper 2 track again.

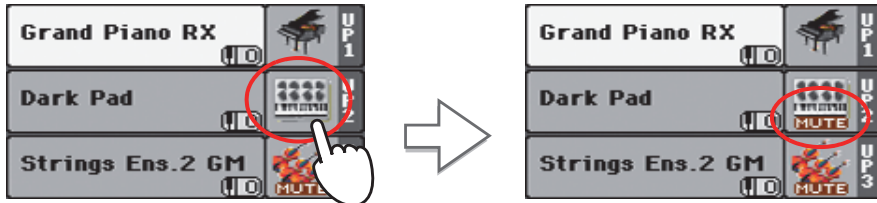

8 Play the keyboard.

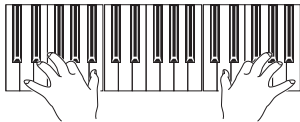

Note how the 'Dark Pad' Sound (assigned to the Upper 2 track) has been muted again. Only track Upper 1 can be heard at this time.

Playing different Sounds with your left and right hand

You can play a single Sound with your left hand, in addition to playing up to three Sounds with your right hand.

- 1 Press the **SPLIT** button to turn its LED on, and split the keyboard in the **Lower** (left hand) and **Upper** (right hand) parts.

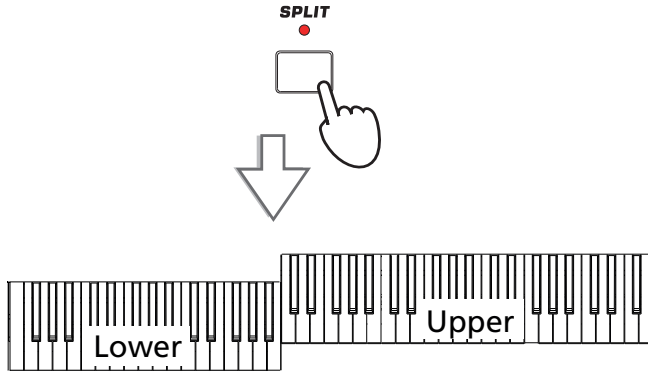

- 2 Be sure the **Lower** track is set to play.



If the Bass & Lower Backing function is turned on, and the Style is not running, the Lower track will always play.

- 3 Play the keyboard.

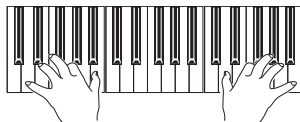

Note how the keyboard is split in two parts, each playing different sounds.

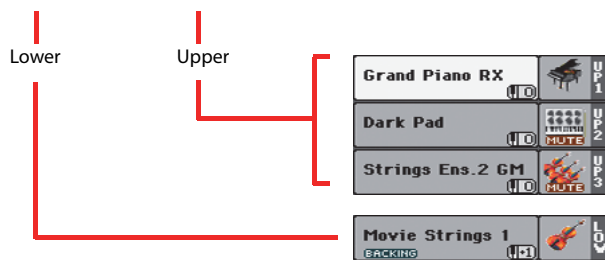

- 4** Return to the full keyboard playing mode by pressing the SPLIT button to turn its LED off.



- 5** Play the keyboard.



Note how the keyboard once again plays the Upper tracks over the entire length of the keyboard.

Upper



Changing the split point

If you are not comfortable with the selected split point, you may set the split point to a different key.

1 Touch the Split tab to see the Split Point panel.

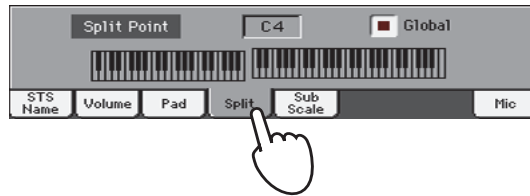

2 Touch the keyboard in the display, then play the lowest note of the Upper section on the keyboard.

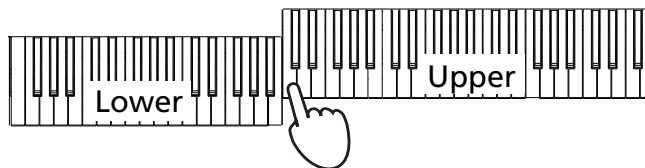
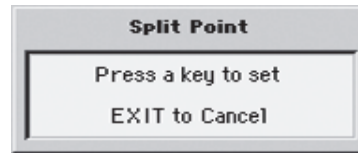
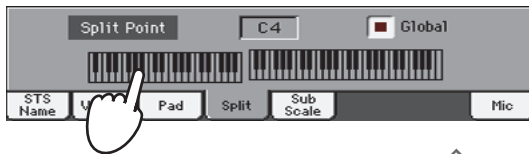

i Hint: As an alternative, keep the SPLIT button pressed to open the Split Point dialog.

3 As an alternative, touch the Split Point parameter to select it, and use the VALUE dial to select the new split point.

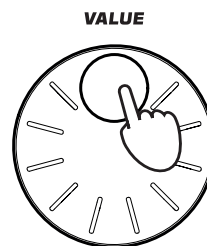
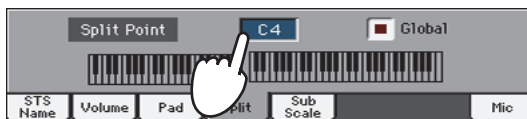

When you change the split point, the “Global” parameter is automatically unchecked. This is because you are setting a “local” or “temporary” split point, and not the “global” one, used across the whole instrument.

To change the “global” split point, go to the Global > Mode Preferences > Style page, and set the “Split Point” parameter.

You can save the “local” split point into a Performance, as described in the following pages (see “Saving your settings to a Performance” on page 44).

Raising or lowering the Upper octave

If all Upper tracks sound too high or too low, you can quickly change which octave they are playing in.

- 1 Use the **UPPER OCTAVE** buttons on the control panel, to transpose all Upper tracks at the same time.

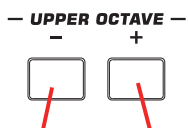

Each time you press this button, the pitch will be lowered by one octave.

Each time you press this button, the pitch will be raised by one octave.

i Note: The Octave Transpose value for each of the keyboard track is shown under the Sound's name.



- 2 Press both **UPPER OCTAVE** buttons together to reset the octave to the value saved in the current Performance.

Selecting and saving Performances

Performances are the musical heart of Pa900. Unlike selecting single Sounds, selecting a Performance will recall several Sounds at the same time, the needed effects and transpositions, plus many more parameters useful for playing in a musical situation (like the Assignable Switches). Performance can be considered a snapshot of the current situation.

You can save these settings to a Performance memory location. While many Performances are already supplied with the instrument, you can customize each of them to your own taste, and then save them in their customized version.

Similar to Performances, but dedicated to the Styles and SongBook Entries, you can also save your settings to a **Single Touch Setting (STS)**, which will store all the settings for the Keyboard tracks. Four STSs are supplied with each Style and SongBook Entry, and can be selected with the four dedicated buttons under the display.

Please note that **settings saved in the "My Setting" Performance are automatically selected when the instrument is turned on (exit from standby).** This means you can save your preferred startup settings to this Performance (see below for more information).

*Note: Style tracks are saved to a third object called the **Style Settings**.*

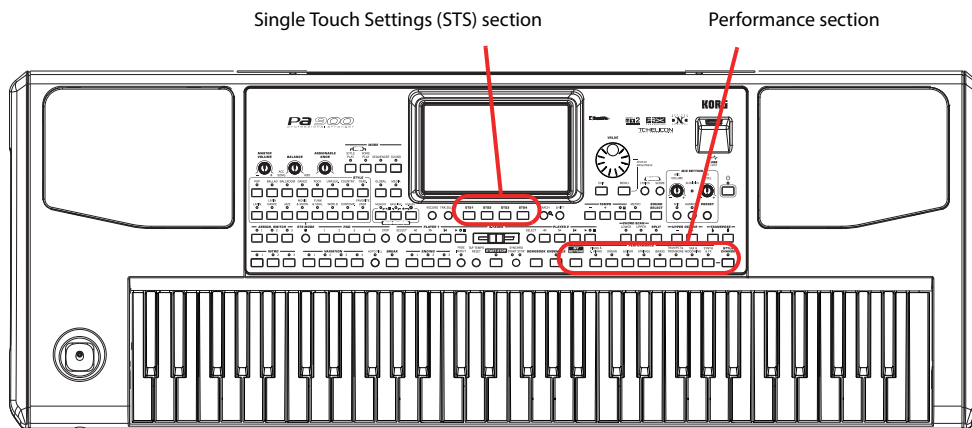

Selecting a Performance

- 1 Touch the Performance area in the display, to open the Performance Select window.

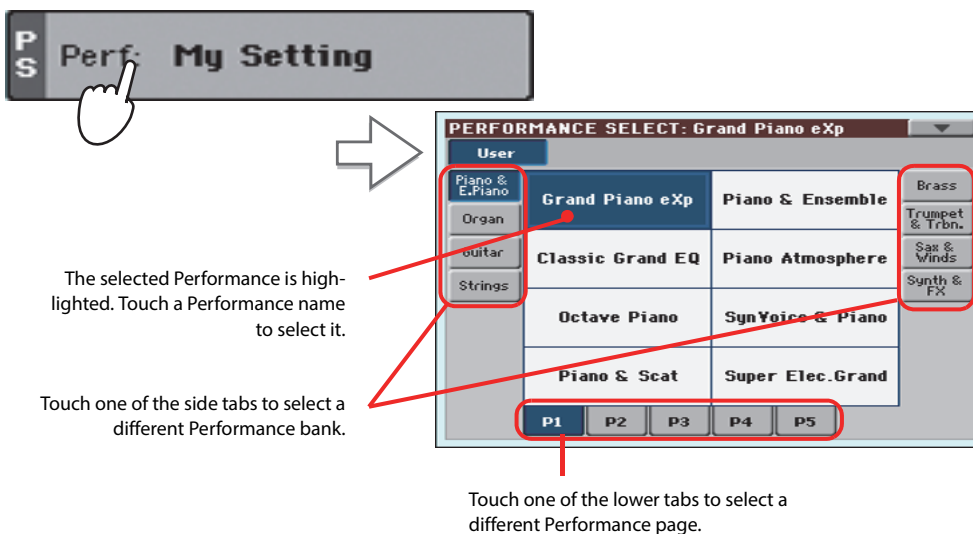

i Hint: You can also open the Performance Select window by pressing one of the buttons in the PERFORMANCE section. This will let you jump directly to the desired Performance bank.

2 Select one of the Performances in the Performance Select window, then press the EXIT button to close the window.

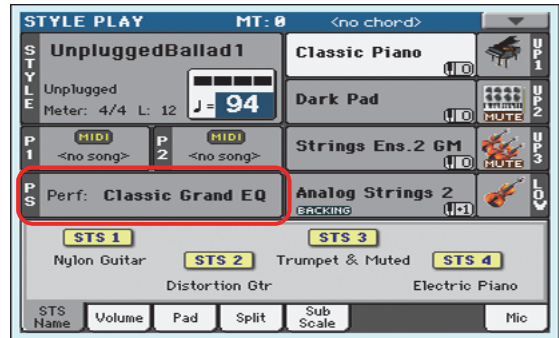
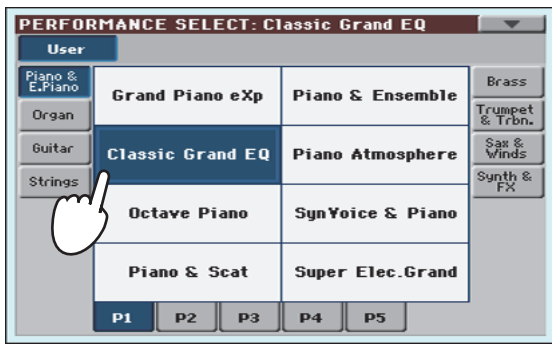

After pressing the EXIT button, the Performance Select window closes, and the main screen appears again. Sounds, Effects, and other settings, change according to the setting memorized in the selected Performance.

Note: Selection windows may automatically close after a selection. To do this, uncheck the “Display Hold” box in the Global > General Controls > Interface page. In this case, press the EXIT button only if you don’t make any selection but want to close the window.

3 Play the keyboard.

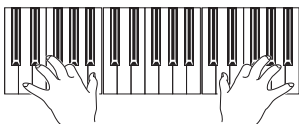

Settings memorized in the selected Performance have been selected. Sounds, effects and other settings have been recalled.

Note: If the **STYLE CHANGE** button is turned on, selecting a Performance may automatically select a different Style and its settings (Sounds, Effects for the Style tracks...)

Saving your settings to a Performance

The Sounds and Effects assigned to the Keyboard tracks, together with the parameters you can access by pressing the MENU button while in Style Play and Song Play mode, can be saved into a single Performance, to be quickly recalled at a later time.

1 Keep one of the PERFORMANCE buttons pressed for about one second to open the Write Performance dialog box.

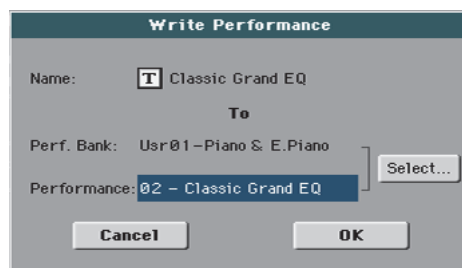
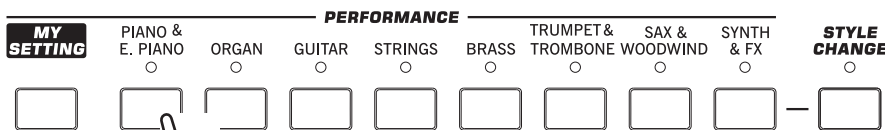

Hint: To open the Write Performance dialog box, you can also choose the ‘Write Performance’ command from the page menu.

2 If you like, you may assign a new name to the Performance.

Use the '<->' and 'DIAL' to move the cursor.

Touch the 'Backspace' symbol to delete just a single character, 'Clear' to delete the whole string.

Use the alphabetic characters to enter text.

Touch the **T** (Text Edit) symbol to open the Text Edit dialog box.

Touch the Shift key to switch between capitals and small characters.

When done, touch OK to confirm the new name, or Cancel to abandon all changes.

3 Select a bank and Performance location in memory, where you would like to save the Performance.

The selected Performance location is highlighted. Touch a Performance's name to select it.

Touch one of the side tabs to select a different Performance bank.

Touch one of the lower tabs to select a different Performance page.

4 When you have edited the name to the Performance, and selected the target location, touch OK to save the Performance to memory (or Cancel to stop the operation).

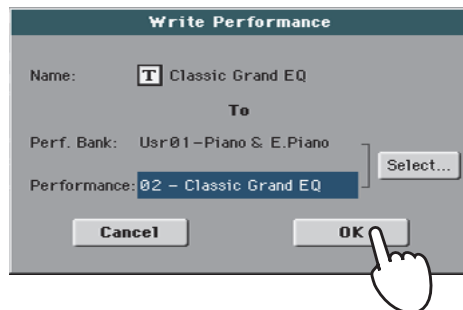

Warning: Saving a Performance to an already used location overwrites any existing data at that location. The old data are lost. Make a backup of all your important data.

Selecting and saving the "My Setting" Performance

There is a special Performance, where you can save your preferred startup settings for things like Keyboard Sounds, Effects, Transposition, Assignable Switches. This Performance is **automatically selected when the instrument is turned on (exit from standby)**. It is called the "My Setting" Performance.

'My Setting' Performance

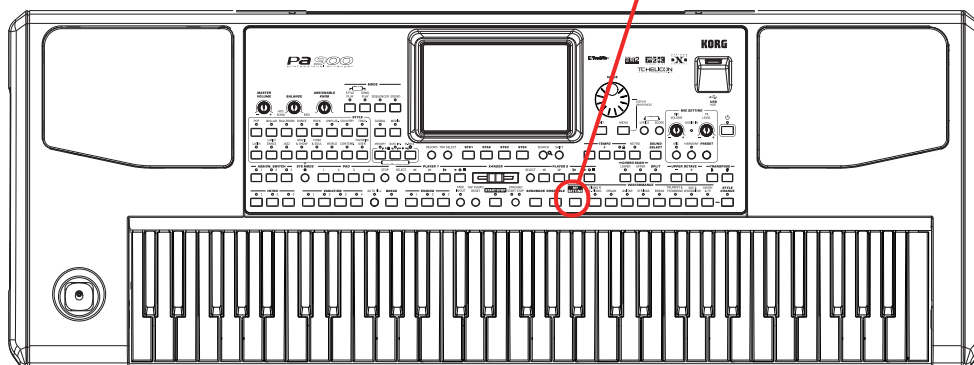

Selecting the startup parameters (the "My Setting" Performance)

After having done some changes to the Sounds, transposition, or other parameters, you can return to the startup situation by pressing the MY SETTING button in the control panel.

- Press the MY SETTING button to recall the "startup" settings.



Saving the startup parameters into the "My Setting" Performance

You can save the startup settings (Sounds and other settings, including most of the settings on the control panel) into this special Performance.

- Keep the MY SETTING button pressed for about one second, until the "Write Startup Settings" dialog box appears, then touch the OK button to confirm saving to memory.

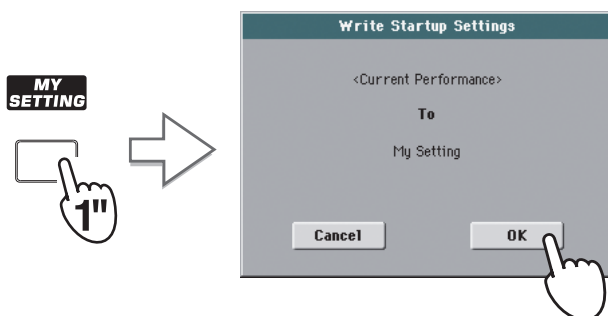

Drawbars

A special type of Sounds in the Pa900 is the Drawbars. This Sound emulates the classic tonewheel organs of the past. You can drag the virtual drawbars on the display to adjust their position, and then save these settings to a Performance, that can be considered the equivalent of an organ's "preset".

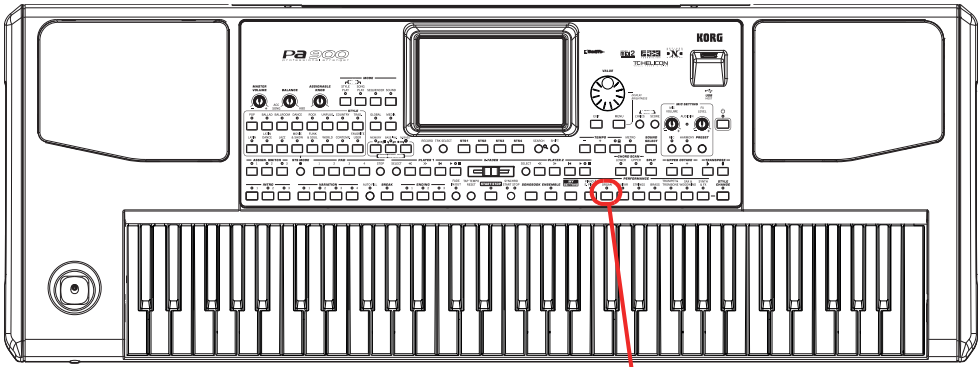

Organ Performance bank

Choosing a Drawbars Preset

Here is how to select and use the Drawbars.

- 1 Press the ORGAN button in the PERFORMANCE section to open the Performance Select window, and choose the "DWB Organ Y+" Performance.**

While you could assign the DRAWBARS Sound to an Upper track, choosing a Performance will also give you all the preset settings for the drawbars.

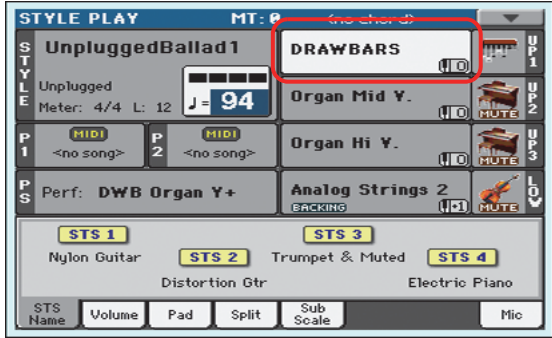
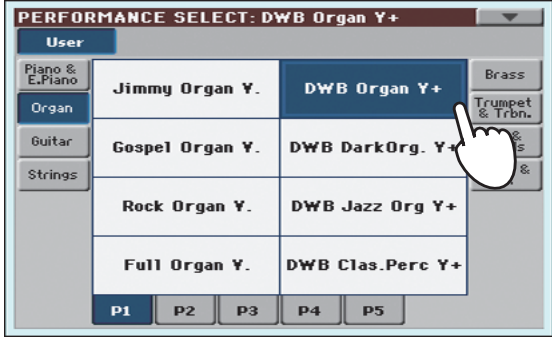
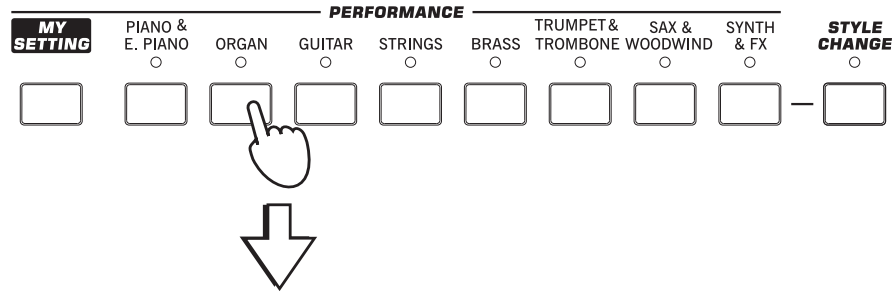

- 2 Play the keyboard to hear a realistic electro-magnetic organ sound.**
Different drawbar settings may be stored with each Performance. So, selecting a different Performance will select different settings for the Drawbars Organ.

Editing the Drawbars Preset

You can edit the Drawbars settings memorized in the selected Performance, and save it to the same or a new Performance.

- 1 While in the main screen, touch the **DRAWBARS** Sound to open the **Sound Select** window, then touch the selected **DRAWBARS** Sound to open the **Drawbars Setting** page.

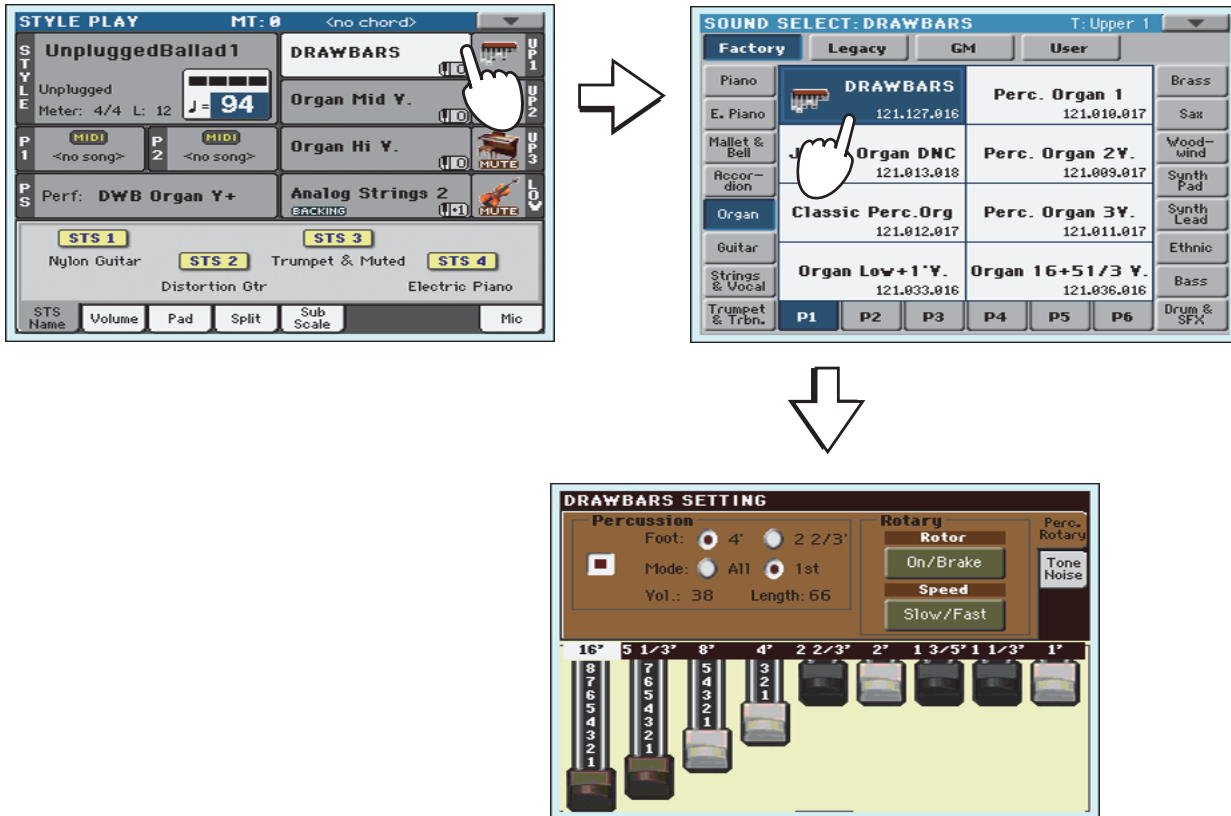

- 2 Drag the virtual sliders to change the various drawbar settings. Select different parameters in this page, and change their settings to see how each setting affects the sound.

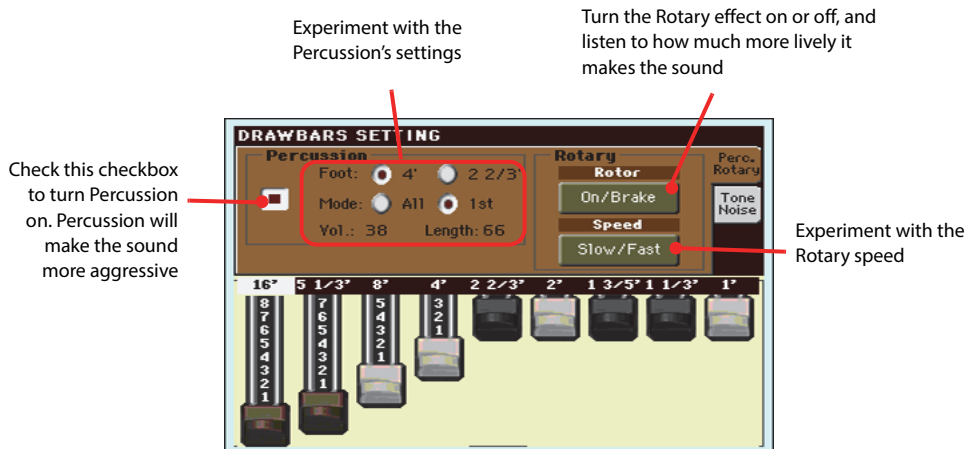

i Hint: As an alternative to dragging the virtual sliders to change drawbar values, you can touch a drawbar in the display and use the **VALUE DIAL** to change it.

3 Touch the “Tone/Noise” tab, and try the sound parameters of the second page.

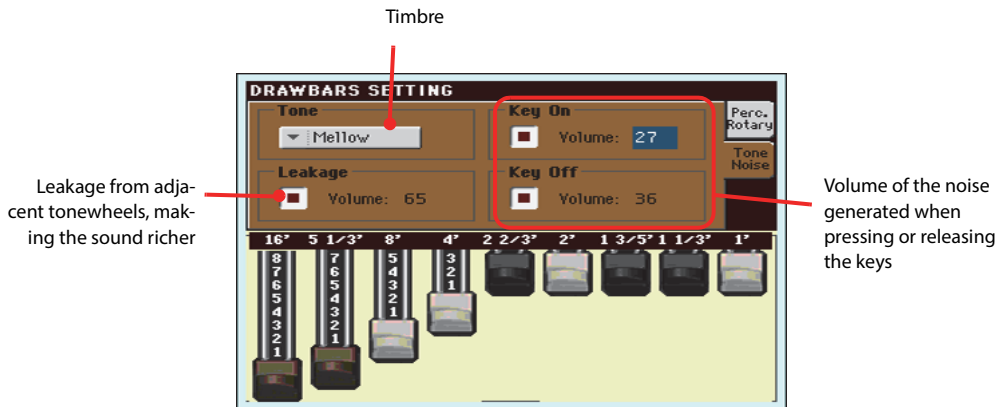

4 When you have found some settings that you like, keep one of the ORGAN Performance buttons pressed to open the Write Performance window, and save your settings to a Performance.

5 Press the EXIT button to go back to the main page.

Selecting and playing Styles

Pa900 is an *arranger*, i.e. a musical instrument providing automatic accompaniments, or *arrangements*. Each arrangement style is called, as a consequence, a *Style*.

A Style is made of several Style Elements (Intro, Variation, Fill, Break, Ending), corresponding to the various sections of a song. By selecting Style Elements, you can make your playing more varied and musical.

When selecting a Style, Sounds, Effects and various configuration parameters for the Style tracks are also selected. These are called the Style Settings. Selecting a Style also selects the four Pads it contains. Pads are single sounds or single-track patterns, that can be triggered with the dedicated PAD buttons.

If the STS MODE LED is turned on, the first of the four Single Touch Settings (STS) associated to the Style is also selected, and Keyboard tracks, Effects and some other useful parameters are automatically configured.

Use the Style controls to start or stop the Style.

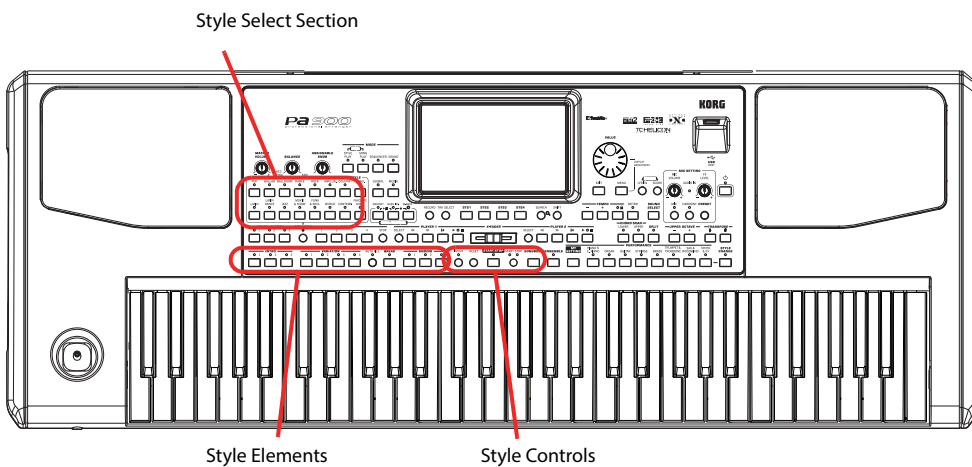

Selecting and playing a Style

1 Touch the Style area in the display. The Style Select window appears.

The selected Style is highlighted. Touch a Style's name to select it.

Touch one of the side tabs to select a different Style bank.

Touch one of the lower tabs to select a different Style page.

i Hint: You can also open the Style Select window by pressing one of the buttons of the STYLE section. This will let you jump directly to the desired Style bank.

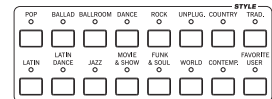

2 Select a Style from the Style Select window.

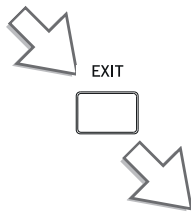

After pressing the EXIT button, the Style Select window closes, and the main screen appears again, with the selected Style ready to go.



3 Be sure one of the Chord Scan modes is selected.

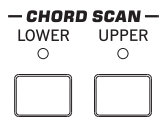

For chord scanning to work, either of both LEDs must be turned on. **Lower:** chords are recognized on the left of the split point; **Upper:** chords are recognized on the right of the split point; **Full (both LEDs on):** chords are recognized on the whole keyboard. **Off:** only the Drum track can be heard.

4 Press the SYNCHRO-START/STOP button to turn the START LED on.

This will turn the Syncho-Start function on, and let the accompaniment start as soon as you play a chord on the keyboard.

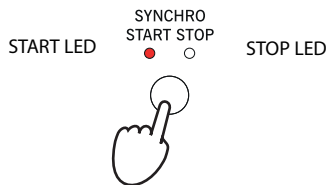

Note: You could simply press START/STOP to start the Style, but the Syncho-Start function allows you to make the Style start in sync with your playing on the keyboard. Therefore, it may be considered a "more musical" way of starting a Style.

5 Play the keyboard.

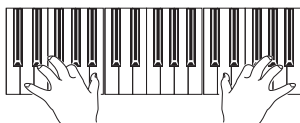

When the Syncho-Start function is turned on, the Style starts playing as soon as you play a note or chord in the chord scan area. Play chords with your left hand, and the melody with your right hand. The arranger will follow your playing.

6 Press START/STOP to stop the Style.



Note: The chord scan area depends on the status of the SPLIT LED and the Chord Recognition parameter (see Global > Mode Preferences > Style).

Tempo

While a Tempo setting is saved with each Style or Performance, you can change it to be whatever you like. You can use either of the following two methods.

- Use the TEMPO + or – buttons to change the Tempo value.

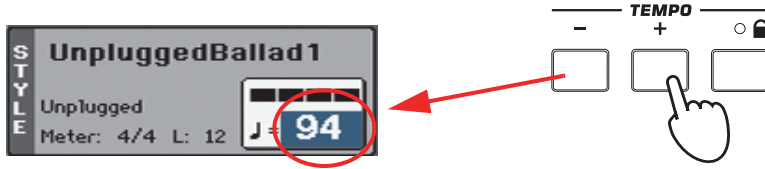

i Hint: As an alternative to using the TEMPO buttons, hold the Tempo value in the display, then move your finger up/down or left/right (or change the value with the VALUE dial).

- Press the TEMPO – and + buttons together to recall the saved Tempo value.

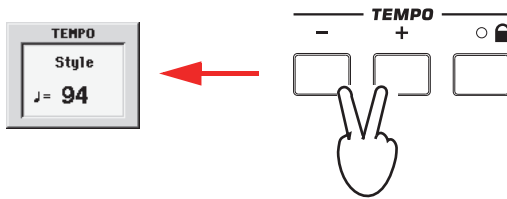

- As an alternative, keep the SHIFT button pressed, and use the VALUE dial to change the Tempo. The selected tempo will be shown in a small window.

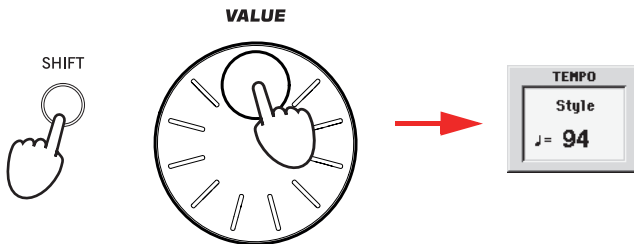

- If you like to keep the currently selected Tempo value unchanged, turn on the LED of the TEMPO  (LOCK) button.

When the Tempo Lock function is turned on, the Tempo will not change when selecting a different Style (or a different Song in Song Play mode).

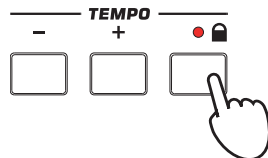

Intro, Variation, Fill, Break, Ending

When playing Styles, you can select various “Style Elements” to cover the various sections of a song. A Style is made of three Intros (or two Intros and a Count-In), up to four basic patterns (Variations), four Fills, a Break, and three Endings.

- 1 **Make sure the SYNCHRO-START LED is turned on (otherwise, press the button to turn it on).**



Activating the Synchro Start function is not mandatory, but it might be handy.

- 2 **Press one of the INTRO buttons to set the corresponding Intro to play.**

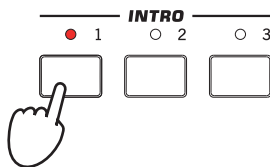

- 3 **Play the keyboard.**

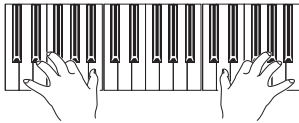

The Style starts with the selected Intro. When the Intro is completed, the basic pattern (selected Variation) starts to play.

- 4 **Be sure the LED of the AUTO FILL button is turned on.**

When the Auto Fill function is turned on, a Fill is automatically performed before switching to a different variation.



- 5 **While playing, press one of the VARIATION buttons, to select a different variation of the basic pattern.**

If you turned the Auto Fill function on in the previous step, a Fill will be performed before the Variation begins.

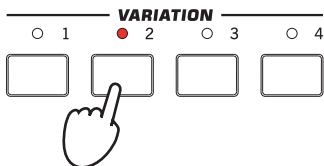

When the Fill ends, the selected Variation will start playing.

- 6** When you like to stop playing, press one of the ENDING buttons to stop the Style with an Ending.

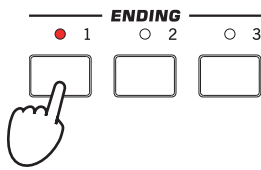

When the Ending is finished, the Style automatically stops.

Single Touch Settings (STS)

Each Style or SongBook Entry may come with up to four Keyboard track settings, called the STS (short for “Single Touch Settings”). STSs are very similar to Performances, but they are fine-tuned to the Style or SongBook Entry they are associated to.

If the STS MODE LED is turned on, STS #1 is automatically selected when choosing a Style. STS #1 is also recalled each time a SongBook Entry is selected.

- 1** In case it is not shown, touch the STS Name tab to see the STS Name panel.

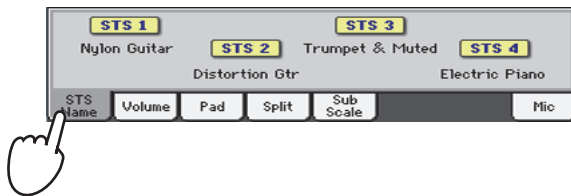

- 2** Press one of the four STS buttons under the display, or touch the name of an STS in the STS panel in the display.

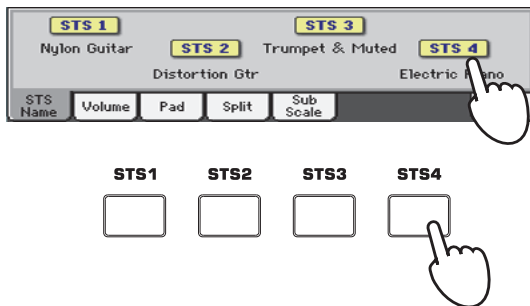

- 3** Play the keyboard.

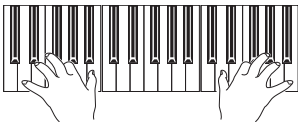

Settings memorized in the selected STS have been selected. Sounds, effects and other settings have been recalled.

- 4** Try all the other STSs, and see how settings change with each of them.

- 5** You can also link the STSs to the Variations. First of all press the STS MODE button, to make its LED flash.



- Then press the various VARIATION buttons, and see how an STS is automatically selected when the corresponding Variation is selected.

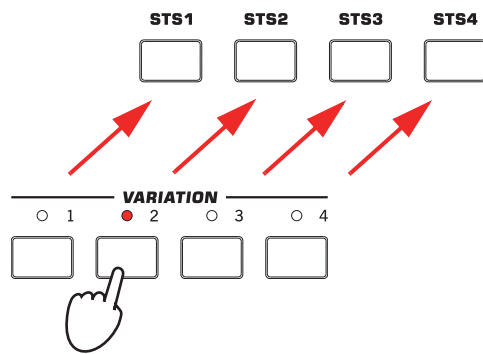

- Press the STS MODE again to turn its LED on (or off).

The Pads

Each Style or SongBook Entry can assign different sounds or patterns to the four PADS. These sounds or patterns can be played along with the Keyboard and Style tracks.

- If you want to see which sounds or patterns are associated to the four Pads for the current Style, touch the Pad tab to see the Pad panel.

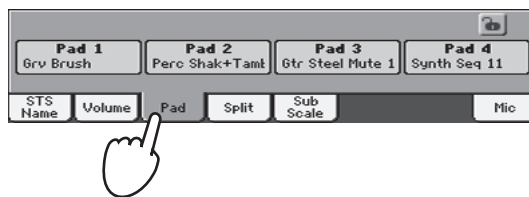

- Press one of the four PADS to play the corresponding Pad.

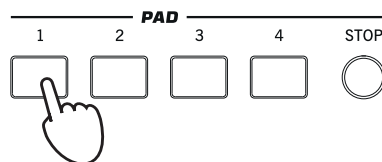

i Hint: You can open the Pad Select window to assign a different sound or pattern to the Pads, by pressing SHIFT + one of the PADS.

- If the selected PAD triggers an endless sound or pattern (i.e. an applause, or a guitar arpeggio), press the same PAD button again to stop it.
- Select a different Style, and see how the sounds or patterns assigned to the PADS change.
- Press more PAD buttons at once, to play two or more sounds or patterns at the same time.
- Press STOP to stop all the Pads at the same time.

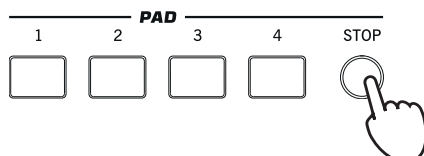

Adjusting the balance between the Style and the keyboard

Balancing between the Keyboard and Style tracks may be useful, to gently fade them and adjust their respective volume.

- While the Style is playing, use the **BALANCE** knob to balance between the Keyboard (KBD) and Style's Accompaniment (ACC) volume.

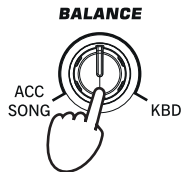

This knob also balances between the Keyboard and the Pad tracks. Also, it balances between the Keyboard and the Song tracks (in Song Play mode).

Adjusting the volume of the separate tracks

You can adjust the volume of each of the Style and Keyboard tracks, for example to soften the bass a little, or to make the keyboard solo louder.

- 1 Touch the **Volume** tab to see the Volume panel.

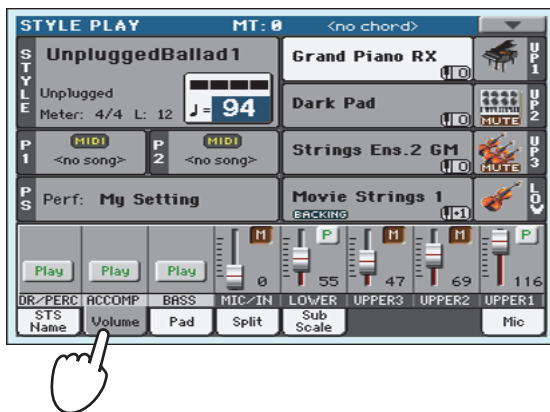

- 2 Hold & drag the **Virtual Sliders** in the display to adjust each Keyboard track's volume.

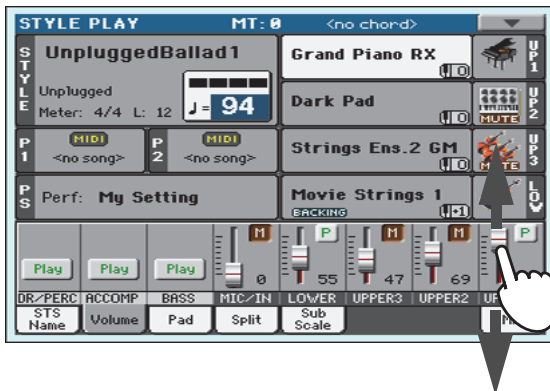

- To separately adjust each Style track, press the TRACK SELECT button to change the track's view.



i Hint: As an alternative, you can change each track's volume, by touching a track's volume, then using the VALUE dial to change the volume.

- To return to the Keyboard Tracks view, press the TRACK SELECT button again.

Turning the Style tracks on/off

You may easily turn on or off any Style track while you are playing. For example, try muting all accompaniment tracks, while drums and bass continue to play.

- Be sure the Volume panel is shown, or touch the Volume tab to show it.

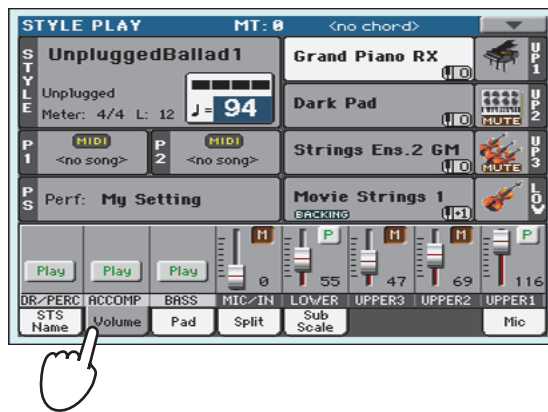

i Note: While in the Normal view of the Style Play mode, you can see Style tracks grouped in just three "grouped" tracks. To see each Style track as separate, individual tracks, just press the TRACK SELECT button.



- While the Style is playing, touch the Play button to set the track to Mute.

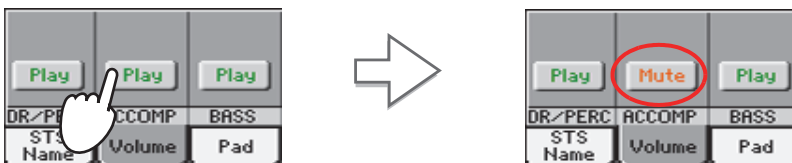

Mute the ACCOMP track. All accompaniment tracks will go silent (apart from Drum, Percussion and Bass).

- To set the tracks back to the Play status, touch the Mute icon on the muted track.

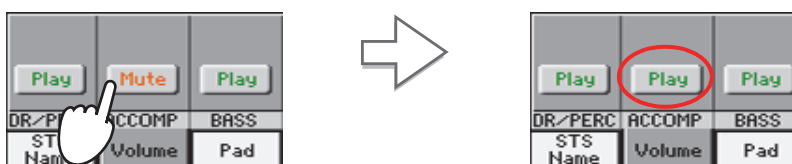

Set the ACCOMP track to Play. All accompaniment tracks will return to their original volumes.

- 4 To mute/unmute each single Style track, first press TRACK SELECT to switch to the Style Tracks view, then repeat the above procedure.**
- 5 Press the TRACK SELECT button again to go back to the Normal view.**

Adding harmony notes to your right-hand melody with the ENSEMBLE function

Chords played with your left hand may be applied to the right-hand melody.

- 1 Press the SPLIT button to turn its LED on and split the keyboard.**

The Ensemble function only works in Split mode.



- 2 Press the ENSEMBLE button to turn its LED on.**

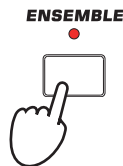

- 3 Play chords with the left hand and single notes in the right hand.**

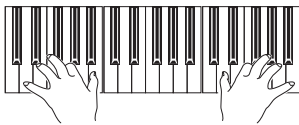

Notice how the right hand is automatically harmonized, according to the chords composed with your left hand.

- 4 To select a different harmonization style, keep the SHIFT button pressed, and press the ENSEMBLE button to open the Ensemble page.**

This is a fast 'shortcut' to recall this page. The longer procedure would have consisted in accessing the Edit mode by pressing the MENU button, touching the Keyboard/Ensemble section, and then going to the Ensemble page.

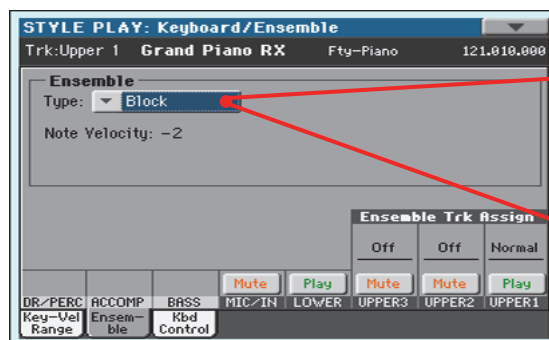
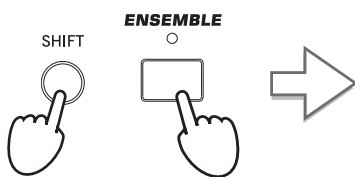

While the Ensemble parameter is selected, use the VALUE dial to select one of the available harmonization types.

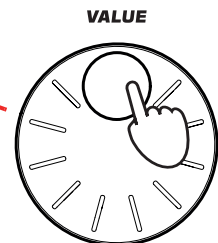

- 5 When the right harmonization type has been selected, press the EXIT button to go back to the main page.

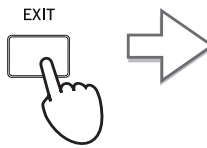
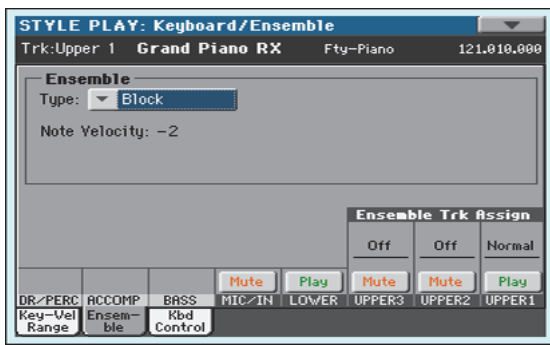

While in an Edit page, press EXIT to go back to the Main page of the current operating mode.



- 6 Press the ENSEMBLE button again to turn its LED off. The automatic harmonization will be turned off.



The Chord Sequencer

In case you need both hands free for playing a solo while a Style is playing, you can record a Chord Sequence and let Pa900 play the chords for you.

- 1 Press the **START/STOP** button to set the Style to play.
- 2 Press the **BASS INV.** and **M. BASS (RECORD)** buttons together to start recording.

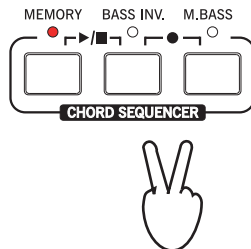

- 3 Start recording your Chord Sequence at the beginning of the next measure.

While recording, you will see a red flashing icon in the display.



- 4 Play the chords in the chord scan area.

The chord scan area is under the Split Point if the SPLIT LED is turned on. Usually, it is over the whole keyboard if the SPLIT LED is turned off. The chord scan area also depends on the status of the Chord Recognition parameter (Global > Mode Preferences > Style).

- 5 When the Chord Sequence is done, press the **BASS INV.** and **MAN. BASS (RECORD)** buttons together again to stop recording.

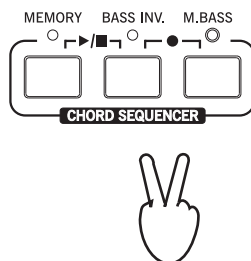

i Hint: You can avoid stopping the Chord Sequencer after recording, and immediately set the Sequence to play, as explained in the following step.

- 6 Press the **MEMORY** and **BASS INV. (PLAY/STOP)** buttons to start playback.

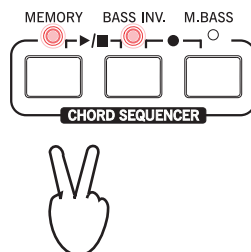

The LED of the two buttons will start flashing. The Chord Sequence will be played back in loop starting from the next measure. Recorded chords will be sent to the arranger, and the Style will play with the recorded chords.

- 7 Play your solo part, while the Chord Sequencer plays the chords for you.

During Chord Sequence looping, you can freely select any Fill or Variation, as if you were playing chords with your hands.

- 8 Press the **MEMORY** and **BASS INV. (PLAY/STOP)** buttons together again to stop playback of the recorded Chord Sequence.

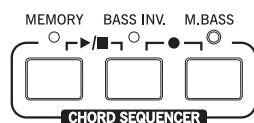

The last chord played by the Chord Sequence remains in memory. The Chord Sequence will remain in memory up until you record a new Chord Sequence, or you set Pa900 to standby.

Song Play

Pa900 is equipped with two onboard Players that can be run at the same time to mix different Songs. The Players can read Songs in Standard MIDI File (MID), Karaoke™ (KAR) and MP3 format.

It may be of great interest to singers and guitar players to know that if a Standard MIDI File or an MP3 file contains lyrics and chords, they can be seen in the display. Lyrics can also be seen on an external video monitor. Lyrics in the graphical “+G” format are also supported.

In addition to lyrics and chords, with Standard MIDI Files and Karaoke files you can also see the score in traditional notation, as well as the markers, to quickly jump to any section of a Song.

The SONG PLAY button

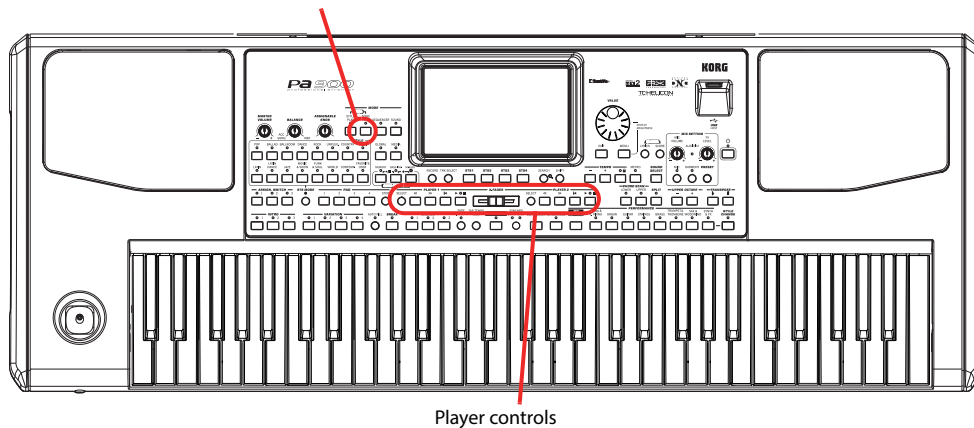

Selecting a Song to play

1 Press the SONG PLAY button to switch to the Song Play mode.

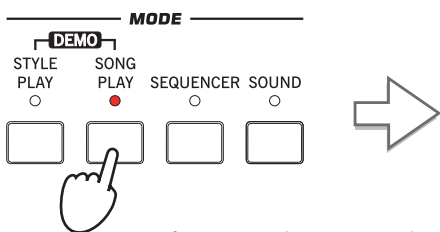

After pressing the SONG PLAY button, the main page of the Song Play mode appears.

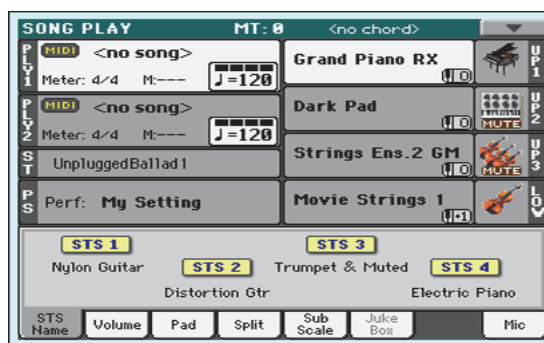

i Hint: In Style Play mode, you can pre-select the Song to be assigned to the Player. This way, you will be ready to start it, as soon as you switch to Song Play mode.

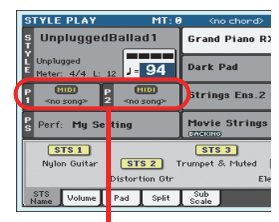

The Song area of the Style Play main page.

2 Touch the Player 1 area to open the Song Select window.

This window is very similar to the one you can see when pressing the MEDIA button on the control panel, and touching the Load tab to see the Load page. This page is, however, “filtered” to only show Song files.



i Hint: As an alternative, you can open the Song Select window by pressing the SELECT button in the PLAYER 1 section on the control panel.

3 Scroll through the list and select the Song to play.

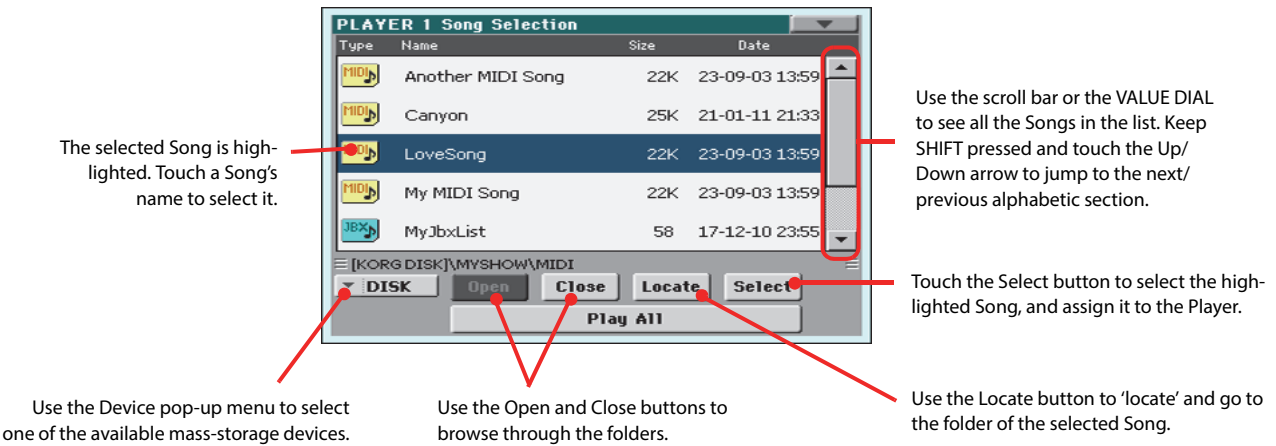

4 When the Song is selected, touch the Select button to confirm your selection; this will automatically close the Song Select window.

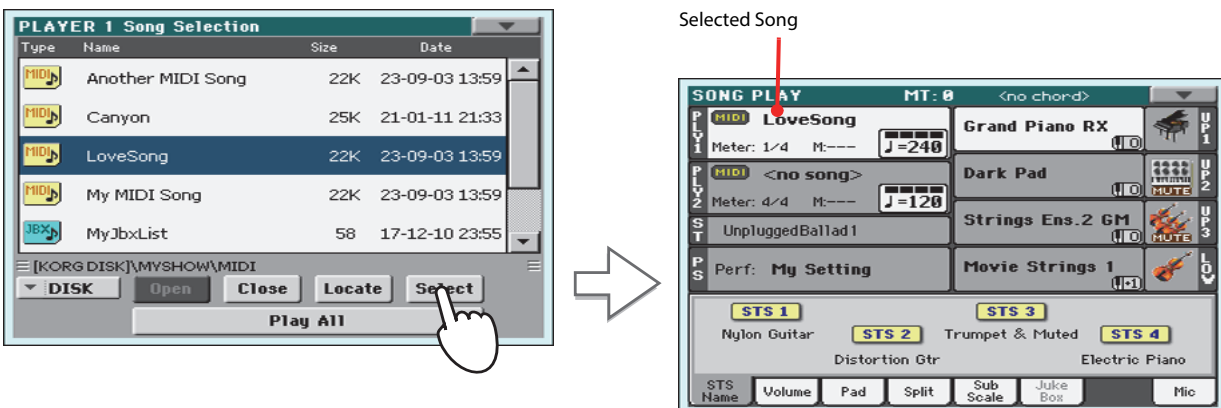

After touching the Select button in the display, the main page of the Song Play mode will appear again.

Playing back a Song

Once a Song has been selected, it may be played back by the Player.

- 1 Be sure the X-Fader is completely moved to the left (toward Player 1).

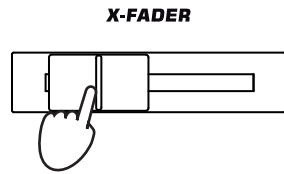

- 2 Press the ►/■ (PLAY/STOP) button in the PLAYER 1 section to start playback.

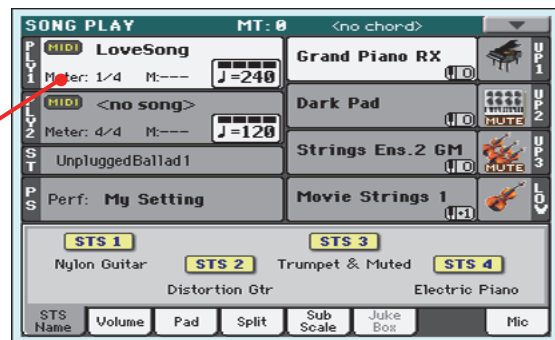
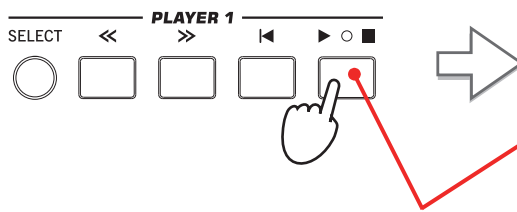

After pressing the ►/■ (PLAY/STOP) button, the button's LED turns on, and the measure counter begins to show the current measure number.

- 3 Use the PLAYER 1 control section to control the Song's playback.

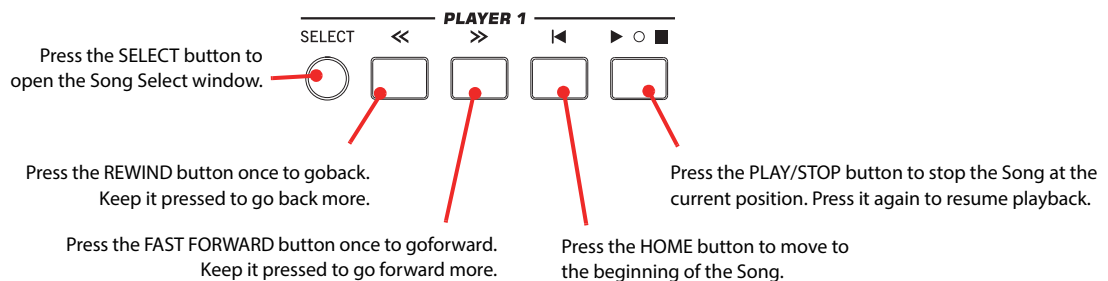

- 4 When you want to stop the song and go back to the beginning, press the ◀ (HOME) button.

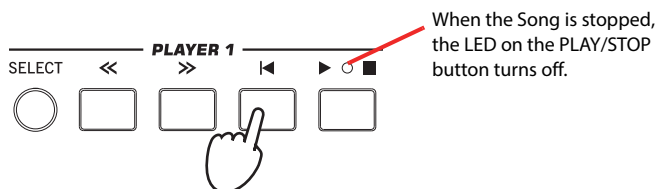

Note: In any case, the Player will automatically stop when the end of the Song is reached.

Changing the tracks' volume

While playing back a Standard MIDI File, you may wish to change each track's volume, to create a mix "on the fly".

- 1 Be sure the Volume panel is shown, or touch the Volume tab to show it.

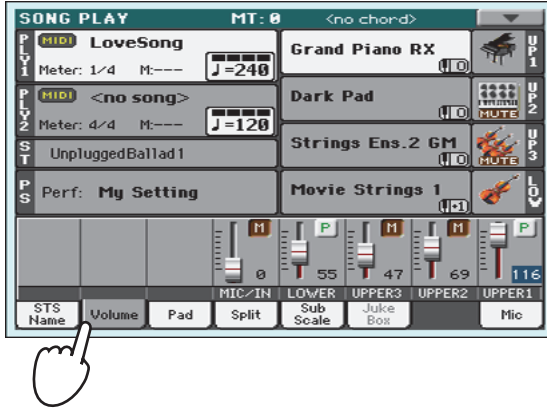

- 2 As seen for the Styles, you can hold & drag the Virtual Sliders on the display to adjust each track's volume. Use the TRACK SELECT button to cycle between track groups.

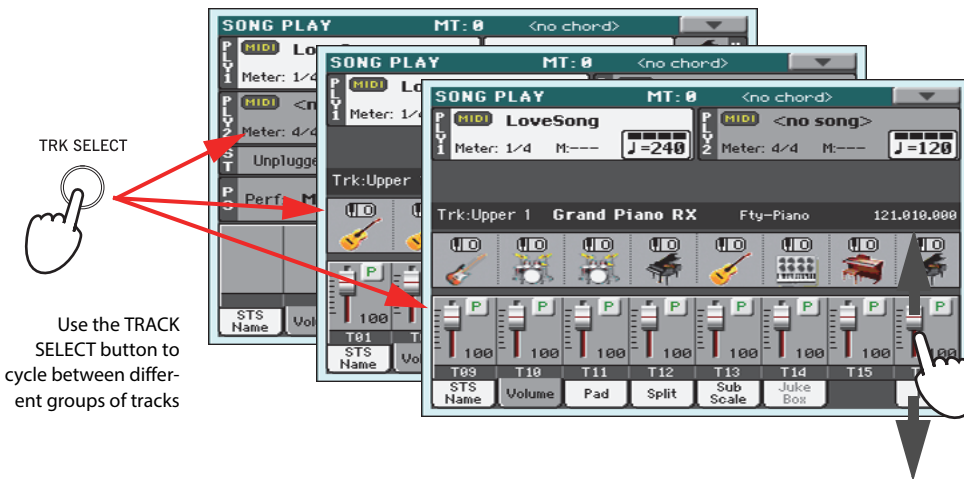

- 3 In Normal view, you can adjust each Keyboard track's volume.

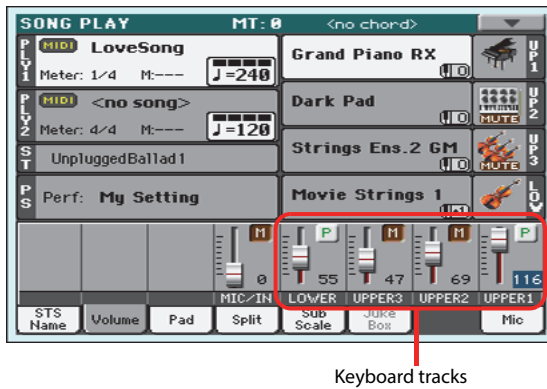

i Hint: As an alternative, you can change each track's volume, by touching a track's volume, by touching a track's area to select it, then using the VALUE dial to change the volume.

Keyboard tracks

4 Press the TRACK SELECT button once to see tracks 1-8 (Track 1-8 view).

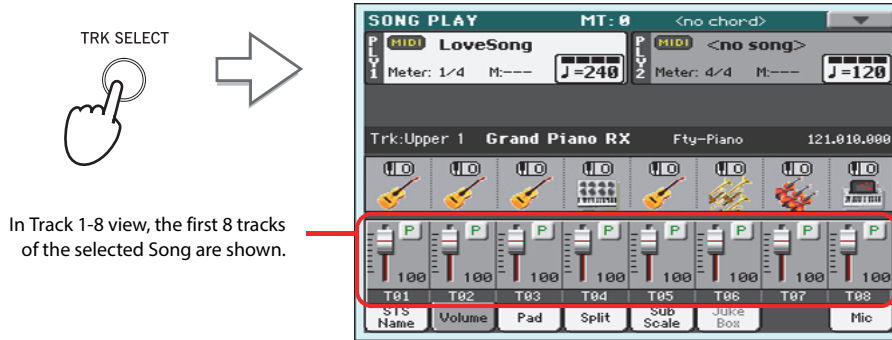

i Note: Changes to Song tracks will not be saved, and are reset each time you press the **⏪** (Home) button, or you select a different Marker. To save changes, you must edit the Song in Sequencer mode.

5 Press TRACK SELECT once again to see tracks 9-16 (Track 9-16 view).

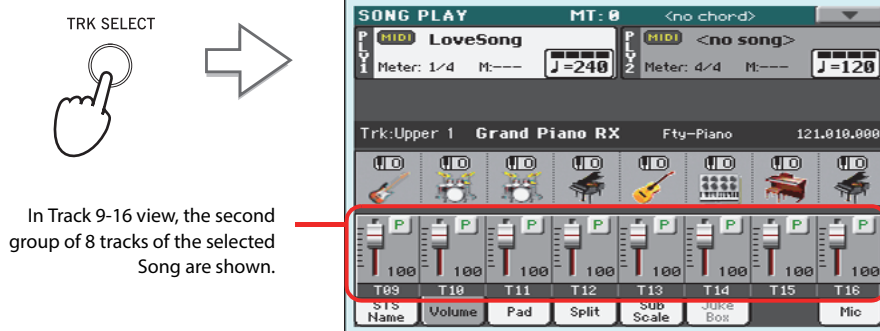

6 Press TRACK SELECT again, to return to the Normal view (Keyboard tracks).

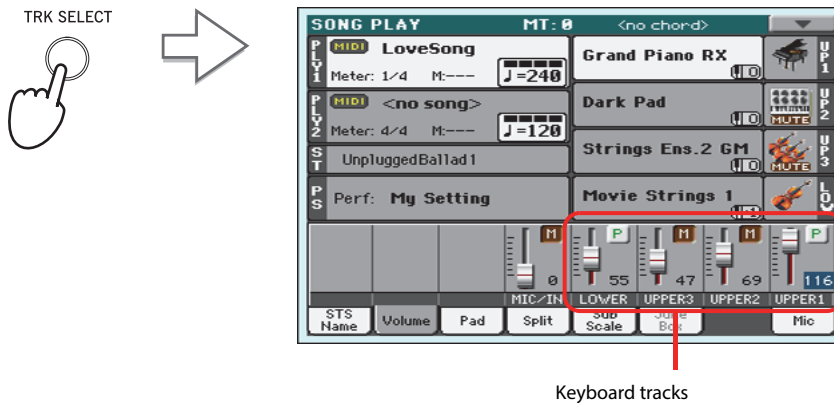

7 Press the **▶/■ (PLAY/STOP) button to start the Song.**

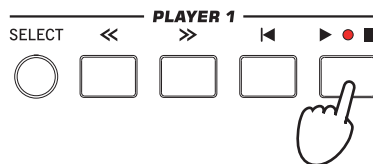

8 While listening to the Song, switch from Normal view to Track 1-8 and Track 9-16 view, to see which tracks are playing.

To see if a track is playing, look at the label with its name, and see if it is changing color.

- Touch each track's channel strip, to see each track's detail in the Track Info line.

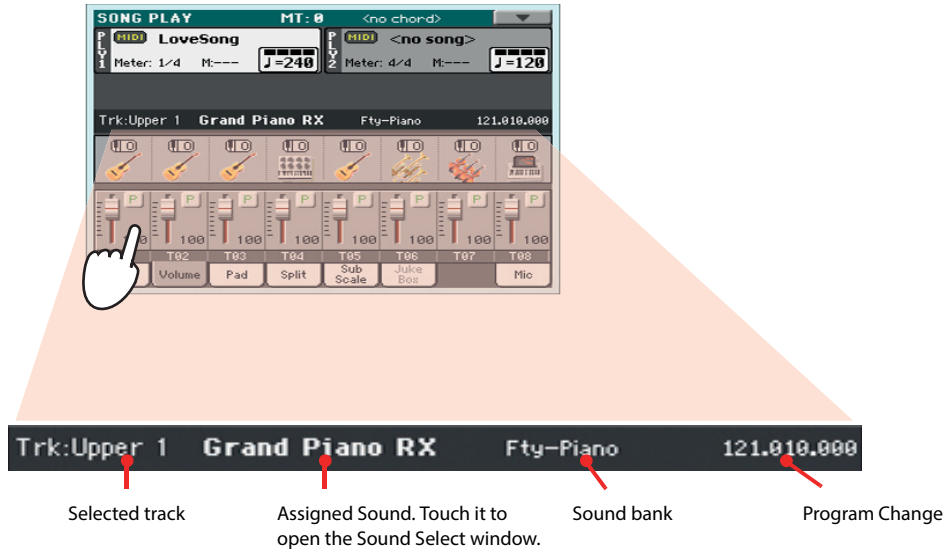

- Also, you can see which type of Sound is assigned to each track in the Sound area of the Track 1-8 and Track 9-16 views.

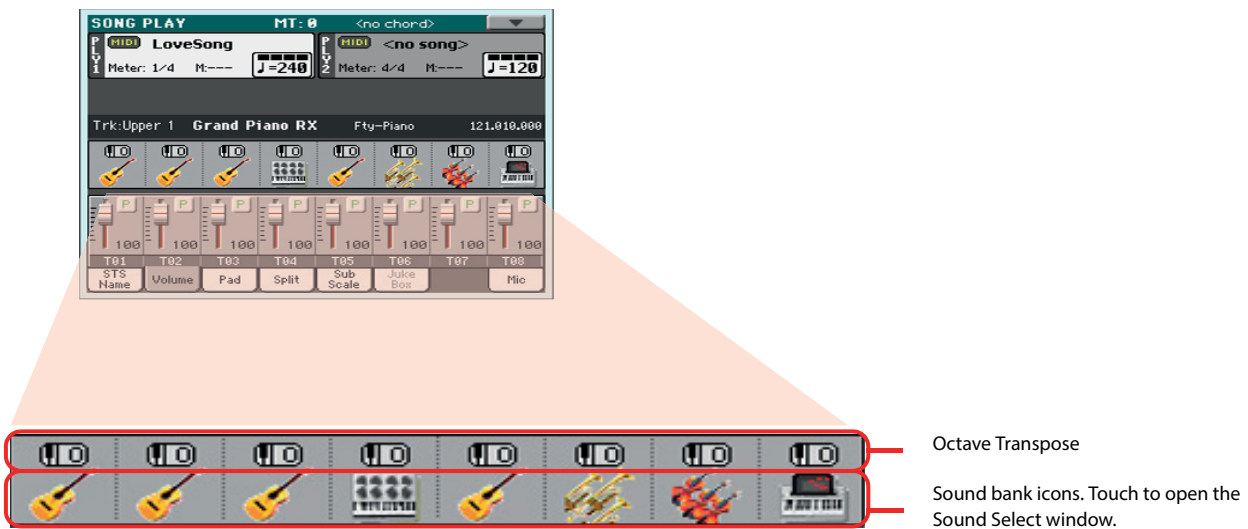

Turning the Song tracks on/off

While playing back a Standard MIDI File, you may wish to mute one or more tracks, for example to sing along with the Song, or play an instrumental part live on the keyboard.

To mute/unmute Song tracks you simply touch the Play/Mute icon in the Volume panel.

Soloing a track

Opposite to the above, you may want to make a single track of a Standard MIDI File play alone. This is called the Solo function.

- 1 While the Song is playing, keep the SHIFT button pressed and touch the track you want to listen to in Solo mode.
- 2 To set all tracks back to the Play status, keep the SHIFT button pressed again, and touch the track that is currently in Solo mode.

Please remember that you can also use the Solo function in Style Play and Sequencer mode. The Solo command can also be selected from the page menu.

Removing the Melody track from a Standard MIDI File or the Lead Vocal from an MP3 file

If you want to sing along with a Song (in Standard MIDI File or MP3 format), you can remove the Melody track or the Lead Vocal from the Song. Please note that removing the Lead Vocal from an MP3 file may be more or less effective, depending on the Song.

Programming the Assignable Switches

- 1 Program the Assignable Switches as the Song-Melody and Vocal Remover switches.

Press the MENU button, and choose the “Pad/Assignable Switch” section. Then touch the Switch tab to open the “Switch” page. While in this page, assign the Song-Melody function to the ASSIGNABLE SWITCH 1, and the Vocal Remover function to the ASSIGNABLE SWITCH 2:

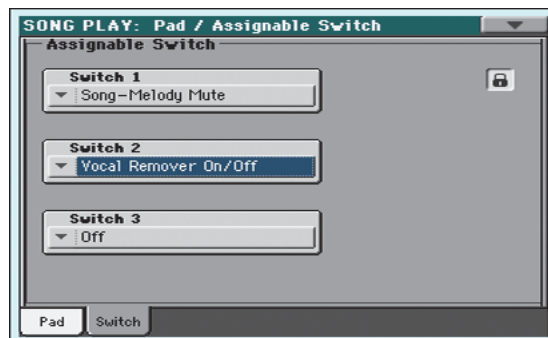

- 2 Press the EXIT button to return to the main page of the Song Play mode.

Using the Assignable Switches with a Song

- 1 Assign a Song (either in Standard MIDI File or MP3 format) to Player 1.
- 2 Start Player 1.
- 3 Press the ASSIGNABLE SWITCH 1 to mute the Melody track, or the ASSIGNABLE SWITCH 2 to activate the Vocal Remover, and remove the Melody track or the original lead singer's voice.

Listen how the Melody track disappears. If it is the wrong track, continue to the instructions below to select a different track.

Or, listen to how the original lead singer's voice is reduced or totally removed.

i Hint: You can open this page by keeping the SHIFT button pressed and pressing one of the ASSIGNABLE SWITCHES.

i Note: The Assignable Switches' assignment can be saved into each Performance or STS.

- 4 When done, you can press the **ASSIGNABLE SWITCH 1** to unmute the Song's Melody track and let the original MIDI instrument play the Melody line again, or press the **ASSIGNABLE SWITCH 2** to deactivate the Vocal Remover and let the original lead singer's voice appear again.
- 5 Stop the Player.

Choosing a different Melody track

You can choose a different Melody track, in case the Standard MIDI Files does not use a standard configuration of tracks.

- 1 Keep the **SHIFT** button pressed and press the **SONG PLAY** button to open the **Global > Mode Preferences > Song Play & Sequencer page**.

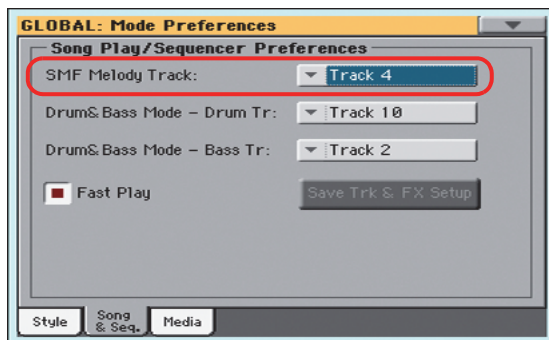

- 2 Choose a different Melody track.
- 3 When done, press **EXIT** to return to the main page.

Mixing two Songs

You can select two Songs at the same time, and mix them by using the X-FADER slider.

- 1 Touch the Player 1 area to open the Song Select window and select the Song to be played by Player 1. Touch Select to confirm.

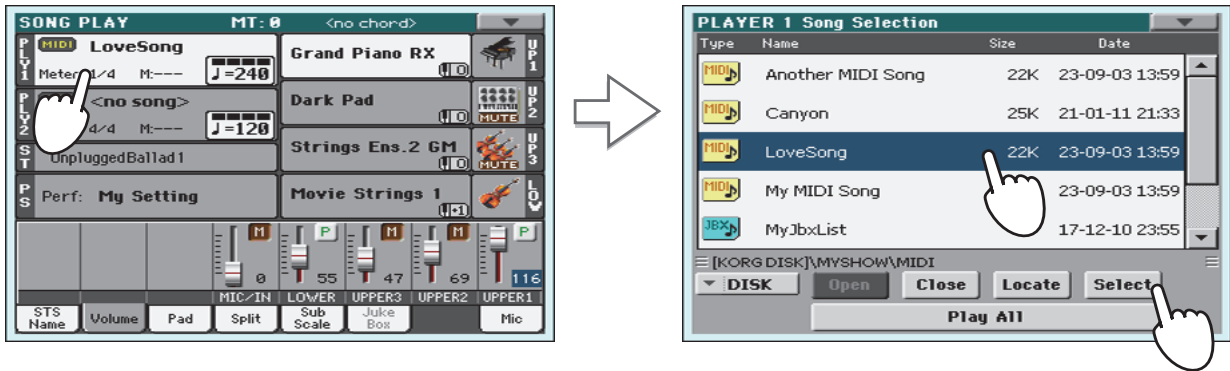

- 2 Once a Song is assigned to Player 1, touch the Player 2 area once to select it, and a second time to open the Song Select window. Select a Song to be assigned to Player 2, and touch Select to confirm.

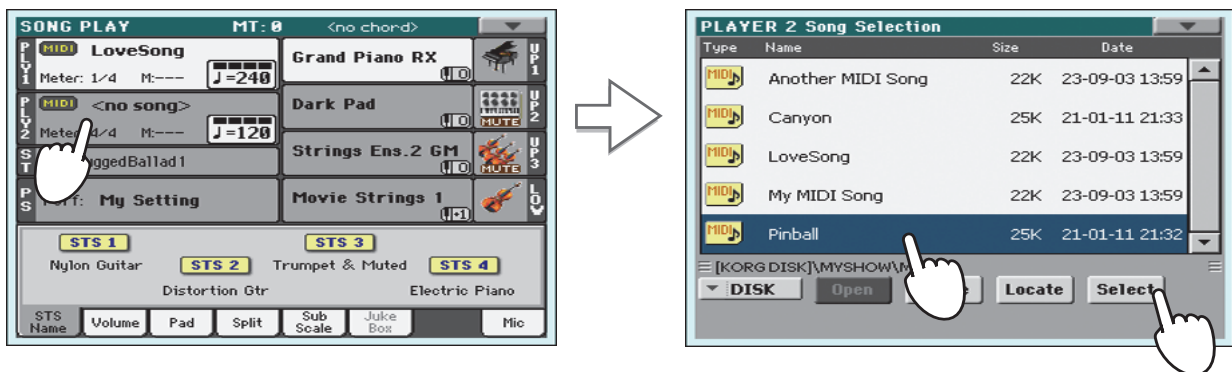

- 3 Keep the SHIFT button pressed, and press any of the two ►/■ (PLAY/STOP) buttons, to start both Players at the same time.

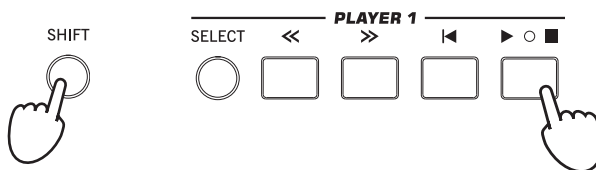

i Hint: You don't need to start both players at the same time. You can start the first Song – then start the second one when the first one is near to the end. This way, you can use the X-FADER slider to gently crossfade between the end of one Song and the beginning of the following one.

- 4 During playback, move the X-Fader, to mix between the two Songs.

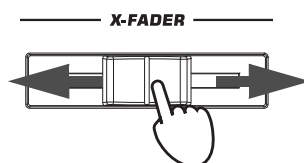

- 5 During playback, you may control each Player separately, by using the dedicated Player controls.
- 6 Press the relevant ►/■ (PLAY/STOP) button to stop the corresponding Player.

The SongBook

One of the most powerful features of Pa900 is the onboard music database, that allows you to organize your Styles and Songs for easy retrieving. Each Entry of this database may include the artist, title, genre, number, key, tempo, and meter (time signature) of a specified song. When selecting one of the Entries, the associated Style, Standard MIDI File or MP3 file – as well as the Style Play or Song Play mode – is automatically recalled. A Voice Processor Preset is also recalled.

In addition to helping you organize your shows, the SongBook allows you to assign up to four Pads, and up to four STSs to each Entry. Also, you can link a text file to any Entry, to be used as the Lyrics of a song, even if there are no Lyrics events in the associated Standard MIDI File or MP3 file, or if you prefer to play the song live with the backing of the Styles.

You can add your own Entries to the SongBook, as well as edit the existing ones. Korg has already supplied some hundred Entries as standard. Furthermore, the SongBook allows you to create various custom lists, that may suit your different types of show.

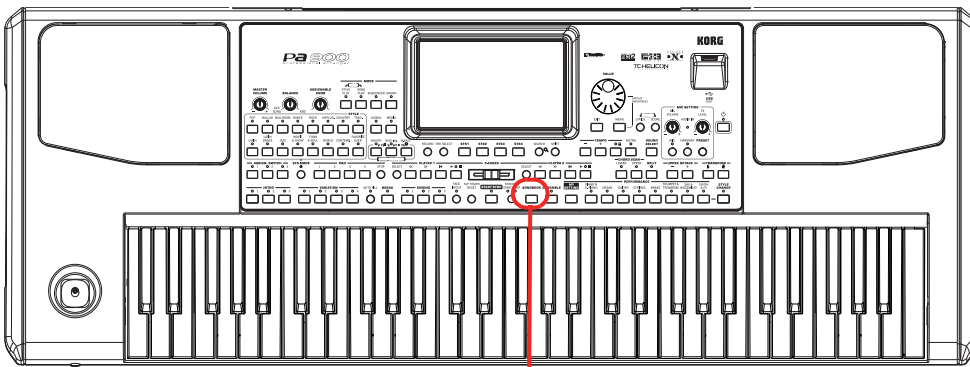

The SONGBOOK button

Selecting the desired Entry from the Main List

A large database is already included with the instrument, and you can later customize it. You may browse through this database in a variety of ways.

- 1 While you are in Style Play or Song Play mode, press the SONGBOOK button to open the SongBook window.

Style, Standard MIDI File(s) or MP3 file(s) currently assigned to the arranger or player(s)

SONGBOOK

MT: 0 <no chord>

N: --- Style: UnpluggedBallad1

Type	Name	Genre	Key	Bpm	Meter
STY	1000giorni di noi	Ballad	-----	86	4/4
STY	6+1 days	Pop	-----	100	4/4
STY	A day in Paradise	Ballad	-----	96	4/4
STY	A felicidad	Latin	-----	170	4/4
STY	A gigolo	Pop	-----	130	4/4
STY	A hard day/night	Pop	-----	148	4/4

Filtered Filter... Add to list Select

Book Custom List Edit Book Edit 1 Book Edit 2 Book Edit 3 Info

Use the scroll bar or the VALUE DIAL to see all the Songs in the list. Keep SHIFT pressed and touch the Up/Down arrow to jump to the next/previous alphabetic section.

Touch this checkbox to turn the view filter on.

Touch this button to edit the view filter.

Adds the selected Entry to the Custom List (if activated – see page 78).

Touch this button to select the current Entry to play.

2 Browse through the Entries.

Icons in the Type column will help you identify the type of the Entry. The Genre column is shown by default, but you can switch to the Artist column (see “Displaying Artist or Genre” below).

3 When the Entry you are looking for becomes visible in the display, select it and touch the Select button in the display.

After selecting an Entry, the corresponding Style, MID, KAR or MP3 file will be recalled, together with the relevant operating mode (Style Play or Song Play). Up to four STSs and four Pads will also be recalled. Any TXT file associated with the Entry can be seen in the Lyrics page.

The selected Style, MID, KAR or MP3 file will be shown in the top area of the screen.

Displaying Artist or Genre

For space matters, either the Genre or Artist column can be seen in the display. You cannot see both at the same time.

1 Touch the page menu icon to open the page menu.

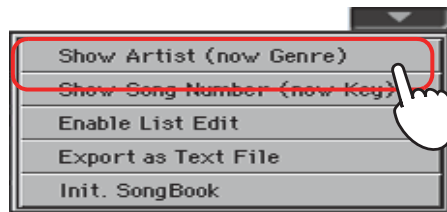

i Note: The Artist and Key fields of all supplied Entries have been intentionally left empty.

2 Choose Show Artist (now Genre) to switch from Genre to Artist in the List view. The Artist column will be shown.



3 Open the page menu again, and choose the Show Genre (now Artist) item. The Genre column will be shown again.

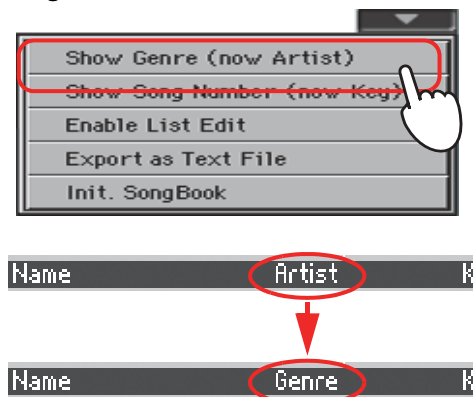

Sorting Entries

You can change the order of the Entries shown in the display.

- 1 You can change the sorting order by touching one of the labels in a list of names.

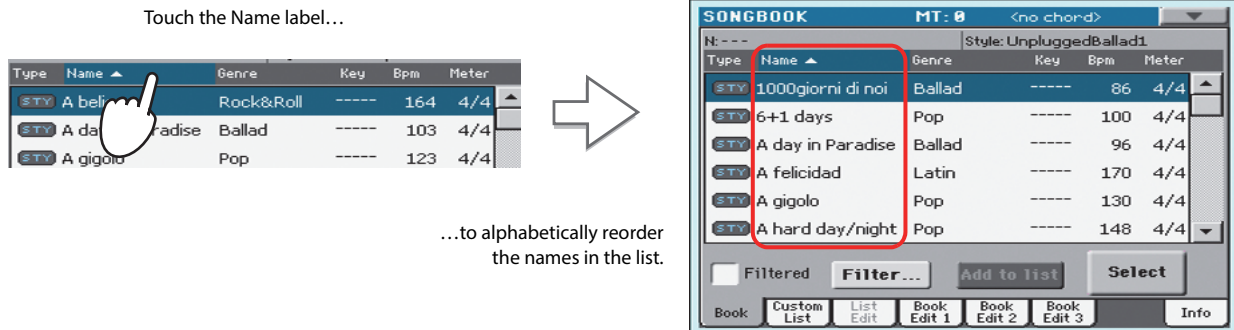

You can do the same by touching the Type, Name, Genre, Artist, Key, Number, Tempo or Meter label.

- 2 Each time you touch the same label again, the order changes between ascending and descending.

Searching for Entries

The SongBook database may be really huge. You can, however, look for (say) specific artists or song titles, using the filtering functions.

- 1 Touch the Filter button in the display, to open the Filter dialog box.

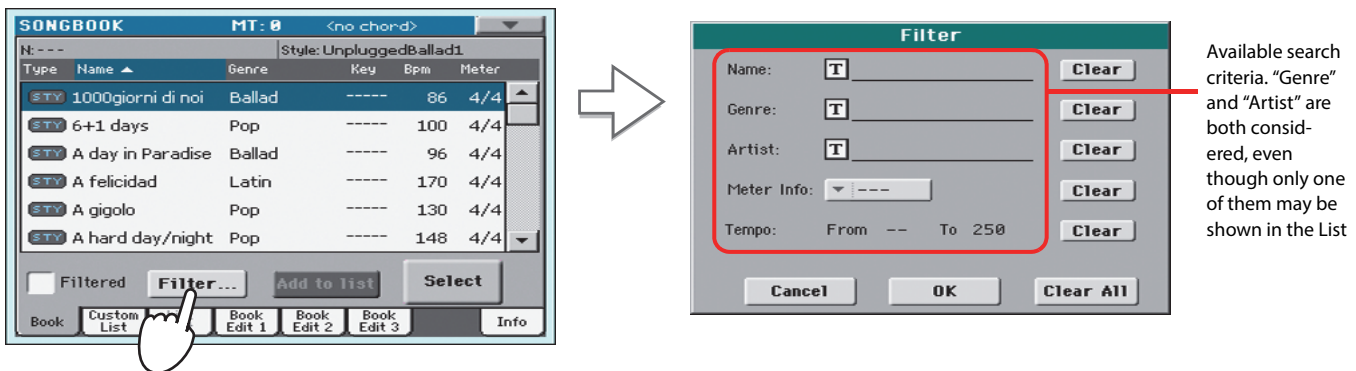

- 2 Touch the **T** (Text Edit) button next to the search criteria (even more than one) you want to enter.

For example, you may want to find all songs containing the word “love” in the title (in any position in the string). If so, select the ‘Name’ criterion, and enter the word ‘love’. Capitals are not relevant for the search.

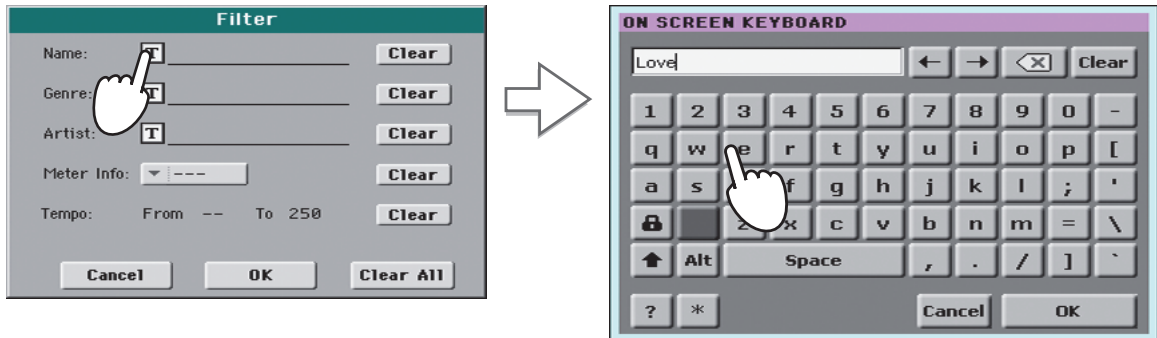

- 3 Touch OK in the display, and close the Text Edit dialog box. The entered text is now the search criteria.

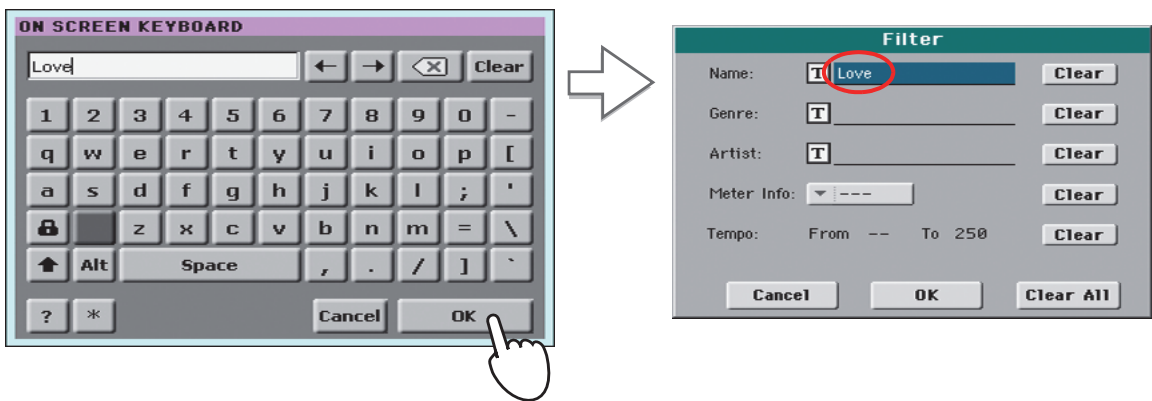

- 4 Touch OK to close the Filter dialog box and return to the SongBook page.

Once the Filter dialog box has been closed by touching OK, the Filtered check box is automatically checked, and the filter is activated. Only Entries matching the entered criterion are seen in the Main List.

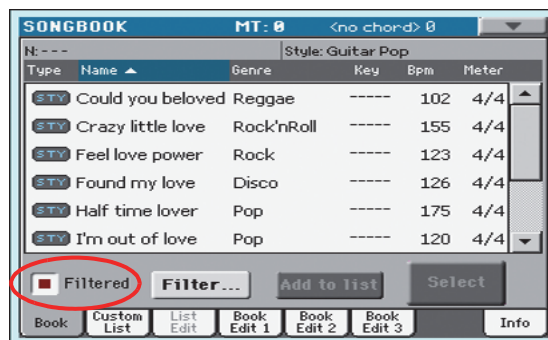

- 5 To see the whole SongBook database again, touch the Filtered check box again, to make the check mark disappear.

Adding Entries

You can add your own Entries to the SongBook database.

- 1 Go to the Style Play or Song Play mode, depending on the type of Entry you want to add to the SongBook database.**
- 2 Select the Style, Standard MIDI File or MP3 file to be added to the SongBook.**
Assign the Song to Player 1 (only Songs assigned to Player 1 will be saved to the SongBook Entry).
- 3 Edit the Keyboard and Style tracks the way you prefer, by selecting different Sounds and Effects, or editing any other relevant parameter.**
Please note that changes to Standard MIDI File tracks will not be saved as SongBook data. Only the data included in the Standard MIDI File will be used.
- 4 Choose a Voice Processor Preset.**
- 5 When ready, keep the SONGBOOK button pressed for about one second to create a new SongBook Entry with the current settings.**



- 6 Touch the  (Text Edit) button to assign a name to the Entry, then touch OK to save the Entry to the SongBook database.**

Editing the Entries

You can edit any SongBook Entry and customize it according to your taste. When done, you can overwrite the current Entry or save it as a new Entry.

- 1 Press the SONGBOOK button to access the SongBook pages.**
- 2 Touch the Book Edit 1 tab to see the Book Edit 1 page and see the linked Musical Resources.**

While in the Book Edit 1 page, you will be able to see the name of the selected Style or Song, and choose whether to replace them or not.

Name of the Style or Song file linked to the Entry. Name of the Entry Song Selection number (ID number for numeric selection)

If checked, the current Style track settings, or the path of the Song file (shown on the right), are saved with the Entry. If unchecked, current settings are left unchanged. This parameter is automatically checked when touching the New Song button to create a new Entry.

If checked, you can either save all the current STSs into the Entry, or choose a single STS where to save the current Keyboard track settings.

If checked, you can save the current Voice Processor Preset into the Entry. If left unchecked, current settings are left unchanged.

(This is just an indicator). When it appears checked, the VP Preset you are saving corresponds to the Global Voice Processor Preset.

3 When done with this page, touch the Book Edit 2 tab to see the Book Edit 2 page and edit the SongBook database details.

Database Entry's parameters

4 Touch the **T** (Text Edit) button next to the field(s) you want to edit. Set all the other parameters.

You can write the Genre and Artist name. Select a Tempo matching the Song's Tempo, and select the Meter (Time Signature) and Key of the Song. You can also specify a Master Transpose value, to be automatically selected when selecting the Entry.

i Note: The Master Transpose might not change, if a Lock is preventing it. See Global > General Controls > Locks.

5 When done with this page, touch the Book Edit 3 tab to go to the Book Edit 3 page, where you can and set the Synchro and Memory parameters, and link a text file to the Entry.

Synchro (for Style) and Memory (for Style and Songs) On/Off status

Text file linked to the Entry. This text will be seen in the same way of ordinary Lyrics in the display (or in the external monitor).

- 6 After having filled up all the desired fields (be as comprehensive as you can), touch the Write button in the display to open the Write dialog box.

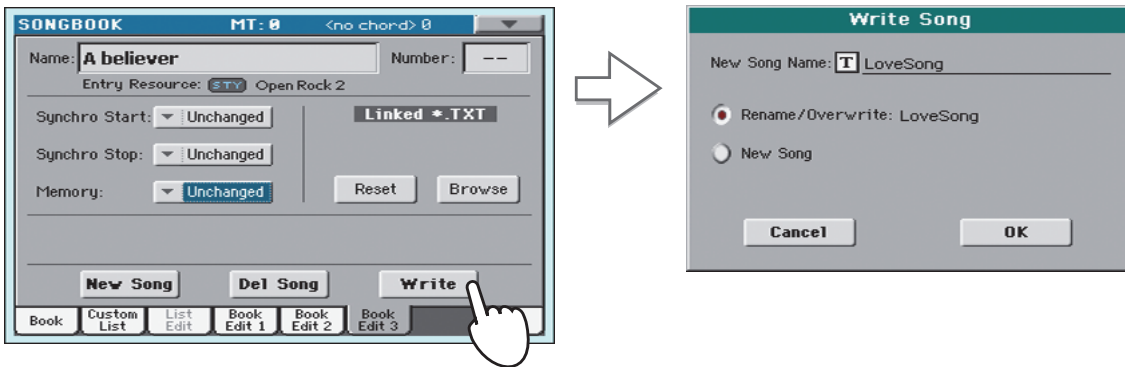

- 7 Touch the **T** (Text Edit) button to assign a name to the Entry, then touch OK to save the Entry to the SongBook database.

Select Rename/Overwrite to replace an existing Entry. This option is automatically selected when editing an existing Entry; it cannot be selected when saving a new Entry. **Warning: the older Entry will be deleted!**

Entry's name. By default it is the same name of the associated Style, Standard MIDI File or MP3 file. The name can be up to 16 characters long.

Select New Song to add a new Entry to the SongBook database. This option is automatically selected when a new Entry has been created (by touching the New Song button).

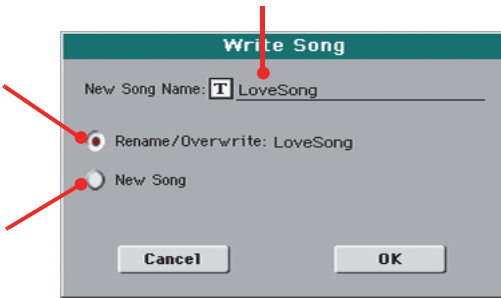

Creating a Custom List

You can create several Custom Lists in the SongBook, to make a set of Entries suitable for your various shows. Before starting a new Custom List, be sure you have added all needed Entries to the SongBook main database (see "Adding Entries" above).

- 1 While in SongBook mode, open the page menu and check the 'Enable List Edit' item.

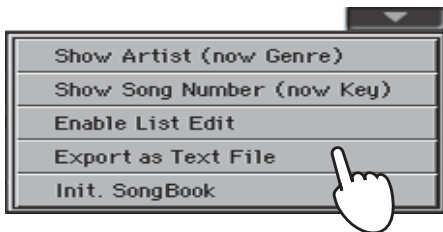

After you check the 'Enable List Edit' item, the List Edit page becomes available.

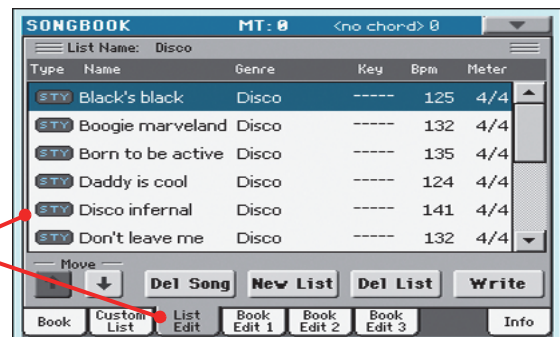

- 2 Select a Custom List to be edited.

To edit an existing list, touch the Custom List tab to open the Custom List page, and select one of the available Custom Lists. To create a new list, touch the List Edit tab to open the List Edit page, and touch the New List button to create a new, blank list.

3 Touch the Book tab to open the Book page and see the full database. Use the various sorting, searching and filtering options (seen above) to find the Entries you are looking for. Touch the Add to List button when the desired Entry has been selected.

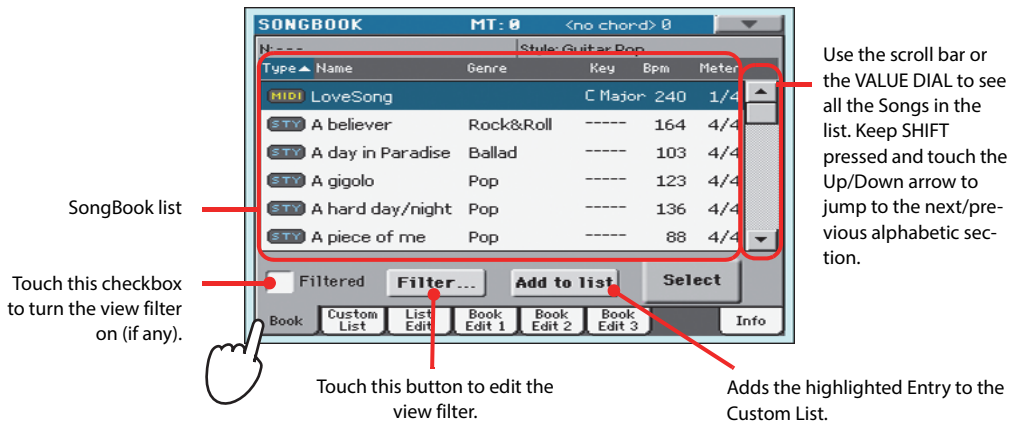

4 When finished adding Entries to the Custom List, touch the List Edit tab to go to the List Edit page, and use the various commands to edit the list.

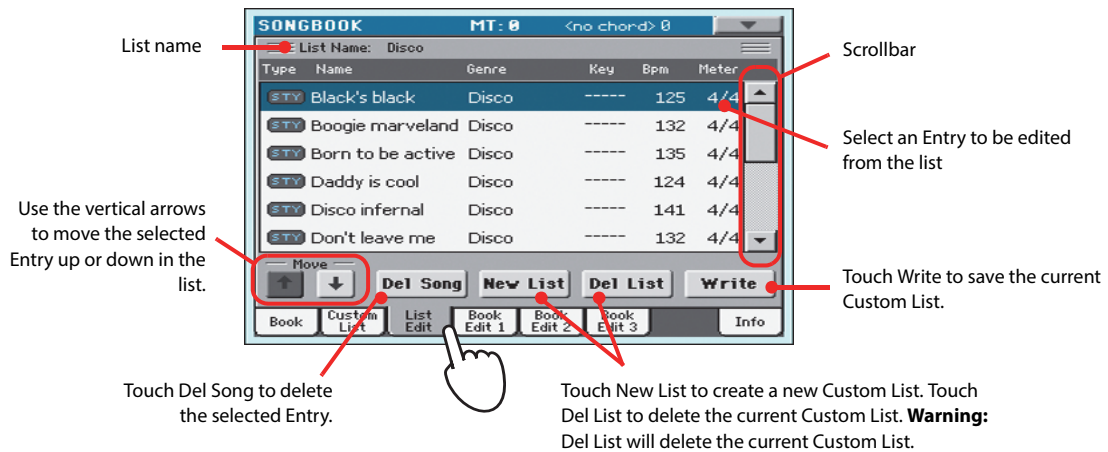

5 When the Custom List is ready, touch the Write button in the display to save it to memory. Assign a new name to the Custom List.

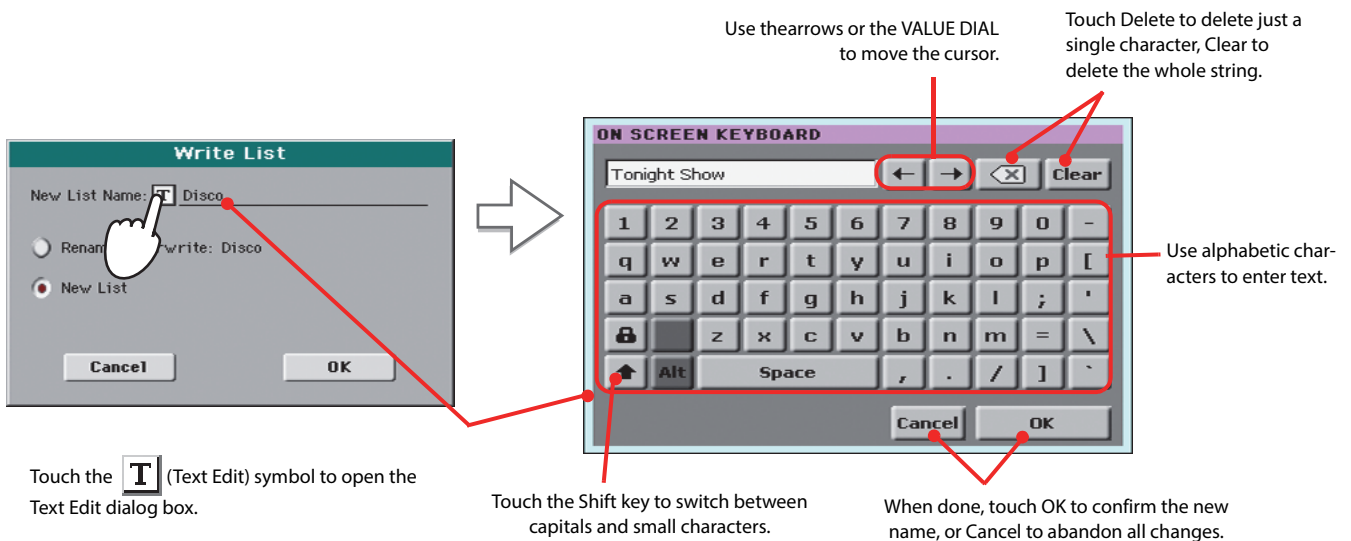

6 When finished editing the Custom List, open the page menu and uncheck the 'Enable List Edit' item.

Selecting and using a Custom List

After having created one or more Custom Lists, you can select one and use it for your show.

- 1 Touch the Custom List tab to select the Custom List page.
- 2 Use the List pop-up menu to select one of the available Custom Lists.



Entry in play. To select a different one, highlight it and touch the Select button in the display.

Touch Select to set the highlighted Entry to play (if different than the one automatically selected).

Use the List pop-up menu to select one of the available Custom Lists.

Touch Next to select the next Entry in the list. (This command can also be assigned to an Assignable Switch).

- 3 Select one of the Entries in the list (it turns blue), then touch the Select button in the display to confirm selection (the selected Entry turns green). Press the PLAY button to start playing back the selected Song.

Singing with a microphone

Pa900 features a high-quality microphone input for a dynamic microphone. It also features a powerful digital voice processor, based on technologies developed by TC Helicon, including dedicated effects and three-part harmonization.

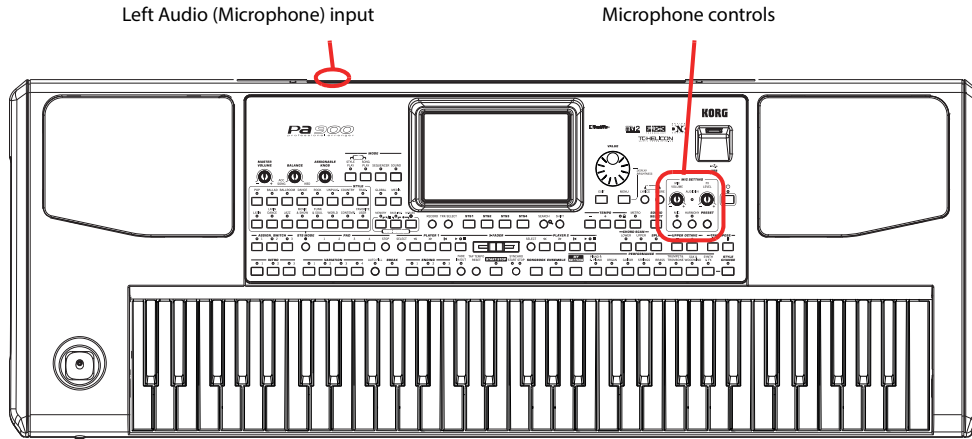

Connecting a microphone

To sing along with the Pa900, you must first connect a dynamic microphone to the LEFT audio input (the one that goes into the Voice Processor).

- 1 Press the GLOBAL button, touch the "Audio & Video" button in the display, then touch the Audio In tab to reach the "Audio In" page.

Be sure the "Input Routing" is set to "Left In to Voice Processor".

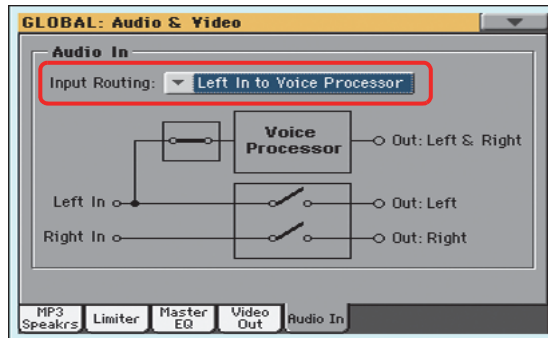

- 2 Press the EXIT button to return to the main screen.
- 3 Turn the Microphone input off by using the dedicated MIC on/off switch on the control panel, and lower the MIC VOLUME knob all way down.

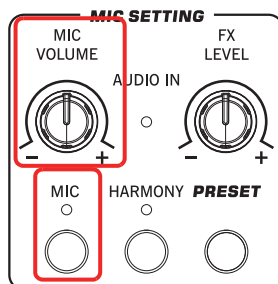

i Note: Keeping the microphone level low helps avoid feedback. Feedback is caused by audio generated by the Pa900, returning to the audio circuitry via the microphone.

4 Connect a microphone.

5 Turn the MIC switch on, and slightly increase the MIC VOLUME level. Sing into the microphone, and adjust the MIC GAIN until you achieve the correct settings.

Adjust the input level by using the MIC GAIN knob next to the LEFT audio input. Sing into the microphone, and watch at the AUDIO IN LED on the control panel – it ought to stay green. If it goes orange too often (or even red), turn down the input gain; if it turns off too often, increase the input gain. No hint of distortion should be heard in the audio system when you sing.

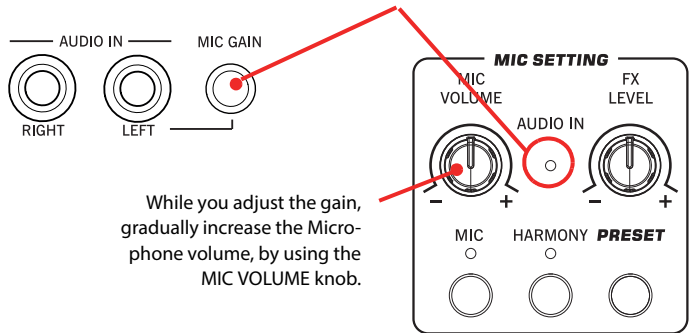

6 When the AUDIO IN LED shows the correct input level, use the MIC VOLUME knob to set the microphone volume in the mix.

Setting up your voice tone

You can add equalization, compression and gate to the microphone signal, to make your voice tonally pleasant and dynamically even. While these effects cannot be considered a replacement for some good training, they can fix a few common problems in a live context.

1 In case your voice is “boomy”, go to the Global > Mic > Global Setup page, by pressing the GLOBAL button, then touching the Mic button in the display, and then (if it is not selected) the Global Setup tab.

The Global Setup page appears in the display.

i Hint: You can keep the SHIFT button pressed, and press the MIC button, to jump to the Global Mic Setup page.

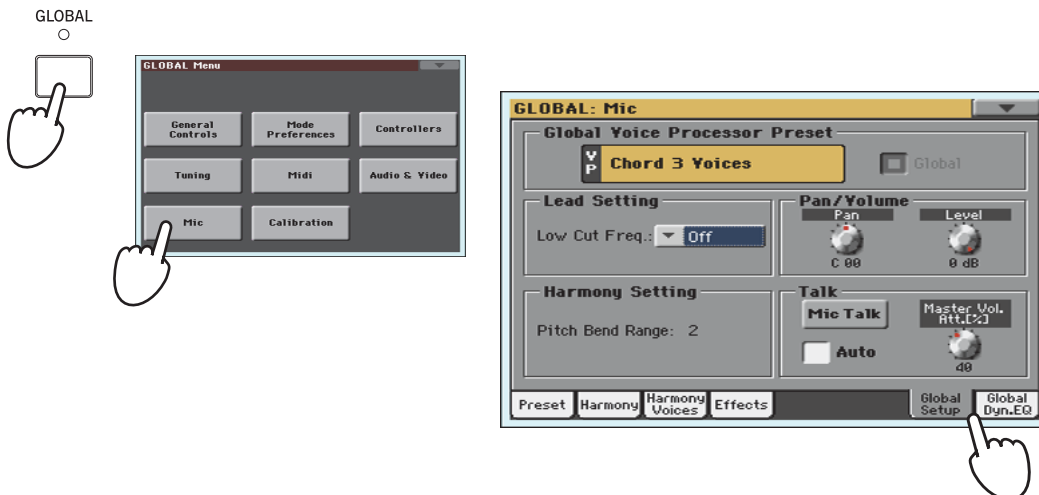

2 To filter out the “boominess”, use the “Low Cut Freq.” parameter and remove some bass frequencies.

Start with the lowest frequency, and then try to up in case it does not solve the problem. In some cases, boominess can be solved by singing a bit farther from the microphone.



3 Then, touch the Global Dyn./EQ tab and adjust the level and tone of your voice.

The Global Dynamics/EQ page appears.

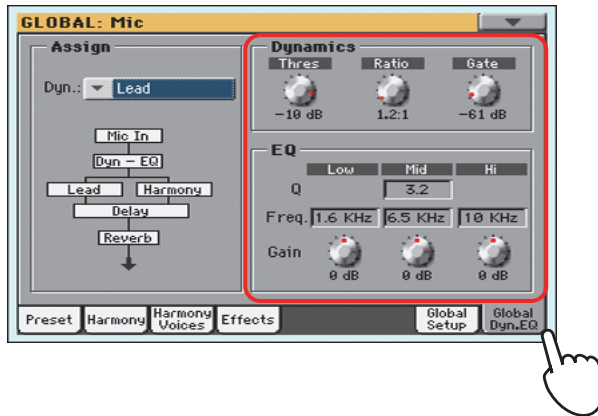

4 Adjust the Compression and Gate settings for your voice.

Adjust the Compressor’s Threshold and Ratio parameters, so that your voice sounds full and even. Use the Gate control to reduce the risk of feedback and the amount of environmental noise (from other musicians on stage, from the audience...).

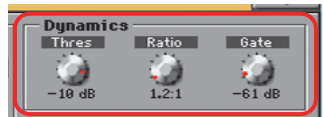

5 Then adjust the Equalization settings.

Use the EQ controls to adjust your tone. Increasing the High band gain adds an airy brightness, or “sizzle” to your voice; it can also increase sibilance. Increasing the Low band gain gives more “body” to your voice, but it can also increase “mud” due to the proximity effect from singing closely into a cardioid microphone. Increasing the Mid band gain increase the presence of your voice in the mix, but it can also make it sound a bit nasal.



6 Press the EXIT button to return to the main page.

7 Since dynamics and EQ can alter the volume level, adjust the volume levels again with the MIC VOLUME knob.

i Hint: You can also access the EQ from the Mic panel of the main screen.

Choosing a Voice Processor Preset

You can add several effects to your voice, and you can set them up quickly through the Voice Processor Presets. These are memories containing all the settings for the Voice Processor effects. You can customize these memories at will.

- 1 **Press the PRESET button in the MIC SETTING sections, and choose one of the Presets from the VP Preset Select window.**

Voice Processor Presets (VP Presets) are settings for the various Voice Processor effects. By selecting a Preset, all processing parameters may change.

While a Global VP Preset is assigned globally, a “local” VP Preset can be assigned to each Performance, Style or SongBook Entry. When selecting one of these elements, the VP Preset may change, changing the type of processing applied to your voice. You can choose a VP Preset in the Mic tab of the main screen.

Press the PRESET button or touch the VP Preset name to select a VP Preset



When the Global option is checked, the Global VP Preset is used instead of the “local” one.

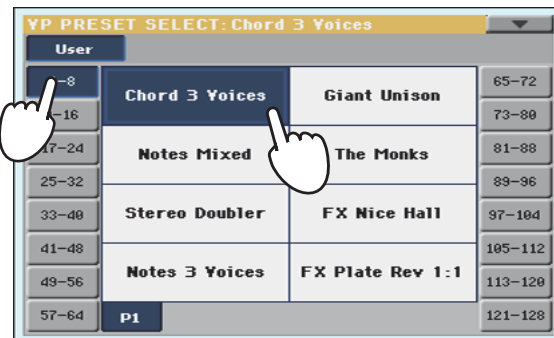

- 2 **Sing into the microphone to listen to the effects.**
- 3 **Adjust the level of the Reverb or Delay effect, by using the FX LEVEL knob in the MIC SETTING section of the control panel.**

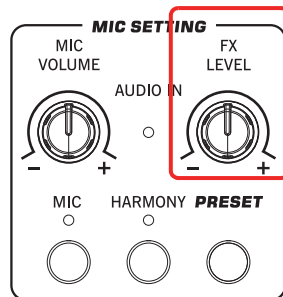

- 4 **Choose a different Preset, and listen to how the effects have changed.**

Applying harmony to your voice while playing with the Styles

You can let Pa900 add automatically-generated harmonies to your lead voice, with up to three backing voices. Each VP Preset may contain a different harmonization style (for example, changing the number of voices, or the way notes are received from the keyboard, a Style or a Song).

Here, we will use a VP Preset set to sing over a Style.

- 1 Press the STYLE PLAY button to go to the Style Play mode, and choose the desired Style.**
- 2 Select the VP Preset “Chord 3 Voices”.**
This VP Preset expects you play chords, and receives notes from the Chord Scan area of the keyboard (the Harmony Mode is “Chord”).
- 3 Play some chords, to let the Voice Processor create new voices based on them, and sing along with the chords you play on the keyboard.**
Harmonizing will add chord notes to the note you are singing.
- 4 Stop the Style.**
- 5 Press the HARMONY button again, to turn its LED off.**

i Note: You can also use this VP Preset in Song Play mode, and play harmony notes in the Chord Scan of the keyboard.

Applying harmony to your voice while playing with a Song

Harmony notes can be received from a Song’s track. Here is how to use a VP Preset set to sing over a Song.

- 1 Press the SONG PLAY button to go to the Song Play mode, and choose the desired Song.**
- 2 Select the VP Preset “Notes 3 Voices”.**
This VP Preset expects notes from Track #5 of the Standard MIDI File (the Harmony Mode is “Notes”). To choose a different track keep the SHIFT button pressed and press the HARMONY button to see the Harmony page. Use the “Song Control” parameter to choose a different track.
- 3 Sing along with the Song, and let the Voice Processor create new voices based on the Harmony track of the Song.**
- 4 Stop the Song.**
- 5 Press the HARMONY button again, to turn its LED off.**

i Note: You can also use this VP Preset in Style Play mode, and play harmony notes over the full keyboard.

Balancing the voice, effects and tracks level

When all effects have been set, you can balance your voice against the effects, the Styles and the Songs.

- 1 **If you like, start a Style or Song.**
- 2 **Adjust the microphone's final volume by using the MIC VOLUME knob.**
The position of the MIC VOLUME knob is not saved to memory, so it remains consistent when selecting different Styles, Performances, Songs or Voice Processor settings.
- 3 **If you are using the Harmony function, adjust the level of the harmony voices by using the "Harmony Level" parameter in the Mic panel of the main page.**

By default, this control is also assigned to the ASSIGNABLE KNOB.



- 4 **Set the voice effects' level by using the dedicated FX LEVEL knob.**

Soloing your voice (Talk)

Sometimes, during a live show, you might like to talk to your audience. Use the Talk function to attenuate the music, and let your voice pass through clean and clear.

- 1 **While in the main page of the Style Play or Song Play mode, touch the Mic tab to see Voice Processor's settings.**
- 2 **During playback, turn the Talk function On.**



- 3 **Sing or talk into the microphone.**
You'll hear that then background music has been made softer, while your voice will be heard *loud and proud*.
- 4 **When done, turn the Talk function Off.**

The background music returns to the original volume.

Recording a new Song (Standard MIDI File)

There are several ways to create a Song on the Pa900. The easiest and fastest is to use the Styles to record what you are playing in realtime on the keyboard, while the arranger gives you the accompaniment tracks.

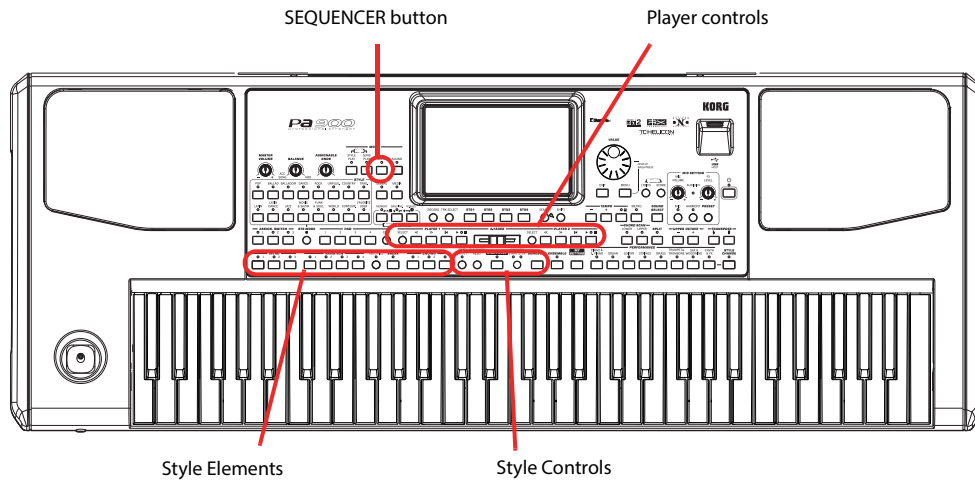

Preparing the Style and Sounds

Before accessing the Record mode, we suggest you prepare the Style and Sounds with which to record your Song.

- 1 Select a Style with which you want to record.**
- 2 Select the Sounds by choosing a Performance or STS.**

That's all! You are ready to access Record mode.

Accessing the Backing Sequence (Quick Record) mode

1 Press the **SEQUENCER** button to switch to the Sequencer mode.

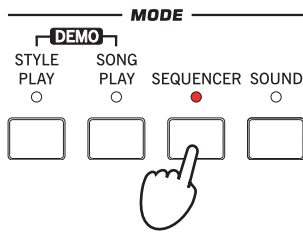

After pressing the SEQUENCER button, the main page of the Sequencer mode appears.



2 Press the **RECORD** button to open the Song Record Mode Select dialog box.



Press the RECORD button, to open the Song Record Mode Select dialog box



3 Select the **Backing Sequence (Quick Record)** option and touch **OK** to enter the Backing Sequence Record mode.

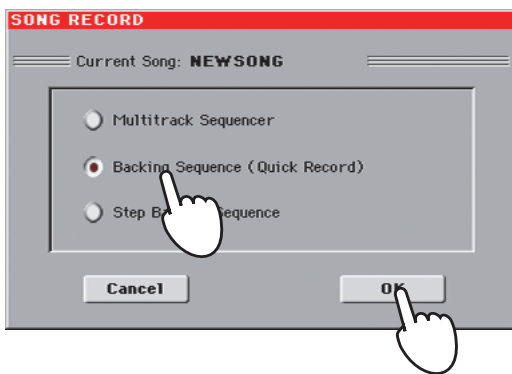

After having chosen the Backing Sequence (Quick Record) option, the Backing Sequence Record page appears.

Setting the Record parameters

When you enter Backing Sequence Record, the latest selected Style and Sounds are already selected, and all tracks are ready to record. You could simply start recording as if you were playing in realtime with the Styles. However, there are some further settings that you may want to do.

- **If you like, adjust any editable parameter in the display.**

Touch the Style parameter (or the STYLE button) to open the Style Select window, and select a different Style.

Track(s) status. 'Rec' means they are ready to record. 'Play' means they are recorded and you can hear them. 'Mute' means they cannot be heard.

Measure counter. The negative number (-1) is the precount, after which you can start recording.

Style's Tempo. Change it, if you like.

Style's Meter (or Time Signature). It's just an indicator, you cannot change it.

Touch the Perf/STS parameter to open the Performance Select window, and select a different Performance (as seen on page 43). As an alternative, you use the PERFORMANCE or STS buttons.

Grouped tracks. During Quick Record, you cannot access each separate Song track. For ease of use, just two 'master' tracks are provided: **Kbd/Pad** (Keyboard/Pads) and **Ch/Acc** (Chord/Accompaniment).

Recording

1 Select the Style Element you wish to use before starting to play.

Select any of the Variations before starting to record.
Select one of the Intros to start with an introduction.

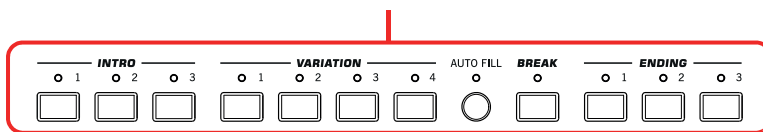

2 Start recording, by pressing the START/STOP button.

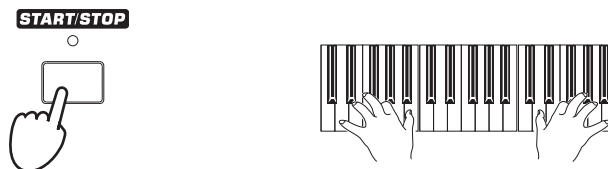

Note: If you do not wish to start the Song with the Style already playing, you can simply start recording by pressing the **PLAY/STOP** button in the **PLAYER 1** section, then start the Style only at a later time. The Style will start at the beginning of the following measure.

3 Play as if you were performing live with the Styles.

During recording, select any Style Element (Intro, Variation, Break, Ending...) you like. You can also press START/STOP to stop the Style, and press it again to start the Style again!

Please remember that, while recording in Backing Sequence Record mode, you cannot use the SYNCHRO, TAP TEMPO/RESET, BALANCE controls.

- 4** When finished recording your Song, press the ►/■ (PLAY/STOP) button in the PLAYER 1 section to exit recording, and return to the main page of the Sequencer mode.

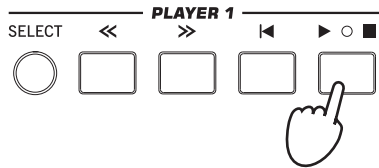

After pressing the PLAY/STOP button, the main page of the Sequencer mode will appear again.



- 5** While in the main page of the Sequencer mode, press the ►/■ (PLAY/STOP) button in the PLAYER 1 section to listen to the recorded Song.

The Backing Sequence Song has been converted to an ordinary Song (in Standard MIDI File, or “MID”, format). If you like it, you can save it. You can then read it in Song Play mode, or transfer it to any external sequencer.

- 6** If you want to edit the Song, press MENU to access Edit mode.

Second-take recording (Overdubbing)

You may want to record an additional “grouped” track, or replace a bad-recorded track with a new one. A good idea may be to record all chords and Style Element changes during the first take, then record Keyboard tracks and Pads during the second take.

- 1** Press the RECORD button to enter Record mode again. When the Song Record Mode Select dialog box appears, select Backing Sequence (Quick Record) again.
- 2** If you are recording just one of the “grouped” tracks, set to Play the track to be preserved.

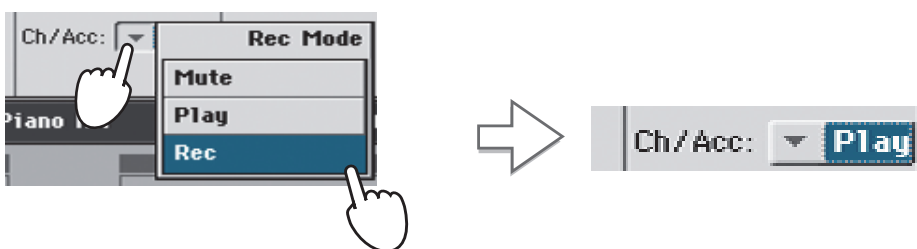

- 3** Repeat the recording procedure, and press the ►/■ (PLAY/STOP) button in the PLAYER 1 section to stop recording and return to the main page of the Sequencer mode.
- 4** While in the main page of the Sequencer mode, press the ►/■ (PLAY/STOP) button in the PLAYER 1 section to listen to the recorded Song.

Again, the Backing Sequence Song has been converted to an ordinary Song.

Saving a Song

After having recorded a Song that you like, it is a good idea to save it, to avoid losing it when the instrument is turned off (or put in standby).

- 1 While in the main page of the Sequencer mode, touch the page menu icon to open the page menu.

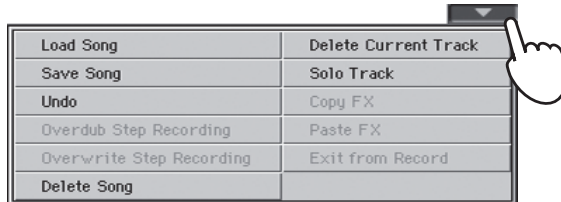

- 2 Select the Save Song command to open the Save Song window.

This window is very similar to the one you can see when pressing the MEDIA button on the control panel, and touch the Save tab to see the Save page. This page is, however, “filtered” to only see Song files.

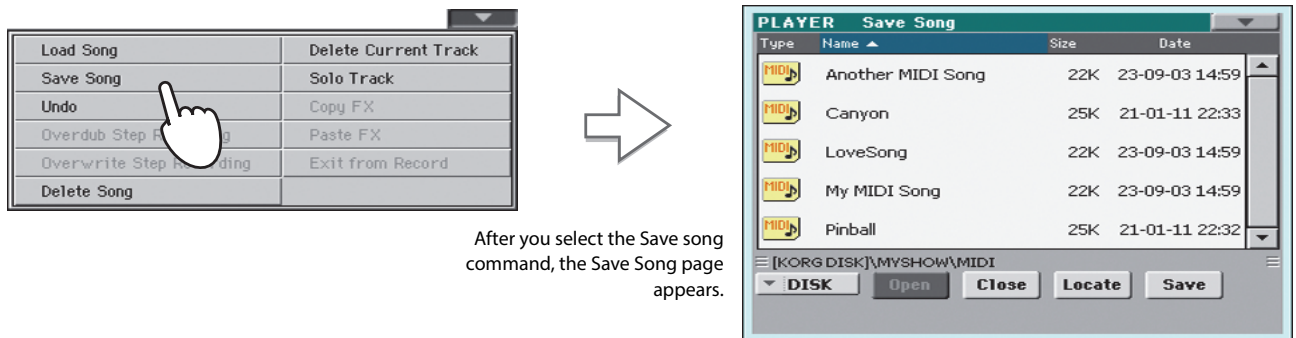

- 3 Select a device and folder where you want to save your Song.

If a Song is selected (highlighted) it will be overwritten. If no Song is selected, a new Song file will be created on the target device. To deselect a selected Song, touch anywhere else in the Song list, or select the same storage device again.

Use the Device pop-up menu to select one of the available storage devices

Use the Open and Close buttons to browse through the folders.

Use the scroll bar to see all Songs in the list. Keep SHIFT pressed and touch the Up/Down arrow to scroll to the next/previous alphabetic section. As an alternative, you can use the VALUE DIAL.

Touch the Save button to save the Song to the current folder.

EXIT

In case you prefer to exit this page without saving the Song, press the EXIT button.

4 Touch the Save button in the display to open the Save Song dialog box.

Touch the Text Edit icon to edit the Song's name.

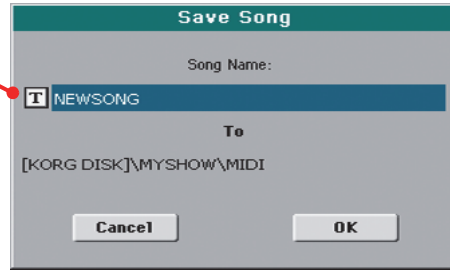

5 Touch OK in the display to save the Song, or Cancel to stop the Save operation.

Recording a new Song (MP3 file)

With Pa900, you can record your performance as an MP3 file. Keep in mind what follows:

- All you play on the keyboard, the Styles and the Standard MIDI Files performed by the Players will be recorded.
- Any audio signal entering the Audio Inputs is recorded (single microphone input with the “Mic In to Voice Processor” option selected, or the Left and Right line inputs with the “Audio In to Direct Out” option selected. See “Audio & Video: Audio In” on page 281). Harmony voices generated by the Voice Processor will be also recorded.
- You will not be able to load MP3 files while recording an MP3 Song, and you will not be able to record an MP3 Song while an MP3 file is playing.

You will then be able to play the resulting MP3 files using the Players, as with any other MP3 file.

1 To access recording, keep the SHIFT button pressed, and press the RECORD button.

The MP3 Record dialog box will appear.



When not recording, the status shown is Idle.

2 Choose the preferred MP3 audio quality option, by means of the “Quality” pop-up menu.

The higher the sound quality, the larger the MP3 file that will be generated.

3 Use the “Device” parameter to choose a location where to temporary store the recorded MP3 file.

This is not the final destination of your file, since you will be able to choose a different location after recording. However, be sure there is enough space for the temporary file, by checking the “Free space” parameter.

The default device is automatically selected as the recording unit; use the Device pop-up menu to choose a different one. You can record to the internal memory or to a device connected to one of the USB ports.

4 When done, touch the “Rec” button in the display to start recording.

The “Rec” button changes to “Stop”, and can be touched again to stop recording. Also, the “Idle” label changes to “Recording”.



i Note: You cannot enter MP3 Record mode while in Sequencer or Media mode.

i Note: MP3 files recorded with lower sampling rates may not sound very good. This is a problem that cannot be avoided with MP3 files.

5 Start playing and singing your Song.

You can record everything you play; in addition, you can record your vocals. In other words, you can record your whole performance.

6 If you like, you can press the EXIT button to exit this dialog box and navigate through the Style Play and Song Play pages, without stopping to record.**7 To access the dialog box again, and see the file length or stop recording, press SHIFT+REC again.**

During recording, if you exit from the MP3 Record dialog box while still recording, a red recorder icon will flash in the display.



During recording, you can use this dialog box to see the Recording time, file length, and the remaining space on disk. Maximum recording time depends on the available space in the selected device.

8 Touch "Stop" to stop recording.

After touching "Stop", recording will stop, and the following dialog box will appear:

**9 Touch the  (Text Edit) button to give the MP3 file a name.****10 Touch the "Browse" button to select a device and directory where to save the file.****11 Touch the "Save" button to save the file.**

After saving, you can listen to the MP3 file in Song Play mode, as you do with any other Song.

The MP3 file can also be moved to a personal computer for further editing, by copying it to an USB memory stick.

Searching files and musical resources

With Pa900, you can press the SEARCH button to search for files or musical resources.

How to use the Search function

Depending on the page you are in, you can search for different types of data. For example, while in Media mode you can only search for files, while in Style Play or Song Play mode you can search for several different types of data (Styles, Songs, Lyrics...).

There are some pages where the Search function is not available, since there are no relevant data to search for that page (for example, the pages of the Global mode).

Here is the general procedure.

- 1 Press the SEARCH button to open the Search window.

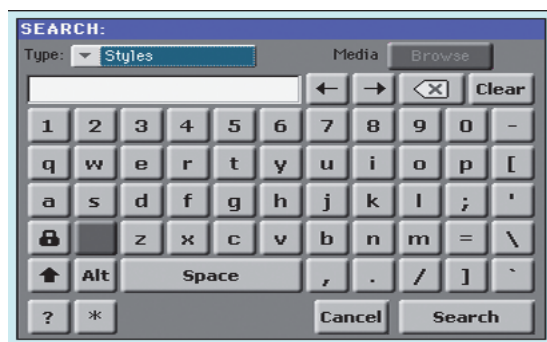

- 2 If needed, touch the "Type" pop-up menu, and choose the type of item you are looking for.

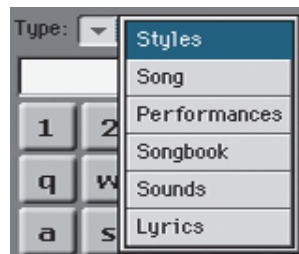

When choosing Files, Songs or Lyrics, the "Browse" button will be activated, to allow for searching files in the disks.



3 In case you are searching for a file in a disk, touch the “Browse” button to open the Media window.

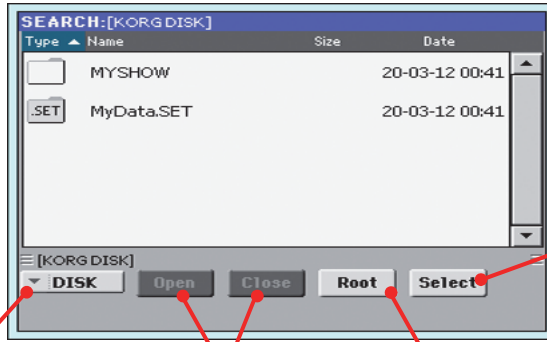

When you see the folder containing the file you are looking for, touch it, then touch the Select button to close the Media window. The name of the selected folder will be shown in the title bar of the Search window.

Use the Device pop-up menu to select one of the available storage devices

Use the Open and Close buttons to browse through the folders

In case you are lost among the directories, touch the “Root” button to go to the root of the selected device

4 Type the name of the file to be searched.

There is no difference between upper and lower cases (“LOVE” is the same as “Love” or “love”).

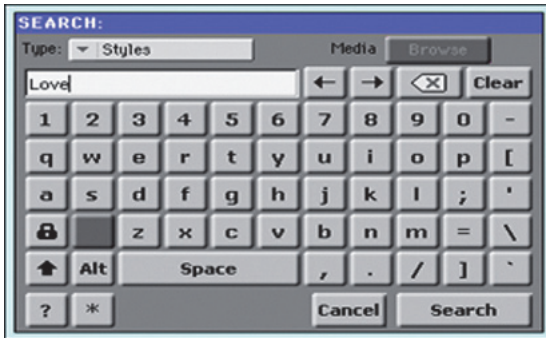

5 When finished entering the name, touch the “Search” button.

After a while, the list of files found begins to appear in the display.

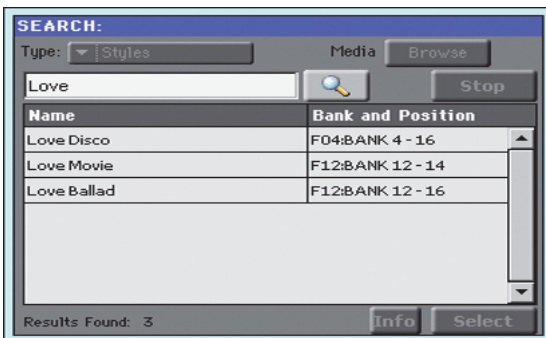

Note: Only one search at a time can be carried on. Please wait for the current search to be completed, or touch the Stop button in the display to stop the current search and do a new one.

After you have touched the “Search” button, its name changes to “Stop”. If needed, touch this button to stop the ongoing search. The name of the button reverts to “Search”. Any file found will remain in the display, until you do a new search.

The time needed to complete a search depends on the size of the device(s) and the number of files.

Hint: You can touch the Cancel button in the display, or press the EXIT button in the control panel, to exit from this window and carry on other operations. The search will continue in the background.

- 6** You can touch one of the found items to select it, and then touch the “Info” button to see information on it.

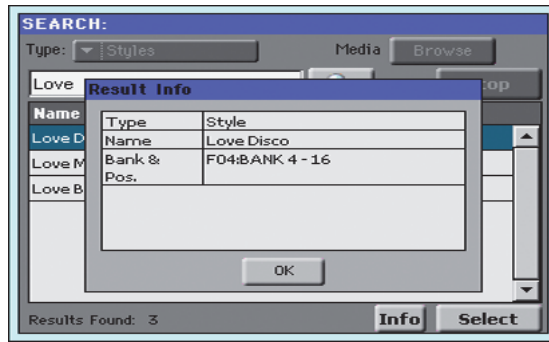

Touch OK to close the Info dialog box.

- 7** If you want to return to the main Search page and type a search string again, touch the  icon. *Otherwise,*
- 8** If you have found what you were looking for, touch its name and then touch the “Select” command.
- 9** You can exit from the Search window at any time, by pressing the EXIT or SEARCH button.

Notes about searching

Wildcards

During search, the string entered will be search as a whole word or as part of a word. For example, if you entered “love”, Pa900 will find “Love” and “LoveSong”, or any other word containing the string “love”.

You can use the wildcards “?” (any single character) and “*” (any sequence of characters) to search exactly that string. For example, “*love” will find “MyLove”, but not “LoveSong”. “??love” will find “MyLove” but not “TrueLove”.

Also, if you are looking for words that can be spelled in a slightly different way, you can use the “?” wildcard to find all occurrences; “gr?y” will find out both “gray” and “grey”.

Appendix

Replacing the clock backup battery

You can replace the clock backup battery with a standard lithium battery (model CR2032). **Do not use replacements different than the one suggested by Korg, or you risk to damage the instrument!** The battery can be replaced by the user. **Korg is not responsible for any data loss, damage or injury caused by the incorrect installation of this part.**

Precautions

- Installation of the battery is done at the user's own risk. Korg will assume no responsibility for any damage or injury resulting from its improper installation or use.
- Be sure to disconnect the instrument from the AC plug, before opening it.
- To prevent your body's static electricity from damaging the board's components, touch an unpainted metallic component before proceeding with the installation.

Installation

For installation, you will need a cross-point and a flat-head screwdrivers (not supplied).

1. Disconnect the instrument from the AC power.
2. From the back of the instrument, use the cross-point screwdriver to remove the fixing screw (a).

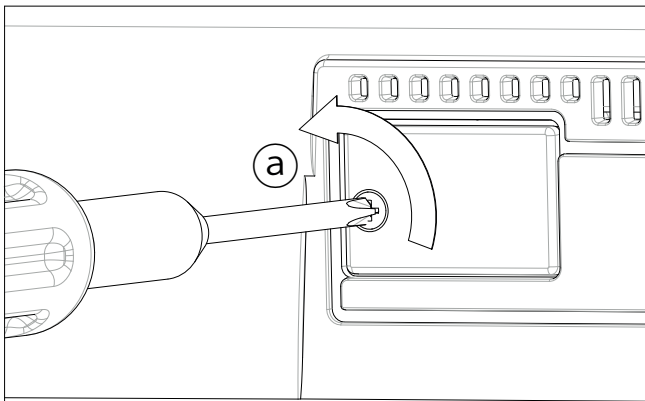

3. Use the flat-head screwdriver to open the cover (b) to gain access to the inside of the battery slot, and keep the cover apart.

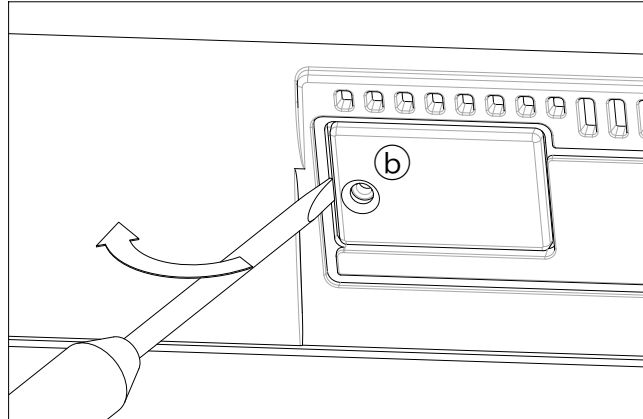

4. With the help of your fingernail, lift the exhausted battery (c) from its lower side, and remove it from the battery slot, being very careful not to let it fall inside the instrument.

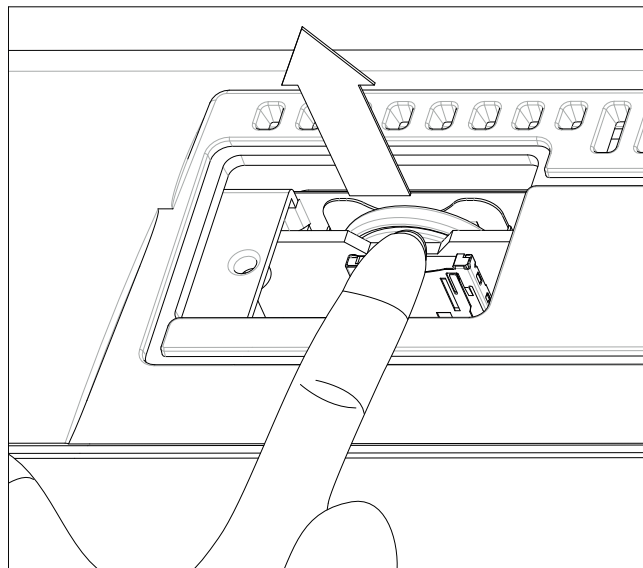

5. Insert the new battery (d) into the empty battery slot, being sure the positive (+) side is facing up. Be very careful not to let it fall inside the instrument.

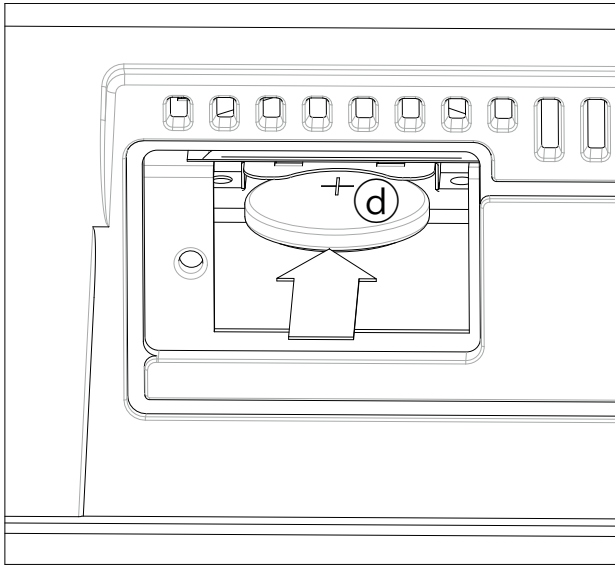

6. Replace the cover (b) to the original position. Attach the cover to the back of the instrument by using the fixing screw (a).

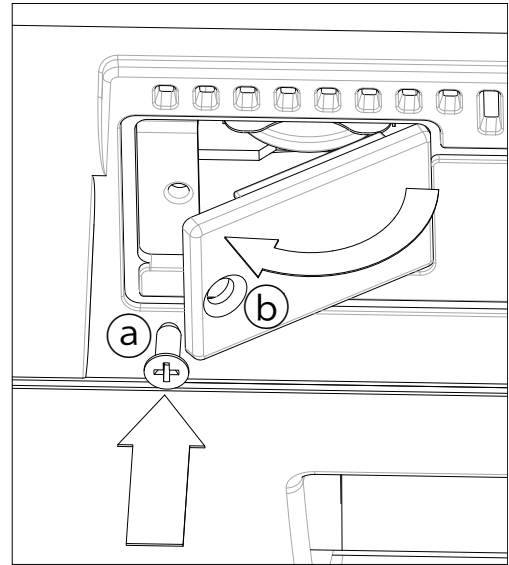

Installing a microSD card

To expand the available onboard memory, you can install an (optional) microSD card inside Pa900. The card can be installed by the user. **Korg is not responsible for any data loss, damage or injury caused by the incorrect installation of this part.**

Precautions

- Be sure to disconnect the instrument from the AC plug, before opening it. **Warning:** Removing or inserting the microSD card while the instrument is connected to the AC plug may damage the instrument!
- To prevent your body's static electricity from damaging the board's components, touch an unpainted metallic component before proceeding with the installation.

Installation

For installation, you will need a cross-point and a flat-head screwdrivers (not supplied).

1. Disconnect the instrument from the AC plug.
2. From the back of the instrument, use the cross-point screwdriver to remove the fixing screw (a).

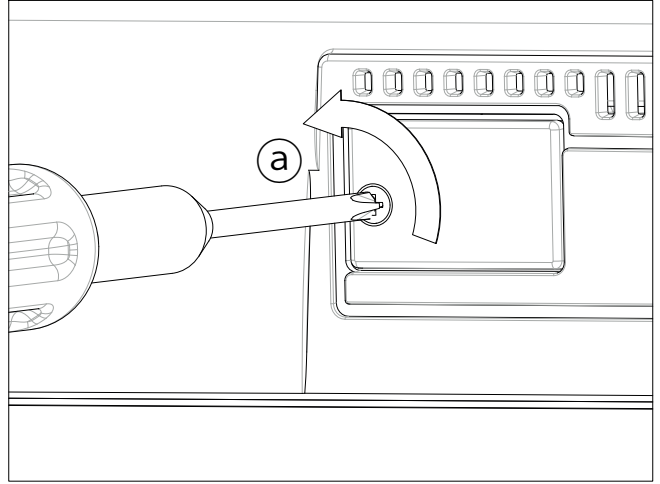

3. Use the flat-head screwdriver to open the cover (b) to gain access to the inside of the microSD slot, and keep the cover apart.

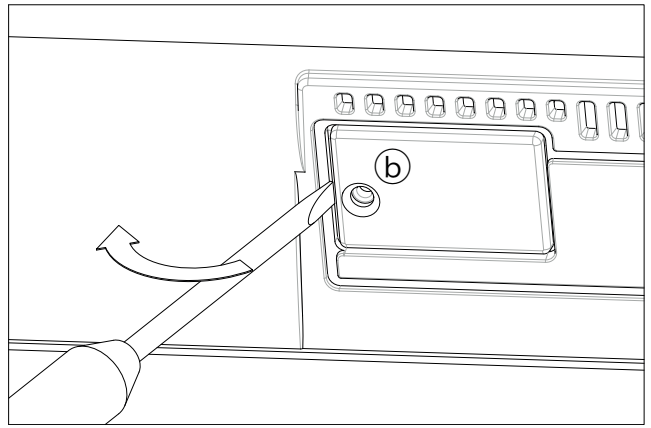

4. Insert the microSD card (c) into the empty card slot, being sure the connector side is facing down and toward the instrument. Gently push the card, until you hear a click sound meaning it is properly inserted. **Warning:** Be sure to insert the card correctly, or it may slip inside the instrument!

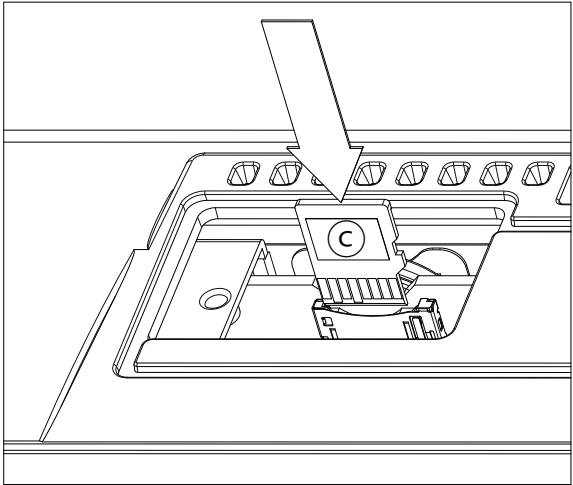

5. Replace the cover (b) to the original position. Attach the cover to the back of the instrument by using the fixing screw (a).

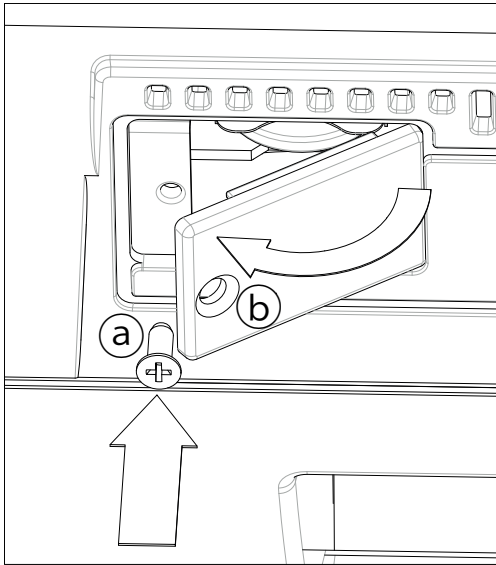

Accessing the microSD card

Once the microSD Key is installed, restart your Pa900. You can access the microSD card from any Media page, by using the Device selector and choosing the “SD [KORG SD]” storage device.

Removal

To extract the microSD card from its slot, just follow the installation instructions in reverse.

Technical specifications

Features	Pa900
Keyboard	61 keys semi-weighted with velocity and aftertouch
System	Upgradable Operating System, RX (Real eXperience), DNC (Defined Nuance Control), Multitasking, Load while play feature
Display	Color TouchView™, 7" TFT display
Tone Generator	KORG EDS (Enhanced Definition Synthesis) sound generator, 128 Voices, 128 Oscillators, Filters with Resonance, Three band EQ for each track
Effects	Up to 4 Stereo Digital Multi-Effects block system, 125 Master Effects types + 2 Global Effects
Voice	Voice Processor Technology by TC Helicon. Three-part Harmonizer, Reverb, Delay, plus Compressor and EQ
Sounds / Drumkits	More than 1100, including Stereo Piano and GM/GS compatibility; more than 70 Drum Kits. User area: 512 Sounds, 128 Drum Kits. Defined Nuance Control (DNC) Technology improved sounds.
Digital Drawbars	9 Footages
Sampling	Load/Import of Korg, Wav, AIFF and Soundfont; Export of Wav and AIFF; Edit, Time Slice PCM User Memory: 192 MB
Styles	More than 400 preloaded Styles, freely reconfigurable, 1200 available Style locations including Favorite and User banks. Eight Style tracks, 4 Single Touch Settings, 4 Pads and one Style Setting per Style, Guitar Track 2 mode, Parallel and Fixed NTT, Style Record with Step Record, Track and Event Edit functions. Style controls: 3 Intros, 4 Variations, 4 Fills, Break, 3 Endings, Synchro Start/Stop, Tap Tempo/Reset, Bass Inversion, Auto Fill, Manual Bass, Memory, Accompaniment Mute, Drum Mapping, Snare & Kick Designation, STS Mode
Chord Sequencer	Realtime Style Chord Sequencer Recorder
Performance	320 Realtime Performance locations, "My Setting" function
STS	Memorize Realtime tracks settings, up to 4 x Style, up to 4 x SongBook entries
Song Play	Patented XDS Crossfade Dual Sequencer Player (supported formats: MID, MID+G, KAR, MP3 + lyrics, MP3+G). 2 Players with separate Select, Start/Stop, Home, Rewind and Fast Forward controls, X-Fader Balance control Lyrics, Score, and Chord data can be displayed on screen, or on external video monitor. Markers, Jukebox function.
MP3 Player / Recorder	Double MP3 Player and MP3 Recorder, Real Time Transpose (+6/-5 semitones), Tempo change (±30%), Vocal Remover. Record MP3 files including Styles, SMF, Real Time Tracks, Pads, Microphone and Effects.
Sequencer	Quick Record (Backing Sequence), Multitrack and Step Record functions. Full-featured Sequencer, 16 tracks; up to 200,000 events, SMF native format
SongBook	Fully programmable music database, based on Styles, SMF, Karaoke, MP3 with automatic selection of Style Play and Song Play modes. User-definable custom lists, Filtering and Ordering options.
Compatibility	i-Series: Styles; Pa-Series: Style, Performance, Program/Sound, Song, SongBook, Pad
Multi Pad	4 Assignable Pads + Stop Button. Pad Record function
General Controls	Master Volume; Fade In/Out; Keyboard-Acc/Song Balance Volume; Ensemble; Octave Transpose; Master Transpose; Style Change; Quarter Tone and Arabic Scale memorized inside Performance/STS; Realtime controllers: Joystick (pitch + modulation), Mic Volume, FX Level; Mic On/Off; Mic Preset; Harmony On/Off; 3 Assignable Switches; Tempo +/-; Tempo Lock; Dial; Search Function; Shift; Chord Scan; Split; Metronome On/Off; Sound Select
Control Inputs	Damper (supports half-pedaling with the optional DS-1H pedal), Assignable Pedal/Footswitch
Clock	Internal System Clock
Mass Storage/Disk	SSD standard; microSD (optional, back panel slot)
MIDI	In, Out; Standard MIDI connectors; USB to MIDI using the USB Device port. 8 user-definable MIDI Setups
Video Out	RCA connector
USB	1 USB Host (front) and 1 USB Device (rear), 2.0 Hi Speed connections
Mic/Line Audio Inputs	2 Unbalanced Jacks; Left/Mono-Mic, with gain control and Right/Mono
Audio Outputs	2 Unbalanced Jacks; Left/Mono, Right/Mono Headphones (in the front panel)
Amplification	2 x 20 Watt; 2 x 100 mm Woofer in Bass Reflex Box and 2 x Tweeter
Consumption	20 Watt; 100-240 V 50/60 Hz
Dimensions (W x D x H)	1030 x 378.3 x 138.8 mm / 40.55 x 14.89 x 5.46 inches (without music stand)
Weight	10.76 kg / 23.72 lbs
Accessories	Printed Manual, AC Power Cable, Music Stand, DVD-ROM
Options	EXP-2 - Expression/Volume Pedal, XVP-10 - Professional Expression/Volume Pedal, DS-1H - Damper Pedal, PS-1/PS-3 Switch Pedal

Specifications and appearance are subject to change without notice for improvement.

MIDI Implementation Chart

KORG Pa900
OS Version 1.0 - March 01, 2013

Function		Transmitted	Recognized	Remarks
Basic Channel	Default	1-16	1-16	Memorized
	Changed	1-16	1-16	
Mode	Default		3	
	Messages	X	X	
	Altered	*****		
Note Number:		0-127	0-127	
	True Voice	*****	0-127	
Velocity	Note On	O 9n, V=1-127	O 9n, V=1-127	
	Note Off	O 8n, V=0-127	O 8n, V=0-127	
Aftersustain	Poly (Key)	O	O	Player data only *1
	Mono (Channel)	O	O	*1
Pitch Bend		O	O	
Control Change	0, 32	O	O	Bank Select (MSB, LSB) *1
	1, 2	O	O	Modulations *1
	6	O	O	Data Entry MSB *1
	38	O	O	Data Entry LSB *1
	7, 11, 16	O	O	Volume, Expression, Ribbon *1
	10, 91, 93	O	O	Panpot, A/B Master FX Send *1
	64, 66, 67	O	O	Damper, Sostenuto, Soft *1
	65, 5	O	O	Portamento On/Off, Portamento Time *1
	71, 72, 73	O	O	Harmonic Content, EG time (Release, Attack) *1
	74, 75	O	O	Brightness, Decay Time *1
	76, 77, 78	O	O	Vibrato Rate, Depth, Delay *1
	98, 99	O	O	NRPN (LSB, MSB) *1, 2
	100, 101	O	O	RPN (LSB, MSB) *1, 3
	120, 121	X	O	All sounds off, Reset all controllers *1
Program Change		O 0-127	O 0-127	*1
	True #	*****	0-127	
System Exclusive		O	O	*4
System Common	Song Position	X	X	
	Song Select	X	X	
	Tune	X	X	
System Real Time	Clock	O	O	*5
	Commands	O	O	*5
Aux Messages	Local On/Off	X	X	
	All Notes Off	X	O (123-124)	
	Active Sense	O	O	
	Reset	X	X	
Notes	*1: Sent and received when MIDI Filters In and Out are set to Off in Global mode. *2: Drawbar settings, Drawbars settings, Sound parameters, Selection of SongBook entries, Drum Kit Family settings. *3: LSB, MSB = 00,00: Pitch Bend range, =01,00: Fine Tune, =02,00: Coarse Tune. *4: Includes Inquiry and Master Volume messages, FX settings, Quarter Tone settings. GM Mode On. *5: Transmitted only when the Clock Send parameter (Global mode) is set to on.			

Mode 1:OMNI ON, POLY
Mode 3:OMNI OFF, POLY

Mode 2:OMNI ON, MONO
Mode 4:OMNI OFF, MONO

O: Yes
X: No

KORG

Address

KORG ITALY SpA
Via Cagiata, 85
I-60027 Osimo (An)
Italy

Web

www.korg.com
www.korg.co.jp

PART NUMBER: MAN0010048

© KORG Italy 2013. All rights reserved

