

**ALLEN & HEATH**

GLSERIES



**GL2800M**

16 MIX WEDGE / IEM MONITOR CONSOLE

**USER GUIDE**

Publication AP6690

## **Limited One Year Warranty**

---

This product is warranted to be free from defects in materials or workmanship for a period of one year from the date of purchase by the original owner.

To ensure a high level of performance and reliability for which this equipment has been designed and manufactured, read this User Guide before operating. In the event of a failure, notify and return the defective unit to Allen & Heath Limited or its authorised agent as soon as possible for repair under warranty subject to the following conditions

### **Conditions Of Warranty**

---

1. The equipment has been installed and operated in accordance with the instructions in this User Guide
2. The equipment has not been subject to misuse either intended or accidental, neglect, or alteration other than as described in the User Guide or Service Manual, or approved by Allen & Heath.
3. Any necessary adjustment, alteration or repair has been carried out by Allen & Heath or its authorised agent.
4. This warranty does not cover fader wear and tear.
5. The defective unit is to be returned carriage prepaid to Allen & Heath or its authorised agent with proof of purchase.
6. Units returned should be packed to avoid transit damage.

In certain territories the terms may vary. Check with your Allen & Heath agent for any additional warranty which may apply.



This product complies with the European Electromagnetic Compatibility directives 89/336/EEC & 92/31/EEC and the European Low Voltage Directives 73/23/EEC & 93/68/EEC.

This product has been tested to EN55103 Parts 1 & 2 1996 for use in Environments E1, E2, E3, and E4 to demonstrate compliance with the protection requirements in the European EMC directive 89/336/EEC. During some tests the specified performance figures of the product were affected. This is considered permissible and the product has been passed as acceptable for its intended use. Allen & Heath has a strict policy of ensuring all products are tested to the latest safety and EMC standards. Customers requiring more information about EMC and safety issues can contact Allen & Heath.

**NOTE:** Any changes or modifications to the console not approved by Allen & Heath could void the compliance of the console and therefore the user's authority to operate it.

GL2800M User Guide AP6690 Issue 2

Copyright © 2007 Allen & Heath Limited. All rights reserved

**ALLEN&HEATH** Limited

Kernick Industrial Estate, Penryn, Cornwall, TR10 9LU, UK  
<http://www.allen-heath.com>

## Important Safety Instructions

**WARNINGS - Read the following before proceeding :**

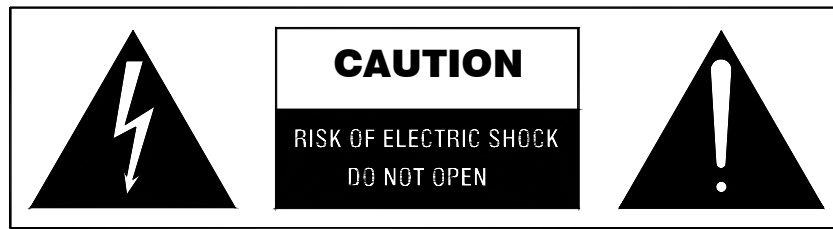

**ATTENTION: RISQUE DE CHOC ELECTRIQUE – NE PAS OUVRIR**

**Read instructions:** Read and retain these safety and operating instructions for future reference. Adhere to all warnings printed here and on the console. Follow the operating instructions printed in this User Guide.

**Do not remove cover:** Operate the console and power units with their covers correctly fitted. Disconnect mains power by unplugging the power cord if the cover needs to be removed for setting internal options. Refer this work to competent technical personnel only.

**Power sources:** Connect the console to a mains power outlet only of the type described in this User Guide and marked on the rear panel. Use the power cord with sealed mains plug appropriate for your local mains supply as provided with the console. If the provided plug does not fit into your outlet consult your service agent for assistance.

**Power cord routing:** Route the power cord so that it is not likely to be walked on, stretched or pinched by items placed upon or against it.

**Grounding:** Do not defeat the grounding and polarisation means of the power cord plug. Do not remove or tamper with the ground connection in the power cord.



**WARNING: This equipment must be earthed.**

**Water and moisture:** To reduce the risk of fire or electric shock do not expose the console or its power units to rain or moisture or use in damp or wet conditions. Do not place containers of liquids on surfaces where liquid may spill into any openings.

**Ventilation:** Do not obstruct the power supply heatsinks and ventilation slots or position the console where the air flow required for ventilation is impeded. If the console is to be operated in a flight case, plinth or other furniture ensure that it is constructed to allow adequate ventilation.

**Heat and vibration:** Do not locate the console in a place subject to excessive heat or direct sunlight as this could be a fire hazard. Locate the console away from any equipment which produces heat or causes excessive vibration.

**Servicing:** Switch off the equipment and unplug the power cord immediately if it is exposed to moisture, spilled liquid, objects fallen into the openings, the power cord or plug become damaged, during lightning storms, or if smoke, odour or noise is noticed. Refer servicing to qualified technical personnel only.

**Installation:** Install the console in accordance with the instructions printed in this User Guide. Do not connect the output of power amplifiers directly to the console. Use audio connectors and plugs only for their intended purpose.

## General Precautions

**Damage** To prevent damage to the controls and cosmetics avoid placing heavy objects on the control surface, scratching the surface with sharp objects, or rough handling and vibration.

**Environment** Protect from excessive dirt, dust, heat and vibration when operating and storing. Avoid tobacco ash, smoke, drinks spillage, and exposure to rain and moisture. If the console or its power unit becomes wet, switch off and remove mains power immediately. Allow to dry out thoroughly before using again.

**Cleaning** Avoid the use of chemicals, abrasives or solvents. The control panel is best cleaned with a soft brush and dry lint-free cloth. The faders, switches and potentiometers are lubricated for life. The use of electrical lubricants on these parts is not recommended. The fader and potentiometer knobs may be removed for cleaning with a warm soapy solution. Rinse and allow to dry fully before refitting them.

**Lifting** To avoid injury to yourself or damage to the equipment take care when lifting, moving or carrying the console.

**Transporting** The console may be transported as a free-standing unit or mounted in a purpose built flight case. We recommend that the console is surrounded by shock absorbent foam to protect it from damage during transit. Always use adequate packing if you need to ship the unit. Protect the controls to avoid damage when moving the console.

**Hearing** To avoid damage to your hearing do not operate any sound system at excessively high volume. This also applies to any close-to-ear monitoring such as headphones and IEM transducers. Continued exposure to high volume sound can cause frequency selective or wide range hearing loss.



### Important Mains plug wiring instructions.

The console is supplied with a moulded mains plug fitted to the AC mains power lead. Follow the instructions below if the mains plug has to be replaced. The wires in the mains lead are coloured in accordance with the following code:

TERMINAL		WIRE COLOUR	
		European	USA/Canada
L	LIVE	BROWN	BLACK
N	NEUTRAL	BLUE	WHITE
E	EARTH GND	GREEN & YELLOW	GREEN

The wire which is coloured Green and Yellow must be connected to the terminal in the plug which is marked with the letter E or with the Earth symbol. **This appliance must be earthed.**

The wire which is coloured Blue must be connected to the terminal in the plug which is marked with the letter N.

The wire which is coloured Brown must be connected to the terminal in the plug which is marked with the letter L.

Ensure that these colour codes are followed carefully in the event of the plug being changed.

# Introduction

---

Welcome to the Allen & Heath **GL2800M**, the dedicated monitor version of the popular GL series live sound mixing consoles. We have tried to keep this user guide brief and to the point. Please read it fully before starting. Included is information on installing, connecting and operating the console, panel drawings, system block diagram and technical specification. For further information on the basic principles of audio system engineering, please refer to one of the specialist publications and resources available from bookshops, audio equipment dealers and the Internet.

Whilst we believe the information in this guide to be reliable we do not assume responsibility for inaccuracies. We also reserve the right to make changes in the interest of further product development.

We are able to offer further product support through our world-wide network of approved dealers and service agents. You can also access our Web site on the Internet for information on our full product range, resource downloads, our company pedigree, contact details, assistance with your technical queries, or simply to chat about audio. To help us provide the most efficient service please keep a record of your console serial number, and date and place of purchase to be quoted in any communication regarding this product.

<http://www.allen-heath.com>

<http://www.glseries.com>

---

## Contents

---

Warranty .....	2
Important Safety Instructions .....	3
General Precautions.....	4
Introduction to this Guide.....	5
Panel Layouts.....	6
System Block Diagram.....	7
Dimensions and Installation.....	8
Introducing the <b>GL2800</b> .....	9
Connecting Power.....	9
Audio Connections.....	10
Mono Input Channel .....	11
16 Mix Sends.....	12
Mix Masters .....	13
Engineers Monitor System.....	14
Engineers Toolbox .....	15
Applications and Operating Tips .....	16
Specifications .....	21
Cue Sheets.....	22

# GL2800M

16 MIX WEDGE / IEM MONITOR CONSOLE

## CONSOLE CONFIGURATION

SELECT USING A POINTED OBJECT

**A**  ON OSC/NOISE GENERATOR ENABLE

**B**  LATCH TALK SWITCH OVERRIDE

**C**  FOLLOW HEADPHONES SOURCE  
 AFL / PFL  
 FOLLOW IEM MONITOR

**MIX 1-8 CONFIGURE**

**D**  POST PRE PRE/POST FADER

**E**  MONO STEREO STEREO (LEV/PAN)

**F**  AFL WEDGE IEM AFL ROUTING

**MIX 9-12 CONFIGURE**

**G**  POST PRE PRE/POST FADER

**H**  MONO STEREO STEREO (LEV/PAN)

**I**  AFL WEDGE IEM AFL ROUTING

**MIX 13-16 CONFIGURE**

**J**  POST PRE PRE/POST FADER

**K**  MONO STEREO STEREO (LEV/PAN)

**L**  AFL WEDGE IEM AFL ROUTING

**M**  PFL ON PFL TO WEDGE MONITOR ENABLE

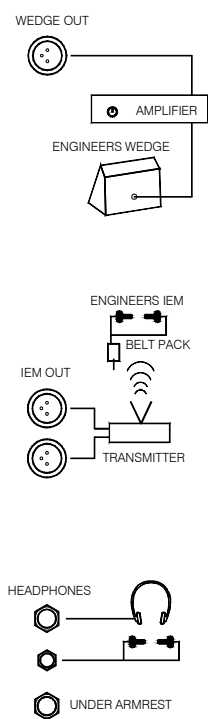

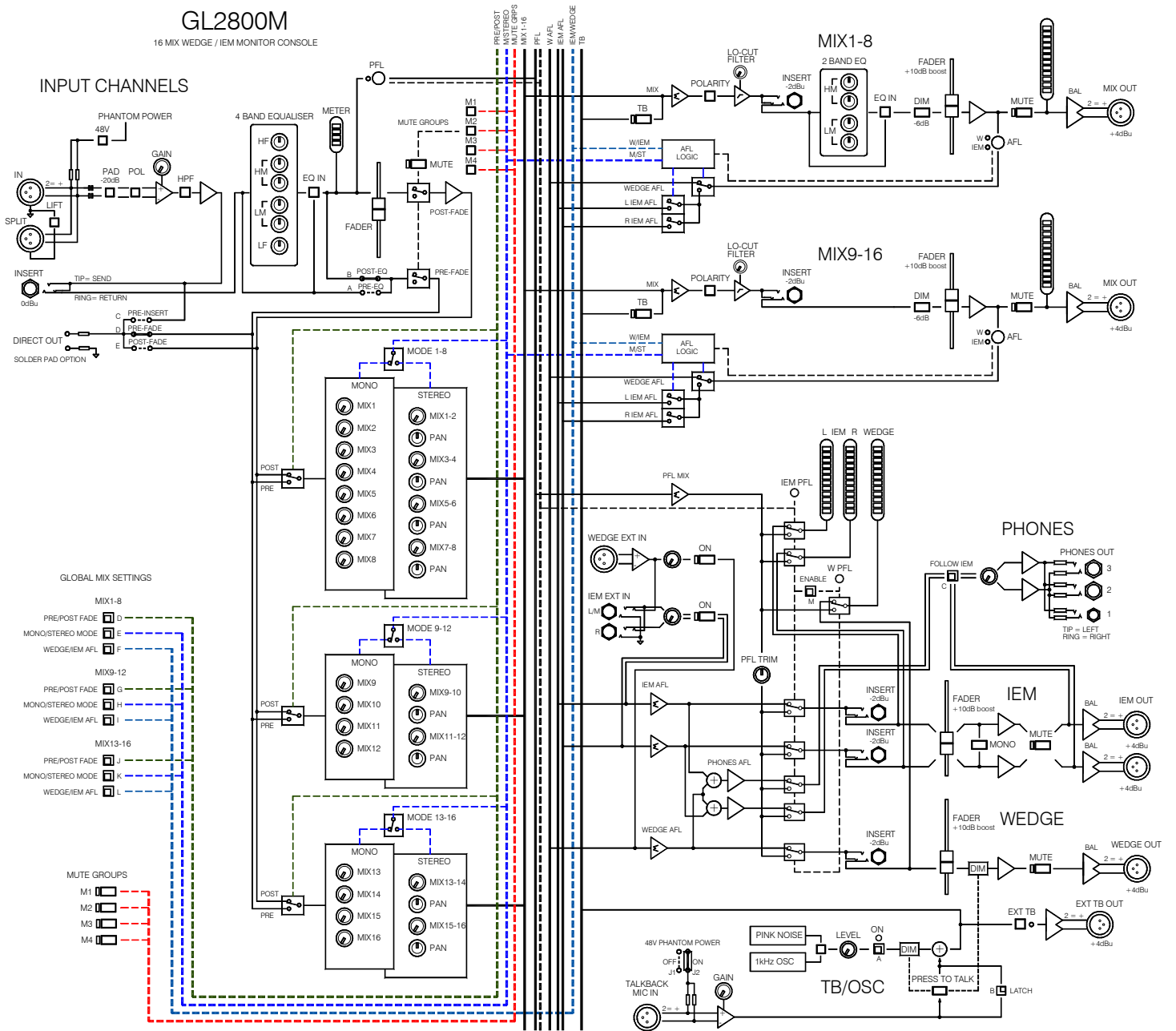
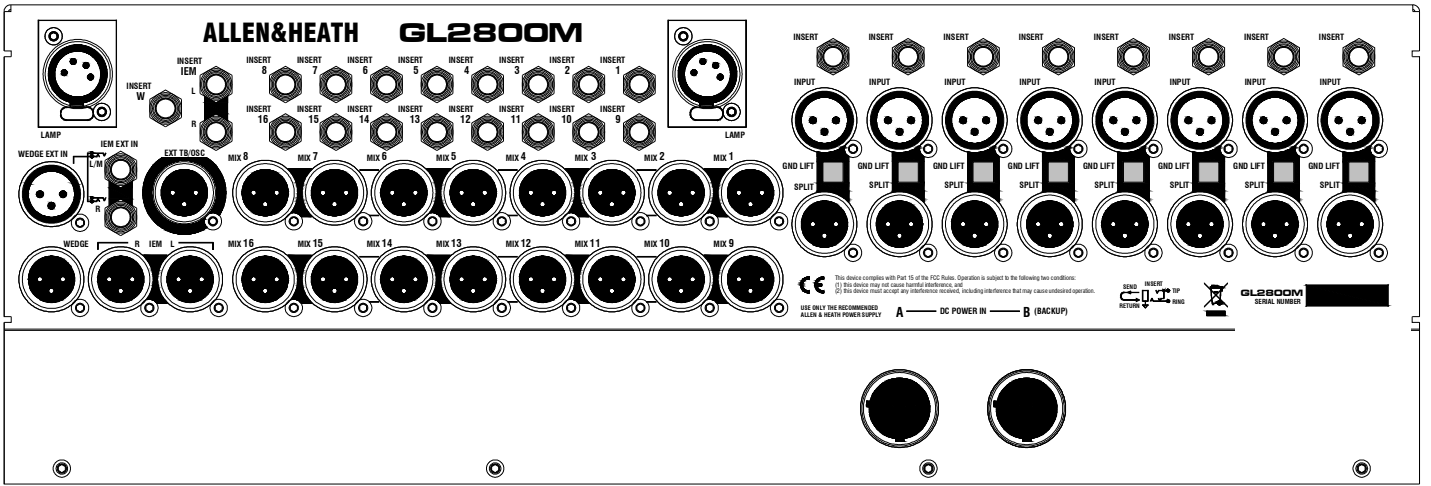

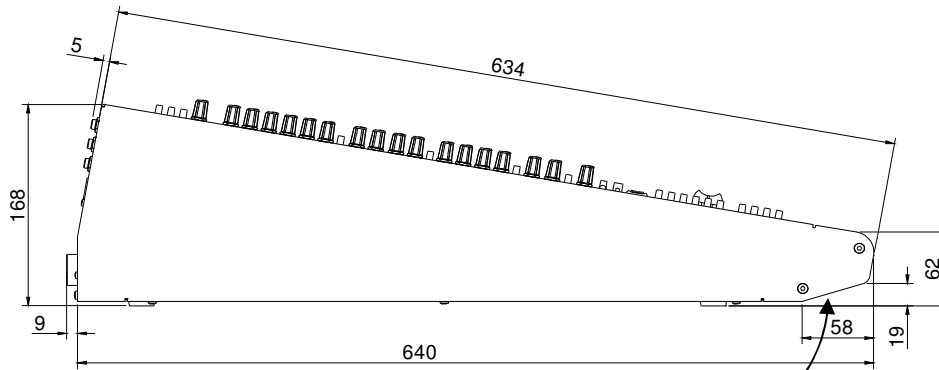
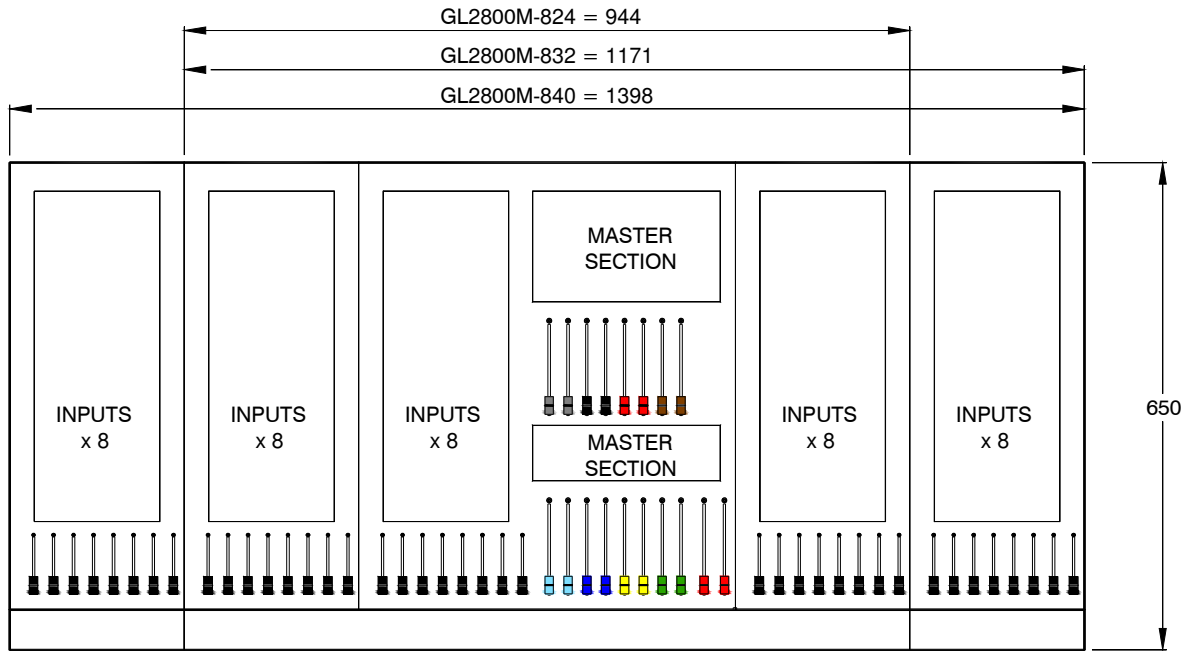

Allow access to additional under-armrest headphone socket

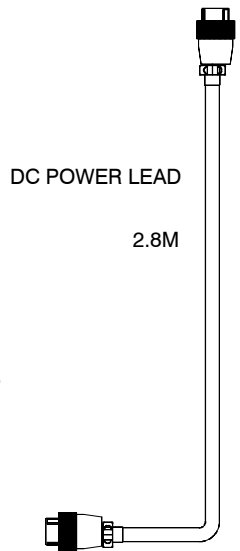

DC POWER LEAD  
2.8M



**Do not obstruct the heatsinks or ventilation openings on the power unit. Ensure adequate air flow around its surfaces. To avoid audible hum, buzz or other performance degradation, do not place equipment that radiates strong electromagnetic fields such as the power unit, other mains power supplies, amplifiers and computers next to or directly underneath the console.**

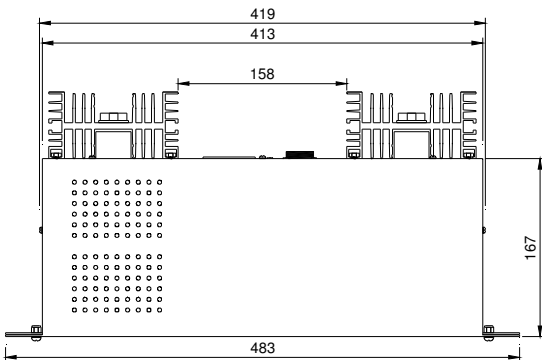

RPS11 Rack Mount Power Supply

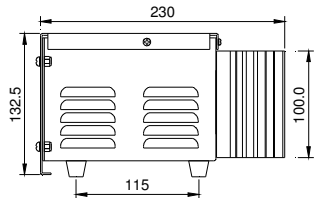
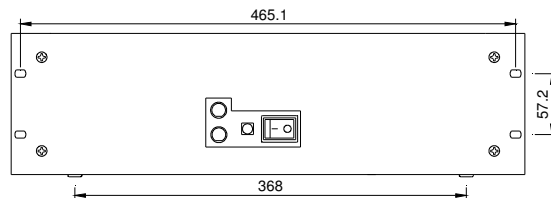

	Width	Depth	Height	Weight
GL2800-824	944mm (37.2")	650mm (25.6")	170mm (6.7")	29 kg (63.8 lbs)
GL2800-832	1171mm (46.1")	650mm (25.6")	170mm (6.7")	35 kg (77 lbs)
GL2800-840	1398mm (55")	650mm (25.6")	170mm (6.7")	41 kg (90.2 lbs)
RPS11 PSU	482.6mm (19")	235mm (9.25")	135mm (5.31")	9.5 kg (21 lbs)



# Introducing the Allen & Heath **GL2800M**

The monitor application has grown dramatically in recent times with the evolution of multiple wedge and stereo in-ear systems which can quickly exceed the mix capability of all but the most expensive consoles. The **GL2800M** adds a fully featured yet affordable dedicated monitor console to the popular GL Series live sound range. It is compact, easy to use, offers the best of analogue reliability and sound, and has a capability that rivals that of much bigger and more expensive consoles. Mechanically similar to the **GL2800** with its solid, individual card, nutted pot construction, it has the same space saving footprint and flight case outline, includes a built-in mic splitter and provides no fewer than 16 mixes plus a comprehensive dual output engineer's wedge/IEM monitoring system.

- 24, 32, 40 and 48 channel frame sizes
- 16 mixes globally assigned as mono or stereo with level and pan
- Built-in passive mic splitter with ground lift switching
- All masters include polarity switch, swept HPF and 6dB dim function
- Mix 1-8 include 2 band swept frequency output EQ
- Engineer's IEM and wedge monitors with faders, meters, inserts and XLR
- IEM/wedge monitor external inputs for FOH comms and IEM rack monitoring
- Mix AFL assignable to either wedge or IEM monitor
- PAFL logic includes PFL override AFL, mono/stereo AFL, PFL to wedge enable
- Headphones follow IEM mode, includes ¼" and 3.5mm jacks
- Talkback with independent selection to all mixes and external output
- Talk latch mode for use with switched hand held talkback mic
- Built-in oscillator/ pink noise generator assignable to any mix output
- Built-in dual supply combiner for additional power supply as a backup
- 4 mute groups
- Solid individual card, nutted pot construction in a no nonsense all steel chassis

## Connecting Power

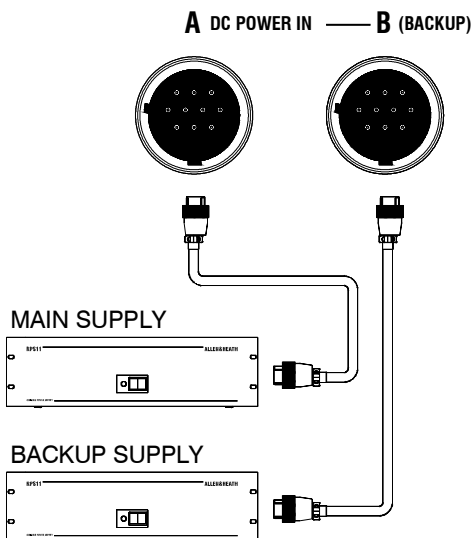

**Read the safety instructions** provided with this console, and the warnings printed on the rear of the console and **RPS11** power unit. Check that your local mains supply voltage is the same as that marked on the rear of the power unit.

**Grounding** For safety it is important that all equipment grounds are connected to mains ground so that exposed metal parts are prevented from carrying high voltage which can injure or even kill the operator. Do not disconnect the ground connection in the mains lead.

**Connect the DC power lead** between the "DC OUT" on the **RPS11** and the "DC POWER IN A" on the **GL2800M**.

**Backup power supply** A second "B (BACKUP)" socket is included for plugging in an optional backup **RPS11** power supply. This provides the reassurance of power supply dual redundancy. The console uses diode combining technology so that both supplies can be powered at the same time. One will automatically take over should the other be switched off or stop working.

**Switching the console on** Turn the power amplifiers off before switching the console and any other connected equipment on or off. This prevents any unexpected clicks or thumps when the equipment is powered up.

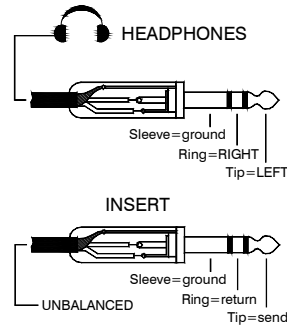
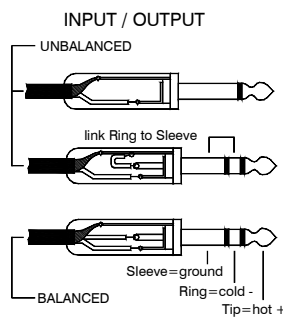
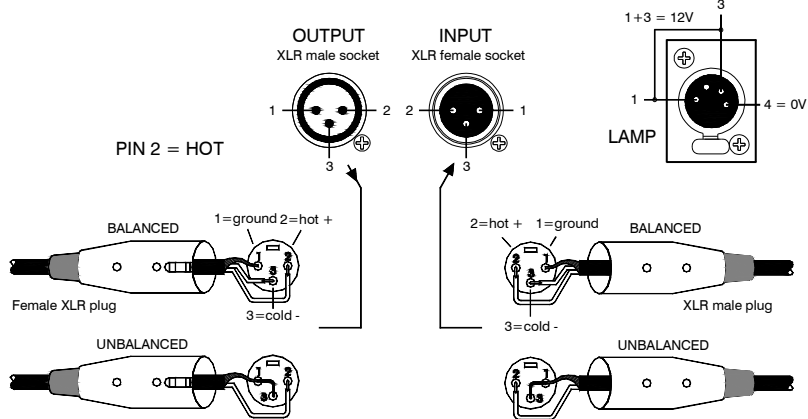
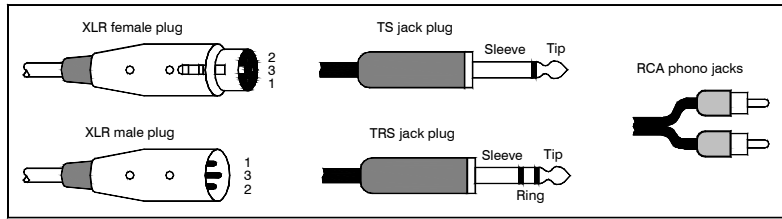

**Y-Adapter**  
2 Outputs to 1 Input

No !

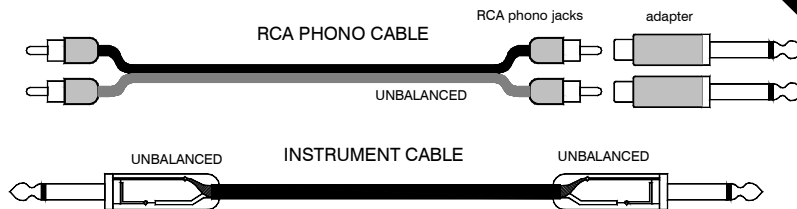

**Y-Adapter**  
1 Output to 2 Inputs

Yes

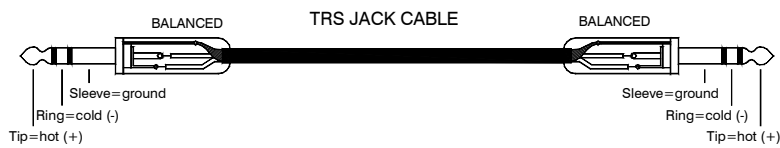

**TO INPUT**

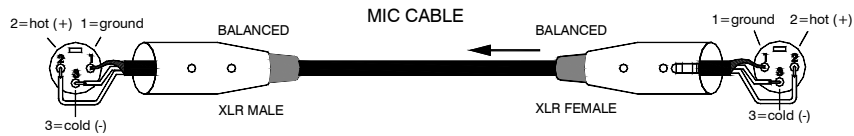

**FROM OUTPUT**

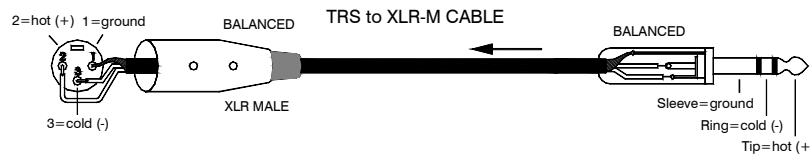
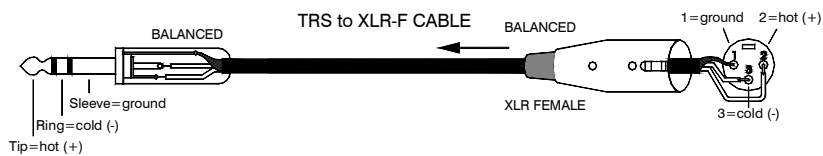

# The Input Channel

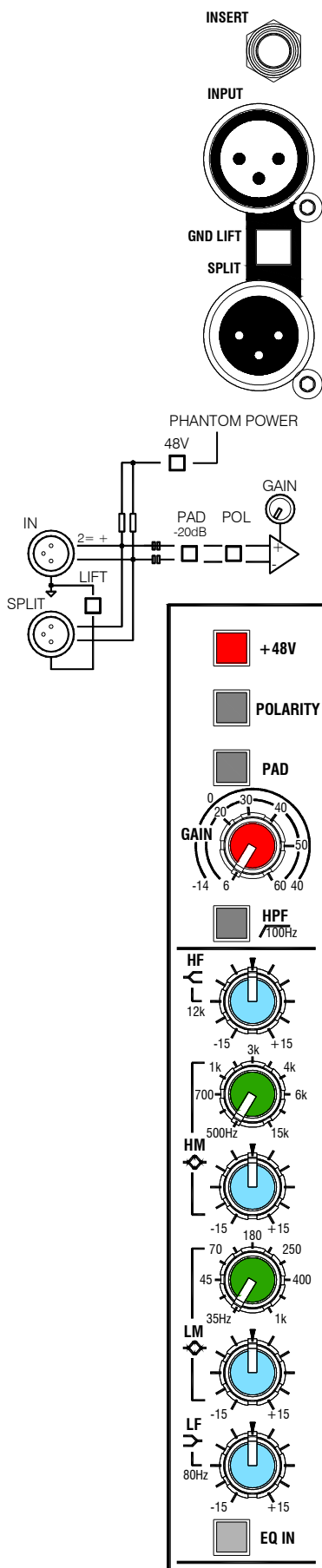

**CHANNEL INPUT** Balanced XLR input pin 2 hot. Accepts mic or line level signals. For unbalanced sources use a cable or adapter that connects XLR pin 3 to pin 1.

**CHANNEL PREAMP** 54dB gain range with 20dB pad to accept signals from -60dBu to +14dBu nominal. Press PAD for hot signals up to +34dBu max. Press HPF to switch in a 12dB/octave 100Hz lo cut filter. Press POLARITY to invert the signal for working with a pin 3 hot source, correcting a reverse wired cable, bottom miking a snare drum and so on. Reversing polarity may help certain situations where feedback is a problem.

**PHANTOM POWER** Press +48V for phantom power via 6.8k ohm resistors to pins 2 and 3 for microphones such as condensers which require phantom powering.

**WARNING:** Do not connect unbalanced sources or cables to the XLR input when 48V phantom power is selected. To avoid loud clicks always turn the channel off by pressing MUTE when switching +48V on or off, and when plugging or unplugging cables.

If you are working with separate monitor and FOH consoles then phantom power may be supplied by either or both consoles without damage. Typically the monitor console provides the power because the monitor engineer would be closer to the stage patch.

**BUILT-IN MIC SPLITTER** Passes the XLR input through to an XLR output to split the signal to another console such as FOH or recording. This is a passive split. The **GL2800M** does not need to be turned on for the split to work.

**GND LIFT** Disconnects the pin1 ground connection between the input XLR and the split output XLR. Press this if there is a problem with a venue ground loop causing audible hum when connecting the splitter to a second console. To isolate the audio ground between the consoles make sure you select all the channel ground lift switches.

**INSERT** A single 3-pole TRS jack carries the unbalanced insert signal for each channel and main mix output. Tip = send, Ring = return, Sleeve = common ground. The channel inserts are post-HPF, pre-EQ and operate at 0dBu. Use these to patch in line level signal processing equipment such as compressors, gates or outboard EQ. The wiring of a suitable cable is shown in the diagram.

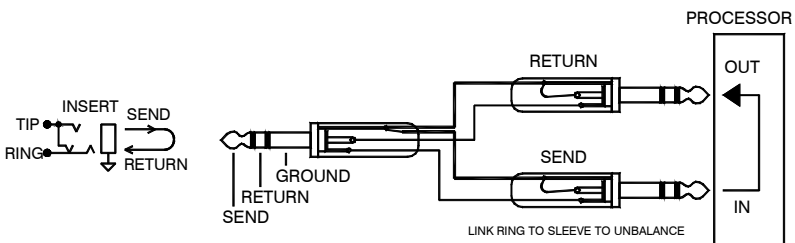

**EQ** 4 band channel EQ with swept frequency mids. The EQ is post-insert so that any inserted processing will be affected by these controls. The channel pre-fade aux sends are configured post-EQ as standard.

# The 16 Channel Mix Sends

The **GL2800M** features 16 mixes (aux sends). These are used for combinations of stage wedge and in-ear monitor sends. The controls are colour coded in pairs to quickly identify each mix. The mixes may be configured as mono or stereo, and pre or post the channel trim fader according to your requirement.

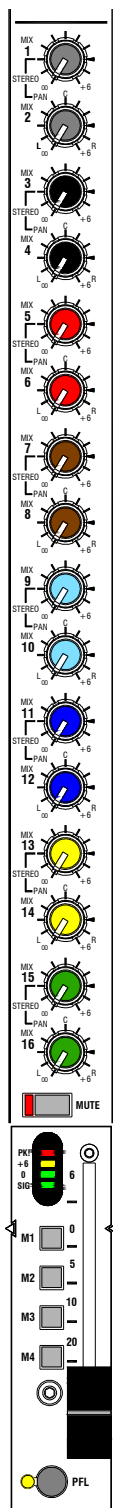

## GLOBAL SETTINGS



### MIX 1-8

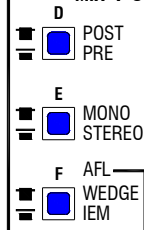

### MIX 9-12

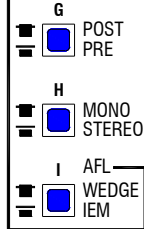

### MIX 13-16

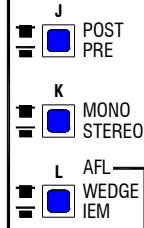

**WEDGE or IEM, MONO or STEREO ?**

Before starting, configure how you want the console to work by setting the GLOBAL SETTINGS switches in the master section. These are identified with the letters 'D' to 'L'. Use a pen or pointed object to set these recessed switches. The 16 mixes may be configured in groups of 8, 4 and 4 to satisfy many combinations:

**POST / PRE** Default is post-fade mix (aux) send. Select this switch to change to pre-fade.

**MONO / STEREO** Default is mono send. Select this switch to change to stereo send with separate pairs of level and pan controls. Start with the pan controls set to their centre detented position.

**WEDGE / IEM AFL** Each master AFL switch routes to either the engineer's wedge or in-ear monitor. Default is AFL routed to the wedge monitor. Select this switch to route AFL to the engineer's IEM monitor.

**MIX SENDS** These rotary controls adjust how much channel signal is mixed to each of the console outputs. They adjust from fully off to +6dB boost. Unity gain 0dB is marked at 3 o'clock position. Every second control has a centre detent for operation as PAN when in stereo mode.

**MUTE** Turns off all sends including pre and post fader. Does not affect the channel insert.

**FADER** This is the channel trim control. Set to unity '0' position for normal operation. This is clearly marked with a pointer. The fader allows adjustment affecting all post-fade sends from the channel. +6dB boost is provided above '0'.

**PFL** Press PFL to listen to the pre-fade channel signal in the engineer's monitor without affecting the mix outputs. Selecting more than one PFL at the same time mixes those signals together in the monitor. PFL overrides any current mix AFL selection.

**METER** A 4 LED channel meter displays the pre-fader signal level. 'SIG' lights when a signal level of -12dBu is detected. '0' lights when the nominal 0dBu level is reached, and '+6' at +6dBu. 'PK' lights when the channel pre-fade signal is within 5dB of clipping. This gives you enough warning to reduce GAIN before you hear signal distortion.

**MUTE GROUPS** Press these switches to add the channel to Mute Groups 1 to 4 as required. Press the master mute switch to mute all channels assigned to that group.

### STEREO (LEV/PAN)

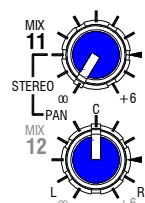

### MON (2x LEV)

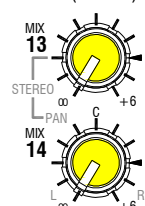

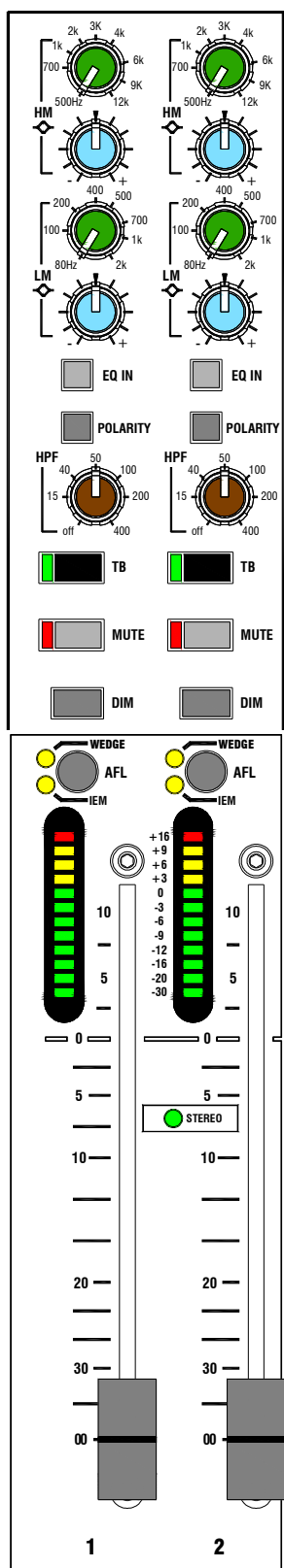

**OUTPUT EQ** (MIX 1-8 only) 2 band swept frequency peak/dip EQ with in/out switch. Use this to adjust the overall sound of the mix, for example to satisfy the preference of a performer using in-ears, or to notch out wedge speaker feedback when an outboard EQ is not available.

**POLARITY** Reverses the signal +/- polarity of the output. Start with the switch in its up (non-inverted) position. Pressing the switch for reversed polarity can help in situations where speaker wiring errors, phasing effects or feedback is experienced on stage. Use the console pink noise generator to help identify speaker polarity and interaction problems.

**HPF** Swept frequency 12dB/octave high pass (low cut) filter affecting the mix output. Adjust from off (full response) to 400Hz. Cutting the low frequency response of wedge monitor speakers can help clean up the stage sound and avoid wasting amplifier power on low end sounds and bleed not needed in the monitors.

**TB** Enables the talkback / oscillator to the mix output. You can talk to or route the oscillator/noise generator to any combination of mix outputs using these switches.

**MUTE** Turns off the mix output. Affects the meter but does not affect the mix AFL function.

**DIM** This momentary switch lets you attenuate the mix output level by 6dB (half volume) while holding it pressed. This can help you quickly identify and stop a monitor speaker feedback, or reduce volume without moving the fader while you are talking to a performer on stage.

**AFL** Routes the post-fade pre-mute mix output to the engineer's monitor system. Depending on the configuration of the GLOBAL SETTINGS switches, AFL feeds the console headphones monitor and either the engineer's wedge speaker or the IEM (in-ear) monitor output. The associated yellow LED indicates which monitor is being fed. If two mixes are configured as a stereo pair, pressing one AFL checks that mix in mono, and pressing both AFL together checks the mix in stereo in the headphones and IEM monitors.

**METER** 12 LED bar output meter displays the signal at the mix output XLR. Meter '0' = XLR +4dBu output.

**STEREO INDICATOR** Green LED lights when the pair of mixes have been configured for stereo operation using the GLOBAL SETTINGS switches. In stereo mode, the associated channel sends operate as level and pan controls, and AFL can provide L only, R only or stereo LR checking of the mix.

**FADER** A 100mm fader provides accurate control of the mix output.

**INSERT** Each mix is provided with an insert socket for patching in an outboard signal processor. When working with stage speakers this is typically a 31 band graphic or a multi band parametric EQ used for ringing out feedback or tuning the speaker response. When working with in-ear systems this may be a dynamics processor with limiter to protect the ears of the IEM user. AFL monitors the signal after the insert so that the engineer can listen to the effect of the processor. A single 3-pole TRS jack carries the unbalanced insert signal for each mix output. Tip = send, Ring = return, Sleeve = common ground. The insert is post-HPF and pre-EQ, pre-fader and operates at a nominal -2dBu line level.

# The Engineer's Monitor System

The **GL2800M** provides three independent engineer's monitor outputs. By setting configuration switches the engineer can listen to each mix the way the performer hears it.

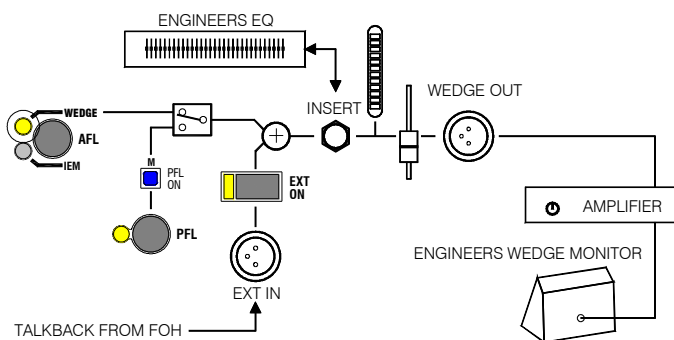

**MONO WEDGE OUTPUT** To feed a wedge speaker monitor placed next to the console. Use the same type of speaker as those used for the monitors on stage so that the engineer can check the signal as it is heard by the performers. Includes a pre-fade insert for patching in an outboard EQ to let the engineer experiment with EQ changes before adjusting the associated mix EQ heard by the performer. Any mix AFL configured as WEDGE using the GLOBAL SETTINGS switches will be routed here. PFL overrides AFL in the wedge output if the recessed PFL ON enable switch has been set. An external input lets you add another signal such as talkback from FOH or a prompt back to the monitor engineer.

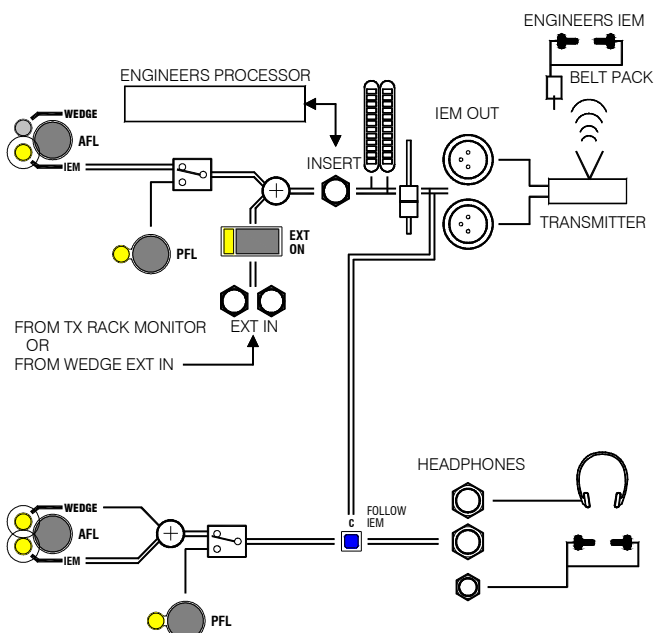

**STEREO IEM OUTPUT** To feed the engineer's in-ear monitoring system, typically a wireless IEM similar to those used by the performers. In situations where IEMs are not being used the output could be connected to feed a stereo wedge monitor instead. Includes a pre-fade insert for patching in an outboard processor to let the engineer try out changes before adjusting the associated mix processor heard by the performer. Any mix AFL configured as IEM using the GLOBAL SETTINGS switches will be routed here. PFL always overrides AFL in the IEM output. An external input lets you select another signal such as a monitor return from a wireless in-ear transmitter rack. The wedge ext input normals through the TRS input sockets for FOH talkback to the in-ears if nothing is plugged in.

**HEADPHONES** AFL interrupted by PFL. The wedge and IEM AFL signals are summed to feed the headphones output. A recessed mode switch changes the headphones source to follow the IEM output instead. This provides a headphones output for the IEM monitor, complete with two 1/4" and one 3.5mm sockets ideal for plugging in a variety of headphones including in-ear transducers.

**XLR OUTPUTS** Differential balanced pin 2 hot outputs operate at +4dBu with +26dBu maximum.

**INSERTS** 3-pole TRS jack unbalanced insert for each monitor. Tip = send, Ring = return, Sleeve = ground. The insert is pre-fader and operates at a nominal -2dBu line level.

**WEDGE EXT IN** Balanced XLR pin 2 hot for nominal 0dBu line level signal.

**IEM EXT IN** Unbalanced TRS jacks for line level input. For a mono signal plug into the L/M input only. With nothing plugged into these sockets the wedge ext input is normalled through to both inputs to provide a common source to both the wedge and IEM monitors.

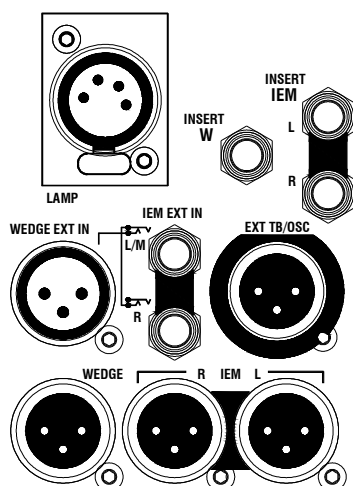

The **GL2800M** provides a comprehensive combination of facilities to help the monitor engineer set up and keep control of the multiple wedge/in-ear stage environment. Includes the engineer's monitors, headphones sockets, talkback section, built-in oscillator/noise test generator, mute group masters and the global settings configuration switches.

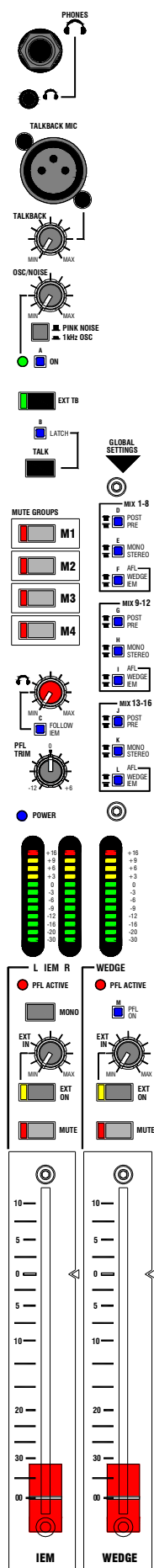

**PHONES OUT** Both a 1/4" and a 3.5mm socket are provided here for plugging in standard headphones and mini-jack ear pieces and in-ear sets. An alternative 1/4" socket is provided under the armrest.

**TB MIC** Plug in a cable or gooseneck vocal microphone to talk to the performers via their monitors. +48V phantom power is provided. This may be disabled by resetting an internal jumper. Adjust the mic level using the TALKBACK trim control.

**OSC/NOISE GENERATOR** The generator is turned on or off using a recessed switch to protect it from accidental operation. When you have finished using the generator turn it off to avoid test signal during the show. Adjust the level using the OSC/NOISE trim control. The test signal is routed to a mix output as soon as its associated TB switch is pressed.

**PINK NOISE / 1kHz OSC** Select either the pink noise or 1kHz tone as the test source. Use the tone when calibrating equipment levels. Use pink noise when testing speaker drivers and polarity.

**EXT TB** Routes the talkback/generator to the rear panel EXT TB/OSC socket. Balanced line level XLR output to drive a long cable run to a remote location, for example to communicate with the engineer at the FOH console. The output could also be used to patch the generator to test console channels or other audio equipment.

**TALK** Press this momentary switch to route the talkback mic to any output which has its TB switch selected. To prevent possible feedback the engineer's wedge output is dimmed (attenuated) by 20dB when TALK is pressed. The generator is dimmed by 12dB for intelligibility, for example when talking to a monitor being tested.

**LATCH** This recessed mode switch overrides the TALK switch to permanently enable the talkback mic when using a switched hand held microphone. Simply activate the switch on the microphone when you want to talk to enabled destinations. The TALK switch still provides a manual dim function.

**MUTE GROUPS** Press one or more of these master switches to mute all inputs assigned using the channel M1-4 switches.

**HEADPHONES FOLLOW IEM** Set this recessed mode switch to change the headphones source to follow the IEM monitor system.

**PFL TRIM** Adjust the PFL signal level to the headphones and monitor outputs to match your average AFL level. Range from -12dB to +6dB with centre detented 0dB position for normal operation. Does not affect the PFL meter reading.

**IEM MASTER** Provides fader, mute, pre-fade meters, mono summing of the stereo signal and external input switch and level trim. Selecting a channel PFL overrides any current AFL selection, indicated by the PFL ACTIVE LED.

**WEDGE MASTER** Provides fader, mute, pre-fade meter and external input switch and level trim. Select the recessed PFL ON switch if you want to check PFL in the wedge monitor. PFL overrides any current AFL selection.



The following is a collection of brief application notes, hints and tips to help the operator to get the most out of the uniquely capable **GL2800M** live sound monitor mixing console. They are written as a concise reference to spark your imagination to creatively and effectively deal with the many challenges faced in modern day mixing.

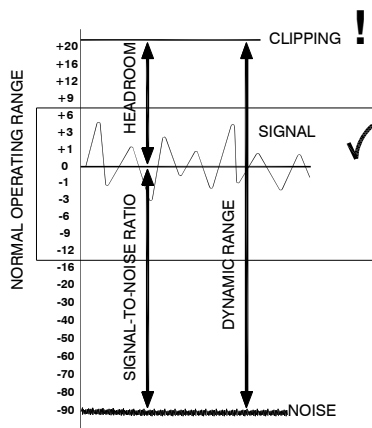

**Gain Structure** The term used to describe the gain (level) matching of the signal through the audio system chain. Each item in the equipment chain has its own optimum ('nominal') operating level determined by its electrical circuits. If you overload it with a signal that is too high then its output tries to produce more voltage than its power rails can provide resulting in harsh sounding distortion as the audio signal is 'clipped'. If you work with a signal that is too low then you are likely to hear the residual hiss of the circuits as the 'noise floor' is amplified along with the signal. The optimum operating level is the point at which the signal is high enough above the noise floor so that the hiss is not heard (good 'signal-to-noise' ratio, the SNR), yet provides enough space ('headroom') before clipping to allow for the louder, dynamic musical moments without distortion. 'Dynamic range' specifies the maximum range between noise floor and clipping. It is the sum of the SNR and headroom. The larger the figure the better... less noise, more headroom, more forgiving to wide ranging signals.

A microphone produces a very tiny signal, for example -50dBu (a few millivolts). This should be amplified by the channel preamp to the optimum operating level of the console circuits, around 0dBu (0.775V), well clear of the noise floor (typically less than -90dBu), and with good headroom (typically clipping at greater than +20dBu). The signal can pass through many stages which affect its level within the console; the channel, its EQ, fader, pan, the mix head amp, inserted EQ and processing, master fader, on to the main output. The output XLR provides the professional standard +4dBu (1.23V) nominal level to the next stage in the audio chain, typically a speaker processor such as limiter or crossover, or straight to the amplifier. The amp boosts this signal to tens of volts to move the speaker cones so producing the audible sound.

To get the best performance from your system, it is important that you set up the gain structure correctly within the console and also within and between the connected equipment. Ideally, each circuit should be set to clip at the same time if the signal became too hot, in other words each would have similar headroom relative to its nominal operating level. The resulting dynamic range is the difference between the highest noise floor and the lowest headroom through the system. The performance is only as good as the weakest link.

The **GL2800M** provides comprehensive metering to check every point within the console signal path. Use the channel meters and PFL/AFL system to set the gains and mix levels to average around '0' meter reading with usual peaks around '+6'. Reduce the gain if the red '+16' or 'PK' indicator lights.

Use the equipment meters to set each item within the system path to operate at its nominal level. We advise that the speaker processor or amplifier trims are set so that the console outputs can drive up to their nominal '0' level. It is a common mistake to set amplifier trims to maximum sensitivity when this results in the console master faders being operated at very low positions, with low meter readings, and reduced dynamic range and therefore audible residual system hiss.



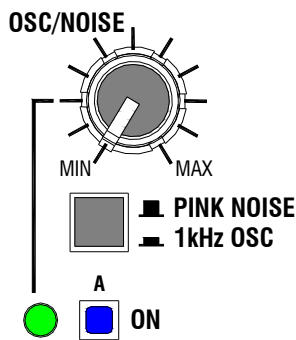

**Using the Oscillator / Noise Generator** The **GL2800M** includes a useful signal generator able to produce a pure 1kHz sine wave tone, or a pink noise test source. This is invaluable in testing the system components and setting up correct gain structure. The generator can be routed independently to the various console outputs.

Use the **1kHz tone** to line up the connected equipment. For example, a mix output to an in-ear transmitter or effects send/return loop. Route the tone to the mix you wish to align. Set the mix master fader to '0'. Press the mix TB switch to route the tone to this mix. Turn up the OSC/NOISE level until the mix meter reads '0'. Next, adjust the destination equipment input trim so that its meter also reads '0'. The connected equipment is now correctly aligned to the operating level of the console. You can patch the tone to other equipment by enabling the EXT TB switch and using the rear panel EXT TB/OSC output.

Use the **Pink Noise generator** to check the signal routing and loudspeaker response. 'Pink noise' is a random signal that contains all audio frequencies and is therefore a very good test source. Unlike 'white noise' which has equal energy per Hz and sounds like system or inter-band tuner hiss, pink noise has equal energy per octave, a response that matches the logarithmic way our ears perceive sound. You can hear all the frequencies clearly from deep bass, through mid to treble. This means you can route the noise to a speaker system and quickly hear if one of the sub, mid or HF drivers is faulty. With the noise sent to several speakers at the same time you can listen for comb filtering, and the severe phasing effect which indicates that one of the speakers may have its wires reversed. Adjust the swept frequency mix HPF using the noise source to listen to the effect of cutting the low frequencies in the monitors.

The **GL2800M** signal generator is an invaluable tool for calibrating and testing the system during setup. To prevent any unexpected mishaps during the sound check or show, remember to disable it by releasing the recessed ON switch once you have finished the testing. We also advise that you always start the calibration with the OSC/NOISE trim turned fully off so that you can bring it up gradually without the risk of overloading the destination.

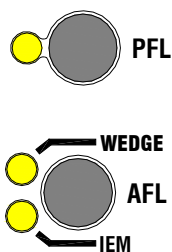

**Using PFL / AFL** The input channels provide **PFL** (pre-fade listen) so that each source can be checked using the meters and wedge/IEM monitors before you bring the channel fader up. You can use PFL while the channel is muted to prevent the signal reaching the monitors until you have checked it and are ready. All the mix outputs provide **AFL** (after-fade listen) so that you can check the exact level leaving the console. The AFL switch gets its source before the output mute so that you can check the signal before you send it to its destination.

😊 If you suspect the insert socket to be faulty or intermittent through excessive wear or contamination, test for this by plugging in a jack with its tip shorted to its ring contact. This bypasses the contact in the socket. Clean using suitable electrical contact cleaner.

**Using Inserts** The **GL2800M** channel inserts operate at 0dBu, the output inserts operate at -2dBu. In practice this makes little difference as long as the inserted equipment is intended for line level operation (-6 to +4dBu). Simply set the gain through the device to unity (0dB) with the bypass switch pressed (if available). With the effect switched in, use the processor output level trim or make-up gain to make any further adjustments needed. This keeps the gain structure correct through the channel signal path. With nothing plugged into the insert, the channel signal is routed through a switching ('normalling') contact in the socket. As soon as a jack is plugged into the socket the contact is opened and the signal path broken so that the external device can be patched in series with the signal.

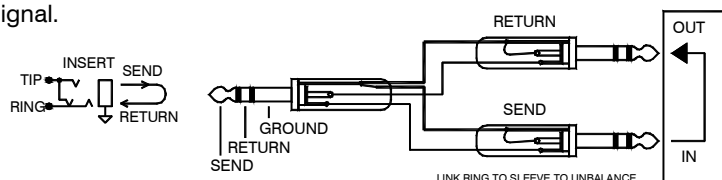



## POLARITY

**Polarity** Refers to the positive (+) and negative (-) wires of a loudspeaker or balanced audio connection. The console input channels and mix masters include POLARITY switches which reverse the + and - input connections. Applications include correcting for reverse wired cables, correcting for microphone placement problems, mixing two mics on a snare drum, one above the other below where the diaphragms move in opposite directions, helping to reduce comb filtering effects between speakers on stage, reducing interaction between stage sound and the FOH PA, and in certain situations helping to reduce feedback. Polarity is sometimes labelled 'phase' on mixing consoles. Technically, 'phase' is not the correct term as it implies a 180 degree time shift. Polarity simply reverses the wires. It does not affect time. Before starting your mixing, check that all the channel and mix polarity switches are correctly set, normally up (+).

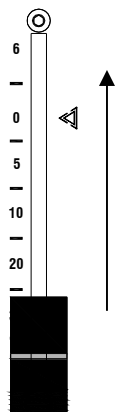

**Using the channel faders** The channels provide 60mm trim faders. It is typical to mix monitors with their channel sends set post-fade. This means you can use the channel fader as a master level trim for that source feeding all the mixes. Before you start balancing the mix set the channel faders to their marked '0' point for normal operation.

If you prefer, you can set all or some of the sends pre-fade so that they are not affected by the fader. For example, you could set the IEM sends pre-fade so that the personal mix to each performer is not affected when you make global changes to all the wedge speakers to adjust stage volume for a particular instrument.

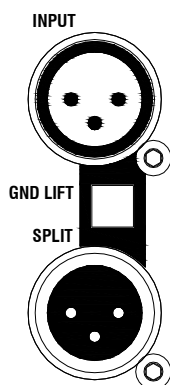

**Using the built-in mic splitter** The **GL2800M** provides a built-in passive mic splitter. Plug the stage sources into the monitor console channel inputs. Connect the split outputs to the multicore feeding the second console, typically FOH. Each console has independent control of its sources. It is the same as using an XLR Y-cable for one mic to feed two console channels. The GND LIFT switch disconnects the pin 1 ground link between the input and split output XLRs. Use this only if you experience audible hum due to a ground loop problem associated with the wiring at your venue. If this is the case you may need to select all the channel lift switches. Only in extreme situations may it become necessary to consider using a much more expensive transformer splitter solution to provide complete isolation between the consoles. Start with all LIFT switches deselected.

**Phantom power and the monitor console** Either or both the monitor and FOH console may provide the 48V phantom power without any problem or damage to the equipment. The power is routed to the XLR pins via 6.8k ohm resistors which limit current and prevent damage. Decide before the sound check which engineer shall be responsible for providing the power. Typically the monitor engineer would switch the power as he/she would be on stage helping set up the microphones. Ensure that both the FOH and monitor console mic channels are muted while the mics are being plugged and power switched.

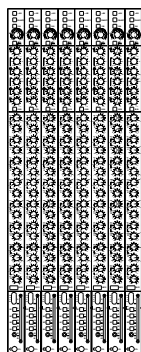

**Zero the console** Before starting the sound check it is good practice to 'zero' the console by setting all its controls to a sensible starting condition. Check that the GLOBAL SETTINGS and all other mode switches are correctly set for your application. Set all GAIN, EQ and PAN controls mid, faders off, TALKBACK and OSC/NOISE levels off, TB enable switches off, PFL and AFL off, and all other switches up. If you have configured stereo mixes start with their pan controls (even numbered sends) set to their centre detented position. Make sure the osc/noise generator is turned off. Cue Sheets are provided at the rear of this guide for you to copy and log your control settings. This can also be downloaded from our web site.

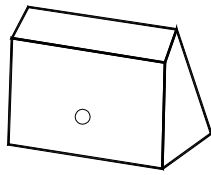

**Stage wedge speakers** The type and position of the floor wedge speakers used for stage monitoring are critical to both meeting the performers needs and keeping stage noise under control. Use a speaker designed for the monitor application and with adequate power handling for the type of show. Know the directional response of the microphones being used as this can determine the optimum position of the speakers to minimise feedback. Ensure the speaker is as close as possible to and angled up to face the performer.

**The engineer's wedge speaker** Use the same type of speaker as used on stage for the performers. To help you hear the mix as the performer does, position this in a similar way to those used on stage, on the floor angled up towards you.

**Ring out the wedges** To avoid problems take care to position each mic and speaker correctly. Use an EQ, typically 31 band graphic, inserted into each wedge mix. Start with the EQ set flat. Sweep the console mix HPF to filter out unnecessary low frequencies. Restricting the low end in the wedges can improve the overall stage sound and prevent the amplifiers wasting energy. It is likely that there will already be a strong low frequency presence from the back line.

Get a colleague to help with this process. Ring out each monitor by carefully turning up the level until feedback just starts. Have someone talk, shout or sing into the mic as this may stimulate further feedback. Find and cut back that frequency a few dB on the EQ. Turn up the level and find the next feedback ring. Do this for 2 or 3 frequencies and do not cut more than 3 to 6dB where possible. Avoid using the EQ to boost frequencies. Excessive use of the EQ may reduce the feedback but may also destroy the intelligibility of the mix. While finding the feedback it helps to simulate how the mic will be used during the show. For example, cup the mic with your hand, present your open mouth close to its grille, walk around the stage if the performer does this. Certain 'props' such as sunglasses, costumes and hats may stimulate feedback. Once you have completed the process listen to your voice or a signal through the speaker to make sure that the overall tone is good. A monitor that has been effectively tuned in this way should provide plenty of GBF (gain before feedback) ready for the sound check and show.

**Creating a wedge mix** To improve intelligibility keep the mix as simple as possible with just vocals and specifically requested sources. It is unusual to put everything into the wedge mix as it is there to supplement the acoustic contribution of the instruments on stage. Avoid reverb or other ambient effects in the wedges if possible. To keep the stage level under control encourage the performers to turn down or reposition the back line amplifiers if they are too loud.

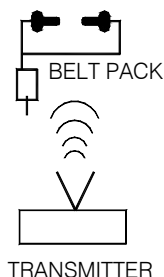

**Mono or stereo in-ear monitors** The majority of professional closed ear IEM systems are capable of handling a stereo mix. Stereo is known to provide the performer with a much more comfortable listening environment. However, mono is still the more common method simply because of the lack of compact affordable consoles with a sufficient number of auxes or the ability to create true stereo mixes. The space saving **GL2800M** changes all that with its 16 mixes, true stereo level/pan capability and advanced engineers stereo monitoring...

**Adding ambience to an in-ear mix** Because the performer wearing an in-ear monitor becomes isolated from the stage and audience acoustics it is good practice to add some ambience to the mix. A little stereo reverb can help, or better still, use a pair of ambient pickup microphones placed at the side or front of stage. Condenser mics are recommended. Plug these into a pair of channels and pan to create the stereo spread required. It helps to EQ out the extreme low and high frequencies to avoid distracting from the musical mix.

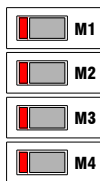
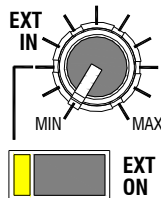
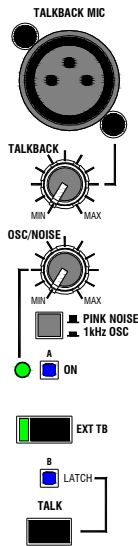

Think before you hit the switch!



**Monitoring many mixes** The **GL2800M** provides a dual AFL monitoring system so you can check the stage wedge mixes in your own floor wedge, and check the in-ear mixes using your own IEM system or the console headphones. Before starting, decide which mixes are to feed each type of monitor and then configure the GLOBAL SETTINGS switches accordingly.

**A quick and easy IEM monitor** If you do not have a dedicated engineer's IEM system then simply select the headphones FOLLOW IEM switch so that the console headphones output may be used instead. In this mode the headphones follows the engineer's IEM monitor master fader. A 3.5mm socket is provided in addition to the two standard 1/4" sockets, ideal for plugging in the typical ear pieces used.

**Communicating with the performers** Use the built-in talkback system to talk to individual or combinations of performers through their monitors. You may find it more convenient to use a switched, hand held microphone. In this case select the recessed LATCH mode switch to bypass the console TALK switch.

**Communicating with the FOH engineer** Use the external TB/OSC output to connect via the multicore to an input on the FOH console. Press the EXT TB switch to enable talkback to this output. The FOH engineer can route that channel or select PFL to his monitor when communication is needed. For reverse communication the FOH engineer can send a line level talkback signal from the FOH console via the multicore to the **GL2800M** wedge EXT input XLR. Press the EXT ON switch and adjust the level to listen to the FOH signal in your wedge when needed. The same talkback return is routed to the IEM monitor when nothing is plugged into its TRS jack inputs.

**Using the mute groups** Use these to mute combinations of input channels, for example those associated with different bands playing in a festival. We recommend you set up one group to mute all inputs. This provides a quick way to turn the mix off during intermission or while you replug microphones on stage.

**Turning the system on and off** It is good practice to:

- Turn the amplifiers on last and off first.
- Mute channels before plugging cables, unplugging instruments and switching phantom power.
- Let equipment which has been stored in a damp or cold place acclimatise in the venue first before powering it up.
- Power up the system in plenty of time before you start the sound check or show.

**Sound levels** The ear is a delicate instrument. Do not subject yourself or the performers to long periods of loud sound, particularly with extreme equalisation. This may result in frequency selective or full range hearing loss. Ensure that any closed ear personal monitor systems in use have adequate protection limiting. This may be built into the monitor system, or it may be necessary to patch outboard limiters into the IEM mix inserts. Adhere to the sound level regulations which may apply to the venue... and common sense!

# Specifications

## Performance

Maximum XLR input level	+34dBu (inc pad)
Maximum XLR output level	+26dBu
Internal headroom	Channels +20dB, Mix +22dB
Master meters	12 segment -30 to +16dB, 0VU= +4dBu XLR
Channel meters	4 segment -12,0,+6+16dB (5dB before clip)
Frequency response	20Hz to 50kHz +0/-1dB
Mic CMRR at 1kHz	> 80dB typical
THD+n at +14dBu 1kHz	Mic to mix out < 0.003%
Crosstalk at 1kHz	Fader shutoff >90dB
	Mute shutoff >88dB
	Inter channel >90dB
Noise, rms 22Hz to 22kHz	Mic EIN -128dB
	Residual output noise < -96dBu (-100dB S/N)
	Mix noise 24 channels < -80dBu (-84dB S/N)
Channel HPF	Switched 100Hz, 12dB/octave
Output HPF	Swept off to 400Hz, 12dB/octave
Channel EQ	HF Shelving +/-15dB, 12kHz
	HM Peak/dip +/-15dB, 500Hz to 15kHz, Q=1.8
	LM Peak/dip +/-15dB, 35Hz to 1kHz, Q=1.8
	LF Shelving +/-15dB, 80Hz
Mix 1-8 EQ	HM Peak/dip +/-15dB, 500Hz to 12kHz, Q=1.6
	LM Peak/dip +/-15dB, 80Hz to 2kHz, Q=1.6
Power supply	External RPS11 IEC input
	External Input for optional RPS11 backup supply

## Connections

Channel	XLR balanced pin 2 hot	Sensitivity -60 to +14dBu
	Total gain range	74dB
	20dB Pad	out 2k ohm, in >10k ohm
Wedge Ext in	XLR balanced pin 2 hot	>10k ohm, 0dBu, +20dBu max
IEM Ext in	TRS unbalanced	>10k ohm, 0dBu, +20dBu max
Talkback mic	XLR balanced pin 2 hot	Sensitivity -50 to -10dBu
	Phantom power	Internal jumper +48V (fitted)
Inserts	Channel	TRS, tip send, ring return, 0dBu
	Output	TRS, tip send, ring return, -2dBu
Mix 1-16 out	XLR balanced pin 2 hot	<75 ohm, +4dBu, +26dBu max
IEM/Wedge out	XLR balanced pin 2 hot	<75 ohm, +4dBu, +26dBu max
Talkback/Osc out	XLR balanced pin 2 hot	<75 ohm, +4dBu, =26dBu max
Headphones	TRS, tip L, ring R,	30 to 600 ohm headphones recommended
Lamp	4-pin XLR	max 12V 5W lamp

## Mechanical

	24	32	40
Width	944mm (37.2")	1171mm (46.1")	1398mm (55")
Depth	650mm (25.6")		
Height	170mm (6.7")		
Weight	29kg(63.8lbs)	35kg(77lbs)	41kg(90.2lbs)

Copy and use this page to record your console settings.

GL2800M

16 MIX WEDGE / IEM MONITOR CONSOLE

Control panel for 16 channels, each with the following controls:

- Gain: +48V, POLARITY, PAD, GAIN (0 to -15 dB), HPF (OFF)
- EQ: HF (120, 150, 200 Hz), LF (15, 20, 30 Hz), EQ IN
- Mix: STEREO (1 to 8), MAX (0 to 10), PAN (L, R)
- Mute: MUTE, DIM
- Routing: PFL (+6, +8, +10, +12, +14, +16 dB), SIG (0 to 6)

Control panel for 16 channels, each with the following controls:

- EQ: EQ IN, POLARITY, HPF (OFF)
- Wedge/IEM: WEDGE, AFL, IEM, EM, STEREO (0 to 10)
- Mute: MUTE, DIM
- Routing: PFL (+6, +8, +10, +12, +14, +16 dB), SIG (0 to 6)

Global settings and monitoring controls:

- PHONES, TALKBACK MIC, TALKBACK, OSC/NOISE, PINK NOISE, 1MHz OSC, ON/OFF
- EXT TB, LATCH, TALK
- GLOBAL SETTINGS: MIX 1-8 (POST PRE, MONO STEREO, WEDGE IEM), MIX 9-12 (POST PRE, MONO STEREO, WEDGE IEM), MIX 13-16 (POST PRE, MONO STEREO, WEDGE IEM)
- MUTE GROUPS: M1, M2, M3, M4
- PFL TRIM (0 to 15)
- POWER
- WEDGE ACTIVE: L IEM R, PFL ACTIVE (MONO, STEREO), EXT IN, EXT ON, MUTE
- IEM and WEDGE monitoring levels (0 to 10)

