

ALLEN & HEATH
WORLD CLASS MIXING

www.allen-heath.com/zed
sales@allen-heath.com

t:+44 (1326) 372070



LARGE FORMAT
LIVE SOUND MIXERS

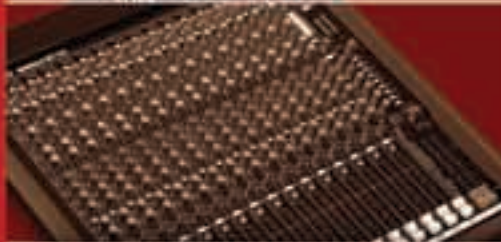

SMALL FORMAT
LIVE SOUND MIXERS



DJ PRODUCTS



SOUND MANAGEMENT
SYSTEMS



DIGITAL LIVE SOUND
SYSTEMS

Allen & Heath reserves the right to alter any information
supplied in this document or any other document supplied hereafter

AP7205 issue3

Multipurpose USB Mixers
for Live Sound and Recording

ALLEN & HEATH
ZED
SERIES



ZED-10 . ZED-10FX . ZED-14 . ZED-24 . ZED-12FX . ZED-22FX . ZED-420 . ZED-428 . ZED-436

GET INTO YOUR ZED SPACE

Allen & Heath has been in the mixer business for nearly 40 years, so we understand what elements make a good mixer – such as fantastic sound, rugged build quality and imaginative feature sets. We've brought all these principles together to produce the ZED series, a range of competitively-priced mixers for musicians and sound engineers which will last a lifetime, and make mixing a real pleasure.

FEATURE SET

Allen & Heath has been in the mixer business for over 40 years, so we understand what elements make a good mixer – such as fantastic sound, rugged build quality and imaginative feature sets. We've brought all these principles together to produce the ZED series, a range of competitively-priced mixers for musicians and sound engineers which will last a lifetime, and make mixing a real pleasure.

The ZED range now offers something for all bands, DJs, singer songwriters or studio musicians. Now comprising the new Mini 10 & 10FX, four models in the 2 bus range and three larger models with 6 auxes and 4 groups, ZED's feature set is incredibly advanced for this level, offering a great mixing solution wherever you are, whatever you're doing • playing live, in the studio, or at home, ZED will suit your application perfectly.

SOLID CONSTRUCTION

ZED mixers offer many sources to the mix, 2, 4 or 6 aux sends, 4 groups on the 4 bus versions, a USB send and return (for PC/Mac recording, playback and effects), a unique dual stereo input capability and some very advanced monitoring facilities. This impressive feature set is complemented by 100mm faders or high quality rotaries for accurate control, the connectors are placed on the top surface for easy plug-in and patching, and the construction, with individual vertically-mounted circuit boards bolted to the top panel, is identical to Allen & Heath's professional touring mixers.

SOUND QUALITY

Our ZED designer, Mike Griffin, has been at the forefront of audio innovation for many years and has developed the designs for our spectacularly successful MixWizard, PA and GL series professional live mixers. Mike is always striving to produce the best possible sound for our products, so ZED mixers utilise MusiQ 3 or 4 band EQ, and incorporate the 'DuoPretm' or 'Guitar DI' Preamp, connect easily to a computer, provide flexible signal routing and monitoring capability, all with low noise and plenty of headroom – packaged in a unit that's built to last for many years.

In the digital world, the innovation continues. The FX algorithms within the ZED-FX mixers are designed by our in-house DSP gurus and are all unique to the ZED. You won't hear them anywhere else, and on a little mixer like the ZED-FX that's something pretty special.

VERSATILITY

Bundled with Cakewalk's superb SONAR LE production software (except ZED10 / 10FX), ZED mixers can be used for many different tasks:-

- Straightforward live performance mixing, either using the ZED-FX 16 internal FX, or using plug-in effects in Sonar, connected via USB.
- Mixing sources and managing outputs for AV presentations
- Live recording via USB and digital audio workstation such as SONAR LE
- Studio recording or mixing down to produce 2-track recordings.
- Building songs up a track at a time, or just quickly getting that idea down.



Learn more at cakewalk.com

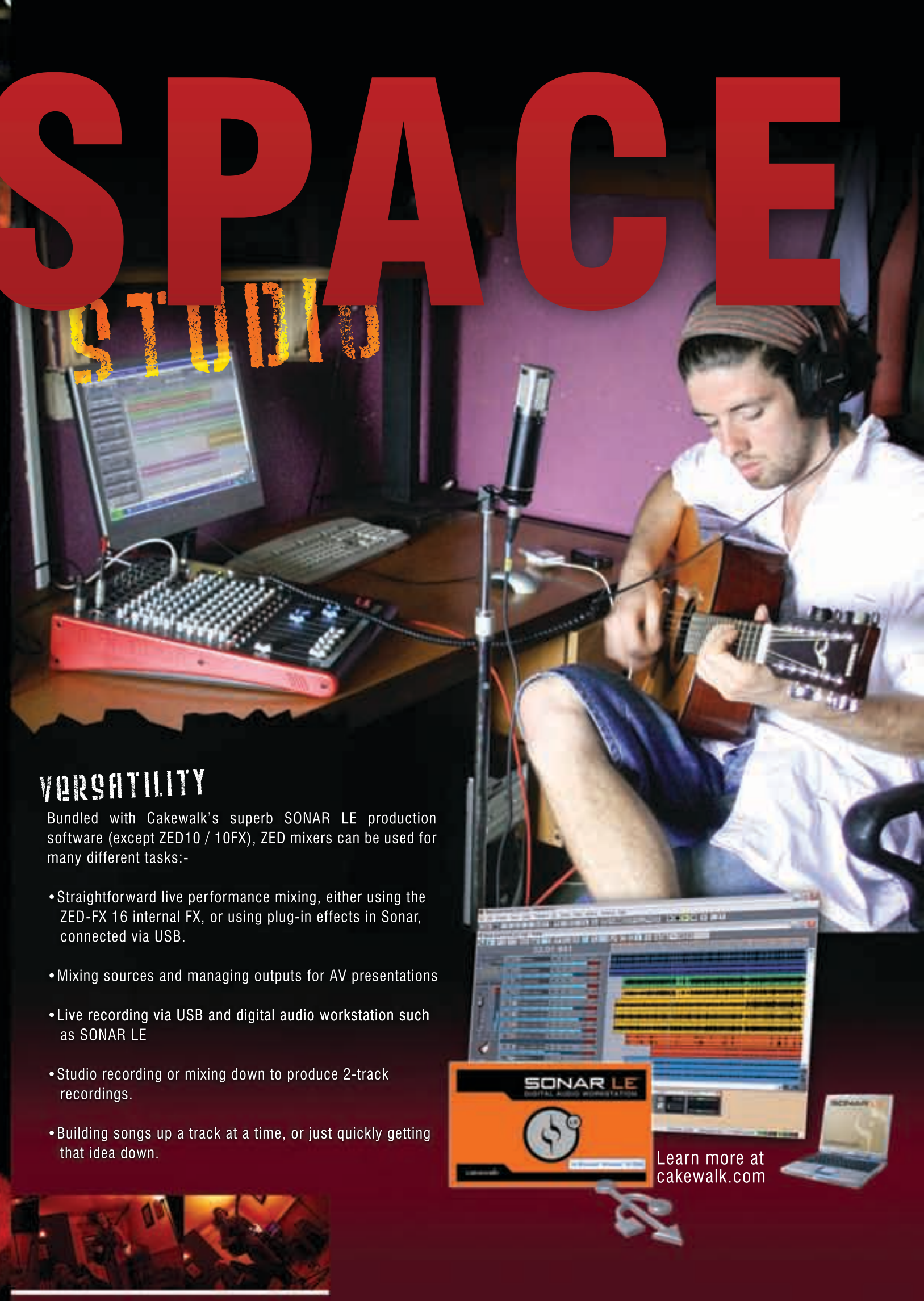

4 mic/line inputs



ZED-10 / ZED-10FX

ZED-10 and ZED-10FX are amazing little desks for small band mixing. They are ultra portable for carrying to the gig, and can be used for recording live or in the studio. Guitars can be plugged in directly to the mixer using the specially designed high-impedance inputs, while the mixer has two stereo inputs for MP3/CD players or keyboards. Equipped with professional XLR main stereo outputs and a flexible monitoring section with headphone and speaker feed outputs. In the FX version, we've added a set of fabulous effects to give shimmering reverbs and enhance your sound.

- 4 mic/line inputs, 2 with Class A FET high impedance
- Responsive 3-band, swept mid EQ with MusiQ
- 2 stereo sources with MP3 player compatibility
- Separate 2-track record outputs
- XLR main stereo outputs with inserts
- Comprehensive monitoring
- 48V microphone phantom power
- DI level switching for sub mixing

4 mic/line inputs



ZED-420 / ZED-428 / ZED-436

Zed 4 bus mixers are excellent for bands, houses of worship, theatres or AV applications. They have a truly professional feature set, which will fit any sound reinforcement application and professional PA hire stock. Available with 16, 24 or 32 mic or line inputs plus 2 dual stereo inputs with EQ, 4-band EQ with MusiQ, 4 sub-groups, 6 auxiliary sends and a 7x2 matrix.

- 4 groups
- 16/24/36 mono mic/line inputs with DuoPre™ preamps
- 2 dual stereo channels with gain
- 4-band, 2 swept EQ with MusiQ
- Direct outputs on each mono channel
- Separate L, R & M main buses
- 100mm professional quality faders
- 2 matrix outputs
- Talkback facility to auxes or LRM
- Flexible dual input options

16 mic/line inputs



24 mic/line inputs



32 mic/line inputs



ZED-14 / ZED-24

ZED-14 is a fantastic entry-level mixer for small bands, solo performers or AV applications. Its comprehensive feature set, compact size and fine lines combine to make it one of the best small mixers around. Provided with 6 mic or line inputs, 4 stereo inputs with EQ, there are an incredible 157 controls on the front panel of the ZED-14. The ZED-24 adds a further 10 mono mic/line inputs for more demanding applications.

- 6 mic/line inputs / 16 mic/line inputs
- DuoPre™ mic preamps
- Responsive 3-band, swept mid EQ with MusiQ
- 4 stereo line inputs with gain and 2-band EQ
- 4 aux sends
- Rack-mountable with optional rack-ears, fits into a 11U space
- 100mm professional quality faders • Flexible dual input options



6 mic/line inputs



16 mic/line inputs



6 mic/line inputs



ZED-12FX / ZED-22FX

ZED-FX mixers are ideal for groups who need to travel light. The ZED-22FX easily accommodates vocals, drums, guitar, bass and keys whilst also providing a dedicated FX bus and 16 internal time-delay effects – giving the whole mix extra ambience. Even with its small footprint, the 12FX squeezes in 4 auxiliary channels and swept semi-parametric EQ on top of the already impressive feature set.

- 16 internal adjustable pro-standard FX
- 6 mic/line inputs / 16 mic/line inputs
- DuoPre™ dual-stage mic preamps
- Responsive 3-band, swept mid EQ with MusiQ
- 4 stereo line inputs with gain and 2-band EQ
- 4 aux sends (stereo aux option on stereo inputs)
- Rack-mountable with optional rack-ears, fits into a 11U space
- 100mm professional quality faders
- ALT-OUT mix position output

16 mic/line inputs



ZED Design Essentials



DuoPre™

Based on the proven pre-amps from the hugely successful PA series, the ZED mixers (except ZED-10 & 10FX) have new DuoPre™ pre-amps, which use a two stage design, with carefully controlled amounts of gain in each stage. When amplifying the signal from the XLR input, the gain range is huge - 69dB of range to be exact - and is very evenly distributed around the gain control, meaning better control of signal level. Most of the gain comes from the first stage, so unwanted noise is kept to a minimum. Line level signals are simply plugged into the second stage of the pre-amp by using the line input jack socket, which has the great advantage of less noise when using the line input and also matching to a higher input impedance.



USB audio flexibility

Getting audio to and from a computer easily is now a common requirement for live sound and music production. The way this has been implemented on ZED is super-flexible and super-easy! No longer do you need to fiddle around the back of your PC to get to the soundcard inputs, only to find that the levels are all wrong and noisy. Just plug in a USB lead to your ZED, select the USB routing on the mixer and the device on your computer and that's it! CD quality audio to and from your PC or Mac. Switches and connection through jack socket terminals provide different send/return configurations:-

ZED-10, 10FX Send options:

- 1) Main Mix Left + Right (Post master Level)
- 2) Aux + FX bus (Aux is a pre-fade send, FX is a post-fade send)
- 3) Record Bus Left + Right (Separate stereo bus to Main Mix)

Return Options:

- 1) To Playback input (through jack socket break contacts)
- 2) To Stereo 2 channel (through jack socket break contacts)

ZED-14, 24, 12FX & 22FX Send options:

- 1) Main Mix Left & Right (post fader)
- 2) Main Mix L & R (pre fader)
- 3) Aux 3 & 4 (post fade sends – ideal for effects processing)
- 4) Aux 1 & 2 (pre fade sends – useful for recording)

Return Options:

- 1) To Main Mix L & R (using dedicated level trim)
- 2) To Stereo channel 3 (so you can use EQ, fader etc)

ZED-420, 428, 436 Send options:

- 1) Main Mix Left & Right (post fader)
- 2) Main Mix L & R (pre fader)
- 3) Aux 5 & 6 (post fade sends – ideal for effects processing)
- 4) Aux 1 & 2 (pre fade sends – useful for recording)
- 5) Matrix 1 & 2 (great for recording a different mix to the main PA)

Return Options:

- 1) To 2 Track Return (ideal for background music or playback)
- 2) To Stereo channel 3 (via switch – either straight to L-R or to the channel)



MusiQ

ZED-10, 10FX, 14, 24, 12FX & 22FX feature a responsive 3-band, swept mid frequency design, while ZED 4-Bus mixers have instead a tuned 4-band EQ taken from the acclaimed GL2400 mixer. Both designs utilise MusiQ – with optimised slope (or Q factor) for equalising individual instruments.

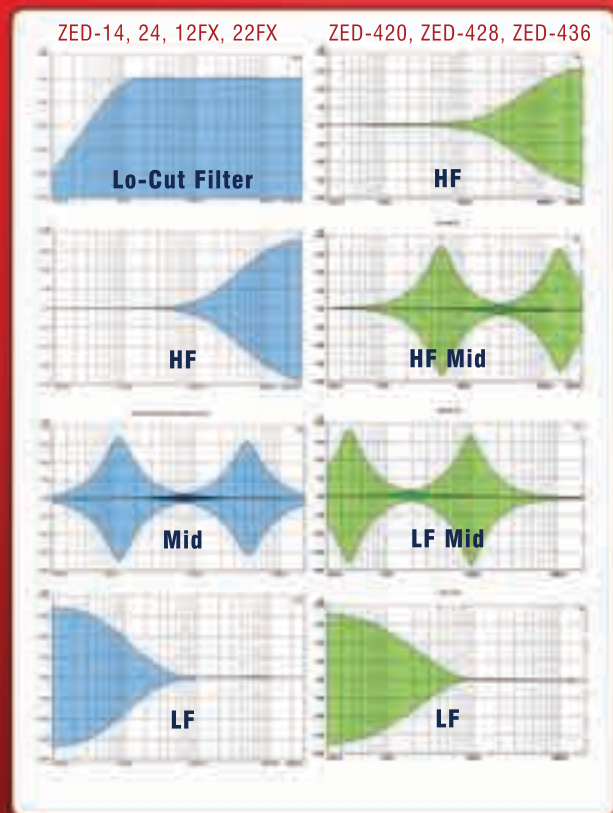

ZED-FX

Launched to complement the existing ZED series, the ZED-FX has an essential selection of 16 time-delay effects, designed for small groups who don't want to carry around an effects unit with their gear but who still want great quality FX at their gigs and on their recordings. Our DSP engineers worked hard, crafting and refining beautiful reverb algorithms to enhance every performance. These effects are available nowhere else at this price point – this quality and integration is only available from the ZED-FX. ZED effects are easily controlled using 3 buttons with 9 display LEDs. For example, the ideal delay time can be quickly tapped-in, or the perfect amount of reverb on the lead vocal can be dialled-in. There is one-stop navigation and editing – in fact, it's just as easy as using effects pedals. To alter effects parameters, the TAP button is held down and the up/down buttons pressed to adjust the specific parameter for that effect, for example, the decay length on PLATE, or the depth on CHORUS.



Guitar DI

In place of the DuoPre™, the ZED-10 & 10FX have pre-amps similar in design to our MixWizard range of mixers, but with a twist! Inputs 3 & 4 have a high impedance jack input capable of taking either a normal line level or a low level input from a guitar pickup.

These newly designed inputs have been crafted with the aim of replicating the sound of a classic guitar or instrument tube pre-amp in a combo or head amp. An extremely high input impedance ensures loading on pick-ups is minimal and a Class A FET (field effect transistor) circuit powered from 48V is employed to give the valve-like gain stage. There is a gain "Boost" switch associated with the guitar inputs which boosts gain by 26dB to cater for instruments with very low level outputs and the overdrive characteristics of the guitar inputs are very similar to a valve (tube) circuit, being asymmetric and soft. All this makes for a wonderfully natural sound to be reproduced from the instrument, full of warmth and character.



SONAR LE - provided Free!

(Except 10/10FX)

We've included Cakewalk SONAR LE with all ZED mixers (except ZED 10 & 10FX) so you can immediately start to use it to create your own music – just add a PC and it couldn't be more straightforward to get going. You'll be able to record from your ZED mixer, create tracks and arrange songs, then play back to ZED via the USB port. You can use SONAR LE and your ZED mixer together in many ways – for example, straightforward recording of a stereo mix, recording tracks individually to build up a song, or sending a postfade mix from ZED and inserting an effects plug-in from SONAR LE, returning the post-effects signal to the mix in ZED. SONAR LE is the most complete OEM audio production software solution available today. And it is now ready for Windows 7! Today's SONAR LE is based on SONAR 8.5, the newest technology from Cakewalk, the world's leading developer of powerful and easy to use products for music creation and recording.

Key Features

- Powered by SONAR 8.5
- 32 audio tracks
- 64 MIDI tracks
- 8 simultaneous inputs and outputs
- 24-bit/96 kHz audio quality
- 24 simultaneous effects
- 8 simultaneous virtual instruments
- Includes 2 virtual instruments
- Includes over 10 audio effects
- Integrated VST/VSTi support
- Support for ACID™-format loops
- Support for ReWire clients such as Live, Reason, and more
- Elegant user interface
- Active Controller Technology™ automatically maps MIDI keyboards and control surfaces to the parameters you need most on effects, instruments, volume, pan, and other mix elements
- Easier integration of virtual instruments with Synth Rack
- Support for 32-bit and 64-bit versions of Windows 7 and Windows Vista as well as 32-bit Windows XP operating systems



Multipurpose Mixers for live sound & recording

- 4 mic/line inputs, 2 with Class A FET high impedance inputs
- Neutrik mic XLR
- Neutrik 1/4 inch jacks
- 3 band EQ with MusiQ
- 2 auxes
- Sound image pan
- Illuminated PFL indicator
- Stereo returns & playback
- All inputs with level control
- 12 bar meters
- Responsive 3-band, swept mid EQ with MusiQ
- 2 stereo sources with MP3 player compatibility
- Separate 2-track record outputs
- Stereo playback input for 2-track replay
- XLR main stereo outputs with inserts
- Comprehensive monitoring
- Configurable USB stereo audio in/out
- Stereo monitor outs
- 48V microphone phantom power
- DI level switching for sub mixing

Block Diagram

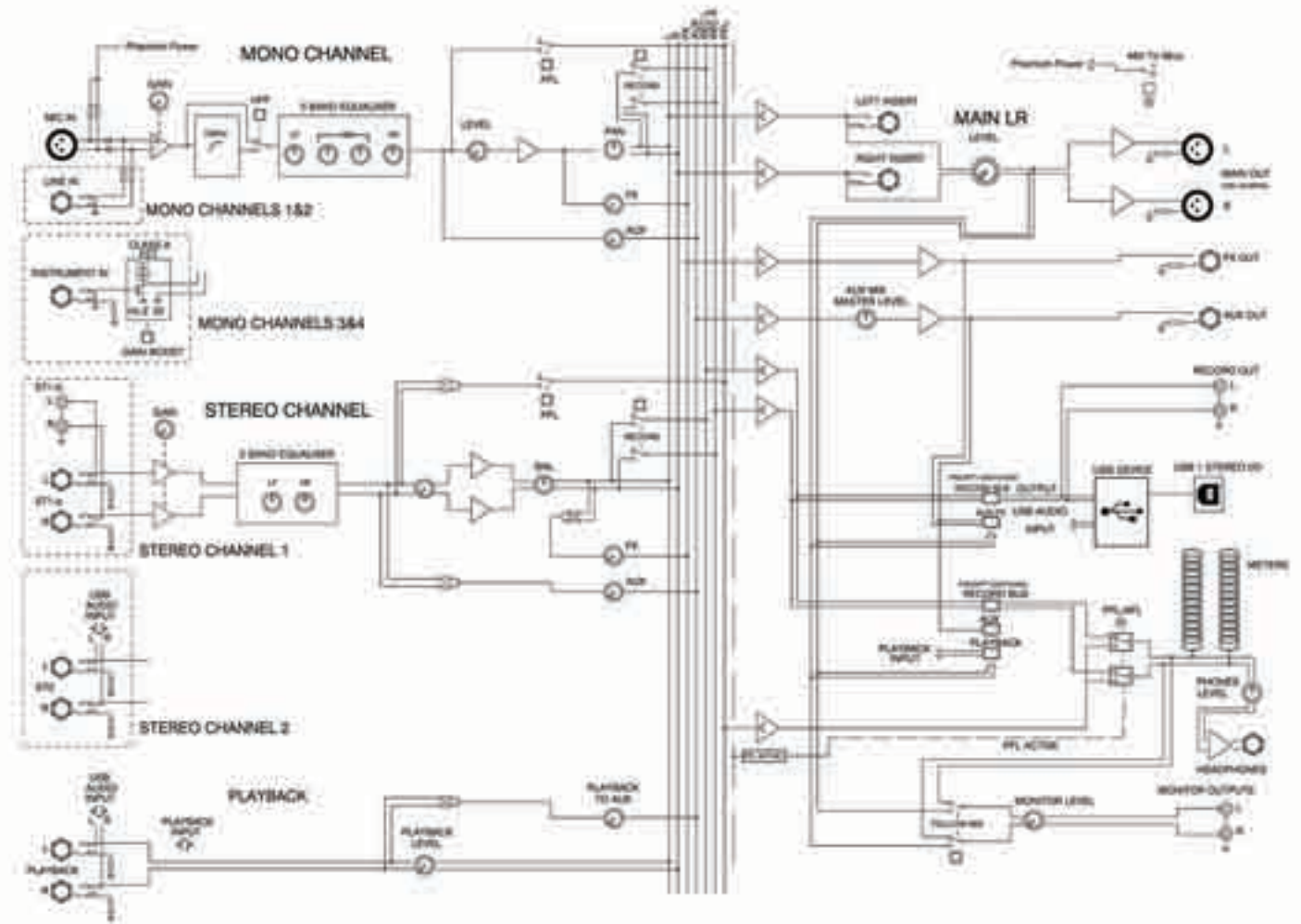



Multipurpose Mixers with FX for live sound & recording

- 4 mic/line inputs, 2 with Class A FET high impedance inputs
- Neutrik mic XLR
- Neutrik 1/4 inch jacks
- 3 band EQ with MusiQ
- 2 auxes
- Sound image pan
- Illuminated PFL indicator
- Stereo returns & playback
- All inputs with level control
- 12 bar meters
- Professional FX
- Responsive 3-band, swept mid EQ with MusiQ
- 2 stereo sources with MP3 player compatibility
- Separate 2-track record outputs
- Stereo playback input for 2-track replay
- XLR main stereo outputs with inserts
- Comprehensive monitoring
- Configurable USB stereo audio in/out
- Stereo monitor outs
- 48V microphone phantom power
- DI level switching for sub mixing

Block Diagram

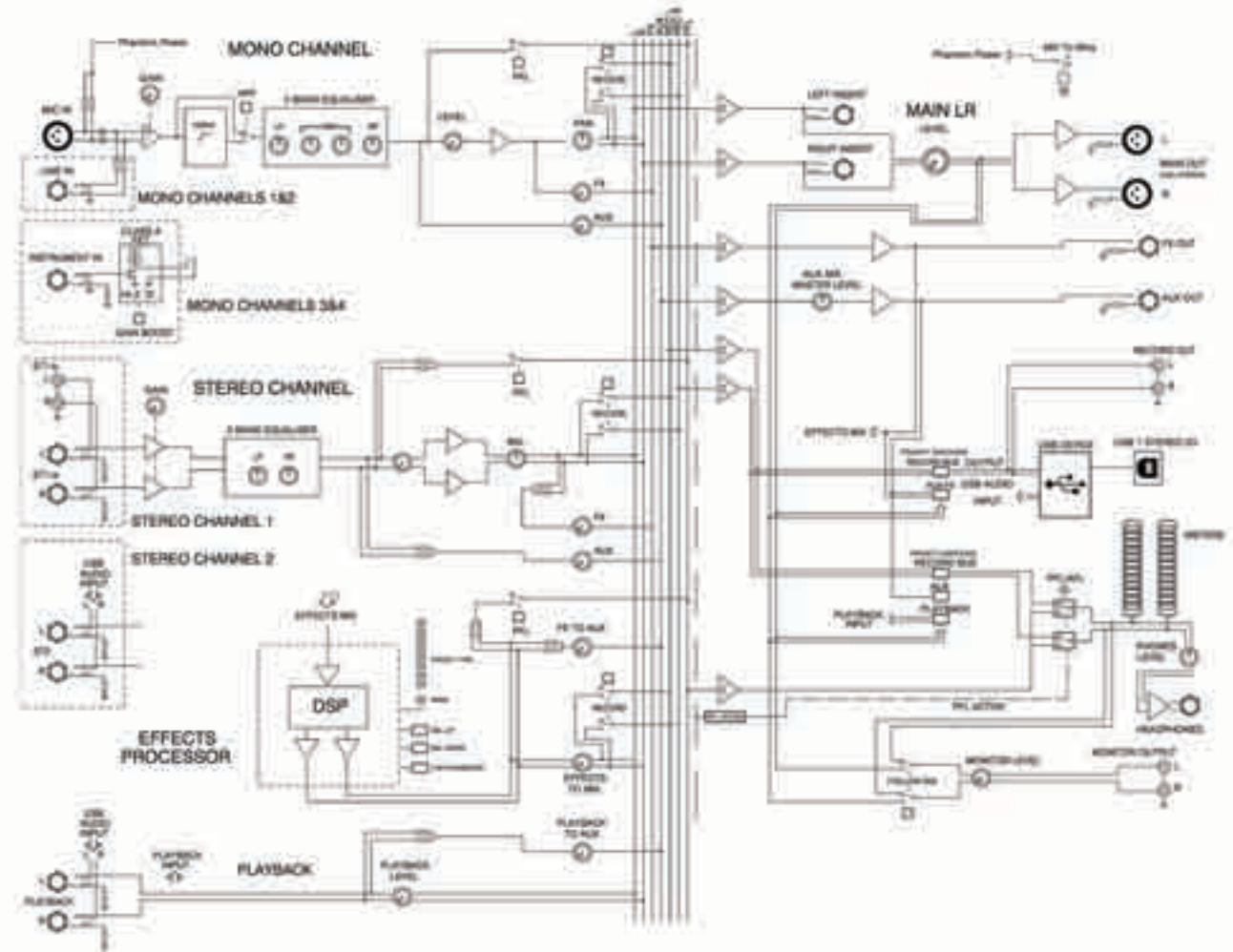



Multipurpose Mixers for live sound & recording

- 6 or 16 mono channels
- Neutrik mic XLR
- Neutrik 1/4 inch jacks
- Channel insert
- Super wide gain 'DuoPre' mic line input
- 3 band EQ with MusiQ
- 4 auxes
- Illuminated mute
- Sound image pan
- Illuminated PFL & peak warning indicator
- ALPS 100mm faders
- 4 stereo channels with 2-band EQ and inputs for extra sources
- Stereo returns & playback
- All inputs with level control
- 12 bar meters
- Mono/stereo function on auxes 1&2
- Monitor output section
- Alt stereo output source
- Configurable USB stereo audio in/out
- Cakewalk SONAR LE bundled with mixer
- Rack ears available

Block Diagram

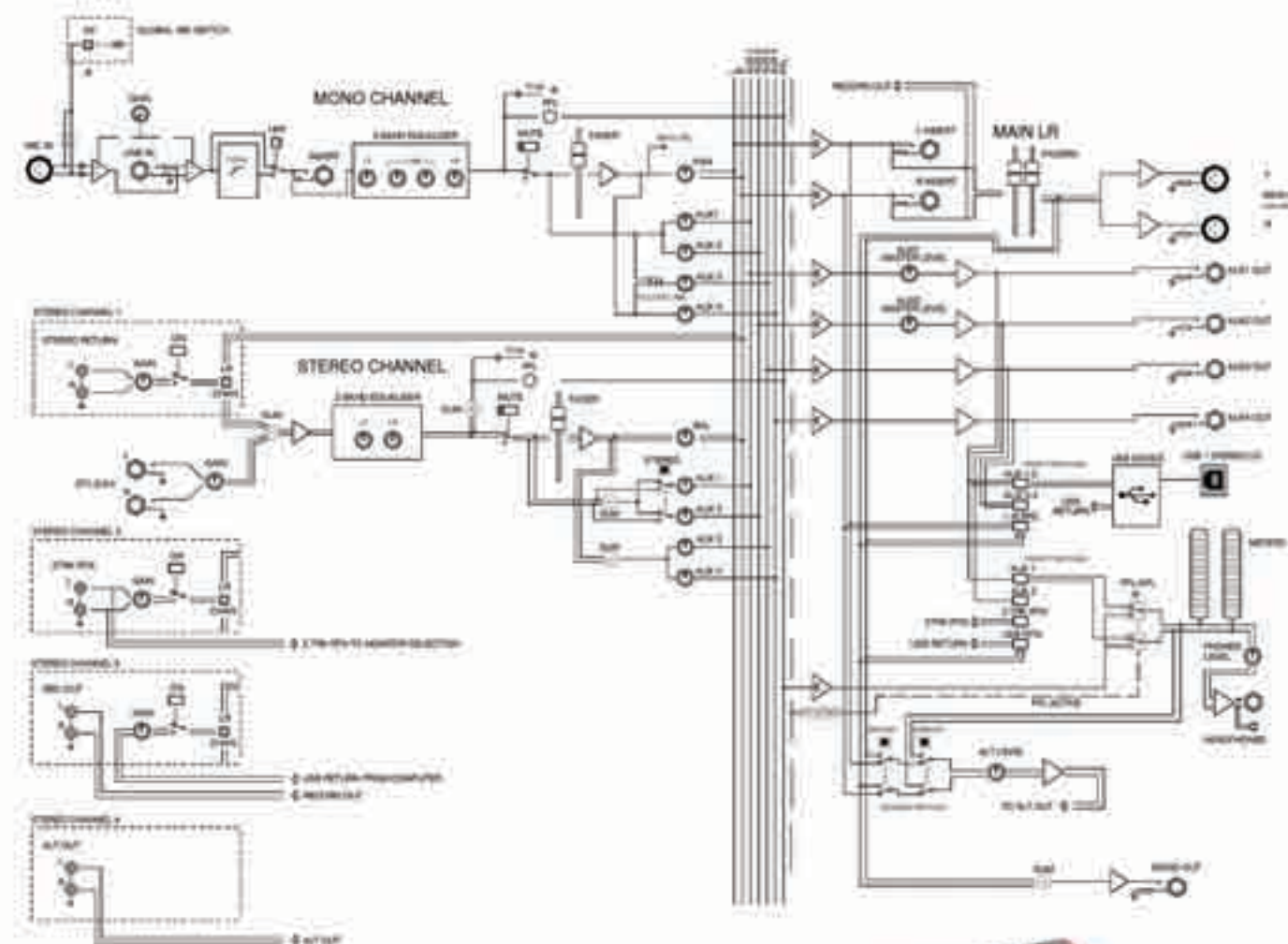



Multipurpose mixers with FX for live sound and recording

- 6 or 16 mono channels
- 16 internal time-delay effects
- Neutrik mic XLR
- Neutrik 1/4 inch jacks
- Channel insert
- Super wide gain 'DuoPre' mic line input
- 3 band EQ with MusiQ
- 4 auxes
- Illuminated mute
- Sound image pan
- Illuminated PFL & peak warning indicator
- ALPS 100mm faders
- 4 stereo channels with 2-band EQ and inputs for extra sources
- Stereo returns & playback
- All inputs with level control
- 12 bar meters
- Mono/stereo function on auxes 1&2
- Monitor output section
- Alt stereo output source
- Configurable USB stereo audio in/out
- Cakewalk SONAR LE bundled with mixer
- Rack ears available

Block Diagram

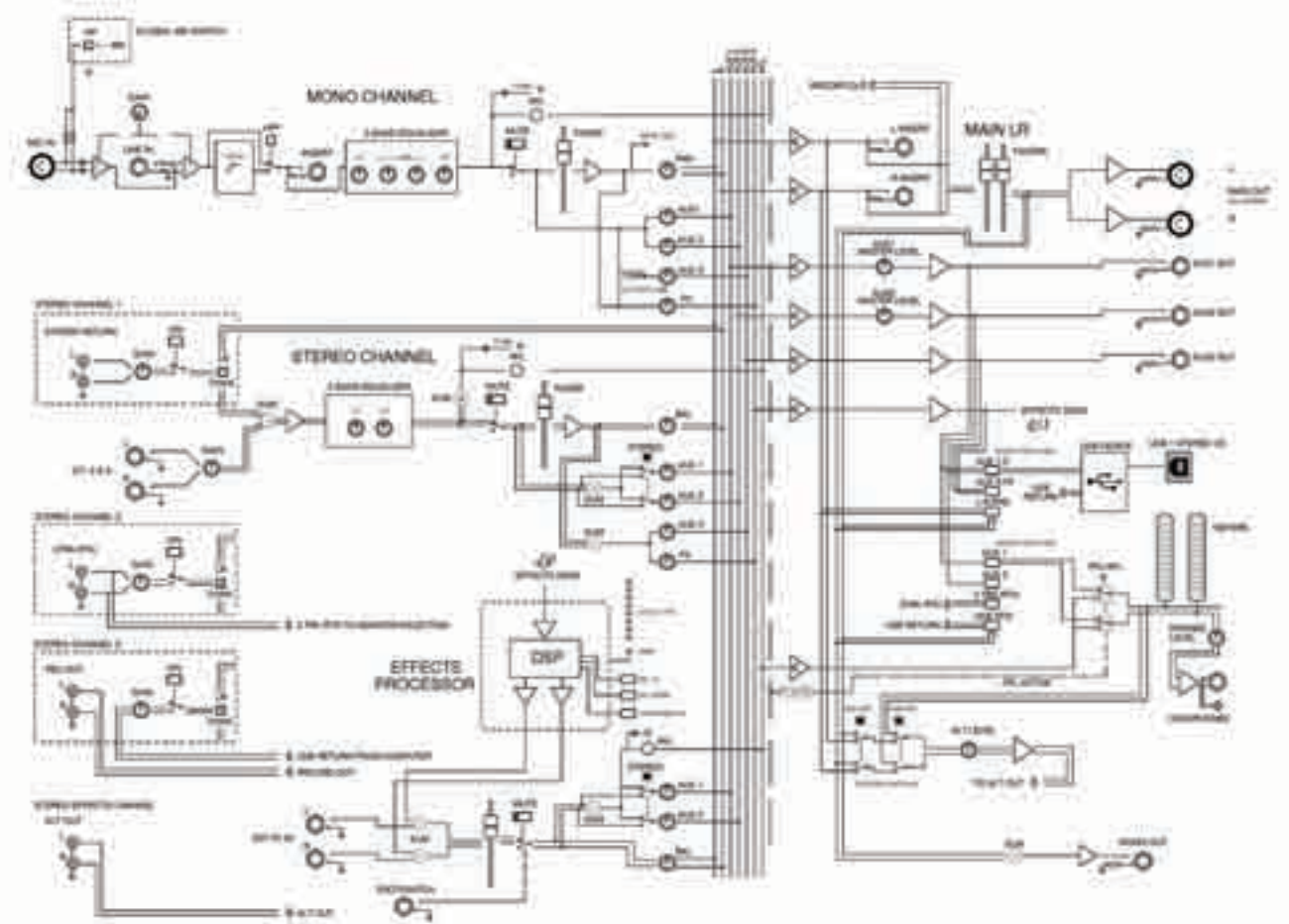



4 Bus Mixer for live sound and recording

- 16, 24 or 32 mono channels
- 2 dual stereo inputs with 4-band EQ
- Neutrik mic XLR
- Neutrik 1/4 inch jacks
- Channel insert
- Super wide gain 'DuoPre' mic line input
- 4-band EQ with 2 swept mids and in/out switch
- Illuminated mute
- Sound image pan
- Illuminated PFL & peak warning indicator
- ALPS 100mm faders
- 6 auxiliary sends (2 pre, 2 post, 2 pre/post)
- 4 sub groups fed from each channel
- All inputs with level control
- 12 bar meters
- L, R and M main mix outputs
- 2 matrix sections available; can send output to USB
- Individual channel 48V phantom power
- Direct output on every mono channel
- Peak and signal indication on every channel
- Configurable USB stereo audio in/out
- Master level controls on all outputs
- Easy to use layout – all connections and controls on top surface
- Cakewalk SONAR LE bundled with mixer

Block Diagram

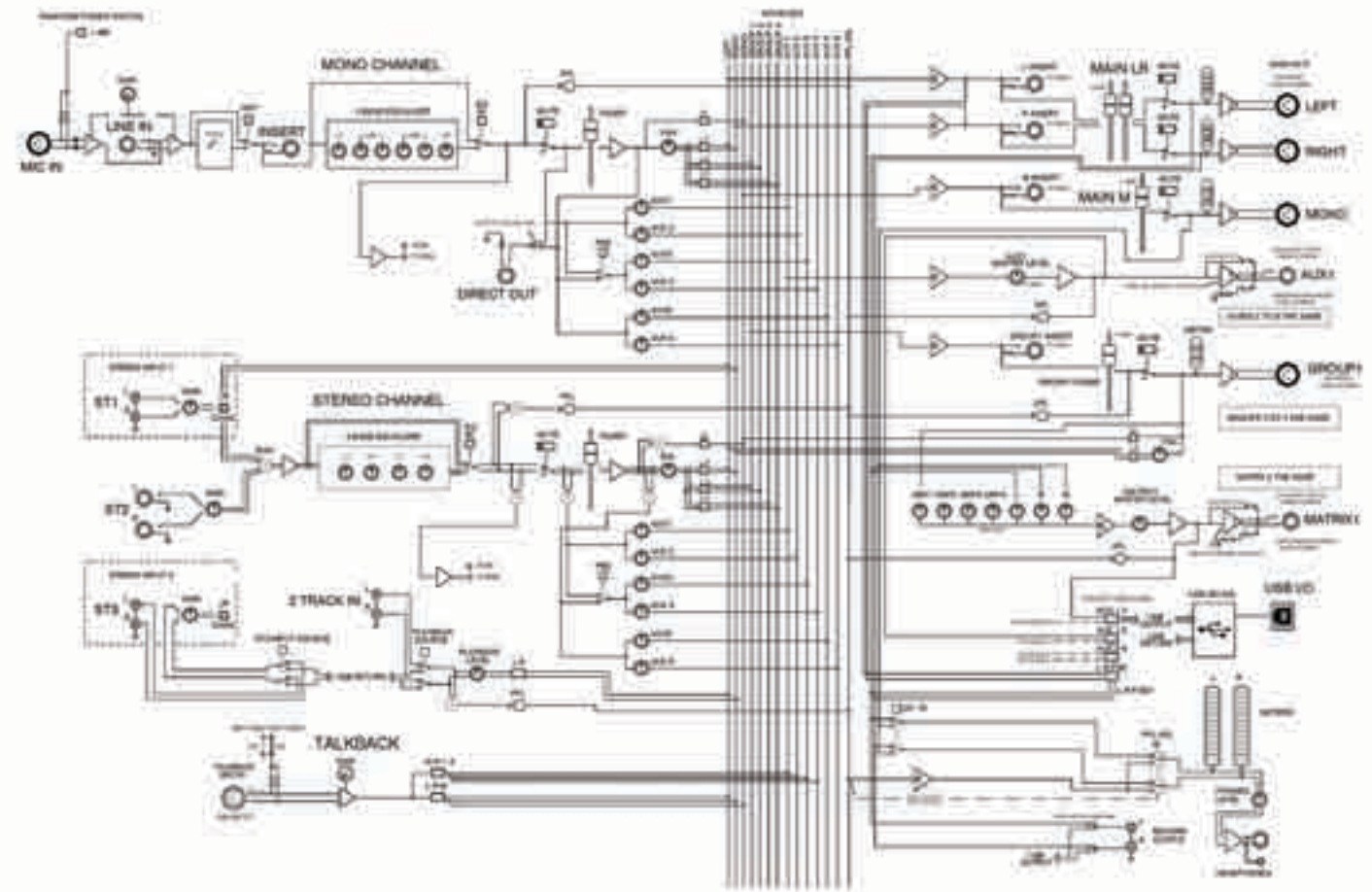

Applications

ZED-10FX Set up



ZED-FX Set up

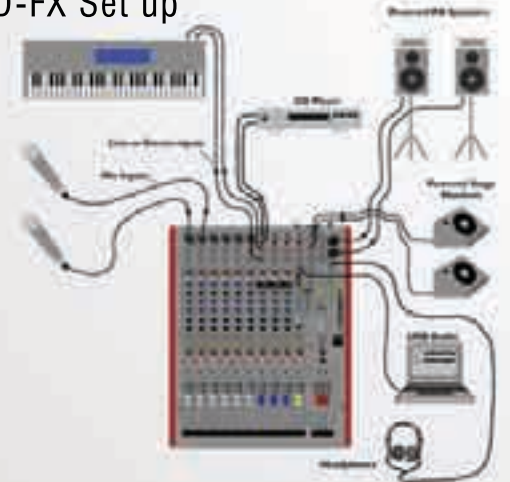

ZED-14 Recording Set up

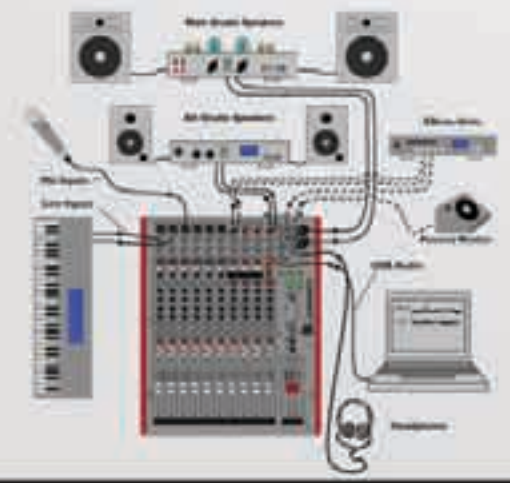

Technical Specs

ZED-10, ZED-10FX

Operating Levels: Inputs

Mono channel (XLR) Input -10 to -60dBu for nominal (+11dBu in max)
 Mono channel Line Input (Jack socket) +10 to -40dBu (+31dBu maximum)
 Stereo Input (Jack or phono sockets) 0dBu nominal (control = Off to +15dB)

Outputs

L/R Outputs (XLR) 0dBu nominal. +21dBu maximum.
 Aux & FX Outputs (Jack sockets) 0dBu nominal. +21dBu maximum.
 Record & Monitor Outputs (phono sockets) 0dBu nominal. +21dBu maximum.

Frequency Response

Mic in to Mix L/R Out, 30dB gain +0.5/-1dB 10Hz to 30kHz.
 Line in to Mix L/R out 0dB gain +0.5/-1dB 10Hz to 30kHz.
 Stereo in to Mix L/R out +0.5/-1dB 10Hz to 30kHz.

THD+n

Mic in to Mix L/R Out, 10dB gain 1kHz +10dBu out 0.002%
 Mic in to Mix L/R Out, 30dB gain 1kHz 0.01%
 Line in to Mix L/R out 0dB gain 0dBu 1kHz 0.003%
 Stereo in to Mix L/R out 0dB gain +10dBu 1kHz 0.002%
 Gtr Input to Mix L/R Out, 0dBu, Boost OUT 0.015%
 Gtr Input to Mix L/R Out, 0dBu, Boost IN 2% Second Harmonic

Headroom

Analogue Headroom from nominal (0Vu) 21dB.
 USB in & out headroom from nominal (0Vu) 14dB.

Noise

Mic Pre EIN @ max gain 150R input Z 22-22kHz -127dBu
 Mix L/R out, L/R faders = 0, Levels min, 22-22kHz -96dBu
 Mix L/R out, L/R faders = 0, Levels min, 22-22kHz -96dBu

The software within the ZED-FX is copyrighted and its use is subject to acceptance of Allen & Heath's End User Licence Agreement - see website for more details.

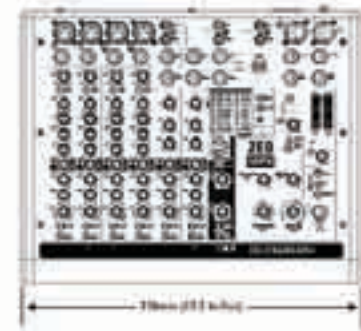

	Weight	
	Unpacked	Packed
ZED-10	3.3kg (7.3 lb)	4.5kg (10 lb)
ZED-10FX	3.3kg (7.3 lb)	4.5kg (10 lb)

ZED-14, ZED-24, ZED-12FX, ZED-22FX

Operating Levels: Inputs

Mono channel (XLR) Input +6 to -63dBu for nominal (+17dBu in max)
 Mono channel Line Input (Jack socket) +10 to -26dBu (+30dBu maximum)
 Insert point (TRS Jack socket) 0dBu nominal +21dBu maximum
 Stereo Input (Jack sockets) 0dBu nominal (control = Off to +10dB)
 Stereo input (phono sockets) 0dBu nominal (control = Off to +10dB)

Outputs

L, R & Mono Outputs (L&R XLR, Mono Jack) 0dBu nominal. +21dBu maximum.
 Aux Outputs (Jack sockets) 0dBu nominal. +21dBu maximum.
 Alt Outputs (phono sockets) 0dBu nominal. +21dBu maximum.
 Rec Outputs (phono sockets) 0dBu nominal. +21dBu maximum.

Frequency Response

Mic in to Mix L/R Out, 30dB gain +0.5/-1dB 20Hz to 20kHz.
 Line in to Mix L/R out 0dB gain +0.5/-1dB 10Hz to 30kHz
 Stereo in to Mix L/R out +0.5/-1dB 10Hz to 30kHz

THD+n

Mic in to Mix L/R Out, 0dB gain 1kHz +10dBu out 0.004%.
 Mic in to Mix L/R Out, 30dB gain 1kHz 0.014%.
 Line in to Mix L/R out 0dB gain 0dBu 1kHz 0.005%.
 Stereo in to Mix L/R out 0dB gain +10dBu 1kHz 0.003%.

Headroom

Analogue Headroom from nominal (0Vu) 21dB.
 USB in & out headroom from nominal (0Vu) 14dB.

Noise

Mic Pre EIN @ max gain 150R input Z 22-22kHz -127dBu
 Mix L/R out, L/R faders = 0, 22-22kHz -88dBu (ZED-14).
 Mix L/R out, L/R faders = 0, 22-22kHz -84dBu (ZED-24).

The software within the ZED-FX is copyrighted and its use is subject to acceptance of Allen & Heath's End User Licence Agreement - see website for more details.

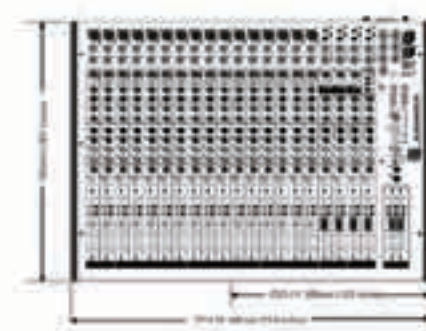

	Weight	
	Unpacked	Packed
ZED-14	6.5kg (14.3 lb)	10.5kg (23.1 lb)
ZED-24	10.5kg (23.1 lb)	19kg (42 lb)
ZED-12FX	6.5kg (14.3 lb)	10.5kg (23.1 lb)
ZED-22FX	10.5kg (23.1 lb)	19kg (42 lb)

ZED-420, ZED-428, ZED-436

Operating Levels

Inputs

Mono channel (XLR) Input +6 to -63dBu for nominal (+17dBu in max)
 Mono channel Line Input (Jack socket) +10 to -26dBu (+30dBu maximum)
 Insert point (TRS Jack socket) 0dBu nominal +21dBu maximum
 Stereo Input (Jack sockets) 0dBu nominal (control = Off to +10dB)
 Stereo input (phono sockets) 0dBu nominal (control = Off to +10dB)
 2 Track Input (phono sockets) 0dBu nominal +21dBu maximum

Outputs

L, R & Mono Outputs (XLR) +4dBu nominal. +27dBu maximum.
 L, R & M Insert (TRS Jack socket) -2dBu nominal +21dBu maximum
 Group Outputs (Jack sockets) +4dBu nominal. +27dBu maximum.
 Group Insert (TRS Jack socket) -2dBu nominal +21dBu maximum
 Aux Outputs (Jack sockets) -2dBu nominal +21dBu maximum (Bal Option +4)
 Matrix Outputs (TRS Jack socket) -2dBu nominal. +21dBu maximum. (Bal Option +4)
 2 Track Output (phono sockets) 0dBu nominal. +21dBu maximum.
 Direct Out (TRS Jack socket) 0dBu nominal. +21dBu maximum.

Frequency Response

Mic in to Mix L/R Out, 30dB gain +0.5/-1dB 20Hz to 20kHz.
 Line in to Mix L/R out 0dB gain +0.5/-1dB 10Hz to 30kHz
 Stereo in to Mix L/R out +0.5/-1dB 10Hz to 30kHz

THD+n

Mic in to Mix L/R Out, 0dB gain 1kHz +10dBu out 0.004%
 Mic in to Mix L/R Out, 30dB gain 1kHz 0.014%
 Line in to Mix L/R out 0dB gain 0dBu 1kHz 0.005%
 Stereo in to Mix L/R out 0dB gain +10dBu 1kHz 0.003%

Headroom

Analogue Headroom from nominal (0Vu) 21dB
 USB in & out headroom from nominal (0Vu) 14dB
 USB Audio CODEC (Coder/Decoder)
 USB Audio In/Out USB 1.1 compliant 16bit.
 Sample Rate 32, 44.1, or 48kHz

Noise

Mix Noise, LR out, 16 channels routed, Ref +4dBu, 22-22kHz -90dB (-86dBu)
 Mix Noise, LR out, 24 channels routed, Ref +4dBu, 22-22kHz -89dB (-85dBu)
 Mix Noise, LR out, 32 channels routed, Ref +4dBu, 22-22kHz -88dB (-84dBu)
 Mic Pre EIN @ max gain 150R input Z 22-22kHz -127dBu

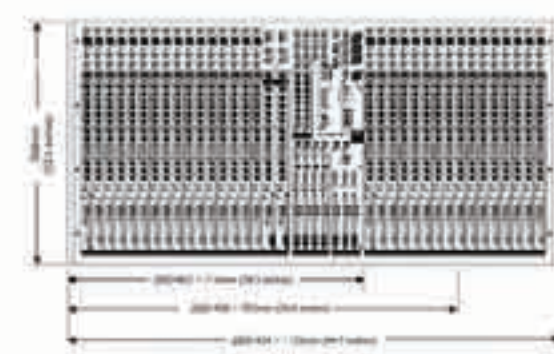

	Weight	
	Unpacked	Packed
ZED-420	14kg (31 lb)	17.5kg (38.5 lb)
ZED-428	19kg (40 lb)	22.5kg (50.25 lb)
ZED-436	23kg (48.5 lb)	26.5kg (58.3 lb)