

# CTK-6000 WK-6500

## USER'S GUIDE

Please keep all information for future reference.

### **Safety Precautions**

Before trying to use the keyboard, be sure to read the separate "Safety Precautions".

E



## **NOTICE**

This equipment has been tested and found to comply with the limits for a Class B digital device, pursuant to Part 15 of the FCC Rules. These limits are designed to provide reasonable protection against harmful interference in a residential installation. This equipment generates, uses and can radiate radio frequency energy and, if not installed and used in accordance with the instructions, may cause harmful interference to radio communications. However, there is no guarantee that interference will not occur in a particular installation. If this equipment does cause harmful interference to radio or television reception, which can be determined by turning the equipment off and on, the user is encouraged to try to correct the interference by one or more of the following measures:

- Reorient or relocate the receiving antenna.
- Increase the separation between the equipment and receiver.
- Connect the equipment into an outlet on a circuit different from that to which the receiver is connected.
- Consult the dealer or an experienced radio/TV technician for help.

## **FCC WARNING**

Changes or modifications not expressly approved by the party responsible for compliance could void the user's authority to operate the equipment.

## **Declaration of Conformity**

Model Number: CTK-6000/WK-6500

Trade Name: CASIO COMPUTER CO., LTD.

Responsible party: CASIO AMERICA, INC.

Address: 570 MT. PLEASANT AVENUE, DOVER, NEW JERSEY 07801

Telephone number: 973-361-5400

This device complies with Part 15 of the FCC Rules, Operation is subject to the following two conditions:

(1) This device may not cause harmful interference, and (2) this device must accept any interference received, including interference that may cause undesired operation.

## **Important!**

Please note the following important information before using this product.

- Before using the optional AC Adaptor to power the unit, be sure to check the AC Adaptor for any damage first. Carefully check the power cord for breakage, cuts, exposed wire and other serious damage. Never let children use an AC adaptor that is seriously damaged.
- Never attempt to recharge batteries.
- Do not use rechargeable batteries.
- Never mix old batteries with new ones.
- Use recommended batteries or equivalent types.
- Always make sure that positive (+) and negative (-) poles are facing correctly as indicated near the battery compartment.
- Replace batteries as soon as possible after any sign they are getting weak.
- Do not short-circuit the battery terminals.
- The product is not intended for children under 3 years.
- Use only a CASIO AD-A12150LW adaptor.
- The AC adaptor is not a toy.
- Be sure to disconnect the AC adaptor before cleaning the product.



This mark applies in EU countries only.



Manufacturer:  
CASIO COMPUTER CO.,LTD.  
6-2, Hon-machi 1-chome, Shibuya-ku, Tokyo 151-8543, Japan  
Responsible within the European Union:  
CASIO EUROPE GmbH  
Casio-Platz 1, 22848 Norderstedt, Germany

- Any reproduction of the contents of this manual, either in part or its entirety, is prohibited. Except for your own, personal use, any other use of the contents of this manual without the consent of CASIO is prohibited under copyright laws.
- IN NO EVENT SHALL CASIO BE LIABLE FOR ANY DAMAGES WHATSOEVER (INCLUDING, WITHOUT LIMITATION, DAMAGES FOR LOSS OF PROFITS, BUSINESS INTERRUPTION, LOSS OF INFORMATION) ARISING OUT OF THE USE OF OR INABILITY TO USE THIS MANUAL OR PRODUCT, EVEN IF CASIO HAS BEEN ADVISED OF THE POSSIBILITY OF SUCH DAMAGES.
- The contents of this manual are subject to change without notice.
- The actual appearance of the product may be different from that shown in the illustrations in this User's Guide.
- Company and product names used in this manual may be registered trademarks of others.

# Contents

## **General Guide ..... E-4**

Reading the Display .....	E-6
Modes.....	E-7
Menus.....	E-7
▲ Precautions while “Please Wait” is displayed .....	E-7
Saving Settings .....	E-8
Returning the Digital Keyboard to Its Factory Default Settings .....	E-8

## **Getting Ready to Play ..... E-9**

Preparing the Music Stand .....	E-9
Power Supply .....	E-9

## **Connections..... E-11**

Connecting Headphones.....	E-11
Connecting a Pedal .....	E-11
Connecting a Microphone (WK-6500 only).....	E-11
Connecting Audio Equipment or an Amplifier .....	E-12
Bundled and Optional Accessories .....	E-12

## **Selecting and Playing a Tone.. E-13**

To turn on Digital Keyboard power .....	E-13
Listening to Demo Tunes .....	E-14
Selecting a Tone .....	E-14
Layering and Splitting Tones.....	E-15
Raising and Lowering Keyboard Tuning (Transpose) .....	E-18
Using Octave Shift.....	E-18
Using the Metronome .....	E-19
Using the Pitch Bend Wheel.....	E-20
Selecting a Temperament and Fine Tuning Its Scale.....	E-21
Playing Arpeggio Phrases Automatically (Arpeggiator) .....	E-23

## **Using Auto Accompaniment ... E-24**

Playing an Auto Accompaniment .....	E-24
Selecting a Chord Fingering Mode.....	E-26
Modifying Auto Accompaniment Patterns.....	E-27
Using One-Touch Presets .....	E-27
Using Auto Harmonize .....	E-28
Using the Rhythm Editor .....	E-29

## **Applying Effects to a Sound.... E-32**

Configuration of Effects.....	E-32
Selecting an Effect.....	E-34
Creating a User DSP .....	E-37

## **Using the Mixer ..... E-39**

Mixer Overview .....	E-39
Mixer Operation .....	E-40
Mixer Parameter Settings .....	E-42

## **Using the Tone Editor..... E-45**

Tone Creation Overview .....	E-45
Creating a User Tone.....	E-46
Tone Parameter Settings .....	E-48

## **Music Presets..... E-50**

Using Music Presets .....	E-50
Creating a User Preset .....	E-54
Editing a Chord Progression .....	E-58

## **Saving Keyboard Setups to Registration Memory ..... E-62**

To save a setup to registration memory .....	E-63
To recall a setup from registration memory .....	E-63

## **Using the Song Sequencer ..... E-64**

Starting One-touch Recording (EASY REC)....	E-64
What you can do with the song sequencer .....	E-66
Recording Individual Tracks.....	E-68
Using Panel Record to Rewrite Song Header Settings.....	E-72
Playing a Recorded Song .....	E-73
Editing a Song.....	E-75
Editing a Track .....	E-79
Editing Events .....	E-81
Directly Inputting Note Events (Step Input).....	E-94

## **Using the Function Menu..... E-96**

Using the Function Menu .....	E-96
Function Menu Settings .....	E-97

**Using a Memory Card..... E-102**

Loading and Removing a Memory Card.....	E-103
Entering the Card Mode .....	E-103
Formatting a Memory Card.....	E-103
Saving Digital Keyboard Data to a Memory Card.....	E-104
Loading Data from a Memory Card .....	E-106
To delete a file from a memory card.....	E-107
To rename a file on a memory card.....	E-107
Playing a Music File from a Memory Card.....	E-108
Error Messages .....	E-111

**Connecting to a Computer .... E-112**

Minimum Computer System Requirements....	E-112
Storing and Loading Digital Keyboard Memory Data.....	E-113

**Reference ..... E-114**



Troubleshooting.....	E-114
Specifications .....	E-116
Operating Precautions.....	E-118
DSP Effect List .....	E-119
Fingering Guide .....	E-124
Supported Input Characters .....	E-124
Chord Example List .....	E-125
Assigning a MIDI Channel to Each Part .....	E-126
Parameter List .....	E-127



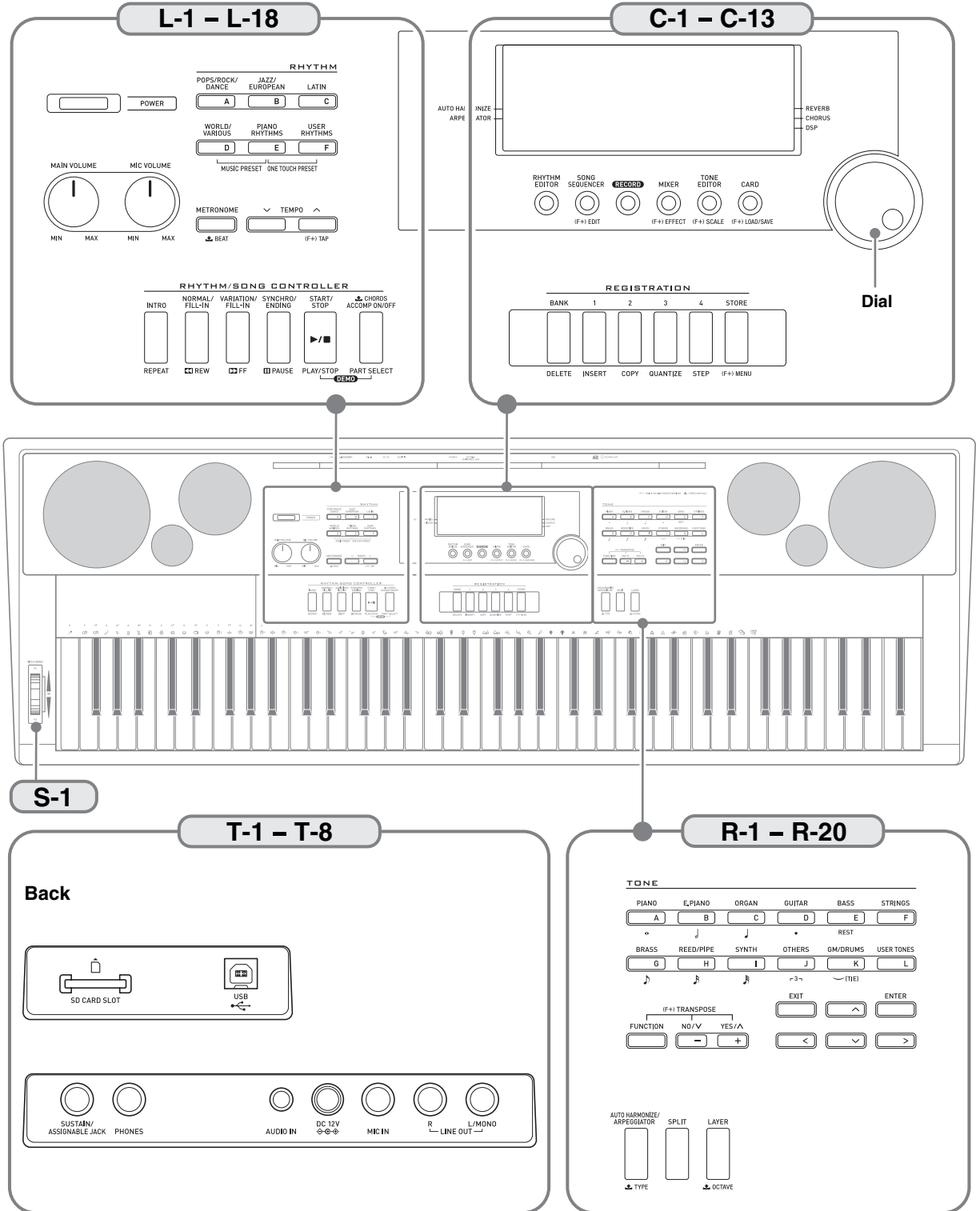

**MIDI Implementation Chart**

# General Guide













• Illustrations in this User's Guide show the WK-6500.



- In this manual, the term “Digital Keyboard” refers to the CTK-6000/WK-6500.
- This manual uses the numbers and names below to refer to buttons and controllers.
- The following explains the meanings of the (F+) and  symbols that appear on the product console and with the key names below.
  - (F+): Indicates a function that is enabled by holding down the **R-13 (FUNCTION)** button when pressing a button. For example, SONG SEQUENCER, (F+) EDIT means that the EDIT function is enabled by depressing the **R-13 (FUNCTION)** button.
  -  : Indicates a function that is enabled by holding down the button for some time. For example, METRONOME, BEAT  means that the BEAT function is enabled by holding down the button for some time.

- L-1 **POWER** button . . . . .  13
- L-2 **VOLUME** knob (CTK-6000) . . . . .  13  
**MAIN VOLUME** knob (WK-6500) . . . . .  13
- L-3 **MIC VOLUME** knob (WK-6500 only) . . . . .  11







**RHYTHM buttons**

- L-4 **[A] POPS/ROCK/DANCE** button . . . . .  14, 24
- L-5 **[B] JAZZ/EUROPEAN** button . . . . .  24
- L-6 **[C] LATIN** button . . . . .  24
- L-7 **[D] WORLD/VARIOUS, MUSIC PRESET** button . . . . .  24, 50
- L-8 **[E] PIANO RHYTHMS, ONE TOUCH PRESET** button . . . . .  24, 27, 50
- L-9 **[F] USER RHYTHMS** button . . . . .  24, 27
- L-10 **METRONOME,  BEAT** button . . . . .  19
- L-11 **TEMPO ** button . . . . .  19
- L-12 **TEMPO , (F+)TAP** button . . . . .  19







































**RHYTHM/SONG CONTROLLER buttons**

- L-13 **INTRO, REPEAT** button . . . . .  27, 74, 108
- L-14 **NORMAL/FILL-IN,  REW** button .  14, 27, 73, 108
- L-15 **VARIATION/FILL-IN,  FF** button .  14, 27, 73, 108
- L-16 **SYNCHRO/ENDING, PAUSE** button  24, 27, 73, 108
- L-17 **START/STOP, PLAY/STOP, DEMO** button . . . . .  14, 24, 73, 108
- L-18 **ACCOMP ON/OFF,  CHORDS, PART SELECT, DEMO** button . . . . .  14, 24, 26, 109
- C-1 **Display** . . . . .  6
- C-2 **RHYTHM EDITOR** button . . . . .  29
- C-3 **SONG SEQUENCER, (F+)EDIT** button . . . . .  7, 68, 75
- C-4 **RECORD** button . . . . .  64, 68, 69
- C-5 **MIXER, (F+)EFFECT** button . . . . .  34, 40
- C-6 **TONE EDITOR, (F+)SCALE** button . . . . .  21, 46
- C-7 **CARD, (F+)LOAD/SAVE** button . . . . .  7, 103, 104, 106  
 Dial. . . . .  6, 14, 24

**REGISTRATION buttons**

- C-8 **BANK, DELETE** button . . . . .  59, 62, 86, 93
- C-9 **1, INSERT** button . . . . .  59, 62, 88, 94
- C-10 **2, COPY** button . . . . .  62, 88
- C-11 **3, QUANTIZE** button . . . . .  62, 89
- C-12 **4, STEP** button . . . . .  60, 62, 94
- C-13 **STORE, (F+)MENU** button . . . . .  7, 62

**TONE buttons**

- R-1 **[A] PIANO, ** button . . . . .  14, 59, 88
- R-2 **[B] E. PIANO, ** button . . . . .  14, 59, 88
- R-3 **[C] ORGAN, ** button . . . . .  14, 59, 88, 89
- R-4 **[D] GUITAR, ** button . . . . .  14, 59, 88
- R-5 **[E] BASS, REST** button . . . . .  14, 94
- R-6 **[F] STRINGS** button . . . . .  14
- R-7 **[G] BRASS, ** button . . . . .  14, 59, 88, 89
- R-8 **[H] REED/PIPE, ** button . . . . .  14, 59, 88, 89
- R-9 **[I] SYNTH, ** button . . . . .  14, 88, 89
- R-10 **[J] OTHERS, ** button . . . . .  14, 59, 88, 89
- R-11 **[K] GM/DRUMS, ** (TIE) button . . . . .  14, 94
- R-12 **[L] USER TONES** button . . . . .  14, 46
- R-13 **FUNCTION** button . . . . .  96
- R-14 **NO/V/-, YES/^/+ , (F+)TRANSPOSE** buttons . . . . .  6, 14, 18, 24
- R-15 **EXIT** button
- R-16 **ENTER** button
- R-17 **<, ^, v, >** buttons . . . . .  7
- R-18 **AUTO HARMONIZE/ARPEGGIATOR,  TYPE** button . . . . .  23, 28
- R-19 **SPLIT** button . . . . .  15
- R-20 **LAYER,  OCTAVE** button . . . . .  15, 18
- S-1 **PITCH BEND** wheel . . . . .  20
- T-1 **SD CARD SLOT** . . . . .  102
- T-2 **USB** jack . . . . .  112
- T-3 **SUSTAIN/ASSIGNABLE JACK** . . . . .  11
- T-4 **PHONES** jack . . . . .  11
- T-5 **AUDIO IN** jack . . . . .  12
- T-6 **DC 12V** jack . . . . .  9
- T-7 **MIC IN** jack (WK-6500 only) . . . . .  11
- T-8 **LINE OUT R, L/MONO** jacks . . . . .  12

## Reading the Display

This section explains the contents of the Digital Keyboard's display screen.

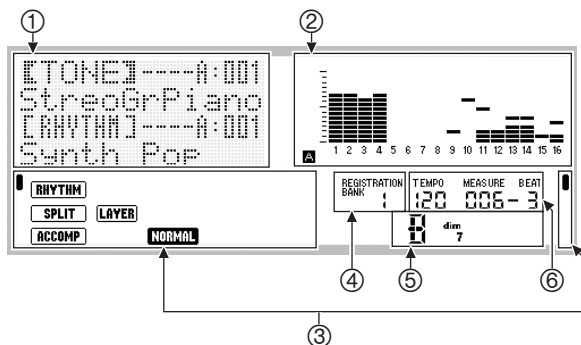

### ① Detailed information area

This area displays a variety of information while the Digital Keyboard is being used. Use this area to confirm proper operation when changing values, when selecting a menu item, and when performing other operations.

### ② Level meter area

This level meter shows the volume level of the notes that are sounded when you play something on the keyboard or when Auto Accompaniment is played. There are a total of 32 parts, 16 each in Group A and Group B. The **A** indicator will be displayed in the lower left corner while Group A parts are being indicated by the level meter, while the **B** indicator will be displayed in the lower left corner while Group B parts are being indicated.

For details about parts, see "How Parts are Organized" (page E-39).

### ③ Indicator areas

The indicator area shows such information as the current mode (page E-7), the status of settings, the status of Auto Accompaniment, and other information.

There are two types of indicators: text type indicators such as **[RHYTHM]**, and pointer (**●**) type indicators. In the case of pointer type indicators, a setting or status is indicated by the location of the **●** next to fixed text along the sides of the display. For example, the location of the pointer (**●**) on the right side of the display in the sample below indicates REVERB.

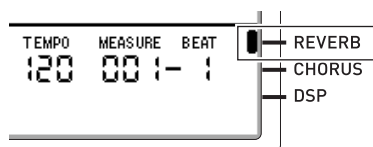

### ④ Registration bank area

This area shows the number of the currently selected registration bank (page E-62).

### ⑤ Chord area

This area shows the chord being played when Auto Accompaniment (page E-24) or music preset (page E-50) is being used. It also can display fraction chords by showing the chord root (C, G, etc.) and type (m, 7th, etc.).

### ⑥ Tempo, measure, beat area

Tempo is shown as the current setting value, as beats per minute. Auto Accompaniment, the metronome (page E-19), and other playback is performed at the tempo shown here. The MEASURE and BEAT values are counted up as Auto Accompaniment, the metronome, or other playback progresses.

## Currently Selected Item Indication

The item that is currently selected on a display screen is indicated by thick brackets (**[ ]**) and by a large dot (**●**). The currently selected item is the one that is affected by the **R-14** (**-**, **+**) buttons or dial operations.



On this screen, "RHYTHM" is selected because it is enclosed by thick brackets. This indicates that the rhythm setting can be changed.



On this screen, "Touch" is selected because the **●** is next to it. This indicates that the value to the right of "Touch", which is enclosed in thick brackets, can be changed.



## Modes

Your Digital Keyboard has three modes: a rhythm mode, a card mode, and a song sequencer mode. The currently selected mode is shown as an indicator on the display.

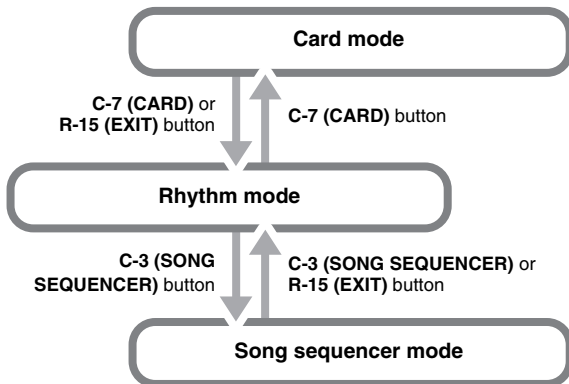

- **Rhythm mode** (**RHYTHM** indicator displayed)  
The rhythm mode is the initial power on default mode. The rhythm mode is the base mode, and it is the mode you should enter when you want to play on the keyboard or use Auto Accompaniment.
- **Card mode** (**CARD** indicator displayed)  
Enter the card mode when you want to perform memory card operations. See “Using a Memory Card” (page E-102) for more information.
  - In the rhythm mode, pressing the **C-7 (CARD)** button will enter the card mode.
  - In the card mode, pressing the **C-7 (CARD)** button or the **R-15 (EXIT)** button will return to the rhythm mode.
- **Song sequencer mode** (**SEQUENCER** indicator displayed)  
Enter the sequencer mode when you want to record performances using the keyboard and Auto Accompaniment, or to play back song data. For details, see “Using the Song Sequencer” (page E-64).
  - In the rhythm mode, pressing the **C-3 (SONG SEQUENCER)** button will enter the song sequencer mode.
  - In the song sequencer mode, pressing the **C-3 (SONG SEQUENCER)** button or the **R-15 (EXIT)** button will return to the rhythm mode.

### IMPORTANT!

- **After entering any mode besides the rhythm mode and performing the operations you want, be sure to return to the rhythm mode. The rhythm mode is the initial power on default mode.**
- **Unless otherwise specifically noted, all of the operations described in this user’s guide are performed in the rhythm mode.**

## Menus

You can use the same operations to display mode and function specific menus. To display a menu, hold down the **R-13 (FUNCTION)** button as you press the **C-13 (MENU)** button. For example, the “Performance” menu shown below will appear if you perform the above operation while in the rhythm mode. This menu provides instant access to performance functions.



- The currently selected item is the one with the ● next to it. You can use the **R-17 (▲, ▼)** buttons to move the ● up and down. You also can use the **R-17 (◀, ▶)** buttons to scroll between menu pages.
- To exit a displayed menu, press the **R-15 (EXIT)** button. You may need to press the **R-15 (EXIT)** button more than once in some cases.
- The menu items and operations for specific modes and functions are described in each section of this user’s guide.

### ⚠ Precautions while “Please Wait” is displayed

Never try to perform any operation, or insert or remove a memory card while the message “Please Wait” is on the display. Wait until the message disappears.

- “Please Wait” indicates that the Digital Keyboard is performing a data save operation. Turning off the Digital Keyboard or removing the memory card can cause Digital Keyboard data to be deleted or become corrupted. It also can cause the Digital Keyboard to fail to turn on when the **L-1 (POWER)** button is pressed.
- If this happens, refer to “Troubleshooting” (page E-114).

## Saving Settings

Your Digital Keyboard is equipped with a song sequencer and other features that you can use to store data you create. This stored data is retained even when the Digital Keyboard is turned off.\*

However, the tone, rhythm, and other settings you configure on the Digital Keyboard's console normally are returned to their initial power on defaults whenever you turn off power. You can configure the Digital Keyboard so it remembers its latest setup or to apply a predetermined default setup each time you turn it on. For details, see "AutoResume (Auto Resume)" (page E-100) and "Default (Default Settings)" (page E-100).

\* The following data and settings are always retained even when power is turned off.

- Registration setup data (page E-62)
- Song sequencer data (page E-64)
- User rhythm data (page E-29)
- User preset data (page E-54)
- User tone data (page E-45)
- User DSP data (page E-37)
- LCD Contrast setting (page E-99)
- Auto Resume setting (page E-100)

## Returning the Digital Keyboard to Its Factory Default Settings

You can delete all data in keyboard memory and return all keyboard parameters to their initial factory default settings. For details, see "To initialize all data and settings (or parameter settings only)" (page E-101).



# Getting Ready to Play

## Preparing the Music Stand

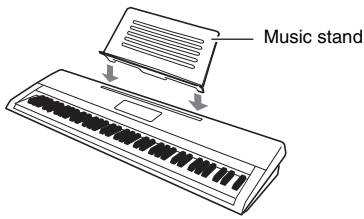

## Power Supply

Prepare a household power outlet or batteries.

### ! IMPORTANT!

- Be sure to comply with the separate “Safety Precautions”. Incorrect use of this product creates the risk of electric shock and fire.
- Always make sure that the product is turned off before plugging in or unplugging the AC adaptor, or before loading or removing batteries.

## Using a Household Power Outlet

Make sure that you use only the AC adaptor (JEITA Standard, with unified polarity plug) specified for this product. Use of a different type of AC adaptor can cause malfunction.

### Specified AC Adaptor: AD-A12150LW

Use the supplied power cord to connect the AC adaptor as shown in the illustration below.

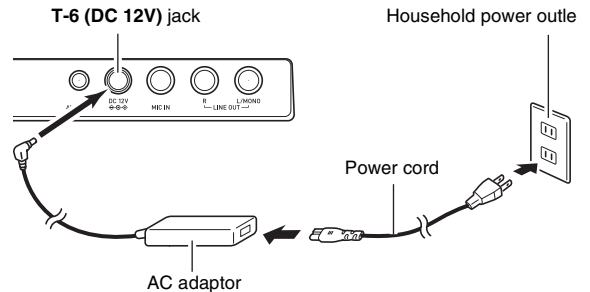

### ! IMPORTANT!

- The AC adaptor will become warm to the touch after very long use. This is normal and does not indicate malfunction.
- To prevent breaking of the wire, take care to avoid putting any type of load on the power cord.

No bending!

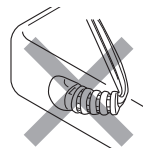

No winding!

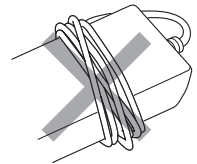

- Never insert metal, pencils, or any other objects into the product's DC 12V jack. Doing so creates the risk of accident.

## Using Batteries

You can use six D-size batteries for power.

- Use alkaline or zinc-carbon batteries.  
Never use oxyride or any other nickel based batteries.

### 1. Open the battery cover on the bottom of the Digital Keyboard.

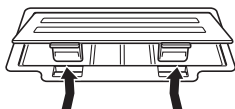

### 2. Load six D-size batteries into the battery compartment.

- Make sure the positive ⊕ and negative ⊖ ends of the batteries are facing as shown in the illustration.

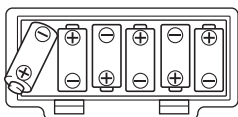

### 3. Insert the tabs of the battery cover into the holes on the side of the battery compartment, and close the cover.

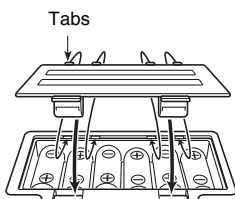

## Low Battery Indication

The following shows the approximate battery life.

### 4 hours\* on alkaline batteries

- \* The above values are standard battery life at normal temperature, with the volume at medium setting.  
Temperature extremes or playing at very loud volume settings can shorten battery life.

The indicators shown below start to flash to let you know when battery power is low. Replace the batteries with new ones.

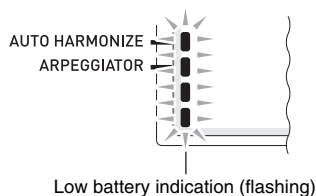

# Connections

## Connecting Headphones

Using headphones cuts off output from the built-in speakers, which means you can practice playing even late at night without disturbing others.

- Be sure to turn down the volume level before connecting headphones.

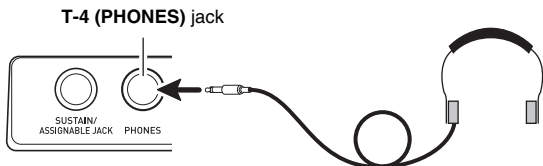

### NOTE

- Headphones do not come with the Digital Keyboard.
- Use commercially available headphones.

### IMPORTANT!

- **Do not listen to very high volume output over headphones for long periods. Doing so creates the risk of hearing damage.**
- **If you are using headphones that require an adaptor plug, make sure you do not leave the adaptor plugged in when removing the headphones.**

## Connecting a Pedal

Connecting an optionally available pedal lets you perform pedal operations that add more versatility to your keyboard play. For information about the types of effects that can be applied by pressing the pedal, see "Ped.Assign (Pedal Assign)" (page E-97).

T-3 (SUSTAIN/ASIGNABLE) jack

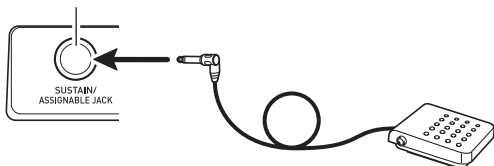

## Connecting a Microphone (WK-6500 only)

You can connect a dynamic microphone (only) to the Digital Keyboard for output through the Digital Keyboard's speakers.

T-7 (MIC IN) jack



- You can adjust the volume level of microphone input with the **L-3 (MIC VOLUME)** knob. Microphone volume control is independent of overall keyboard volume.
- Built-in effects (reverb, chorus, DSP) are also applied to input from the microphone. You also can use the Mixer to adjust how effects are applied, the speaker stereo pan position, and other parameters. For details, see "Selecting and Playing a Tone" (page E-13) and "Using the Mixer" (page E-39).

### IMPORTANT!

- **Before connecting a microphone, make sure that the Digital Keyboard and microphone are turned off.**
- **Before connecting a microphone, set both the L-2 (MAIN VOLUME) and L-3 (MIC VOLUME) knobs to low levels. Adjust volume settings to appropriate levels after connecting the microphone.**

## Connecting Audio Equipment or an Amplifier

You can connect audio equipment or a music amplifier to the Digital Keyboard and then play through external speakers for more powerful volume and better sound quality.

### IMPORTANT!

- Whenever connecting a device to the Digital Keyboard, first use the L-2 (CTK-6000: **VOLUME**) (WK-6500: **MAIN VOLUME**) knob to set the volume to a low level. After connecting, you can adjust the volume to the level you want.
- Whenever you connect any device to the Digital Keyboard, be sure to read the user documentation that comes with the device.

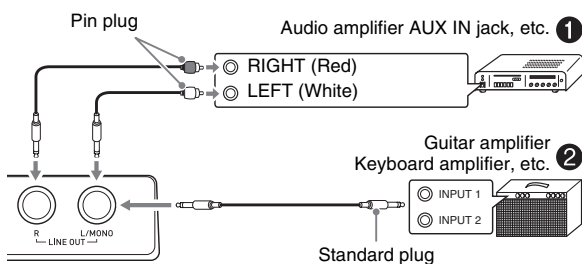

## Outputting Keyboard Notes to Audio Equipment ①

Use commercially available connecting cords to connect the external audio equipment to the Digital Keyboard's T-8 (LINE OUT) jacks as shown in Figure ①. LINE OUT R jack output is right channel sound, while LINE OUT L/MONO jack output is left channel sound. It is up to you to purchase connecting cords like the ones shown in the illustration for connection of audio equipment. Normally in this configuration you must set the audio equipment's input selector to the setting that specifies the terminal (such as AUX IN) to which the Digital Keyboard is connected. Use the L-2 (CTK-6000: **VOLUME**) (WK-6500: **MAIN VOLUME**) knob to adjust the volume level.

## Outputting Keyboard Notes to a Musical Instrument Amplifier ②

Use a commercially available connecting cord to connect the amplifier to either of the Digital Keyboard's T-8 (LINE OUT) jacks as shown in Figure ②. LINE OUT R jack output is right channel sound, while LINE OUT L/MONO jack output is left channel sound. Connecting to the LINE OUT L/ MONO jack only outputs a mixture of both channels. It is up to you to purchase connecting cord like the one shown in the illustration for connection of the amplifier. Use the L-2 (CTK-6000: **VOLUME**) (WK-6500: **MAIN VOLUME**) knob to adjust the volume level.

## Playing an External Device from the Digital Keyboard ③

Use a commercially available connecting cord to connect the external audio equipment to the Digital Keyboard's T-5 (AUDIO IN) jack as shown in Figure ③. The connecting cord should have a stereo mini plug on one end and a plug that matches the configuration of the external device on the other end. Use the L-2 (CTK-6000: **VOLUME**) (WK-6500: **MAIN VOLUME**) knob to adjust the volume level.

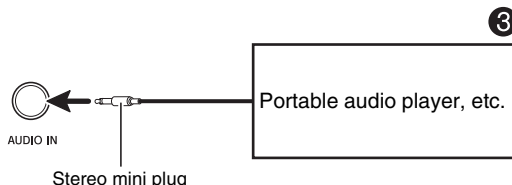

## Bundled and Optional Accessories

Use of unauthorized accessories creates the risk of fire, electric shock, and personal injury.

### NOTE

- You can get information about accessories that are sold separately for this product from the CASIO catalog available from your retailer, and from the CASIO website at the following URL.  
<http://world.casio.com/>



# Selecting and Playing a Tone

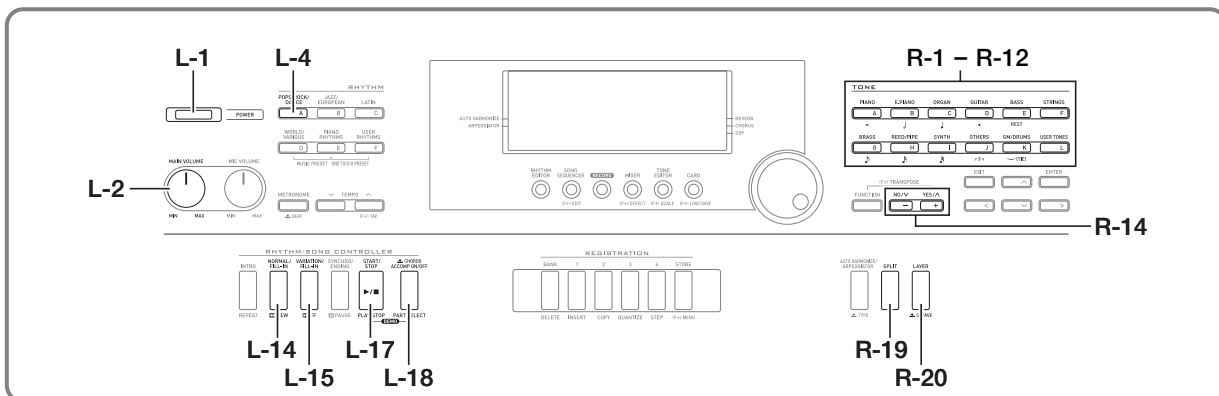

## To turn on Digital Keyboard power

1. Rotate the L-2 (CTK-6000: VOLUME) (WK-6500: MAIN VOLUME) knob towards MIN to set the volume to a low level.
2. Referring to “Connections” (page E-11), connect headphones, amplifier, or other device.
3. Use the L-1 (POWER) button to turn on power.
  - The Digital Keyboard display screen will appear as shown below, which indicates that it is ready to play with a piano tone (using initial power on default settings).

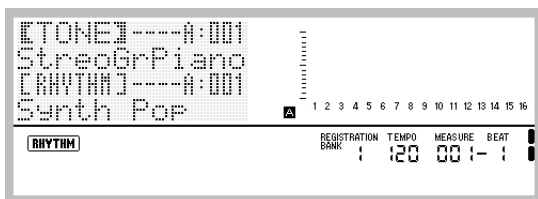

- To turn off the Digital Keyboard, press the L-1 (POWER) button again.

## IMPORTANT!

- Under its initial configuration, the Digital Keyboard will return to its default settings whenever you turn it off. You can change the initial configuration to have the Digital Keyboard remember its latest setup or to apply a predetermined setup each time you turn it on. For details, see “AutoResume (Auto Resume)” (page E-100) and “Default (Default Settings)” (page E-100).
- The message “Please Wait” will remain on the display while a data save operation is in progress. Do not perform any other operation while it is displayed. Turning off the Digital Keyboard or removing the memory card can cause Digital Keyboard data to be deleted or become corrupted. It also can cause the Digital Keyboard to fail to turn on when the L-1 (POWER) button is pressed. If this happens, refer to “Troubleshooting” (page E-114).

## Auto Power Off

This Digital Keyboard is designed to turn off automatically to avoid wasting power after no operation is performed for a preset amount of time. The Auto Power Off trigger time is six minutes under battery power and four hours under AC adaptor power.

- Auto Power Off is enabled while “on” is selected for “AutoPower (Auto Power Off)” (page E-99). The initial default setting is “on”. To disable Auto Power Off, select “oFF” for “AutoPower” (Auto Power Off).
- You also can use the procedure below to temporarily suspend Auto Power Off while it is enabled.

■ To disable Auto Power Off

1. While the Digital Keyboard is turned on, press the L-1 (POWER) button to turn it off.
2. While holding down the L-4 ([A] POPS/ROCK/DANCE) button, press the L-1 (POWER) button to turn on the Digital Keyboard.

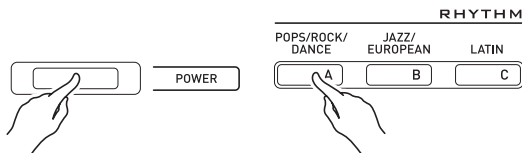

- Auto Power Off will be disabled at this time.

**NOTE**

- Turning off the keyboard after performing the above steps will re-enable Auto Power Off.

## Listening to Demo Tunes

1. While holding down the L-18 (ACCOMP ON/OFF) button, press the L-17 (PLAY/STOP) button.

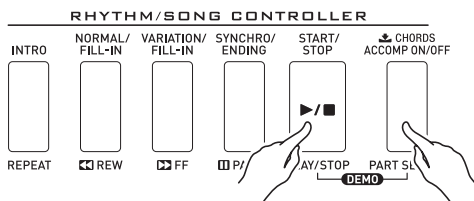

- This starts demo tune play.
- The Digital Keyboard has a total of five demo tunes. You also can use the R-14 (-, +) buttons to select a demo tune.
- Pressing the L-15 (▶▶FF) button performs fast forward play of the demo tune, while the L-14 (◀◀REW) button performs fast backward play. Holding down the L-14 (◀◀REW) button until playback reaches the beginning of the current song will stop playback there. Normal playback will resume when you release the L-14 (◀◀REW) button. Holding down the L-15 (▶▶FF) button continues fast forward playback, even after the end of a song is reached.
- You can play along on the keyboard with demo tune play. Note, however, that you cannot change the tone assigned to the keyboard. Only the key operations described above are supported during demo tune playback.

2. To stop demo tune playback, press the L-17 (PLAY/STOP) button.

## Selecting a Tone

The tones of this Digital Keyboard are divided among groups, each of which corresponds to one of the 12 TONE buttons. You can specify a tone by its group and its tone number. Use the following procedure to select a single tone that is applied across the entire keyboard.

### To select a tone

1. Refer to the separate “Appendix” to look up the group and the number of the tone you want to select.
2. Check to make sure that the **SPLIT** and **LAYER** indicators are not on the display.
  - If they are displayed, press the R-19 (SPLIT) button and/or R-20 (LAYER) button to clear both indicators from the display.
3. Use buttons R-1 ([A] PIANO) through R-12 ([L] USER TONES) to select a tone group.

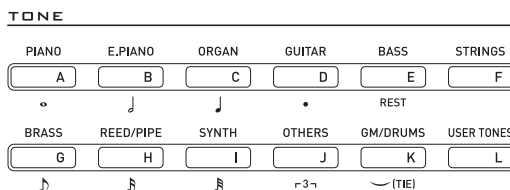

- The R-12 ([L] USER TONES) button selects the user tone group. For details, see “Using the Tone Editor” (page E-45).

4. Use the dial to scroll through the tone numbers until the one you want is displayed.

Example: Group [C], Number 004





**5. Now you can play on the keyboard using the tone you selected.**

**NOTE**

- You also can use the **R-14** (–, +) buttons to select a demo tune. Holding down either button will scroll through tone numbers at high speed. Pressing both of the **R-14** (–, +) buttons at the same time will select tone 001 in the currently selected group.

**Layering and Splitting Tones**

You can configure the keyboard to play two different tones at the same time (Layer) or to play different tones in the left and right ranges (Split). You can even use Layer and Split in combination with each other and play three different tones at the same time.

The UPPER 1 part is used alone when playing an individual tone on the keyboard. When layering two tones, the UPPER 1 part and UPPER 2 parts are used. When splitting the keyboard between two tones, the low range of the keyboard plays the LOWER part.

- One tone across the entire keyboard (page E-14)**  
This configuration uses the UPPER 1 part only (Layer: Off, Split: Off).



- Two layered tones across the entire keyboard (page E-16)**  
This configuration uses the UPPER 1 part and UPPER 2 part (Layer: On, Split: Off).

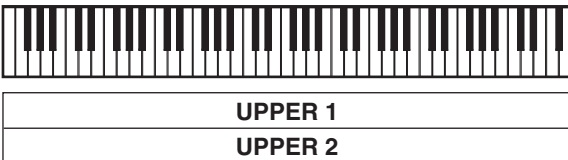

- Two tones, one for the left range and one for the right range of the keyboard (page E-17)**  
This configuration uses the UPPER 1 part and LOWER part (Layer: Off, Split: On).



- Three tones, two layered tones for the right range and one tone for the left range of the keyboard (page E-17)**  
This configuration uses the UPPER 1 part, UPPER 2 part, and LOWER part (Layer: On, Split: On).

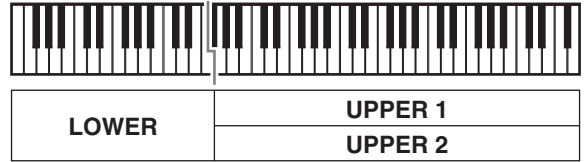

**NOTE**

- You can configure the settings described below to adjust each part when using multiple tones in layer and split configurations.

To adjust this setting for each part:	Go here for more information:
Octave shift	Using Octave Shift (page E-18)
Volume balance	Using the Mixer (page E-39)
Stereo position, effect (reverb, chorus) levels, and other detailed settings	

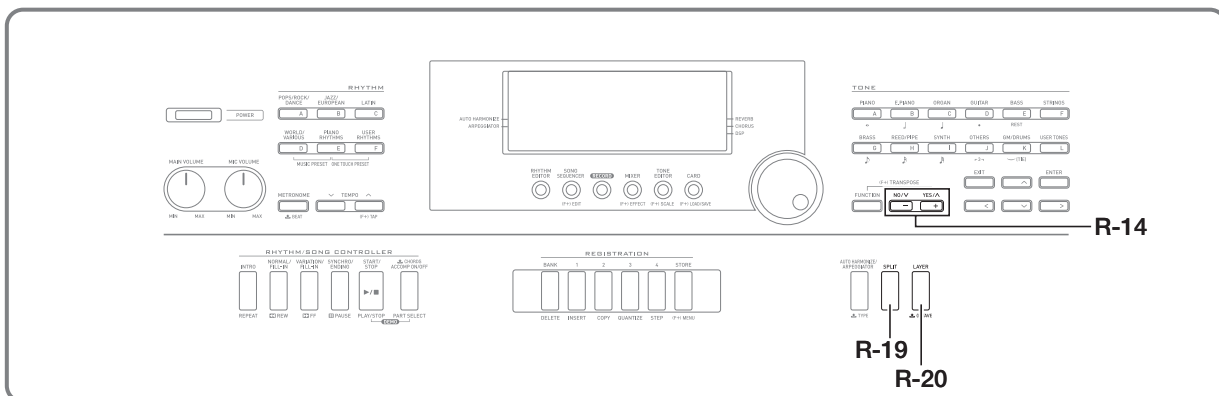

R-14

R-19  
R-20

**To layer two tones**

1. Refer to the separate “Appendix” to look up the group(s) and numbers of the two tones (UPPER 1 part tone and UPPER 2 part tone) you want to use.
2. Check to make sure that the **[SPLIT]** and **[LAYER]** indicators are not on the display.
  - If they are displayed, press the **R-19 (SPLIT)** button and/or **R-20 (LAYER)** button to clear both indicators from the display. When neither indicator is displayed, the tone you select will become the UPPER 1 part tone.
3. Use the **TONE** buttons and dial to select the UPPER 1 part tone.
4. Press the **R-20 (LAYER)** button.
  - This causes the **[LAYER]** indicator to appear on the display. This indicates that the tone you select will become the UPPER 2 part tone.
5. Use the **TONE** buttons and dial to select the UPPER 2 part tone.
6. Play something on the keyboard to check how the tones sound layered together.
7. To cancel tone layering, press the **R-20 (LAYER)** button again so the **[LAYER]** indicator disappears from the display.

**To split the keyboard between two tones**

1. Refer to the separate “Appendix” to look up the group(s) and numbers of the tones (UPPER 1 part tone and LOWER part tone) you want to use.
2. Check to make sure that the **[SPLIT]** and **[LAYER]** indicators are not on the display.
  - If they are displayed, press the **R-19 (SPLIT)** button and/or **R-20 (LAYER)** button to clear both indicators from the display. When neither indicator is displayed, the tone you select will become the UPPER 1 part tone.
3. Use the **TONE** buttons and dial to select the UPPER 1 part tone.
4. Press the **R-19 (SPLIT)** button.
  - This causes the **[SPLIT]** indicator to appear on the display. This indicates that the tone you select will become the LOWER part tone.
5. Use the **TONE** buttons and dial to select the LOWER part tone.
6. Play something on the left and right sides of the keyboard to confirm that the tones are assigned properly.
  - You also can specify the keyboard split point, which is the location where the keyboard splits between the left range and right range. For details, see “To specify the keyboard split point” (page E-17).
7. To cancel keyboard split, press the **R-19 (SPLIT)** button so the **[SPLIT]** indicator disappears from the display.

## To specify the keyboard split point

1. While holding down the R-19 (SPLIT) button, press the keyboard key that you want to be the leftmost key in the right side (UPPER 1 part) range.

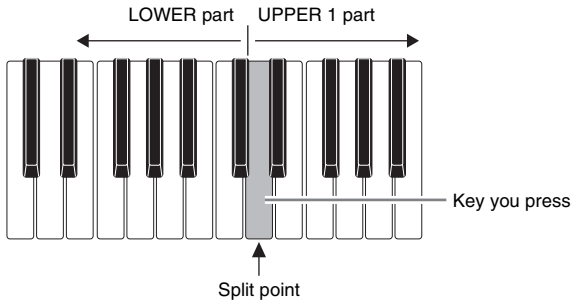

- The name of the key you press will appear on the display as the new split point key name.
- You also can use the R-14 (–, +) buttons to change the displayed split point key name.

2. When you are finished, release the R-19 (SPLIT) button.

### NOTE

- The initial default split point is at key F#3.
- During Auto Accompaniment play (page E-24), the keyboard to the left of the split point becomes the chord keyboard.

## To use layer and split together

1. Perform steps 1 through 6 of the procedure under “To layer two tones” (page E-16).
2. Refer to the separate “Appendix” to look up the group and the number of the tone you want to assign to for the LOWER part.
3. Press the R-19 (SPLIT) button.
  - This causes the **SPLIT** indicator to appear on the display. This indicates that the tone you select will become the LOWER part tone.
4. Use the TONE buttons and dial to select the LOWER part tone.
5. Play something on the left and right sides of the keyboard to confirm that the tones are assigned properly.
  - The right keyboard area plays the UPPER 1 and UPPER 2 tones in a layered configuration, while the left keyboard area plays the LOWER tone.
6. To cancel keyboard split, press the R-19 (SPLIT) button so the **SPLIT** indicator disappears from the display.
7. To cancel tone layering, press the R-20 (LAYER) button again so the **LAYER** indicator disappears from the display.

## Raising and Lowering Keyboard Tuning (Transpose)

The transpose feature lets you raise or lower the overall tuning of the keyboard in semitone steps. You can use this feature to adjust keyboard tuning to a key that better matches a vocalist, another musical instrument, etc.

1. While holding down the R-13 (FUNCTION) button, press one of the R-14 (–, +) buttons.

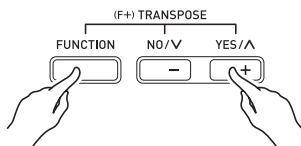

- This displays the transpose screen shown below.



2. While holding down the R-13 (FUNCTION) button, use the dial or the R-14 (–, +) buttons to change the setting value.

- You can change the tuning of the keyboard within the range of –12 to 00 to +12.

3. Press the R-13 (FUNCTION) button.

- This exits the transpose screen.

### NOTE

- Setting a transposed value other than 00 will cause the **TRANPOSE** indicator to appear on the display.
- The current transpose setting is applied to the notes of all parts (UPPER 1, UPPER 2, LOWER, Auto Accompaniment, etc.) played on the keyboard. The MIDI out note number when a keyboard key is pressed is also shifted in accordance with the transpose setting.

## Using Octave Shift

You can use octave shift to individually change the octave of the UPPER 1, UPPER 2, and LOWER parts. You can use octave shift to raise or lower the octave of a song, to assign different octaves to the left side and right side keyboards while the keyboard is split, or to play two notes in different octaves while the keyboard is layered.

1. Hold down the R-20 (OCTAVE) button until the octave shift screen shown below appears on the display.

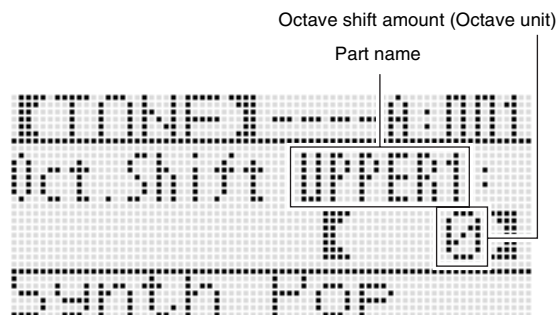

- This indicates you can change the UPPER 1 part octave.

2. Use the dial or R-14 (–, +) buttons to specify the octave shift amount.

- You can shift the octave within the range of –2 to 0 to +2.

3. If you want to change the octave of the UPPER 2 part, press the R-20 (OCTAVE) button.

- This will cause “UPPER 2” to appear on the display, indicating that you can change the UPPER 2 part octave. Perform the same operation as in step 3 to specify the octave shift amount.

4. If you want to change the octave of the LOWER part, press the R-20 (OCTAVE) button.

- This will cause “LOWER” to appear on the display, indicating that you can change the LOWER part octave. Perform the same operation as in step 3 to specify the octave shift amount.

5. Press the R-20 (OCTAVE) button or the R-15 (EXIT) button.

- This exits the octave shift screen.

## Using the Metronome

### 1. Press the L-10 (METRONOME) button.

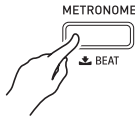

- This will start the metronome.
- The display will show the tempo along with a count of the measures and beats since you started the metronome.

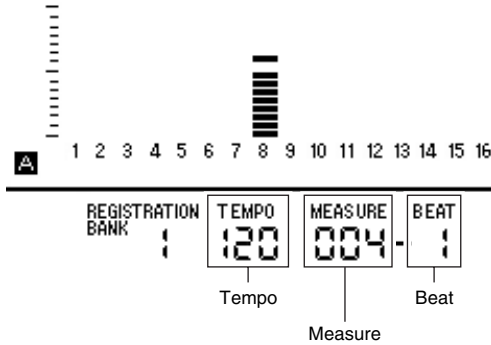

### 2. Press the L-10 (METRONOME) button again to stop the metronome.

## To change the beats per measure

### 1. Hold down the L-10 (BEAT) button until the metronome beat screen shown below appears on the display.



### 2. Use the dial or R-14 (-, +) buttons to select a beat setting.

- You can select 0, or a value within the range of 2 to 6. Specifying 0 for this setting will cause each beat to be indicated by the same sound (no chime at the beginning of each measure).

### 3. Press the L-10 (BEAT) or R-15 (EXIT) button.

- This exits the metronome beat screen.

## To change the tempo setting

There are two different methods you can use to change the tempo setting: using the TEMPO buttons or tapping a beat with a button.

### ■ To change the tempo using the TEMPO buttons

#### 1. Press the L-11 (TEMPO $\nabla$ ) (slower) or L-12 (TEMPO $\blacktriangle$ ) (faster) button.

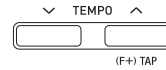

- This displays the tempo screen shown below.



- If you do not perform any operation for a few seconds, the display will return to previous screen automatically.

#### 2. Use the L-11 (TEMPO $\nabla$ ) and L-12 (TEMPO $\blacktriangle$ ) buttons to change the tempo (beats per minute).

- Holding down either button will scroll the setting values at high speed.
- You can specify a tempo value in the range of 30 to 255.

#### 3. Press the R-15 (EXIT) button.

- This exits the tempo screen.

■ To adjust the tempo by tapping a beat

1. While holding down the R-13 (FUNCTION) button, tap the L-12 (TAP) button four times at the speed (tempo) you want to set.

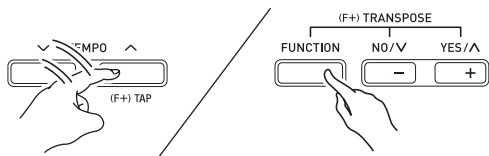

- The first tap of the L-12 (TAP) button will cause the display shown below to appear.



- The tempo setting will change in accordance with your tapping speed as soon as you tap the fourth time.
- The setting will be canceled if you release the R-13 (FUNCTION) button before tapping the R-12 (TAP) button four times.

2. After setting the tempo by tapping, you then can use the procedure under “To change the tempo using the TEMPO buttons” (page E-19) to make fine adjustments.

## Using the Pitch Bend Wheel

The PITCH BEND wheel (S-1) lets you change the pitch of notes you are playing by rotating the wheel forward or back. Rotating the wheel away from you raises the pitch, while rotating it towards you lowers it. Releasing the wheel causes the pitch of the notes to return to normal automatically.



### ! IMPORTANT!

- Do not have the pitch bend wheel rotated as you turn on the keyboard.

### NOTE

- You also can change the range of the pitch bend wheel (bend range) globally or for a specific part. For details, see “BendRange (Bend Range)” (page E-97) and “Part Parameters” (page E-44).

## Selecting a Temperament and Fine Tuning Its Scale

Use the scale function to select one of the 17 preset temperaments (tunings) for the built-in sound source. You also can fine tune each note of a scale (from C to B) in one-cent units. After selecting one of the preset temperaments, you can edit it to suit your particular needs. You also can specify whether the current scale settings (temperament setting and fine tuning adjustment) should be applied to Auto Accompaniment (Accomp Scale).

### NOTE

- The settings you configure with the scale function are retained even when the Digital Keyboard is turned off.

### To select a preset scale

- While holding down the R-13 (FUNCTION) button, press the C-6 (SCALE) button to display the scale screen, with the ● located at “Preset”.

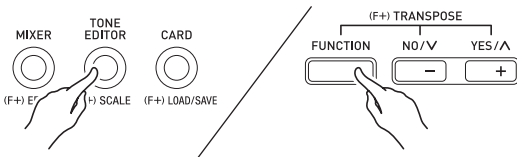

- Press the R-16 (ENTER) button.

- This displays a preset temperament selection screen like the one shown below.



- Use the dial or the R-14 (–, +) buttons to select a temperament.

- Selecting a temperament other than 01: Equal will cause the **SCALE** indicator to appear on the display.
- The following shows the temperament numbers and names that appear on the display.

Number	Screen Name	Preset Temperament
01	Equal	Equal temperament
02	Pure Major	Just major intonation
03	Pure Minor	Just minor intonation
04	Pythagorean	Pythagorean system
05	Kirnberger 3	Kirnberger III
06	Werckmeister	Werckmeister 1-3 (III)
07	Mean-Tone	Mean tone
08	Rast	Rast
09	Bayati	Bayati
10	Hijaz	Hijaz
11	Saba	Saba
12	Dashti	Dashti
13	Chahargah	Chahargah
14	Segah	Segah
15	Gurjari Todi	Gurjari Todi
16	Chandrakauns	Chandrakauns
17	Charukeshi	Charukeshi

- Perform the following steps to specify the root note of a temperament.

- Press the R-17 (>) button.

- This displays root note setting screen.



- Use the dial or the R-14 (–, +) buttons to change the root note (C to B).

- You can also use the keyboard to specify the root note.

**5. When you are finished, press the R-15 (EXIT) button twice.**

- This will return to the screen that was displayed before you displayed the scale screen.

**NOTE**

- The root note setting you specify here is retained, even if you later change to a different preset temperament.

**Fine Tuning a Scale**

**1. If required, perform the procedure under “To select a preset scale” (page E-21) to select a preset temperament.**

**2. While holding down the R-13 (FUNCTION) button, press the C-6 (SCALE) button to display the scale screen.**

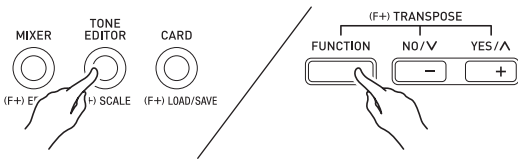

**3. Use the R-17 (V) button to move the ● to “FineTune” and then press the R-16 (ENTER) button.**

- This displays the scale fine tuning screen like the one shown below.

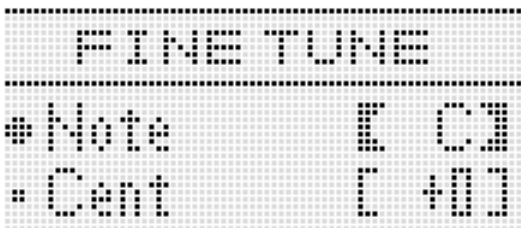

**4. You can adjust the tuning of each individual note in the scale.**

- (1) Use the R-17 (Λ) button to move the ● to “Note”, and then use the dial or R-14 (–, +) buttons to select the name of the note you want to fine tune.
  - You can also press a keyboard key to specify a note.
- (2) Use the R-17 (V) button to move the ● to “Cent”, and then use the dial or R-14 (–, +) buttons to fine tune the selected note. You can fine tune a note within the range of –99 through +99 cents.
  - Adjusting all of the notes in the scale to 0 changes the selected tuning to equal temperament. The SCALE indicator will be on the display when any note in the scale has a value other than 0.

**5. When you are finished making adjustments, press the R-15 (EXIT) button twice.**

- This will return to the screen that was displayed before you displayed the scale screen.

**Specifying whether the Current Scale Settings Should be Applied to Auto Accompaniment (Accomp Scale)**

**1. While holding down the R-13 (FUNCTION) button, press the C-6 (SCALE) button to display the scale screen.**

**2. Use the R-17 (>) button to move the ● to “AccompScale”.**



**3. Use the dial or the R-14 (–, +) buttons to change the setting value.**

To do this:	Select this setting:
Not apply scale settings to Auto Accompaniment	oFF
Apply scale settings to Auto Accompaniment	on

**4. When the setting is the way you want, press the R-15 (EXIT) button.**

- This will return to the screen that was displayed before you displayed the scale screen.

**NOTE**

- The above scale on/off setting affects the Auto Accompaniment bass part and Chord 1 through Chord 5 parts (A11 through A16). You also can turn scales settings on or off for each individual part using the Part Parameter (page E-44) “Scale (Part Scale Enable)” setting.



## Playing Arpeggio Phrases Automatically (Arpeggiator)

With the arpeggiator, you can play various arpeggios and other phrases automatically by simply pressing keys on the keyboard. You can select from a number of different arpeggiator options, including playing arpeggios from a chord, playing various phrases automatically, and more.

1. Hold down the R-18 (AUTO HARMONIZE/ARPEGGIATOR) button until the type selection screen shown below appears on the display.

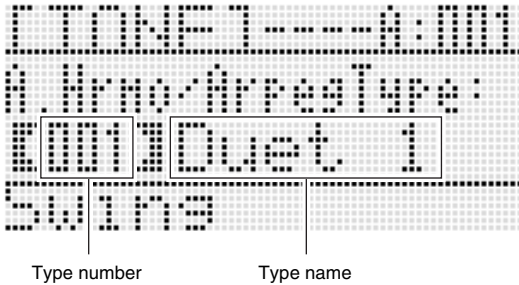
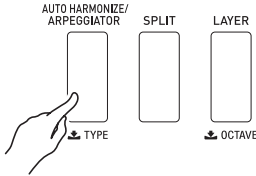

2. Use the dial or R-14 (-, +) buttons to select the arpeggiator type you want to use.

- You can select one of the arpeggiator types (013 through 162). Refer to the separate "Appendix" for detailed information about supported arpeggiator types.
- When selecting the arpeggiator type, you can assign the recommended tone for the currently displayed type as the keyboard tone, by holding down the R-18 (AUTO HARMONIZE/ARPEGGIATOR) button until a pointer indicator starts to flash on the display next to ARPEGGIATOR.

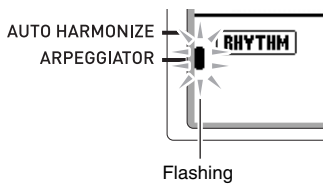

- For information about type number 001 through 012, see "Using Auto Harmonize" (page E-28).

3. Press the R-15 (EXIT) button.

- This exits the type selection screen.

4. Press the R-18 (AUTO HARMONIZE/ARPEGGIATOR) button.

- This causes a pointer indicator to appear on the display next to ARPEGGIATOR.

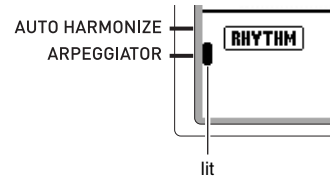

5. Configure arpeggiator settings as required.

- The settings you can configure are described in the table below. For information about how to configure settings, see "To change the setting of a function menu item" (page E-96).

For information about this setting:	Go here:
Whether arpeggio should be played while keyboard keys are depressed or after the keys are released	ArpegHold (Arpeggiator Hold) (page E-97)
The number of times arpeggio is played within one beat	ArpegSpeed (Arpeggiator Speed) (page E-98)
When the keyboard is split between two tones, whether arpeggio should be played when UPPER keyboard or LOWER keyboard keys are pressed	ArpegPart (Arpeggiator Part) (page E-98)

6. On the keyboard, play a chord or a single note.

- Arpeggio is played in accordance with the currently selected arpeggiator type and the note(s) you play.

7. To turn off the arpeggiator, press the R-18 (AUTO HARMONIZE/ARPEGGIATOR) button again.

- This causes the pointer indicator next to ARPEGGIATOR to disappear from the display.

# Using Auto Accompaniment

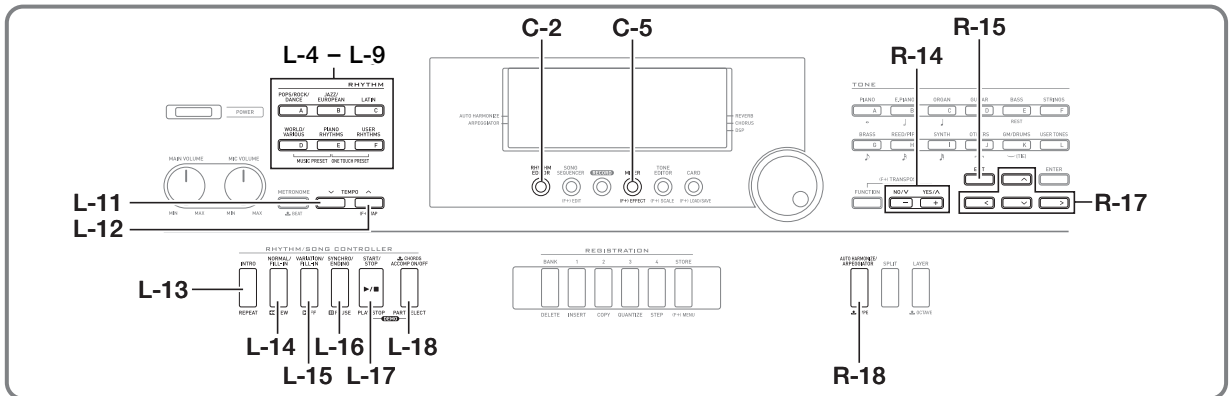

With Auto Accompaniment, simply select the accompaniment rhythm you want and the matching accompaniment (drums, guitar, etc.) will play automatically when you play a chord with your left hand. It's like having your own personal backup group along with you wherever you go.

This Digital Keyboard has 200 built-in Auto Accompaniment patterns, which are divided into five groups. You can edit built-in rhythms to create your own original rhythms (called "user rhythms"), which you can save in a sixth group. For more information, see the separate "Appendix".

## Playing an Auto Accompaniment

1. Refer to the separate "Appendix" to look up the group and the number of the rhythm you want to use.
2. Use the buttons from L-4 ([A] POPS/ROCK/ DANCE) to L-9 ([F] USER RHYTHMS) to select a rhythm group.
  - The L-9 ([F] USER RHYTHMS) button is for the user rhythm group. For details, see "Using the Rhythm Editor" (page E-29).

3. Use the dial to scroll through the rhythm numbers until the one you want is displayed. Example: Group B, Number 005

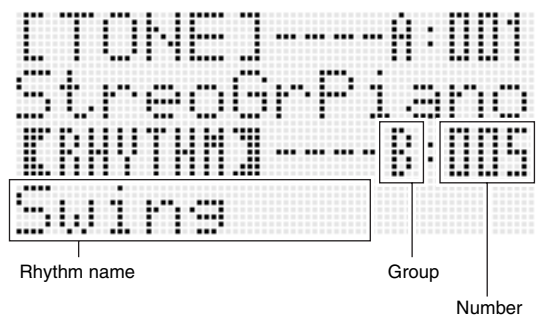

- You can also use the R-14 (–, +) buttons to select a rhythm number. Holding down either button will scroll through rhythm numbers at high speed. Pressing both of the R-14 (–, +) buttons at the same time will select 001 in the currently selected group.
4. Use the L-11 (TEMPO ∨) and L-12 (TEMPO ∧) buttons to adjust the tempo setting.
  5. Press the L-18 (ACCOMP ON/OFF) button so the **ACCOMP** indicator is on the display.
    - Each press of the button toggles accompaniment between on (**ACCOMP** indicator displayed) and off (indicator not displayed).
    - All accompaniment instrument parts sound while accompaniment is on (**ACCOMP** indicator displayed), while only percussion instrument parts (drums, etc.) sound while accompaniment is off (indicator not displayed).

## 6. Press the L-16 (SYNCHRO/ENDING) button.

- This enters synchro standby (Auto Accompaniment waiting for you to play a chord), with the **NORMAL** indicator flashing on the display. The flashing **NORMAL** indicator means that the normal Auto Accompaniment pattern is standing by.

## 7. You also can use the buttons described below to change to intro or variation pattern standby.

To enter synchro standby for this pattern:	Press this key:	Display Indicator:
Intro	<b>L-13 (INTRO)</b> button	<b>INTRO</b> flashing
Variation	<b>L-15 (VARIATION/FILL-IN)</b> button	<b>VARIATION</b> flashing

For details about intro and variation patterns, see “Modifying Auto Accompaniment Patterns” (page E-27).

## 8. Play the chord you want on the chord keyboard (left keyboard keys).

- Auto Accompaniment will start playing when you play the chord.
- To start percussion part play without playing a chord, press the **L-17 (START/STOP)** button.

Example: To play a C chord

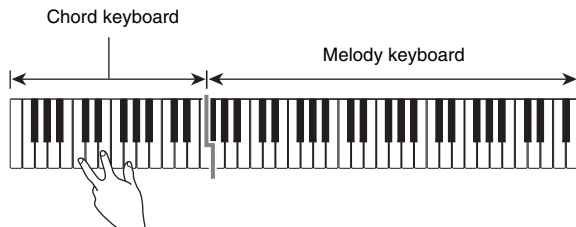

- The chord root and type that corresponds to the keys you press appear in the chord area of the display.

## 9. Play other chords with your left hand as you play the melody with your right hand.

- You can use “CASIO Chord” or other simplified chord fingering modes to play chords. For details, see “Selecting a Chord Fingering Mode” in the following section.
- You can use the **L-14 (NORMAL/FILL-IN)** and **L-15 (VARIATION/FILL-IN)** buttons to modify accompaniment patterns. For details, see “Modifying Auto Accompaniment Patterns” (page E-27).

## 10. When you are finished, press the L-17 (START/STOP) button again to stop Auto Accompaniment.

- Pressing the **L-16 (SYNCHRO/ENDING)** button instead of the **L-17 (START/STOP)** button will play an ending pattern before stopping Auto Accompaniment play. For details about ending patterns, see “Modifying Auto Accompaniment Patterns” (page E-27).

### NOTE

- You can use the following procedure to adjust the volume level of the Auto Accompaniment, without affecting the volume of Digital Keyboard output. For details, see “AccompVol. (Auto Accompaniment Volume)” (page E-99).
- You can change the size of the chord keyboard by using the split feature to move the split point (page E-17). The keyboard keys to the left of the split point make up the chord keyboard.

## Selecting a Chord Fingering Mode

While Auto Accompaniment is playing, you use the chord keyboard to specify the chord root and type. The area of the keyboard to the left of the split point (page E-17) is the chord keyboard. The illustration below shows the chord keyboard range under WK-6500 initial default settings.

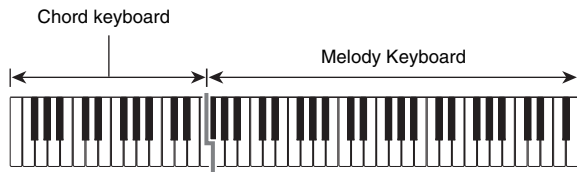

You can select from among the following five chord fingering modes.

- 1: Fingered 1
- 2: Fingered 2
- 3: Fingered 3
- 4: CASIO Chord
- 5: Full Range

### To select a chord fingering mode

- Hold down the L-18 (ACCOMP ON/OFF) button until the chord fingering mode selection screen shown below appears on the display.



Chord fingering mode

- Use the dial or R-14 (-, +) buttons to select a chord fingering mode.
- Press the L-18 (ACCOMP ON/OFF) button or the R-15 (EXIT) button.
  - This exits the chord fingering mode selection screen.

### Fingered 1, 2, 3

With these three chord fingering modes, you play chords on the chord keyboard using their normal chord fingerings. Some chord forms are abbreviated, and can be fingered with one or two keys. For information about the types of chords you can finger and their fingerings, see the “Fingering Guide” (page E-124).

**Fingered 1 :** Play the component notes of the chord on the keyboard.

**Fingered 2 :** Unlike Fingered 1, 6th input is not possible with this mode.

**Fingered 3 :** Unlike Fingered 1, this mode allows input of fraction chords with the lowest keyboard note as the bass note.

### CASIO Chord

With “CASIO Chord”, you can use simplified fingerings to play the four types of chords described below.

Chord Type	Example
<b>Major Chords</b> Press one key, whose note corresponds to the chord name. <ul style="list-style-type: none"> <li>• To play C Major, press any C key in the chord keyboard. The octave of the note does not matter.</li> </ul>	C (C Major) Note name →
<b>Minor Chords</b> Press the chord keyboard key that corresponds to the major chord, while also pressing one other chord keyboard key to the right.	Cm (C minor) 
<b>Seventh Chords</b> Press the chord keyboard key that corresponds to the major chord, while also pressing two other chord keyboard keys to the right.	C7 (C seventh) 
<b>Minor Seventh Chords</b> Press the chord keyboard key that corresponds to the major chord, while also pressing three other chord keyboard keys to the right.	Cm7 (C minor seventh) 

When pressing more than one chord keyboard key, it makes no difference whether the additional keys are white or black.

### Full Range Chord

With this chord fingering mode, you can use the full range of the keyboard to play chords and the melody. For information about the types of chords you can finger and their fingerings, see the “Fingering Guide” (page E-124).

## Modifying Auto Accompaniment Patterns

There are six different Auto Accompaniment patterns, shown below. You can switch between patterns during accompaniment play and even modify patterns. Use buttons L-13 through L-16 to select the pattern you want.

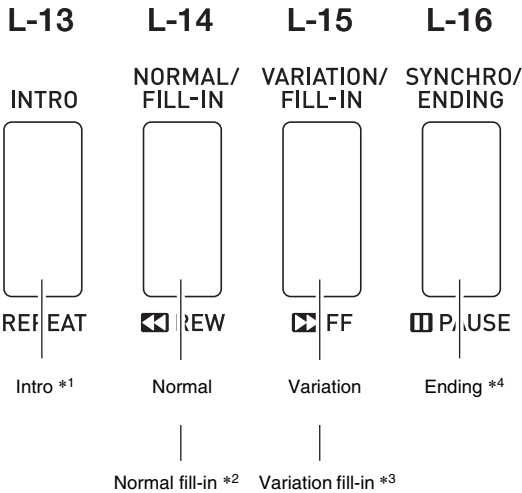

- \*1 Press at the beginning of a song. Accompaniment play proceeds with the normal pattern after the intro pattern is complete. Pressing the **L-15 (VARIATION/FILL-IN)** button before pressing this button will proceed with the variation pattern after the intro pattern is complete.
- \*2 Press while a normal pattern is playing to insert a fill-in pattern.
- \*3 Press while a variation pattern is playing to insert a fill-in variation pattern.
- \*4 Press at the end of a song. This will play an ending pattern and then stop Auto Accompaniment.

## Using One-Touch Presets

One-Touch Preset gives you one-touch access to tone and tempo settings that go well with the currently selected Auto Accompaniment rhythm pattern.

### To perform using a one-touch preset

1. If rhythm is playing, press the L-17 (START/STOP) button to stop it.
2. Select the rhythm (excluding user rhythms) you want to use.
3. While holding down the L-8 ([E] PIANO RHYTHMS) button, press the L-9 ([F] USER RHYTHMS) button.

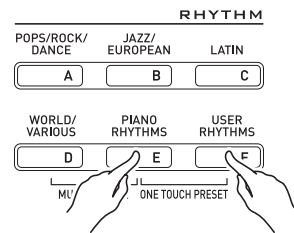

- Settings for the following items are configured appropriately for the rhythm you selected in step 1.
  - Tones for the UPPER 1, UPPER 2, and LOWER parts
  - Octave shift for the UPPER 1, UPPER 2, and LOWER parts
  - Layer and split on/off
  - Accompaniment on/off
  - Reverb on/off and type
  - Chorus type
  - Auto harmonize or Arpeggiator on/off and type
  - Tempo
- Also, the **NORMAL** indicator flashes on the display to indicate that the normal Auto Accompaniment pattern is standing by.

### 4. Start playing something on the keyboard.

- Perform the procedure starting from step 7 under “Playing an Auto Accompaniment” on page E-24 and E-27.

### NOTE

- One-Touch Presets are not supported for user rhythms (F:001 through F:010).
- You can recall one-touch preset settings even if a rhythm is already playing when you perform step 3 of the above procedure. In this case, rhythm play will continue without going into synchro standby.

## Using Auto Harmonize

Auto harmonize lets you add harmony to melody notes you play with your right hand. You can select any one of 12 Auto harmonize settings.

### To play using auto harmonize

1. Hold down the R-18 (AUTO HARMONIZE/ARPEGGIATOR) button until the type selection screen shown below appears on the display.

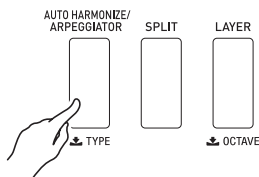

Type number

Type name

2. Use the dial or R-14 (-, +) buttons to select the auto harmonize type you want to use.

- You can select one of the type numbers (001 through 012) described in the table below.

Type Number	Type Name	Description
001	Duet 1	Adds close (separated by two to four degrees) one-note harmony below the melody note.
002	Duet 2	Adds open (separated by more than 4 to 6 degrees) 1-note harmony below the melody note.
003	Country	Adds country style harmony.
004	Octave	Adds the note from the next lower octave.
005	5th	Adds the fifth degree note.
006	3WayOpen	Adds 2-note open harmony, for a total of three notes.
007	3WayClos	Adds 2-note close harmony, for a total of three notes.
008	Strings	Adds harmony that is optimal for strings.
009	4WayOpen	Adds 3-note open harmony, for a total of four notes.
010	4WayClos	Adds 3-note close harmony, for a total of four notes.
011	Block	Adds block chord notes.
012	Big Band	Adds big band style harmony.

- For information about type numbers greater than 012, see "Playing Arpeggio Phrases Automatically (Arpeggiator)" (page E-23).

3. Press the R-15 (EXIT) button.

- This exits the type selection screen.

4. Press the R-18 (AUTO HARMONIZE/ARPEGGIATOR) button.

- This causes a pointer indicator to appear on the display next to AUTO HARMONIZE.

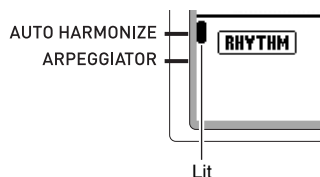

5. Play chords and the melody on the keyboard.

- Harmony will be added to your melody notes based on the chords you play.

## 6. To turn off auto harmonize, press the R-18 (AUTO HARMONIZE/ARPEGGIATOR) button again.

- This causes the pointer indicator next to AUTO HARMONIZE to disappear.

## Using the Rhythm Editor

You can use the rhythm editor to modify a built-in Auto Accompaniment rhythm and create an original "user rhythm" of your own. You can select a part (drum, bass, etc.) of a normal, intro, or other pattern (page E-27) and turn it on or off, adjust its volume level, and perform other operations.

### User Rhythm Numbers

Rhythm areas numbered F:001 through F:010 are for storage of user rhythms. You can have up to 10 user rhythms stored in memory at one time. You can recall a stored user rhythm by pressing the L-9 ([F] USER RHYTHMS) button. See "Playing an Auto Accompaniment" (page E-24) for more information.

### To create and save a user rhythm

- Select the rhythm you want to edit in order to create your user rhythm.
- Press the C-2 (RHYTHM EDITOR) button.



- This displays the rhythm editor screen.

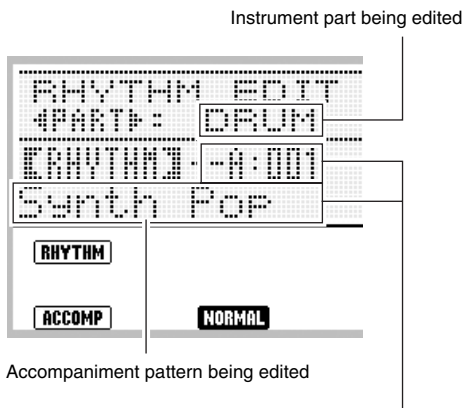

Rhythm number and rhythm name assigned to the instrument part of the accompaniment pattern being edited (Default: Number and name selected in step 1)

- Use buttons L-13 (INTRO) through L-16 (SYNCHRO/ENDING) to select the accompaniment pattern you want to edit. If you want to edit the intro accompaniment pattern, for example, press the L-13 (INTRO) button.

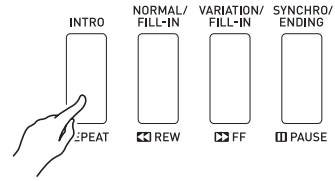

- Each press of the L-14 (NORMAL/FILL-IN) button toggles between normal and normal fill-in, and each press of the L-15 (VARIATION/FILL-IN) button toggles between variation and variation fill-in.
- The indicator for the currently selected accompaniment pattern will flash on the display.

Selecting this accompaniment pattern:	Causes this indicator to flash:
Intro	<b>INTRO</b>
Normal	<b>NORMAL</b>
Normal fill-in	<b>NORMAL</b> <b>FILL-IN</b>
Variation	<b>VARIATION</b>
Variation fill-in	<b>FILL-IN</b> <b>VARIATION</b>
Ending	<b>ENDING</b>

- Use the R-17 (<, >) buttons to select the instrument part you want to edit.

- The name of the instrument part you select will appear on the display.

Selecting this instrument part:	Causes this name to appear on the display:
Percussion	PERC
Drums	DRUM
Bass	BASS
Chord 1 to Chord 5	CHORD1 to CHORD5



## 5. Edit the selected accompaniment pattern instrument part as desired.

- While performing the procedure below, you can press the **L-17 (START/STOP)** button and perform repeat playback of only the accompaniment pattern you are editing. Each press of the **L-17 (START/STOP)** button starts or stops playback.
- (1) While **[RHYTHM]** is displayed in line three of the rhythm editor screen, specify a number to assign a rhythm to the instrument part of the selected accompaniment pattern.  
Settings are configured using the same procedures as those for rhythm selection. Perform steps 1, 2, and 3 under “Playing an Auto Accompaniment” on page E-24.
- (2) Configure the mixer settings of the selected accompaniment pattern instrument part as desired. Press the **C-5 (MIXER)** button, use the **R-17 (▲, ▼)** buttons to select one of the items described in the table below, and then use the dial or **R-14 (←, →)** buttons to change the setting.

Display: Item name	Description	Setting Range
TONE: Part Tone	Specifies the instrument part tone setting.	All tones (except user tones) <sup>*1</sup>
Part: Part On/Off <sup>*2</sup>	Specifies whether or not the instrument part should sound.	on: Sounds the part. oFF: Mutes the part.
Volume: Part Volume	Specifies the instrument part volume.	000 to 127
Pan: Part Pan	Specifies whether the sound of the part can be heard from the left side or right side.	-64 to 0 to +63 <sup>*3</sup>
Reverb: Part Reverb Send	Specifies the level of reverb (page E-34) applied to an instrument part.	000 to 127
Chorus: Part Chorus Send	Specifies the level of chorus (page E-35) applied to an instrument part.	000 to 127

- \*1 Only drum set sounds (tone numbers K:129 through K:145) can be selected for drum parts and percussion parts. Drum set sounds cannot be selected for the bass and the Chord 1 through Chord 5 parts.
- \*2 In addition to its “on” and “oFF” settings, “Part” also has a “Sol” (Solo) setting, which you can select by pressing the **R-14 (←, →)** buttons at the same time while “Part” is selected. While the “Sol” setting is selected, the Digital Keyboard will sound only notes of the part that is currently selected for editing.
  - Using the **R-17 (←, →)** to select a different instrument part will change “Part” from “Sol” back to “on” or “oFF”.
  - Note that “Sol” is a special setting for previewing data while editing it, and it is not reflected when saving the user rhythm.
- \*3 A smaller value shifts the pan position to the left while a larger value shifts to the right. A value of zero specifies center.
  - (3) To exit the mixer, press the **C-5 (MIXER)** button or the **R-15 (EXIT)** button.
    - This returns to the **[RHYTHM]** screen displayed in step (1).

### IMPORTANT!

- **Performing rhythm assignment in step (1) above also will automatically change mixer settings to the initial defaults for the assigned rhythm. Because of this, changing the rhythm after configuring mixer settings in step (2) will cause the configured mixer settings to be replaced with the default settings of the newly selected rhythm.**
- **When intro or ending is selected as the accompaniment pattern, the same rhythm is always assigned to all eight instrument parts. Because of this, performing rhythm assignment in step (1) for an intro or ending will change the rhythm of all instrument parts at one time.**

## 6. Repeat steps 3 through 5 to edit other accompaniment patterns and instrument parts.

## 7. After editing is complete, adjust the tempo of the rhythm as desired.

- The tempo you set here becomes the initial default tempo.

## 8. To save a rhythm after you edit it, hold down the **R-13 (FUNCTION)** button as you press the **C-13 (MENU)** button.

- This displays the rhythm editor menu with the  located at “Store”.



**9. After everything is the way you want, press the R-16 (ENTER) button.**

- This displays a screen for specifying the destination user rhythm number and rhythm name.

Destination user rhythm number

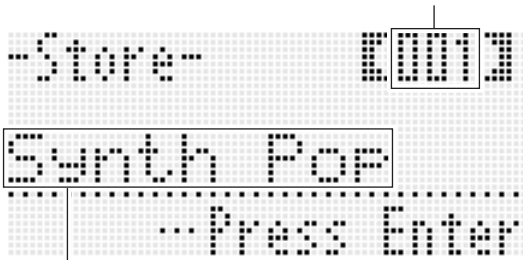

Rhythm name

**10. Use the dial or R-14 (-, +) buttons to select the destination user rhythm number you want.**

**11. Use the R-17 (<, >) buttons to move the cursor to the name character position you want to change, and then use the dial or R-14 (-, +) buttons to select the character you want.**

- See “Supported Input Characters” (page E-124) for information about the characters you can input for the name.
- To input a space, press both of the R-14 (-, +) buttons at the same time.

**12. Press the R-16 (ENTER) button.**

- This saves the data.
- If the rhythm number where you are saving the data already has data saved to it, a message (Replace?) will appear on the display to confirm whether you want to replace the existing data with the new data. Press the R-14 (YES) button to replace the existing data with the new data or the R-14 (NO) button to cancel and return to the screen in step 9.

**IMPORTANT!**

- The message “Please Wait” will remain on the display while a data save operation is in progress. Do not perform any other operation while it is displayed. Turning off the Digital Keyboard or removing the memory card can cause Digital Keyboard data to be deleted or become corrupted. It also can cause the Digital Keyboard to fail to turn on when the L-1 (POWER) button is pressed. If this happens, refer to “Troubleshooting” (page E-114).

**NOTE**

- Pressing the R-15 (EXIT) button in place of step 8 displays the confirmation screen shown below. Pressing the R-14 (YES) button at this time will display the user rhythm save screen in step 9.



To cancel the editor operation without saving the edited results, press the R-14 (NO) button.

- If the size of the accompaniment pattern or instrument part data is too large to be edited, a memory full message (Memory Full) will appear on the display. If that happens, select a different accompaniment pattern or instrument part for editing.

**To clear user rhythm data**

- Press the C-2 (RHYTHM EDITOR) button to display the rhythm editor screen.
- While holding down the R-13 (FUNCTION) button, press the C-13 (MENU) button.
  - This displays the rhythm editor menu.
- Use the R-17 (V) button to move the ● to “Clear” and then press the R-16 (ENTER) button.
  - This displays a screen for specifying the number of the rhythm you want to clear.
- Use the dial or R-14 (-, +) buttons to specify the number of the user rhythm you want to clear.
- Press the R-16 (ENTER) button.
- In response to the “Sure?” message that appears, press the R-14 (YES) button to clear or the R-14 (NO) button to cancel.

# Applying Effects to a Sound

You can apply a variety of different acoustic effects to the sounds produced by the Digital Keyboard. The built-in effects include a wide variety of variations that give you access to a selection of general digital effects.

**NOTE**

- The WK-6500 also lets you apply effects to input from the **T-7 (MIC IN)** jack.

## Configuration of Effects

The following shows how Digital Keyboard effects are configured.

**NOTE**

- Items such as “Reverb Send” that are indicated by the symbol  $\rightarrow$  are all mixer settings. For details, see “Using the Mixer” (page E-39).
- Chorus and DSP cannot be used at the same time.

### ■ Chorus Effect Mode Configuration

The chorus effect mode is enabled while “Chorus” is selected for the “Chorus/DSP” effect parameter. Chorus and reverb can be used in the chorus effect mode.

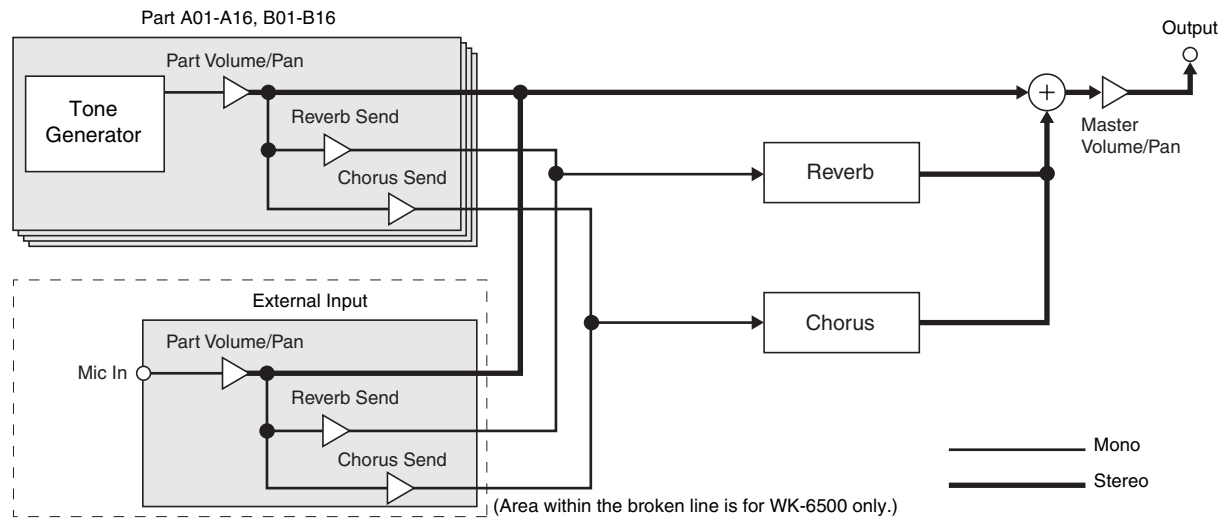

- For information about “Chorus/DSP”, see “Selecting an Effect” (page E-34).

## ■ DSP Effect Mode Configuration

The DSP effect mode is enabled while “DSP” is selected for the “Chorus/DSP” effect parameter. DSP and reverb can be used in the DSP effect mode.

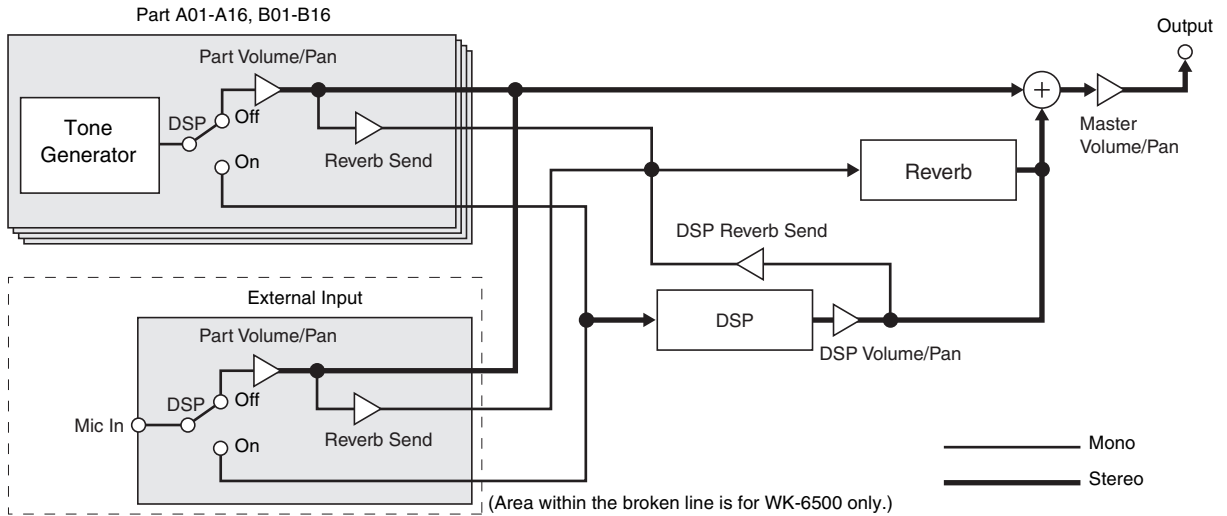

- **Reverb**

This type of effect simulates acoustic spaces. There are 10 different reverb effects, including room and hall.

- **Chorus**

This type of effect increases the depth of notes and applies vibrato to notes. There are five different chorus effects.

- **DSP**

This type of effect is inserted between the sound source and output. There are a total of 100 different DSP effects, including distortion and modulation. You also can transfer DSP effects from a computer or create DSP data on the Digital Keyboard, and store up to 100 user DSP effects in Digital Keyboard memory. For details, see “Creating a User DSP” (page E-37) and “Connecting to a Computer” (page E-112).

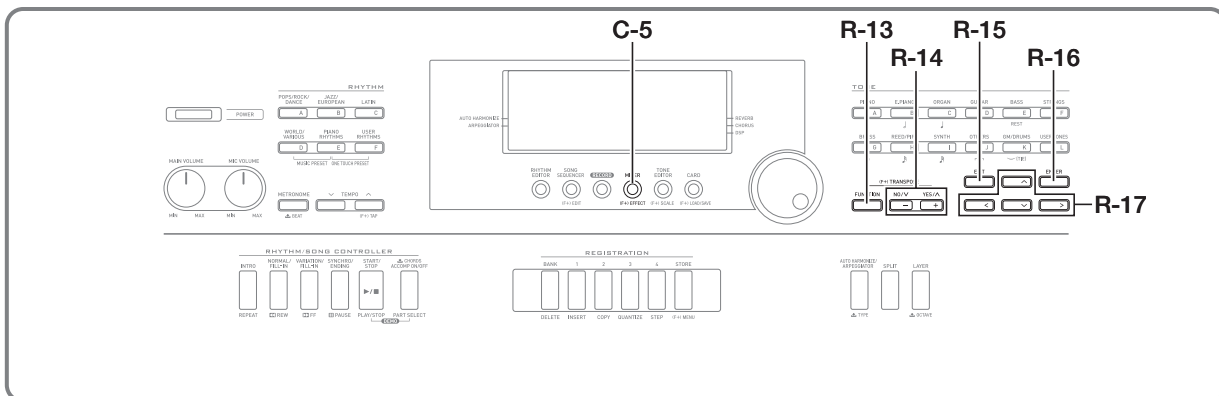

## Selecting an Effect

Effects are divided among different types (reverb, chorus, DSP), so first you need to use the procedure below to select an effect type.

### To add reverb to sounds

1. While holding down the R-13 (FUNCTION) button, press the C-5 (EFFECT) button.

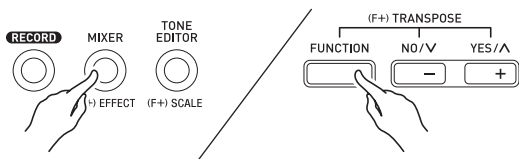

- This displays the effect setting screen shown below.



2. Use the dial or R-14 (-, +) buttons to select the reverb type you want to use.
  - Refer to the separate "Appendix" for information about supported reverb types.
  - To turn off reverb, select "oFF" here.
3. Press the C-5 (EFFECT) button or the R-15 (EXIT) button.
  - This exits the effect setting screen.

## NOTE

- A pointer indicator is displayed next to REVERB when anything other than "oFF" is selected for the reverb type. The pointer indicator is not displayed next to REVERB when "oFF" is selected.
- You can use Reverb Send to adjust how reverb is applied to the tone of each keyboard or Auto Accompaniment part. For details, see "Using the Mixer" (page E-39).

## To add the chorus effect to sounds

1. While holding down the R-13 (FUNCTION) button, press the C-5 (EFFECT) button to display the effect setting screen.

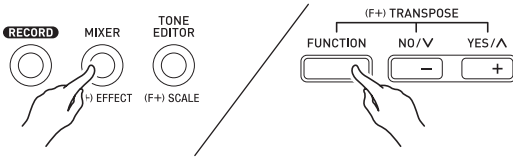

2. If you want, use the R-17 (^, v) buttons to move the thick brackets ([ ]) to the “DSP Disable” setting, and then use the R-14 (-, +) buttons to change the setting to “on”.
  - For more information about this setting, see the “Important!” note below.
  - If you turning on the “DSP Disable” setting, you should skip steps 3 and 4 below.
3. Use the R-17 (^, v) buttons to move the thick brackets ([ ]) to the “Chorus/DSP” setting.
4. Use the R-14 (-, +) buttons to select “Chorus”.
  - This enters the chorus effect mode, which enables the use of the chorus effect.
5. Use the R-17 (^, v) buttons to move the thick brackets ([ ]) to the “Chorus” setting.



6. Use the dial or R-14 (-, +) buttons to select the chorus type you want to use.
  - Refer to the separate “Appendix” for information about supported chorus types.
7. Press the C-5 (EFFECT) button or the R-15 (EXIT) button.
  - This exits the effect setting screen.

8. Use the mixer to adjust the chorus send of the part to which you want to apply chorus.

- You can use “Cho.Send” (Part Chorus Send, page E-44) to adjust how chorus is applied to the tone of each keyboard or Auto Accompaniment part. The initial default setting is 0 for the chorus send of all parts, so change the settings to a chorus send value greater than 0 for all parts to which you want to apply the chorus effect. For details, see “Using the Mixer” (page E-39).

### IMPORTANT!

- Selecting a tone with DSP causes the “Chorus/DSP” setting to change automatically to the “DSP” (DSP effect mode), so the chorus effect will not be available. If you want the chorus effect always to be available, change the “DSP Disable” setting to “on”. This will keep the Digital Keyboard in the chorus effect mode.

### NOTE

- A pointer indicator is displayed next to CHORUS when “Chorus” is selected for the “Chorus/DSP” setting. The pointer indicator is not displayed next to CHORUS when “oFF” is selected for the chorus type or when “DSP” is selected for the “Chorus/DSP” setting.
- Selecting “Chorus” for the “Chorus/DSP” setting will cause the “DSP Line” (Part DSP Line, page E-44) setting for all parts to be changed to “oFF”.

## To use a DSP

1. While holding down the R-13 (FUNCTION) button, press the C-5 (EFFECT) button to display the effect setting screen.

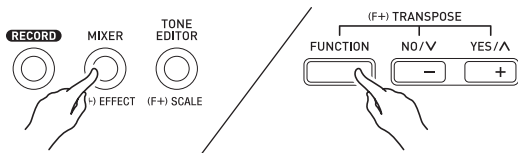

- Check to make sure that the “DSP Disable” setting is “oFF”. If it is “on”, change it to “oFF”.

2. Use the R-17 (∧, ∨) buttons to move the thick brackets ([ ]) to “Chorus/DSP”.

3. Use the R-14 (–, +) buttons to select “DSP”.

4. Use the R-17 (∧, ∨) buttons to move the thick brackets ([ ]) to the “DSP” setting.

- This causes the number and name of the currently selected preset DSP to appear within the thick brackets ([ ]) on the display.



5. Use the dial or R-14 (–, +) buttons to select the preset DSP you want to use.

- DSPs with the leading numbers 001 through 100 (and “ton”) are preset DSPs. See “Preset DSP List” on page E-119 for information about preset DSP numbers and names.
- DSP types with the leading numbers 101 through 200 are user DSPs. For details, see “Creating a User DSP” (page E-37).

6. Press the C-5 (EFFECT) button or the R-15 (EXIT) button.

- This exits the effect setting screen.

### NOTE

- A pointer indicator is displayed next to DSP when “DSP” is selected for the “Chorus/DSP” setting.
- You also can adjust how a DSP is applied (DSP output enabled/disabled, DSP output volume, DSP output pan, etc.) For details, see “Using the Mixer” (page E-39).

## Creating a User DSP

You can create a user DSP by editing one of the built-in preset DSPs.

### User DSP Numbers

DSP areas numbered 101 through 200 are for storage of user DSPs. You can have up to 100 user DSPs stored in memory at one time. To recall a stored user DSP, use the same procedure you use to recall a preset DSP. See “To use a DSP” (page E-36) for more information.

### To create and save a user DSP

**1. Referring to the “DSP Type List” (page E-120), select the DSP type you want to edit in order to create your user DSP.**

**2. Use the R-17 (V) button to move the ● to “DSP Edit”.**



**3. Press the R-16 (ENTER) button.**

- This displays page one of the DSP editor screen. Use this screen to select the DSP type.

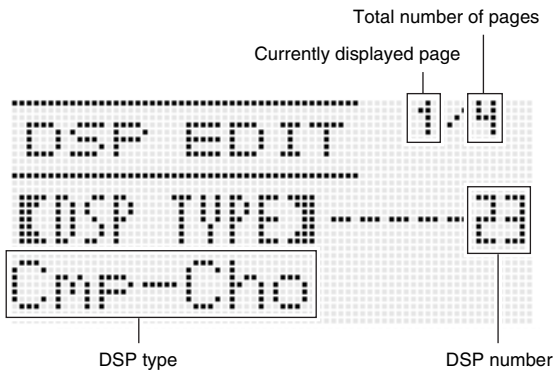

- You can use the R-17 (<, >) buttons to scroll between pages.

**4. Use the dial or R-14 (–, +) buttons to select a DSP type.**

**5. Use the R-17 (∧, V) buttons to move the thick brackets ([ ]) to the parameter you want to change.**



**6. Use the dial or R-14 (–, +) buttons to change the setting value.**

- Pressing the R-14 (–, +) buttons at the same time returns a parameter to its initial default setting.
- The following describes each of the parameters.

Parameter Name	Description
Parameters 1 through 8	The number of parameters and settings available for each parameter depends on the DSP type. For details, see “DSP Parameter List” (page E-121).
DSP RevSend (DSP Reverb Send)	Specifies how much of the post-DSP sound should be sent to reverb. (Settings: 0 to 127 ; Default: 40)

- Changing the DSP parameter while a note is being output from the Digital Keyboard may cause noise to be generated. This does not indicate malfunction.

**7. Repeat steps 5 and 6 as required to configure other parameters.**

**8. Press the R-15 (EXIT) button.**

- This displays the confirmation screen shown below.



To cancel the editor operation without saving the edited results, press the R-14 (NO) button.

**9. Press the R-14 (YES) button.**

- This displays a screen for specifying the destination user DSP number and DSP name.

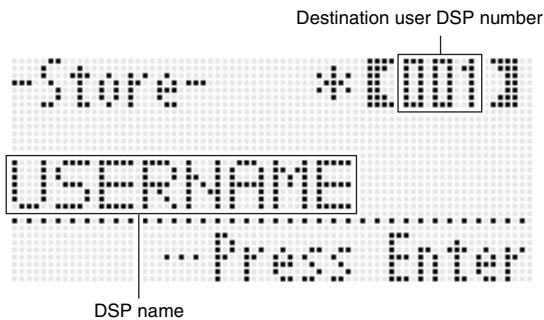

**10. Use the dial or R-14 (-, +) buttons to select the destination user DSP number you want.**

**11. Use the R-17 (<, >) buttons to move the cursor to the name character position you want to change, and then use the dial or R-14 (-, +) buttons to select the character you want.**

- See “Supported Input Characters” (page E-124) for information about the characters you can input for the name.
- To input a space, press both of the R-14 (-, +) buttons at the same time.

**12. After everything is the way you want, press the R-16 (ENTER) button.**

- A message (Replace?) will appear on the display to confirm whether you want to replace the existing data with the new data. Press the R-14 (YES) button to replace the existing data with the new data or the R-14 (NO) button to cancel and return to the screen in step 9.

**IMPORTANT!**

- The message “Please Wait” will remain on the display while a data save operation is in progress. Do not perform any other operation while it is displayed. Turning off the Digital Keyboard or removing the memory card can cause Digital Keyboard data to be deleted or become corrupted. It also can cause the Digital Keyboard to fail to turn on when the L-1 (POWER) button is pressed. If this happens, refer to “Troubleshooting” (page E-114).



# Using the Mixer

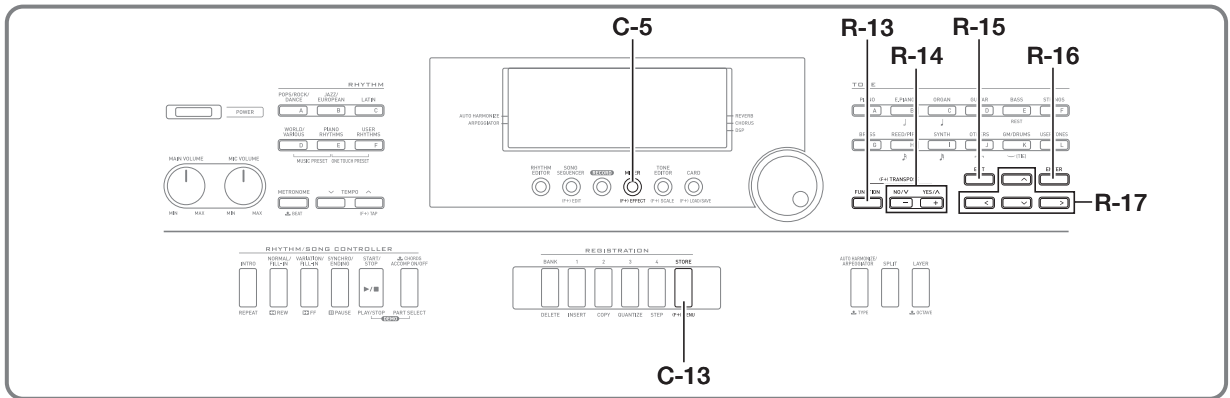

## Mixer Overview

The sound source of this Digital Keyboard is capable of sounding up to 32 individual parts simultaneously. Each part can be controlled individually, and each part can be configured to sound a different musical instrument. Different tones can be assigned to each part when using layer and split to sound multiple tones at the same time, and to sound multiple instruments at the same time with Auto Accompaniment.

The mixer can be used to assign such tones and to configure other settings for each part, and to configure global effect settings applied to all parts. The mixer provides you with the means to make fine adjustments to a wide variety of settings, from note generation to note output.

## How Parts are Organized

This Digital Keyboard has a total of 32 parts: A01 through A16, and B01 through B16. Each part has a specific purpose. Use the table below as a reference to determine the purpose of each part when using the mixer to configure the settings of a part.

This part:	Is used for this:	Go here for more information:
A01	Manual play UPPER 1 part	"Layering and Splitting Tones" (page E-15)
A02	Manual play UPPER 2 part	
A03	Manual play LOWER part	
A04	Auto harmonize tone	"Using Auto Harmonize" (page E-28)
A05	UPPER 1 part*1	"Using the Song Sequencer" (page E-64)
A06	UPPER 2 part*2	
A07	LOWER part*3	
A08	Metronome sound	"Using the Metronome" (page E-19)

This part:	Is used for this:	Go here for more information:
A09	Auto Accompaniment percussion part	"Using Auto Accompaniment" (page E-24)
A10	Auto Accompaniment drums part	
A11	Auto Accompaniment bass part	
A12 to A16	Auto Accompaniment Chord 1 part through Chord 5 part	
B01 to B16	Song sequencer track B01 through B16, tracks 1 through 16 during playback of a MIDI file from a memory card, CH1 through CH16 during MIDI receive	"Using the Song Sequencer" (page E-64), "Playing a Music File from a Memory Card" (page E-108), "Connecting to a Computer" (page E-112)

\*1 UPPER 1 part recorded to the song sequencer system track.

\*2 UPPER 2 part recorded to the song sequencer system track.

\*3 LOWER part recorded to the song sequencer system track.

## Mixer Operation

### To change mixer parameters

#### 1. Press the C-5 (MIXER) button.



- This causes the mixer screen to appear.

Currently selected setting  
(MASTER, DSP, MIC, or A01 to A16/B01 to B16)

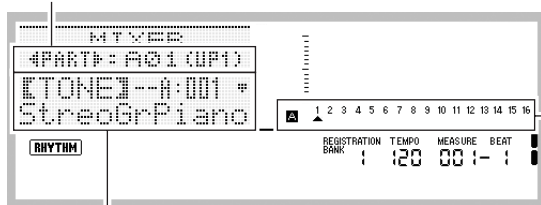

Parameter/Setting value

Currently selected setting part  
(when currently selected setting is A01 to A16/B01 to B16)

#### 2. Use the R-17 (<, >) buttons to select the mixer parameter you want to change.

- You can select master (MASTER), effect (DSP), microphone input (MIC), or a part (A01 through A16, B01 through B16). The currently selected setting is shown in the line two of the display.
- While a part is selected, you can toggle between Group A and Group B by pressing both of the R-17 (<, >) buttons at the same time.

#### 3. Use the R-17 (∧, ∨) buttons to move the thick brackets ([ ]) to the parameter you want to change.

- The parameters that can be configured depend on the currently selected setting. For details, refer to the sections shown in the table below.

When this setting is selected:	These parameters can be configured:
MASTER	MASTER parameters (page E-42)
MIC	MIC parameters (page E-43)
DSP	DSP parameters (page E-42)
A01 to A16/B01 to B16	Part parameters (page E-44)

- When you move the thick brackets ([ ]) to one of the setting values of a part parameter, all of the part parameter values of the group (A or B) to which the part belongs are indicated by level meter black boxes.

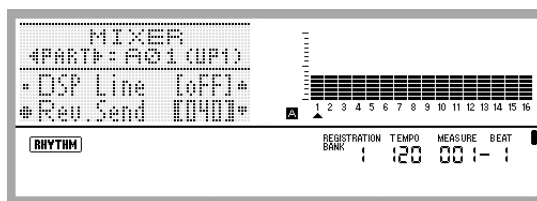

#### 4. Use the dial or R-14 (-, +) buttons to change the setting value.

- Pressing the R-14 (-, +) buttons at the same time returns a parameter to its initial default setting.
- While the "Part" (part on/off) setting of a part parameter is being configured, pressing both of the R-14 (-, +) buttons at the same time will change the setting to "Sol" (Solo). For details, see "Part Parameters" (page E-44).

#### 5. Repeat steps 2 through 4 as required to configure other parameters.

#### 6. To exit the mixer, press the C-5 (MIXER) button or the R-15 (EXIT) button.

- This exits the mixer screen.

#### NOTE

- While master (MASTER), effect (DSP) or microphone input (MIC) is selected in step 2 above for setting, you also can perform normal keyboard play (play using layer, split, and Auto Accompaniment).
- While an individual part (A01 through A16, B01 through B16) is selected in step 2 above, pressing a keyboard key will sound only notes of the selected part. All other types of performance operations (layer, split, Auto Accompaniment, etc.) are disabled.

## To initialize all mixer parameters

### NOTE

- For details about how initial default settings are configured when you perform the following procedure, see “Parameter List” (page E-127).

### 1. While the mixer screen is displayed, hold down the R-13 (FUNCTION) button as you press the C-13 (MENU) button.

- This displays the mixer menu screen with the ● next to “Initialize”.



### 2. Press the R-16 (ENTER) button.

### 3. In response to the “Sure?” message that appears, press the R-14 (YES) button to initialize all mixer parameters or the R-14 (NO) button to cancel.

## To change the information displayed by the level meter while configuring part parameter settings

### 1. While the mixer screen is displayed, hold down the R-13 (FUNCTION) button as you press the C-13 (MENU) button.

- This displays the mixer menu.

### 2. Use the R-17 (V) button to move the ● to “Display” and then press the R-16 (ENTER) button.

### 3. Use the dial or R-14 (–, +) buttons to change the setting.

To select display of this information:	Select this setting:
Part parameter setting values	Param
Volume level	Meter

### 4. After the setting is the way you want, press the R-15 (EXIT) button to exit the menu.

## Mixer Parameter Settings

The tables below show the parameters that can be configured on the mixer screen. The settings marked with an asterisk (\*) in the “Setting Range” column are initial defaults.

### MASTER Parameters

MASTER parameters include items for adjusting the volume level, pan position, and other settings that are applied globally to all parts.

Parameter Name	Description	Setting Range
Volume (Master Volume)	Specifies the maximum volume level of Digital Keyboard output. The level set here is the maximum level that can be set with the <b>L-2 (CTK-6000: VOLUME) (WK-6500: MAIN VOLUME)</b> knob.	0 to 127*
Pan (Master Pan)	Specifies the stereo pan position of all sound output by the Digital Keyboard. 0 indicates the center, while a smaller values shifts to the left and a larger value shifts to the right.	-64 to 0* to +63

### DSP Parameters

DSP parameters include DSP-related settings that are applied globally to all parts.

#### IMPORTANT!

- **DSP parameter setting cannot be changed while “on” is selected for the “DSP Disable” effect setting. See “To add the chorus effect to sounds” (page E-35) for information about “DSP Disable”. If you want to change DSP parameter settings, change the “DSP Disable” setting to “off”.**

Parameter Name	Description	Setting Range
Cho/DSP (Chorus/DSP)	Specifies whether the Digital Keyboard’s sound source should go through the chorus or DSP.*1 This setting item is linked to the “Chorus/DSP”*2 item on the effect setting screen. The settings below cannot be configured whenever this parameter is “Chorus”.	Chorus*, DSP
Part (DSP Output Enable)	Specifies if a note should be output (on) or not output (off) after it passes through the DSP.	off, on*
Volume (DSP Output Volume)	Specifies the post-DSP volume level.*1	0 to 127*
Pan (DSP Output Pan)	Specifies the post-DSP send stereo pan position. 0 indicates the center, while a smaller values shifts to the left and a larger value shifts to the right.	-64 to 0* to +63
Rev.Send (DSP Output Reverb Send)	Specifies how much reverb is applied to the post-DSP send note.	0 to 40* to 127

\*1 See the block diagram under “Configuration of Effects” (page E-32).

\*2 See “To add the chorus effect to sounds” (page E-35) and “To use a DSP” (page E-36).

**MIC Parameters (WK-6500 Only)**

The MIC parameters include microphone input (input via **T-7 (MIC IN)** jack) related settings.

Parameter Name	Description	Setting Range
Part (Mic Enable)	Specifies if sound input via a microphone should be output (on) or not output (oFF).	oFF, on*
Volume (Mic Volume)	Specifies the volume level of sound input via a microphone.*1	0 to 80* to 127
Pan (Mic Pan)	Specifies the stereo pan position of sound input via a microphone. 0 indicates the center, while a smaller values shifts to the left and a larger value shifts to the right.	-64 to 0* to +63
DSP Line (Mic DSP Line)	Specifies whether DSP should be applied to microphone input.	oFF*, on
Rev.Send (Mic Reverb Send)	Specifies how much reverb is applied to sound input via a microphone.	0 to 40* to 127
Cho.Send (Mic Chorus Send)	Specifies how much chorus effect is applied to sound input via a microphone.	0* to 127

\*1 See the block diagram under "Configuration of Effects" (page E-32).

## Part Parameters

Part parameters include setting items that can be adjusted for parts A01 through A16 and B01 through B16.

Parameter Name	Description	Setting Range
TONE (Part Tone)	Specifies a tone for each part. When configuring this parameter, you can use the buttons from <b>R-1 ([A] PIANO)</b> through <b>R-12 ([L] USER TONES)</b> to select a tone group.	A:001 to L:010
Part (Part On/Off)	Specifies if the notes of a particular part should be output (on) or not output (oFF). When a part is turned on, the part number is displayed along the bottom of the level meter. Part numbers are not displayed for parts that are turned off. When playing back a MIDI file or song sequencer song, a "Sol" (Solo) option can be specified to play a specific part only. To switch to "Sol", press both <b>R-14 (-, +)</b> buttons at the same time.	oFF, on*
Volume (Part Volume)	Specifies the volume level of each part.	0 to 127*
Pan (Part Pan)	Specifies the stereo pan position of each part. 0 indicates the center, while a smaller values shifts to the left and a larger value shifts to the right.	-64 to 0* to +63
CoarseTune (Part Coarse Tune)	Specifies, in semitone steps, the pitch of the notes of each part.	-24 to 0* to +24
FineTune (Part Fine Tune)	Specifies, in cent steps, the pitch of the notes of each part.	-99 to 0* to +99
BendRange (Part Bend Range)	Specifies the bend range of each part.	0 to 2* to 24
DSP Line (Part DSP Line)	Specifies whether DSP should be applied to each part. Changing this setting from "oFF" to "on" automatically switches the "Cho/DSP" setting (page E-42) to "DSP".	oFF*, on
Rev.Send (Part Reverb Send)	Specifies how much reverb is applied to each part. No reverb is applied at all when this setting is 0, while maximum reverb is applied when it is 127.	0 to 40* to 127
Cho.Send (Part Chorus Send)	Specifies how much chorus is applied to each part. No chorus is applied at all when this setting is 0, while maximum chorus is applied when it is 127.	0* to 127
Scale (Part Scale Enable)	Specifies whether scale (page E-21) settings should be applied (on) or should not be applied (oFF). Equal temperament is applied to parts when this setting is "oFF".	oFF*, on

# Using the Tone Editor

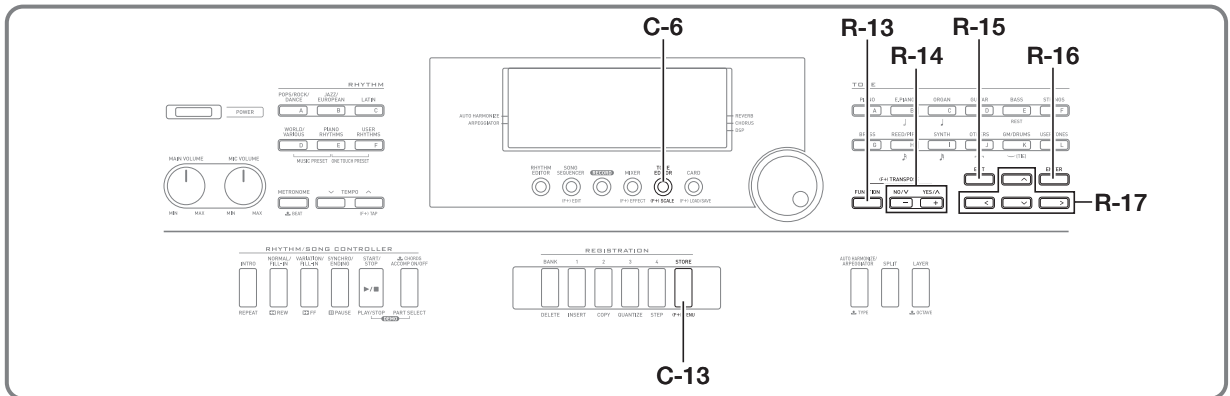

You can create a user tone by editing one of the built-in preset tones.

## Tone Creation Overview

The preset tones built into this Digital Keyboard consist of a number of parameters. To create a user tone, you first recall a preset tone (A:001 to K:128) and then modify its parameters to change it to your own original tone.

Note that drum set sounds (K:129 through K:145) cannot be used as the basis of a user tone.

The illustration nearby shows the parameters that make up the preset tones, and what each parameter does. As can be seen in the illustration, parameters can be divided into four groups, each of which is described in detail below.

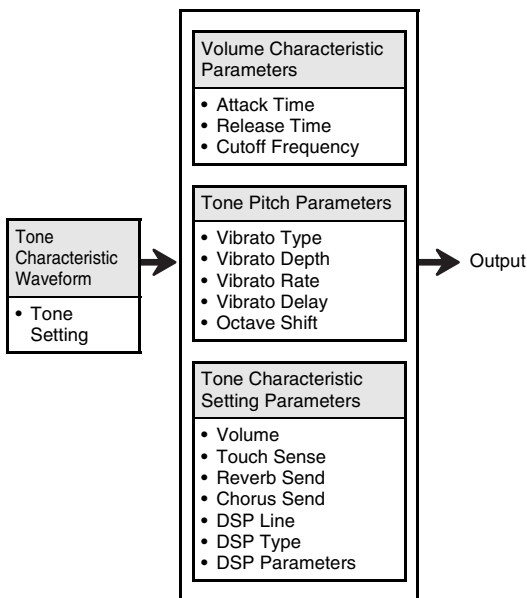

### (1) Tone Characteristic Waveform

#### • Tone Setting

Specifies which of the preset tones should be used as the original tone.

### (2) Volume Characteristic Parameters

These parameters control how the tone changes over time, from when the keyboard key is pressed until the tone decays. You can specify changes in volume and sound characteristics.

#### • Attack time

This is the rate or time it takes for the tone to reach its highest volume level. You can specify a fast rate, where the tone reaches its highest volume level immediately, a slow rate where it gradually rises, or something in between.

#### • Release time

This is the rate or time it takes for the tone volume to fall to zero after a keyboard key is released. You can specify a release that ranges from a sudden fall to zero, to one that gradually falls to zero.

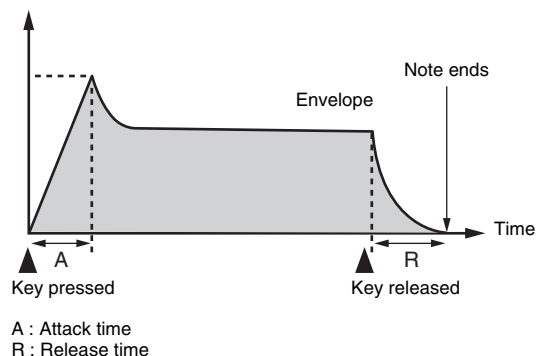

**Cutoff Frequency**

The cutoff frequency is a parameter for adjusting timbre by cutting any frequency that is higher than a specific frequency. A larger cutoff frequency produces a brighter (harder) timbre, while a smaller frequency produces a darker (softer) timbre.

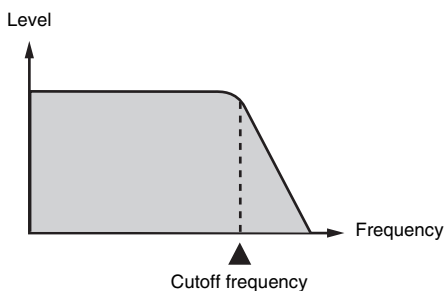

**(3) Tone Pitch Parameters**

**Vibrato Type, Vibrato Delay, Vibrato Rate, Vibrato Depth**

These parameters adjust the vibrato effect, which causes periodic changes in the tone.

**Octave Shift**

This parameter controls the octave of all tones.

**(4) Tone Characteristic Setting Parameters**

**Volume**

This parameter controls the overall volume of the tone.

**Touch Sense**

This parameter controls changes in volume and timbre in accordance with the relative amount of pressure applied to the keyboard keys. You can specify more volume for stronger pressure and less volume or a lighter pressure, or you can specify the same volume regardless of how much pressure is applied to the keys.

**Reverb Send, Chorus Send, DSP Line, DSP Type, DSP Parameters**

These parameters control the effects applied to tones.

## Creating a User Tone

### User Tone Numbers

Tone areas numbered L:001 through L:010 are for storage of user tones. You can have up to 10 user tones stored in memory at one time. You can recall a stored user tone by pressing the **R-12 ([L] USER TONES)** button. See "To select a tone" (page E-14).

### To create and save a user tone

1. Select the tone you want to edit in order to create your user tone.
2. Press the **C-6 (TONE EDITOR)** button.



- This displays the tone editor screen.

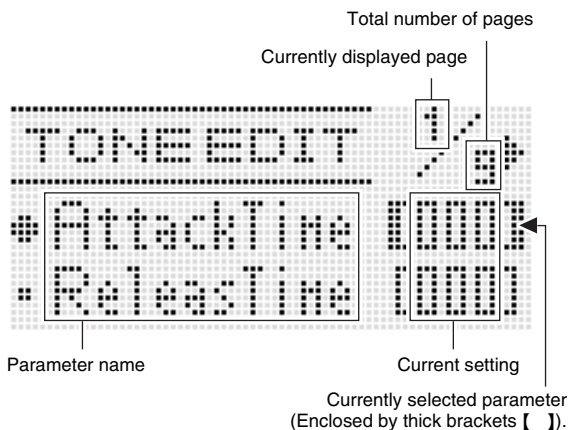

- You can use the **R-17 (<, >)** buttons to scroll between pages.

3. Use the **R-17 (^, v)** buttons to move the thick brackets ([ ]) to the parameter you want to change.

- For information about the operation and the setting range of each parameter, see "Tone Parameter Settings" (page E-48).

4. Use the dial or **R-14 (-, +)** buttons to change the setting value.

- Pressing the **R-14 (-, +)** buttons at the same time returns a parameter to its initial default setting.

5. Repeat steps 3 and 4 as required to configure other parameters.



**6. To save a rhythm after you edit it, hold down the R-13 (FUNCTION) button as you press the C-13 (MENU) button.**

- This displays the tone editor menu.

**7. Press the R-16 (ENTER) button.**

- This displays a screen for specifying the destination user tone number and tone name.

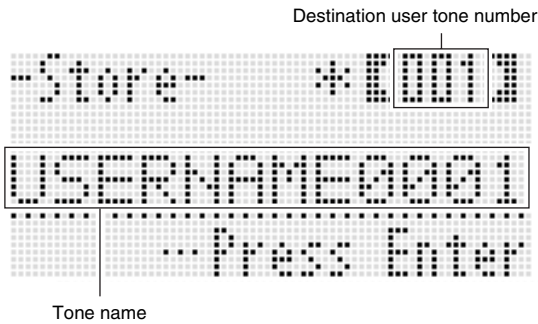

**8. Use the dial or R-14 (-, +) buttons to select the destination user tone number you want.**

**9. Use the R-17 (<, >) buttons to move the cursor to the name character position you want to change, and then use the dial or R-14 (-, +) buttons to select the character you want.**

- See “Supported Input Characters” (page E-124) for information about the characters you can input for the name.
- To input a space, press both of the R-14 (-, +) buttons at the same time.

**10. After everything is the way you want, press the R-16 (ENTER) button.**

- A message (Replace?) will appear on the display to confirm whether you want to replace the existing data with the new data. Press the R-14 (YES) button to replace the existing data with the new data.

**IMPORTANT!**

- The message “Please Wait” will remain on the display while a data save operation is in progress. Do not perform any other operation while it is displayed. Turning off the Digital Keyboard or removing the memory card can cause Digital Keyboard data to be deleted or become corrupted. It also can cause the Digital Keyboard to fail to turn on when the L-1 (POWER) button is pressed. If this happens, refer to “Troubleshooting” (page E-114).

**NOTE**

- Pressing the R-15 (EXIT) button in place of step 6 displays the confirmation screen shown below. Pressing the R-14 (YES) button at this time will display the tone save screen in step 9.















To cancel the editor operation without saving the edited results, press the R-14 (NO) button.

## Tone Parameter Settings

The table below shows the parameters that can be configured on the tone editor screen. For information about each parameter, also refer to “Tone Creation Overview” (page E-45).

The settings marked with an asterisk (\*) in the “Setting Range” column are initial defaults.

Parameter Name	Description	Setting Range															
AttackTime (Attack Time)	Specifies the time until a note starts to sound after a key is pressed.	-64 to 0* to +63															
ReleasTime (Release Time)	Specifies the time a note continues to sound after a key is released.	-64 to 0* to +63															
CutOff (Cutoff Frequency)	Adjusts timbre by attenuating note components that are higher than a certain frequency. A larger value produces a brighter, harder sound, while a lower value produces a mellower, softer sound.	-64 to 0* to +63															
Vib.Type (Vibrato Type)	Specifies the vibrato type (vibrato waveform). <table border="1" data-bbox="433 624 1000 929"> <thead> <tr> <th>Setting</th> <th>Description</th> <th>Waveform</th> </tr> </thead> <tbody> <tr> <td>Sin</td> <td>Sine wave</td> <td></td> </tr> <tr> <td>Tri</td> <td>Triangle wave</td> <td></td> </tr> <tr> <td>Saw</td> <td>Sawtooth wave</td> <td></td> </tr> <tr> <td>Sqr</td> <td>Square wave</td> <td></td> </tr> </tbody> </table>	Setting	Description	Waveform	Sin	Sine wave		Tri	Triangle wave		Saw	Sawtooth wave		Sqr	Square wave		Sin*, Tri, Saw, Sqr
Setting	Description	Waveform															
Sin	Sine wave																
Tri	Triangle wave																
Saw	Sawtooth wave																
Sqr	Square wave																
Vib.Depth (Vibrato Depth)	Specifies how much vibrato is applied to a note.	-64 to 0* to +63															
Vib.Rate (Vibrato Rate)	Specifies the speed of the vibrato applied to a note.	-64 to 0* to +63															
Vib.Delay (Vibrato Delay)	Specifies how much time elapses until vibrato starts.	-64 to 0* to +63															
Oct.Shift (Octave Shift)	Shifts the pitch upwards or downwards in octave steps.	-2 to 0* to +2															
Volume (Volume)	Specifies the volume level of all tones. A larger value sets a higher volume level.	0 to 127*															
TouchSense (Touch Sense)	Specifies how much the volume changes in accordance with the relative amount of pressure applied to keyboard keys. A larger positive value results more change in volume in accordance with key pressure. A larger negative value results in less change in volume in accordance with key pressure. Key pressure does not affect volume when a value of 0 is set.	-64 to 0 to +63*															
Rev.Send (Reverb Send)	Specifies how much reverb is applied for each tone.	0 to 40* to 127															
Cho.Send (Chorus Send)	Specifies how much chorus is applied for each tone.	0* to 127															

Parameter Name	Description	Setting Range
DSP On Off (DSP On/Off)	Specifies whether DSP should be applied (on) or not applied (off) to notes. The following four settings become enabled when “on” is selected for this setting.	oFF*, on
DSP	Specifies the DSP to be applied to tones using DSP numbers (001 to 100: Preset DSPs; 101 to 200: User DSPs). Selecting “ton” applies the initial preset DSP of each tone.	ton*, 001 - 200
DSP Type (DSP Type)	Shows the DSP type number corresponding to the above DSP value that is set automatically as the initial default setting.*1 You can modify the initial default setting and select a different DSP type.	01 - 46*1
DSP Parameters 1 through 8	Shows up to eight parameters for “DSP Type”. *2	*2
DSP RevSend (DSP Reverb Send)	Adjusts how much reverb is applied to the post-DSP note.	0 - 40* - 127

\*1 See “Preset DSP List” (page E-119) for information about the DSP types of each preset DSP.

\*2 The number of DSP parameters, their content, and their setting ranges depend on the DSP type. For details, see “DSP Type List” (page E-120) and “DSP Parameter List” (page E-121).

# Music Presets

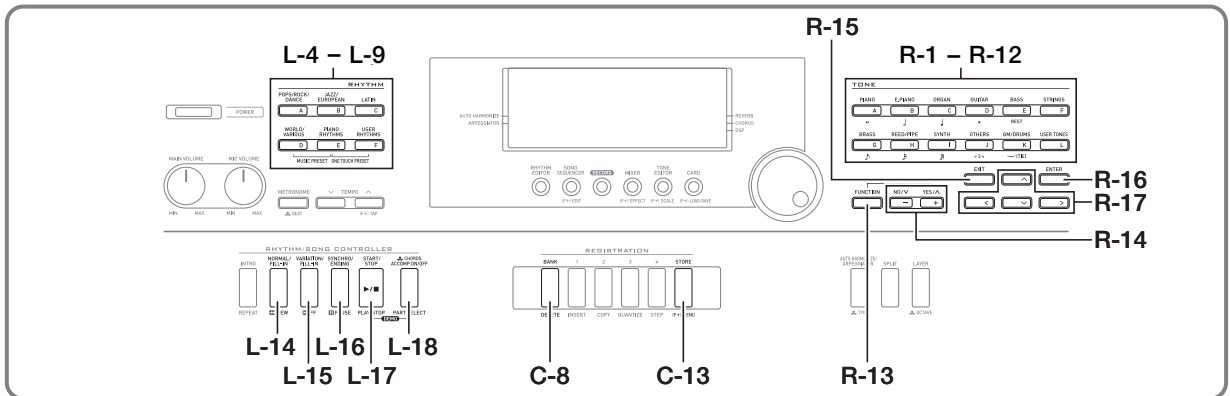

## Using Music Presets

Music presets provide one-touch access to Auto Accompaniment, tone, reverb, and other settings that are configured in accordance with preset chord progressions. A total of 305 presets let you easily configure the keyboard for a wide variety of different musical styles. Chord progressions include both short loops of a few measures that are great for improvisation, as well as progressions for entire songs. Chord progressions are also fun just to listen to. In addition to built-in presets, you can create your own original music presets (user presets). You can record chord progressions up to 999 measures long, which provides plenty of versatility for long songs. Music presets are divided among six groups, each of which corresponds to one of the **RHYTHM** buttons from [A] through [F]. Groups [A] through [E] are built-in preset groups, while Group [F] is the user preset group.

### To perform using a music preset

1. Refer to the separate “Appendix” to find the music preset you want to use, and note its group and number.

2. While holding down the L-7 ([D] WORLD/VARIOUS) button, press the L-8 ([E] PIANO RHYTHMS) button.

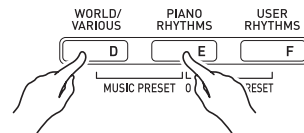

- This displays the music preset screen like the one shown below.

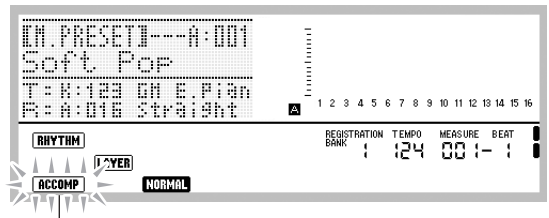

Flashing

- The **ACCOMP** indicator will be flashing on the display. This indicates that play with a preset chord progression is enabled.
- Depending on the music preset you selected, the **NORMAL**, **LAYER**, or other indicators may also be flashing or displayed.

3. Use the buttons from L-4 ([A] POPS/ROCK/DANCE) to L-9 ([F] USER RHYTHMS) to select a music preset group.

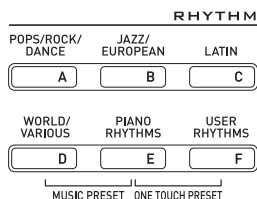

- The L-9 ([F] USER RHYTHMS) button is for the user preset group. For details, see “Creating a User Preset” (page E-54).
4. Use the dial or R-14 (–, +) buttons to scroll through the music preset numbers until the one you want is displayed.
- Tone, rhythm, and other settings will be configured in accordance with the music preset you selected. For details about the settings that are configured by a music preset, see “Music Preset Settings” (page E-52).
5. What you should do to start your performance depends on the music preset you selected as described below.

When the **NORMAL**, **INTRO**, or **VARIATION** indicator is flashing on the display:

→ The flashing indicator means that the Digital Keyboard is in synchro standby. Press a key in the chord keyboard to the left of the split point (page E-17). This will start Auto Accompaniment play along with the chord progression.

When the **NORMAL**, **INTRO**, or **VARIATION** indicator is not flashing on the display:

→ Press the L-17 (START/STOP) button. This will start Auto Accompaniment play along with the chord progression.

6. Play the melody along with the Auto Accompaniment.

- The preset chord progression repeats the same pattern. The number of measures in the progression depends on the music preset that is selected. Shorter progressions are made up of two to four measures, while longer are 30 to 40 measures long. For some chord progressions, a fill-in pattern will be inserted automatically at the end of a progression pattern.
- You can change to a different music preset while Auto Accompaniment play is in progress, or after stopping your performance in step 7, below. Perform steps 3 and 4 of this procedure to change to another music preset. If you change to a different music preset while playing, the change will be executed after playback reaches the end of the measure you are in when you make the change.

7. To stop playing, press the L-16 (SYNCHRO/ENDING) button or the L-17 (START/STOP) button.

- The **ACCOMP** indicator continues to flash on the display even after you stop playing. Pressing the L-17 (START/STOP) button at this time will restart Auto Accompaniment play.

8. Press the R-15 (EXIT) button to exit the music preset screen.

- You also can press the R-15 (EXIT) button while Auto Accompaniment play is in progress. In this case, play will stop and the music preset screen will be exited as soon as you press the R-15 (EXIT) button.

#### NOTE

- Instead of using the preset chord progression, you also can use the chord keyboard (page E-26) to play Auto Accompaniment chords, and you also can play with the rhythm only. For details, see “To change music preset Auto Accompaniment settings” (page E-53).
- During play using a music preset, you can change tone, rhythm, tempo, mixer, effect, and other settings.

## Music Preset Settings

The settings listed in the table below are recalled when a music preset is selected.

- Except for the chord progression, all of the settings can be modified after a music preset is selected. Refer to the information noted in the “Go here for more information” column of the table for details about modifying a particular setting.
- Selecting a different music preset or exiting the music preset screen clears any modifications you make in the currently selected preset. If you want to retain modified settings for later use, you can save them as a user preset. For details, see “Creating a User Preset” (page E-54).

Setting	Go here for more information
Tones for the UPPER 1, UPPER 2, and LOWER parts	Layering and Splitting Tones (page E-15)
Layer on/off, split on/off	
Octave shift for the UPPER 1, UPPER 2, and LOWER parts	Using Octave Shift (page E-18)
Reverb on/off and type	To add reverb to sounds (page E-34)
Auto harmonize tones	Using the Mixer (page E-39), Part Parameters (page E-44)
Volume of the UPPER 1, UPPER 2, LOWER, and auto harmonize parts	
Part on/off	
Auto harmonize or arpeggiator on/off and type	Using Auto Harmonize (page E-28), Playing Arpeggio Phrases Automatically (Arpeggiator) (page E-23)
Arpeggiator hold, arpeggiator speed, arpeggiator part	Function Menu Settings (page E-97)
Rhythm	To change the rhythm while using a music preset (page E-53)
Synchro start type (normal, intro, variation)	Playing an Auto Accompaniment (page E-24)
Tempo	To change the tempo setting (page E-19)
Chord progression	–

### NOTE

- If you change to a different music preset while a music preset is playing, changes in rhythm and tempo will be executed after the measure you are in when you make the change is complete.
- Though you cannot modify the chord progression of a music preset, you can modify the preset chord progression and save it as a user preset. For details, see “Creating a User Preset” (page E-54).

## To change music preset Auto Accompaniment settings

While the music preset screen is displayed, you can use the **L-18 (ACCOMP ON/OFF)** button to change Auto Accompaniment settings.

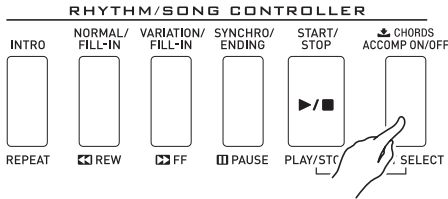

- Each press of the **L-18 (ACCOMP ON/OFF)** button cycles through settings as shown below.

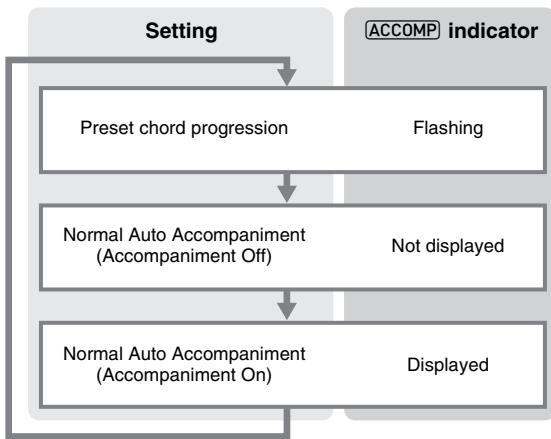

- When a preset chord progression or accompaniment off is selected, the keyboard can be used for melody play. When accompaniment on is selected, the left side range of the keyboard is the chord keyboard, and the right side range is the melody keyboard.

## To change the rhythm while using a music preset

While the music preset screen is displayed, buttons **L-4 ([A] POPS/ROCK/DANCE)** to **L-9 ([F] USER RHYTHMS)** function as music preset group select buttons. Because of this, you need to perform the procedure below to change the rhythm.

### 1. Press the R-17 (V) button twice.

- This displays a rhythm selection screen like the one shown below.



### 2. Use the buttons from L-4 ([A] POPS/ROCK/DANCE) to L-9 ([F] USER RHYTHMS) to select a rhythm group.

### 3. Use the dial or R-14 (-, +) buttons to scroll through the rhythm numbers until the one you want is displayed.

### 4. After selecting the rhythm you want, press the R-15 (EXIT) button or press the R-17 (V) button twice.

- This exits the rhythm selection screen.

### NOTE

- Pressing a button from **R-1 ([A] PIANO)** through **R-12 ([L] USER TONES)** while a music preset is in use will display the tone selection screen. While the tone selection screen is displayed, pressing the **R-17 (V)** button once will change to the rhythm selection screen shown in the procedure above.

## Creating a User Preset

### User Preset Numbers

Preset areas numbered F:001 through F:050 are for storage of user presets. You can have up to 50 user presets stored in memory at one time. You can recall a stored user preset after pressing the **L-9 ([F] USER RHYTHMS)** button. See “To perform using a music preset” (page E-50) for more information.

### To create and save a user preset

**1. Perform steps 1 through 4 under “To perform using a music preset” (page E-50) and select the music preset you want to edit in order to create your user music preset.**

**2. Configure tone and other settings referring to “Music Preset Settings” (page E-52).**

**3. While holding down the R-13 (FUNCTION) button, press the C-13 (MENU) button.**

- This displays the MP (music preset) editor screen like the one shown below.

```

-MP Edit-          1/2B
# Chord Edit      >Ent
# Parameter       >Ent
# Store           >Ent
    
```

- Pressing the **R-16 (ENTER)** button here will change to a screen for editing the chord progression. See “Editing a Chord Progression” (page E-58) for more information.

**4. Use the R-17 (∧, ∨) button to move the ● to “Parameter” and then press the R-16 (ENTER) button.**

- This displays the parameter menu.

```

-Parameter-        1/2B
# Syncro [ off ]   1
# IntroChd [ C ]   1
# EndIntroChd [ C ] 1
    
```

**5. You can change each of the parameters on the parameter menu as required.**

- (1) Use the **R-17 (∧, ∨, <, >)** buttons to move ● to the parameter you want to change.
- (2) Use the dial or the **R-14 (-, +)** buttons to change the setting value.
  - Pressing the **R-14 (-, +)** buttons at the same time returns a parameter to its initial default setting.
  - The following explains the meanings and setting ranges of the on-screen items. The settings marked with an asterisk (\*) in the “Setting Range” column are initial defaults.

Item name	Description	Setting Range
Syncro (Synchro type)	Specifies the Auto Accompaniment synchro start standby type.	oFF, Normal*, Variation, Intro
IntroChd (Intro chord)	Specifies the chords of the Auto Accompaniment intro pattern.	C* - B, Cm - Bm
EndingChd (Ending chord)	Specifies the chords of the Auto Accompaniment ending pattern.	C* - B, Cm - Bm
AutoFill (Auto fill in)	Specifies whether a fill in should be inserted (on) or not inserted (oFF) at the end of the chord progression.	on*, oFF
Timing (Timing set)	Specifies the chord change timing during playback for recorded chords. For information about differences in playback for each setting value, see “Timing Setting and Chord Progression Playback” (page E-56).	Normal*, Half, Double, 3/4, 3/2

- (3) Repeat steps (1) and (2) as required.
- (4) After the settings are the way you want, press the **R-15 (EXIT)** button.
  - This returns to the MP editor screen.



**6. Use the R-17 (V) button to move the ● to “Store” and then press the R-16 (ENTER) button.**

- This displays a screen for specifying the destination user preset number and name.

Save destination user preset number



User preset name

**7. Use the dial or R-14 (–, +) buttons to select the destination user preset number you want.**

**8. Use the R-17 (<, >) buttons to move the cursor to the name character position you want to change, and then use the dial or R-14 (–, +) buttons to select the character you want.**

- For details about the characters you can input, see “Supported Input Characters” (page E-124).
- To input a space, press both of the R-14 (–, +) buttons at the same time.

**9. After everything is the way you want, press the R-16 (ENTER) button.**

- If the user preset number where you are saving the data already has data saved to it, a message (Replace?) will appear on the display to confirm whether you want to replace the existing data with the new data. Press the R-14 (YES) button to replace the existing data with the new data or the R-14 (NO) button to cancel and return to the screen in step 6.

**IMPORTANT!**

- The message “Please Wait” will remain on the display while a data save operation is in progress. Do not perform any other operation while it is displayed. Turning off the Digital Keyboard or removing the memory card can cause Digital Keyboard data to be deleted or become corrupted. It also can cause the Digital Keyboard to fail to turn on when the L-1 (POWER) button is pressed. If this happens, refer to “Troubleshooting” (page E-114).

**NOTE**

- Pressing the R-15 (EXIT) button in place of step 6 displays the confirmation screen shown below. Pressing the R-14 (YES) button at this time will display the user preset save screen in step 7.



To cancel the editor operation without saving the edited results, press the R-14 (NO) button.

**To clear user preset data**

1. While holding down the R-13 (FUNCTION) button, press the C-13 (MENU) button to display the MP (music preset) editor screen.
2. Use the R-17 (V) button to move the ● to “Clear” and then press the R-16 (ENTER) button.
  - This displays a screen for specifying the number of the user preset you want to clear.
3. Use the dial or R-14 (–, +) buttons to specify the number of the user preset you want to clear.
4. Press the R-16 (ENTER) button.
5. In response to the “Sure?” message that appears, press the R-14 (YES) button to clear or the R-14 (NO) button to cancel.

## Timing Setting and Chord Progression Playback

This section explains how chord progressions are played in accordance with the “Timing” (Timing set) settings in step 5 under “To create and save a user preset” (page E-54). Note that this setting affects playback only. It does not change the chord progression data.

- **Normal**

Plays chords at the same timing as the recording.

- **Half**

Plays chords measure-by-measure at a timing that is half that of the recording.

Example:

Measure	1				2				3				4			
Beat	1	2	3	4	1	2	3	4	1	2	3	4	1	2	3	4
Chord progression	Dm		A7		Dm		G7		C		EM7		Am		C7	

The following shows what happens when the “Half” setting is used to play back a user preset that was created based on a music preset whose rhythm is a 4/4 time.

### Half Playback when a 4/4 time rhythm is assigned to the user preset

Measure	1				2				3				4			
Beat	1	2	3	4	1	2	3	4	1	2	3	4	1	2	3	4
Chord progression	Dm		A7		Dm		G7		C		EM7		Am		C7	

### Half Playback when a 2/4 time rhythm is assigned to the user preset

Measure	1		2		3		4	
Beat	1	2	1	2	1	2	1	2
Chord progression	Dm A7		Dm G7		C EM7		Am C7	

- **Double**

Plays chords measure-by-measure at a timing that is double that of the recording.

Playing back a chord progression like that shown for “Half” above while “Double” is specified results in the progression shown below.

### Double Playback when a 4/4 time rhythm is assigned to the user preset

Measure	1				2				3				4			
Beat	1	2	3	4	1	2	3	4	1	2	3	4	1	2	3	4
Chord progression	Dm				Dm				C				Am			

### Double Playback when an 8/4 time rhythm is assigned to the user preset

Measure	1								2								3	
Beat	1	2	3	4	5	6	7	8	1	2	3	4	5	6	7	8	1	2
Chord progression	Dm				A7				Dm				G7				C	

- 3/4**  
 Plays chords measure-by-measure at a timing that is 3/4 times that of the recording. This setting is best for use with a 6/8 time rhythm.  
 Playing back a chord progression like that shown for “Half” above while “3/4” is specified results in the progression shown below.

**3/4 Playback when a 4/4 time rhythm is assigned to the user preset**

Measure	1	2	3	4
Beat	1 2 3 4	1 2 3 4	1 2 3 4	1 2 3 4
Chord progression	Dm A7	Dm G7	C EM7	Am C7

**3/4 Playback when a 6/8 time rhythm is assigned to the user preset**

Measure	1	2	3	4
Beat	1 2 3 4 5 6	1 2 3 4 5 6	1 2 3 4 5 6	1 2
Chord progression	Dm A7	Dm G7	Dm EM7	Am

- 3/2**  
 Plays chords measure-by-measure at a timing that is 3/2 times that of the recording. This setting is best for use with a 6/4 time rhythm.  
 Playing back a chord progression like that shown for “Half” above while “3/2” is specified results in the progression shown below.

**3/2 Playback when a 4/4 time rhythm is assigned to the user preset**

Measure	1	2	3	4
Beat	1 2 3 4	1 2 3 4	1 2 3 4	1 2 3 4
Chord progression	Dm A7	Dm G7	C EM7	Am C7

**3/2 Playback when a 6/4 time rhythm is assigned to the user preset**

Measure	1	2	3	4
Beat	1 2 3 4 5 6	1 2 3 4 5 6	1 2 3 4 5 6	1 2
Chord progression	Dm A7	Dm G7	Dm EM7	Am

 **NOTE**

- When “Double” or “3/2” is selected, chord timing is shifted to a later timing. Any chords that do not fit within a measure are not played.

## Editing a Chord Progression

You can modify the preset chord progression and save it as a user preset, or you can create a new chord progression from scratch and save it.

### Chord Progression Editing Flow

**1. Perform steps 1 through 4 under “To perform using a music preset” (page E-50) and select the music preset you want to edit in order to create your user music preset.**

**2. Configure tone and other settings referring to “Music Preset Settings” (page E-52).**

**3. While holding down the R-13 (FUNCTION) button, press the C-13 (MENU) button.**

- This displays the MP (music preset) editor screen like the one shown below with the ● next to “Chord Edit”.



**4. Press the R-16 (ENTER) button.**

- This displays the chord editor screen shown below. You can use this screen to directly edit the individual chord data items of a chord progression.

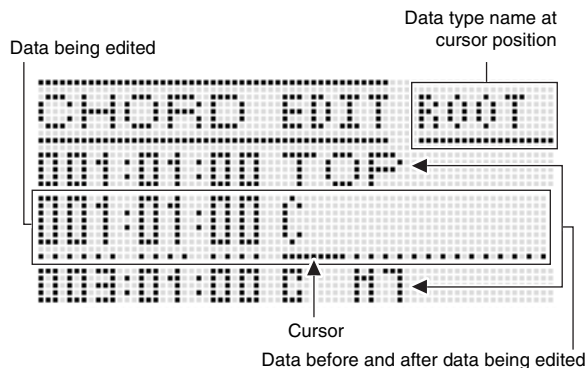

**5. Perform the following chord progression editing operations.**

- Change an existing chord (“To modify recorded chord data”, page E-59)
- Delete an existing chord (“To delete recorded chord data”, page E-59)
- Insert a new chord (“To insert a new chord”, page E-59)
- Delete all existing chords (“Initialize”, under “To perform menu operations”, page E-61)
- Input a series of chords (“To perform step input of chords”, page E-60)
- Key shift all existing chords (“Key Shift”, under “To perform menu operations”, page E-61)
- Insert another music preset chord progression following the chord progression data of the preset being edited (“Append Chord”, under “To perform menu operations”, page E-61)
- Delete existing chords in a specific measure (“Delete Measure”, under “To perform menu operations”, page E-61)
- Insert blank measures at a specific location (“Insert Measure”, under “To perform menu operations”, page E-61)

**6. After editing is complete, press the R-15 (EXIT) button.**

- This returns to the MP editor screen.

**7. Perform steps 4 through 9 under “To create and save a user preset” on page E-54.**

- Steps 4 and 5 can be skipped if they are not necessary.

### To modify recorded chord data

1. Perform steps 1 through 4 of the procedure under “Chord Progression Editing Flow” on page E-58.
2. Use the R-17 (Λ, V) buttons to move the cursor to the chord you want to edit.
  - You can use the L-15 (▶▶FF) and L-14 (◀◀REW) buttons to move the cursor by measure-by-measure.
3. Use the R-17 (<, >) buttons to move the cursor, and then use the dial or R-14 (–, +) buttons to change the value at the cursor position.
  - The cursor flashes during a value change operation.

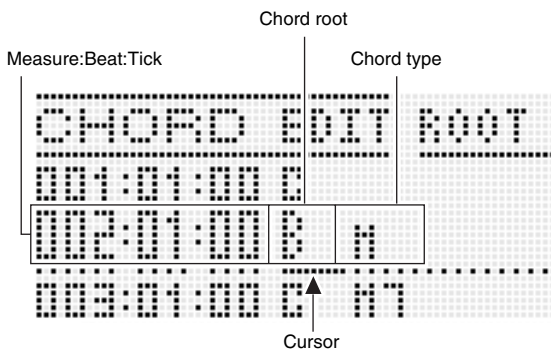

- A “tick” is a time unit that is shorter than one beat. With music preset data, 12 ticks equal one beat. This means that you can specify a tick value in the range of 00 to 11. A tick value of 12 advances to the next beat. In the case of 4/4 time, a quarter note (♩) is 12 ticks and an eighth note (♩) is 6 ticks.

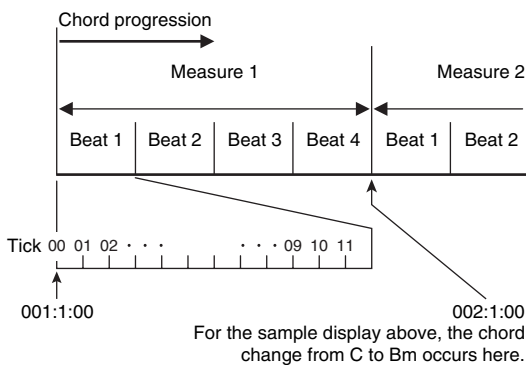

4. To apply the changed value, press the R-16 (ENTER) button.

- This causes the cursor to stop flashing.

### IMPORTANT!

- You cannot change the timing (Measure:Beat:Tick) of the first chord of the user preset data.

### To delete recorded chord data

1. Perform steps 1 through 4 of the procedure under “Chord Progression Editing Flow” on page E-58.
2. Use the R-17 (Λ, V) buttons to move the cursor to the chord you want to delete.
3. Press the C-8 (DELETE) button.
  - The chord at the current cursor position will be deleted as soon as you press the C-8 (DELETE) button.

### IMPORTANT!

- You cannot delete the first chord of the user preset data.

### To insert a new chord

1. Perform steps 1 through 4 of the procedure under “Chord Progression Editing Flow” on page E-58.
2. Use the R-17 (Λ, V) buttons to move the cursor to the chord that comes immediately before the position where you want to insert a chord.
3. Press the C-9 (INSERT) button.
  - This displays a screen like the one shown below.



**4. Specify the location of the new chord insert as a number of beats after the current cursor position.**

To specify this number of beats after the current cursor position:	Press this button:
4 beats	R-1 (•)
2 beats	R-2 (♪)
1 beat	R-3 (♩)
1/2 beat	R-7 (♩)
1/4 beat	R-8 (♩)

- Except for the R-8 (♩) button, pressing the R-4 (•) button after you press any one of the above buttons will increase number of beats by 1.5.
- Pressing the R-10 (♩) button after you press any one of the above buttons will change the number of beats by 2/3.
- The R-9 (♩) and R-11 (TIE) buttons are disabled during this step.

**5. Press the R-16 (ENTER) button.**

- This inserts the chord and causes the cursor to appear at the "ROOT" position of the inserted chord data. The initial default root setting is C.



**6. Use the dial or the R-14 (-, +) buttons to specify the root.**

**7. Use the R-17 (>) button to move the cursor to "TYPE" position, and then use the dial or R-14 (-, +) buttons to configure the type setting.**

- When the cursor is located at "ROOT" or "TYPE", you can use the chord keyboard to specify the chord root or type.

**8. To apply the chord data, press the R-16 (ENTER) button.**

- This causes the cursor to stop flashing.

**To perform step input of chords**

**1. Perform steps 1 through 4 of the procedure under "Chord Progression Editing Flow" on page E-58.**

**2. Press the C-12 (STEP) button.**

- This will display a step screen like the one shown below.



**3. Use the L-15 (FF) and L-14 (REW) buttons to move the cursor to the location from which you want to perform step input.**

- The cursor will move in one-measure steps.

**4. Specify the length of the chord you want to input.**

- For information about how to do this, see the table in step 4 under "To insert an event" (page E-88).
- The R-9 (♩) button is disabled during this step. Also note that you cannot specify a dotted 16th note.

**5. Press the keyboard keys that correspond to the chord you want to input.**

- Press keyboard keys in accordance with the current chord fingering mode. For details, see "Selecting a Chord Fingering Mode" (page E-26).
- The chord is input as soon as you press the keyboard key, and the cursor will move by the length you specified in step 4 to the next measure:beat:tick. From there you can input the next chord, if you want.

**IMPORTANT!**

- You cannot input more than 999 measures here.

**6. Repeat steps 4 and 5 to input the chords you want.**

- If you want to input a series of chords of the same length, skip step 4 and perform step 5 only.

**7. When you are finished with step input, press the R-15 (EXIT) button twice.**

## To perform menu operations

1. Perform steps 1 through 4 of the procedure under “Chord Progression Editing Flow” on page E-58.
2. While holding down the R-13 (FUNCTION) button, press the C-13 (MENU) button.
3. This displays a screen like the one shown below.



### 4. Execute the desired menu operation.

To do this:	Do this:
Delete all existing chords (Initialize) <sup>*1</sup>	Use the R-17 (▲, ▼) buttons to move the ● to “Initialize” and then press the R-16 (ENTER) button.
Key shift all existing chords (Key Shift)	<ol style="list-style-type: none"> <li>1. Use the R-17 (▲, ▼) buttons to move the ● to “Key Shift” and then press the R-16 (ENTER) button.</li> <li>2. Use the dial or R-14 (–, +) buttons to specify how much you want to shift the key. <ul style="list-style-type: none"> <li>• You can specify a value from –5 to +6.</li> </ul> </li> <li>3. Press the R-16 (ENTER) button.</li> </ol>
Insert another music preset chord progression following the chord progression data of the preset being edited (Append Chord) <sup>*2</sup>	<ol style="list-style-type: none"> <li>1. Use the R-17 (▲, ▼) buttons to move the ● to “Append Chord” and then press the R-16 (ENTER) button.</li> <li>2. Use the dial or R-14 (–, +) buttons to scroll through the music preset numbers until the one you want is displayed, and then press the R-16 (ENTER) button.</li> </ol>
Delete existing chords in a specific measure (Delete Measure) <sup>*3</sup>	<ol style="list-style-type: none"> <li>1. Use the R-17 (▲, ▼) buttons to move the ● to “DeleteMeas.” and then press the R-16 (ENTER) button.</li> <li>2. Use the dial or R-14 (–, +) buttons to specify the start measure of the delete operation.</li> <li>3. Press the R-17 (▼) button to move the thick brackets ([ ]) to “Size”.</li> <li>4. Use the dial or R-14 (–, +) buttons to specify the number of measures you want to delete.</li> <li>5. After everything is the way you want, press the R-16 (ENTER) button.</li> </ol>
Insert blank measures at a specific location (Insert Measure) <sup>*2</sup>	<ol style="list-style-type: none"> <li>1. Use the R-17 (▲, ▼) buttons to move the ● to “InsertMeas.” and then press the R-16 (ENTER) button.</li> <li>2. Use the dial or R-14 (–, +) buttons to specify the start measure of the insert operation.</li> <li>3. Press the R-17 (▼) button to move the thick brackets ([ ]) to “Size”.</li> <li>4. Use the dial or R-14 (–, +) buttons to specify the number of measures you want to insert.</li> <li>5. After everything is the way you want, press the R-16 (ENTER) button.</li> </ol>

\*1 Deletes all existing chords, and replaces it with four measures of data with a C-chord at the first beat of the first measure (user preset initial data).

\*2 You will not be able to execute this operation if the number of measures specified exceeds 999.

\*3 You cannot delete all measures. If you specify range that includes all of the measures, the first measure will remain without being deleted.

### 5. In response to the “Sure?” message that appears, press the R-14 (YES) button to execute the operation you performed in step 4 or the R-14 (NO) button to cancel.

- Pressing the R-14 (YES) button starts the process. The message “Please Wait” will remain on the display if the process takes time to perform. Do not perform any operation while this message is on the display.



# Saving Keyboard Setups to Registration Memory

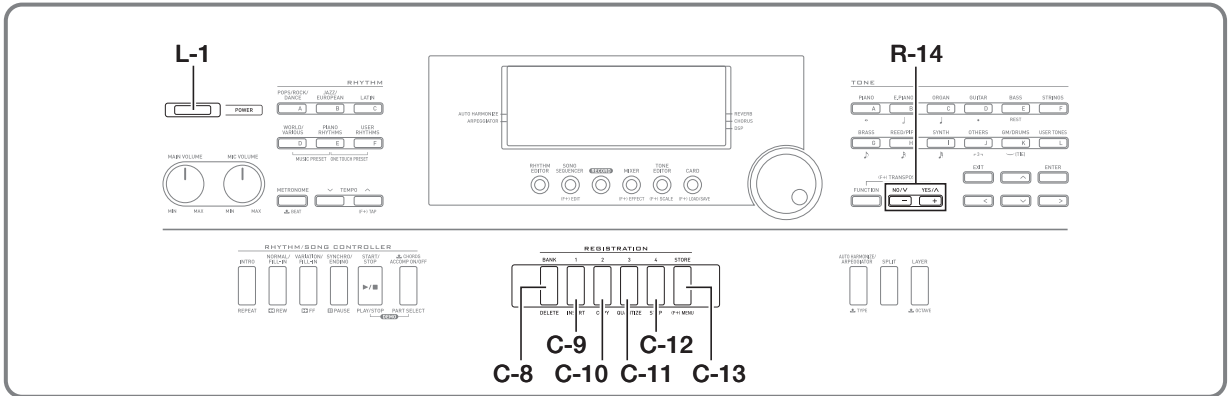

Registration memory lets you store Digital Keyboard setups (tone, rhythm, etc.) for instant recall whenever you need them.

## NOTE

- For information about items that can be part of a registration setup, see “Parameter List” (page E-127).
- When recalling a registration setup, you can recall only the setting items related to accompaniments, or only the setting items related to scales. For more information, see “RegFltAcmp (Registration Filter: Accompaniment)” (page E-98) and “RegFltScal (Registration Filter: Scale)” (page E-98).

You can have up to 32 setups in registration memory at one time. The **C-8 (BANK)** and **C-9 (1)** to **C-12 (4)** buttons are used for selecting bank and area.

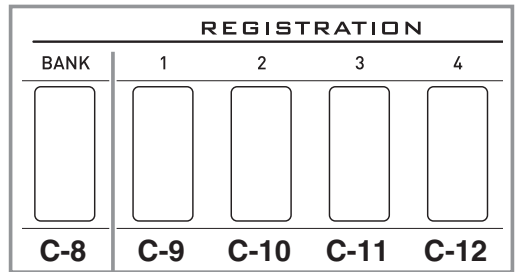

	Area 1	Area 2	Area 3	Area 4
Bank 1	Setup 1-1	Setup 1-2	Setup 1-3	Setup 1-4
Bank 2	Setup 2-1	Setup 2-2	Setup 2-3	Setup 2-4
⋮	⋮	⋮	⋮	⋮
Bank 8	Setup 8-1	Setup 8-2	Setup 8-3	Setup 8-4

- Each press of the **C-8 (BANK)** button cycles through the bank numbers, from 1 to 8.
- Pressing a button from **C-9 (1)** to **C-12 (4)** selects the corresponding area in the currently selected bank.

## Registration Save Example

This example saves the data shown in the table below to the following setups in Bank 1.

- Initial melody setup saved to Setup 1-1.
- Second melody setup saved to Setup 1-2.
- Third melody setup saved to Setup 1-3.

	Setup 1-1	Setup 1-2	Setup 1-3
Tone Number	E:016	H:001	A:001
Rhythm Number	A:015	E:013	A:044
Tempo	080	140	089



## To save a setup to registration memory

1. Configure the tone, rhythm, and other settings you want to include in the setup.
2. Press the C-8 (BANK) button to select the bank you want.
  - Each press of the C-8 (BANK) button cycles through the bank numbers.

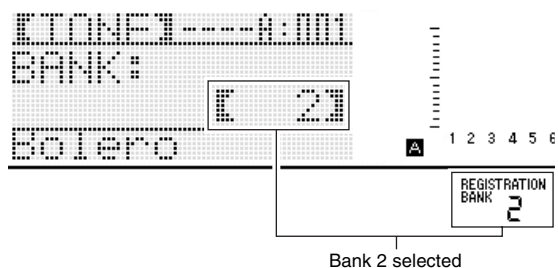

- While the “BANK” screen is displayed after pressing the C-8 (BANK) button, use the dial or R-14 (–, +) buttons to select the bank you want.
  - If you do not perform any operation for a few seconds, the display will return to previous screen automatically.
3. While holding down the C-13 (STORE) button, press a button from C-9 (1) to C-12 (4) to select an area.
    - This will save the settings you configured in step 1 into the applicable setup.
    - If there is anything already stored in the setup, it will be replaced (deleted) with the new setup.



### IMPORTANT!

- The message “Please Wait” will remain on the display while a data save operation is in progress. Do not perform any other operation while it is displayed. Turning off the Digital Keyboard or removing the memory card can cause Digital Keyboard data to be deleted or become corrupted. It also can cause the Digital Keyboard to fail to turn on when the L-1 (POWER) button is pressed. If this happens, refer to “Troubleshooting” (page E-114).

## To recall a setup from registration memory

1. Press the C-8 (BANK) button to select the bank that contains the setup you want to recall.
2. Use buttons C-9 (1) to C-12 (4) to select the area that contains the setup you want to recall.
  - This will recall the registration memory setup and automatically configure the Digital Keyboard settings accordingly.

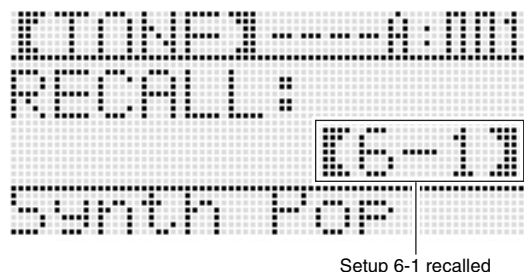

### NOTE

- Notes currently being sounded by the keyboard may stop if you recall a setup that causes a change in octave shift (page E-18). To keep this from happening, either select a setup that does not cause a change in the octave shift setting, or hold down the pedal (which will cause notes currently being played to be sustained).

# Using the Song Sequencer

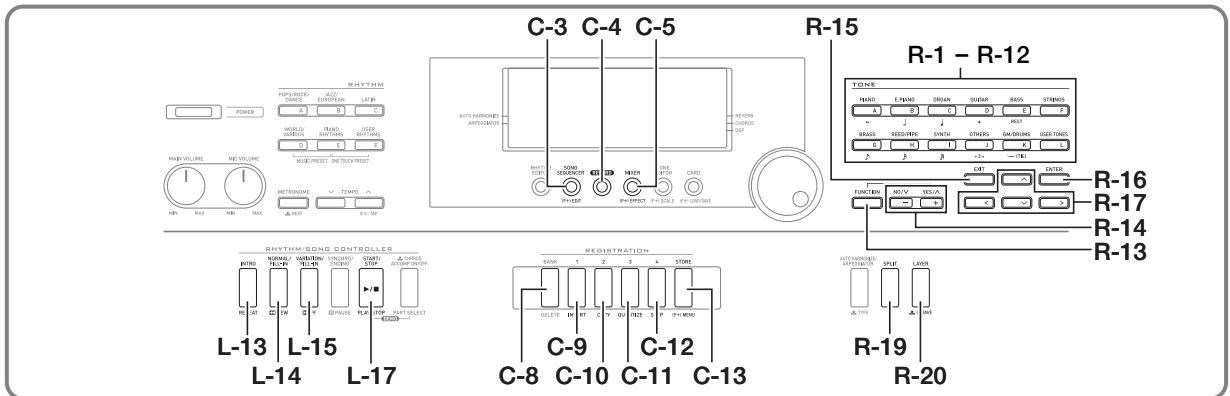

You can use the song sequencer to record keyboard play (including Auto Accompaniment), or to record individual parts (multi-track recording) and combine them into a final song. After recording data, you can edit each individual note (event). You can have up to five recorded songs (approximately 12,000 notes total) stored in memory at the same time.

## IMPORTANT!

- The message “Please Wait” will remain on the display while a data save operation is in progress. Do not perform any other operation while it is displayed. Turning off the Digital Keyboard or removing the memory card can cause Digital Keyboard data to be deleted or become corrupted. It also can cause the Digital Keyboard to fail to turn on when the L-1 (POWER) button is pressed. If this happens, refer to “Troubleshooting” (page E-114).

## Starting One-touch Recording (EASY REC)

EASY REC lets you start recording of keyboard play with a single button operation.

### NOTE

- EASY REC is a function of the song sequencer. For details on using the song sequencer, see “What you can do with the song sequencer” (page E-66).
- EASY REC can be used to record keyboard play that uses a music preset (page E-50). For details, see “To use EASY REC to record a performance using a music preset” (page E-66).

## To use EASY REC to record

### 1. Configure Digital Keyboard settings for your performance.

- Configure the following settings: tone and rhythm selection, tempo, layer and split, synchro standby (when using Auto Accompaniment), mixer, etc. For details about settings that can be configured, see “Recording Start” under “System Track and Track 01 through 16 Common Recording Content” (page E-67) and “System Track Recording Content” (page E-67).
- Performing step 2 below enters record standby. After that, recording will start whenever you play something on the keyboard. After step 2, take care that you do not accidentally press a keyboard key and unintentionally start recording.

## 2. Press the C-4 (RECORD) button.



- The button will start flashing and the EASY REC screen shown below will appear on the display.

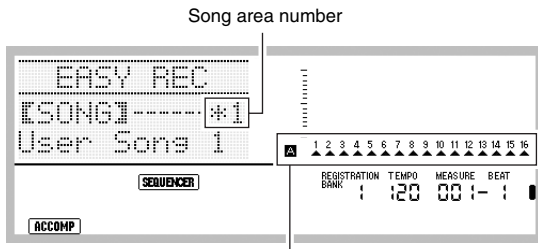

Arrows (▲) will indicate all the parts in Group A. This indicates the Digital Keyboard is currently in system track (page E-66) record standby.

- An asterisk (\*) next to a song area number indicates that there is already data recorded in that area. Selecting a song area that already contains recorded data and starting a new recording will cause the existing system track data to be deleted.

## 3. Perform the following steps to configure beat and other settings.

- While holding down the R-13 (FUNCTION) button, press the C-13 (MENU) button. This will display a menu like the one shown below, with the ● next to "Beat" (beat).



- Use the dial or R-14 (–, +) buttons to configure the beat setting. You can specify a beat setting of 2/4 to 8/4, 2/8 to 16/8.
- Use the R-17 (▼) button to move the ● to "Metronome" and then use the R-14 (–, +) buttons to turn the metronome on or off. Turning on the metronome causes it to sound a count during recording, but not during playback.

- Use the R-17 (▼) button to move the ● to "Precount" and then use the R-14 (–, +) buttons to turn the precount on or off. Turning on the precount inserts a one-measure count before the start of recording when you press the L-17 (START/STOP) button in step 4.
- Press the R-15 (EXIT) button to exit the menu.

## 4. Start playing something on the keyboard.

- Recording starts automatically when you perform any one of the following operations.
  - Playing on the keyboard
  - Pressing the L-13 (INTRO), L-14 (NORMAL/FILL-IN), or L-15 (VARIATION/FILL-IN) button
  - Pressing the L-17 (START/STOP) button. To input one or more rests before starting recording, press the L-17 (START/STOP) button to start recording, and then start keyboard play at the point you want.
- Starting recording will cause the C-4 (RECORD) button to change from flashing to lit. During recording, the display will show the current measure (MEASURE) and beat (BEAT).
- PITCH BEND wheel (S-1) and pedal operations are also recorded.
- When recording reaches a point where there is less than 100 notes of remaining memory capacity, the current measure (MEASURE) and beat (BEAT) values will start flashing.

## 5. To stop recording, press the L-17 (START/STOP) button.

- After recording stops, the initial song sequencer mode screen appears on the display.

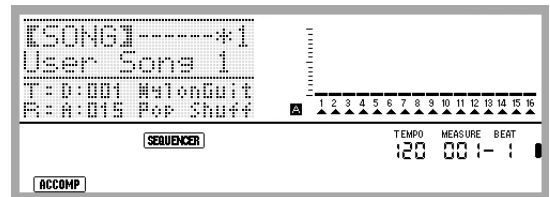

- At this time you can press the L-17 (START/STOP) button to replay what you have just recorded. For details about playing back recorded content, see "Playing a Recorded Song" (page E-73).

## 6. To exit the song sequencer, press the C-3 (SONG SEQUENCER) button or the R-15 (EXIT) button.

## To use EASY REC to record a performance using a music preset

**1. Perform steps 1 through 4 under “To perform using a music preset” (page E-50).**

**2. Press the C-4 (RECORD) button.**



- The button will start flashing and the EASY REC screen will appear on the display.

**3. Start to play something using a music preset. For details, see “To perform using a music preset” (page E-50).**

- This will start recording, along with Auto Accompaniment in accordance with the preset chord progression.
- Starting recording will cause the **C-4 (RECORD)** button to change from flashing to lit. During recording, the display will show the current measure (MEASURE) and beat (BEAT).

**4. To stop recording, press the L-17 (START/STOP) button.**

- After recording stops, the initial song sequencer mode screen appears on the display.
- At this time you can press the **L-17 (START/STOP)** button to replay what you have just recorded. For details about playing back recorded content, see “Playing a Recorded Song” (page E-73).

**5. To exit the song sequencer, press the C-3 (SONG SEQUENCER) button or the R-15 (EXIT) button.**

## What you can do with the song sequencer

The simplest use of the song sequencer is to record a performance as you play it. For details, see “To use EASY REC to record” (page E-64). Virtually everything you play on the keyboard can be recorded by the song sequencer. You also can use the song sequencer to perform multi-track recording of 17 different tracks and assemble them into a final song. For example, you can first record a piano track, followed by a bass track, then a guitar track or tracks that feature other musical instruments.

### Songs, tracks, and parts

A single song can be made up of up to 17 tracks. The 17 tracks are broken down as shown in the table below.

	Track	Part Number	Part Contents	
Song	System Track	A04	Auto Accompaniment (Auto harmonize tone)	
		A05	Keyboard (UPPER 1 part)	
		A06	Keyboard (UPPER 2 part)	
		A07	Keyboard (LOWER part)	
		A09	Auto Accompaniment (Percussion part)	
		A10	Auto Accompaniment (Drums part)	
		A11	Auto Accompaniment (Bass part)	
		A12	Auto Accompaniment (Chord 1 part)	
		A13	Auto Accompaniment (Chord 2 part)	
		A14	Auto Accompaniment (Chord 3 part)	
		A15	Auto Accompaniment (Chord 4 part)	
		A16	Auto Accompaniment (Chord 5 part)	
		Track 01	B01	Keyboard (B01 part)
		Track 16	B16	Keyboard (B16 part)

- The Digital Keyboard uses multiple parts simultaneously to sound Auto Accompaniment, a keyboard layer tone, and keyboard split tone at the same time. The system track is used to record the notes of these parts in a single location.
- Tracks 01 through 16 each correspond to a single musical instrument part. Each track is used to record the notes of each individual part.
- The parts shown in the table above correspond to mixer parts. For details, see “Using the Mixer” (page E-39).
- Part B10 is a drum sound only part.

## System Track and Track 01 through 16 Common Recording Content

### ■ Recording Start

- Note settings
- Rhythm selection
- Tempo setting
- Scale setting
- The mixer settings below
  - All part parameters from A04 through A07 and B01 through B16 (Excluding part on/off)
  - Part parameters from A09 through A16: part on/off, coarse tune, fine tune, scale enable, DSP line
  - DSP parameters: volume, pan, reverb send
- Effect settings
- Accomp volume

### ■ During Recording

- Keyboard play
- Pitch bender operations
- Pedal operations

## System Track Recording Content

### ■ Recording Start

- Tones for the UPPER 1, UPPER 2, and LOWER parts
- Layer and split on/off
- Split point setting
- Octave shift for the UPPER 1, UPPER 2, and LOWER parts
- The function menu item settings below (page E-97)
  - Arpeggiator hold, arpeggiator speed, arpeggiator part
- Auto harmonize or arpeggiator on/off and type
- Synchro standby (Normal, Variation, Intro)
- Music preset (Only when using EASY REC.)

### ■ During Recording

- Rhythm selection
- Tempo setting
- All of the items under “Recording Start” above, except for the function menu item settings and split point setting
- Chord play using the chord keyboard
- The rhythm controller operations below
  - L-13 (INTRO), L-14 (NORMAL/FILL-IN), L-15 (VARIATION/FILL-IN), and L-16 (SYNCHRO/ENDING)** button operations
- Settings recalled from registration memory
- Settings recalled using One Touch Preset

### NOTE

- Due to the way song parts are configured, settings configured by a recalled registration are applied to different numbered parts than they were assigned to when the setup was saved, as shown below.

Parts when registration setup is saved	Parts when registration is recalled for song recording
UPPER 1 part (A01)	UPPER 1 part (A05)
UPPER 2 part (A02)	UPPER 2 part (A06)
LOWER part (A03)	LOWER part (A07)
Auto Harmonize tone part (A04)	Auto Harmonize tone part (A04)

For details about the configuration of song parts, see “Songs, tracks, and parts” (page E-66).

- The moment you call up a registration setup or One Touch Preset while recording, the setting information registered with the registration setup or One Touch Preset is recorded to the system track. The registration setup or One Touch Preset itself is not recorded.

## Track 01 through 16 Recording Content

### ■ Recording Start

- Part tone selection for the track

### ■ During Recording

- Part tone selection for the track
- The mixer settings below
  - All part parameters from B01 through B16 (except part on/off)

## Panel Settings and Header Settings

Before starting recording with the song sequencer, you need to select the tone and rhythm, and also configure other settings such as tempo, mixer settings, etc. These are called “panel settings” because they are configured using the Digital Keyboard’s control panel. When you start recording, panel settings are stored in the header of the song. Settings in the header of a song are called “header settings”.

- The “Recording Start” settings under “System Track and Track 01 through 16 Common Recording Content” (page E-67), “System Track Recording Content” (page E-67) and “Track 01 through 16 Recording Content” (page E-67) are stored as header settings.
- Only header settings can be changed after song recording is complete. For details, see “Using Panel Record to Rewrite Song Header Settings” (page E-72).

## Recording Individual Tracks

This section explains how to record to the system track and how to record to Tracks 01 through 16. For details about track configuration and what is recorded to each track, see “What you can do with the song sequencer” (page E-66).

### To record a performance to the system track

#### 1. Press the C-3 (SONG SEQUENCER) button to enter the song sequencer mode.

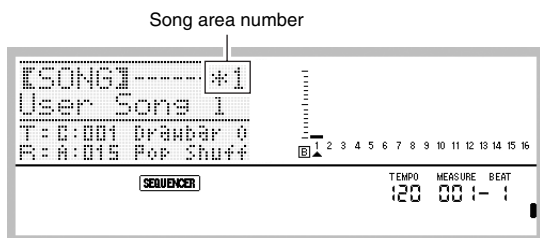
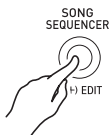

- An asterisk (\*) next to a song area number indicates that there is already data recorded in that area.
- **A** in the level meter indicates that the system track is currently selected, while **B** indicates that another track (01 through 16) is selected. In the case of **B**, a pointer (**A**) indicates which track is selected.
- A black box (■) in the level meter above a track number indicates that there is already data recorded in that track.

#### 2. Use the dial or R-14 (-, +) buttons to select a song area number.

- Selecting a song area that already contains recorded data will immediately recall the header settings of the song (page E-67).

#### 3. Press the C-4 (RECORD) button.



- The button will start to flash and the Digital Keyboard will enter record standby, which means recording will start whenever you play something on the keyboard. Up to step 7, take care that you do not accidentally press a keyboard key and unintentionally start recording.

#### 4. Use the R-17 (<, >) buttons to select the system track.

- If the system track already contains recorded data, starting recording in step 7 below will cause the current system track data to be deleted.

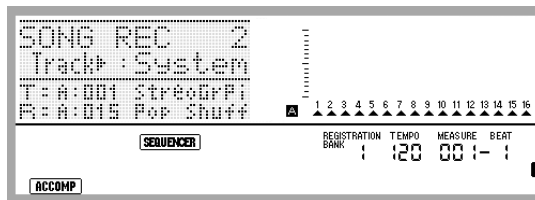

#### 5. Configure panel settings as required for your performance.

- Configure the following settings: tone and rhythm selection, tempo, layer and split, synchro standby (when using Auto Accompaniment), mixer, etc. For details about settings that can be configured, see “Recording Start” under “System Track and Track 01 through 16 Common Recording Content” (page E-67) and “System Track Recording Content” (page E-67). For information about mixer settings, see “Mixer Settings in the Song Sequencer Mode” (page E-72).

#### 6. Perform the following steps to configure beat and other settings.

- (1) While holding down the R-13 (FUNCTION) button, press the C-13 (MENU) button. This will display a menu like the one shown below, with the ● next to “Beat” (beat).



- (2) Use the dial or R-14 (-, +) buttons to configure the beat setting. You can specify a beat setting of 2/4 to 8/4, 2/8 to 16/8.
- (3) Use the R-17 (V) button to move the ● to “Metronome” and then use the R-14 (-, +) buttons to turn the metronome on or off. Turning on the metronome causes it to sound a count during recording, but not during playback.
- (4) Use the R-17 (V) button to move the ● to “Precount” and then use the R-14 (-, +) buttons to turn the precount on or off. Turning on the precount inserts a one-measure count before the start of recording when you press the L-17 (START/STOP) button in step 7.
- (5) Press the R-15 (EXIT) button to exit the menu.

#### NOTE

- Page 2 of the menu screen has a “RecType” setting, but this setting cannot be used when recording a performance to the system track.

## 7. Start playing something on the keyboard.

- Recording starts automatically when you perform any one of the following operations.
  - Playing on the keyboard
  - Pressing the **L-13 (INTRO)**, **L-14 (NORMAL/FILL-IN)**, or **L-15 (VARIATION/FILL-IN)** button
  - Pressing the **L-17 (START/STOP)** button. To input one or more rests before starting recording, press the **L-17 (START/STOP)** button to start recording, and then start keyboard play at the point you want.
- Starting recording will cause the **C-4 (RECORD)** button to change from flashing to lit. During recording, the display will show the current measure (MEASURE) and beat (BEAT).
- PITCH BEND** wheel (**S-1**) and pedal operations are also recorded.
- When recording reaches a point where there is less than 100 notes of remaining memory capacity, the current measure (MEASURE) and beat (BEAT) values will start flashing.

## 8. To stop recording, press the L-17 (START/STOP) button.

- At this time you can press the **L-17 (START/STOP)** button to replay what you have just recorded. For details about playing back recorded content, see "Playing a Recorded Song" (page E-73).

## 9. To exit the song sequencer, press the C-3 (SONG SEQUENCER) button or the R-15 (EXIT) button.

## To record to Tracks 01 through 16

### 1. Press the C-3 (SONG SEQUENCER) button to enter the song sequencer mode.

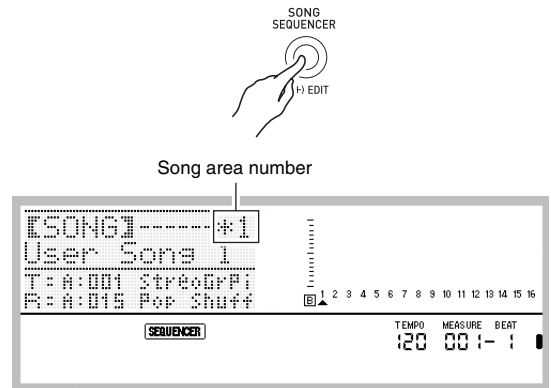

- An asterisk (\*) next to a song area number indicates that there is already data recorded in that area.
- A** in the level meter indicates that the system track is currently selected, while **B** indicates that another track (01 through 16) is selected. In the case of **B**, which track is selected is indicated by the position of a pointer (**A**).
- A black box (■) in the level meter above a track number indicates that there is already data recorded in that track.

### 2. Use the dial or R-14 (-, +) buttons to select a song area number.

- Selecting a song area that already contains recorded data will immediately recall the header settings of the song (page E-67).

### 3. Press the C-4 (RECORD) button.



- The button will start to flash and the Digital Keyboard will enter record standby, which means recording will start whenever you play something on the keyboard. Up to step 7, take care that you do not accidentally press a keyboard key and unintentionally start recording.



**4. Use the R-17 (<, >) buttons to select a track (Track 01 through Track 16).**

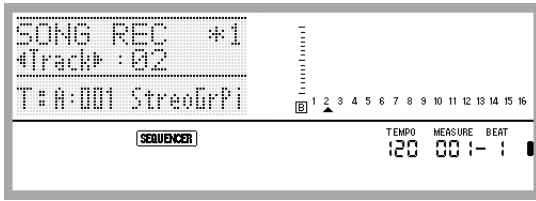

**5. Configure panel settings as required for your performance.**

- Configure the following settings: tone selection, tempo, mixer settings, etc. For details about settings that can be configured, see “Recording Start” under “System Track and Track 01 through 16 Common Recording Content” (page E-67) and “Track 01 through 16 Recording Content” (page E-67). For information about mixer settings, see “Mixer Settings in the Song Sequencer Mode” (page E-72).

**6. Perform the following steps to configure beat and other settings.**

- (1) While holding down the R-13 (FUNCTION) button, press the C-13 (MENU) button. This will display a menu like the one shown below, with the ● next to “Beat” (beat).



- (2) Use the dial or R-14 (-, +) buttons to configure the beat setting. You can specify a beat setting of 2/4 to 8/4, 2/8 to 16/8.
- (3) Use the R-17 (V) button to move the ● to “Metronome” and then use the R-14 (-, +) buttons to turn the metronome on or off. Turning on the metronome causes it to count a count during recording, but not during playback.
- (4) Use the R-17 (V) button to move the ● to “Precount” and then use the R-14 (-, +) buttons to turn the precount on or off. Turning on the precount inserts a one-measure count before the start of recording when you press the L-17 (START/STOP) button in step 7.

- (5) Use the R-17 (V) button to move the ● to “RecType”, and then use the R-14 (-, +) buttons to select “REPL” or “OVDB”.

When you want to perform this type of recording:	Select this RecType option:
Delete any data currently existing in the track being recorded to and start a new recording.	REPL (Replace)
Overdub any data currently existing in the track being recorded to with the new recording.	OVDB (Overdub)

- (6) Press the R-15 (EXIT) button to exit the menu.

**7. Start playing something on the keyboard.**

- This will start recording and cause the C-4 (RECORD) button to change from flashing to lit. During recording, the display will show the current measure (MEASURE) and beat (BEAT).
- To input one or more rests before starting recording, press the L-17 (START/STOP) button to start recording, and then start keyboard play at the point you want.
- PITCH BEND wheel (S-1) and pedal operations are also recorded.
- When recording reaches a point where there is less than 100 notes of remaining memory capacity, the current measure (MEASURE) and beat (BEAT) values will start flashing.

**8. To stop recording, press the L-17 (START/STOP) button.**

- At this time you can press the L-17 (START/STOP) button to replay what you have just recorded. For details about playing back recorded content, see “Playing a Recorded Song” (page E-73).

**9. To exit the song sequencer, press the C-3 (SONG SEQUENCER) button or the R-15 (EXIT) button.**



### To clear the content of a single track immediately after recording it

**1. While the song sequencer mode initial screen is on the display after track recording is complete, hold down the R-13 (FUNCTION) button as you press the C-13 (MENU) button.**

- This displays the song sequencer menu with the ● located at “ClearTrack”.

```

-5. SEQ Menu-
# ClearTrack  >Ent
# ClearSongs  >Ent
# PanelRecord >Ent
  
```

**2. Press the R-16 (ENTER) button.**

- This causes the “Clear Track” screen to appear. At this time the target track for the clear operation is the one you just recorded.

**3. Press the R-16 (ENTER) button.**

- This will cause the confirmation message “Sure?” to appear.

**4. Press the R-14 (YES) button to clear the track data or the R-14 (NO) button to cancel.**

#### NOTE

- For information on how to select a particular track and clear its content, see “To clear a single track” (page E-79).

### To clear a single song immediately after recording it

**1. While the song sequencer mode initial screen is on the display after track recording is complete, hold down the R-13 (FUNCTION) button as you press the C-13 (MENU) button.**

- This displays the song sequencer menu.

**2. Use the R-17 (∧, ∨) button to move the ● to “ClearSong” and then press the R-16 (ENTER) button.**

- This causes the “Clear Song” screen to appear. At this time the target song for the clear operation is the one you just recorded.

**3. Press the R-16 (ENTER) button.**

- This will cause the confirmation message “Sure?” to appear.

**4. Press the R-14 (YES) button to clear the track data or the R-14 (NO) button to cancel.**

#### NOTE

- For information on how to select a particular song and clear its content, see “To clear a song” (page E-76).

## Mixer Settings in the Song Sequencer Mode

You can access the mixer during playback, playback standby, or record standby (**C-4 (RECORD)** button flashing), or while recording is in progress (**C-4 (RECORD)** button lit). Press the **C-5 (MIXER)** button to display the mixer screen. To return to the song sequencer mode screen, press the **C-5 (MIXER)** button again or press the **R-15 (EXIT)** button.

The table below shows how mixer parts correspond to song sequencer parts.

Mixer	Song Sequencer
Parts A04 to A07, A09 to A16	System Track
Parts B01 to B16	Tracks 01 through 16

### Supported Mixer Operations during Playback or Playback Standby

All mixer settings can be configured during playback or playback standby, subject to the following precautions.

- If you want to change mixer settings during playback standby, change them after selecting the song you want to play back. If you change mixer settings and then change the song selection, the header settings of the newly selected song will be recalled and mixer settings will be changed accordingly.
- The only mixer settings you can change during playback standby are those that are included in the song header of the currently selected song. If mixer settings were changed part way through when recording the song, the later recorded mixer settings will supersede any settings you make during playback standby.

### Supported Mixer Operations during Record Standby

The mixer settings for the parts shown below (excluding part on/off) are supported, depending on the track being recorded to. Settings are recorded to the header settings (page E-67), the same way settings are stored when recording is started.

System Track	Tracks 01 through 16
A05 (UPPER 1), A06 (UPPER 2), A07 (LOWER), A04 (Auto harmonize) parts	Parts corresponding to each track (B01 through B16)

### Supported Mixer Operations During Recording

Mixer settings cannot be configured during recording to the system track.

Configuration of mixer settings (except for part on/off) is supported for a part (B01 through B16) that corresponds to a track when recording to any track from 01 through 16 shown. Any change in a mixer setting on the mixer screen is recorded as soon as it is made.

For details about mixer functions and operations, see “Using the Mixer” (page E-39).

## Using Panel Record to Rewrite Song Header Settings

The header of each song contains “header settings”, which are settings that were in effect on the Digital Keyboard when recording was performed. You can use a “panel record” operation to rewrite a song’s header settings with the Digital Keyboard’s current setup.

The following items are header settings that can be rewritten using the panel record operation.

- Rhythm selection
- Tempo setting
- Scale setting
- The mixer settings below
  - All part parameters from A04 through A07 and B01 through B16 (Excluding part on/off)
  - Part parameters from A09 through A16: part on/off, coarse tune, fine tune, scale enable, DSP line
  - DSP parameters: volume, pan, reverb send
- Effect settings
- Accomp volume
- UPPER 1 part tone, UPPER 2 part tone, and LOWER part tone selections

### To perform a panel record operation

1. Press the **C-3 (SONG SEQUENCER)** button to enter the song sequencer mode.

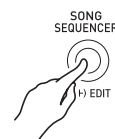

2. Use the dial or **R-14 (-, +)** buttons to select a song area number.

3. Configure panel settings so they reflect the settings you want to write as the header settings.

- You can configure the following settings: mixer settings, tempo, system track rhythm, track tone selection, etc.
- To change the system track UPPER 1, UPPER 2, and LOWER part tones or mixer settings, use the mixer to change the settings of parts A05 (UPPER 1), A06 (UPPER 2), and A07 (LOWER).

4. After all of the panels settings are the way you want, hold the **R-13 (FUNCTION)** button as you press the **C-13 (MENU)** button.

- This displays the song sequencer menu.

5. Use the R-17 (V) button to move the ● to “PanelRecord”.

```

-5. SEQ Menu-
- ClearTrack >Ent
- ClearSongs >Ent
# PanelRecord >Ent
  
```

6. Press the R-16 (ENTER) button.

7. In response to the “Sure?” message that appears, press the R-14 (YES) button to execute the panel record operation or the R-14 (NO) button to cancel.

## Playing a Recorded Song

This section explains how to perform the following operations on songs recorded in the song sequencer mode.

- Play a song.
- Fast forward, fast backward, pause, unpause.
- Play a specific part in a song.
- Repeat play a specific section of a song.
- Assign a name to a song.
- Delete a song.

### To play a recorded song

1. Press the C-3 (SONG SEQUENCER) button to enter the song sequencer mode.

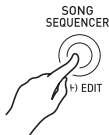

2. Use the dial or R-14 (–, +) buttons to select a song area number.

3. Configure mixer settings, tempo, and other panel settings you want to use for playback.

- To change the system track UPPER 1, UPPER 2, and LOWER part tones or mixer settings, use the mixer to change the settings of parts A05 (UPPER 1), A06 (UPPER 2), and A07 (LOWER).
- The above settings are not required if you want to play the song as it was recorded.

4. Press the L-17 (START/STOP) button.

- This starts playback. The following operations are supported during playback.

To do this:	Do this:
Skip Forward	Hold down the L-15 (▶▶FF) button.
Skip Back	Hold down the L-14 (◀◀REW) button.
Pause	Press the L-16 (PAUSE) button.
Restart paused playback	Press the L-16 (PAUSE) button.
Perform repeat playback	Perform steps 4 through 6 under “To repeat play a specific section of a song” (page E-110).

- Even while playback is paused, you can still perform fast forward playback by holding down the L-15 (▶▶FF) button or fast backward playback by holding down the L-14 (◀◀REW). Releasing either button goes back into pause.
- While playback is in progress or playback standby, you can use the R-17 (<, >) buttons to select the track you want. Playing keyboard keys sounds the parts that correspond to the currently selected track (A04 to A07 for the system track).
- Playback stops automatically when it reaches the end of a song. To stop playback part way through, press the L-17 (START/STOP) button.

### To play back a particular part alone

1. Press the C-3 (SONG SEQUENCER) button to enter the song sequencer mode.
2. Use the dial or R-14 (–, +) buttons to select a song area number.
3. Press the C-5 (MIXER) button to display the mixer screen.
4. Use the R-17 (<, >) buttons to select the part you want to play (A04 through A16, B01 through B16).
  - For example, to play only the melody that was recorded using the UPPER 1 part and recorded into the system track, select Part A05. For details about the content of each part, see “How Parts are Organized” (page E-39).
5. Use the R-17 (∧, ∨) buttons to move the thick brackets ([ ]) to “Part”.



6. Press the R-14 (–, +) buttons at the same time.
  - This causes the setting to change to “Sol” (Solo).
7. Press the L-17 (START/STOP) button.
  - This starts playback only of the part you selected in step 4.
  - Playback stops automatically when it reaches the end of a song. To stop playback part way through, press the L-17 (START/STOP) button.

### To repeat play a specific phrase

1. Hold down the R-13 (REPEAT) button until the locator screen shown below appears on the display.

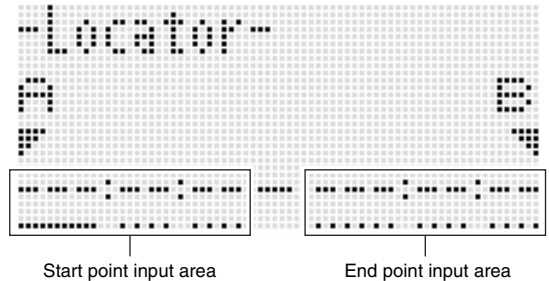

2. Specify a measure as the start point of the phrase to be repeat played.
  - (1) Press the R-14 (+) button.
 

This will input “001:01:00” into the start point input area (A), and cause the cursor to start to flash.
  - (2) Use the dial or R-14 (–, +) buttons to specify the start measure number.
3. Specify a measure as the end point of the phrase to be repeat played.
  - (1) Press the R-17 (>) three times to move the cursor to the end point input area.
 

Press the R-14 (+) button.

The end point input area (B) initially shows the measure that is one measure after the start point.
  - (2) Use the dial or R-14 (–, +) buttons to specify the end measure number.
4. Press the R-16 (ENTER) button.
  - This causes the cursor to stop flashing.
5. Press the R-15 (EXIT) button to exit the locator screen.
6. Perform the following steps to start phrase repeat play.
  - (1) Press the L-13 (REPEAT) button.
 

This causes the **REPEAT** indicator to appear on the display.
  - (2) Press the L-17 (START/STOP) button.
 

The specified phrase plays back in a loop.

## 7. To stop playback, press the L-17 (START/STOP) button.

### NOTE

- Pressing the R-15 (EXIT) button without pressing the R-16 (ENTER) button in step 4 above will cancel the phrase setting operation and close the locator screen.
  - The start point and end point specified on the locator screen by the above operation will be displayed as the initial default values when you display the screen of editing the next event.
    - “To delete all events in a specific range of a track” (page E-87)
    - “To copy the events within a specific range to a desired location” (page E-88)
    - “To quantize all note events within specific range of a track” (page E-90)
    - “To delete all pitch bender events within a specific range of a track” (page E-91)
- This lets you repeat play and check the phrase so you can perform the above operation to edit it.

## Editing a Song

The following operations are supported during song editing.

- Deleting a specific song or all songs
- Copying a song from one area to another
- Deleting specific measures from a song
- Inserting blank measures into a song
- Extracting system track recorded content to track 04 through 07 or 09 through 16
- Renaming songs

### To start a song editor operation

- Press the C-3 (SONG SEQUENCER) button to enter the song sequencer mode.
- While holding down the R-13 (FUNCTION) button, press the C-3 (EDIT) button to display the editor menu.

```

-EDIT-
#EventEdit    >Ent
#TrackEdit    >Ent
#SongEdit     >Ent
  
```

- Use the R-17 (V) button to move the ● to “Song Edit” and then press the R-16 (ENTER) button.

- This displays the song editor menu shown below.

```

-Song EDIT-    1/2
#Clear         >Ent
#Copy         >Ent
#DeleteMeas.  >Ent
  
```

### To clear a song

1. Perform the procedure under “To start a song editor operation” on page E-75 to display the song editor menu, with the ● located at “Clear”.
2. Press the R-16 (ENTER) button.
  - This displays the “Clear Song” screen.
3. Use the dial or R-14 (–, +) buttons to specify the song area number you want to clear.
  - An asterisk (\*) next to a song area number indicates that there is already data recorded in that area.



- You can select “All” here to clear all songs.

4. Press the R-16 (ENTER) button.
5. In response to the “Sure?” message that appears, press the R-14 (YES) button to clear or the R-14 (NO) button to cancel.

### To copy a song from one area to another

1. Perform the procedure under “To start a song editor operation” on page E-75 to display the song editor menu.
2. Use the R-17 (∧, ∨) button to move the ● to “Copy” and then press the R-16 (ENTER) button.
  - This displays the “Copy Song” screen. At this time the thick brackets ([ ]) will be located at the “Copy” setting.
3. Use the dial or R-14 (–, +) buttons to specify the song area number you want to copy from.

4. Press the R-17 (∨) button to move the thick brackets ([ ]) to “To”.



- An asterisk (\*) next to a song area number indicates that there is already data recorded in that area.

5. Use the dial or R-14 (–, +) buttons to specify the song area number you want to copy to.

6. Press the R-16 (ENTER) button.
  - If the copy destination song area does not contain recorded data, the copy operation is performed immediately.
  - If the copy destination song area already contains recorded data, The confirmation message shown below appears asking if you want to overwrite the existing data.



Press the R-14 (YES) button to perform the copy operation and overwrite the existing song or the R-14 (NO) button to cancel.

**To delete a specific measure from a song**

1. Perform the procedure under “To start a song editor operation” on page E-75 to display the song editor menu.
2. Use the R-17 (Λ, V) button to move the ● to “DeleteMeas.” and then press the R-16 (ENTER) button.
  - This causes “Delete Measure” screen to appear. At this time the thick brackets ([ ]) will be located at the “Measure” setting.
3. Use the dial or R-14 (–, +) buttons to specify the song measure you want to delete.
4. Press the R-17 (V) button to move the thick brackets ([ ]) to “Size”.

```

Delete Measure
Measure [004]
Size [001]
...Press Enter
  
```

5. Use the dial or R-14 (–, +) buttons to specify the number of measures you want to delete.
6. After everything is the way you want, press the R-16 (ENTER) button.
7. In response to the “Sure?” message that appears, press the R-14 (YES) button to delete or the R-14 (NO) button to cancel.

**To insert blank measures into a song**

1. Perform the procedure under “To start a song editor operation” on page E-75 to display the song editor menu.
2. Use the R-17 (Λ, V) button to move the ● to “InsertMeas.” and then press the R-16 (ENTER) button.
  - This causes “Insert Measure” screen to appear. At this time the thick brackets ([ ]) will be located at the “Measure” setting.
3. Use the dial or R-14 (–, +) buttons to specify the song measure number from which you want the insert to start.
4. Press the R-17 (V) button to move the thick brackets ([ ]) to “Size”.
5. Use the dial or R-14 (–, +) buttons to specify the number of measures you want to insert.
  - For example, specifying 002 for “Measure” and 003 for “Size” will insert three blank measures in front of song measure 2.
6. After everything is the way you want, press the R-16 (ENTER) button.
7. In response to the “Sure?” message that appears, press the R-14 (YES) button to insert or the R-14 (NO) button to cancel.



### To extract system track recorded content to track 04 through 07 or 09 through 16

As explained in detail under “Songs, tracks, and parts” (page E-66), the system track is an individual track, while the keyboard play and Auto Accompaniment data are recorded individually to multiple parts (A04 through A07, A09 through A16). The data of these parts is extracted to Tracks 04 through 07 and 09 through 16, with one part corresponding individually to one track of data. This makes it easy to edit each accompaniment part individually.

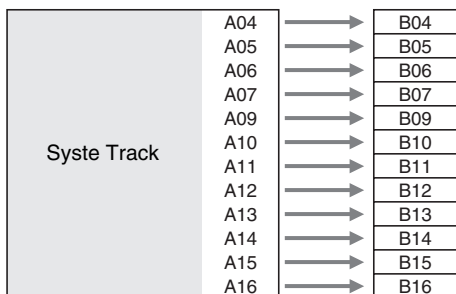

- In response to the “Sure?” message that appears, press the R-14 (YES) button to start extraction or the R-14 (NO) button to cancel.

### To rename a song

- Perform the procedure under “To start a song editor operation” on page E-75 to display the song editor menu.
- Use the R-17 (V) button to move the ● to “Rename” and then press the R-16 (ENTER) button.
  - This displays the “Rename” screen.



- Use the R-17 (<, >) buttons to move the cursor to the name character position you want to change, and then use the dial or R-14 (–, +) buttons to select the character you want.
  - See “Supported Input Characters” (page E-124) for information about the characters you can input for the name.
  - To input a space, press both of the R-14 (–, +) buttons at the same time.
- After everything is the way you want, press the R-16 (ENTER) button.
- In response to the “Sure?” message that appears, press the R-14 (YES) button to rename the song or the R-14 (NO) button to cancel.

### IMPORTANT!

- Performing this operation will delete all data currently recorded in the system track except for tempo data.
- Performing this operation deletes all data currently recorded in Tracks 04 through 07 and 09 through 16, and overwrites it with the data in the system track.

- Perform the procedure under “To start a song editor operation” on page E-75 to display the song editor menu.
- Use the R-17 (∧, V) button to move the ● to “Extract” and then press the R-16 (ENTER) button.
  - This displays an “Extract” screen like the one shown below.



- Press the R-16 (ENTER) button.



## Editing a Track

The following operations are supported during track (system track, Tracks 01 through 16) editing.

- Clearing a single track
- Copying one track to another track (Tracks 01 through 16 only)
- Combining two tracks into a single track (Tracks 01 through 16 only)

### To start a track editor operation

1. Press the C-3 (SONG SEQUENCER) button to enter the song sequencer mode.
2. While holding down the R-13 (FUNCTION) button, press the C-3 (EDIT) button to display the editor menu.
3. Use the R-17 (∧, ∨) button to move the ● to “TrackEdit” and then press the R-16 (ENTER) button.
  - This displays the track editor menu shown below.

```

-Track EDIT-
#Clear      >Ent
- Copy     >Ent
- Merge    >Ent
  
```

### To clear a single track

1. Perform the procedure under “To start a track editor operation” on page E-79 to display the track editor menu.
2. Press the R-16 (ENTER) button.
  - This causes the “Clear Track” screen to appear.

```

-Clear Track-
  #Track#
  * 01
  ...Press Enter
  
```

3. Use the dial or R-17 (<, >) buttons to specify the track you want to clear.
  - A black box (■) above a track number in the level meter indicates that there is already data recorded in that track.
  - You also can select a track using the dial or R-14 (←, →) buttons.
4. Press the R-16 (ENTER) button.
5. In response to the “Sure?” message that appears, press the R-14 (YES) button to clear or the R-14 (NO) button to cancel.

**To copy one track to another track (Tracks 01 through 16 only)**

1. Perform the procedure under “To start a track editor operation” on page E-79 to display the track editor menu.
2. Use the R-17 (Λ, ∨) button to move the ● to “Copy” and then press the R-16 (ENTER) button.
  - This causes the “Copy Track” screen to appear. At this time the thick brackets ([ ]) will be located at the “Copy” setting.
3. Use the dial or R-14 (–, +) buttons to specify the track number you want to copy from.
4. Press the R-17 (∨) button to move the thick brackets ([ ]) to “To”.
  - An asterisk (\*) next to a track number indicates that there is already data recorded in that track.
5. Use the dial or R-14 (–, +) buttons to specify the track number you want to copy to.
6. After everything is the way you want, press the R-16 (ENTER) button.
  - If the copy destination track does not contain recorded data, the copy operation is performed immediately.
  - If the copy destination track already contains recorded data, the confirmation message shown below appears asking if you want to overwrite the existing data.



Press the R-14 (YES) button to perform the copy operation and overwrite the existing track or the R-14 (NO) button to cancel.

**To combine two tracks into a single track (Tracks 01 through 16 only)**

1. In the song sequencer mode, use the R-17 (<, >) buttons to select the lower numbered track of those you want to combine.
  - As an example, we will combine Track 03 and Track 05 into Track 06. Here, select Track 03.
2. Perform steps 2 and 3 of the procedure under “To start a track editor operation” on page E-79 to display the track editor menu.
3. Use the R-17 (∨) button to move the ● to “Merge” and then press the R-16 (ENTER) button.
  - This displays a “Merge Track” screen like the one shown below. At this time the thick brackets ([ ]) will be located at setting ②.

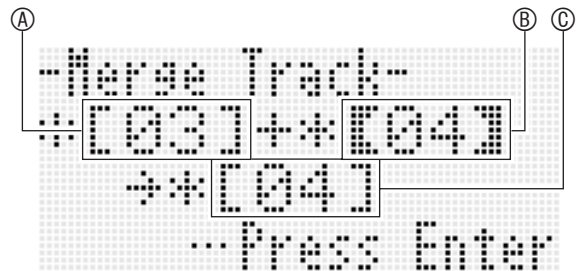

- Ⓐ: One of the tracks to be combined (The track you selected in step 1 is the initial default selection).
- Ⓑ: Other track to be combined.
- Ⓒ: Destination track of combined tracks.

4. Use the dial or R-14 (–, +) buttons to specify 05 (Track 05) for ②.
  - Changing the value of ② also causes the ③ value to change.
5. Press an R-17 (> or ∨) button to move the thick brackets ([ ]) to ③.
6. Use the dial or R-14 (–, +) buttons to specify 06 (Track 06) for ③.

## 7. After everything is the way you want, press the R-16 (ENTER) button.

- If the destination track does not contain recorded data, combination of the tracks starts immediately.
- If the destination track already contains recorded data, the confirmation message shown below appears asking if you want to overwrite the existing data.

```

-Merge Track-
DB exists,
Overwrite?
...Press No/Yes
  
```

Press the **R-14 (YES)** button to perform the process and overwrite the existing track or the **R-14 (NO)** button to cancel.

### NOTE

- Performing the above procedure does not clear the contents of the two source tracks. If you no longer need the content of a track, you can clear it using the procedure under “To clear a single track” (page E-79).

## Editing Events

The song sequencer records all Digital Keyboard operations you perform while playing as “events”, which are the smallest unit of data that makes up a song. Playing a single note on the keyboard, for example, stores the following events: note start measure, beat, and track, note pitch, note length, and note intensity.

The following operations are supported during event editing.

- Deleting events
- Inserting events
- Copying events within a specific range to a desired location
- Quantizing\* note events
- Deleting pitch bender events
- Adjusting note event velocity values
- Adjusting note event gate time values
- Selecting the type of events that appear on the Event Editor screen (View Select)
- Inserting or deleting beat events
- Directly inputting note events (step input)

\* Quantize is an operation that automatically adjusts the note-on timing of a note event to match a reference note.

## To start an event editor operation

1. Press the **C-3 (SONG SEQUENCER)** button to enter the song sequencer mode.
2. While holding down the **R-13 (FUNCTION)** button, press the **C-3 (EDIT)** button to display the editor menu.
3. Press the **R-16 (ENTER)** button.

- This displays the event editor screen shown below.

```

EVENT EDIT NOTE
-----
001:01:00 TOP
001:03:00 C4 01:00
001:03:19 Tone F:001
  
```

- For information about how to use the event editor screen, see “Event Types and Screen Content” (page E-82).

4. While holding down the **R-13 (FUNCTION)** button, press the **C-13 (MENU)** button.

- This displays the event editor menu shown below.

```

-E Edit Menu- 1/4
# Delete >Ent
# Insert >Ent
# Copy >Ent
  
```

- Next, select the menu item that corresponds to the type of operation you want to perform. Details about each operation are provided in the procedures of this section.

## Event Types and Screen Content

The event editor screen displays the individual events that make up a song as values and characters as shown in the sample screen below.

Event being edited (selected event) (Center of screen)

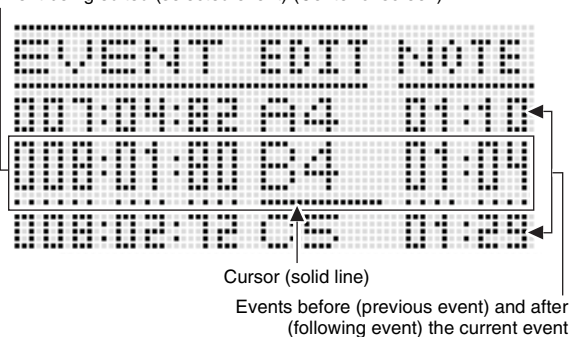

The event editor screen shows three events at one time. The event in the middle line is the selected event. You can change the value where the solid-line cursor is located. A broken line under a setting value indicates that the cursor can be moved to that value.

### Reading Event Data

Here we will use two types of event displays to explain how to read event data.

- Example 1: Note event

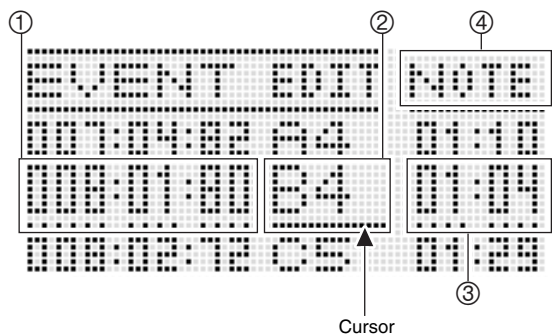

- Example 2: Pitch bender event

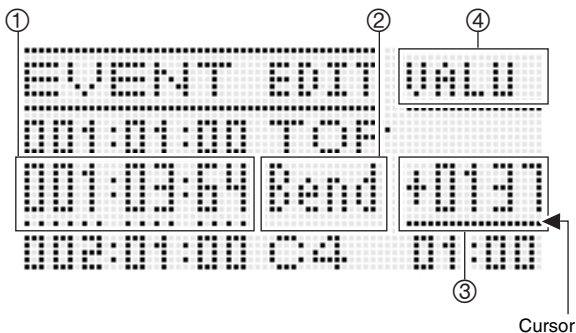

The following explains the meaning of each screen position.

Number	Description
①	For all event types, indicates the even location (timing) in the following format: measure:beat:tick. A "tick" is a time unit that is shorter than one beat. Song sequencer data uses 96 ticks per beat (for 2/4 to 8/4) or 48 ticks per beat (for 2/8 to 16/8).
②	For almost all events, this position shows an abbreviation indicating the event type. "Bend" in display example (2) stands for "pitch bender event". Note events (display example (1)) and chord events are different in that this position shows the event parameter (note name for a note event, root for a chord event) setting value. For information about what is displayed at this position and the corresponding event type, see the "Event Data List" (page E-83).
③	This position shows parameter setting values that corresponds to the event type. When an event has multiple parameters, use the R-17 (<, >) buttons to move the cursor, which will scroll the display between the parameters. The name of the parameter at the current cursor position will be displayed in position ④.
④	This position indicates where the cursor is currently located as "MEAS." (measure), "BEAT" (beat), or "TICK" (tick).

## ■ Event Data List

The following table shows the event types that correspond to the abbreviations that appear on the display, as well as the parameters of each event type and setting ranges.

- “② display” and “④ display” in the table headings correspond to the ②, ④ screen positions under “Reading Event Data” (page E-82).
- “② display during insert” in the table headings indicates the event type name enclosed in thick brackets (【 】) when step 3 of insert event procedure under “To insert an event” (page E-88).

### System Track and Track 01 to 16 Common Events

Event Type		② display during insert	④ display	Parameter Name	Setting Range
② display	Event Name				
TOP	(song start point)	–	–	–	(Not editable)
*1	Note	【Note】	NOTE	Note name	C- - C0 - G9*2
			GATE	Gate time	00:00 - 99:95
			VEL	Velocity	001 - 127
Bend	Pitch Bender	【Bend】	VALU	Pitch Bender	-8192 - 0000 - +8191
Mod	Modulation*3	【Modulat】	VALU	Modulation	000 - 127
Sus	Sustain Pedal	【Sustain】	VALU	Sustain Pedal	000 - 127
Soft	Soft Pedal	【Soft】	VALU	Soft Pedal	000 - 127
Sost	Sostenute Pedal	【Sostenu】	VALU	Sostenute Pedal	000 - 127
END	(song end point)	–	–	–	(Not editable)

\*1 A note event is not displayed as the event name at position ②, but rather as the note name (C4, etc.).

\*2 “C-” on the display indicates C-1 (one octave below C0).

\*3 This event can be added only with the operation under “To insert an event” (page E-88). It applies vibrato.

### Track 01 to 16 Events

Event Type		② display during insert	④ display	Parameter Name	Setting Range
② display	Event Name				
TONE	Part Tone	【Tone】	VALU	Tone Number	A:001 - L:010
Vol	Part Volume	【Volume】	VALU	Part Volume	000 - 127
Pan	Part Pan	【Pan】	VALU	Part Pan	-64 - 00- +63
CTun	Part Coarse Tune	【CrsTune】	VALU	Part Coarse Tune	-24 - 00 - +24
FTun	Part Fine Tune	【FinTune】	VALU	Part Fine Tune	-99 - 00 - +99
BndR	Part Bend Range	【BendRng】	VALU	Part Bend Range	00 - 24
RSnd	Part Reverb Send	【RevSend】	VALU	Part Reverb Send	000 - 127
CSnd	Part Chorus Send	【ChoSend】	VALU	Part Chorus Send	000 - 127
SciE	Part Scale Enable	【ScaleEn】	VALU	Part Scale Enable	on, oFF
DspL	Part DSP Line	【DspLine】	VALU	Part DSP Line	on, oFF
Exp	Expression*4	【Express】	VALU	Expression	000 - 127

\*4 This event can be added only with the operation under “To insert an event” (page E-88). It changes the volume.

■ System Track Events

Event Type		② display during insert	④ display	Parameter Name	Setting Range
② display	Event Name				
TnU1	UPPER 1 Tone	<b>[Tone_U1]</b>	VALU	Tone Number	A:001 - L:010
TnU2	UPPER 2 Tone	<b>[Tone_U2]</b>	VALU	Tone Number	A:001 - L:010
TnLo	LOWER Tone	<b>[Tone_Lo]</b>	VALU	Tone Number	A:001 - L:010
TnHm	Auto Harmonize Tone	<b>[Tone_Hm]</b>	VALU	Tone Number	A:001 - L:010
*1	Chord	<b>[Chord]</b>	ROOT	Root	C - B
			TYPE	Chord type	*2
			CVEL	Chord velocity	000 - 127
RHY	Rhythm	<b>[Rhythm]</b>	VALU	Rhythm Number	A:001 - F:010
Rctl	Rhythm Controller	<b>[RhyCtrl]</b>	VALU	Rhythm controller	*3
APrt	Accompaniment Part On/Off	<b>[AcmpPrt]</b>	PART	Part	PREC, DRUM, BASS, CHD1 - CHD5
			VALU	On/Off	on, oFF
Layr	Layer On/Off	<b>[Layer]</b>	VALU	Layer On/Off	on, oFF
Shft	Octave Shift	<b>[OctShft]</b>	PART	Part	UPP1, UPP2, LOWR
			VALU	Octave Shift	-2 - 0 - +2
Split	Split On/Off	<b>[Split]</b>	VALU	Split On/Off	on, oFF
TMPO	Tempo	<b>[Tempo]</b>	VALU	Tempo	30 - 255
SpIP	Split Point	<b>[SplitPt]</b>	VALU	Split Point	C - C0 - G9*4
HmAp	Auto Harmonize/Arpeggiator	<b>[HarmArp]</b>	VALU	Auto Harmonize/Arpeggiator	oFF, 001 - 162
ApHd	Arpeggiator Hold	<b>[ArpHold]</b>	VALU	Arpeggiator Hold	on, oFF
ApSp	Arpeggiator Speed	<b>[ArpSpd]</b>	VALU	Arpeggiator Speed	1, 2, 2S, 3, 4, 4S, 6, 8
ApPt	Arpeggiator Part	<b>[ArpPart]</b>	VALU	Arpeggiator Part	UPPER, LOWER
Revb	Reverb	<b>[Reverb]</b>	VALU	Reverb	oFF, 01 - 10
Chrs	Chorus	<b>[Chorus]</b>	VALU	Chorus	1 - 5
DSP	DSP	<b>[DSP]</b>	VALU	DSP	ton, 001 - 200
Scal	Scale	<b>[Scale]</b>	NOTE	Key	C - B
			Cent	Cent	-99 - 00 - +99
Vol	Part Volume	<b>[Volume]</b>	PART	Part	UPP1, UPP2, LOWR, HARM
			VALU	Part Volume	000 - 127
Pan	Part Pan	<b>[Pan]</b>	PART	Part	UPP1, UPP2, LOWR, HARM
			VALU	Part Pan	-64 - 00 - +63
CTun	Part Coarse Tune	<b>[CrsTune]</b>	PART	Part	UPP1, UPP2, LOWR, HARM
			VALU	Part Coarse Tune	-24 - 00 - +24
FTun	Part Fine Tune	<b>[FinTune]</b>	PART	Part	UPP1, UPP2, LOWR, HARM
			VALU	Part Fine Tune	-99 - 00 - +99
BndR	Part Bend Range	<b>[BendRng]</b>	PART	Part	UPP1, UPP2, LOWR, HARM
			VALU	Part Bend Range	00 - 24

Event Type		② display during insert	④ display	Parameter Name	Setting Range
② display	Event Name				
RSnd	Part Reverb Send	【RevSend】	PART	Part	UPP1, UPP2, LOWR, HARM
			VALU	Part Reverb Send	000 - 127
CSnd	Part Chorus Send	【ChoSend】	PART	Part	UPP1, UPP2, LOWR, HARM
			VALU	Part Chorus Send	000 - 127
DspL	Part DSP Line	【DspLine】	PART	Part	UPP1, UPP2, LOWR, HARM
			VALU	Part DSP Line	on, oFF
AVol	Accomp Volume* <sup>5</sup>	【AcmpVol】	VALU	Accomp volume	000 - 127
AScl	Accomp Scale* <sup>6</sup>	【AcmpScl】	VALU	Accomp Scale	on, oFF

\*1 A chord event is not displayed as the event name at position ♯, but rather as the chord root (C, etc.)

\*2 See “Fingering Guide” on (page E-124).

\*3 Intro: intro pattern, norml: normal pattern, Vari: variation pattern, nFIOon: normal fill-in on, nFIOF: normal fill-in off, vFIOon: variation fill-in on, vFIOF: variation fill-in off, Endin: ending pattern.

\*4 “C-” on the display indicates C-1 (one octave below C0).

\*5 This setting corresponds to the function menu “AccompVol.” item (page E-99).

\*6 For details, see “Specifying whether the Current Scale Settings Should be Applied to Auto Accompaniment (Accomp Scale)” (page E-22).

## To select a track for editing

1. Perform steps 1 to 3 of the procedure under “To start an event editor operation” on page E-81 to display the event editor screen.
2. While holding down the R-13 (FUNCTION) button, use the R-17 (<, >) buttons to select the track you want to edit.

## To play back a song from the event editor screen (Quick Play)

1. Perform steps 1 to 3 of the procedure under “To start an event editor operation” on page E-81 to display the event editor screen.
2. Press the L-17 (START/STOP) button.
  - This starts playback of the song being edited from the first measure where the cursor is currently located.
  - Playback stops automatically when it reaches the end of a song. To stop playback part way through, press the L-17 (START/STOP) button.

### To select the types of events that appear on the Event Editor screen (View Select)

1. Perform the procedure under “To start an event editor operation” on page E-81.
2. Use R-17 (>) button to display page three of the event editor menu, with the ● located at “ViewSelect”.
3. Press the R-16 (ENTER) button.
  - This displays the “View Select” screen.



4. Use the R-17 (∧, ∨) buttons to move the ● between the setting items, and the dial or R-14 (–, +) buttons to toggle the currently selected setting between “on” (shown) and “off” (hidden).
  - The table below shows the event that corresponds to each setting item.

Setting Item	Corresponding Event
Note	Note event
PitchBend	Pitch Bend event
Pedal	Sustain, soft, sostenute events
Rhythm	Rhythm event
Chord	Chord event
Tempo	Tempo event
Tone	Tone event
Mixer	Mixer event (excluding Tone event)
Others	All other events besides those above.

- For information about each event, see “Event Types and Screen Content” (page E-82).
5. Press the R-15 (EXIT) button to apply the settings and exit the “View Select” screen.

### To edit an existing event

1. Display the event editor screen of the track that includes the event you want to edit.
  - See “To select a track for editing” (page E-85).
2. Use the R-17 (∧, ∨) buttons to move the cursor to the event you want to edit.
3. Use the R-17 (<, >) buttons to move the cursor, and then use the dial or R-14 (–, +) buttons to change the value at the cursor position.
  - The cursor flashes during a value change operation.
  - During note event recording, you can change the pitch of a note by pressing a keyboard key. If the cursor is located at the “VEL” position, the velocity value will change at the same time as the note pitch.
4. To apply the changed value, press the R-16 (ENTER) button.
  - This causes the cursor to stop flashing.

### To delete an individual event

1. Display the event editor screen of the track that includes the events you want to delete.
  - See “To select a track for editing” (page E-85).
2. Use the R-17 (∧, ∨) buttons to move the cursor to the event you want to delete.
3. Press the C-8 (DELETE) button.
  - The event at the current cursor position will be deleted as soon as you press the C-8 (DELETE) button.



### To delete all events in a track

1. Display the event editor screen of the track that includes the events you want to delete.
  - See “To select a track for editing” (page E-85).
2. While holding down the R-13 (FUNCTION) button, press the C-13 (MENU) button to display the event editor menu.
3. Use the R-17 (∧, ∨) button to move the ● to “Delete” and then press the R-16 (ENTER) button.
  - This displays the “Delete” screen.

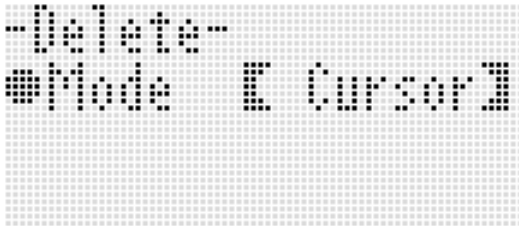

4. Use the dial or R-14 (–, +) buttons to change the setting in the thick brackets ([ ]) to “All”, and then press the R-16 (ENTER) button.
5. In response to the “Sure?” message that appears, press the R-14 (YES) button to delete or the R-14 (NO) button to cancel.

### To delete all events in a specific range of a track

1. Display the event editor screen of the track that includes the events you want to delete.
  - See “To select a track for editing” (page E-85).
2. If required, you can perform a song playback operation at this time to check the range you want to select for deletion.
  - See “To play back a song from the event editor screen (Quick Play)” (page E-85).

3. While holding down the R-13 (FUNCTION) button, press the C-13 (MENU) button to display the event editor menu.
4. Use the R-17 (∧, ∨) button to move the ● to “Delete” and then press the R-16 (ENTER) button.
  - This displays the “Delete” screen.
5. Use the dial or R-14 (–, +) buttons to change the setting in the thick brackets ([ ]) to “Locator”.
  - This displays a range specification screen like the one shown below.
  - If you have already specified a range using the locator screen (page E-74), that range will be displayed on the range specification screen.

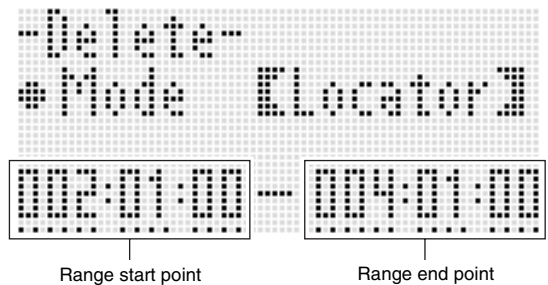

6. Use the R-17 (<, >) button to move the cursor, and then use the dial or R-14 (–, +) buttons to change the value at the cursor position.
  - The event located at the timing specified by the range end point will not be deleted.
7. After everything is the way you want, press the R-16 (ENTER) button.
8. In response to the “Sure?” message that appears, press the R-14 (YES) button to delete or the R-14 (NO) button to cancel.

### To insert an event

1. Display the event editor screen of the track where you want to insert the event.
  - See “To select a track for editing” (page E-85).
2. Use the R-17 (Λ, V) buttons to move the cursor to the position where you want to insert an event.
  - The new event will be inserted at the same timing as the event where the cursor is located. You can fine tune the timing after inserting the new event.
3. Press the C-9 (INSERT) button.

- This inserts the event at the specified location and displays a screen like the one shown below.

Note type (for note event only)

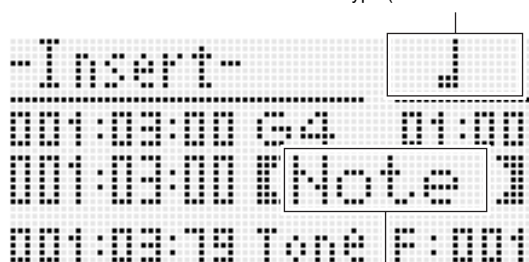

Event type name

### 4. Use the dial or R-14 (-, +) buttons to select an event type.

- For information about events that can be specified, see “Event Types and Screen Content” (page E-82).
- When a note event is specified as the event type, specify the note type (note length) using the buttons shown in the table below. You specify the pitch of the note in step 6 of this procedure.

To specify this type of note:	Press this button:
Whole	R-1 (○)
Half	R-2 (◡)
Quarter	R-3 (◢)
Eighth	R-7 (◣)
Sixteenth	R-8 (◤)
Thirty-second	R-9 (◥)
Dotted*	R-4 (●)
Triplet*	R-10 (ㄱ-3ㄴ)

\* For dotted notes and triplets, first select the note and then add the dot or triplet. To specify a dotted quarter note, for example, press the R-3 (◢) button and then the R-4 (●) button.

### 5. After everything is the way you want, press the R-16 (ENTER) button.

- This inserts the specified event.



### 6. Adjust the settings of the event as desired.

- Use the R-17 (<, >) button to move the cursor, and then use the dial or R-14 (-, +) buttons to change the value at the cursor position. The cursor flashes during a value change operation.
- For information about data types and setting value ranges for events that can be edited, see “Event Types and Screen Content” (page E-82).

### 7. To apply the event data, press the R-16 (ENTER) button.

- This causes the cursor to stop flashing.

#### NOTE

- You also can perform the operation in step 3 by moving the ● to “Insert” on the event editor menu and then pressing the R-16 (ENTER) button.

### To copy the events within a specific range to a desired location

1. Display the event editor screen of the track that contains the events you want to copy.
  - See “To select a track for editing” (page E-85).
2. If required, you can perform a song playback operation to check the range you want to select for copying and the copy location.

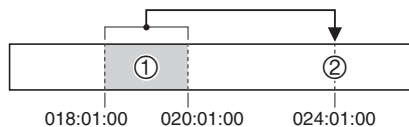

- See “To play back a song from the event editor screen (Quick Play)” (page E-85).

### 3. Press the C-10 (COPY) button.

- This displays the “Copy” screen.
- If you have already specified a range using the locator screen (page E-74), that range will be displayed on the range specification screen.

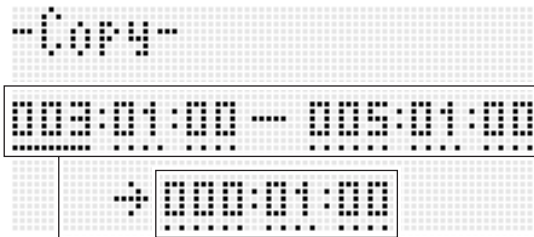

- ① Copy source range (start point - end point)
- ② Copy destination point

4. Use the R-17 (<, >) button to move the cursor, and then use the dial or R-14 (–, +) buttons to change the value at the cursor position.
5. After everything is the way you want, press the R-16 (ENTER) button.
6. In response to the “Sure?” message that appears, press the R-14 (YES) button to copy or the R-14 (NO) button to cancel.

- Pressing the R-14 (YES) button executes the copy operation. The message “Complete” appears and the display returns to the “Copy” screen after the copy is complete.
- At this time, the ② Copy destination position” value on the locator screen moves forward by the length specified by “① Copy source range”.

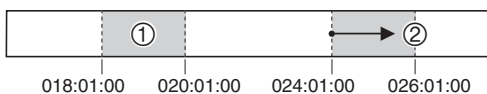

If you want to continue by copying the same copy source range to another location, repeat steps 5 and 6 again.

7. To return to the event editor screen, press the R-15 (EXIT) button.

### To quantize an individual note event

1. Display the event editor screen of the track that includes the event you want to quantize.
  - See “To select a track for editing” (page E-85).
2. Use the R-17 (Λ, V) buttons to move the cursor to the event you want to quantize.
3. Press the C-11 (QUANTIZE) button.
  - This displays the “Quantize” screen.



4. Use the dial or R-14 (–, +) buttons to change the setting in the thick brackets ([ ]) to “Cursor”.
5. Specify the note you want to use as the quantize reference note.

To specify this type of note:	Press this button:
Quarter	R-3 (♩)
Eighth	R-7 (♩)
Sixteenth	R-8 (♩)
Thirty-second	R-9 (♩)
Triplet*	R-10 (♩)

\* For a triplet, first select the note and then add the triplet. To specify a triplet made up of quarter notes, for example, press the R-3 (♩) button and then the R-10 (♩) button.

6. After everything is the way you want, press the R-16 (ENTER) button.

- This performs quantization and returns to the event editor screen.

### To quantize all note events in a track

1. Display the event editor screen of the track you want to quantize.
  - See “To select a track for editing” (page E-85).
2. Press the C-11 (QUANTIZE) button.
  - This displays the “Quantize” screen.
3. Use the dial or R-14 (–, +) buttons to change the setting in the thick brackets ([ ]) to “All”.
4. Perform step 5 under “To quantize an individual note event” on page E-89.
5. Press the L-17 (START/STOP) button when you want to play back with quantization applied.
  - Note that the actual data still has not been changed yet.
6. Press the R-16 (ENTER) button.
7. In response to the “Sure?” message that appears, press the R-14 (YES) button to quantize or the R-14 (NO) button to cancel.

### To quantize all note events within specific range of a track

1. Display the event editor screen of the track that includes the events you want to quantize.
  - See “To select a track for editing” (page E-85).
2. If required, you can perform a song playback operation at this time to check the range you want to select for quantization.
  - See “To play back a song from the event editor screen (Quick Play)” (page E-85).
3. Press the C-11 (QUANTIZE) button.
  - This displays the “Quantize” screen.

4. Use the dial or R-14 (–, +) buttons to change the setting in the thick brackets ([ ]) to “Locator”.

- This displays a range specification screen like the one shown below.
- If you have already specified a range using the locator screen (page E-74), that range will be displayed on the range specification screen.

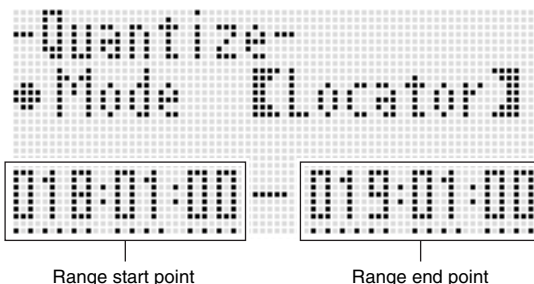

5. Use the R-17 (<, >) button to move the cursor, and then use the dial or R-14 (–, +) buttons to change the value at the cursor position.
6. Perform step 5 under “To quantize an individual note event” on page E-89.
7. Press the L-17 (START/STOP) button when you want to play back with quantization applied.
  - Note that the actual data still has not been changed yet.
8. After everything is the way you want, press the R-16 (ENTER) button.
9. In response to the “Sure?” message that appears, press the R-14 (YES) button to quantize or the R-14 (NO) button to cancel.

## Deleting Pitch Bender Events

You can use the procedures in this section to delete all pitch bender events from a track or from a specific range in a track.

### NOTE

- To delete individual pitch bender events, perform the operation under “To delete an individual event” (page E-86).
- After deleting the pitch bender events in one track from Track 01 through Track 16, you can overdub new pitch bender (**PITCH BEND** wheel (**S-1**)) operations for that track. To do so, use the procedure under “To record to Tracks 01 through 16” (page E-69), and select “OVDB” (Overdub) for the “RecType” setting in step 6-(3).
- Since “OVDB” cannot be selected for “RecType” when recording to the system track, you will not be able to overdub pitch bender operations after deleting pitch bender events from the system track. You can use the procedure under “To insert an event” (page E-88) to insert pitch bender events.

### ■ To delete all pitch bender events in a track

- Display the event editor screen of the track whose pitch bender events you want to delete.
  - See “To select a track for editing” (page E-85).
- While holding down the R-13 (FUNCTION) button, press the C-13 (MENU) button to display the event editor menu.
- Use the R-17 (Λ, ∨) button to move the ● to “DeleteBender” and then press the R-16 (ENTER) button.
  - This causes “Delete Bender” screen to appear.



- Use the dial or R-14 (–, +) buttons to change the setting in the thick brackets ([ ]) to “ALL”, and then press the R-16 (ENTER) button.
- In response to the “Sure?” message that appears, press the R-14 (YES) button to delete or the R-14 (NO) button to cancel.

### ■ To delete all pitch bender events within a specific range of a track

- Display the event editor screen of the track whose pitch bender events you want to delete.
  - See “To select a track for editing” (page E-85).
- If required, you can perform a song playback operation at this time to check the range you want to select for deletion.
  - See “To play back a song from the event editor screen (Quick Play)” (page E-85).
- While holding down the R-13 (FUNCTION) button, press the C-13 (MENU) button to display the event editor menu.
- Use the R-17 (Λ, ∨) button to move the ● to “DeleteBender” and then press the R-16 (ENTER) button.
  - This causes “Delete Bender” screen to appear.
- Use the dial or R-14 (–, +) buttons to change the setting in the thick brackets ([ ]) to “Locator”.
  - This displays a range specification screen like the one shown below.
  - If you have already specified a range using the locator screen (page E-74), that range will be displayed on the range specification screen.

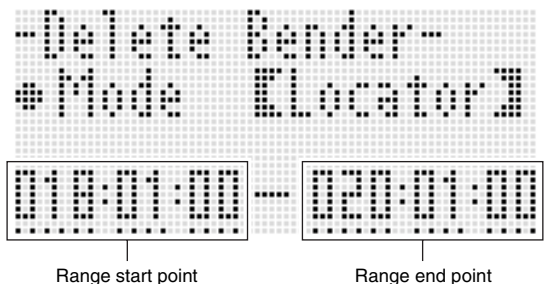

- Use the R-17 (<, >) button to move the cursor, and then use the dial or R-14 (–, +) buttons to change the value at the cursor position.
- After everything is the way you want, press the R-16 (ENTER) button.
- In response to the “Sure?” message that appears, press the R-14 (YES) button to delete or the R-14 (NO) button to cancel.

**To adjust the velocity value of a note event**

**1. Display the event editor screen of the track you want to edit.**

- See “To select a track for editing” (page E-85).

**2. Depending on the type of adjustment you want make, perform one of the operations below.**

To adjust this:	Do this:
Individual note event	On the event editor screen, move the cursor to the note event you want to adjust and then advance to step 3.
All note events in a track	Advance to step 3.
Note events within a specific range in a track	Advance to step 3.

**3. While holding down the R-13 (FUNCTION) button, press the C-13 (MENU) button to display the event editor menu.**

**4. Use the R-17 (∧, ∨) button to move the ● to “VelocityMod.” and then press the R-16 (ENTER) button.**

- This displays the “Velocity Modify” screen.



**5. Use the dial or R-14 (–, +) buttons to change the mode indicated in the thick brackets ([ ]).**

To adjust this:	Select this mode:
Individual note event	Cursor
All note events in a track	All
Note events within a specific range in a track	Locator

- While the “Locator” mode is selected, use the R-17 (<, >) buttons, the dial, or the R-14 (–, +) buttons to specify the range whose note event velocity value you want to adjust.

**6. Press the R-16 (ENTER) button.**

- This will display the setting screen like the one shown below.

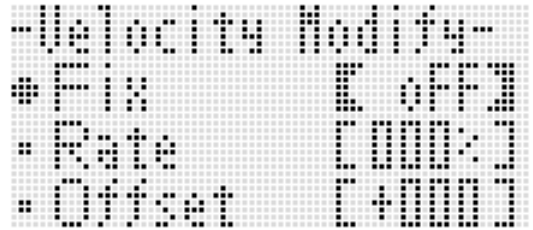

- The following explains the meanings and setting ranges of the on-screen items. The settings marked with an asterisk (\*) in the “Setting Range” column are initial defaults.

Item name	Description	Setting Range
Fix (Fixed value)	Specifies a fixed value as the velocity value. Select “oFF” for this setting to adjust based on the current velocity value of each note event.	oFF*, 001 to 127
Rate (Velocity Rate)	These settings are enabled only when the “oFF” is selected for the “Fix” setting. They change the velocity value of each note event according to the mathematical expression (decimal parts cut off) shown below. 1 is used when the value produced by the expression is less than 1, and 127 is used when it is greater than 127. (Current velocity) × (Rate setting) + (Offset setting)	000% to 100%* to 200%
Offset (Velocity Offset)		–126 to 000* to +126

**7. To change the setting to the desired value, press the R-16 (ENTER) button.**

**8. In response to the “Sure?” message that appears, press the R-14 (YES) button to execute the adjustment or the R-14 (NO) button to cancel.**

**To adjust the gate time value of a note event**

**1.** Perform steps 1 through 5 under “To adjust the velocity value of a note event” on page E-92. In step 4, select “GatetimeMod.” instead of “VelocityMod.”

**2.** Press the R-16 (ENTER) button.

- This will display the setting screen like the one shown below.



- The following explains the meanings and setting ranges of the on-screen items. The settings marked with an asterisk (\*) in the “Setting Range” column are initial defaults.

Item name	Description	Setting Range
Fix (Fixed value)	Specifies a fixed value as the time gate value. 99:95 stands for quarter note 99 beats, 95 ticks. Select “oFF” for this setting to adjust based on the current gate time value of each note event.	oFF*, 00:00 to 99:95
Rate (Gate Time Rate)	These settings are enabled only when the “oFF” is selected for the “Fix” setting. They change the gate time value of each note event according to the mathematical expression (decimal parts cut off) shown below. 00:00 is used when the value produced by the expression is less than 00:00, and 99:95 is used when it is greater than 99:95. (Current gate time) × (Rate setting) + (Offset setting)	000% to 100%* to 200%
Offset (Gate Time Offset)		-9:95 to 0:00* to +9:95

**3.** To change the setting to the desired value, press the R-16 (ENTER) button.

**4.** In response to the “Sure?” message that appears, press the R-14 (YES) button to execute the adjustment or the R-14 (NO) button to cancel.

**To delete a beat event**

**1.** Perform the procedure under “To start an event editor operation” on page E-81 to display the event editor menu.

**2.** Use the R-17 (V) button to move the ● to “Beat” and then press the R-16 (ENTER) button.

- This displays the “Beat” screen.



**3.** Use the R-17 (∧, V) buttons to move the cursor to the beat event you want to delete.

**4.** Press the C-8 (DELETE) button.

- The event at the current cursor position will be deleted as soon as you press the C-8 (DELETE) button.



## To insert a beat event

1. Perform steps 1 and 2 under “To delete a beat event” (page E-93).
2. Move the cursor to the beat event that comes immediately before the location where you want to insert a new beat event.
3. Press the C-9 (INSERT) button.
  - This will insert a new beat event into the next measure after the cursor position you selected in step 2, which does not contain a beat event. If, for example, there are beat events already in measures 16 and 17, selecting the beat event in measure 16 with the cursor and pressing the C-9 (INSERT) button will insert a new beat event into measure 18.
4. Change the beat event measure and beat as required.
  - Use the R-17 (<, >) button to move the cursor, and then use the dial or R-14 (-, +) buttons to change the value at the cursor position. The cursor flashes during a value change operation. Pressing the R-16 (ENTER) button applies the setting and causes the cursor to stop flashing.
5. To return to the event editor screen, press the R-15 (EXIT) button.

## Directly Inputting Note Events (Step Input)

Step input is an event editor function. You can use step input to specify the length and pitch of each individual note (note event). In the system track, you also can perform step input of Auto Accompaniment chords (chord events) as well.

### NOTE

- Performing step input into a track that already contains recorded data will not delete the existing data. This means you can use step input to add to existing recorded data.

## To perform step input

1. Display the event editor screen of the track where you want to perform step input.
  - See “To select a track for editing” (page E-85).
2. Press the C-12 (STEP) button.
  - This will display a step screen like the one shown below. The cursor is always flashing during step input.

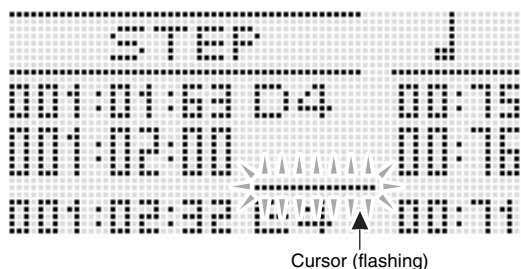

3. Configure step input settings.
  - (1) While holding down the R-13 (FUNCTION) button, press the C-13 (MENU) button. This displays the input menu shown below.





- (2) Use the R-17 (▲, ▼) buttons to move ● to the setting item you want to change.
  - (3) Use the dial or R-14 (-, +) buttons to change the setting value.
    - For information about the meanings and setting ranges of the on-screen items, see “Input Menu Setting Items” (page E-95).
  - (4) Press the R-15 (EXIT) button to exit the menu.
4. Use the L-15 (▶▶FF) and L-14 (◀◀REW) buttons to move the cursor to the location from which you want to perform step input.
    - The cursor will move in one-measure steps.

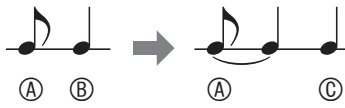

## 5. Use buttons R-1 (♩) to R-4 (♩) and buttons R-7 (♩) to R-10 (♩) to specify the length of the note you want to input.

- For information about how to specify note lengths, see step 4 under “To insert an event” (page E-88).
- You can perform the following operations during step input to insert ties and rests.

To do this:	Perform this operation:
Tie the note at the current cursor position with the note event immediately before it	<ol style="list-style-type: none"> <li>1. At the current cursor position, specify the length of the note you want to tie with the immediately preceding note event.</li> <li>2. Press the <b>R-11</b> (TIE) button. <ul style="list-style-type: none"> <li>• This adds the length of the note you specified in step 1 to the length of the note immediately preceding it. At this time, the cursor will move forward by the timing of the added amount.</li> </ul> </li> </ol>  <p> <span data-bbox="370 540 391 569">Ⓐ</span> Preceding note event  <span data-bbox="418 540 439 569">Ⓑ</span> Current cursor position  <span data-bbox="555 540 576 569">Ⓐ</span> Preceding note event  <span data-bbox="665 540 686 569">Ⓒ</span> Cursor position after process  <span data-bbox="727 511 747 540">Ⓑ</span> Current cursor position  <span data-bbox="727 540 747 569">Ⓒ</span> Cursor position after process </p>
Insert a rest before the current cursor position	<ol style="list-style-type: none"> <li>1. At the current cursor position, specify a note that is the same length as the rest you want to insert.</li> <li>2. Press the <b>R-5</b> (REST) button. <ul style="list-style-type: none"> <li>• The cursor will move forward by the length of the note you specified in step 1.</li> </ul> </li> </ol>  <p> <span data-bbox="418 743 439 772">Ⓑ</span> Current cursor position  <span data-bbox="665 743 686 772">Ⓒ</span> Cursor position after process  <span data-bbox="727 714 747 743">Ⓑ</span> Current cursor position  <span data-bbox="727 743 747 772">Ⓒ</span> Cursor position after process </p>

## 6. Press the keyboard key that corresponds to the note you want to input.

- The note is input as soon as you press the keyboard key, and the cursor will move by the length you specified in step 5 to the next measure:beat:tick. From there you can input the next note, if you want.

## 7. Repeat steps 5 and 6 to input the notes you want.

- If you want to input a series of notes of the same length, skip step 5 and perform step 6 only.

## 8. After inputting all of the notes you want, press the R-15 (EXIT) or R-17 (∧, ∨) button.

- This returns to the event editor screen.

## Input Menu Setting Items

Pressing the **C-13** (MENU) button while holding down the **R-13** (FUNCTION) button during step input will display the input menu. The following explains the meanings and setting ranges of the input menu items. The settings marked with an asterisk (\*) in the “Setting Range” column are initial defaults.

Item name	Description	Setting Range
GateRate (Gate Rate)	Specifies the gate rate as a percentage of the actually input gate length for the length (gate length) of the note event or chord event that was specified using buttons <b>R-1</b> (♩) through <b>R-4</b> (♩) and <b>R-7</b> (♩) through <b>R-10</b> (♩). Specifying a GateRate of 080% and inputting a quarter note (96 ticks), for example, will result in a GATE setting of 00:76 (96 × 0.8 = 76.8, cut off to 76).	001% to 080%* to 100%
Velocity (Velocity)	Specifies the velocity value of an input note event or chord event. Specifying “KeyOn” inputs a velocity value in accordance with applied key pressure.	KeyOn, 001 to 100* to 127
SysTrack (System Track)	Selects either note event input or chord event input when inputting to the system track.	note*, Chord

# Using the Function Menu

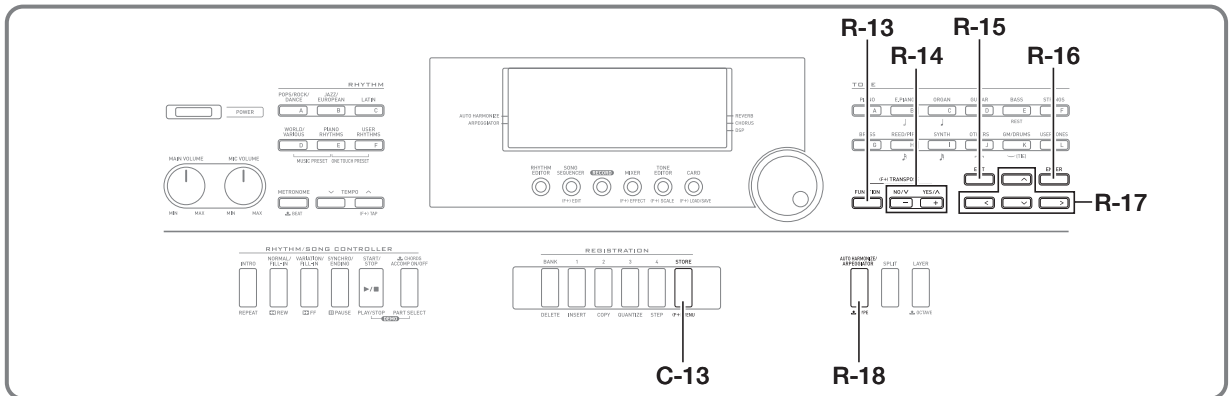

The function menu contains items for tuning and touch adjustments, local on/off, and other global settings that need to be changed by you relatively infrequently. It also includes some memory card operations (format, etc.).

## Using the Function Menu

This section explains function menu operations. For details about specific function menu items, see “Function Menu Settings” (page E-97).

### To change the setting of a function menu item

1. Press the R-13 (FUNCTION) button.

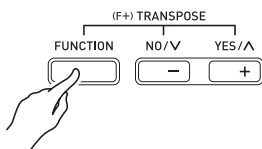

- This displays the function menu like the one shown below.



2. To adjust the “Tune” (Tuning) setting, use the dial or the R-14 (-, +) buttons to change the value inside the thick brackets ([ ]).

- Pressing the R-14 (-, +) buttons at the same time returns the setting to its initial default.

3. The setting items from “Performance” and below are groups that include multiple setting items. Use the following procedure to change the settings of the items in each group.

(1) Use the R-17 (▲, ▼) buttons to move the ● to the desired group name and then press the R-16 (ENTER) button.

- This displays the items included within the group.



Example: Performance group

(2) Use the R-17 (▲, ▼, <, >) buttons to move ● to the setting you want to change.

(3) Use the dial or the R-14 (-, +) buttons to change the setting value.

- Pressing the R-14 (-, +) buttons at the same time returns an item to its initial default setting.

(4) To return to the function menu, press the R-15 (EXIT) button.

4. To exit the function menu, press the R-13 (FUNCTION) button or R-15 (EXIT) button.

### IMPORTANT!

- Note that all function menu settings you configure are returned to their initial defaults whenever you turn off the Digital Keyboard. You can configure the Digital Keyboard so it remembers its latest settings or to apply predetermined default settings each time you turn it on. For details, see “AutoResume (Auto Resume)” (page E-100) and “Default (Default Settings)” (page E-100).
- Some function menu settings also can be saved to registration memory. For details, see “Saving Keyboard Setups to Registration Memory” (page E-62).

## Function Menu Settings

This section explains the meaning of each function menu setting item, and provides information about setting ranges and initial default values.

- For each item, the initial default setting is indicated by an asterisk (\*).

### Tune (Tuning)

Fine tunes the overall keyboard tuning in 0.1 Hz steps.

A4=415.5 - 440.0\* - 465.9Hz

### Performance (Performance/Accompaniment) Group

#### NOTE

- You can directly display this group screen without going through the function menu. While the initial power on screen is displayed, hold down the R-13 (FUNCTION) button as you press the C-13 (MENU) button.

```

-Performance- 1/3
# Touch      [ 13 ]
# TchOffVel  [100]
# Ped.Assign [SUS]
  
```

### Touch (Touch Response)

Select one of the settings below to specify the relationship between key pressure and note volume.

- oFF : Constant note volume regardless of keyboard pressure
- 1\* : Normal
- 2 : Strong sound even with light pressure

### TchOffVel (Touch Off Velocity)

Specifies the velocity value setting when the Touch setting is off.

000 - 100\* - 127

### Ped.Assign (Pedal Assign)

Specifies the operation of the pedal connected to T-3 (SUSTAIN/ASSIGNABLE JACK).

- SUS\* : Sustain pedal
- SSt : Sostenuto pedal
- SFt : Soft pedal
- rHy : Rhythm start/stop switch

### BendRange (Bend Range)

Specifies the range of pitch change that occurs when the PITCH BEND wheel (S-1) is rotated.

00 - 02\* - 24 semitones

### ArpegHold (Arpeggiator Hold)

Specifies the how arpeggio is played in accordance with pressed keyboard keys when the arpeggiator (page E-23) is being used.

- oFF\* : Arpeggio played while the keys of a chord are depressed on the keyboard
- on : Arpeggio played after keyboard keys are released

#### NOTE

- When “on” is selected for this setting, you can turn off arpeggio play pressing the R-18 (AUTO HARMONIZE/ARPEGGIATOR) button to disable the arpeggiator, or you can change this setting to “oFF”.

### ArpegSpeed (Arpeggiator Speed)

Specifies how many times notes or chords should sound within one beat for arpeggio phrases played by the arpeggiator (page E-23).

**1, 2, 2S, 3, 4\*, 4S, 6, 8**

The setting value indicates the number of times within one beat. Selecting an option that is only a value will sound the note that number of times within one beat. Selecting "4", for example, will play with the rhythm ♪♪♪♪.

Selecting an option that includes the letter "S" will play a shuffle. 2S plays ♪♪ and 4S plays ♪♪♪♪.

#### NOTE

- The availability of the settings for this item depends on the arpeggiator type. Refer to the separate "Appendix" for details.

### ArpegPart (Arpeggiator Part)

Specifies whether arpeggiator play should be used for the UPPER part keyboard or LOWER part keyboard when the arpeggiator (page E-23) is used while the keyboard is split between two tones (page E-15).

**Upp\*** : UPPER part

**Low** : LOWER part

### RegFitAcmp (Registration Filter: Accompaniment)

Specifies if accompaniment settings are recalled (oFF\*) when a registration setup (page E-62) is recalled, or if accompaniment settings are not recalled (on).

### RegFitScal (Registration Filter: Scale)

Specifies if scale settings are recalled (oFF) when a registration setup (page E-62) is recalled, or if scale settings are not recalled (on\*).

## Play/CardUtl (Playback, Card Utility) Group

#### NOTE

- You can directly display this group screen without going through the function menu. While in the card mode (page E-103), hold down the **R-13 (FUNCTION)** button as you press the **C-13 (MENU)** button.

```

-PlayCardUtl- 1/2*
#Precount      [oFF]
*SongRepeat    [oFF]
*AllData       >Ent
    
```

### PreCount (Song Pre-count Sound)

Specifies if a pre-count should sound (on) when playback of a song file is started in the card mode (page E-103) or if a pre-count should not sound (oFF\*).

### SongRepeat (Song Repeat Play)

Specifies if a single song file should be repeat played (on) during playback in the card mode (page E-103) or if a song file should not be repeat played (oFF\*).

### AllData (All Data)

You can batch save all user data in Digital Keyboard memory to a memory card, or load all user data from a memory card to Digital Keyboard memory.

See "To batch save all Digital Keyboard data to a memory card" (page E-105) and "To batch load all Digital Keyboard memory data from a memory card" (page E-106) for more information.

### CardFormat (Card Format)

See "Formatting a Memory Card" (page E-103).

### FileDelete (File Delete)

See "To delete a file from a memory card" (page E-107).

### FileRename (File Rename)

See "To rename a file on a memory card" (page E-107).

## Volume (Volume) Group

```

-Volume-
* AccompVol. [000]
* SongVol.   [127]
* MetroVol.  [100]
  
```

### NOTE

- For details about “parts” mentioned here, see “How Parts are Organized” (page E-39).

### AccompVol. (Auto Accompaniment Volume)

Adjusts the Auto Accompaniment volume level (master volume of parts A09 through A16). This setting does not affect the keyboard volume level (parts A01 through A03).

000 - 115\* - 127

### SongVol. (Song Volume)

Adjusts the master volume of song file playback in the card mode (page E-103). This setting does not affect the keyboard volume level (parts A01 through A03) or Auto Accompaniment volume level (parts A09 through A16).

000 - 127\*

### MetroVol. (Metronome Volume)

Adjusts the metronome volume. This setting is linked with the A08 part volume (part volume) that can be adjusted with the mixer (page E-39).

000 - 100\* - 127

## MIDI Group

```

-MIDI-
* KeyboardCh [01]
* LocalCtrl  [on]
* AccompOut  [oFF]
  
```

### KeyboardCh (Keyboard Channel)

Selects the channel for sending keyboard play MIDI data to an external device (keyboard channel).

01\* - 16

### LocalCtrl (Local Control)

Specifies whether pressing a key sounds the internal sound source (on\*) or whether the keyboard and internal sound source should be disconnected (oFF).

### AccompOut (Accompaniment MIDI Out)

Specifies if Auto Accompaniment MIDI data should be sent to an external device (on) or not sent to an external device (oFF\*).

## General (Other) Group

```

-General- 1/2
* Contrast [09]
* AutoPower [on]
* AutoResume [oFF]
  
```

### Contrast (LCD Contrast)

Adjusts display contrast.

01 - 09\* - 17

### AutoPower (Auto Power Off)

Specifies if Auto Power Off (page E-13) is enabled (on\*) or disabled (oFF). Even when “on” is selected for this setting, you can temporarily disable Auto Power Off by holding down the L-4 ([A] POPS/ROCK/DANCE) button as you press the L-1 (POWER) button to turn on power.

### AutoResume (Auto Resume)

Specifies whether the Digital Keyboard should remember its setup when turned off and restore it the next time it is turned on.

- oFF\*** : Restores power on defaults when power is turned on.
- on** : Remembers setup when power is turned off and restores it when power is turned back on.

#### NOTE

- For information about the setting items that are restored when Auto Resume is enabled, see “Parameter List” (page E-127).
- Initially, power on default settings are the same as the factory default settings. You also can use the procedure below to specify other power on default settings to suit your needs.

### Default (Default Settings)

You can use this setting item to do the following.

- Rewrite the power on default settings with the Digital Keyboard’s current setup (registering default settings).
- Return the power on default settings to the factory default settings (clearing default settings).

#### ■ To register or clear default settings

- 1. Press the R-13 (FUNCTION) button to display the function menu.**
- 2. Use the R-17 (>, V) buttons to move the ● to “General” and then press the R-16 (ENTER) button.**
- 3. Use the R-17 (Λ, V) button to move the ● to “Default” and then press the R-16 (ENTER) button.**
  - This displays the default setting screen like the one shown below.



- 4. Use the R-17 (Λ, V) buttons to select the operation you want.**

To do this:	Move the ● here:
Return the power on default settings to the factory default settings (clearing default settings).	Clear
Rewrite the power on default settings with the Digital Keyboard’s current setup (registering default settings).	Store

- For information about the setting items that are registered as default settings, see “Parameter List” (page E-127).

- 5. After everything is the way you want, press the R-16 (ENTER) button.**

- The message “Complete” appears and the display returns to the screen before you pressed the R-16 (ENTER) button in step 3.

- 6. To exit the function menu, press the R-13 (FUNCTION) button.**

#### NOTE

- If you want the default settings to be restored whenever power is turned on, select “oFF” for the “AutoResume” setting (page E-100).

### Initialize (Initialize)

This item can be used to initialize all data and settings, or parameter settings only.

#### NOTE

- For information about what settings are initialized when “Parameter” is selected for initialization in step 4 of the procedure below, see “Parameter List” (page E-127).

■ To initialize all data and settings (or parameter settings only)

1. Press the R-13 (FUNCTION) button to display the function menu.
2. Use the R-17 (>, V) buttons to move the ● to “General” and then press the R-16 (ENTER) button.
3. Use the R-17 (>, V) buttons to move the ● to “Initialize” and then press the R-16 (ENTER) button.
  - This displays the initialize screen like the one shown below.



```
-Initialize-
#Parameter  >Ent
- All       >Ent
```

4. Use the R-17 (∧, V) buttons to select either “All” (all settings) or “Parameter” (parameter settings only).
5. To execute initialization, press the R-16 (ENTER) button.

# Using a Memory Card

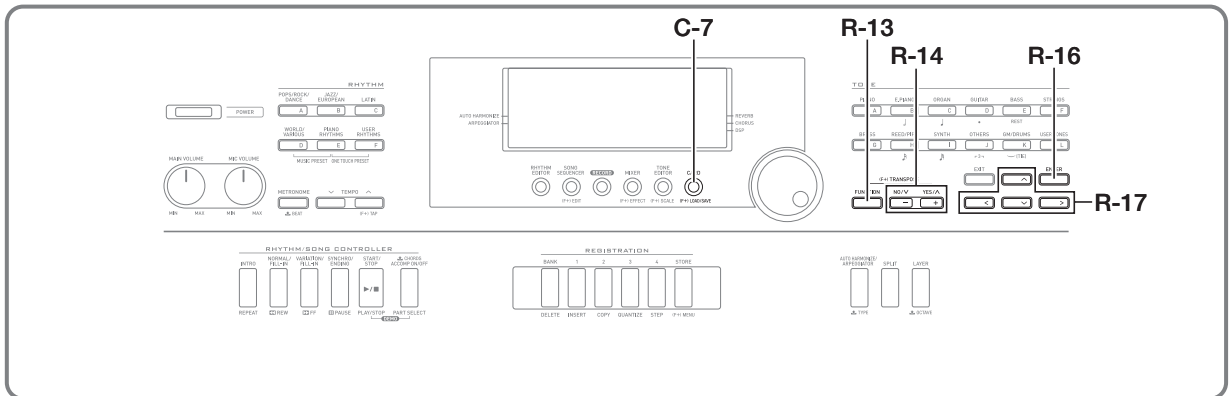

You can save Digital Keyboard user area data to a memory card and load data from a memory card to Digital Keyboard memory. You also can play music files (MIDI files) stored on a memory card on the Digital Keyboard.

## NOTE

- Use an SD memory card or an SDHC memory card with a capacity of 32GB or less. Use of a memory card with a capacity that is greater than 32GB and other types of memory cards is not supported.

## Supported Data Types

### Data that can be saved to and exported from a memory card

Data Type	Description (File Name Extension)
User rhythm data (page E-29)	Auto Accompaniment data edited with this Digital Keyboard (AC7)
User tone data (page E-45)	Tone data edited with this Digital Keyboard (TN7)
User DSP data (page E-37)	DSP data edited with this Digital Keyboard (DS7)
User preset data (page E-54)	Music preset data edited on this Digital Keyboard (MPS)
Song sequencer data (page E-64)	Song data edited with this Digital Keyboard (CMS, MID*)
Registration data (page E-62)	This Digital Keyboard's panel settings (RM7)
All data	All the above data (AL7)

\* Save only.

- For information about saving and importing individual data items, see “Saving Digital Keyboard Data to a Memory Card” (page E-104) and “Loading Data from a Memory Card” (page E-106).
- For details about saving and loading all data, see “To batch save all Digital Keyboard data to a memory card” (page E-105) and “To batch load all Digital Keyboard memory data from a memory card” (page E-106).

### Data that can be directly played back from a memory card

Data Type	Description (File Name Extension)
Song files (page E-108)	SMF format 0 or 1 MIDI files (MID)

## Card and Card Slot Precautions

- Be sure to observe the precautions provided in the documentation that comes with the memory card.
- Memory cards have a write-protect switch. Use it when you want to protect the data on the card from accidental deletion.
- Avoid using a memory card under the following conditions. Such conditions can corrupt data stored on the memory card.
  - Areas subjected to high temperature, high humidity, or corrosive gas.
  - Areas subjected to strong electrostatic charge and digital noise.
- Never touch the contacts of a memory card when loading it or removing it from the Digital Keyboard.
- The message “Please Wait” will remain on the display while a data save operation is in progress. Do not perform any other operation while it is displayed. Turning off the Digital Keyboard or removing the memory card can cause Digital Keyboard data to be deleted or become corrupted. It also can cause the Digital Keyboard to fail to turn on when the **L-1 (POWER)** button is pressed. If this happens, refer to “Troubleshooting” (page E-114).
- Never insert anything besides a memory card into the card slot. Doing so creates the risk of malfunction.
- Electrostatic charge from your fingers or the memory card to the card slot can cause malfunction of the Digital Keyboard. If this happens, turn the Digital Keyboard off and then back on again.
- A memory card can become quite warm after very long use in the card slot. This is normal and does not indicate malfunction.



## Loading and Removing a Memory Card

### IMPORTANT!

- A memory card must be positioned correctly when being loaded into the Digital Keyboard. Trying to force an improperly oriented memory card into the slot can damage the memory card and the slot.

1. With the top of the memory card facing upwards (so you can see it), carefully insert it into the Digital Keyboard's SD card slot (T-1) until stops with a click.

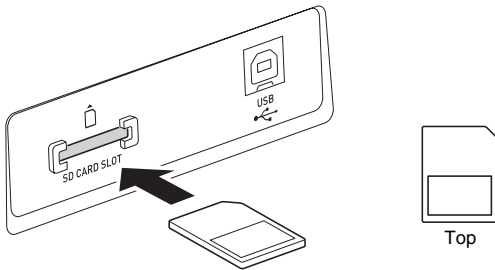

2. To remove the memory card first press it into the slot further.

- This will cause the memory card to disengage and eject partially. Pull the memory card the rest of the way out of the slot.

## Entering the Card Mode

Enter the card mode when you want to perform memory card operations.

- While in the rhythm mode (page E-7) press the **C-7 (CARD)** button to enter the card mode.

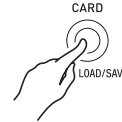

This will cause the **[RHYTHM]** indicator to disappear from the display and the **[CARD]** indicator to appear.

```
[TONE]-----A:001
StreeOrPiano
[CARD]-----
No Card
```

If the message “No Card” appears on the display, it means there is no memory card in the card slot. For details about what appears on the display while a card is loaded, see “Playing a Music File from a Memory Card” (page E-108).

- To exit the card mode, press the **C-7 (CARD)** button again. This will cause the **[CARD]** indicator to disappear from the display and the **[RHYTHM]** indicator to appear.

## Formatting a Memory Card

### IMPORTANT!

- Format a memory card before using it for the first time.
- Before formatting a memory card, make sure it does not have any valuable data stored on it.
- The memory card format operation performed by this Digital Keyboard is a “quick format”. If you want to completely delete all of the data on the memory card, format it on your computer or some other device.

1. Insert the memory card you want to format into the Digital Keyboard's card slot.

- Make sure the memory card is write-enabled. Check the position of the card's write-protect switch to ensure it is not in the write-protect position.

2. Press the **C-7 (CARD)** button to enter the card mode.

3. While holding down the **R-13 (FUNCTION)** button, press the **C-13 (MENU)** button.

- This displays the function menu “Play/CardUt” screen.

4. Use the R-17 (∧, ∨) buttons to move the ● to “CardFormat”.

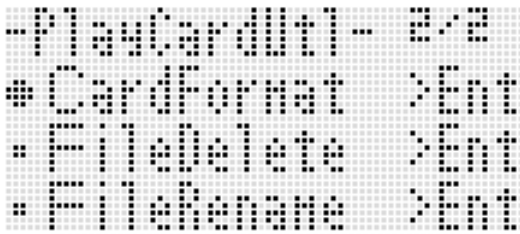

5. Press the R-16 (ENTER) button.

- This will cause the confirmation message “Sure?” to appear.

6. Press the R-14 (YES) button to format the memory card or the R-14 (NO) button to cancel.

- The message “Please Wait” will remain on the display while the format operation is being performed. Do not perform any Digital Keyboard operation while this message is on the display. “Complete” appears on the display after formatting is complete.
- Formatting may take as long as a few minutes to complete.

## Saving Digital Keyboard Data to a Memory Card

### To save Digital Keyboard data to a memory card

1. Insert the memory card into the card slot.
2. If the Digital Keyboard is in the card mode, press the C-7 (CARD) button to exit the card mode.

3. Depending on the type of data you want to save to the memory card, perform one of the steps shown below.

- All setup registration banks are saved as a batch. Other data is saved in area (data item) units.

To save this type of data:	Do this:
One user rhythm	<ol style="list-style-type: none"> <li>1. Press the L-9 ([F] USER RHYTHMS) button.</li> <li>2. Use the dial or R-14 (←, →) buttons to specify the user rhythm number.</li> </ol>
One user tone	<ol style="list-style-type: none"> <li>1. Press the R-12 ([L] USER TONES) button.</li> <li>2. Use the dial or R-14 (←, →) buttons to specify the user tone number.</li> </ol>
One user DSP	<ol style="list-style-type: none"> <li>1. Perform steps 1 through 4 under “To use a DSP” (page E-36).</li> <li>2. Use the dial or R-14 (←, →) buttons to specify the user DSP number (101 through 200).</li> </ol>
One user preset	<ol style="list-style-type: none"> <li>1. While holding down the L-7 ([D] WORLD/ VARIOUS) button, press the L-8 ([E] PIANO RHYTHMS) button to display the music preset screen.</li> <li>2. Press the L-9 ([F] USER RHYTHMS) button.</li> <li>3. Use the dial or R-14 (←, →) buttons to specify the user preset number.</li> </ol>
One song sequencer song	<ol style="list-style-type: none"> <li>1. Press the C-3 (SONG SEQUENCER) button to enter the song sequencer mode.</li> <li>2. Use the dial or R-14 (←, →) buttons to specify the song number.</li> </ol>
All registration banks	Press the C-8 (BANK) button to display the registration bank selection screen.

4. While holding down the R-13 (FUNCTION) button, press the C-7 (LOAD/SAVE) button.

- This causes an “Xxxx Load”<sup>\*1</sup> screen like the one shown below to appear. The sample screen below shows the screen that appears from the rhythm screen.



**5. Press the R-17 (V) button to change to the “Xxxx Save”<sup>\*1</sup> screen.**



- To save a song sequencer song in SMF format, press the R-17 (V) button one more time here to display the “Seq SmfSave” screen. You can switch between the “Xxxx Load”, “Seq Save”, and “Seq SmfSave” screens using the R-17 (Λ, V) buttons.

**6. Enter the file name to assign to the data when it is stored.**

Change the initial default file name “USERNAME.xxx”<sup>\*2</sup> as described below.

- Use the R-17 (<, >) buttons to move the cursor to the character you want to change.
- Use the dial or the R-14 (-, +) buttons to change the character.

- The characters you can select are shown below.

0	1	2	3	4	5	6	7	8	9
A	B	C	D	E	F	G	H	I	J
K	L	M	N	O	P	Q	R	S	T
U	V	W	X	Y	Z	\$	&	_	'
(	)	-	^	{	}	@	~	`	

**7. After everything is the way you want, press the R-16 (ENTER) button.**

**8. In response to the “Sure?” message that appears, press the R-14 (YES) button to save or the R-14 (NO) button to cancel.**

\*1 The “Xxxx” part of the file name depends the type of data you are saving.

\*2 The “xxx” part of the file name is a file name extension that depends the type of data you are saving.

**NOTE**

- Performing the above procedure to write a song sequencer song to an SMF format file will save the data as SMF Format 0 (16 channel) data. System track data A01 through A16 are saved respectively to SMF 01CH through 16CH, while song tracks 01 through 16 are saved respectively to SMF 01CH through 16CH. Note that the save operation gives priority to the data of tracks 01 through 16. If there is data in any of the tracks 01 through 16 and “On” is selected for the “Part On/Off” setting of a track that contains data, the system track data (A01 through A16) for the same numbered track data will not be saved. Also, the note events of tracks that are turned off using the mixer are not saved.

**To batch save all Digital Keyboard data to a memory card**

- Press the C-7 (CARD) button to enter the card mode.
- While holding down the R-13 (FUNCTION) button, press the C-13 (MENU) button.
  - This displays the function menu “Play/CardUt” screen.
- Use the R-17 (Λ, V) buttons to move the ● to “AllData” and then press the R-16 (ENTER) button.
- When the “All Load” screen appears, use the R-17 (V) button to change to the “All Save” screen.



- The remainder of the steps are the same as those from step 6 under “To save Digital Keyboard data to a memory card” (page E-104).

**Memory card Data Storage**

The above procedure stores Digital Keyboard data in a folder named MUSICDAT on the memory card.

- The MUSICDAT folder is created automatically when you format the memory card on the Digital Keyboard (page E-103).
- Note that files not in the MUSICDAT folder cannot be loaded, deleted, or renamed by this Digital Keyboard. You also will not be able to load or delete any file stored in any subfolder inside the MUSICDAT folder.

## Loading Data from a Memory Card

### IMPORTANT!

- Make sure that all of the data you want to load is in the MUSICDAT folder on the memory card.

### To load data to Digital Keyboard memory from a memory card

1. Insert the memory card into the card slot.
2. If the Digital Keyboard is in the card mode, press the C-7 (CARD) button to exit the card mode.
3. Referring to the table in step 3 of the procedure under “To save Digital Keyboard data to a memory card” (page E-104), perform the procedure required for the type of data you want to load from the card.
  - All setup registration banks are loaded as a batch. Other data is loaded in area (data item) units.
4. While holding down the R-13 (FUNCTION) button, press the C-7 (LOAD/SAVE) button.
  - This causes an “Xxxx Load”\* screen like the one shown below to appear. The sample screen below shows the screen that appears from the rhythm screen.



5. Use the dial or R-14 (-, +) buttons to display the file you want to import.
6. Press the R-16 (ENTER) button.
7. In response to the “Sure?” message that appears, press the R-14 (YES) button to load or the R-14 (NO) button to cancel.

\* The “Xxxx” part of the file name depends the type of data on the memory card.

### To batch load all Digital Keyboard memory data from a memory card

1. Press the C-7 (CARD) button to enter the card mode.
2. While holding down the R-13 (FUNCTION) button, press the C-13 (MENU) button.
  - This displays the function menu “Play/CardUt” screen.
3. Use the R-17 (∧, ∨) buttons to move the ● to “AllData” and then press the R-16 (ENTER) button.
  - This displays the “All Load” screen.
  - The remainder of the steps are the same as those from step 5 under “To load data to Digital Keyboard memory from a memory card”.

## To delete a file from a memory card

1. Insert the memory card into the card slot.
2. Press the C-7 (CARD) button to enter the card mode.
3. While holding down the R-13 (FUNCTION) button, press the C-13 (MENU) button.
  - This displays the function menu “Play/CardUtI” screen.
4. Use the R-17 (∧, ∨) buttons to move the ● to “FileDelete” and then press the R-16 (ENTER) button.
  - This displays a screen for specifying the file to be deleted.

FileDelete 0013  
BEAT .MID  
Press Enter

5. Use the dial or R-14 (–, +) buttons to display the file you want to delete.
6. Press the R-16 (ENTER) button.
7. In response to the “Sure?” message that appears, press the R-14 (YES) button to delete or the R-14 (NO) button to cancel.
  - Pressing the R-14 (YES) button displays the message “Please Wait” (indicating the operation is in progress). Do not perform any operation while this message is on the display. “Complete” appears on the display after the operation is complete.

## To rename a file on a memory card

1. Insert the memory card into the card slot.
2. Press the C-7 (CARD) button to enter the card mode.
3. While holding down the R-13 (FUNCTION) button, press the C-13 (MENU) button.
  - This displays the function menu “Play/CardUtI” screen.
4. Use the R-17 (>, ∨) buttons to move the ● to “FileRename” and then press the R-16 (ENTER) button.
  - This displays a screen for specifying the file to be renamed.
5. Use the dial or R-14 (–, +) buttons to display the file you want to rename.
6. Use the R-17 (<, >) buttons to move the cursor to the name character position you want to change, and then use the dial or R-14 (–, +) buttons to select the character you want.
7. After the name is the way you want, press the R-16 (ENTER) button.
8. In response to the “Sure?” message that appears, press the R-14 (YES) button to rename the file or the R-14 (NO) button to cancel.
  - Pressing the R-14 (YES) button displays the message “Please Wait” (indicating the operation is in progress). Do not perform any operation while this message is on the display. “Complete” appears on the display after the operation is complete.

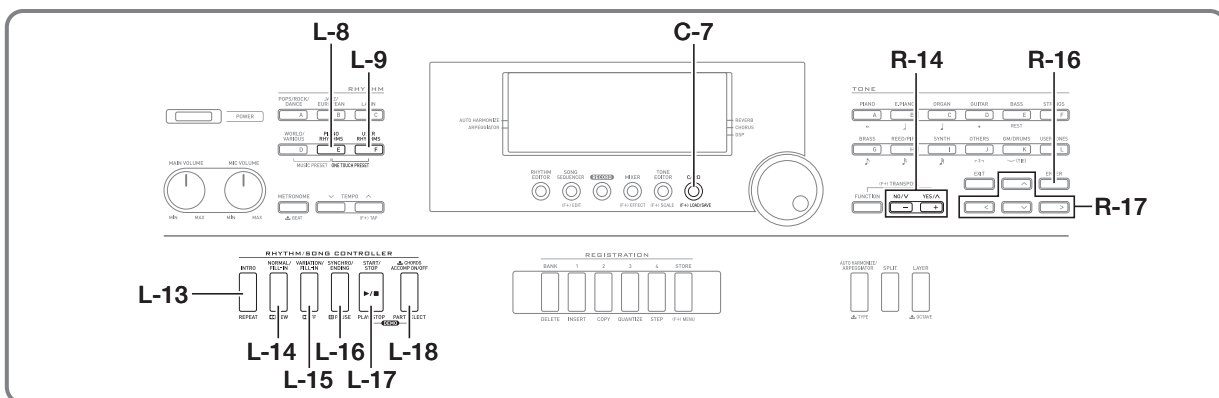

## Playing a Music File from a Memory Card

You can use the Digital Keyboard to play music files you saved to a memory card with your computer.

### IMPORTANT!

- Supported music files are SMF format 0 or 1 MIDI files (MID).
- Playback of audio files (WAV, MP3, etc.) is not supported.

### NOTE

- At the same time playback starts, the transpose setting (page E-18) will change to 00 and the local control setting (page E-99) will change to "on".

### To play a music file from a memory card

- Format the memory card on the Digital Keyboard (page E-103).**
  - This will cause a folder named MUSICDAT to be automatically created in the memory card root directory.
- Use your computer to copy the music file you want to play to the MUSICDAT file that was created in step 1.**
  - See the "Important!" note above for information about supported file types.
- Insert the memory card into the card slot.**
- Press the C-7 (CARD) button to enter the card mode.**

- Use the dial or R-14 (-, +) buttons to select the music file you want to play.**

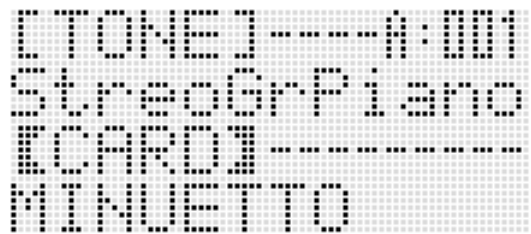

- To start playback, press the L-17 (PLAY/STOP) button.**

- To perform a fast forward operation, hold down the L-15 (▶▶FF) button. The measure number in the lower right corner of the display scrolls at high speed while the L-15 (▶▶FF) is depressed. Releasing the button immediately resumes normal playback from that point.
- To perform a fast backward operation, hold down the L-14 (◀◀REW) button. Sound is muted and the measure number in the lower right corner of the display scrolls at high speed while the L-14 (◀◀REW) is depressed. Releasing the button immediately resumes normal playback from the beginning of the measure whose number is displayed.
- Pressing the L-16 (PAUSE) button pauses playback. Press again to resume playback.

- To stop playback, press the L-17 (PLAY/STOP) button.**

## Turning Off One Hand Part and Playing the Other Hand Part on the Keyboard (Part Off)

When playing a music file of a piano piece that has the left hand and the right hand parts recorded in separate MIDI channels, you can turn off playback of one of the parts and play it on the keyboard along with playback of the other part.

**1. Enter the card mode and select the MIDI file you want to play.**

**2. Press the L-18 (PART SELECT) button.**

- This displays a “Part Select” screen like the one shown below, with the ● next to “Part L”.

```

-Part Select-
#Part L [ on ]
#Part R [ off ]
#SelectCh >Ent
  
```

**3. Use the R-17 (∧, ∨) buttons to move the ● between “Part L” (left-hand part) and “Part R” (right-hand part), and the dial or R-14 (–, +) buttons to turn the currently selected part on or off.**

**4. Use the R-17 (∨) button to move the ● to “SelectCh” and then press the R-16 (ENTER) button.**

- This causes the screen shown below to appear.

```

-Channel Select-
#Part L [B-03]
#Part R [B-04]
  
```

**5. Use the R-17 (∧, ∨) buttons to move the ● between “Part L” (left-hand part) and “Part R” (right-hand part), and the dial or R-14 (–, +) buttons to specify the MIDI channel for currently selected part.**

**6. Press the L-18 (PART SELECT) button to exit the part on/off screen.**

**7. To start playback, press the L-17 (PLAY/STOP) button.**

- This starts playback of the part you turned on in step 3.

**8. To stop playback, press the L-17 (PLAY/STOP) button.**

### NOTE

- The part on/off setting reverts to the initial default (both parts on) whenever you select a different music file.



## Playing on the Keyboard Along with Playback of a Music File on a memory card

You can perform the following operations and play on the keyboard along with playback of a music file on a memory card.

- Select UPPER 1 part, UPPER 2 part, and LOWER part tones.
- Specify layer, split on/off, and the split point

The procedures for performing these operations are the same as those performed in the rhythm mode. For details about the operation, see “Layering and Splitting Tones” (page E-15).

You also can use the procedure below to easily assign the same tone as the right-hand part or left-hand part of the music file to the keyboard (UPPER 1 part tone) for manual play.

### ■ To assign the same tone as the right-hand part or left-hand part of the music file to the keyboard

#### 1. Perform the procedure under “Turning Off One Hand Part and Playing the Other Hand Part on the Keyboard (Part Off)” (page E-109) to turn off the part you want to play on the keyboard.

- This step is not required if you want to play along on the keyboard while playing back both hand parts.

#### 2. While holding down the L-8 ([E] PIANO RHYTHMS) button, press the L-9 ([F] USER RHYTHMS) button.

- This assigns the tone of the part that is turned off to the UPPER 1 part.
- If both parts are on or off, the right-hand part of the music file is assigned to the UPPER 1 part.

#### 3. This starts playback of the music file. Play the part you want on the keyboard.

## To repeat play a specific section of a song

### 1. Enter the card mode and select the MIDI file you want to play.

### 2. Press the L-17 (PLAY/STOP) button to start playback.

### 3. When playback reaches the measure you want to specify as the repeat start point, press the L-13 (REPEAT) button.

- The **REPEAT** indicator will be flashing on the display.

### 4. When playback reaches the measure you want to specify as the repeat end point, press the L-13 (REPEAT) button.

- The **REPEAT** indicator will stop flashing and repeat playback of the measures within the range you specified in steps 3 and 4 will start.
- The repeat range is from the beginning of the measure you specified in step 3 to the end of the measure you specified in step 4.
- If you do not specify an end point, the end of the song will be the end point.

### 5. To stop playback, press the L-17 (PLAY/STOP) button.

- Pressing the L-17 (PLAY/STOP) button again will restart repeat playback using the same start and end points.
- The repeat range is cleared when you select a different music file.

## To change the playback tempo

See “To change the tempo setting” (page E-19).

## To adjust playback volume in accordance with keyboard play volume

See “SongVol. (Song Volume)” (page E-99). For information about how to configure settings, see “To change the setting of a function menu item” (page E-96).

## To sound a pre-count at the start of playback

See “PreCount (Song Pre-count Sound)” (page E-98). For information about how to configure settings, see “To change the setting of a function menu item” (page E-96).



## Error Messages

Display Message	Cause	Required Action
<b>Format</b>	<ol style="list-style-type: none"> <li>1. The current memory card format is not compatible with this Digital Keyboard.</li> <li>2. The memory card capacity is greater than 32GB.</li> <li>3. You are trying to use an SDXC card.</li> <li>4. There is something wrong with the memory card.</li> </ol>	<ol style="list-style-type: none"> <li>1. Format the memory card on the Digital Keyboard (page E-103).</li> <li>2. Use a memory card with a capacity of 32GB or less.</li> <li>3. SDXC cards not supported. Use an SD or SDHC memory card.</li> <li>4. Use a different memory card.</li> </ol>
<b>Card Full</b>	There is not enough room available on the memory card.	Delete some of the files on the memory card to make room for new data (page E-107), or use a different card.
<b>Card R/W</b>	Memory card data is corrupted.	Use a different memory card.
<b>No Card</b>	<ol style="list-style-type: none"> <li>1. The memory card is not loaded correctly in the Digital Keyboard's card slot.</li> <li>2. The memory card was removed while some operation was in progress.</li> </ol>	<ol style="list-style-type: none"> <li>1. Correctly load the memory card into the card slot.</li> <li>2. Do not remove the memory card while any operation is in progress.</li> </ol>
<b>No Data</b>	You tried to save a Digital Keyboard user area (user rhythm, user rhythm song, etc.) that does not contain any data to the memory card.	Select a user area that contains data.
<b>No File</b>	<ol style="list-style-type: none"> <li>1. There is no MUSICDAT folder (page E-105) on the memory card.</li> <li>2. There is no loadable or playable data in the MUSICDAT folder.</li> </ol>	<ol style="list-style-type: none"> <li>1. Create a MUSICDAT folder on the memory card or format the memory card on the Digital Keyboard (page E-103).</li> <li>2. Move the file you want to load or play into the memory card's MUSICDAT folder.</li> </ol>
<b>Not SMF0/1</b>	You are attempting to play back SMF Format 2 file.	This Digital Keyboard supports playback of SMF Format 0 or Format 1 only.
<b>Protect</b>	The memory card is write-protected.	Use the memory card's write protect switch to enable writing.
<b>Read Only</b>	A read-only file with the same name you are trying to use is already stored on the memory card.	<ul style="list-style-type: none"> <li>• Use a different name to save the new file.</li> <li>• Remove the read-only attribute from the existing file and overwrite it with the new file.</li> <li>• Use a different memory card.</li> </ul>
<b>Size Over</b>	<ol style="list-style-type: none"> <li>1. The data on the memory card is too big to play.</li> <li>2. The data you are trying to load is too large.</li> </ol>	<ol style="list-style-type: none"> <li>1. This Digital Keyboard supports playback of song data files with a maximum size of about 320KB.</li> <li>2. The following is the approximate maximum data sizes (per data item) when loading data into Digital Keyboard memory.            User rhythm: 32KB            Song sequencer song: 61KB            User preset: 8KB            A total of approximately 64KB of user presets (total of all 50 user presets) can be loaded.</li> </ol>
<b>Wrong Data</b>	<ol style="list-style-type: none"> <li>1. The memory card data is corrupted.</li> <li>2. The memory card contains data that is not supported by this Digital Keyboard.</li> </ol>	Use a different memory card.
<b>Meas. Limit</b>	You tried to perform an operation during song sequencer song editing or user music preset editing that would cause the number of measures in the song or chord progression to exceed 999.	Make sure your edits do not cause the number of measures to exceed the 999-measure limit.
<b>Memory Full</b>	<ol style="list-style-type: none"> <li>1. There is not enough memory capacity required for rhythm editor operations.</li> <li>2. Remaining memory capacity became too low during music preset editing.</li> <li>3. There is not enough memory capacity required for song sequencer operations.</li> </ol>	<ol style="list-style-type: none"> <li>1. Select the rhythm you want to use.</li> <li>2. Referring to "To clear user preset data" (page E-55), delete user presets you no longer need in order to free up memory.</li> <li>3. Delete other tracks and/or songs to free up memory space.</li> </ol>
<b>File Name</b>	When renaming a file on a memory card, attempting to specify a file name that is already used.	Use a different name.

# Connecting to a Computer

You can connect the Digital Keyboard to a computer and exchange MIDI data between them. You can send play data from the Digital Keyboard to music software running on your computer, or you can send MIDI data from your computer to the Digital Keyboard for playback.

## Minimum Computer System Requirements

The following shows the minimum computer system requirements for sending and receiving MIDI data. Check to make sure that your computer complies with these requirements before connecting the Digital Keyboard to it.

### • Operating System

Windows® XP (SP2 or later) \*1

Windows Vista® \*2

Windows 7® \*3

Mac OS® X (10.3.9, 10.4.11 or later, 10.5.8 or later, 10.6.3 or later)

\*1: Windows XP Home Edition

Windows XP Professional (32-bit)

\*2: Windows Vista (32-bit)

\*3: Windows 7 (32-bit, 64-bit)

### • USB port

## ! IMPORTANT!

- **Never connect to a computer that does not conform to the above requirements. Doing so can cause problems with your computer.**

## Connecting the Digital Keyboard to Your Computer

## ! IMPORTANT!

- **Make sure you follow the steps of the procedure below exactly. Connecting incorrectly can make data send and receive impossible.**

### 1. Turn off the Digital Keyboard and then start up your computer.

- Do not start up the music software on your computer yet!

### 2. After starting up your computer, use a commercially available USB cable to connect it to the Digital Keyboard.

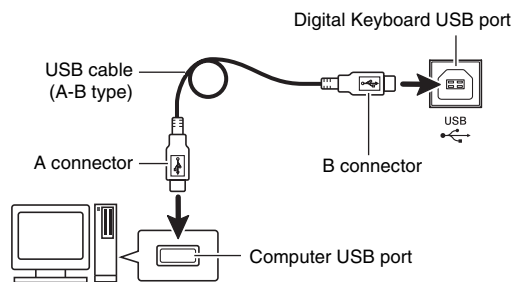

### 3. Turn on the Digital Keyboard.

- If this is the first time you are connecting the Digital Keyboard to your computer, the driver software required to send and receive data will be installed on your computer automatically.

### 4. Start up your computer's music software.

### 5. Configure the music software settings to select one of the following as the MIDI device.

CASIO USB-MIDI : (For Windows 7, Windows Vista, Mac OS X)

USB Audio Device : (For Windows XP)

- For information about how to select the MIDI device, see the user documentation that comes with the music software you are using.

## ! IMPORTANT!

- **Be sure to turn on the Digital Keyboard first before starting up your computer's music software.**

## NOTE

- Once you are able to connect successfully for the first time, there is no problem with leaving the USB cable connected when you turn off your computer and/or Digital Keyboard.
- You can alter the Digital Keyboard's MIDI setup by changing the MIDI data send channel or other settings. For details, see "MIDI Group" under "Function Menu Settings" (page E-97).
- For information about the relationship between each Digital Keyboard part (page E-39) and the MIDI IN and MIDI OUT channels, see "Assigning a MIDI Channel to Each Part" (page E-126).
- This Digital Keyboard conforms to General MIDI Level 1 (GM).
- For detailed specifications and connections that apply to MIDI data send and receive by this Digital Keyboard, see the latest support information provided by the website at the following URL.

<http://world.casio.com/>

## Storing and Loading Digital Keyboard Memory Data

You can transfer song sequencer songs, user rhythms, and other data in Digital Keyboard memory to a computer for storage. You also can load Auto Accompaniment data you download from the CASIO website to the Digital Keyboard, which greatly expands the Auto Accompaniment patterns available to you. A special Data Manager application is required in order to transfer data to and from the Digital Keyboard.

### Data Types Supported for Data Transfer Downloading Data Manager

The same types of data that you can store to or recall from a memory card (page E-102) can be transferred to and from the Digital Keyboard.

#### To download Data Manager

- 1. Go to the CASIO WORLDWIDE site at the following URL.**  
<http://world.casio.com/>
- 2. At the site, select a geographic area or country.**
- 3. After accessing the area site, navigate to the minimum computer system requirements for Data Manager for this product.**
  - You should be able to find a link to Data Manager information on the product introduction page of this product. If you cannot find such a link, use the search form of the area site where you are located to enter the model name of this product and search for it.
  - Note that site contents are subject to change without notice.
- 4. Check if your computer system complies with the minimum requirements for Data Manager.**
- 5. Download Data Manager and its user's guide to your computer.**
- 6. Follow the procedure in the user's guide that you downloaded in step 5 to install and use Data Manager.**
  - You can download accompaniment data from the Internet Data Expansion system of the CASIO MUSIC SITE (<http://music.casio.com/>) and load it into the memory of this Digital Keyboard. Note that there is not any accompaniment data intended specifically for this model, so you should use data for other models.

#### NOTE

- Since the accompaniment data is for other models, you may experience some abnormalities when playing it on this model.

## Troubleshooting

Symptom	Action
<b>Included Accessories</b>	
I can't find something that should be included with the product.	Carefully check inside all of the packing materials.
<b>Power Requirements</b>	
Power will not turn on.	<ul style="list-style-type: none"> <li>• Check the AC adaptor or make sure that the batteries are facing correctly (page E-9).</li> <li>• Replace the batteries with new ones or switch over to AC adaptor power (page E-9).</li> <li>• You may have tried to perform some operation while the "Please Wait" message was displayed, which caused an internal problem. If other measures do not correct this problem, perform the operation below to turn on power.</li> </ul> <p><b>Warning!</b> The following operation will delete all Digital Keyboard data and return all settings to their initial factory defaults.</p> <p>While holding down the <b>R-2 ([B] E.Piano)</b> and <b>R-5 ([E] BASS)</b> buttons, press the <b>L-1 (POWER)</b> button to turn on power.</p>
The Digital Keyboard outputs a loud sound and then suddenly powers down.	Replace the batteries with new ones or switch over to AC adaptor power (page E-9).
The Digital Keyboard suddenly powers down after a few minutes.	This happens when Auto Power Off (page E-13) is triggered.
<b>Display</b>	
The display keeps going out or is flashing.	Replace the batteries with new ones or switch over to AC adaptor power (page E-9).
Screen contents are visible only from straight ahead.	This is due to production limitations. It does not indicate malfunction.
<b>Sound</b>	
Nothing happens when I press any keyboard key.	<ul style="list-style-type: none"> <li>• Adjust the main volume setting (page E-13).</li> <li>• Check if something is plugged into the <b>T-4 (PHONES)</b> jack on the back of the Digital Keyboard.</li> <li>• Turn power off and then back on to initialize all keyboard settings (page E-13).</li> </ul>
Nothing happens or notes do not play normally when I play on the left side of the keyboard.	Press the <b>L-18 (ACCOMP ON/OFF)</b> button to disable chord input with chord keyboard (page E-24).
Nothing happens when I start an Auto Accompaniment.	<ul style="list-style-type: none"> <li>• With rhythms E:029 to E:038, nothing will sound until you play a chord on the keyboard. Try playing a chord (page E-26).</li> <li>• Check and adjust the accompaniment volume setting (page E-99).</li> <li>• If there is no user rhythm stored in memory, Auto Accompaniment will not start when you press the <b>L-17 (START/STOP)</b> button while a rhythm in the range of F:001 to F:010 is selected (page E-24).</li> <li>• Turn power off and then back on to initialize all Digital Keyboard settings (page E-13).</li> </ul>
The metronome does not sound.	<ul style="list-style-type: none"> <li>• Check and adjust the metronome volume setting (page E-99).</li> <li>• Turn power off and then back on to initialize all Digital Keyboard settings (page E-13).</li> </ul>

Symptom	Action
Notes keep sounding, without stopping.	<ul style="list-style-type: none"> <li>• Turn power off and then back on to initialize all Digital Keyboard settings (page E-13).</li> <li>• Replace the batteries with new ones or switch over to AC adaptor power (page E-9).</li> </ul>
Some notes are cut off while they are playing.	Notes are cut off whenever the number of notes being sounded exceeds the maximum polyphony value of 48 (24 for some tones). This does not indicate malfunction. See the separate “Appendix”.
The volume or tone setting I configured has changed.	<ul style="list-style-type: none"> <li>• Adjust the main volume setting (page E-13).</li> <li>• Turn power off and then back on to initialize all Digital Keyboard settings (page E-13).</li> <li>• Replace the batteries with new ones or switch over to AC adaptor power (page E-9).</li> </ul>
Output volume does not change even though I change my keyboard pressure.	<ul style="list-style-type: none"> <li>• Change the Touch Response setting (page E-97).</li> <li>• Turn power off and then back on to initialize all Digital Keyboard settings (page E-13).</li> </ul>
In certain keyboard ranges, the volume and tone quality sound are slightly different from those in other keyboard ranges.	This is due to system limitations. It does not indicate malfunction.
With some tones, octaves do not change at the far ends of the keyboard.	This is due to system limitations. It does not indicate malfunction.
The pitch of the notes does not match other accompanying instruments or sounds strange when played along with other instruments.	<ul style="list-style-type: none"> <li>• When the <b>TRANSPOSE</b> indicator is displayed, it means that the transpose setting (page E-18) has been used to change the pitch of the keyboard. Return the transpose setting to 00.</li> <li>• When the <b>SCALE</b> indicator is displayed, it means that the scale setting (page E-21) has been used to change the Digital Keyboard’s initial default setting. Use the procedure under “To select a preset scale” (page E-21) to change to the “Equal” preset scale. If the <b>SCALE</b> indicator remains on the display after you select “Equal”, use the dial or the <b>R-14 (-, +)</b> buttons to change to another preset scale other than “Equal” and then select “Equal” again.</li> <li>• Turn power off and then back on to initialize all Digital Keyboard settings (page E-13).</li> </ul>
The reverb of notes seems to change suddenly.	<ul style="list-style-type: none"> <li>• Check and adjust the reverb setting (page E-34).</li> <li>• Turn power off and then back on to initialize all Digital Keyboard settings (page E-13).</li> </ul>
<b>Operation</b>	
Tone, rhythm, and other settings revert to their initial defaults whenever you turn on the Digital Keyboard.	The Digital Keyboard may be configured to restore default settings (factory default settings or settings registered by you) when power is turned on. If you want the Digital Keyboard to remember its last setup and restore it the next time it is turned on, select “on” for the Auto Resume setting (page E-100).
<b>Computer Connection</b>	
I can’t exchange data between the Digital Keyboard and a computer.	<ul style="list-style-type: none"> <li>• Check to make sure that the USB cable is connected to the Digital Keyboard and computer, and that the device is selected correctly with your computer’s music software settings (page E-112).</li> <li>• Turn off the Digital Keyboard and then exit the music software on your computer. Next, turn the Digital Keyboard back on and then restart the music software on your computer.</li> </ul>

## Specifications

<b>Models</b>	CTK-6000 / WK-6500
<b>Keyboard</b>	CTK-6000: 61 standard-size keys WK-6500: 76 standard-size keys
Touch Response	2 types, Off
<b>Maximum Polyphony</b>	48 notes (24 for certain tones)
<b>Tones</b>	
Built-in Tones	670
User Tones	Up to 10 (Tone Editor)
Functions	Layer, Split
<b>Reverb</b>	1 to 10, Off
<b>Chorus</b>	1 to 5, Off
<b>DSP</b>	
Preset DSP	100
User DSP	Up to 100
<b>Metronome</b>	
Beats per Measure	0, 2 to 6
Tempo Range	30 to 255
<b>Auto Accompaniment</b>	
Built-in Rhythms	200
User Rhythms	Up to 10 (Rhythm Editor)
<b>Demo Songs</b>	5 songs
<b>Registration</b>	32 (4 setups × 8 banks)
<b>Song Sequencer</b>	Real-time recording, playback
Keyboard Play	5 songs, 17 tracks
Memory Capacity	Approximately 12,000 notes (total for 5 songs)
<b>Mixer</b>	32 parts (A01-A16/B01-B16) Master parameters, DSP parameters, Part parameters (CTK-6000/WK-6500) MIC parameters (WK-6500 only)
<b>Other Functions</b>	
Transpose	±1 octaves (-12 to +12 semitones)
Octave Shift	UPPER 1/UPPER 2/LOWER ±2 octaves
Tuning	A4 = 415.5 - 440.0 - 465.9Hz
Scale Tuning	Scale Fine Tune, Preset Scales
Music Preset	305 built-in, plus 50 user presets
One Touch Preset	200
Auto Harmonize	12 types
Arpeggiator	150 types
<b>MIDI</b>	16 multi-timbre received, GM Level 1 standard
<b>Pitch Bend Wheel</b>	
Pitch Bend Range	0 to 24 semitones
<b>Memory Cards</b>	
Supported Memory Cards	SD or SDHC memory cards, 32GB or less
Functions	SMF playback, file storage, file recall, file delete, card format

<b>Inputs/Outputs</b>	
USB port	TYPE B
Sustain/Assignable jack	Standard jack (sustain, sostenuto, soft, start/stop)
Phones jack	Stereo standard jack
Line Out R, L/MONO jacks	Standard jack × 2 Output Impedance: 2.3kΩ, Output Voltage: 1.5V (RMS) MAX
Audio In jack	Stereo mini jack Input Impedance: 9kΩ, Input Sensitivity: 200mV
Mic In jack (WK-6500 only)	Standard jack (connect a dynamic microphone only) Input Impedance: 3kΩ, Input Sensitivity: 10mV
<b>Power Jack</b>	12V DC
<b>Power Supply</b>	2-way
Batteries	6 D-size zinc-carbon batteries or alkaline batteries
Battery Life	Approximately 4 hours continuous operation on alkaline batteries
AC Adaptor	AD-A12150LW
Auto Power Off	Approximately 6 minutes after last key operation (during battery use), approximately 4 hours after last key operation (during AC adaptor use)
<b>Speakers</b>	12cm × 2 + 3cm × 2 (Output: 6.0W + 6.0W)
<b>Power Consumption</b>	12V --- 18W
<b>Dimensions</b>	CTK-6000: 94.5 × 37.8 × 13.2 cm (37 1/4 × 14 7/8 × 5 3/16 inch) WK-6500: 118.7 × 39.9 × 14.9 cm (46 3/4 × 15 3/4 × 5 7/8 inch)
<b>Weight</b>	CTK-6000: Approximately 5.8kg (12.8 lbs) (without batteries) WK-6500: Approximately 7.9kg (17.4 lbs) (without batteries)

- Design and specifications are subject to change without notice.

## Operating Precautions

Be sure to read and observe the following operating precautions.

### ■ Location

Avoid the following locations for this product.

- Areas exposed to direct sunlight and high humidity
- Areas subjected to temperature extremes
- Near a radio, TV, video deck, or tuner

The above devices will not cause malfunction of the product, but the product can cause interference in the audio or video of a nearby device.

### ■ User Maintenance

- Never use benzine, alcohol, thinner, or other chemical agents to clean the product.
- To clean the product or its keyboard, wipe with a soft cloth moistened in a weak solution of water and a mild neutral detergent. Wring all excess moisture from the cloth before wiping.

### ■ Included and Optional Accessories

Use only accessories that are specified for use with this product. Use of unauthorized accessories creates the risk of fire, electric shock, and personal injury.

### ■ AC Adaptor Handling Precautions

- Use a power outlet that is easily accessible so you can unplug the AC adaptor when a malfunction occurs or whenever else you need to do so.
- The AC adaptor is intended for indoor use only. Do not use it where it might be exposed to splashing or moisture. Do not place any container, such as a flower vase, that contains liquid on the AC adaptor.
- Store the AC adaptor in a dry place.
- Use the AC adaptor in an open, well-ventilated area.
- Never cover the AC adaptor with newspaper, a table cloth, a curtain, or any other similar item.
- Unplug the AC adaptor from the power outlet if you do not plan to use the product for a long time.
- Never try to repair the AC adaptor or modify it in any way.
- AC adaptor operating environment  
Temperature: 0 to 40°C  
Humidity: 10% to 90% RH
- Output polarity: 

### ■ Weld Lines

Lines may be visible on the exterior of the product. These are “weld lines” that result from the plastic molding process. They are not cracks or scratches.

### ■ Musical Instrument Etiquette

Always be aware of others around you whenever using this product. Be especially careful when playing late at night to keep the volume at levels that do not disturb others. Other steps you can take when playing late at night are closing windows and using headphones.



## DSP Effect List

### Preset DSP List

The table below shows the preset DSPs that can be selected by the procedure under “To use a DSP” (page E-36).

- The “Number” column shows DSP numbers, while the “Screen Name” shows the DSP name that appears on the display.
- The DSPs of this Digital Keyboard consist of the 46 “types” shown in the “DSP Type List” (page E-120). A preset DSP is a variation that is derived from one of these 46 types.

Number	Screen Name	Type Number
001	Comp 1	02
002	Comp 2	02
003	Enhance1	04
004	Enhance2	04
005	Phaser 1	07
006	Phaser 2	07
007	Phaser 3	07
008	Chorus 1	09
009	Chorus 2	09
010	Chorus 3	09
011	Chorus 4	09
012	Chorus 5	09
013	CmpCho 1	24
014	CmpCho 2	24
015	RefCho	41
016	Flanger1	08
017	Flanger2	08
018	Flanger3	08
019	Flanger4	08
020	CmpFln	25
021	Delay 1	10
022	Delay 2	10
023	Delay 3	10
024	Delay 4	10
025	Delay 5	10
026	Reflect1	11
027	Reflect2	11
028	Reflect3	11
029	CmpRef	26
030	ChoRef 1	36
031	ChoRef 2	36
032	ChoRef 3	36
033	FlnRef 1	38
034	FlnRef 2	38
035	FlnRef 3	38
036	Tremolo	6
037	CmpTrm	27
038	TrmRef	46
039	TrmCho 1	44
040	TrmCho 2	44
041	TrmFln 1	45
042	TrmFln 2	45
043	TrmDst 1	43
044	TrmDst 2	43
045	AutoPan	05
046	CmpPan	28
047	ChoPan 1	37
048	ChoPan 2	37
049	FlnPan 1	39
050	FlnPan 2	39

Number	Screen Name	Type Number
051	RefPan 1	42
052	RefPan 2	42
053	Rotary 1	12
054	Rotary 2	12
055	Rotary 3	12
056	Rotary 4	12
057	Rotary 5	12
058	Wah 1	01
059	Wah 2	01
060	Wah 3	01
061	Wah 4	01
062	CmpWah	22
063	WahCho 1	17
064	WahCho 2	17
065	WahFln 1	18
066	WahFln 2	18
067	WahDst 1	16
068	WahDst 2	16
069	WahTrm 1	20
070	WahTrm 2	20
071	WahPan 1	21
072	WahPan 2	21
073	WahRef 1	19
074	WahRef 2	19
075	WahCmp 1	15
076	WahCmp 2	15
077	Dist 1	03
078	Dist 2	03
079	Dist 3	03
080	DstCmp	30
081	CmpDst	23
082	DstTrm 1	34
083	DstTrm 2	34
084	DstPan 1	35
085	DstPan 2	35
086	DstCho 1	31
087	DstCho 2	31
088	DstFln 1	32
089	DstFln 2	32
090	DstFln 3	32
091	DstWah 1	29
092	DstWah 2	29
093	DstWah 3	29
094	DstWah 4	29
095	DstRef	33
096	RefDst	40
097	Lo-Fi	14
098	RingMod1	13
099	RingMod2	13
100	RingMod3	13

## DSP Type List

All of the Digital Keyboard's preset DSPs belong to one of the DSP types shown in the table below. When creating a user DSP (page E-37) or when using the tone editor (page E-45) to edit the DSP applied to a tone, you need to select one of the DSP types in the table.

- Type numbers 01 through 14 are single type DSPs, while numbers 15 through 46 are dual type DSPs. A single type DSP is one with a single structure, while a dual type is a combination of two single type DSPs.
- The name of a dual DSP is formed by its two constituent single DSP names, in the order that they are applied. For example, type 15 named "Wah-Compressor" connects in line to "Wah" and "Compressor", in that sequence.

Type Number	DSP Type Name	Screen Name
01	Wah	Wah
02	Compressor	Comp
03	Distortion	Dist
04	Enhancer	Enhance
05	AutoPan	AutoPan
06	Tremolo	Tremolo
07	Phaser	Phaser
08	Flanger	Flanger
09	Chorus	Chorus
10	Delay	Delay
11	Reflection	Reflect
12	Rotary	Rotary
13	RingModulator	RingMod
14	Lo-Fi	Lo-Fi
15	Wah-Compressor	WahCmp
16	Wah-Distortion	WahDst
17	Wah-Chorus	WahCho
18	Wah-Flanger	WahFln
19	Wah-Reflection	WahRef
20	Wah-Tremolo	WahTrm
21	Wah-AutoPan	WahPan
22	Compressor-Wah	CmpWah
23	Compressor-Distortion	CmpDst

Type Number	DSP Type Name	Screen Name
24	Compressor-Chorus	CmpCho
25	Compressor-Flanger	CmpFln
26	Compressor-Reflection	CmpRef
27	Compressor-Tremolo	CmpTrm
28	Compressor-AutoPan	CmpPan
29	Distortion-Wah	DstWah
30	Distortion-Compressor	DstCmp
31	Distortion-Chorus	DstCho
32	Distortion-Flanger	DstFln
33	Distortion-Reflection	DstRef
34	Distortion-Tremolo	DstTrm
35	Distortion-AutoPan	DstPan
36	Chorus-Reflection	ChoRef
37	Chorus-AutoPan	ChoPan
38	Flanger-Reflection	FlnRef
39	Flanger-AutoPan	FlnPan
40	Reflection-Distortion	RefDst
41	Reflection-Chorus	RefCho
42	Reflection-AutoPan	RefPan
43	Tremolo-Distortion	TrmDst
44	Tremolo-Chorus	TrmCho
45	Tremolo-Flanger	TrmFln
46	Tremolo-Reflection	TrmRef

- For details about parameters that can be configured with each DSP type, refer to the sections shown in the table below.

For information about this DSP type:	Go here:
Single type (Type numbers 01 through 14)	Single Type DSP Parameters (page E-121)
Dual type (Type numbers 15 through 46)	Dual Type DSP Parameters (page E-123)

## DSP Parameter List

### ■ Single Type DSP Parameters

#### 01: Wah

This is a “wah” effect that can automatically affect the frequency using an LFO.

##### Parameters and Value Ranges:

- 1 :Resonance (0 to 127)  
Adjusts the strength of resonance.
- 2 :Manual (0 to 127)  
Adjusts the wah filter reference frequency.
- 3 :LFO Rate (0 to 127)  
Adjusts the LFO rate.
- 4 :LFO Depth (0 to 127)  
Adjusts the LFO depth.
- 5 :LFO Waveform (off, sin, tri, random)  
Selects the LFO waveform.

#### 02: Compressor

Compresses the input signal, which can have the effect of suppressing level variation and make it possible to sustain dampened sounds longer.

##### Parameters and Value Ranges:

- 1 :Depth (0 to 127)  
Adjusts compression of the audio signal.
- 2 :Attack (0 to 127)  
Adjusts the attack amount of the input signal. A smaller value causes prompt compressor operation, which suppresses the attack of the input signal. A larger values delays compressor operation, which causes the attack of the input signal to be output as-is.
- 3 :Release (0 to 127)  
Adjusts the time from the point the input signal drops below a certain level until the compression operation is stopped. When an attack feeling is desired (no compression at the onset of sound), set this parameter to as low a value as possible. To have compression applied at all times, set a high value.
- 4 :Level (0 to 127)  
Adjusts the output level.
- 5 :Threshold (0 to 127)  
Adjusts the volume level at which the compression operation starts.

#### 03: Distortion

Digital distortion that applies an overtone to the input signal and distorts it.

##### Parameters and Value Ranges:

- 1 :Gain (0 to 127)  
Adjusts the input signal gain.
- 2 :Level (0 to 127)  
Adjusts the output level.

#### 04: Enhancer

Phase shifts low-range sounds and high-range sounds of the input signal to enhance their profiles.

##### Parameters and Value Ranges:

- 1 :Low Frequency (0 to 127)  
Adjusts the low range enhancer frequency.
- 2 :Low Phase (0 to 127)  
Adjusts the phase shift amount of the low-range enhancer.
- 3 :High Frequency (0 to 127)  
Adjusts the high range enhancer frequency.
- 4 :High Phase (0 to 127)  
Adjusts the phase shift amount of the high-range enhancer.

#### 05: Auto Pan

Performs continual left-right panning of the input signal using an LFO.

##### Parameters and Value Ranges:

- 1 :LFO Rate (0 to 127)  
Adjusts the panning rate.
- 2 :LFO Depth (0 to 127)  
Adjusts the panning depth.
- 3 :LFO Waveform (sin, tri)  
Selects the LFO waveform.

#### 06: Tremolo

Adjusts the volume of the input signal using an LFO.

##### Parameters and Value Ranges:

- 1 :LFO Rate (0 to 127)  
Adjusts the tremolo rate.
- 2 :LFO Depth (0 to 127)  
Adjusts the tremolo depth.
- 3 :LFO Waveform (sin, tri)  
Selects the LFO waveform.

#### 07: Phaser

Produces a distinctive pulsating, broad sound by using an LFO to change the phase of the input signal and then mixes it with the original input signal.

##### Parameters and Value Ranges:

- 1 :Resonance (0 to 127)  
Adjusts the strength of the resonance.
- 2 :LFO Rate (0 to 127)  
Adjusts the LFO rate.
- 3 :LFO Depth (0 to 127)  
Adjusts the LFO depth.
- 4 :LFO Waveform (sin, tri, random)  
Selects the LFO waveform.

### 08: Flanger

Applies wildly pulsating and metallic reverberation to sounds. LFO waveform is selectable.

**Parameters and Value Ranges:**

- 1 :LFO Rate (0 to 127)  
Adjusts the LFO rate.
- 2 :LFO Depth (0 to 127)  
Adjusts the LFO depth.
- 3 :LFO Waveform (sin, tri, random)  
Selects the LFO waveform.
- 4 :Feedback (0 to 127)  
Adjusts the strength of feedback.

### 09: Chorus

Gives sounds depth and breadth. Chorus type is selectable.

**Parameters and Value Ranges:**

- 1 :LFO Rate (0 to 127)  
Adjusts the LFO rate.
- 2 :LFO Depth (0 to 127)  
Adjusts the LFO depth.
- 3 :LFO Waveform (sin, tri)  
Selects the LFO waveform.
- 4 :Feedback (0 to 127)  
Adjusts the strength of feedback
- 5 :Type (mono, stereo, tri)  
Selects the chorus type.

### 10: Delay

Delays the input signal and feeds it back to create a repeating effect and give sounds more breadth.

**Parameters and Value Ranges:**

- 1 :Delay Time (0 to 127)  
Adjusts the delay time.
- 2 :Feedback (0 to 127)  
Adjusts the repeat of the delay.
- 3 :Ratio Lch (0 to 127)  
Adjusts the delay time of the left channel. This value is a ratio of the value specified for Delay Time.
- 4 :Ratio Rch (0 to 127)  
Adjusts the delay time of the right channel. This value is a ratio of the value specified for Delay Time.
- 5 :Wet Level (0, 1, 2, 3, 4, 5)  
Adjusts the level of the delay sound.
- 6 :Type (1, 2)  
Selects the delay type.
  - 1 :Delay repeat determined by Delay Time.
  - 2 :Delay repeat determined by Delay Time and Ratio L/R.

**Important!**

When adjusting the delay time and type, certain settings can result in a switching sound in the delay.

### 11: Reflection

An effector that extracts early reflections from reverb. Applies acoustic presence to sounds.

**Parameters and Value Ranges:**

- 1 :Type (1, 2, 3, 4, 5, 6, 7, 8)  
Selects from among the eight available reflection patterns.
- 2 :Feedback (0 to 127)  
Adjusts the repeat of the reflected sound.

### 12: Rotary

This is a rotary speaker simulator.

**Parameters and Value Ranges:**

- 1 :Overdrive Gain (0, 1, 2, 3)  
Adjusts overdrive gain.
- 2 :Overdrive Level (0 to 127)  
Adjusts the overdrive output level.
- 3 :Speed (Slow, Fast)  
Switches the speed mode between fast and slow.
- 4 :Brake (Rotate, Stop)  
Stops speaker rotation.
- 5 :Fall Acceleration (0 to 127)  
Adjusts acceleration when the speed mode is switched from fast to slow.
- 6 :Rise Acceleration (0 to 127)  
Adjusts acceleration when the speed mode is switched from slow to fast.
- 7 :Slow Rate (0 to 127)  
Adjusts the speaker rotation speed in the slow speed mode.
- 8 :Fast Rate (0 to 127)  
Adjusts the speaker rotation speed in the fast speed mode.

### 13: Ring Modulator

Multiplies the input signal with an internal oscillator signal to create a metallic sound.

**Parameters and Value Ranges:**

- 1 :OSC Frequency (0 to 127)  
Sets the reference frequency of the internal oscillator.
- 2 :LFO Rate (0 to 127)  
Adjusts the LFO rate.
- 3 :LFO Depth (0 to 127)  
Adjusts the LFO depth.
- 4 :Type (1, 2, 3)
  - 1 :Outputs the ring modulated signal only.
  - 2 :Outputs the ring modulated signal and the input signal.
  - 3 :Outputs a signal with a chorus effect applied to 2 (ring modulated signal and input signal).

## 14: Lo-Fi

Applies various types of noise to the input signal to reproduce a retro Lo-Fi sound.

Includes wow and flutter for rotational fluctuation like that in tapes and records, a Noise 1 generator that generates continual FM radio type, and a Noise 2 generator that generates record play types scratch noise.

### Parameters and Value Ranges:

- 1 :Wow and Flutter Rate (0 to 127)  
Adjusts the wow and flutter rate.
- 2 :Wow and Flutter Depth (0 to 127)  
Adjusts the wow and flutter depth.
- 3 :Noise1 Level (0, 1, 2, 3, 4, 5)  
Adjusts the level of Noise Generator 1.
- 4 :Noise2 Level (0, 1, 2, 3, 4, 5)  
Adjusts the level of Noise Generator 2.
- 5 :Noise2 Density (0, 1, 2, 3, 4, 5)  
Adjusts the frequency of Noise Generator 2.
- 6 :Bit (0, 1, 2, 3)  
Distorts the sound. A larger number produces greater distortion.

### Important!

Raising the noise level while a note is not sounding will cause noise to sound, even if there is no input signal.

## ■ Dual Type DSP Parameters

Dual type DSPs are configured by combining two different single type DSPs. Use the procedure below to determine what parameters that can be configured for each dual type DSP, and the operation, and setting ranges of dual type DSPs.

Example: Type number 29: Distortion-Wah

1. The DSP type name has two parts: a left side part and a right side part.  
Distortion-Wah → “Distortion” and “Wah”
2. Find out what parameters you can configure by looking up the left side part of a dual type DSP in the “Type Name” column of the table below.

Type Name	Configurable Parameters
Wah	LFO Waveform LFO Rate LFO Depth
Distortion	Gain Level
Chorus	LFO Waveform LFO Rate LFO Depth
Flanger	LFO Waveform LFO Rate LFO Depth
Reflection	Feedback
Compressor	Threshold Level
Auto Pan	LFO Waveform LFO Rate LFO Depth
Tremolo	LFO Waveform LFO Rate LFO Depth

3. Find the same type names in the table under “Single Type DSP Parameters” on pages E-121 through E-123, and note the operation and setting ranges of the items that are the same as those shown in the “Configurable Parameters” column of the above table.
  - In our “Distortion-Wah” example, the left side part of the name is “Distortion” so we can see in the above table that “Gain” and “Level” parameters can be configured. You can find out about the operations and setting ranges of “Gain” and “Level” by referring to “03: Distortion” on page E-121.
4. Next, repeat steps 2 and 3 above for the right side part of the dual type DSP parameter name.
  - The parameter numbers that appear on the parameter setting screen start from 1, and the number is incremented for each successive parameter. The parameter numbers of our “Distortion-Wah” example would be as shown below.
    - 1: Gain
    - 2: Level
    - 3: LFO Waveform
    - 4: LFO Rate
    - 5: LFO Depth

## Fingering Guide

### Fingered 1, Fingered 2 Chords

<b>C</b>	
<b>Cm</b>	
<b>Cdim</b>	
<b>Caug</b> *3	
<b>Csus4</b> *3	
<b>Csus2</b> *3	
<b>C7</b>	
<b>Cm7</b> *3	
<b>CM7</b>	
<b>Cm7<sup>b</sup>5</b> *3	
<b>C7<sup>b</sup>5</b> *3	
<b>C7sus4</b>	
<b>Cadd9</b>	
<b>Cmadd9</b>	
<b>CmM7</b>	
<b>Cdim7</b> *3	
<b>C69</b> *3	
<b>C6</b> *1 *3	
<b>Cm6</b> *2 *3	

\*1 With Fingered 2, interpreted as Am7.

\*2 With Fingered 2, interpreted as Am7<sup>b</sup>5.

\*3 Inverted form not supported in some cases.

### Fingered 3, Full Range Chords

In addition to the chords that can be fingered with Fingered 1 and Fingered 2, the following chords also are recognized.

$\frac{C\#}{C}$	$\frac{D}{C}$	$\frac{E}{C}$	$\frac{F}{C}$	$\frac{G}{C}$	$\frac{A^b}{C}$	$\frac{B^b}{C}$	$\frac{B}{C}$	$\frac{C\#m}{C}$	$\frac{Dm}{C}$	$\frac{Fm}{C}$
$\frac{Gm}{C}$	$\frac{Am}{C}$	$\frac{B^bm}{C}$	$\frac{Ddim}{C}$	$\frac{A^b7}{C}$	$\frac{F7}{C}$	$\frac{Fm7}{C}$	$\frac{Gm7}{C}$	$\frac{A^badd9}{C}$		

#### NOTE

- With Fingered 3, the lowest note fingered is interpreted as the base note. Inverted forms are not supported.
- With Full Range Chord, when the lowest note fingered is a certain distance from the neighboring note, the chord is interpreted as a fraction chord.
- Unlike Fingered 1, 2, and 3, Full Range Chord requires pressing of at least three keys to form a chord.

### Supported Input Characters

!	"	#	\$	%	&	'	(	)	
*	+	,	-	.	/	0	1	2	3
4	5	6	7	8	9	:	;	<	=
>	?	@	A	B	C	D	E	F	G
H	I	J	K	L	M	N	O	P	Q
R	S	T	U	V	W	X	Y	Z	[
¥	]	^	_	`	a	b	c	d	e
f	g	h	i	j	k	l	m	n	o
p	q	r	s	t	u	v	w	x	y
z	{		}	~					

## Chord Example List

Root Chord Type	C	C $\sharp$ /(D $\flat$ )	D	(D $\sharp$ )/E $\flat$	E	F	F $\sharp$ /(G $\flat$ )	G	(G $\sharp$ )/A $\flat$	A	(A $\sharp$ )/B $\flat$	B
M												
m												
dim												
aug												
sus4												
sus2												
7												
m7												
M7												
m7 $\sharp$ 5												
7 $\sharp$ 5												
7sus4												
add9												
madd9												
mM7												
dim7												
6/9												
6												
m6												

• Since the chord input range is limited, this model may not support some of the chords shown above.

## Assigning a MIDI Channel to Each Part

The following shows the relationship between MIDI IN and MIDI OUT channels and each part.

This part:	MIDI Channel		Part name
	IN	OUT	
A01	--	01 <sup>*1</sup>	Upper1
A02	--	02	Upper2
A03	--	03	Lower
A04	--	04	Harmo.
A05	--	05	System Upper1
A06	--	06	System Upper2
A07	--	07	System Lower
A08	--	--	Metronome
A09	--	09	Perc.
A10	--	10	Drum
A11	--	11	Bass
A12	--	12	Chord1
A13	--	13	Chord2
A14	--	14	Chord3
A15	--	15	Chord4
A16	--	16	Chord5

This part:	MIDI Channel		Part name
	IN	OUT	
B01	01	01	Track <sup>*2</sup> /MIDI 01
B02	02	02	Track <sup>*2</sup> /MIDI 02
B03	03	03	Track <sup>*2</sup> /MIDI 03
B04	04	04	Track <sup>*2</sup> /MIDI 04
B05	05	05	Track <sup>*2</sup> /MIDI 05
B06	06	06	Track <sup>*2</sup> /MIDI 06
B07	07	07	Track <sup>*2</sup> /MIDI 07
B08	08	08	Track <sup>*2</sup> /MIDI 08
B09	09	09	Track <sup>*2</sup> /MIDI 09
B10	10	10	Track <sup>*2</sup> /MIDI 10
B11	11	11	Track <sup>*2</sup> /MIDI 11
B12	12	12	Track <sup>*2</sup> /MIDI 12
B13	13	13	Track <sup>*2</sup> /MIDI 13
B14	14	14	Track <sup>*2</sup> /MIDI 14
B15	15	15	Track <sup>*2</sup> /MIDI 15
B16	16	16	Track <sup>*2</sup> /MIDI 16

\*1 The A01 part MIDI OUT channel depends on the keyboard channel setting. For details, see “KeyboardCh (Keyboard Channel)” (page E-99).

\*2 SONG SEQUENCER Track

### NOTE

- For details about parts, see “How Parts are Organized” (page E-39).



## Parameter List

To check this setting item:	Refer to this column in the table below:
Setting items that are always saved when power is turned off	①
Setting items stored in registration memory (page E-62)	②
When “on” is selected for the “AutoResume (Auto Resume)” setting (page E-100), setting items that are restored to those in effect the last time power was turned off	③
Items that are stored as “Default (Default Settings)” (page E-100)	④
Settings items initialized by the “To initialize all mixer parameters” operation (page E-41)	④
Setting items initialized when “Parameter” (parameter settings only) is selected by “Initialize (Initialize)” (page E-100)	⑤

Setting Item	①	②	③	④	⑤
<b>User Memory Items</b>					
User rhythms, user tones, user DSPs, user presets	○				
Registration	○				
<b>Function Menu Item</b>					
Tuning			○		○
Touch Response		○	○		○
Pitch Bend Velocity		○	○		○
Pedal Assign		○	○		○
Bend Range* <sup>1</sup>				○	○
Arpeggiator Hold		○	○		○
Arpeggiator Speed		○	○		○
Arpeggiator Part		○	○		○
Registration Filter (Accompaniment/Scale)					○
Song Pre-count Sound			○		○
Song Repeat Play			○		○
Auto Accompaniment Volume		○* <sup>2</sup>	○		○
Song Volume			○		○
Metronome Volume			○	○	○
Keyboard Channel			○		○
Local Control					○
Accompaniment MIDI Out					○
LCD Contrast	○				
Auto Power Off			○		○
Auto Recover	○				
<b>Other Items</b>					
Tone Number* <sup>1</sup>		○	○	○	○
Rhythm Number		○* <sup>2</sup>	○		○
Music Preset Number					○
Transpose		○	○		○
Split On/Off		○	○		○
Split Point		○	○		○
Layer On/Off		○	○		○
Octave Shift* <sup>3</sup>		○	○		○
Accompaniment On/Off		○* <sup>2</sup>	○		○
Chord Fingering Mode		○* <sup>2</sup>	○		○
Auto Harmonize On/Off/Type		○	○		○
Metronome Beat			○		○
Chorus/DSP					○
DSP Disable					○
Reverb (On, Off, Type)		○	○		○

Setting Item	①	②	③	④	⑤
Chorus Type		○	○		
DSP Type		○	○		○
Tempo		○* <sup>2</sup>	○		○
Synchro Standby		○* <sup>2</sup>			
Scale Preset Number			○		○
Scale Root			○		○
Scale Fine Tuning		○* <sup>4</sup>	○		○
Accompaniment Scale		○* <sup>4</sup>	○	○	○
Accompaniment Part On/Off		○* <sup>2</sup>	○	○	
Mode (Rhythm/Card) Selection Status			○		
Card Song number			○		
Left-hand Part Select					○
Right-hand Part Select					○
Registration Bank Number			○		○
Rhythm Category Number			○		○
Tone Category Number			○		○
Music Preset Category Number					○
<b>Mixer Settings for Part A01 through A04</b>					
Part On/Off* <sup>1</sup>			○	○	○
Part Volume* <sup>1</sup>		○	○	○	○
Part Pan* <sup>1</sup>		○	○	○	○
Part Coarse Tuning* <sup>1</sup>		○	○	○	○
Part Fine Tuning* <sup>1</sup>		○	○	○	○
Part Bend Range* <sup>1</sup>		○	○	○	○
Part DSP Line On/Off* <sup>1</sup>		○	○	○	○
Part Reverb Send* <sup>1</sup>		○	○	○	○
Part Chorus Send* <sup>1</sup>		○	○	○	○
Part Scale Enable* <sup>1</sup>			○	○	○
Mixer Settings for Master, DSP and MIC, and for Parts A05 through A16, and Parts B01 through B16				○	

\*1 Configured for each of the following parts: A01 through A04 (UPPER 1, UPPER 2, LOWER, Auto Harmonize).

\*2 Not recalled when “on” is selected for “RegFitAcmp” (page E-98).

\*3 Configured for each of the following parts: A01 through A03 (UPPER 1, UPPER 2, LOWER).

\*4 Not recalled when “on” is selected for “RegFitScal” (page E-98).

# MIDI Implementation Chart

Function	Transmitted	Recognized	Remarks
<b>Basic Channel</b> Default Changed	1 - 16 1 - 16	1 - 16 1 - 16	
<b>Mode</b> Default Messages Altered	Mode 3 X * * * * * * * * * *	Mode 3 X * * * * * * * * * *	
<b>Note Number</b> True voice	0 - 127 * * * * * * * * * *	0 - 127 0 - 127 *1	
<b>Velocity</b> Note ON Note OFF	0 9nH v = 1 - 127 X 9nH v = 0	0 9nH v = 1 - 127 X 9nH v = 0, 8nH V = **	** : no relation
<b>After Touch</b> Key's Ch's	X X	X O	
<b>Pitch Bender</b>	O	O	
<b>Control Change</b> 0 1 6, 38 7 10 11 16 17 18 19 64 66 67 72 73	O X *2 O *2 O O O O X O O O O O O *3 O *3 O *3 O O O O	O O *2 O	Bank select Modulation Data entry LSB, MSB Volume Pan Expression DSP Parameter0 DSP Parameter1 DSP Parameter2 DSP Parameter3 Hold 1 Sostenuto Soft pedal Release time Attack time

74 76 77 78 80 81 82 85 91 93 98,99 100,101		O O O O O O O O O O O *2 O *2		O O O O O O O O O O O *2 O *2	Filter cutoff Vibrato rate Vibrato depth Vibrato delay DSP Parameter4 DSP Parameter5 DSP Parameter6 DSP Parameter7 Reverb send Chorus send NRPN LSB, MSB RPN LSB, MSB
<b>Program Change</b>	: True #	O 0 - 127 * * * * * * * * *	O 0 - 127	O 0 - 127	
<b>System Exclusive</b>		O *2	O *2	O *2	
<b>System Common</b>	: Song Pos : Song Sel : Tune	X X X		X X X	
<b>System Real Time</b>	: Clock : Commands	O O		X X	
<b>Aux Messages</b>	: All sound off : Reset all controller : Local ON/OFF : All notes OFF : Active Sense : Reset	X O X O X X		O O X O O X	
<b>Remarks</b>		*1: Depends on tone. *2: For details about NRPN, RPN, and system exclusive messages, see MIDI Implementation at <a href="http://world.casio.com/">http://world.casio.com/</a> . *3: In accordance with pedal effect setting.			

Mode 1 : OMNI ON, POLY  
Mode 3 : OMNI OFF, POLY

Mode 2 : OMNI ON, MONO  
Mode 4 : OMNI OFF, MONO

O : Yes  
X : No



This recycle mark indicates that the packaging conforms to the environmental protection legislation in Germany.

**CASIO®**