

## V-Hi-Hat **VH-11**

# Owner's Manual

We'd like to take a moment to thank you for purchasing the Roland V-Hi-Hat VH-11.

**When using the VH-11, you will need to make the settings for the sound module. Refer to p. 6 or p. 8.**

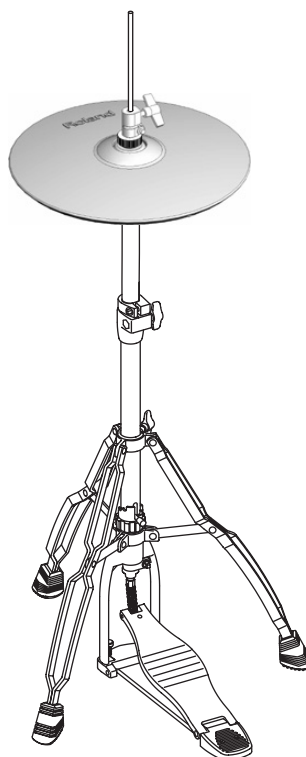



\* **Hi-hat stand is not included.**



*For details on compatible stands, refer to p. 9.*

**Before using this unit, carefully read the sections entitled: "USING THE UNIT SAFELY" and "IMPORTANT NOTES" (p. 2; p. 3). These sections provide important information concerning the proper operation of the unit. Additionally, in order to feel assured that you have gained a good grasp of every feature provided by your new unit, Owner's manual should be read in its entirety. The manual should be saved and kept on hand as a convenient reference.**







# USING THE UNIT SAFELY

## INSTRUCTIONS FOR THE PREVENTION OF FIRE, ELECTRIC SHOCK, OR INJURY TO PERSONS

About  WARNING and  CAUTION Notices

 <b>WARNING</b>	Used for instructions intended to alert the user to the risk of death or severe injury should the unit be used improperly.
 <b>CAUTION</b>	Used for instructions intended to alert the user to the risk of injury or material damage should the unit be used improperly. * Material damage refers to damage or other adverse effects caused with respect to the home and all its furnishings, as well to domestic animals or pets.

About the Symbols

	The  symbol alerts the user to important instructions or warnings. The specific meaning of the symbol is determined by the design contained within the triangle. In the case of the symbol at left, it is used for general cautions, warnings, or alerts to danger.
	The  symbol alerts the user to items that must never be carried out (are forbidden). The specific thing that must not be done is indicated by the design contained within the circle. In the case of the symbol at left, it means that the unit must never be disassembled.
	The  symbol alerts the user to things that must be carried out. The specific thing that must be done is indicated by the design contained within the circle. In the case of the symbol at left, it means that the power-cord plug must be unplugged from the outlet.

### ALWAYS OBSERVE THE FOLLOWING

#### **WARNING**

- Before using this unit, make sure to read the instructions below, and the Owner's Manual. 



---

- Do not open or perform any internal modifications on the unit. 

---

- Do not attempt to repair the unit, or replace parts within it (except when this manual provides specific instructions directing you to do so). Refer all servicing to your retailer, the nearest Roland Service Center, or an authorized Roland distributor, as listed on the "Information" page. 



---

- Never use or store the unit in places that are:
  - Subject to temperature extremes (e.g., direct sunlight in an enclosed vehicle, near a heating duct, on top of heat-generating equipment); or are 
  - Damp (e.g., baths, washrooms, on wet floors); or are 
  - Humid; or are
  - Exposed to rain; or are
  - Dusty; or are
  - Subject to high levels of vibration.

---

- Make sure you always have the unit placed so it is level and sure to remain stable. Never place it on stands that could wobble, or on inclined surfaces. 

---

- Do not allow any objects (e.g., flammable material, coins, pins); or liquids of any kind (water, soft drinks, etc.) to penetrate the unit.   



#### **WARNING**

- In households with small children, an adult should provide supervision until the child is capable of following all the rules essential for the safe operation of the unit. 

---

- Protect the unit from strong impact. (Do not drop it!) 

#### **CAUTION**

- Try to prevent cords and cables from becoming entangled. Also, all cords and cables should be placed so they are out of the reach of children. 

---

- Never climb on top of, nor place heavy objects on the unit. 

---

- Install the unit only on the hi-hat stand which satisfies the specifications described on p. 9. 

---

- Should you remove bolts, keep them in a safe place out of children's reach, so there is no chance of them being swallowed accidentally. 

---

- Be careful not to allow your fingers or hands to be caught between the hi-hat and motion sensor unit. 

# IMPORTANT NOTES

In addition to the items listed under “USING THE UNIT SAFELY” on page 2, please read and observe the following:

## Placement

- Do not expose the unit to direct sunlight, place it near devices that radiate heat, leave it inside an enclosed vehicle, or otherwise subject it to temperature extremes. Excessive heat can deform or discolor the unit.
- When moved from one location to another where the temperature and/or humidity is very different, water droplets (condensation) may form inside the unit. Damage or malfunction may result if you attempt to use the unit in this condition. Therefore, before using the unit, you must allow it to stand for several hours, until the condensation has completely evaporated.
- Do not allow rubber, vinyl, or similar materials to remain on the unit for long periods of time. Such objects can discolor or otherwise harmfully affect the finish.

## Maintenance

- For everyday cleaning wipe the unit with a soft, dry cloth or one that has been slightly dampened with water. To remove stubborn dirt, use a cloth impregnated with a mild, non-abrasive detergent. Afterwards, be sure to wipe the unit thoroughly with a soft, dry cloth.
- Never use benzene, thinners, alcohol or solvents of any kind, to avoid the possibility of discoloration and/or deformation.

## Additional Precautions

- Use a reasonable amount of care when using the unit’s buttons, sliders, or other controls; and when using its jacks and connectors. Rough handling can lead to malfunctions.
- When connecting / disconnecting all cables, grasp the connector itself—never pull on the cable. This way you will avoid causing shorts, or damage to the cable’s internal elements.
- To avoid disturbing your neighbors, try to keep the unit’s volume at reasonable levels. You may prefer to use headphones, so you do not need to be concerned about those around you (especially when it is late at night).

- This instrument is designed to minimize the extraneous sounds produced when it’s played. However, since sound vibrations can be transmitted through floors and walls to a greater degree than expected, take care not to allow these sounds to become a nuisance to neighbors, especially when performing at night and when using headphones.
- When you need to transport the unit, package it in the box (including padding) that it came in, if possible. Otherwise, you will need to use equivalent packaging materials.
- The hi-hat stand is supported by means of a tripod. When installing the hi-hat, make sure the legs of the tripod are opened wide enough to keep the equipment from falling over.
- The hi-hat’s rubber surface may turn white, but this has no effect on the hi-hat’s function.
- Do not remove the special VH-11 clutch from the hi-hat or disassemble the clutch.
- When not using the hi-hat for extended periods, store the hi-hat in the open position to prevent placing any stress on the motion sensor unit.
- High-precision sensors are located at the portion of the motion sensor unit indicated by the arrow in the left figure below. Take care not to subject this area to excessive shock, and do not allow any foreign objects to enter any gaps.

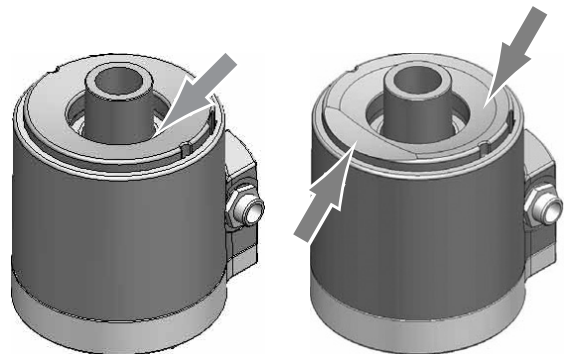

- Over long periods of use, the portion of the motion sensor unit that comes into contact with the hi-hat (the damper) may become worn at the points indicated by the arrows in the right figure above. Such damper wear may prevent proper adjustment of the offset and may cause the hi-hat to swing with an unnatural motion. If this occurs, replace the damper. For more information on replacing the damper, contact Roland Service.



This product complies with the requirements of European Directive 89/336/EEC.

For EU Countries

# Getting Started

## Features

### Similar Touch and Feel as with an Acoustic Hi-Hat

The VH-11 is constructed with one floating cymbal, making it compatible with commercially available hi-hat stands and providing the same feel as you get from an acoustic hi-hat, including the stick rebound, the looseness of the cymbal when you strike it, and the vertical action of the cymbal when you press and release the pedal.

### Smooth Transition Between Closed and Open Tones

When you strike the pad while gradually opening the pedal, the tone smoothly opens in response to how much the pedal is opened.

### Allows Foot Splashes

You can play foot splashes by pressing the pedal and then instantly opening it.

### Quick-Open Tone Changes

With the VH-11 connected to a TD-20/12 sound module, you can get realistic tonal changes by hitting the closed hi-hat and immediately opening it.

### Dual Trigger Capability

Sensors in both the top and edge portion make it possible to get different sounds by striking the bow (upper surface) and the edge (p. 9).

### Natural-Feeling Action

You can achieve just the pedal feel you like by adjusting the pressure put on the pedal and the tension of the hi-hat stand spring.

### They're Quiet!

Rubber is used on the striking surface for a damping effect.

### Compatible with Commercially Available Hi-Hat Stands (p. 9)

## Regarding the VH-11's Compatibility

Sound Module	Compatibility
TD-20	Completely Compatible
TD-12	Completely Compatible
TD-10 + TDW-1	Compatible
TD-8	Compatible
TD-6V, TD-6	Compatible

**Completely Compatible:** Tone changes more naturally from open to closed.

**Compatible:** Although you can control the opening and closing, the expression of the half-open hi-hat differs from that achieved with the completely compatible TD-20/12.

## Package Contents

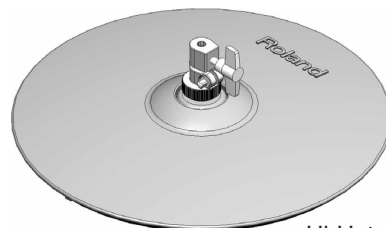

Hi-Hat

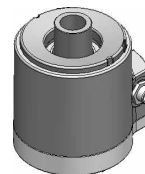

Motion Sensor Unit

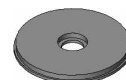

Insulating Plate



Cable Tie



Tuning Key

# Mounting on the Hi-Hat Stand

## 1. Remove the clutch included with the hi-hat stand from the cymbal rod.

- \* The clutch included with the hi-hat stand will not be used.
- \* It is not necessary to remove the felt (or rubber) pad on the hi-hat stand used for supporting the bottom cymbal.

## 2. Confirm that the cymbal rod is firmly secured.

For instructions on tightening the cymbal rod, refer to the owner's manual for your cymbal stand.

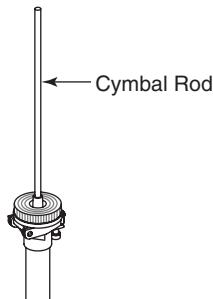

- \* Looseness or play in the cymbal rod can make the top hi-hat unstable, causing it to shake or turn, and prevent proper functioning.

## 3. Place the insulating plate on the hi-hat stand with the cymbal rod passing through the hole of the insulating plate.

Set the insulating plate with the sponge side facing up.

## 4. Place the motion sensor unit on the insulating plate with the cymbal rod passing through the hole of the motion sensor unit.

Position the CONTROL OUT jack on the farther side, as viewed from the player.

## 5. Loosen the clutch screw and place the hi-hat on the motion sensor unit with the cymbal rod passing through the hi-hat hole.

Position the "Roland" logo on the farther side, as viewed from the player.

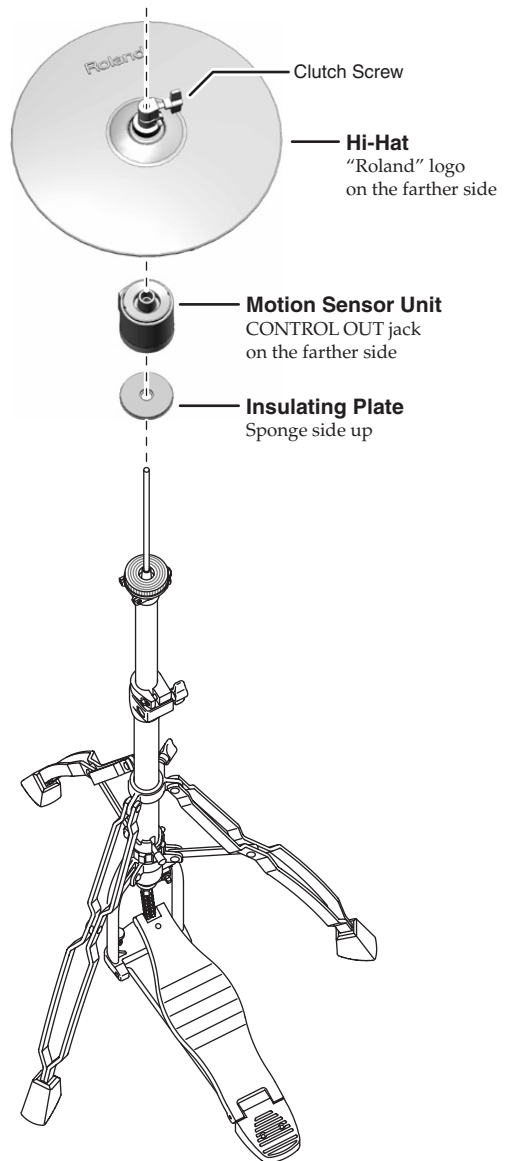

# Connecting and Adjusting

## Connecting to a Sound Module

\* To prevent malfunction and/or damage to speakers or other devices, always turn down the volume, and turn off the power on all devices before making any connections.

1. Connect the VH-11's TRIGGER OUT jack to the sound module's TRIGGER INPUT HI-HAT jack, and the VH-11's CONTROL OUT jack to the sound module's HH CTRL jack.

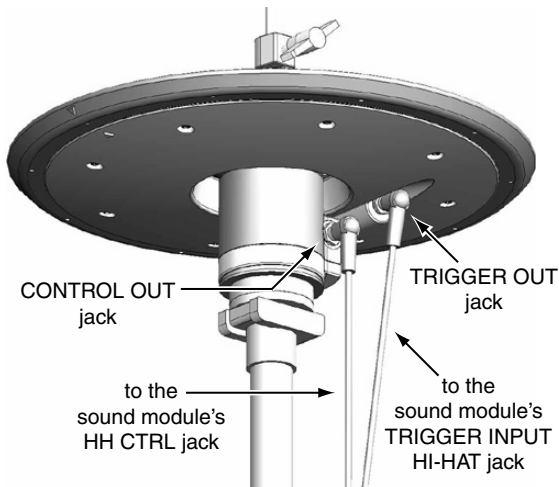

\* Use stereo (TRS) cables to make the connections. If monaural cables are used, edge shots cannot be supported.

2. Secure the cables in place with the cable tie, while leaving some slack in the cables.

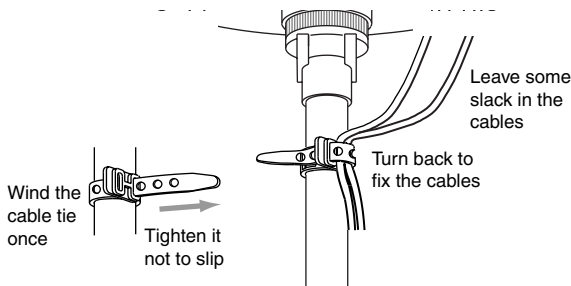

## Adjusting the Sound Module TD-12 and VH-11's Offset

The VH-11's offset needs to be adjusted to ensure proper expression of the hi-hat's opening and closing. Perform this adjustment while the sound module is connected.

### Using the TD-12

This section describes the adjustment procedure when the VH-11 is used with a TD-12.



Refer to p. 8 if you are using a different sound module.

1. Confirm that the VH-11 and TD-12 are connected properly.
2. After making the hi-hat settings, release your foot from the pedal, and while keeping your foot off the pedal, turn on the power to the TD-12.

\* The offset cannot be adjusted correctly if the hi-hat is making contact with the motion sensor unit when the power is turned on.

3. Loosen the clutch screw and let the hi-hat rest naturally on the motion sensor unit.
4. Press the TD-12's [TRIGGER] button, then press the [F1 (BANK)] button.

The "TRIGGER BANK" screen appears.

5. Press the [CURSOR] buttons to move the cursor to the trigger type for TRIGGER INPUT 6.
6. Use the [+/-] buttons or the [VALUE] dial to select "VH11."



**7. Press the [F3 (HI-HAT)] button.**

The "TRIGGER HI-HAT" screen appears.



**8. Confirm the TD-12's settings.**

Parameter	Value
Hi-Hat Type	VH11/FD
CC Max	90
CC Resolution	NORMAL

**9. While reading the meter displayed on the right side of the TD-12's screen, adjust the offset with the VH-11's VH offset adjustment screw.**

Adjust the offset so that a black ►◄ appears in the meter.

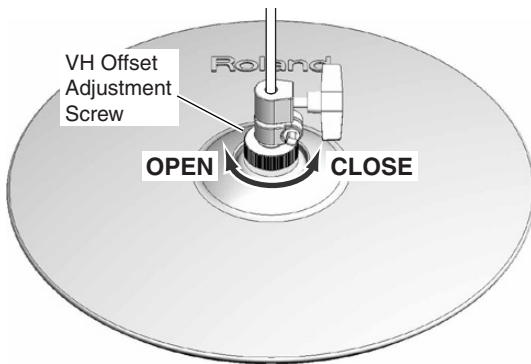

**VH Offset Adjustment Points**

If the closed hi-hat sound is difficult to attain, rotate the VH offset adjustment screw towards "CLOSE."

If the open hi-hat sound is difficult to attain, rotate the screw towards "OPEN."

**NOTE**

If the sound cuts off when you strike the hi-hat forcefully, rotate the VH offset adjustment screw towards "OPEN."

**Adjusting the Hi-Hat**

- 1. Adjust the gap between the metal portion in the center of the lower hi-hat and the sensor's center tip to a clearance of approximately 3 mm, then tighten the clutch screw.**

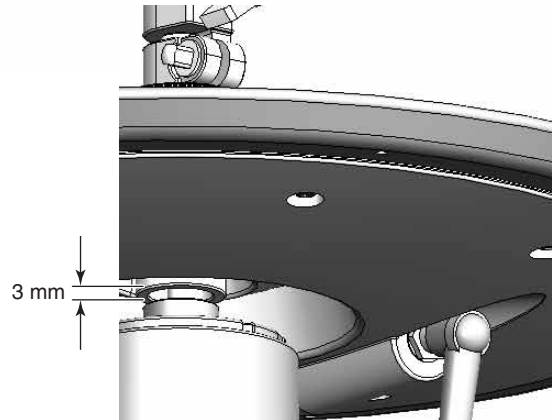

\* Although the gap can be adjusted to a clearance that makes playing the hi-hat easier, setting too narrow or wide a gap can cause improper function of the unit and prevent the hi-hat from sounding as you intend. Setting the gap to **3 mm** provides the most natural feel when playing the VH-11.

- 2. Change the spring tension by adjusting the hi-hat stand.**

For instructions on adjusting the tension, refer to the owner's manual for your hi-hat stand.

\* The tension may not be adjustable on some stands.

**NOTE**

When performing, make sure that the name "Roland" on the hi-hat is on the opposite side of the stand from the hi-hat pedal (p. 5).

# Adjusting the Other Sound Module and VH-11's Offset

## Using the TD-20

\* If "VH11" is available as a Trigger Type setting on the TD-20 you are using, follow the instructions in **Using the TD-12** (p. 6) to set the TD-20 and adjust the VH-11's offset.

1. Confirm that the VH-11 and TD-20 are connected properly.
  2. After making the hi-hat settings, release your foot from the pedal, and while keeping your foot off the pedal, turn on the power to the TD-20.
- \* The offset cannot be adjusted correctly if the hi-hat is making contact with the motion sensor unit when the power is turned on.
3. Loosen the clutch screw and let the hi-hat rest naturally on the motion sensor unit.
  4. Press the TD-20's [TRIGGER] button.
  5. Press the [F1 (BANK)], [F2 (BASIC)], and [F3 (HI-HAT)] buttons, and make the TD-20's settings.

For details, refer to the TD-20 owner's manual.

Button	Parameter	Value
[F1 (BANK)]	Trigger Type	VH12
[F2 (BASIC)]	Sensitivity	10
	Threshold	6
[F3 (HI-HAT)]	Hi-Hat Ctrl Type	FD
	CC Max	90
	CC Resolution	NORMAL

6. Adjust the offset by rotating the VH-11's VH offset adjustment screw. See the column below.

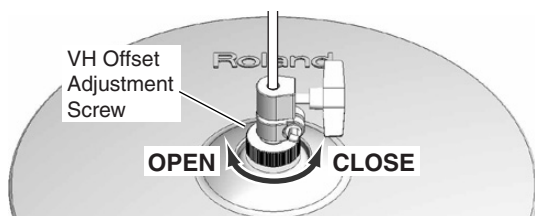

## How to Adjust the VH Offset

- Adjust until you are satisfied with the correspondence between the hi-hat's opening and closing action and the change in tone.
- If the closed hi-hat sound is difficult to attain, rotate the VH offset adjustment screw towards "CLOSE." If the open hi-hat sound is difficult to attain, rotate the screw towards "OPEN."

## Using the TD-10+TDW-1 / TD-8/TD-6V/TD-6

1. Confirm that the VH-11 and the sound module are connected properly.
  2. After making the hi-hat settings, release your foot from the pedal, and while keeping your foot off the pedal, turn on the power to the sound module.
- \* The offset cannot be adjusted correctly if the hi-hat is making contact with the motion sensor unit when the power is turned on.
3. Loosen the clutch screw and let the hi-hat rest naturally on the motion sensor unit.
  4. Make the sound module's settings.

For details, refer to the owner's manual supplied with the sound module.

Parameter	Value		
	TD-10 + TDW-1	TD-8	TD-6V/6
Trigger Type	HH	CY1/PD7	CY Type
Sensitivity	6	10	10
Threshold	6	4	4
Curve	Linear	LINEAR	LINEAR
Scan Time	2.0	2.5	2.5
Retrigger Cancel	4	8	8
Mask Time	8	8	8
Xtalk Cancel	20	20	20
Mount Type	CymMount	-	-

5. Adjust the offset by rotating the VH-11's VH offset adjustment screw. See the column below.

## Notes to Observe When Using the TD-10+TDW-1, TD-8, and TD-6V/6

Do not turn on the power to the sound module with the hi-hat in the closed position; this may cause faulty operation. Make sure the hi-hat is open when turning on the power.

### NOTE

If the sound cuts off when you strike the hi-hat forcefully, rotate the VH offset adjustment screw towards "OPEN."



# Playing Methods

## Open/Closed

The hi-hat tone changes smoothly and continuously from open to closed in response to how far the pedal is pressed. You can also play the foot closed sound (playing the hi-hat with the pedal completely pressed down) and foot splash sound (playing the hi-hat with the pedal fully pressed and then instantly opening it).

## Bow Shot

This playing method involves striking the middle area of the hi-hat. It corresponds to the sound of the "head-side" of the connected trigger input.

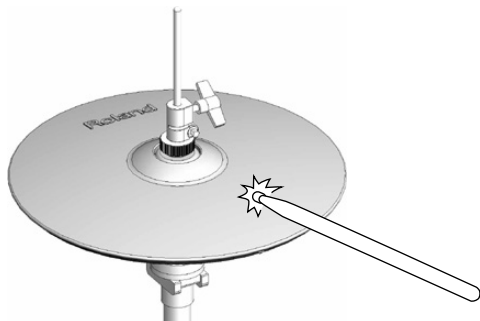

## Edge Shot

This playing method involves striking the edge of the hi-hat with the shoulder of the stick. When played as shown in the figure, the "rim-side" sound of the connected trigger input is triggered.

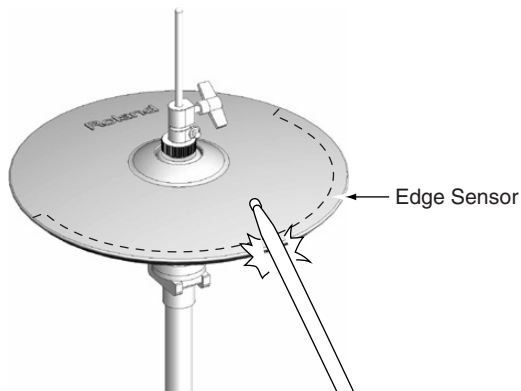

### NOTE

Position the "Roland" logo on the farther side, as viewed from the player (p. 5).

# Specifications

Size:	12 inches
Trigger:	2 (Bow / Edge)
Connectors:	TRIGGER OUT Jack CONTROL OUT Jack
Dimensions:	314 (W) x 314 (D) x 154 (H) mm 12-3/8 (W) x 12-3/8 (D) x 6-1/16 (H) inches
Weight:	1.7 kg / 3 lbs 12 oz
Options:	Owner's Manual, Connection Cable, Tuning Key, Cable Tie, Insulating Plate

\* In the interest of product improvement, the specifications and/or appearance of this unit are subject to change without prior notice.

## Compatible Stand

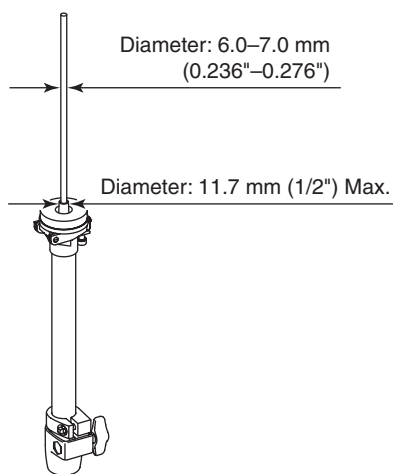

# Troubleshooting

## No sound is heard

### Is the TRIGGER OUT connected to the sound module's HH CTRL jack?

Connect the VH-11's TRIGGER OUT jack to the sound module's HI-HAT jack, and the CONTROL OUT to the sound module's HH CTRL (p. 6).

## The sound does not change when an edge shot is made

### Is a monaural cable being used?

When a monaural cable is used, the sound does not change when an edge shot is made.

Use a stereo (TRS) cable.

### Are you striking the area where an edge sensor is located?

The VH-11 has an edge sensor only at the area closest to you, at the front (p. 9).

Position the "Roland" logo on the farther side, as viewed from the player (p. 5).

## Foot splashes difficult to produce

If you are using the TD-12/20 as your sound module, adjust the "Foot Splash Sens."

If you are using the TD-10/8/6V/6 or other sound module, adjust the VH-11's offset, the stand, the hi-hat clearance, and/or the pedal spring tension until the foot splash sound is easy to produce.

## Sounds cut out

### Have you adjusted the VH-11's offset?

Adjust the offset by rotating the VH-11's VH offset adjustment screw (p. 7, p. 8).

- Sounds may cut out when the hi-hat is struck forcefully if the screw is turned too far in the "CLOSE" direction.
- The offset may change somewhat as you perform.
- Your particular stand may require even further adjustment.

## Unable to control opening and closing

### Have you adjusted the VH-11's offset?

Adjust the offset by rotating the VH-11's VH offset adjustment screw (p. 7, p. 8).

- The VH-11's offset needs to be adjusted to ensure proper expression of the hi-hat's opening and closing. Adjust until you are satisfied with the correspondence between the hi-hat's opening and closing action and the change in tone.
- The offset may change somewhat as you perform.
- Your particular stand may require even further adjustment.

### Is the sound module set correctly?

If you are using a TD-12 or TD-20, confirm the sound module's settings.

- If you have the TD-12 sound module connected → p. 7
- If you have the TD-20 sound module connected → p. 8

### Is the hi-hat open when turning on the power?

When using the TD-10+TDW-1, TD-8, and TD-6V/6, turning on the power to the sound module with the hi-hat in the closed position may cause faulty operation.

## Sounds are not triggering properly

### Is the trigger type set correctly?

Make the trigger parameter settings for your sound module (p. 6, p. 8).

### Is the direction of the hi-hat correct?

Position the "Roland" logo on the farther side, as viewed from the player (p. 5).

### Are you using the special VH-11 clutch?

Clutches included with hi-hat stands are shaped differently than the VH-11's special clutch, so use of such other clutches prevent the sensors within the VH-11 from functioning properly. Be sure to use the clutch designed especially for the VH-11.

# If the Clutch Was Apart from the Hi-Hat

If the hi-hat clutch is inadvertently removed from the hi-hat, use the following procedure to reassemble and attach the clutch.

## NOTE

Due to the different shape, the clutch included with the hi-hat stand cannot be used with the VH-11. Be sure to use the special VH-11 clutch.

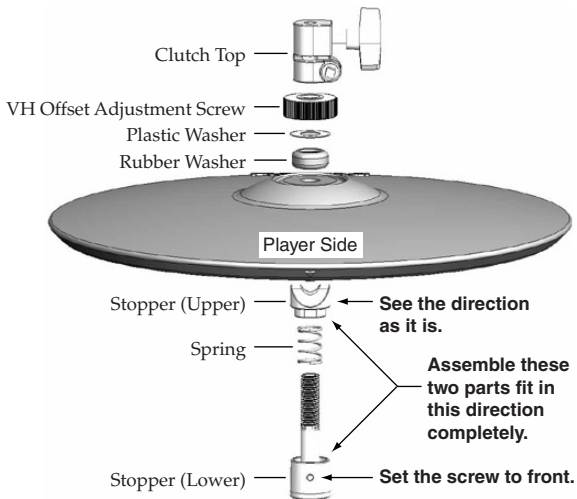

\* Orient the stopper (upper) so that it matches the groove in the hi-hat.

## Hi-Hat Being Properly Assembled

