

# CRATE®

## V-SERIES TUBE AMPLIFIERS

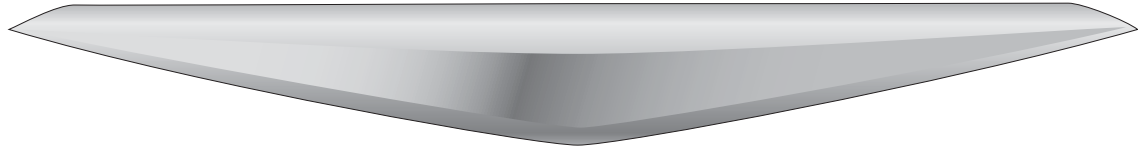

### **V33H** Tube Guitar Amplifier with Reverb



**CRATE®**

**Owner's Manual**

## TABLE OF CONTENTS

Introduction .....	3
The Front Panel .....	4
The Rear Panel .....	5
Important Information About Tubes and Tube Products .....	6
A Brief History of Tubes .....	6
Tube Types and Usage .....	6
The Nature of Tubes: Why (and When) to Replace Them ....	7
The Importance of Proper Biasing .....	8
Survival Tips for Tube Amplifiers .....	9
Some Suggested Settings .....	10
System Block Diagram .....	11
Technical Specifications .....	12
Service Information .....	12

	<b>CAUTION</b> RISK OF ELECTRIC SHOCK DO NOT OPEN	
<small>WARNING: TO REDUCE THE RISK OF FIRE OR ELECTRIC SHOCK, DO NOT EXPOSE THIS APPARATUS TO RAIN OR MOISTURE. TO REDUCE THE RISK OF ELECTRIC SHOCK, DO NOT REMOVE COVER. NO USER-SERVICEABLE PARTS INSIDE. REFER SERVICING TO QUALIFIED SERVICE PERSONNEL.</small>		

	<b>PRECAUCION</b> RIESGO DE CORRIENTAZO NO ABRA	
<small>PRECAUCION: PARA REDUCIR EL RIESGO DE INCENDIOS O DESCARGAS ELECTRICAS, NO PERMITA QUE ESTE APARATO QUEDE EXPUESTO A LA LLUVIA O LA HUMEDAD. PARA DISMINUIR EL RIESGO DE CORRIENTAZO, NO ABRA LA CUBIERTA. NO HAY PIEZAS ADETRON QUE EL USARIO PUEDO REPARAR DEJE TODO MANTENIMIENTO A LOS TECNICOS CALIFICADOS.</small>		

	<b>ATTENTION</b> RISQUE D'ELECTROCUTION NE PAS OUVRIR	
<small>ATTENTION: PROTEGEZ CET APPAREIL DE LA PLUIE ET DE L'HUMIDITE AFIN D'EVITER TOUT RISQUE D'INCENDIE OU D'ELECTROCUTION. POUR REDUIRE D'ELECTROCUTION NE PAS ENLEVER LE COUVERCLE. AUCUNE PIECE INTERNE N'EST REPRABLE PAR L'UTILISATEUR. POUR TOUTE REPARATION, S'ADRESSER A UN TECHNICIEN QUALIFIE.</small>		

### IMPORTANT SAFETY INSTRUCTIONS

- READ, FOLLOW, HEED, AND KEEP ALL INSTRUCTIONS AND WARNINGS.
- DO NOT OPERATE NEAR ANY HEAT SOURCE AND DO NOT BLOCK ANY VENTILATION OPENINGS ON THIS APPARATUS. FOR PROPER OPERATION, THIS UNIT REQUIRES 3" (75mm) OF WELL VENTILATED SPACE AROUND HEATSINKS AND OTHER AIR FLOW PROVISIONS IN THE CABINET.
- DO NOT USE THIS APPARATUS NEAR SPLASHING, FALLING, SPRAYING, OR STANDING LIQUIDS.
- CLEAN ONLY WITH LINT-FREE DAMP CLOTH AND DO NOT USE CLEANING AGENTS.
- ONLY CONNECT POWER CORD TO A POLARIZED, SAFETY GROUNDED OUTLET WIRED TO CURRENT ELECTRICAL CODES AND COMPATIBLE WITH VOLTAGE, POWER, AND FREQUENCY REQUIREMENTS STATED ON THE REAR PANEL OF THE APPARATUS.
- PROTECT THE POWER CORD FROM DAMAGE DUE TO BEING WALKED ON, PINCHED, OR STRAINED.
- UNPLUG THE APPARATUS DURING LIGHTNING STORMS OR WHEN UNUSED FOR LONG PERIODS OF TIME.
- ONLY USE ATTACHMENTS, ACCESSORIES, STANDS, OR BRACKETS SPECIFIED BY THE MANUFACTURER FOR SAFE OPERATION AND TO AVOID INJURY.
- WARNING: TO REDUCE THE RISK OF ELECTRIC SHOCK OR FIRE, DO NOT EXPOSE THIS UNIT TO RAIN OR MOISTURE.
- SERVICE MUST BE PERFORMED BY QUALIFIED PERSONNEL.
- OUR AMPLIFIERS ARE CAPABLE OF PRODUCING HIGH SOUND PRESSURE LEVELS. CONTINUED EXPOSURE TO HIGH SOUND PRESSURE LEVELS CAN CAUSE PERMANENT HEARING IMPAIRMENT OR LOSS. USER CAUTION IS ADVISED AND EAR PROTECTION IS RECOMMENDED IF UNIT IS OPERATED AT HIGH VOLUME.
- WARNING: THIS UNIT REQUIRES A SAFETY GROUNDED OUTLET WIRED TO CURRENT ELECTRIC CODES HAVING THE LINE SUPPLY VOLTAGE, POWER, AND FREQUENCY IDENTIFIED ON THE REAR OF THE UNIT. THE OUTLET MUST REMAIN ACCESSIBLE TO DISCONNECT THE UNIT IF A FAULT SHOULD ARISE WHILE IN USE. THIS UNIT SHOULD BE UNPLUGGED WHEN NOT IN USE.

EXPLANATION OF GRAPHICAL SYMBOLS:

EXPLICACION DE SIMBOLOS GRAFICOS:

EXPLICATION DES SYMBOLES GRAPHIQUES:



=

"DANGEROUS VOLTAGE"

"VOLTAJE PELIGROSO"

"DANGER HAUTE TENSION"



=

"IT IS NECESSARY FOR THE USER TO REFER TO THE INSTRUCTION MANUAL"

"ES NECESARIO QUE EL USUARIO SE REFIERA AL MANUAL DE INSTRUCCIONES."

"REFERREZ-VOUS AU MANUAL D'UTILISATION"

## Introduction

***Congratulations!*** You are now the proud owner of a Crate V33H tube guitar amplifier. This rugged amplifier packs a whole lot of vintage tube sound and classic spring reverb into its compact cabinet, providing you with an amp that is portable and easy to operate, yet still produces incredible sounds!

The V-Series amps offer the versatility required for many different musical styles, and have the unique tonal purity of a hot-rodded tube amp. The V33H is a two-channel amplifier with channel-switching between clean and overdrive sounds, gain and master volume controls, treble/mid/bass tone controls, global boost and presence switches, and an internal spring reverb. It cranks out 33 watts from a set of four EL84 output tubes.

Like all Crate products, your V33H amplifier is designed by musicians and built using only the best components. Each amplifier is tested to confirm that it meets our specifications, and we believe that this amplifier is the absolute best that it can be.

In order to get the most out of your new amplifier, please read this manual before you begin playing.

And **thank you** for choosing Crate.

Here are some of the features packed into your new V33H Guitar Amplifier:

- Four EL84 power vacuum tubes for smooth overdrive sound
- Three 12AX7 preamplifier vacuum tubes
- 33 watts rms power output
- Two-channel operation (Clean and Overdrive)
- 3-band shared EQ
- Boost switch for increased midrange
- Proprietary Presence switch adds punch to the output
- Reverb control
- Effects loop
- Extension speaker output for connecting additional speakers
- Two-function footswitch option for remotely selecting Channel and Boost

## The Front Panel

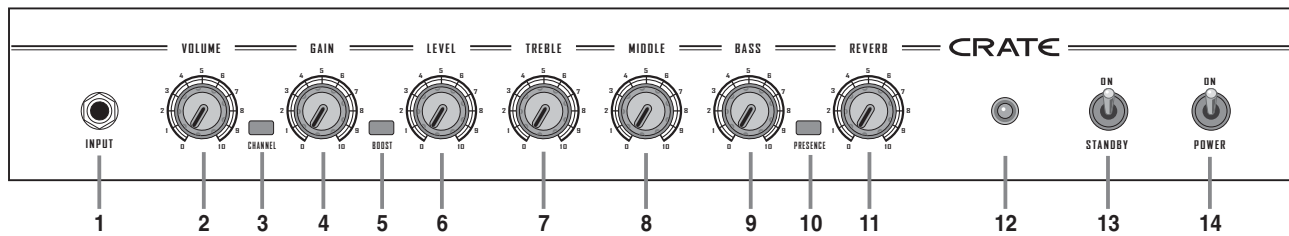

- 1. INPUT:** Use this jack to connect your guitar to the amplifier using a shielded instrument cable.
- 2. VOLUME:** Use this to adjust the output level of the Clean channel.
- 3. CHANNEL Select:** Push in this switch to activate the Overdrive channel. The Clean channel is active when the switch is in the out position.
- 4. GAIN:** Use this to adjust the gain for the Overdrive channel. With the control turned counter-clockwise, the gain is low and very little distortion is present. As you rotate it clockwise, the gain increases, producing more overdrive distortion, and a higher output volume level.
- 5. BOOST:** Push this switch in to boost the output by 10 dB at 900 Hz. This adds more punch to the midrange frequencies.
- 6. LEVEL:** Use this to adjust the output level of the Overdrive channel.
- 7. TREBLE:** Use this to adjust the output level of the high frequencies. The adjustment range is 12 dB at 6 kHz.
- 8. MIDDLE:** Use this to adjust the output level of the mid frequencies. The adjustment range is 10 dB at 1 kHz.
- 9. BASS:** Use this to adjust the output level of the low frequencies. The adjustment range is 8 dB at 150 Hz.
- 10. PRESENCE:** Push this switch in to adjust the overall brightness and punch of the output signal.
- 11. REVERB:** Use this to adjust the amount of reverb. Fully counter-clockwise is “dry” (no reverb). Rotate clockwise to increase the amount of reverb.
- 12. LAMP:** This illuminates when the amplifier is turned on.
- 13. ON/STANDBY Switch:** Use this switch to activate the amplifier after the On/Off switch (14) is turned on.  
***Always turn this switch OFF first, and ON last! Turn the On/Off switch (14) on at least 30 seconds before turning on the standby switch.***  
During short breaks, you should turn this switch off, and leave the On/Off switch on. This will help prolong the life of the amplifier tubes.
- 14. ON/OFF SWITCH:** Use this switch to turn the amplifier on and off.  
***Always turn this switch ON first and OFF last! Turn the Standby switch (13) on at least 30 seconds after turning on the On/Off switch.***

## The Rear Panel

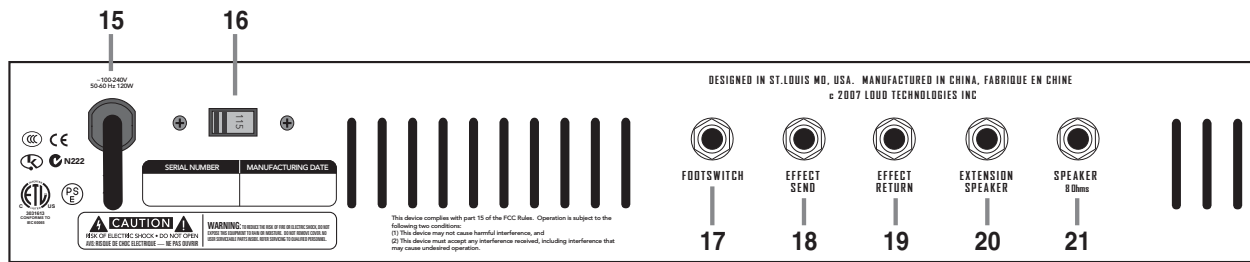

**15. AC LINE CORD:** The grounded power cord should only be plugged into a grounded power outlet that meets all applicable electrical codes, and is compatible with the voltage, power, and frequency requirements stated on the V33H rear panel. Do not attempt to defeat the safety ground connection.

**16. Voltage Select Switch:** Set this switch to “115” for 120 VAC mains, and to “230” for 220-240 VAC mains.

**With the amplifier power cord unplugged,** use the tip of a small flat-blade screwdriver to slide this switch to the proper position.

**17. FOOTSWITCH Jack:** Use this 1/4" TRS jack to connect the cable of the optional VSFS-2 footswitch. This allows for remote control of channel switching and the boost effect (Tip= channel select, Ring = boost on/off).

**18. EFFECT SEND:** Use this 1/4" TS jack to send the signal to an external effects box.

**Note:** The Effect Send jack can be used as a line-level output from the pre-amplifier stage of the V33H to a mixer or recorder. The signal comes after the EQ stage but before the reverb stage.

**19. EFFECT RETURN:** Use this 1/4" TS jack to return the signal from an external effects box.

**Note:** The Effect Return jack disconnects the signal from the preamplifier stage of the V33H, so only the signal at the Effect Return jack is sent on to the power amplifier.

**20. EXTENSION SPEAKER:** Use this 1/4" TS jack to connect the amplifier to an 8 ohm extension speaker.

**21. SPEAKER 8 OHMS:** Use this 1/4" TS jack to connect the amplifier to an 8 ohm speaker like the Crate V212B.

## **Important Information about Tubes and Tube Products:**

### **A Brief History Of The Tube:**

In 1883, Edison discovered that electrons would flow from a suspended filament when enclosed in an evacuated lamp. Years later, in 1905, Fleming expanded on Edison's discovery and created the "Fleming Valve." Then, in 1907, Dr. Lee de Forest added a third component – the grid – to the "Fleming Valve" and the vacuum tube was a fact of life. The door to electronic amplification was now open.

During World War II, data gleaned from their intensive research on the detectors used in radar systems, led Bell Telephone Laboratories to the invention of the transistor. This reliable little device gained quick support as the new component for amplification. The death of the vacuum tube seemed imminent as designers, scientists, and engineers reveled in the idea of replacing large, fragile glass tubes with these small, solid-state devices.

However, there were (and still are) many serious listeners who realized that the sound produced by a "transistor" amplifier is significantly different from that produced by a tube amplifier with identical design specifications. They considered the sound produced by these new solid-state devices to be hard, brittle, and lifeless. It was determined that solid-state devices produced a less musical set of harmonics than tubes. When pushed past their limits, they tend to mute the tone and emphasize the distortion.

Tubes, on the other hand, produce a more musical set of harmonics, the intensity of which can be controlled by the player. This characteristic adds warmth and definition to the sound which has become the hallmark of tube amplifiers. When tubes are driven into clipping, the harmonic overtones can be both sweet and pleasing or intense and penetrating, depending on the musician's musical taste and playing technique.

Over the years, application engineers have designed a number of outstanding solid-state amplifiers that sound very, very good. Some use special circuitry which enables them to simulate the distortion characteristics of a tube amplifier. However, the tube amplifier, still held in the highest esteem by many musicians, offers a classic "vintage" sound in a contemporary market.

### **Tube Types And Usage:**

Tube amplifiers are based primarily on two types of tubes – preamplifier tubes and power tubes. The tubes used in preamplifiers (12AX7, 12AU7, 12AT7, etc.) are smaller than the power tubes. These tubes amplify the signal from your instrument and shape the sound. They are inherently microphonic (they can mechanically pick up and transmit external noises). Since these tubes are used in the critical first stages of a tube amplifier's circuitry, it is very important to use high-quality, low noise/low microphonic tubes for this application. Although tubes of this quality may be difficult to find and typically cost more than "off-the-shelf" tubes, the improvement in performance is worth the investment.

Preamplifier tubes are also used to drive the power tubes. When used in this application, a 12AX7 will produce a more distorted tone than a 12AT7, which produces a clearer, sweeter sound. A 12AU7 is even cleaner and brighter than a 12AT7, giving more definition to the sound. (In some cases it is possible to change the sound by changing the type of preamp and/or driver tubes. When making any modification to your equipment, it is highly recommended that you consult with a qualified service center.)

## *Important Information About Tubes and Tube Products (continued):*

The power tubes are the largest tubes used in an amplifier. These tubes convert the low-level, conditioned signal from the preamplifier into a level that is sufficient to drive the speakers. There are several types of power tubes available, each of which offers a different performance/sound characteristic. For example, the EL34 power tube produces a great classic rock sound. When an EL34 is driven into distortion, it produces a unique sound (“crunch”). When compared to the 6L6, the EL34 distorts more quickly, exhibits a “looser” low-end response and produces more harmonics at mid and high frequencies (“creamier” sound). These differences become more noticeable at higher volumes.

The EL84 is similar to the EL34 but produces less output power. It can be easily driven into distortion and is characterized by a smooth, sweet tone with excellent touch sensitivity.

6L6 tubes produce a big low-end thump and have a very good dynamic range. They offer a more traditional “American Rock” sound. The 6V6 tubes produce a creamy sound with nice distortion. On the other hand, the KT88 produces a big low-end but sounds more like an EL34 in the mid and high frequencies.

6550 power tubes are more rugged and stay cleaner-sounding even at full power. When they do distort, the sound produced is more solid and has a tighter low end; more of a “heavy metal” type distortion with lots of power.

Some tubes are available in matched sets. These tubes have been extensively tested for optimum performance and longevity.

### **The Nature Of Tubes — Why (And When) To Replace Them:**

Tubes are made up of a number of fragile mechanical components that are vacuum-sealed in a glass envelope or bubble. The tube’s longevity is based on a number of factors which include how hard and often the amplifier is played, vibration from the speakers, road travel, repeated set up and tear down, etc.

Any time you notice a change in your amplifier’s performance, check the tubes first.

If it’s been a while since the tubes were replaced and the sound from your amplifier lacks punch, fades in and out, loses highs or lows or produces unusual sounds, the power tubes probably need to be replaced. If your amplifier squeals, makes noise, loses gain, starts to hum, lacks “sensitivity”, or feels as if it is working against you, the preamplifier tubes may need to be replaced.

The power tubes are subjected to considerably more stress than the preamplifier tubes. Consequently, they almost always fail/degrade first. If deteriorating power tubes aren’t replaced they will ultimately fail. Depending on the failure mode, they may even cause severe damage to the audio output transformer and/or other components in the amplifier. Replacing the tubes before they fail completely has the potential to save you time, money and unwanted trouble. Since power tubes work together in an amplifier, it is crucial that they (if there is more than one) be replaced by a matched set. If you’re on the road a lot, we recommend that you carry a spare matched set of replacement power tubes and their associated driver tubes.

After turning off the power and disconnecting the amplifier from the power source, carefully check the tubes (in bright light) for cracks or white spots inside the glass or any other apparent damage. Then, with the power on, view the tubes in a dark room. Look for preamplifier tubes that do not glow at all or power tubes that glow excessively red.

## *Important Information About Tubes and Tube Products (continued):*

Whenever you replace the power tube(s):

- Always have the amplifier's bias voltage checked by a qualified service center. Improper bias voltage will cause degradation in performance and possibly damage the tubes and/or the amplifier. (See "The Importance of Proper Biasing", below for more information).
- We highly recommend that you replace the driver tube(s) as well. The driver tube determines the shape and amplitude of the signal applied to the power tube(s) and has to work almost as hard as the power tube(s).

You can check your preamplifier tubes for microphonics by turning the amplifier on, turning up the gain and tapping lightly on each tube with the end of a pencil or a chop stick (my favorite). You will be able to hear the tapping through your speakers, which is normal. It is not normal for a tube to ring like a bell after it's tapped. If it does ring then it's microphonic and should be replaced. Remember to use only high quality, low microphonic tubes in the preamplifier section.

Even though power tubes are rarely microphonic, you should check them anyway. The power tubes can be checked for microphonics just like pre-amp tubes.

In the case of very high gain amps, you may be able to reduce the amount of noise generated by simply swapping the preamp tubes around.

### **The Importance Of Proper Biasing:**

For the best performance and longest tube life, proper biasing is imperative. Bias is the negative voltage which is applied to the power tube's control grid to set the level of idle current. We cannot over emphasize the difference in warmth of tone and dynamic response that come with proper biasing. If the bias is set too high (over biased), the sound from the amp will be distorted at all levels. If the bias is set too low, (under biased) the power tubes will run hot (the plates inside the tubes may glow red due to excessive heat) and the sound from the amplifier will lack power and punch. The excessive heat greatly reduces tube life – from a few days to as little as a few hours in extreme cases. Setting the bias on your amp is like setting the idle on your car. If it's too high or hot it's running away with you and if it's too low or cold it will choke when you step on it.

The bias is adjusted at the factory in accordance with the type of power tube(s) installed in your amplifier. It is important to point out that tubes of the same type and specification typically exhibit different performance characteristics. Consequently, whenever power tubes are replaced, the bias voltage must be checked (unless the amplifier is equipped with "self-biasing" circuitry) and readjusted to accommodate the operating parameters of the replacement tubes.

Depending on the model and amplifier type, there may be hum balance controls, trim pots, or bias adjustment controls on its rear panel. However, the bias adjustment should be performed only by qualified service personnel with the proper, calibrated test equipment.



*Important Information About Tubes and Tube Products (continued):*

## **Survival Tips For Tube Amplifiers:**

To prolong tube life, observe these tips and recommendations:

- Match the impedance of your speaker cabinet(s) to your amplifier. Improper impedance matching will contribute to early tube degradation and may cause premature tube failure.
- Make sure the speaker(s) are properly connected prior to turning on the amplifier.
- After playing the amplifier, allow sufficient time for it to properly cool down prior to moving it. A properly cooled amplifier prolongs tube life due to the internal components being less susceptible to the damage caused by vibration.
- Allow the amplifier to warm up to room temperature before turning it on. The heat generated by the tube elements can crack a cold glass housing.
- Replace the output tube(s) before the performance degrades or the tubes fail completely. Replace the tube(s) on a regular basis (at least once per year or as often as every 4 to 6 months if you play long and hard every day).
- Always have the bias checked after replacing the output tubes (unless the amplifier is equipped with “selfbiasing circuitry”). This should be done ONLY at a qualified service center. Improper biasing could result in the tubes running too hot, which greatly reduces the life of the tubes – or too cold, which results in distorted sound regardless of level settings. Do not play the amplifier if it exhibits these symptoms – get the bias checked/adjusted immediately to prevent tube failure and/or other damage.
- If the locating notch on the base of a power tube breaks off, replace the tube. This significantly reduces the risk of damaging your amplifier by incorrectly inserting the tube.
- Protect the amplifier from dust and moisture. If liquid gets into the amplifier proper, or if the amplifier is dropped or otherwise mechanically abused, have it checked out at an authorized service center before using it.
- Proper maintenance and cleaning in combination with routine checkups by your authorized service center will insure the best performance and longest life from your amplifier.

**CAUTION: Tube replacement should be performed only by qualified service personnel who are familiar with the dangers of hazardous voltages that are typically present in tube circuitry.**

## Some Suggested Settings

### Sweet 'n Clean:

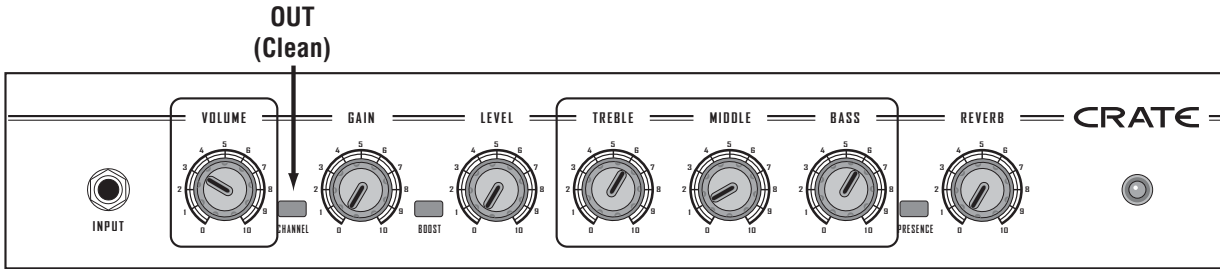

### Just a 'Lil Nasty:

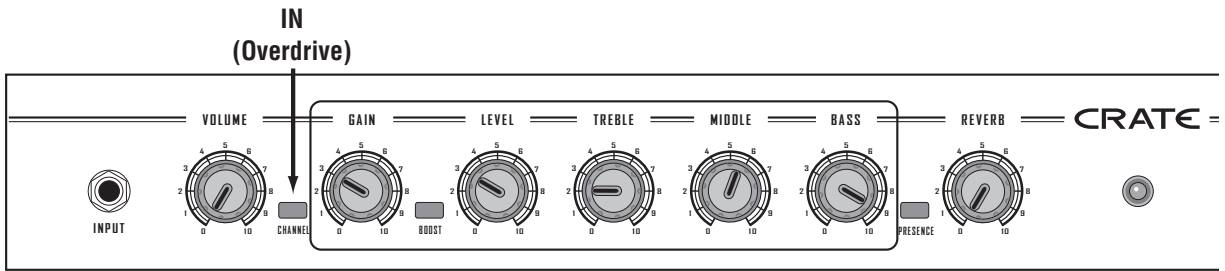

### Politely Gritty:

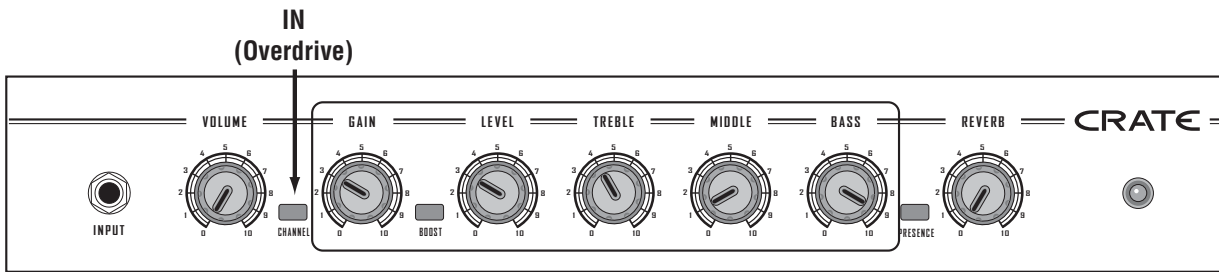

### Down 'n Dirty:

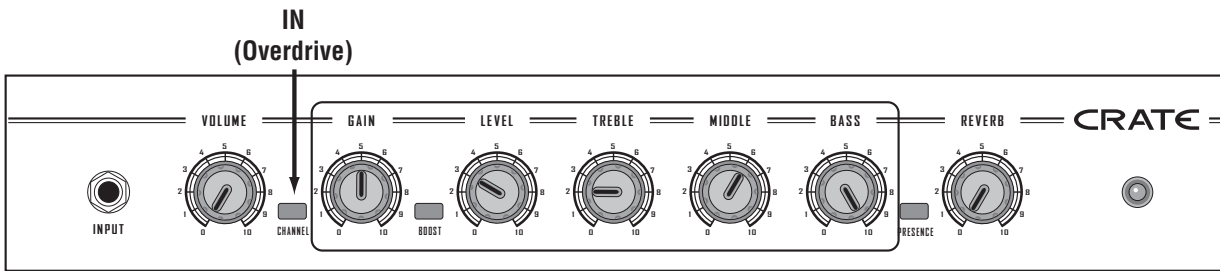

## System Block Diagram

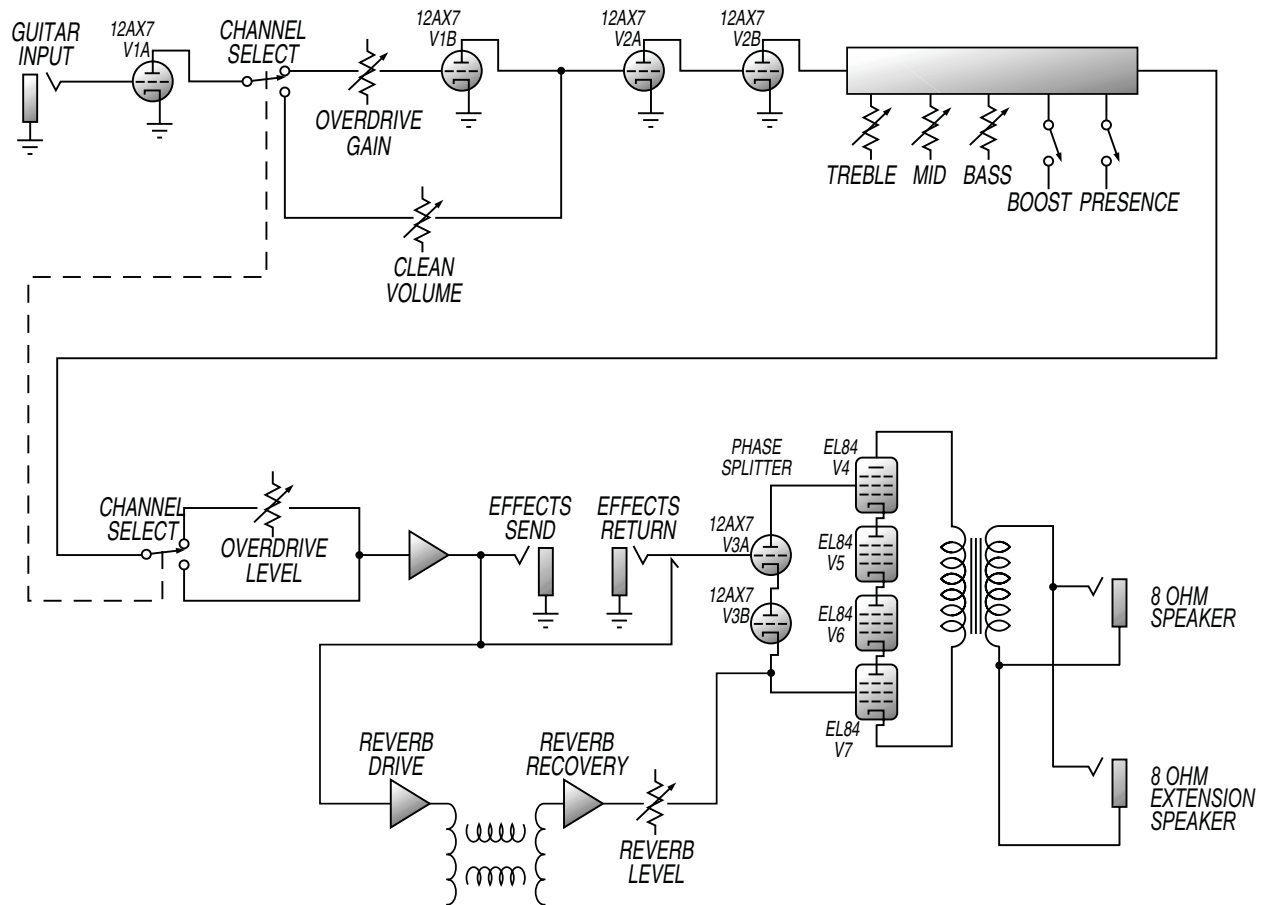

### Declaration Of Conformity

<b>Manufacturer:</b>	LOUD Technologies Inc. 16220 Wood-Red Rd. NE Woodinville, WA 98072, USA
<b>Product Name:</b>	Crate V33H
<b>Product Type:</b>	Audio Amplifier
<b>Complies with Standards:</b>	
<b>LVD:</b>	92/31/EEC, 93/68/EEC, & 73/23/EWG
<b>Safety:</b>	EN60065
<b>EMC:</b>	EN55013, EN55020, EN55022, EN55103, EN61000-3-2, & EN61000-3-3

The official Declaration of Conformity for this product is kept on file at:  
 LOUD Technologies Inc., 16220 Wood-Red Road NE, Woodinville, WA 98072 • Tel: 1-866-858-5832

## V33H TECHNICAL SPECIFICATIONS

Output Power Rating		33 W rms @ 10% THD, 8 ohm load, 120 VAC
Input Impedance		700 kohms
Signal-to-Noise Ratio		42 dB, Typical (Clean Ch only)
Gain	Overdrive Ch	102 dB, all controls @ 10
	Clean Ch	56 dB, all controls @ 10
EQ		Treble: 12 dB range @ 6 kHz Middle: 10 dB range @ 1 kHz Bass: 8 dB range @ 150 Hz
Boost		10 dB @ 900 Hz
Presence		8 dB @ 10 kHz
Preamplifier Tubes		(3) 12AX7
Power Tubes		(4) EL84
Power Requirements		90-132 VAC, 60 Hz, 85 VA 220-240 VAC, 50 Hz, 85 VA
Size (H x W x D)		8.25 in/21.0 cm x 24.25 in/61.6 cm x 9.15 in/23.2 cm
Weight		25.4 lb/11.5 kg

## Service Information

If you are having a problem with your V33H, you can go to our website ([www.crateamps.com](http://www.crateamps.com)) and click on Support for service information, or call 1-800-898-3211 during business hours (7 am to 5 pm PST, Monday-Friday). If you are outside of the U.S., contact your local distributor for technical support and service.

**The V33H is covered with a durable fabric-backed vinyl material. Wipe it clean with a lint-free cloth. Never spray cleaning agents onto the cabinet. Avoid abrasive cleansers which would damage the finish.**

*Crate continually develops new products, as well as improves existing ones. For this reason, the specifications and information in this manual are subject to change without notice.*

*"Crate" is a registered trademark of LOUD Technologies Inc. All other brand names mentioned are trademarks or registered trademarks of their respective holders and are hereby acknowledged.*



[www.crateamps.com](http://www.crateamps.com)  
©2007 LOUD Technologies Inc.  
16220 Wood-Red Road NE • Woodinville, WA 98072  
Part No. 0024537 Rev. B 08/07

