

UAD SYSTEM MANUAL

SOFTWARE VERSION 6.3.2

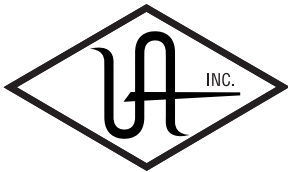

UNIVERSAL AUDIO

Universal Audio, Inc.
1700 Green Hills Road
Scotts Valley, CA 95066-4926
Voice: +1-831-440-1176
Fax: +1-831-461-1550
www.uaudio.com

Customer Support
USA (toll-free): 1-877-698-2834
International: +1-831-1176

NOTICES

Disclaimer

This manual provides general information, preparation for use, installation and operating instructions for Universal Audio UAD Powered Plug-Ins. The information contained in this manual is subject to change without notice.

Universal Audio, Inc. makes no warranties of any kind with regard to this manual, or the product(s) it refers to, including, but not limited to, the implied warranties of merchantability and fitness for a particular purpose.

Universal Audio, Inc. shall not be liable for errors contained herein or direct, indirect, special, incidental, or consequential damages in connection with the furnishing, performance, or use of this material or the product(s).

Important Safety Instructions

Before using this unit, be sure to carefully read the applicable items of these operating instructions and the safety suggestions. Afterwards keep them handy for future reference. Take special care to follow the warnings indicated on the unit, as well as in the operating instructions.

Water and Moisture

Do not use the unit near any source of water or in excessively moist environments.

Object and Liquid Entry

Care should be taken so that objects do not fall, and liquids are not spilled, into the enclosure through openings.

Ventilation

When installing the unit in a rack or any other location, be sure there is adequate ventilation. Improper ventilation will cause overheating, and can damage the unit.

Heat

The unit should be situated away from heat sources, or other equipment that produces heat.

Power Sources

The unit should be connected to a power supply only of the type described in the operating instructions, or as marked on the unit.

Power Cord Protection

AC power supply cords should be routed so that they are not likely to be walked on or pinched by items placed upon or against them. Pay particular attention to cords at plugs, convenience receptacles, and the point where they exit from the unit. Never take hold of the plug or cord if your hand is wet. Always grasp the plug body when connecting or disconnecting AC.

Cleaning

The external unit should be cleaned only with a damp cloth and mild soap if necessary. Chemical cleaners may damage the silkscreen and/or finish.

Nonuse Periods

The AC power supply cord of the unit should be unplugged from the AC outlet when left unused for a long period of time.

Damage Requiring Service

The unit should be serviced by qualified service personnel when:

- The AC power supply cord or the plug has been damaged;
- Objects have fallen or liquid has been spilled into the unit;
- The unit has been exposed to rain;
- The unit does not operate normally or exhibits a marked change in performance;
- The unit has been dropped, or the enclosure damaged.

FCC Compliance

This equipment has been tested and found to comply with the limits for a Class B digital device, pursuant to part 15 of the FCC Rules. These limits are designed to provide reasonable protection against harmful interference in a residential installation.

This equipment generates, uses and can radiate radio frequency energy and, if not installed and used in accordance with the instructions, may cause harmful interference to radio communications. However, there is no guarantee that interference will not occur in a particular installation.

If this equipment does cause harmful interference to radio or television reception, which can be determined by turning the equipment off and on, the user is encouraged to try to correct the interference by one or more of the following measures:

- Reorient or relocate the receiving antenna.
- Increase the separation between the equipment and receiver.
- Connect the equipment into an outlet on a circuit different from that to which the receiver is connected.
- Consult the dealer or an experienced radio/TV technician for help.

Caution: Changes or modifications not expressly approved by Universal Audio could void the user's authority to operate the equipment.

Warranty

The Warranty for all Universal Audio hardware is one (1) year from date of purchase, including parts and labor.

Service & Support

Even the best-built audio equipment in the world will sometimes fail. In those rare instances, our goal here at UA is to get you up and running again as soon as possible. If you are experiencing problems with your UAD product, please visit the Universal Audio website at <http://www.uaudio.com> to validate compatibility, and read the FAQs regarding UAD products. If you still require service, contact UA Tech Support at 877-MY-UAUDIO, or visit <http://www.uaudio.com/support/contact.html> to create a help ticket, and we will help troubleshoot your system. (Canadian and overseas customers should contact their local distributor, which can be found using the Dealer Locator at <http://www.uaudio.com>.) When calling Tech Support for assistance, please have the product serial number available, and have your unit set up in front of you, turned on, and exhibiting the problem. This will help us diagnose and solve any problems as quickly as possible. Thank you.

The user should not attempt to service the unit beyond that described in the operating instructions. All other servicing should be referred to qualified service personnel.

UAD System Manual

Version 121016

Universal Audio, Inc.

End User License Agreement

By installing the software and clicking through this window, you confirm your acceptance of the Universal Audio End User License Agreement, as well as the Universal Audio terms of service and privacy policy, and any additional Third-Party Software terms, all of which can be found at: <http://www.uaudio.com/eula>

This Universal Audio End-User License Agreement ("Agreement") is between Universal Audio, Inc. ("Universal Audio") and you. **IMPORTANT - PLEASE READ THIS LICENSE AGREEMENT CAREFULLY BEFORE INSTALLING THIS SOFTWARE.** By using the Universal Audio software ("Universal Audio Software"), you accept these terms. The Universal Audio Software may be distributed with software or components from third-parties ("Third-Party Software"). Use of Third-Party Software is also subject to the terms of this EULA, although certain third parties may have additional terms found at: <http://www.uaudio.com/eula>. The Universal Audio Software and Third-Party Software shall be collectively referred as "Software" in this Agreement.

If you do not accept these terms, do not use the Software provided with this installation. Instead, return the Software to the reseller for a refund or credit or, if you purchased your Software license directly from Universal Audio, contact Universal Audio for information at 877-MY-UAUDIO (877-698-2324). For a list of authorized resellers, see: <http://www.uaudio.com/where-to-buy.html>.

1. Limited Use License. The Software is licensed, not sold, by Universal Audio or its Third-Party Software suppliers ("Suppliers") to the original end user for use only on the terms set forth in the Agreement. If and only if your Software is purchased through a Universal Audio Authorized Dealer or Distributor, Universal Audio, as Licensor, grants you, as an end user Licensee, a non-exclusive license to use the Software (which includes computer software, updates and any bug fixes subsequently delivered and associated media, printed materials and "online" or electronic documentation) with a single computer unit at a single location.

2. Title. The Software is owned by Universal Audio or its Suppliers as applicable, and is protected by copyright laws and international treaty provisions, as well as other intellectual property laws and treaties. Universal Audio (or its Suppliers, as applicable) retains title to and ownership of the Software and all copies, as well as any rights not specifically granted. This Agreement only gives you certain rights to use the Software and related documentation, which may be revoked if you do not follow these terms.

3. Limited Rights to Install and Use the Software.

(i) Permitted use and restrictions. You may install the Software into the memory of a single computer for your internal business use or your own personal enjoyment, but may not redistribute or electronically transfer the Software to someone else's computer or operate it in a time-sharing or service-bureau operation. Additionally, you may only use the Software on a computer that contains a maximum of eight (8) UAD Devices, specifically four UAD-1 devices and four UAD-2 devices. "UAD Devices" includes UAD-1 and UAD-2 cards, as well as the UAD-Xpander, UAD-2 Satellite and Apollo products. The sole exceptions are—if you are a licensee of the UAD-2 Solo/Laptop card, UAD-2 Satellite or Apollo, you may link those UAD Devices to an existing computer previously registered.

(ii) Reverse engineering and copying limitations. You may make one copy of the Software for backup purposes only (and replacement backup copies in the event of loss of or damage to a backup copy), provided you include all copyright notices contained on the original media on the backup copy. You may not modify, translate, adapt, reverse engineer, decompile, create other works from, or disassemble the Software or any portions thereof (except and to the extent that applicable law expressly permits reverse engineering, decompilation or disassembly). Similarly, you may not copy, modify, adapt, transfer, or create other works based upon the printed materials and "online" or electronic documentation accompanying or published for use with the Software (the "Documentation").

(iii) Technical limitations. The Software may include technological measures, whether in the Software or in bundled hardware or both, that are designed to prevent or detect unlicensed use of the Software. Circumvention of these technological measures is prohibited, except and only to the extent that applicable law expressly permits, despite this limitation. Any attempt to circumvent technical limitations may render the Software or certain features unusable or unstable, and may prevent you from updating or upgrading the Software.

(iv) No reconfiguration. The Software is licensed for installation and use only in the manner it was provided to you, as configured by an automated installation program provided with the Software, or as described in Universal Audio's Documentation. You may not separate the components contained in the Software or otherwise reconfigure the Software to circumvent technical limitations on the use of the Software or to otherwise exceed the scope of your license.

4. Export, Renting and Transfer Restrictions. You may not export, convey, rent, sublicense, or otherwise distribute the Software or any rights therein to any person or entity. You may, however, transfer the Software license, but only under the following limited terms and conditions:

(i) Eligible transferees. You may transfer the license and remainder of the Limited Warranty to a transferee, only if (a) the Software license transfer is done in connection with a permitted Hardware transfer, as detailed at <http://www.uaudio.com/support/uad/transfer-faq>; (b) You have provided registration details (your name, hardware ID(s), user e-mail ID, buyer's name and buyer's e-mail address) to Universal Audio at info@uaudio.com in advance of the transfer; and (c) the transferee has agreed to be bound by the terms of this license by registering with Universal Audio at <http://www.uaudio.com/my>. Any permitted transferee may not subsequently transfer this license.

(ii) Eligible products. The Software may only be transferred in connection with up to four (4) UAD-1 devices and four (4) UAD-2 devices per user account. Special exceptions may arise where the use of more than eight (8) UAD Devices is required. These cases are generally related to areas of education and multi-room facilities, and require advanced approval if requesting to sell or transfer over eight (8) UAD Devices per account. If you have questions or are seeking an exception, please contact customer support at 877-MY-UAUDIO (877-698-2324).

5. Limited Warranty. Universal Audio and its Suppliers grant solely to you a limited warranty for a period of ninety (90) days from the original purchase date that the media on which the Software is distributed shall be substantially free from material defects. Your exclusive remedy under this warranty (at Universal Audio's option) is to return and have replaced the inaccurate media containing the Software or receive a refund of the price paid. **NEITHER UNIVERSAL AUDIO NOR ITS SUPPLIERS WARRANT THAT THE SOFTWARE WILL MEET YOUR REQUIREMENTS OR THAT ITS OPERATION WILL BE UNINTERRUPTED OR ERROR-FREE. EXCEPT AS SPECIFIED HEREIN, UNIVERSAL AUDIO AND ITS SUPPLIERS MAKE NO WARRANTIES OR REPRESENTATIONS, EXPRESS OR IMPLIED, REGARDING THE SOFTWARE, DOCUMENTATION, OR MEDIA, AND HEREBY EXPRESSLY DISCLAIMS THE WARRANTIES OF MERCHANTABILITY, FITNESS FOR A PARTICULAR PURPOSE, AND NONINFRINGEMENT OF THIRD PARTY RIGHTS. FURTHERMORE, UNIVERSAL AUDIO DOES NOT WARRANT OR MAKE ANY REPRESENTATIONS REGARDING THE USE OR THE RESULTS OF THE USE OF THE SOFTWARE OR DOCUMENTATION IN TERMS OF THEIR CORRECTNESS, ACCURACY, RELIABILITY, OR OTHERWISE. NO ORAL OR WRITTEN INFORMATION OR ADVICE GIVEN BY UNIVERSAL AUDIO OR A UNIVERSAL AUDIO-AUTHORIZED REPRESENTATIVE SHALL CREATE A WARRANTY OR IN ANY WAY INCREASE THE SCOPE OF THIS WARRANTY. EXCEPT AS SPECIFIED HEREIN, SHOULD THE SOFTWARE PROVE DEFECTIVE, YOU (AND NOT UNIVERSAL AUDIO OR A UNIVERSAL AUDIO-AUTHORIZED REPRESENTATIVE OR SUPPLIER) ASSUME THE ENTIRE COST OF ALL NECESSARY SERVICING, REPAIR, OR CORRECTION. SOME JURISDICTIONS DO NOT ALLOW THE EXCLUSION OF IMPLIED WARRANTIES, SO THE ABOVE EXCLUSION MAY NOT APPLY TO YOU.**

6. Excluded Products. Universal Audio and its Suppliers give NO warranty for Software free of charge, including Software designated as "limited release," "pre-release," "loan," "beta" or "test." This Software is provided "AS IS."

7. Limitation of Liability. UNIVERSAL AUDIO AND ITS SUPPLIERS SHALL HAVE NO LIABILITY TO YOU WHETHER IN CONTRACT, TORT, NEGLIGENCE OR PRODUCTS LIABILITY, FOR ANY CLAIM, LOSS, OR DAMAGE, INCLUDING BUT NOT LIMITED TO LOST PROFITS, LOSS OF USE, BUSINESS INTERRUPTION, LOST DATA, OR LOST FILES, OR FOR ANY INDIRECT, SPECIAL, INCIDENTAL OR CONSEQUENTIAL DAMAGES OF ANY KIND OR NATURE WHATSOEVER ARISING OUT OF OR IN CONNECTION WITH THE USE OF OR INABILITY TO USE THE SOFTWARE OR DOCUMENTATION, OR THE PERFORMANCE OR OPERATION OF THE SOFTWARE, EVEN IF UNIVERSAL AUDIO OR ITS SUPPLIERS HAS BEEN ADVISED OF THE POSSIBILITY OF SUCH DAMAGES. SOME STATES DO NOT ALLOW THE EXCLUSION OR LIMITATION OF INCIDENTAL OR CONSEQUENTIAL DAMAGES, SO THE ABOVE EXCLUSION OR LIMITATION MAY NOT APPLY TO YOU. IN NO EVENT SHALL UNIVERSAL AUDIO'S TOTAL LIABILITY TO YOU FOR ALL DAMAGES, LOSSES, AND CAUSES OF ACTION WHETHER IN CONTRACT, TORT (INCLUDING NEGLIGENCE) OR OTHERWISE EXCEED THE AMOUNT PAID BY YOU FOR THE SOFTWARE.

8. Termination. To the extent permitted by law, and without prejudice to any other rights Universal Audio may have, Universal Audio may terminate your license if you materially breach these terms and conditions. Upon termination by Universal Audio, you will return to Universal Audio, at your expense, the Software, including Documentation, and any copies thereof.

9. Notice to U. S. Government End Users. The software is a "commercial item" as that term is defined in 48 CFR 2.101 (Oct. 2005), consisting of "commercial computer software documentation," as such terms are used in 48 CFR 12.212 (Sept. 2005). Consistent with 48 CFR 12.212 and 48 CFR 227.7202-1 through 227.7202-4 (June 2005), all U.S. Government End Users acquire the software with only those rights set forth herein. All software provided to the U.S. Government pursuant to solicitations issued prior to December 1, 1995 is provided with "Restricted Rights" as provided for in FAR, 48 CFR 52.227-14 (June 1987) or DFAR, 48 CFR 252.227-7013 (Oct. 1988) as application. This provision does not apply if you are not affiliated with the government of the United States of America.

10. Export restrictions. The Software is subject to United States export laws and regulations. If you are subject to U.S. laws, you must comply with these laws, which include restrictions on destinations, end users and end use. For further information, please see <http://www.bis.doc.gov>.

11. Consent to Use Data. Universal Audio may collect and use technical information about the Software and hardware devices you use in connection with the Software in a manner that does not personally identify you. Universal Audio may use this information to improve our products or to provide customized services or technologies. Universal Audio may also disclose this information to third parties so that they may improve the way their products or services interact with the Software.

12. Third-Party Software and Information. This EULA governs any Third-Party Software distributed by Universal Audio. Universal Audio may include information about third party products and services, including links to Web sites run by others. Universal Audio is not responsible for, and does not endorse or sponsor, this third-party information.

13. Miscellaneous. This Agreement shall be governed by and construed in accordance with the laws of the United States and the State of California, as applied to agreements entered into and to be performed entirely within California between California residents. If for any reason a court of competent jurisdiction finds any provision of this Agreement or portion thereof to be unenforceable, that provision or part thereof shall be enforced to the maximum extent permissible so as to effect the intent of the parties, and the remainder of this Agreement shall continue in full force and effect. This Agreement constitutes the entire agreement between the parties with respect to the use of the Software and Documentation, and supersedes all prior or contemporaneous understandings or agreements, written or oral, regarding such subject matter. No amendment to or modification of this Agreement will be binding unless in writing and signed by a duly authorized representative of Universal Audio.

Should you have any questions concerning this Agreement, please contact Universal Audio at 1700 Green Hills Road, Scotts Valley, CA, 95066-4926 USA, +1-831-440-1176 voice, +1-831-461-1550 fax, www.uaudio.com web.

Copyright

(c) 2012 Universal Audio, Inc. All rights reserved.

This manual and any associated software, artwork, product designs, and design concepts are subject to copyright protection. No part of this document may be reproduced, in any form, without prior written permission of Universal Audio, Inc. Your rights to the Software are governed by the accompanying End-User license agreement.

Trademarks

Universal Audio, the Universal Audio "diamond" logo, UAD, UAD Series, UAD-1, UAD-2, UAD-2 SOLO, UAD-2 DUO, UAD-2 QUAD, "Powered Plug-Ins", 1176LN, 1176SE, Teletronix, LA-2A, LA-3A, LA-610, LA-610MkII, 2-1176, 2-610, 6176, 710 Twin-Finity, 2192, 4-710d, Cambridge EQ, DreamVerb, Plate 140, Precision Limiter, RealVerb Pro, Precision Buss Compressor, Precision De-Esser, Precision Maximizer, Satellite DUO, Satellite QUAD, Apollo and "Analog Ears | Digital Minds," are trademarks or registered trademarks of Universal Audio, Inc. Other company and product names mentioned herein are trademarks of their respective owners.

Last Updated March 27, 2012

TABLE OF CONTENTS

Chapter 1. Introduction	8
Welcome!	8
Features	10
The UAD System	11
Package Contents	11
UAD Documentation Overview	11
Online Documentation	13
Customer Support	14
Chapter 2. UAD Installation	15
Overview	15
Install Videos	15
System Requirements	16
Supported Hosts	16
Latest Information & Software Updates	17
UAD Software Installation	18
UAD Hardware Installation	20
Authorization	22
Authorize Plug-Ins Procedure	23
Offline Authorization	24
Verifying Installation	26
Software Removal	27
Using Unlicensed Plug-Ins (Demo Mode)	27
Learn More	27
Chapter 3. UAD System Overview	28
The UAD Environment	28
The UAD Hardware	28
The UAD Software	31
The DAW Environment	33
My.uaudio.com	35
Authorization	35
Chapter 4. My.uaudio.com	36
Optional Plug-Ins	36
Authorization Overview	37
Demo Mode	40
UA Online Store	41
Buying Plug-Ins	42
Transferring UAD devices and licenses	43

TABLE OF CONTENTS

Chapter 5. Using Multiple UAD Devices	44
Overview	44
Plug-In License Policy	44
Authorizing Multiple Devices	44
Power Requirement	45
Multidevice DSP Loading	46
Device Info Display	46
Disabling Devices	46
Host CPU	47
Chapter 6. UAD Meter & Control Panel	48
Overview	48
Launching the UAD Meter & Control Panel Application	49
Using the UAD Meter	49
UAD Meter Elements	50
UAD Control Panel	51
System Information Panel	52
Plug-Ins Panel	55
Configuration Panel	58
FireWire Panel	64
Help & Support Panel	69
Chapter 7. Using UAD Powered Plug-Ins	71
Overview	71
Launching a UAD Powered Plug-In	71
The UAD Plug-In Window	72
UAD Toolbar	73
LiveTrack Mode	75
Adjusting Parameters	77
Shortcuts	78
DSP Loading Information	79
Automation	80
External MIDI Control	81
Operating Levels	81
Chapter 8. Tempo Sync	82
Overview	82
Tempo Sync Plug-Ins	82
Available Note Values	83
Range Limits	84

TABLE OF CONTENTS

Entering Values	84
Out of range	85
Modes with Tempo Sync	85
Roland RE-201 Sync	85
Chapter 9. UAD Delay Compensation	86
Latency & Delay Compensation	86
Upsampled Plug-Ins	87
Upsampling Values Table	88
Live Processing	89
Chapter 10. UAD-2 SOLO/Laptop	90
Overview	90
UAD-2 SOLO/Laptop Details	92
Important SOLO/Laptop Notes	95
Chapter 11. UAD-2 Satellite	96
Overview	96
UAD-2 Satellite Details	97
UAD-2 Satellite Installation	98
UAD-2 Satellite Operation	101
Important UAD-2 Satellite Notes	103
FireWire Basics	105
FireWire Bandwidth	109
FireWire Bandwidth vs. UAD DSP	111
FireWire Bus Power	112
Chapter 12. History	114
Bill Putnam Sr.	114
Classic Compressors	118
Pros Talk UA	121
Thank You	125

CHAPTER 1

Introduction

Welcome!

Congratulations, and welcome to the UA Family! You now own the best sounding, most powerful sonic upgrade available for your DAW. The UAD-2 and version 6 software represents the culmination of a multi-year development effort delivering the latest in state-of-the-art audio processing technology and is the next evolution of the revolutionary, award-winning UAD Powered Plug-Ins & DSP Device Platform.

For many years our customers have been asking for a UAD with more power and the UAD-2 is all about putting more power in your hands – more power to track, mix and master. The UAD-2 OCTO offers, on average, an incredible 20 times the power of the UAD-1, while the UAD-2 Duo offers 5 times, and UAD-2 Solo offers 2.5 times the power. The UAD-2 Quad supports an awe-inspiring 128-channel Neve 88RS mixer at 44.1k. That’s a full console for the largest of professional mixes on ONE incredibly priced UAD-2 device!

Up to four UAD-2 devices can be mixed and matched to conveniently scale the DSP power you want at the price you can afford. Start with a Nevana 32 and instantly run a 32 channel Neve 88RS console. Then, simply add more devices for additional outboard FX or more mix channels as your needs grow. Pro power-users can now use up to four UAD-2 Quads for the most demanding applications with equivalent potency to 40 UAD-1 cards! Now inside-the-box mixing is as powerful as outside.

Once you’re settled in with your new UAD-2 select from our ever growing Powered Plug-Ins Collection to custom build your own virtual mixing console, mastering console, mix sidecar, or inboard dream-FX-rack. UA’s exclusive collection of revered studio gear includes classics from Neve®, Roland/BOSS®, Helios®, Fairchild, Pultec, SPL®, Moog®, Empirical Labs®, Manley Laboratories®, dbx®, Studer®, Ampex®, SSL®, Harmon/Lexicon®, and others, plus of course UA’s own 1176, LA-2A, and LA-3A compressors, and our critically acclaimed Precision Series lineup. Digital recreations of other seminal analog studio gems from other legendary analog manufacturers are always on the way.

The UAD-2 also includes version 6 of the UAD software, which has major driver enhancements and an all-new UAD Meter & Control Panel. Version 6 features multicore-aware drivers, LiveTrack™ for low-latency tracking and monitoring through UAD-2 plug-ins, and L.O.D.E.™ [Live Optimizing DSP Engine], which dynamically balances the load on the UAD-2. The new UAD Meter & Control Panel offers improved status monitoring, easy Quick-Click Plug Purchasing, Help and Support resources, Software Updates, and improved rollover help. There's also a new streamlined web shopping experience via a completely re-designed UA website with integrated audio and video demo's, tutorials, in-depth webzine articles, FAQ's and enhanced support so you can really get the most out of your UAD-2.

Developing the UAD-2 as well as Universal Audio's entire line of quality audio products designed to meet the needs of the modern recording studio while retaining the character of classic vintage equipment—has been a very special experience for me and for all who have been involved. We hope that you will enjoy using your UAD-2 and Powered Plug-Ins as much as we do.

Thanks for your support of Universal Audio.

Sincerely,
Bill Putnam, Jr.
CEO, Owner

A handwritten signature in black ink, appearing to read 'Bill Putnam, Jr.', with a long horizontal line extending to the right.

Features

- High-bandwidth x1 PCI Express card (PCIe 2.0 compatible)
- UAD-2 SOLO: low-profile, half-height, short PCIe card
- UAD-2 DUO/QUAD/OCTO: full-height, short PCIe card
- UAD-2 Satellite: DUO or QUAD in FireWire enclosure w/power supply
- 1, 2, 4, or 8 Analog Devices SHARC floating-point processors
- Multi-device support for up to four UAD-2's in one system
- Cross-Platform* for Mac and PC
- Supports VST, RTAS, and Audio Units plug-in formats
- 44.1, 48, 88.2, 96, 176.4, 192 kHz sample rate support for all plug-ins
- Drivers optimized for modern multi-thread and multi-processor architectures
- Real-time and faster than real-time processing for mix bounces
- LiveTrack™ low-latency mode for monitoring, tracking, and performance (PCIe devices only)
- L.O.D.E.™ (Live Optimizing DSP Engine) automatically balances DSP loads*
- LoadLock™ ensures resource availability on loaded plug-ins
- UAD Meter & Control Panel application
- UAD Toolbar for preset management
- Simple Registration/Authorization process via one button click
- World's best plug-in library with premier titles from Neve®, Roland®, Moog®, SPL®, Manley®, Empirical Labs®, SSL®, Pultec, and more
- 14-day full function demo for all plug-ins; try before you buy
- UAD Powered Plug-Ins™ available at the my.uaudio.com online store

*UAD-2 Satellite and Apollo are Mac Only

The UAD System

UAD Powered Plug-Ins is a hardware-plus-software system that consists of one or more UAD-2 DSP accelerator devices combined with the Powered Plug-Ins software. Various UAD-2 products are available to accommodate your particular computer system, processing needs, and budget. For the complete product lineup, visit our website at:

- www.uaudio.com

For a detailed overview about the UAD Powered Plug-Ins system and how it operates, see [Chapter 3, “UAD System Overview.”](#)

Package Contents

Each UAD retail package includes:

- Printed Information Sheet
- UAD DSP hardware device
- UAD Software Installer CD-ROM (with PDF user documentation)
- UAD-2 Satellite has additional contents (see [Chapter 11, “UAD-2 Satellite”](#))

UAD Documentation Overview

This section describes the various instructional and technical resources that are available for installing, using, and troubleshooting UAD Powered Plug-Ins. Documentation for the product line is available in written, video, and on-line formats.

ReadMe

The ReadMe contains important, late-breaking information that may not be available in other locations. Please review all the information in the ReadMe before installing or using UAD Powered Plug-Ins. The ReadMe file is presented for viewing during the software installation process, and it is installed to:

Windows

- Start Menu>All Programs>UAD Powered Plug-Ins

Mac

- Startup Disk/Applications/Powered Plug-Ins Tools

Operation Manuals

Documentation for UAD-2 and Powered Plug-Ins are separated by areas of functionality, as described below. The user manuals are on the software CD-ROM, and also placed inside the Powered Plug-Ins Documentation folder on the hard drive during software installation.

UAD System Manual

The UAD System Manual (PDF only) is the operation manual for overall UAD functionality and applies to the entire UAD product line. It contains detailed information about installing and configuring UAD devices, the UAD Meter & Control Panel application, how to use UAD Powered Plug-Ins within a DAW, obtaining optional plug-in licenses at the UA online store, and more. It includes everything about UAD except Apollo-specific information and individual UAD Powered Plug-In descriptions.

UAD Plug-Ins Manual

The features and functionality of all the individual UAD Powered Plug-Ins are detailed in the UAD Plug-Ins Manual (PDF only). Refer to this document to learn about the operation, controls, and interface of each plug-in.

Direct Developers

UAD Powered Plug-Ins includes plug-ins from our Direct Developer partners. Documentation for these 3rd-party plug-ins are separate files that are written and provided by the plug-in developers themselves. The filenames for these plug-ins are the same as the plug-in names.

Installed Locations

The UAD and Direct Developer manual files are copied to the hard drive by the software installer to the following locations:

Windows

- Start Menu>All Programs>UAD Powered Plug-Ins>Documentation

Mac

- Startup Disk/Applications/Powered Plug-Ins Tools/Documentation

Manual Conventions

UAD Powered Plug-Ins is a cross-platform solution for both Windows and Mac computers. * The UAD hardware device can be installed into either platform; it is the exact same hardware for both platforms. Operation of the plug-ins is practically identical regardless of the host system platform and application. However, certain platform-specific instructions will differ according to the host system you are using.

*UAD-2 Satellite and Apollo are Mac only.

Platforms Instructions in this guide that are platform-specific are indicated with a heading in red letters. Instructions that are identical regardless of platform are not differentiated.

Windows Instructions specific to the Windows platform use this red Windows heading.

Mac Instructions specific to the Mac platform use this red Mac heading.

UAD Nomenclature Unless specified otherwise, for descriptive purposes within this manual, “UAD-2” and “UAD” means all UAD-2 family products (SOLO, DUO, QUAD, OCTO, Satellite, Apollo).

Screen Shots Screenshots in this manual may be taken from the Windows and/or Mac version of the software, and are used interchangeably when the content and functionality of the screenshot is the same on both platforms. Slight variations in the appearance of a screenshot between operating systems are inevitable.

When the content of and function of the software represented in a screenshot is identical on both platforms, no differentiation is made in the screenshot title. If there is a significant difference between platforms, screenshots from both platforms are included.

Online Documentation

The technical support pages on our website offer a wealth of helpful information that is not included in the documentation contained within the software bundle. Please visit our support pages for important information including the latest software, release notes, updated technical news, and more. The main UAD Powered Plug-Ins support link is:

Support Website • www.uaudio.com/support

Videos Our website also contains many helpful videos that explain how to install UAD hardware and software, register and authorize the products, obtain optional plug-ins, and more:

• www.uaudio.com/videos

Blog Our blog is published regularly and contains lots of useful and interesting information. How-to pages, artist/producer/engineer interviews, support Q & A, detailed scientific notes, and other fascinating articles make the our blog a great place to routinely visit:

• www.uaudio.com/blog

Users Forum The unofficial UAD Powered Plug-Ins users forum, for the exchange of tips and information, is on the world wide web at:

- www.studionu.com/uadforums

Customer Support

Customer support is provided by Universal Audio staff to all registered UAD Powered Plug-Ins users (see “Registration” on page 41 for details).

Support Hours Our support specialists are available to assist you via email and telephone during our normal business hours, which are from 9am to 5pm, Monday through Friday, Pacific Standard Time.

Phone Support Customer Service & Technical Support
USA toll-free: 877-MY-UAUDIO (1-877-698-2834)
International: +1-831-440-1176
FAX: +1-831-461-1550

Online Support To request online support, please visit our support page, then click the blue “Submit Support Ticket” button in the right column to create a help ticket:

- www.uaudio.com/support

Factory Address Universal Audio, Inc.
1700 Green Hills Road
Scotts Valley, CA 95066-4926
USA

Main Website • www.uaudio.com

Feedback Your feedback on the performance and features of UAD Powered Plug-Ins is very important to us. Please send your comments and suggestions to us. Comments (not technical support issues) may be sent to:

- info@uaudio.com

CHAPTER 2

UAD Installation

Overview

UAD Powered Plug-Ins installation and configuration consists of four steps:

- UAD software installation
Insert the enclosed CD-ROM and run the installer.
- UAD hardware installation
Follow the instructions in this chapter.
- UAD device registration
Add your device to your [my.uaudio.com Account](#).
- UAD plug-in authorization
Download and apply UAD authorization file.

These steps are detailed in this chapter. Your host computer must meet the hardware and software requirements to operate properly, and you need a supported VST, RTAS, or Audio Units host application to run the UAD Powered Plug-Ins.

UAD-2 Satellite

This UAD product has its own set of hardware connection and operation instructions. Refer to [Chapter 11, “UAD-2 Satellite”](#) for complete details.

UAD-2 SOLO/Laptop

This UAD product has its own set of hardware connection and operation instructions. Refer to [Chapter 10, “UAD-2 SOLO/Laptop”](#) for complete details.

Install Videos

Our website contains many helpful support videos that explain how to install the hardware and software, register and authorize the product, obtain optional plug-ins, and more:

- www.uaudio.com/videos

System Requirements

UAD Powered Plug-Ins require the following hardware and software

Windows (32-bit and 64-bit):

- Windows 7 Home Premium, Professional, or Ultimate Edition

Mac OS X (32-bit and 64-bit):

- Mac OS X 10.6 Snow Leopard, 10.7 Lion, or 10.8 Mountain Lion

All Platforms:

- 2GB available hard drive space
- Available PCI Express (PCIe) slot for each UAD-2 card
- Available Firewire 800 or Firewire 400 port for UAD-2 Satellite
- 1024 x 800 minimum display resolution
- Internet connection or CD-ROM drive for software installation
- Internet connection required for registration and plug-in authorization
- Compatible VST, RTAS, or Audio Units plug-in host application software (see [Table 1 on page 17](#))

Supported Hosts

UAD Powered Plug-Ins, when combined with a plug-in host application, is a technically complex system with many variables. Because the host application environment is integral to the system but is completely out of our control, we cannot claim compatibility with all hosts that may claim to support the use of VST, RTAS, and/or Audio Units plug-ins.

We test the specific host applications listed in [Table 1 on page 17](#) below for compatibility with UAD Powered Plug-Ins. We recommend the latest versions of these host applications for optimum performance. Host applications that are not listed may work with UAD Powered Plug-ins, but compatibility with them cannot be guaranteed.

Table 1. Supported UAD Host Applications

Supported UAD Hosts
Avid Pro Tools LE, 9, & 10 (Mac & PC)
Avid Pro Tools HD (Mac & PC)
Steinberg Cubase/Nuendo (Mac & PC)
Ableton Live (Mac & PC)
Apple Logic Pro (Mac)
Cakewalk Sonar (PC)
MOTU Digital Performer (Mac)

For detailed technical information about using UAD Powered Plug-Ins with these supported hosts, please review the Host Application Notes pages on the UAD website:

- www.uaudio.com/support/uad/compatibility

Latest Information & Software Updates

Technical Updates

Updated UAD technical information is regularly posted to the UA website. Please visit the UAD support pages for the latest bulletins:

- www.uaudio.com/support

Software Updates

The CD-ROM in the retail package may not contain the latest UAD software. Check our website for software updates:

- www.uaudio.com/downloads

If the UAD software is already installed, the UAD Meter & Control Panel application has a convenient button that checks for the most recent version (see “Check for Updates” on page 52).

UAD Software Installation

Install Software First

If you are installing UAD Powered Plug-Ins for the first time, install the software before installing the UAD device(s). This is particularly important on Windows systems for plug-and-play functionality. If you are updating to a newer version of the software or installing additional UAD devices, it is not necessary to remove the previous UAD software or hardware from the system, but you should still install the newer software before adding new devices.

Note: *The UAD Powered Plug-Ins software installer is identical for all UAD hardware (there are only two UAD installers, one each for Win & Mac).*

Install Options

The UAD software is comprised of many components, and the version of all the components must match for proper operation. When the UAD installer is run, all existing UAD components are deleted to avoid version mismatch. Therefore, it is necessary to select all the desired driver and plug-in format options during each UAD installation. Partial installations are not possible.

Important: *Select all desired options each time the UAD installer is run. Previously installed components are deleted during installation.*

Win & Mac

Software installation and removal for Windows and Mac platforms have their own particular procedures; each are described below.

Important: *Close all open files and applications before starting the installation procedure. Specifically, make sure the UAD Meter & Control Panel and all UAD host applications are not running.*

Windows Install



Software Installation Procedure for Windows Systems

Important: *Verify the computer system date and time are set correctly before installing the software and/or launching the UAD Meter & Control Panel application for the first time.*

1. Launch the software installer.
 - To install from CD-ROM, insert the UAD Powered Plug-Ins CD. If the installer doesn't automatically run, double click the Setup.exe application located at the root of the CD.
 - To install from a download, double-click the downloaded software archive, which is an executable application. The installer will run automatically.
2. Setup will guide you through the installation procedure. Take care to select the proper component package(s) for your system.

3. When installation has completed, power down your computer to install the UAD devices(s) following the instructions on [page 20](#). If the UAD device is already installed or you are updating, simply restart the system.
4. After restarting, the New Hardware Wizard will try to locate the new drivers. Follow these steps:
 - a) Select the “Install the software automatically (Recommended)” option, and click “Next.”
 - b) The UAD device driver will be installed, click “Finish” when it is complete.

Software installation is now complete. Proceed to the Authorization section ([page 22](#)).

You can use the UAD Meter & Control Panel to verify installation (see “[Verifying Installation](#)” on [page 26](#).)

Note: *If you want to install the UAD plug-ins into another application, run the installer again.*

Mac Install



Software Installation Procedure for Mac Systems

Important: *Verify the computer system date and time are set correctly before installing the software and/or launching the UAD Meter & Control Panel application for the first time.*

1. Launch the software installer.
 - To install from CD-ROM, insert the UAD Powered Plug-Ins CD. Open the CD window, then double-click the application named “UAD Powered Plug-Ins Installer.”
 - To install from a download, first decompress the downloaded zip archive by double-clicking it. Then double-click the UAD Powered Plug-Ins Installer application.
2. The installer will guide you through the installation procedure. Take care to select the proper component package(s) for your system.
3. Restart the computer after the software is installed.

Software installation is now complete. Proceed to hardware installation or if that is done already, proceed to the Authorization section ([page 22](#)).

Verify Install

You can use the UAD Meter & Control Panel to verify installation (see “[Verifying Installation](#)” on [page 26](#).)

Installed Locations

The UAD Meter & Control Panel application and UAD documentation is copied to these locations on the hard drive during installation:

Windows



- C:\Program Files\Universal Audio\Powered Plug-Ins

You can access these files from the Windows Start Menu at:

- Start>All Programs>UAD Powered Plug-Ins

The VST plug-in files are installed to the location specified during installation.

Mac



- Startup Disk/Applications/Powered Plug-Ins Tools

The plug-in files are installed to the standardized OS X locations:

- VST: Startup Disk/Library/Audio/Plug-Ins/VST/Powered Plug-Ins
- Audio Units: Startup Disk/Library/Audio/Plug-Ins/Components
- RTAS: Startup Disk/Library/Application Support/Digidesign/Plug-Ins

UAD Hardware Installation

Note: The UAD software should be installed before installing the UAD DSP device(s). See the previous section for software installation instructions.

UAD-2 SOLO/Laptop

UAD-2 SOLO/Laptop is a UAD product designed for use with the Express-Card expansion slot typically found on notebook computers. It has its own set of hardware connection and operation instructions. Refer to [Chapter 10, “UAD-2 SOLO/Laptop”](#) for complete details.

UAD-2 Satellite

The UAD-2 Satellite is a UAD product that is designed for use with the Firewire port. This product has its own set of hardware connection and operation instructions. Refer to [Chapter 11, “UAD-2 Satellite”](#) for complete details.

About PCI and PCI Express

PCI and PCI-X should not be confused with PCI Express (also known as PCIe). PCIe is not compatible with PCI or PCI-X because PCIe uses a completely different connector (see [Figure 1 on page 21](#)).

UAD-2 SOLO, DUO, and QUAD cards are all PCIe cards. They will ONLY work in PCI Express (PCIe) slots. Be careful to only install the UAD-2 card into a PCIe slot.

PCI/PCI-X

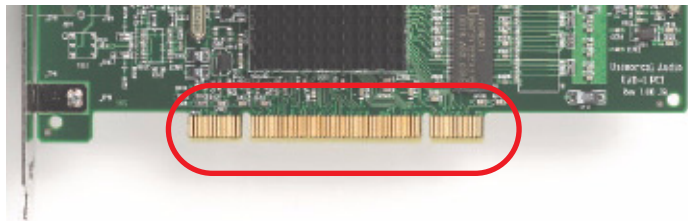

PCI Express (PCIe)

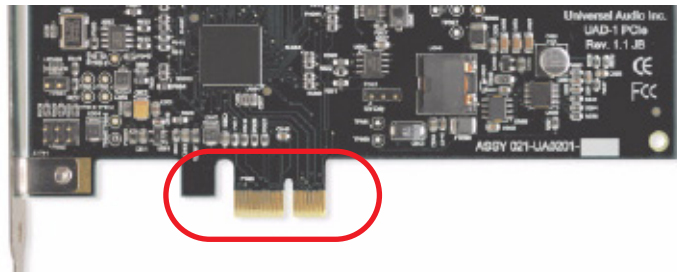

Figure 1. PCI and PCIe connectors are incompatible.

UAD-2 PCIe Speed

UAD-2 cards are “x1” PCIe cards. Although these cards can be installed into any speed PCIe slot (x1/x4/x8/x16), putting a them in any PCIe slot faster than x1 will not improve UAD performance.

Installing the UAD Cards

After installing the UAD Powered Plug-Ins software, install the UAD DSP card(s). Hardware installation is the same for all platforms.

Note: *If necessary, refer to the computer manufacturer’s documentation for instructions about installing PCIe cards.*

To install the UAD DSP card(s):

1. Install the UAD software first ([page 18](#)).
2. Power down the computer system.
3. Open the computer case.
4. Remove the rear screw and cover of an available PCIe expansion slot.
5. Before handling the UAD card, discharge any static electricity by touching the metal casing of the power supply.
6. Remove the UAD card from its protective anti-static bag. Do not touch the gold edge connector contacts.

7. Hold the card gently by the top edges, and line up its connector with the slot inside the computer.

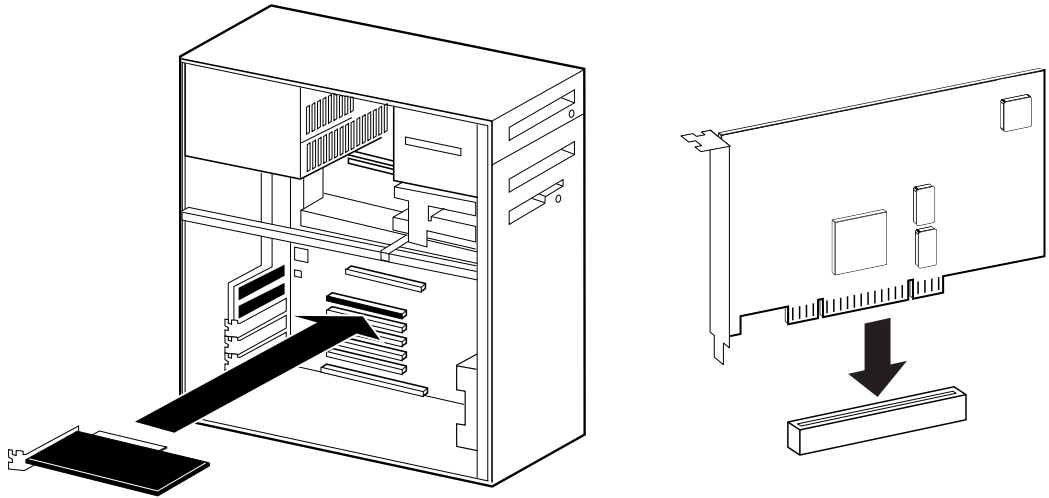

Figure 2. UAD-2 card installation in PCIe slot.

8. When the connector and slot are aligned, press the card into the slot with firm, even pressure. The card should “pop” into place. The top of the slot on the motherboard should be flush and parallel with the edge of the UAD card.
9. Secure the card with the previously removed screw.
10. Replace the computer case.

Hardware installation is now complete. Proceed to Authorization in the next section.

Authorization

Your UAD device must be registered at my.uaudio.com to download an authorization file, and you need a my.uaudio.com account to register the device. These steps are detailed in the “[Authorize Plug-Ins Procedure](#)” on [page 23](#).

Important: *All UAD plug-ins must be authorized before they can be used (unauthorized plug-ins can be used in demo mode for 14 days without authorization). Authorization is accomplished by clicking the “Authorize Plug-Ins” button in the UAD Meter & Control Panel application. The procedure is in the next section.*

Authorize Plug-Ins Procedure

This procedure provides only the step-by-step process for UAD authorization. A complete overview of UAD authorization, my.uaudio.com, and the UA online store is in [Chapter 4, “My.uaudio.com.”](#)

Note: *The following procedure requires an internet connection on the UAD host computer. To authorize from a system that is not online, see “Offline Authorization” on page 24.*

Online Authorization

To download and apply the UAD authorization file when connected to the internet:

1. Install the UAD Powered Plug-Ins software and the UAD hardware using the procedures detailed in this chapter (the system must be operating properly).
2. Launch the UAD Meter & Control Panel application ([see page 49](#)) and open the Plug-Ins panel ([see page 51](#)).
3. Click the “Authorize Plug-Ins” button ([page 55](#)). The my.uaudio.com online store opens in the default web browser.
 - If you don’t already have a my.uaudio.com account, you are directed to create one. Follow the instructions online.
 - If you already have a my.uaudio.com account, login with your email address and password. If your password is lost, the store can email it to you.
4. Your device will be automatically registered and added to your “My Systems” computer group, and your authorization file is generated.
5. Click the “Download Authorization” button at the bottom of the registration page to download the “auth.uad2” file. The authorization file is downloaded by the browser to the location specified in the browser preferences.
6. Double click the auth.uad2 file. The authorization is loaded onto the UAD device(s) and after a few seconds the “Authorizations Updated Successfully” window appears ([Figure 3](#)).

Online UAD authorization is now complete, and UAD Powered Plug-Ins are ready for use.

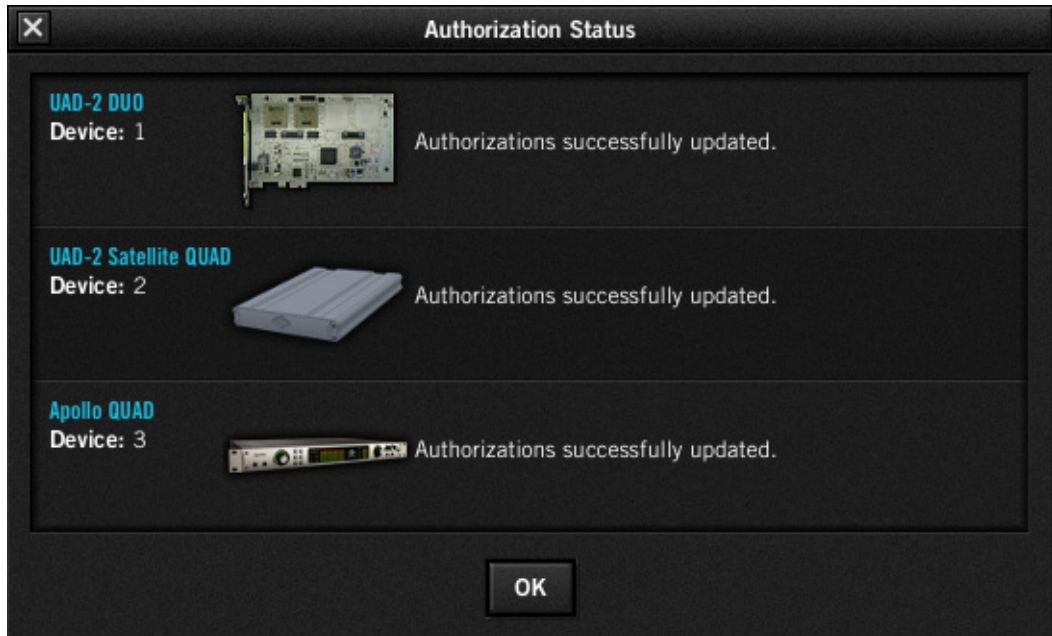

Figure 3. The authorization successful window

Offline Authorization

Note: If the UAD computer is not connected to the internet, you will need to manually transfer the registration URL into the browser of a web-enabled computer.

To download and apply the UAD authorization file if not connected to the internet:

1. Install UAD Powered Plug-Ins software and the UAD hardware using the procedures detailed in this chapter (the system must be operating properly).
2. Launch the UAD Meter & Control Panel application (see page 49) and open the Plug-Ins panel (see page 51).
3. Click the "Authorize Plug-Ins" button (page 55). The default web browser opens with the registration URL in the address bar (and you may get an error that the computer is not connected to the internet).
4. You must enter this URL into a web-connected computer, so either:
 - a) Drag the URL icon to the Desktop to create a weblink shortcut (preferred, Figure 4 on page 25) then transfer the weblink shortcut to the internet computer via a storage device or network, OR
 - b) Carefully write down the URL, EXACTLY as it appears.
5. Go to the URL using a web browser on an internet-connected computer. Double-click the transferred weblink shortcut, or enter the URL as noted.

- If you don't already have a my.uaudio.com account, you are directed to create one. Follow the instructions online.
 - If you already have a my.uaudio.com account, login with your email address and password. If your password is lost, the store can email it to you.
6. Your device will be automatically registered and added to your "My Systems" Computer group, and your authorization file is generated.
 7. The authorization file should begin downloading automatically. Click the "Download Authorization" link to download the auth file if not.
 8. Transfer the authorization file to the UAD computer via a storage device or network.
 9. Double-click the authorization file. The authorization is loaded onto the UAD device(s) and after a few seconds the "Authorizations Updated Successfully" window appears (Figure 3).

Online UAD authorization is now complete, and UAD Powered Plug-Ins are ready for use.

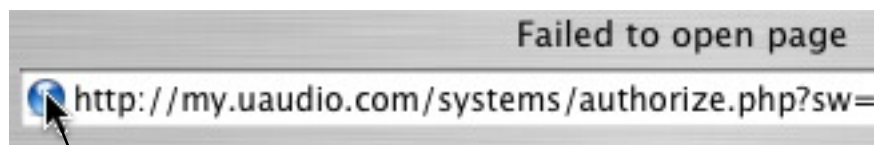

1. Click + hold this URL icon in the browser's address bar, then...

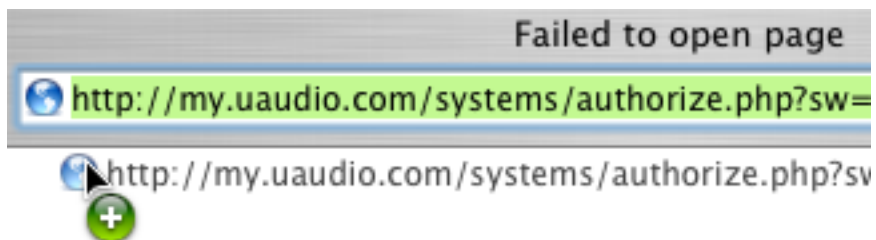

2. Drag the icon to the Desktop and release to create a weblink shortcut for easier transfer.

Figure 4. To authorize a system that is not connected to the internet, create a weblink shortcut on the UAD system for easier transfer of the URL to an online system.

Verifying Installation

The [UAD Meter & Control Panel](#) displays the current resource loads of the UAD DSP hardware device in realtime. It also contains the System Information panel, where UAD software and hardware installation can be verified to ensure the system is working properly.

To confirm proper UAD installation and operation:

1. Launch the UAD Meter & Control Panel application ([see page 49](#)).
2. Open the System Information panel ([see page 51](#)).
3. When the UAD device is displayed in the Hardware area and its status is "OK" then the UAD driver is communicating with the UAD device and the system is operating properly.

UAD-2 LED

The UAD-2 has an LED indicator. This LED provides certain indications about the operational state of the UAD-2. The location of the LED depends on the UAD-2 product. On UAD-2 PCIe cards, the LED is on the mounting bracket of the card. On the SOLO/Laptop, the LED is next to the UA logo on the black housing. On UAD-2 Satellite, the LED is on the rear panel.

Alternating red and green

When the LED alternates between solid red and solid green, the device is powered up properly but the UAD driver is not yet loaded or communicating with the device. This is the expected state if the device is installed but the software is not yet installed, or when booting the system and the UAD driver is not yet loaded.

Solid green

When the LED is solid green, the UAD driver is loaded and properly communicating with the device. This is the normal state when using UAD Powered Plug-Ins.

Solid red or other blinking patterns

When the LED is producing any pattern other than the two conditions above, there is a problem with communication between the driver and the device. Try a cold reboot (complete power down) and/or reinstalling the UAD software before contacting customer support.

Software Removal

To remove all UAD software from the computer:

Windows



1. From the Windows Start Menu at, select:
 - Start>All Programs>UAD Powered Plug-Ins>Remove UAD Powered Plug-Ins
2. The UAD software is removed.

Mac



1. Launch the UAD Powered Plug-Ins Installer application. Click through the splash screen and license agreement.
2. When you get to the install screen, select “Uninstall” from the drop menu.
3. Click the “Uninstall” button. The UAD software is removed.
4. Drag the UAD Meter & Control Panel icon out of the Dock.

UAD software removal is complete.

Important: Power down the computer before removing any UAD cards.

Using Unlicensed Plug-Ins (Demo Mode)

To run unlicensed UAD plug-ins after authorization, see “[Demo Mode](#)” on [page 40](#). To redeem vouchers or coupons, or purchase additional UAD plug-in licenses, see “[UA Online Store](#)” on [page 41](#).

Learn More

After installation, registration, and authorization, you’re ready to use UAD Powered Plug-Ins. We especially recommend reading chapters 3, 4, 6, and 7 in this manual to gain important insights about using the product.

Visit our support site for the latest technical information and additional information not included with the software, or to contact technical support about any technical difficulties:

- www.uaudio.com/support

Our website also contains many helpful videos that explain how to install the hardware and software, register, authorize, and use the product, obtain optional plug-ins, and more:

- www.uaudio.com/videos

CHAPTER 3

UAD System Overview

The UAD Environment

The complete UAD Powered Plug-Ins environment consists of many components. These components are:

- One or more UAD DSP hardware accelerator devices
- The UAD device drivers
- The UAD plug-ins
- The host computer system
- The plug-in host application software (DAW)
- An audio hardware input/output interface and its drivers

All these components operate together simultaneously within one computer to form the complete audio processing system.

The other UAD component is your account at my.uaudio.com (page 36) and the UA online store, where UAD devices are registered, UAD coupons are redeemed, and UAD plug-in licenses and authorizations are obtained. Although my.uaudio.com is not required during normal system use, it is essential for initializing the overall UAD system because authorization is required to use UAD-Powered Plug-Ins (see “[Authorization Overview](#)” on page 37).

The UAD Hardware

The UAD DSP (Digital Signal Processing) hardware accelerator devices provide the “power” behind UAD Powered Plug-Ins. Most UAD plug-ins use extremely complex algorithms to provide the quality sound and accurate modeling Universal Audio is famous for. The UAD processor engines are significantly more optimized to perform the complex DSP routines required for these algorithms than a standard desktop computer CPU can deliver.

All UAD-2 devices are Mac and Windows compatible unless stated otherwise; the hardware is identical for both OS platforms.

Note: Multiple UAD hardware types can be used concurrently in the same computer. For details, see [Chapter 5, “Using Multiple UAD Devices.”](#)

UAD-2 Family



UAD-2 is our second-generation UAD product line that offers many improvements over the original UAD-1; most notable is significantly increased DSP horsepower. Each UAD-2 DSP provides approximately 2.5x the processing power of the UAD-1, therefore one UAD-2 OCTO offers approximately 20 times the processing power of UAD-1.

A variety of UAD-2 models are available to suit various processing and protocol needs. Each model is defined by its number of DSP chips (1, 2, 4, or 8) and its connection protocol (PCIe or Firewire). Up to four UAD-2 devices can be run concurrently in one system.

Note: UAD-1 is a discontinued product.

SOLO/DUO/ QUAD/OCTO

UAD-2 devices are designated as SOLO, DUO, QUAD, or OCTO which indicates the number of SHARC® DSP chips in each device. SOLO devices have one DSP, DUO devices have two DSPs, QUAD devices have four DSPs, and OCTO devices have eight DSPs.



UAD-2 PCIe Cards



UAD-2 PCI-Express (PCIe) cards are available in SOLO, DUO, QUAD, and OCTO configurations. All UAD-2 PCIe cards use the PCIe "x1" architecture, which offers plenty of data bandwidth for even the most demanding audio processing requirements, such as four UAD-2 OCTOs (32 DSPs) in the same system.

UAD-2 SOLO/Laptop

The UAD-2 SOLO/Laptop is a self-contained UAD-2 Solo device housed entirely within an Express-Card/34 expansion card for use with notebook systems. No external cables or power is required, for the ultimate in mobile DSP capability. UAD-2 SOLO/Laptop has special instructions for installation, connectivity, and use. See [Chapter 10, "UAD-2 SOLO/Laptop"](#) for complete details.



Note: UAD-2 SOLO/Laptop is a discontinued product.

UAD-2 Satellite

The UAD-2 Satellite is available in DUO and QUAD versions and is enclosed in an attractive housing that uses an external power supply. It connects via Firewire, enabling **Powered Plug-Ins** on Mac systems that don't have PCIe or ExpressCard slots. See **Chapter 11, "UAD-2 Satellite"** for complete details.



Apollo

Apollo is UA's high-resolution 18 x 24 audio interface with class-leading sound quality, Realtime UAD Processing, FireWire/Thunderbolt connectivity, and elegant hardware design and workflow.



The UAD functionality of Apollo's built-in UAD-2 processor is documented in this manual. However, functionality that is unique to Apollo is documented separately in the Apollo hardware and software manuals.

UAD-2 Products

UAD-2 devices are available in a variety of retail configurations to best accommodate your budget and processing requirements. The products have various DSP counts (Solo/Duo/Quad), form factors (PCIe, FireWire), and plug-in bundles. For complete details about all available products, visit:

- www.uaudio.com

UAD-1 vs. UAD-2 (SOLO, DUO, QUAD) Power Comparison Meter

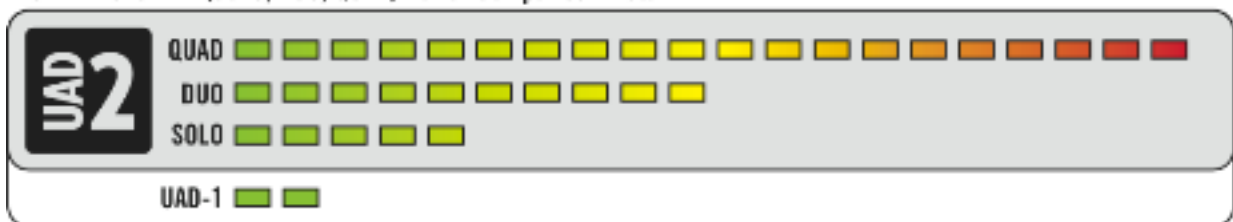

The UAD Software

The UAD Powered Plug-Ins software consists of the UAD installer, the UAD plug-ins, the UAD Meter & Control Panel application, the UAD device drivers, and the user documentation.

Installer



The UAD Powered Plug-Ins software installer contains all the UAD software components (plug-ins, drivers, and documentation) and copies them to disk during installation. There is one UAD software installer for each OS platform (Windows and Mac). The UAD software installer supports all variations of UAD hardware devices.

Powered Plug-Ins



Powered Plug-ins are the VST, RTAS, and Audio Units plug-in files that are loaded within the host application. The plug-ins are where the graphical user interface (GUI) is seen (Figure 18 on page 72) and where the various control parameters can be manipulated to achieve the desired result.

The UAD software installer always installs the complete suite of all available Powered Plug-Ins. However, all of the installed UAD plug-ins may not be licensed. The included licenses depends on the retail package bundle (see “Bundled Plug-Ins” on page 36).

Optional Plug-Ins

Most UAD plug-ins require optional licenses to run without restrictions. Optional plug-in licenses are obtained at my.uaudio.com, the Universal Audio online store. Licenses can be purchased separately, or they can be purchased with coupons that are bundled in most retail packages.

Demo Mode

UAD plug-ins that are unlicensed can be run in Demo Mode in a 14-day trial period without any functional restrictions. See [page 40](#) for details.

Bundled Licenses and Coupons

Your account at the my.uaudio.com online store is where bundled software and coupons are redeemed and where additional licenses can be purchased. See [Chapter 4, “My.uaudio.com”](#) for details.

Note: When you purchase an optional license, you don’t download that individual plug-in. Instead, you download a newer authorization, which enables the plug-in file that is already installed.

UAD Meter & Control Panel



The UAD Meter & Control Panel ([page 48](#)) is a utility application that is used to monitor and configure UAD device resources. It has two main windows: the UAD Meter, and the UAD Control Panel.

The UAD Meter window ([Figure 7 on page 48](#)) displays the current DSP, program, and memory status of the UAD hardware in realtime. The UAD Control Panel window ([page 51](#)) has multiple panels that display and modify various system, plug-in, and global configuration parameters.

UAD Drivers

The UAD device drivers are the low-level system software files that instruct the host computer system on how to communicate with the UAD hardware device(s). The UAD drivers are loaded during system startup so the UAD devices are ready to be used when the plug-in host application is launched.

In addition to instructing the OS on how to control the UAD hardware, the driver acts as a software “middleman” between the host application and the UAD hardware. The host application uses the driver to route UAD signals in the DAW.

Each UAD device family (UAD-2 or Apollo) has its own set of drivers. One or both are specified during UAD software installation, depending on which device type(s) you intend to use.

UAD Buffers and Latency

The UAD drivers use “buffers” to shuttle audio signals to and from the device. This means the digital data is transferred in small batches instead of continuously. Buffering induces a very small audio latency (delay) that is inherent in most digital audio systems and can be detected in certain situations.

UAD latency is managed automatically by most host applications and can be reduced to undetectable levels in the UAD-2 (see [“LiveTrack Mode” on page 75](#)). Latency and buffers are discussed in greater detail in [Chapter 9, “UAD Delay Compensation.”](#)

User Documentation



Various instructional and technical resources are available for installing, using, and troubleshooting UAD Powered Plug-Ins. UAD documentation is available in written, video, and online formats. For details about user documentation, see [“UAD Documentation Overview” on page 11](#).

The DAW Environment

The digital audio workstation (DAW) environment is a complete system where audio production takes place (either with or without UAD Powered Plug-Ins). The UAD system is an add-on to a computer-based DAW that can dramatically improve the sonic quality and performance of the DAW, while still working entirely from within the DAW.



A computer-based DAW consists of the host computer hardware and its operating system (OS) software, the plug-in host application (DAW software), and an audio input/output (I/O) interface and its drivers.

Host Computer

The host computer is the system that the host DAW application software runs on and the UAD devices are installed into. The host computer must meet minimum technical requirements and have one or more compatible expansion slots to use with UAD hardware. See “[System Requirements](#)” on page 16 for complete details.

Operating System



The host computer runs an operating system (e.g., Windows 7 or Mac OS X) that defines the OS “platform” of the system. UAD Powered Plug-Ins is a cross-platform product that is (for practical purposes) functionally identical on Windows and Mac systems (except as otherwise noted).

Host Application

The plug-in host application is the software DAW environment where audio recording, playback, mixing, and other production functions are controlled. UAD plug-ins are accessed and operated from within the host software application.

Each host application has a unique feature set and different methods of operation, including how to use plug-ins. However, once UAD plug-ins are loaded, UAD plug-in operation is identical in all host applications.

Each host application has its own set of system requirements. In addition to the UAD-specific system requirements, the host computer must meet the host application system requirements.

Because the host application environment is integral to the UAD system but is completely out of our control, we cannot claim compatibility with all hosts that may support use of the UAD plug-in formats. See [“Supported Hosts” on page 16](#) for complete details.

Plug-In Formats

UAD Powered Plug-Ins includes support for VST, RTAS, and Audio Units plug-in formats. These formats define the software protocols that the host application uses for plug-in processing.

UAD Powered Plug-Ins operations are (for practical purposes) functionally identical in all three plug-in formats. The format of the installed UAD plug-in files are specified during UAD software installation.

VST

The VST (“Virtual Studio Technology”) plug-in format is developed by Steinberg and is supported by various Windows and Mac host applications.



RTAS

The RTAS (“Real-Time AudioSuite”) plug-in format is developed by Avid and is supported by Pro Tools host applications on Windows and Mac platforms.



Audio Units

The Audio Units (“AU”) plug-in format protocol was developed by Apple and is supported by various host applications on the Mac platform only.



Audio Units

Audio Interface

The audio hardware input/output (“I/O”) interface is how audio signals get into and out of the host computer. An audio interface is a hardware+driver device that can have analog or digital I/O, or both. The interface is usually where the analog-to-digital (“A/D”) and digital-to-analog (“D/A”) audio conversions take place. Universal Audio’s Apollo is an audio interface.

I/O Drivers

The audio interface is a hardware device that requires a software device driver for the host computer OS. In addition to instructing the OS on how to control the interface hardware, the driver acts as a software “middleman” between the host application and the I/O ports. The host application uses the driver to access the I/O for signal routings.

I/O Buffers and Latency

Like the UAD device, audio interface driver also uses “buffers” to shuttle audio signals to and from the I/O (see [“UAD Buffers and Latency” on page 32](#)).

Smaller I/O buffer settings produce lower latencies which is useful when monitoring tracks while recording performances, but usually results in a higher host computer CPU load since the system has to work harder transferring data. Latency and buffers are discussed in greater detail in [Chapter 9, “UAD Delay Compensation.”](#)

My.uaudio.com

My.uaudio.com is the UA online store, where UAD devices are registered to your account and authorization files can be obtained. Bundled plug-ins and coupons are redeemed at the store and optional plug-in licenses can be purchased there as well. For complete details about my.uaudio.com, including accounts, registration, purchasing plug-ins at the online store, and more, see [Chapter 4, “My.uaudio.com.”](#)

Authorization

All UAD plug-ins must be authorized before they can be used. Authorization is accomplished by simply clicking the “Authorize Plug-Ins” button ([page 55](#)) in the UAD Meter & Control Panel. For complete details about the authorization system, see [“Authorization Overview” on page 37](#).

CHAPTER 4

My.uaudio.com

My.uaudio.com is the Universal Audio online store where UAD devices are registered to your account and UAD plug-in authorizations are obtained. Bundled plug-in coupons are redeemed at the store and optional plug-in licenses can be purchased at my.uaudio as well. This chapter provides details about UAD plug-in authorization and licensing, and the my.uaudio.com store.

Important: All UAD plug-ins must be authorized before they can be used. Authorization is accomplished by clicking the “Authorize Plug-Ins” button (page 55) in the UAD Meter & Control Panel. For instructions, see “Authorize Plug-Ins Procedure” on page 23. For complete details, see “Authorization Overview” on page 37.



Figure 5. Accessing my.uaudio.com at www.uaudio.com

Optional Plug-Ins

Most UAD Powered Plug-Ins require optional licenses to run without restrictions. Optional plug-in licenses are obtained at my.uaudio.com, the Universal Audio online store. Licenses can be purchased separately (page 42), or they can be purchased with coupons that are bundled in most retail packages.

Bundled Plug-Ins

UAD plug-ins that are bundled with the UAD device are automatically licensed when the device is registered. After registration, the [Authorization File](#) must be loaded to enable the bundled plug-ins.

Note: UAD devices must be authorized to run bundled (included) plug-ins. See “Authorization Overview” on page 37 for details.

Coupons

Coupons included in UAD retail packages have dollar values that are as “good as cash” for buying UAD plug-ins at my.uaudio.com. Coupons are applied to your my.uaudio.com account automatically when you register your device by clicking the [Authorize Plug-ins button](#). After registration, the coupon dollar amount is in your account as a credit, ready to be applied to your store purchase.

Coupons expire after a limited time period, and they can be used only once.

Tip: Coupons are a great reason to subscribe to promotional announcements. Email subscription preferences are specified on your “My Profile” page at my.uaudio.com (see “My Profile” on page 42).

Plug-Ins are already installed

The UAD software installer always installs the complete suite of available UAD plug-ins to the hard drive during installation. Therefore when you purchase an optional license, you don’t download that individual plug-in. Instead, you download a newer authorization file, which activates the plug-in file that is already installed.

Important: Older versions of the UAD software may not include all the latest UAD plug-ins. To ensure all UAD plug-ins are installed, and for optimum performance, we recommend updating to the latest UAD version. See “Check for Updates” on page 52.

Authorization Overview

All UAD plug-ins must be authorized before they can be used. Authorization is accomplished by clicking the [Authorize Plug-ins button](#) in the UAD Meter & Control Panel, then loading the downloaded authorization file. For instructions, see “Authorize Plug-Ins Procedure” on page 23.

Video Help

Our support website contains many helpful videos that explain how to register and authorize the product, obtain optional plug-ins, and more:

- www.uaudio.com/blog/cat/videos

Procedure

This section is a detailed overview of the entire UAD authorization system. For the step-by-step authorization instructions, see “Authorize Plug-Ins Procedure” on page 23 in Chapter 2, “UAD Installation.”

Note: Without authorization, UAD plug-ins can be enabled to run for 14 days without functional limitations in a timed demo mode (see “Demo Mode” on page 40).

Important: Your UAD device must be registered at my.uaudio.com to download an authorization file, and you need a my.uaudio.com account to register the device.

Authorize Plug-Ins

The registration/account/authorization process isn't as complicated as it may seem. The entire routine involves simply clicking the “Authorize Plug-Ins” button (page 55) in the UAD Meter & Control Panel. Clicking this button automatically registers the installed UAD devices, generates the authorization file, and downloads it to disk.



Just double-click the downloaded authorization file or drag onto any UAD Meter & Control Panel icon and you're ready to use UAD Powered Plug-Ins. When authorizing, you'll be prompted to log into your account if you aren't already, and if you don't already have an account, you'll be prompted create one.

Authorization File

The “auth.uad2” authorization file, which is obtained by clicking the “Authorize Plug-Ins” button (page 55), contains the license key(s) that enable UAD plug-ins to run on associated UAD devices. The authorization file is generated at my.uaudio.com then downloaded to the local hard drive automatically.

Loading

To load a downloaded authorization file, just double-click it, or drag-drop it onto any UAD Meter & Control Panel application icon/shortcut/alias (see Figure 3 on page 24).

My Systems

The UAD devices and plug-ins that you own and can authorize can be found in your My Systems page at my.uaudio.com. My Systems keeps track of which UAD devices are in which computer, and the authorization status of each UAD plug-in. The current license state is also shown in the “Plug-Ins” panel in the UAD Meter & Control Panel application.

My Systems is managed automatically by my.uaudio.com and the UAD software. When “Authorize Plug-Ins” is clicked, devices in the host system are added to My Systems. When an authorization file is downloaded, it reflects the current state of My Systems.

System

All the UAD devices installed in a single host computer system, and the UAD plug-in license status for those devices, is referred to as a “System” (formally known as “Group”) on the My Systems page at my.uaudio.com. When you click the “Authorize Plug-Ins” button, UAD devices in the host computer are automatically registered and added to a System.

The UAD hardware identification numbers for each UAD device in a single host computer are stored in the same System. Authorization files generated at my.uaudio.com are constrained to only authorize the licensed UAD plug-ins running on the UAD devices in the same System. The same authorization file authorizes all the devices and plug-ins in the host computer.

If you register a UAD device that is in a second host computer using the same my.uaudio account, a second System is automatically created at My Systems. In accordance with the [“Plug-In License Policy” on page 44](#), you can’t have UAD devices from two separate computers in the same System. Each System generates a unique authorization file.

Authorization Notes

- UAD devices must be authorized to run bundled (included) plug-ins. See [“Authorization Overview” on page 37](#) for details.
- Without authorization, UAD plug-ins can be enabled to run for 14 days without functional limitations in a timed demo mode (see [“Demo Mode” on page 40](#)).
- Older versions of the UAD software may not include all the latest UAD plug-ins. To ensure all UAD plug-ins are installed, and for optimum performance, we recommend updating to the latest UAD version. See [“Check for Updates” on page 52](#).
- Optional plug-ins are contained within the UAD software installer, not the “auth.uad2” authorization file. Download and install the latest UAD software version to ensure the optional plug-ins that you are authorizing are installed.
- The auth.uad2 authorization file contains plug-in license keys for the specific UAD devices in each computer group at [My Systems](#). The file will not authorize any other UAD devices.
- An authorization file is not associated to the host computer or the UAD installer in any way. Instead, it is associated with the UAD devices at [My Systems](#) (it’s the UAD hardware that is authorized, not the UAD plug-ins or computer).

- During authorization, the UAD plug-in license state is stored on the UAD-2 device. If the UAD-2 is moved to another computer, it is not necessary to reload an authorization file.

Demo Mode

All unlicensed UAD plug-ins include a free 14-day trial evaluation period. When the demonstration mode is activated, the plug-in will run without functional limitations for 14 days. Demo mode can be activated once only. After the demo trial period has expired, demo mode cannot be activated again on the same UAD device.

If an unlicensed plug-in is loaded and its demo has never been started, a dialog appears with instructions to start the demo and the option to visit the online store to purchase the license. If you don't start the demo or purchase a license, the plug-in interface appears and can be manipulated, but audio is not processed by the plug-in.

Important: *The 14 day demo period can only be activated once, and cannot be stopped or restarted during this period! We recommend you do not activate demo mode until you have the time to thoroughly check out its sound and functionality.*

Demo Activation

To activate demo mode:

1. Ensure UAD Powered Plug-Ins version 5.0 or higher is already installed and configured properly (see [Chapter 2, "UAD Installation"](#)).
2. Launch the UAD Meter & Control Panel application ([page 49](#)).
3. Select "Plug-Ins..." from the Control Panel Menu ([page 51](#)). The UAD Plug-Ins panel ([Figure 11 on page 57](#)) appears.
4. Click the [Start Demo](#) button for the desired UAD plug-in. A confirmation window appears and the timed demo can be activated or demo activation can be cancelled.

The timed demo is activated for 14 days.

Demo Notes

- In addition to the Plug-Ins panel, Demo mode can also be activated directly from the UAD Toolbar (see [page 73](#)).
- Manipulating the computer's system date and time will result in a decreased demo period.

UA Online Store

The UA online store at my.uaudio.com (Figure 6) is where optional UAD plug-in licenses and other UA products can be purchased. Promotional coupons are also redeemed here. All UAD device registrations and plug-in authorizations are managed here as well.

[My.uaudio.com](http://my.uaudio.com) can be accessed from most pages at www.uaudio.com by clicking the link in at the upper left of a webpage. The direct URL for the my.uaudio.com online store is: <http://my.uaudio.com>.

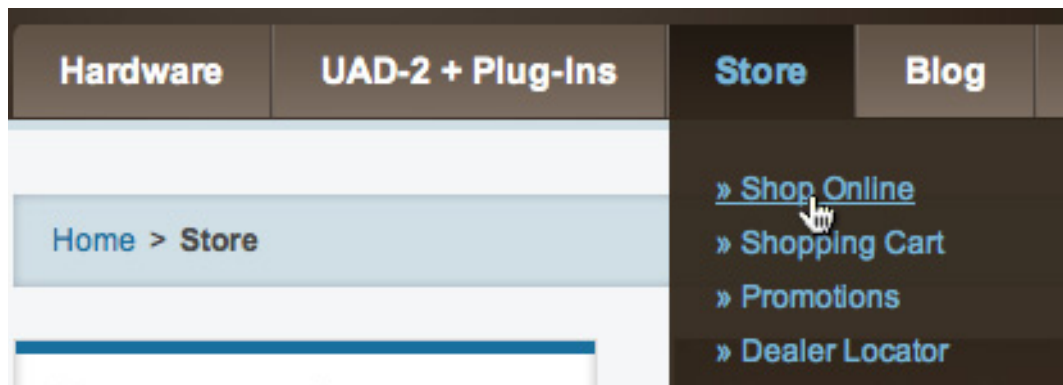

Figure 6. Accessing the UA online store from www.uaudio.com

Registration

Registration at my.uaudio.com is required for all UAD users to obtain UAD device authorizations, redeem coupons, purchase optional UAD plug-in licenses, get software updates, and receive customer support. It is also an opportunity for you to inform us of your system details so we can serve you better, and for us to keep you informed about important updates and new product announcements.

Account

A my.uaudio.com account is required to use UAD- Powered Plug-Ins, because UAD plug-ins must be authorized for use, and authorization can only occur after the UAD device is registered to an account. UAD registration also entitles you to free UAD [Customer Support](#) and special promotional offers.

Creation

The first time you visit my.uaudio.com you are prompted to create your account. Your email address is your account login. You'll be prompted to enter your name, address, and password, and set your email notification preferences.

Login

When you revisit my.uaudio.com, you are prompted to login to your account. Your email address is your account login; the password was specified when the account was created. If you forget your password you can have the store email your password to you. You have the option to stay logged in (via a browser cookie) if desired so you don't have to keep entering the credentials.

My Profile

"My Profile" is where product registration details such as name and mailing address are stored and edited. Your email subscription preferences are also set here so you can choose whether or not to receive email announcements for our webzine and promotional offers.

Your email address is your my.uaudio.com account identifier and login. You can change the email address (and the my.uaudio.com login) on the My Profile page.

Buying Plug-Ins

To obtain optional UAD plug-in licenses, simply visit www.uaudio.com, browse the complete line of plug-ins at our secure online store, and complete your purchase with several payment options or use any coupon credit that was applied during device registration or promotional offers.

Lots of product information such as features, specifications, audio/video demos, and reviews are available on the plug-in product pages at the store to help you make your buying decisions.

Purchase Procedure

To purchase and authorize an optional UAD plug-in:

1. Visit the [UA Online Store](http://www.uaudio.com) at www.uaudio.com (Figure 6 on page 41).
2. Add the items you wish to purchase to your shopping cart (you may need to login to your [Account](#)).
3. Click "View cart" or the Checkout button when ready to proceed to checkout. The payment page appears.
4. Select payment method and provide payment details. If applicable, apply any discount coupons.
5. Click the Continue button. The order confirmation page appears.

6. Verify the order on the confirmation page, then click Confirm Order *once only*. The transaction is processed, and the Checkout Success page appears. Purchased UAD plug-in licenses are issued immediately to [My Systems](#). Any authorization file downloaded after this point contains the license for the newly purchased plug-in(s).
7. Download a new [Authorization File](#) by clicking the Download Authorizations button. The auth.uad2 file is downloaded to the location specified in the web browser preferences.
8. Double-click the downloaded authorization file. The authorization is loaded onto the UAD device(s) and after a few seconds the “Authorizations Updated Successfully” window ([page 24](#)) appears.

The purchased UAD plug-in is now licensed and fully authorized.

Transferring UAD devices and licenses

Ownership of UAD devices and UAD plug-in licenses can be transferred from one my.uaudio.com account to another to accommodate the used equipment marketplace. Certain restrictions apply. Please visit the UAD transfer page for instructions, policies, and FAQ:

- www.uaudio.com/support/uad/transfer-faq

Transfer Video

Our Videos page has a video about UAD device transfers:

- www.uaudio.com/videos

CHAPTER 5

Using Multiple UAD Devices

Overview

Multiple UAD-2 devices can be used in a single host computer system for increased DSP capacity. The UAD-2 devices in the multidevice system can be mixed and/or matched in any combination (see [“The UAD Hardware” on page 28](#)).

When multiple UAD-2 devices are installed in the host computer, the DSP and memory load of the devices are automatically balanced dynamically as UAD plug-ins are loaded and unloaded. With multiple devices, there is no major difference in operating procedures, except that more UAD Powered Plug-Ins can be loaded simultaneously in the session.

Mixed UAD System

The UAD drivers support up to four UAD-2 devices running in the same host computer system concurrently. The devices can be any combination within the UAD-2 family (PCIe, Satellite, SOLO/Laptop, Apollo).

Plug-In License Policy

The Universal Audio End-User License Agreement (“EULA”) on [page 3](#) grants you the non-exclusive right to use UAD Powered Plug-Ins on a single computer at a single location.

Since you can run up to four UAD-2 devices type in the same computer, each individual UAD plug-in license will authorize all the devices in one computer.

As an example, if you have four UAD-2 devices but run a dual-device system in two separate computers, you are required to purchase separate licenses for the second system.

Authorizing Multiple Devices

When you buy an optional plug-in, your purchased license is valid for all the UAD devices in the computer. The license is tied to the specific UAD devices in the [System](#) (see [page 39](#)) when the license was purchased. For example, if you have two devices when you purchase a plug-in, your authorization file will authorize both devices.

If you have one device during a plug-in purchase then later acquire another device(s) and add it to the same computer, simply download a new authorization file and it will authorize the additional device with your existing plug-in licenses. Your license(s) apply to all devices in the same computer system.

Each individual device must be authorized in order to run optional plug-ins, however multiple installed devices are authorized simultaneously. If one device is authorized then another device is added without downloading a new authorization, the optional plug-in will only load on the previously authorized device. To obtain a new authorization file for additional devices, use the “Authorize Plug-ins” button (page 55) in the UAD Meter & Control Panel.

Power Requirement

Each UAD PCIe card draws power from the PCIe expansion slot that it is installed in. The total power draw of all the installed cards must not exceed the power that can be adequately delivered by the host computer.

The UAD device power requirements are listed in Table 2 on page 45. These figures are measurements of the actual power draw for these devices when running at full DSP load.

Note: *UAD-2 Satellite cannot be powered by the Firewire bus. It requires the included external power supply adapter for operation.*

Important: *If insufficient power is available to UAD devices, unpredictable behavior may result.*

Table 2. UAD Power Requirements by Device Type

UAD Device Type	Maximum Power Draw
UAD-2 SOLO	5 Watts
UAD-2 DUO	7 Watts
UAD-2 QUAD	10 Watts
UAD-2 SOLO/Laptop	3.5 Watts
UAD-2 Satellite (DUO)*	4 Watts (*via external power supply)
UAD-2 Satellite (QUAD)*	7 Watts (*via external power supply)

Windows



The PCI specification provides for up to 25W per device, however some host systems don't provide this much power. When designing a computer DAW system, a common rule of thumb is to provide an extra 50%–100% of headroom over the estimated maximum total power draw of all components in the system.

Note: *Don't skimp on the power supply unit. When building a custom system, a high quality sufficiently-rated PSU is critical for system stability.*



IRQ Conflicts

Under rare conditions running multiple UAD cards may cause an IRQ conflict which can cause system instability or freezes. If this occurs, try moving the UAD card(s) to different slots and/or contacting UA for technical assistance.

Multidevice DSP Loading

DSP loading in a multidevice system behaves the same as in a single UAD-2 DUO, QUAD, or OCTO system (these devices have multiple DSPs), and is managed automatically by the UAD software. See “[DSP Loading Information](#)” on page 79 for details.

Device Info Display

UAD-2 DUO		DSP 1		DSP 2					
Device: 1		DSP	73.4%	68.1%					
Status: OK		PGM	33.0%	39.2%					
Plug-ins: 15		MEM	1.6%	0.0%					
		PLG	9	6					
UAD-2 Satellite QUAD		DSP 1		DSP 2		DSP 3		DSP 4	
Device: 2		DSP	82.5%	64.8%	47.1%	47.1%			
Status: OK		PGM	24.0%	24.0%	12.8%	12.8%			
Plug-ins: 11		MEM	0.0%	0.0%	0.0%	0.0%			
		PLG	4	3	2	2			

UAD DSP and memory resources used for each installed device, and the ability to enable/disable individual devices, is displayed in the System Information window.

See “[System Information Panel](#)” on page 52 for complete details.

Disabling Devices

Individual UAD devices can be disabled using the Device Enabled function (see [page 54](#)). This can be useful, for example, if creating a session on a system with multiple devices that will be transferred to a system with fewer devices.



Devices are disabled only while the UAD Meter & Control Panel application is open. When the UAD Meter & Control Panel is quit, disabled devices are re-enabled.

Note: For optimum results, quit any applications using UAD plug-ins before disabling/enabling devices.

If a UAD Powered Plug-In is loaded on a device then that device is subsequently disabled, an error message will be displayed. This occurs because a plug-in is assigned to a device when it is first instantiated. It stays assigned to the same device until it is de-instantiated (for example, removed from the insert slot).

Host CPU

Using more than one device can cause a slight increase in host CPU loads, so disabling unused devices can help you squeeze in a bit more host performance if you need it. Using additional devices on the PCIe bus requires host resources, so running 15 UAD plug-ins on three devices at five plug-ins per device may require more host CPU than running the same 15 UAD plug-ins on one device.

For example, if you are trying to minimize latency during tracking by using a smaller buffer size (which will increase host CPU loading, even on non-UAD systems) and need a bit more host CPU, disabling one or more UAD devices during tracking may give the extra pinch of host CPU you need. The buffer size can then be increased and the UAD device(s) re-enabled for mixing.

CHAPTER 6

UAD Meter & Control Panel

Overview



The UAD Meter & Control Panel application is used to monitor UAD device resources, confirm the UAD system is operating properly, and configure the global UAD Powered Plug-Ins system parameters.

The UAD Meter window displays the current DSP, program, and memory status of the UAD hardware in real-time. Figure 7 shows how the UAD Meter appears on when UAD-2 devices are installed in the system.

The UAD Control Panel Window (page 51) has multiple panels that display and modify various system, plug-in, and configuration parameters.

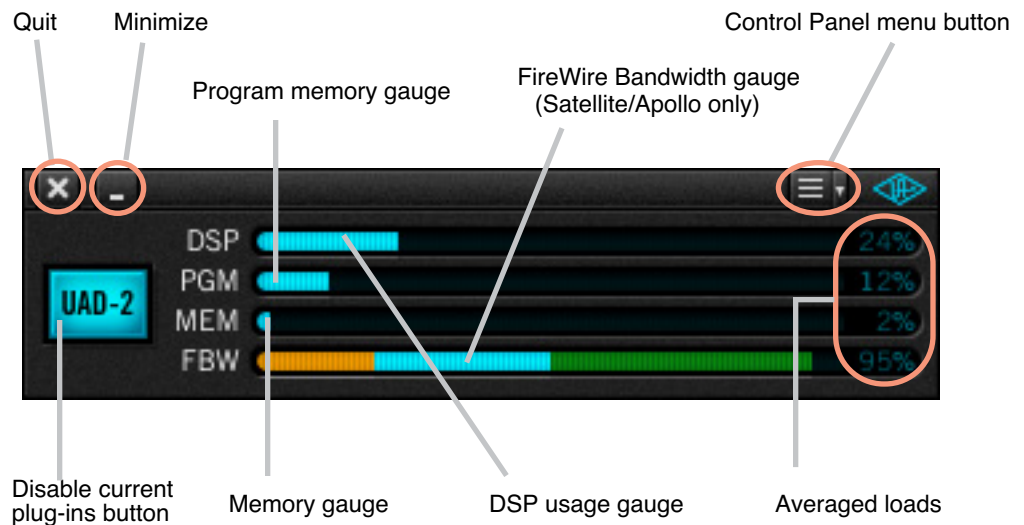

Figure 7. The UAD Meter window

Note: The Quit, Minimize, and Menu button positions shown in Figure 4 are as they appear on Mac systems. The button positions are reversed on Windows systems, reflecting the conventions for each OS platform.

Launching the UAD Meter & Control Panel Application

Windows



To launch the UAD Meter in Windows:

1. Double-click the UAD Meter & Control Panel shortcut that was optionally placed on the Desktop during installation. OR,
2. Access the application from:
Start Menu>All Programs>UAD Powered Plug-Ins. OR,
3. Double-click the executable file on the hard drive located at
C:\Program Files\Universal Audio\Powered Plug-Ins\UADPerfMon.exe.

Mac



To launch the UAD Meter in Mac OS X:

1. Single-click the UAD Meter & Control Panel alias that was placed in the Dock during installation. OR,
2. Double-click the UAD Meter & Control Panel application that was installed to Applications/Powered Plug-Ins Tools during installation.

Using the UAD Meter

The UAD Meter & Control Panel can be launched or quit at any time. It does not need to be open or active to use UAD Powered Plug-Ins. It is completely independent and does not require a host application. You can move the UAD Meter to a convenient location on your screen by dragging its window title bar.

Always On Top

The UAD Meter window can be set to normal or “Always on top” view mode. In normal mode, the window can be covered by windows of the foreground application. When in Always on top mode, the Meter window always “floats” on top of other windows, even when other applications are in the foreground, so you can always see the meter and access the disable buttons (page 50). This setting is saved when the meter is quit.

To enable Always on top mode, click the control panel menu button in the Meter window title bar (Figure 8 on page 52) and select “Always on top” from the drop menu (or use the keyboard shortcut shown in the menu). The mode is active when a checkbox appears next to the item in the drop menu.

Note: If “No Devices Found” appears in the UAD Meter window instead of the expected buttons and gauges, then the UAD drivers are not communicating with the UAD hardware. If this occurs, double-check hardware and software installations and/or contact customer support.

UAD Meter Elements

Refer to [Figure 7 on page 48](#) for these element descriptions.

Title Bar

The Title Bar (the strip across the top of the UAD Meter window) contains buttons to quit the UAD Meter & Control panel application, minimize the UAD Meter window, and a drop menu to access the Control Panel window functions.

Disable Current



The Disable Current button disables all UAD Powered Plug-Ins that are currently running. This enables you to add new UAD plug-ins for offline processing, or easily compare the sound of the processed and unprocessed audio.

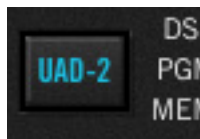

When the button glows blue, UAD plug-ins are active. Click the button to disable the active plug-ins; the button changes to black with blue lettering. New UAD plug-ins can still be added; click the button again to re-activate all UAD plug-ins.

Note: *Disable Current stays active only while the UAD Meter & Control Panel application is open. When the UAD Meter & Control Panel is quit, Disable Current is deactivated.*

Resource Gauges

The UAD resource loads are displayed in the UAD Meter window, which are constantly updated in realtime even when the UAD Meter is not the foreground application. This allows you to monitor UAD loads as needed, for example when deciding which UAD plug-ins to load, based upon how much DSP is available.

The UAD resources are displayed as bar graphs and as percentages.

Averaged Loads

The load for each gauge represents the average for all UAD devices in use. For example, if one UAD-2 QUAD is installed, the UAD-2 DSP load is an average of the four SHARC DSP processors on the QUAD. If two UAD-2 QUADs are installed, then the eight processors are averaged.

Individual Loads

The loads of individual devices in a multidevice setup (or the individual DSP loads in a multi-DSP UAD-2 device) can be viewed in the UAD System Information panel (see [page 52](#)).

DSP The DSP gauges display the amount of digital signal processing resources that are being used by the UAD Powered Plug-Ins algorithms. DSP is the primary hardware “juice” that powers the UAD Powered Plug-Ins algorithms.

When UAD plug-ins are disabled, DSP requirements are decreased.

Program This resource shows how much UAD-2 program memory is in use. Program memory is an on-chip memory that is specific to the UAD-2 DSP processor(s) and is used for certain UAD plug-in resources.

Each unique UAD-2 plug-in uses a bit of program memory. If many different UAD-2 plug-ins are loaded simultaneously, it is possible for this resource to run out before DSP overload occurs. This point is considered and factored in by the automatic UAD-2 load balancing routines.

Memory The Memory gauges indicate the percentage of UAD RAM that is currently in use. It indicates the total available UAD memory available, regardless of the number of DSP processors that are installed.

Memory is used for echo, delay lines, reverb, and similar spatial processing. When UAD plug-ins are disabled but not unloaded, memory requirements are *not* decreased. In this case, the memory remains loaded so that reverb tails and delay lines are not cut off when the plug-in is disabled (if supported by the host).

UAD Control Panel

The UAD Control Panel is where detailed system information is displayed and global UAD Powered Plug-Ins settings are modified. The UAD Control panel has four panels, organized into similar areas of functionality: System Information, Plug-Ins, Configuration, and Help & Support.

Accessing the Control Panels

The main UAD Control Panel window is accessed from the UAD Meter window. To open the Control Panel, click the menu button in the UAD Meter window Title Bar ([Figure 8 on page 52](#)). After clicking the menu button, the available functions are listed in the drop menu.



Figure 8. Click the Menu Button to access the UAD Control Panel drop menu

Once the main UAD Control Panel window is open, the individual window panels are accessed by clicking the title buttons (Figure 9).

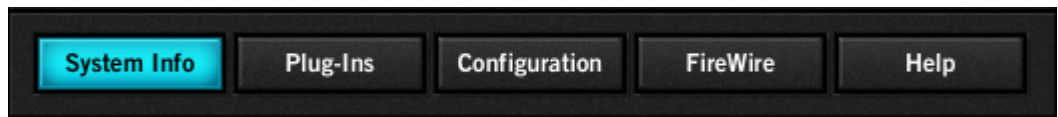

Figure 9. The Control Panel window panel buttons

Note: The FireWire button is only displayed if UAD-2 Satellite or Apollo is connected.

System Information Panel

The System Information panel (Figure 10 on page 53) displays detailed UAD software and hardware information and contains several useful buttons.

Software Section

Version String

The currently installed UAD Powered Plug-Ins software version is displayed.

Important: The UAD driver and plug-in versions must match. If they don't, a "driver mismatch" error will occur when attempting to process audio. If this occurs, you must reinstall and/or reauthorize the UAD software.

Check for Updates

This button checks our web server to find out if a more recent version of the UAD software is available than is currently installed. We recommend running the latest version of UAD Powered Plug-Ins for maximum stability and the latest features, such as new plug-ins.

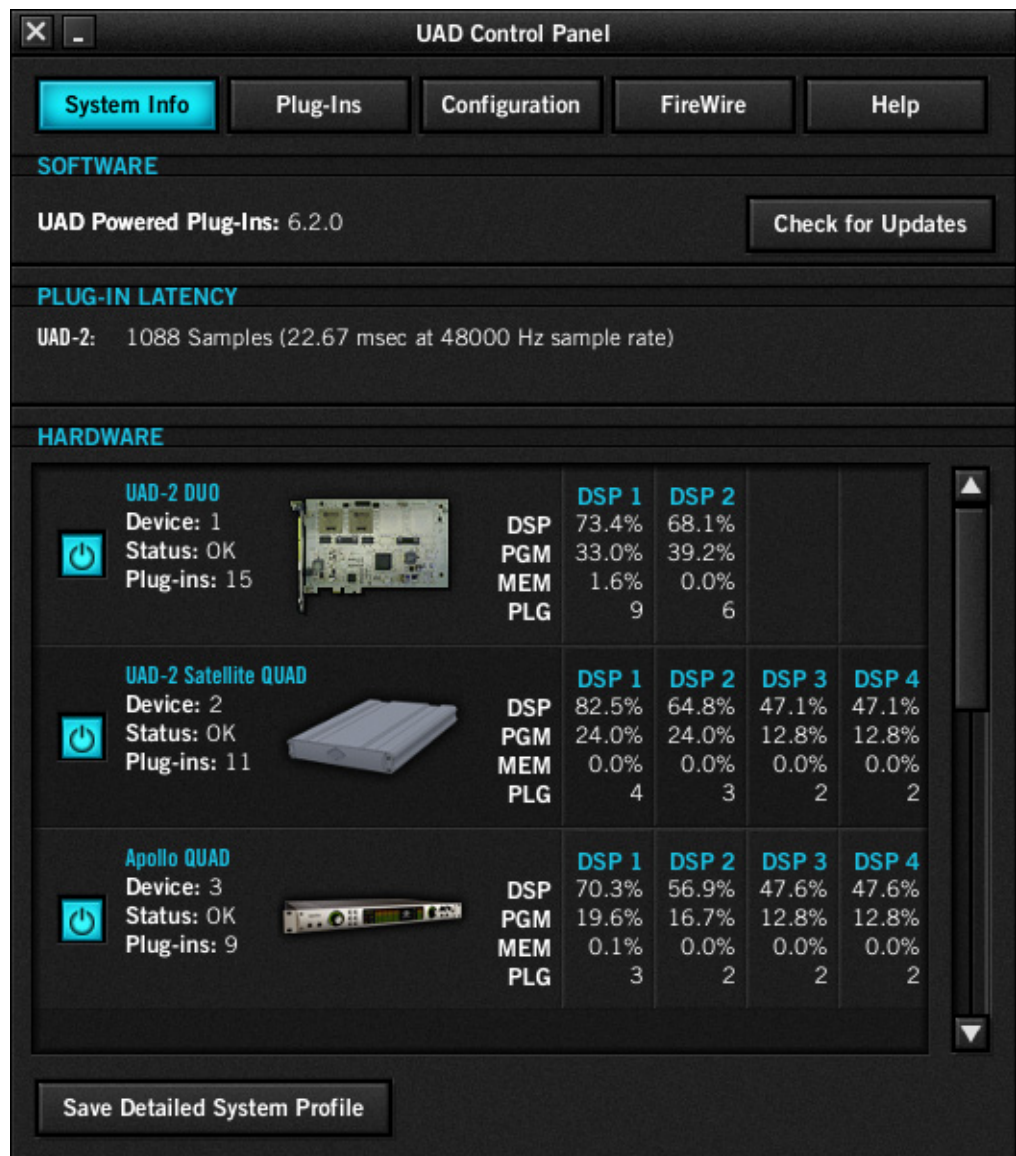

Figure 10. The UAD System Information panel

Plug-In Latency Section

UAD plug-in latency is displayed here. The calculation is based on the audio I/O interface buffer size and the sample rate. The window uses this information to calculate and display the resulting latency in samples and milliseconds.

Note: Displayed latency does not reflect the actual lowered latency value when LiveTrack mode (page 75) is active.

The displayed latency is the audio I/O interface buffer size when Extra Buffering (page 61) is off. When Extra Buffering is on, the displayed latency is the audio I/O interface buffer size plus 64 samples.

Note: The displayed sample latency number does not include the extra samples produced by upsampled UAD plug-ins. For more detailed information about the extra samples and latency, see [Chapter 9, “UAD Delay Compensation.”](#)

Hardware Section

Detailed information about each UAD device and its DSP is displayed in the Hardware area ([Figure 10 on page 53](#)). If you have several devices installed, use the scrollbar to see the other devices.

Device Status

For each installed device, a small picture of the hardware and its status is displayed. When the device displays Status: OK the hardware is operating properly. The total number of UAD plug-ins loaded on each device is also displayed here.

Device Enabled



Individual UAD devices can be disabled using the Device Enabled button. This can be useful, for example, if creating a session on a system with multiple devices that will be transferred to a system with fewer devices or to streamline the performance of the host system when multiple devices are not needed.



Click the button to disable an individual device. The device is enabled when the button is blue. For additional information regarding multidevice use, see [Chapter 5, “Using Multiple UAD Devices.”](#)

Devices remain disabled only while the UAD Meter & Control Panel application is open. When the UAD Meter & Control Panel is quit, disabled devices are re-enabled.

Note: Disabling devices does not disable plug-ins already running on the device; it only prevents additional plug-ins from being loaded onto it.

Important: For optimum results, quit any host applications using UAD plug-ins before disabling/enabling devices.

DSP Load

If more than one UAD DSP is installed, information for each of the processors is displayed. DSP, Program (“PGM”), and Memory (“MEM”) loads are displayed as a percentage of total available load for that processor.

The number of UAD plug-ins (“PLG”) running on each individual processor is also displayed.

Save Detailed System Profile

Clicking this button will generate a detailed system profile and prompt you for a location to save the text file to disk. This file contains an even greater level of detail than the System Information panel, which can be useful for troubleshooting or if UA Customer Support requests this document when providing assistance.

The profile lists the version strings of the individual UAD software components, installed device type(s) with serial and hardware ID numbers, host computer information, and detailed authorization status for all UAD plug-ins.

Plug-Ins Panel

The Plug-Ins panel ([Figure 11 on page 57](#)) displays the current authorization status of all UAD plug-ins. This is also where you can activate plug-in Demo Mode (["UA Online Store" on page 41](#)) and configure UAD plug-ins to run on a specific device. Use the scrollbar to view plug-ins that are not visible in the list.

Authorize Plug-ins button



This important button links directly to your account at the UA online store to automatically generate and download an authorization file for your UAD plug-ins. If you do not already have an account, you are redirected to the registration page to create one.

Important: UAD plug-ins require authorization before they can be used. For detailed information, see ["Authorization Overview" on page 37](#). Without authorization, UAD plug-ins can be enabled to run for 14 days without functional limitations in a timed demo mode (see ["Demo Mode" on page 40](#)).

The complete procedure for UAD device authorization is detailed in [Chapter 2, "UAD Installation."](#) See ["Authorize Plug-Ins Procedure" on page 23](#) for complete step-by-step instructions. If the UAD computer is not connected to the internet, see ["" on page 24](#).

Plug-In Column

All currently installed UAD Powered Plug-Ins are displayed in the Plug-In column. Use the scrollbar to view the entire list if necessary.

Status Column

The Status column reflects the current state of each UAD plug-in. After the authorization file is loaded (["Authorization Overview" on page 37](#)), the status will show one of the following:

Authorized for all devices

The plug-in is fully licensed and authorized to run on all devices in the system.

Start Demo

The demo period has not been started for the plug-in. Click the "START DEMO" button to begin the 14-day trial period.

Demo (days remaining)

If the 14-day trial period has been activated but is not yet expired, the number of days remaining is displayed here in green text.

Important: *The 14-day demo period can only be activated once, and cannot be stopped or restarted during this period! We recommend you do not activate demo mode until you have the time to thoroughly check out its sound and functionality. See "Demo Mode" on page 40 for detailed information.*

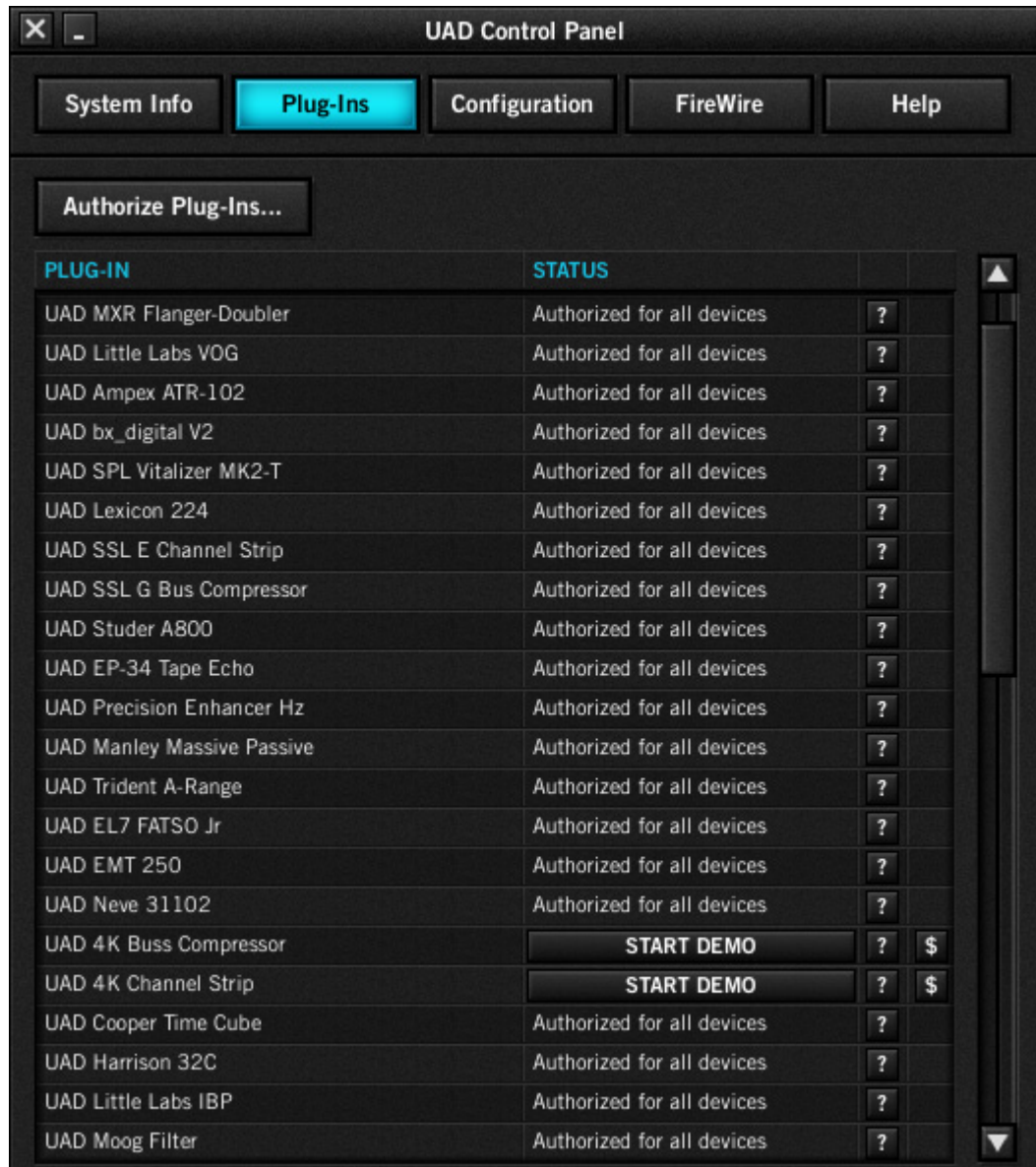



Figure 11. The UAD Plug-Ins panel

Help Column

 Clicking the Help button (“?”) opens a link to the plug-in product page on the UA online store.

Buy Column

 Clicking the Buy button adds the plug-in to your shopping card at the UA online store. See [“UA Online Store” on page 41](#) for purchasing details.

Configuration Panel

The UAD Configuration Panel is where most of the global UAD settings and preferences are specified for all UAD devices. Refer to [Figure 12 on page 59](#) for the parameter descriptions.

The parameters that are displayed in the Configuration Panel are dependent upon the UAD hardware that is currently installed and the OS platform (Windows or Mac). For example, if you have only UAD-2 devices installed in a Windows system, you will not see Mac-specific parameters.

Note: *All UAD-2 parameters apply to UAD-2 PCIe cards, UAD-2 SOLO/Laptop, UAD-2 Satellite, and Apollo unless otherwise noted.*



Figure 12. The UAD Configuration panel

DSP Load Limiting Overview

Without UAD Powered Plug-Ins installed, overloading the host system with native (host based) plug-ins can cause dropouts and possibly system lockup. Steinberg hosts, for example, provide a switch that allows you to trade latency for stability when the system is overloaded. Similarly, the UAD DSP load cannot exceed 100% without unpredictable behavior.

With the Limit DSP Load feature, the UAD DSP can also be limited so the load cannot exceed 100%, thereby increasing overall system stability in high load situations. With very heavy UAD loads, DSP load limiting may also improve host CPU performance.

There are many variables that affect DSP load (sample rate, buffer size, parameter values, mono/stereo, automation, host system, etc). Although these variables are taken into account, the resulting measurement cannot be absolutely accurate. This is due to variations in system configurations, specifically PCI/PCIe bus loading which is impossible to predict. Systems that are heavily loaded due to the presence of other devices or suboptimal configuration may cause additional DSP loading that cannot be predicted by the UAD plug-in load calculator. The DSP load limit should be reduced in this case.

It is possible for certain (non-typical) conditions to be met where another UAD plug-in can't be added, even when the UAD Meter says you should have DSP available when compared to the DSP Load Limit value.

Note: *When Limit DSP Load is enabled and the DSP load limit is exceeded when instantiating a new UAD plug-in, an overload message will appear and the plug-in toolbar will display "DISABLED." Even though its interface will load, the plug-in will not process audio.*

UAD-2 DSP parameters apply to UAD-2 PCIe cards, UAD-2 SOLO/Laptop, and UAD-2 Satellite unless otherwise noted.

Limit DSP Load

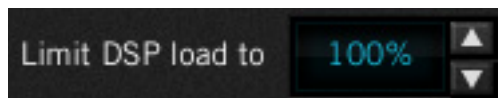

This setting determines the maximum UAD DSP load. If performance issues such as overloads, dropouts, stuttering, and/or crackles persist, change the UAD DSP load value by clicking the triangles to the right of the percentage display.

UAD-2 DSP load limiting is always on. 100% (the default value) is the maximum available setting.

UAD-2 DSP LoadLock

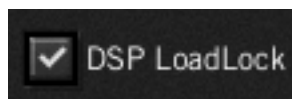

DSP LoadLock (UAD-2 only) reserves the maximum UAD-2 DSP load required by each plug-in, even if certain plug-in features are disabled. This ensures there will always be enough DSP if those features are later enabled, or when automating parameters that affect the DSP load.

Disabling LoadLock increases available UAD-2 DSP by turning off unused features in certain plug-ins, but may cause problems with previously saved sessions that had all plug-in features enabled, or when automating parameters that affect the DSP load.

Enabling DSP LoadLock is recommended for optimum performance. Disable LoadLock when you need to squeeze in that extra bit of DSP resources.

Note: Changes to this setting do not take effect until all open sessions containing UAD plug-ins are reloaded.

UAD-2 Extra Buffering

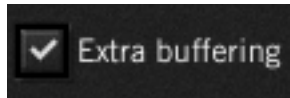

Extra Buffering adds an additional 64 samples of buffering for increased host application compatibility. Applications that are known to require Extra Buffering include Sony Vegas, Acid, and Soundforge, and Sonar Cakewalk.

In other hosts, you can disable this mode to reduce latency. If your application is incompatible with reduced latency when Extra Buffering is off, a dialog will be displayed indicating that Extra Buffering is required.

Note: Changes to this setting do not take effect until all open sessions containing UAD plug-ins are reloaded.

Host Compatibility

Windows



Enable CPU Optimization

When this setting is enabled, host CPU usage is significantly reduced, particularly when running larger numbers of plug-ins and/or small buffer sizes. Incidents of host CPU overloads with high graphical activity are also significantly reduced.

The default value is ON. We recommend leaving this setting enabled on all Windows systems.

Important: If UAD-2 plug-ins are already loaded when the setting is changed, the host application must be restarted for the change to take effect.

Mac



Release all DSP resources on Audio Unit bypass

Some Audio Unit hosts dynamically bypass plug-ins when they are not being used during playback, for example when no audio is present at the current playback position. During this dynamic bypassing, UAD plug-ins stay loaded on the device, which reduces glitches in playback.

This setting affects the Audio Units platform only. Checking the “Release all DSP resources on AudioUnit bypass” option will unload UAD plug-ins from the device during dynamic bypassing. When the option is checked, UAD DSP usage may be reduced during dynamic bypassing, but the possibility of glitching during playback is increased.

Note: *Changes to this setting do not take effect until all open sessions containing UAD plug-ins are reloaded.*

Mac



Force Logic to use “live mode” for tracks with UAD plug-ins

When UAD plug-ins and Logic 7.2.1 (and higher) are used together and this setting is checked, all Logic tracks with UAD plug-ins are forced into Logic's “live mode” and latency is reduced. Reduced latency is useful for tracking when Logic's Software Monitoring feature is active.

Note: *Logic's “live mode” is unrelated to UAD-2's LiveTrack Mode.*

When this setting is active, UAD-2 latency is the same as the hardware I/O buffer. In Logic versions prior to 7.2.1 (and later versions when live mode is disabled), UAD latency is determined by the larger of the audio interface hardware I/O buffer size and the Process Buffer Range setting within Logic.

When Logic's “live mode” is NOT active and this setting is NOT enabled, the minimum Process Buffer Range setting (“Small”) in Logic 7 corresponds to 512 samples, meaning the minimum possible UAD latency is 512 samples for UAD-2 (the current latency is displayed in the UAD Meter System Information panel). Latency can be further reduced by using [LiveTrack Mode](#) (UAD-2 only).

On multi-processor machines Live Mode forces all plug-ins on tracks with UAD plug-ins (and any aux/buses fed by those tracks) to run on one processor only. To allow host-based (native) plug-ins to run on all processors under these conditions, deactivate this setting.

Note: *Changes to this setting do not take effect until all open sessions containing UAD plug-ins are reloaded.*

User Interface Settings

Controls Mode

This setting determines how UAD Powered Plug-In parameter knobs respond to adjustment. Three control modes are offered: Circular, Relative Circular, and Linear. Select the desired mode from the drop menu.

Note: *To increase resolution when in adjusting rotary controls in circular and relative circular modes, increase the radius of the mouse relative to the knob while dragging (i.e. move the mouse farther away from the knob while dragging in a circular motion).*

Linear (slider)

In Linear mode, the knob is adjusted by dragging horizontally or vertically instead of by rotating. This behavior is similar to moving a physical fader.

Circular (jump)

In Circular mode, the software knobs behave similar to physical rotary knobs. Values are changed by clicking on the knob then rotating in a circular direction. When the edge of the knob is clicked, the parameter value jumps to the mouse position.

Relative Circular (grab)

Relative Circular mode operates similar to Circular mode, but the knob value does not jump to the mouse position when clicked. Instead, the knob value is modified relative to its original value.

In this mode you can click anywhere on the knob to make an adjustment originating at the original value. You don't have to click on the current knob position.

Use Host Mode

When Use Host Mode is checked, the control mode set within the host application preferences is used if this feature is supported by the host. This setting forces the host to override the control mode set in the UAD user interface settings.

Note: *When Use Host Mode is checked, the UAD Meter user interface settings have no effect unless control mode is NOT supported by the host.*

Mac



Toggle initial value modifier

Holding the specified modifier key while clicking a parameter control will toggle between the value of the control when the editor was opened and its last edited value. This feature is not supported under Windows.

This parameter also affects the “select + click” modifier. For a complete list of keyboard shortcuts, see “Shortcuts” on page 78.

Info Display

This area displays helpful text about parameters in the Configuration panel. Hover the mouse over a Configuration setting to view the informational text.

FireWire Panel

The UAD FireWire Panel (Figure 13 on page 65) is where settings specific to UAD-2 Satellite and Apollo are configured (FireWire settings do not apply to UAD PCI/PCIe devices). UAD-2 Satellite and Apollo are external UAD devices that connect via FireWire as opposed to PCI/PCIe or ExpressCard.

Note: *The FireWire Panel is only displayed if UAD-2 Satellite and/or Apollo is connected.*

FireWire System

The FireWire System parameters pertain to the configuration of the FireWire bus. These settings affect UAD-2 Satellite and Apollo performance and can also affect external FireWire audio interface and hard drive performance if they are connected to the same FireWire bus.

The primary function of the FireWire System settings is to reduce the UAD-2 Satellite FireWire bandwidth allocation and/or link speed when other FireWire devices are on the same bus, or if other performance issues arise.

Note: *The FireWire System settings cannot be changed when UAD plug-ins are loaded. Quit all UAD plug-in host software to make changes to these settings.*

Important: *FireWire device connection methods can affect the FireWire bus speed. See “FireWire Bandwidth” on page 109 for details.*

For more information about FireWire and using it with UAD-2 Satellite and Apollo, see “FireWire Basics” on page 105, “FireWire Bandwidth vs. UAD DSP” on page 111, and “FireWire Bus Power” on page 112.

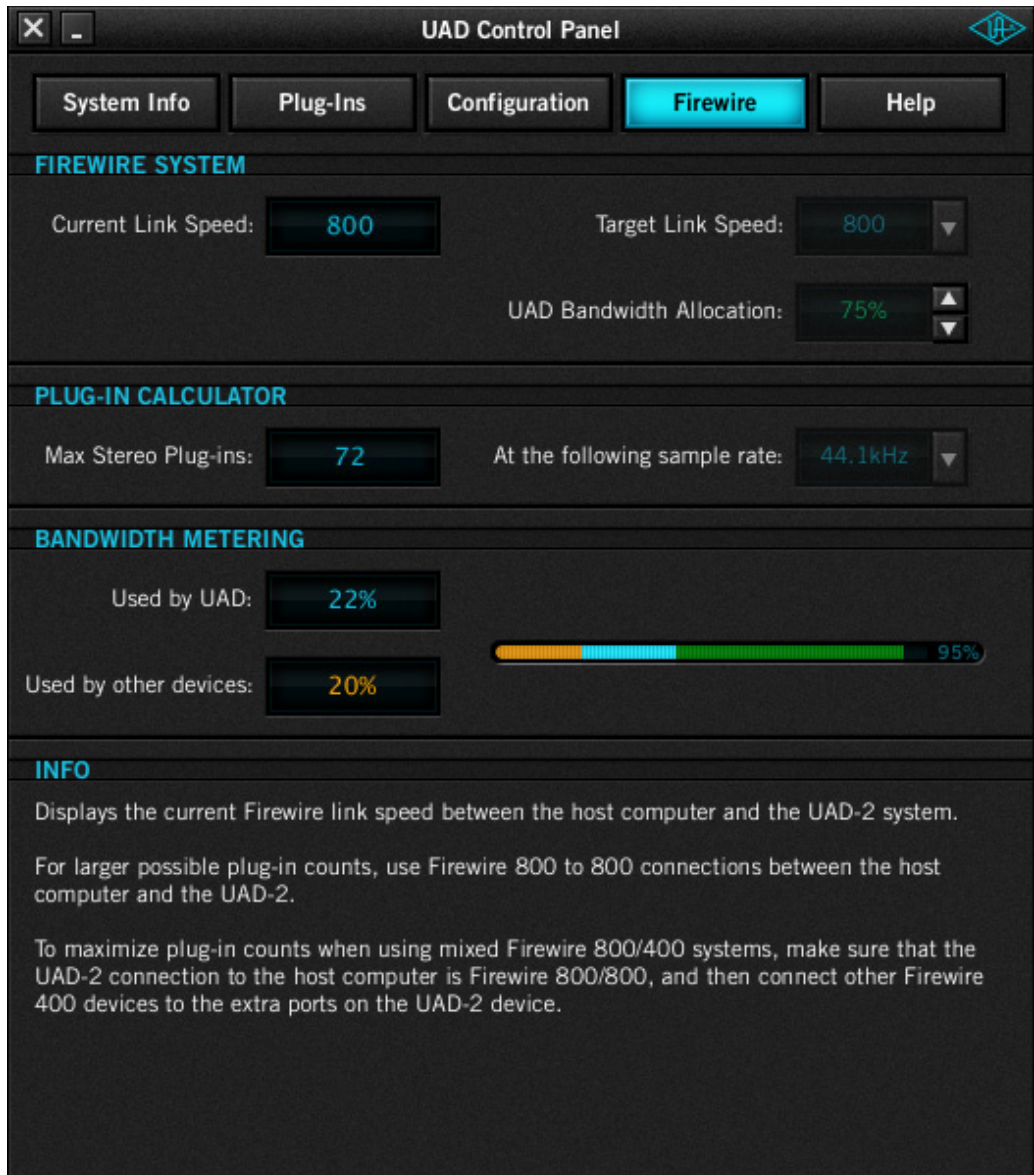

Figure 13. The UAD FireWire panel

Current Link Speed

The current speed of the FireWire link between the host computer and UAD-2 Satellite and/or Apollo is displayed here. The active link speed can be changed with the **Target Link Speed** control if FW400 and FW800 are both supported by the host system.

If the host computer has multiple FireWire buses (this is rare), up to two speeds will be displayed, with the values separated by a comma.

Note: If the host computer supports FireWire 800 and the Target Link Speed is set to 800, but the Current Link Speed still displays 400, check the bus ordering of the FireWire devices. See [“Mixing FireWire Speeds”](#) on page 108 for information on how to properly combine FireWire 400 and FireWire 800 devices on the same bus.

Target Link Speed

The desired speed of the FireWire link between the host computer and the UAD-2 Satellite or Apollo is set here (the actual link speed is shown in the [Current Link Speed](#) display). To change the value, click the down arrow to display the drop menu, then select the desired value. The setting cannot be changed when UAD plug-ins are loaded.

Target Link Speed should be set to 800 when supported by the host computer. However, some FireWire devices may not always perform flawlessly. Changing the Target Link Speed to 400 may actually improve performance and/or stability on systems not optimized for FireWire 800 operation.

Tip: Twice as many UAD-2 Satellite or Apollo plug-ins can be run at 800 versus 400, so configure the FireWire system to run at 800 if supported by the computer.

UAD Bandwidth Allocation

This parameter determines how much of the total available FireWire bus bandwidth will be reserved for UAD-2 Satellite or Apollo plug-ins. Limiting the bandwidth used by UAD-2 Satellite or Apollo ensures that other FireWire devices on the same bus will have enough bandwidth to function properly.

To change the value, click the increment/decrement arrows, click/hold the current target value to display a drop menu, or double-click the value for direct text entry. The maximum available value is 85%.

Note: The value cannot be changed when UAD plug-ins are active.

Although the amount of FireWire bandwidth reserved by UAD-2 Satellite or Apollo depends on the UAD Bandwidth Allocation setting, the amount of DSP used by any UAD plug-in does not affect FireWire bandwidth (UAD plug-ins that use very little DSP require the same FireWire bandwidth as DSP-intensive UAD plug-ins). See [“FireWire Bandwidth vs. UAD DSP”](#) on page 111 for details.

It is important to note that all devices on the FireWire bus share the available data bandwidth of the bus, including hard drives and audio interfaces as well as UAD-2 Satellite and Apollo. Therefore all of the bandwidth cannot be allocated for UAD use if FireWire hard drives and/or audio interfaces are on the same bus. See “[FireWire Bandwidth](#)” on [page 109](#) for additional information.

To determine the proper value for the UAD Bandwidth Allocation:

1. Connect and power up all the FireWire devices (host computer, audio interfaces, hard drives, UAD-2 Satellite) on the FireWire bus.
2. If running an audio interface on the FireWire bus, ensure the audio interface drivers are installed and configured correctly (specifically, all the audio inputs and outputs that will be used should be enabled).
3. Run the UAD host (DAW) software but DO NOT run any UAD plug-ins, at the HIGHEST SAMPLE RATE that will be used in the session (the sample rate may be reduced after UAD Bandwidth Allocation is set).
4. View [FireWire Gauge](#) in the “[Bandwidth Metering](#)” section of the [FireWire Panel UAD-2 Satellite](#) ([page 68](#)) when UAD plug-ins are NOT running. The value indicated in orange is the percentage of FireWire bandwidth that is used by audio interface I/O streams.
5. Subtract the “[Used by other devices](#)” percentage from 100% and enter the difference as the UAD Bandwidth Allocation.
6. If you are using FireWire hard drives for audio session data on the same bus, the UAD Bandwidth Allocation will need to be reduced to accommodate the FireWire hard drive usage.

UAD Bandwidth Allocation Example

If all the FireWire devices on the bus except UAD-2 Satellite use 20% of the available FireWire bandwidth (from steps 1 through 4 above), enter 80% as the UAD Bandwidth Allocation ($100\% - 20\% = 80\%$).

Tip: *If FireWire performance issues occur, leaving a bit of unused FireWire bandwidth (headroom), so the total usage for all devices is less than 100%. To leave 5% of the bandwidth available for headroom in the example above, you’d enter 75% for UAD Bandwidth Allocation (20% bandwidth without UAD-2 Satellite + 75% for UAD-2 Satellite = 95% total FireWire bandwidth). This is especially applicable if using FireWire hard drives on the same bus for audio session data.*

Plug-In Calculator

The Plug-In Calculator displays the maximum number of stereo UAD plug-ins that can be run on UAD-2 Satellite and Apollo with the current [FireWire System](#) settings at a given sample rate.

Note: *The Plug-In Calculator is for informational purposes only; it does not actually affect UAD FireWire or DSP performance in any way.*

Max Stereo Plug-Ins

The maximum number of stereo UAD plug-ins that can run on UAD-2 Satellite and Apollo, based upon the [FireWire System](#) settings and a given session sample rate, is displayed here. The number changes if/when session sample rate changes.

The UAD instantiation count at the current settings could exceed this number if used in true mono configurations. Note that some host software uses stereo plug-in processing even when used on a mono track.

At the following sample rate

This parameter selects the sample rate used by the Plug-In Calculator. To change the value, click the down arrow to display the drop menu, then select the desired value.

When a UAD plug-in is loaded by the host software, the session sample rate is entered automatically. In this scenario, the parameter cannot be modified until the host is quit.

Note: *The “At the following sample rate” parameter is only used by the Plug-in Calculator; it does not affect the actual sample rate of the UAD system or the host software.*

Bandwidth Metering

Bandwidth Metering pertains to the FireWire bus that UAD-2 Satellite and Apollo are attached to. The items displayed in this area are for informational purposes only; there are no settings here that can be changed.

If the host computer has multiple FireWire buses (this is rare), up to two bandwidth gauges will be displayed, one for each bus.

Used by UAD

This number displays the percentage of FireWire bus bandwidth that is used by UAD plug-ins running on UAD-2 Satellite and Apollo. The number cannot exceed the value set by the [UAD Bandwidth Allocation](#) parameter.

Used by other devices

This number displays the percentage of FireWire bus bandwidth that is used by all FireWire audio interface devices connected to the bus. The number is used to help determine an optimum value for the [UAD Bandwidth Allocation](#) parameter.

FireWire Gauge

The FireWire Gauge ([Figure 14](#)) reflects the FireWire bus bandwidth currently used by UAD-2 Satellite, Apollo, and all other FireWire peripheral devices (e.g., audio interfaces and hard drives).

The gauge graphically displays the [UAD Bandwidth Allocation](#) (green), the bandwidth used by active UAD plug-ins (blue), bandwidth used by audio interfaces (orange), and bandwidth available for FireWire hard drives (black).

The FireWire Gauge in the FireWire control panel is also displayed in the UAD Meter when UAD-2 Satellite or Apollo is connected (see [Figure 7 on page 48](#)).

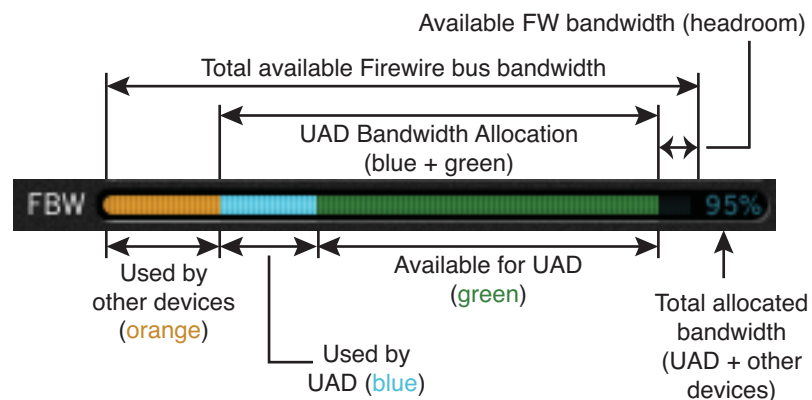

Figure 14. Elements of the UAD FireWire Gauge

Important: FireWire bandwidth is unrelated to UAD DSP loads. See [“FireWire Bandwidth vs. UAD DSP”](#) on page 111 for details.

Info Display

This area displays helpful text about parameters in the FireWire panel. Hover the mouse over a FireWire setting to view the informational text.

Help & Support Panel

The Help & Support panel ([Figure 15](#)) contains numerous helpful weblinks to help you get the most out your UAD Powered Plug-Ins experience.

The button names are self-explanatory. Click a button to launch the URL in your default web browser (you must be connected to the internet to launch the web pages). If the UAD computer isn't online, much of the information is in the manual you're reading now; find it in Table of Contents, Index, or search.

"View User Manual" is the only button that doesn't link to the internet. Instead, clicking this button opens the UAD User Manual (the file you're reading now).

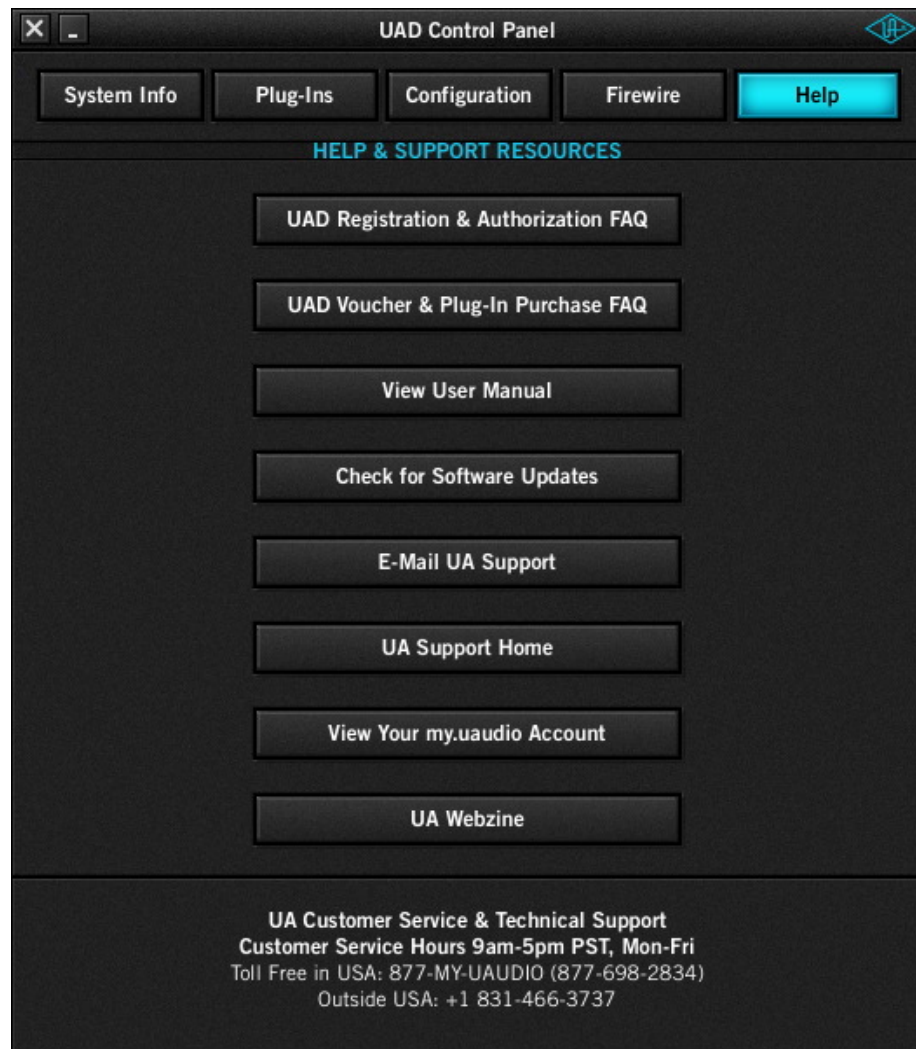

Figure 15. The UAD System Help & Support panel

CHAPTER 7

Using UAD Powered Plug-Ins

Overview

Once the UAD device(s) and Powered Plug-Ins have been properly installed, the UAD Powered Plug-Ins are accessed and used just like any host-based plug-in. All UAD Powered Plug-Ins can run concurrently with each other and with host-based plug-ins simultaneously, in any combination.

UAD-2 Powered Plug-Ins support up to 32-bit, 192 kHz operation. Resolution is limited only by the resolution of the host application. Please note that Powered Plug-Ins running at 96 kHz use twice as much UAD DSP resources than those used at 48kHz, and so forth.

Launching a UAD Powered Plug-In

Each host application has its own particular methods for instantiating (launching) a plug-in. Consult the host application documentation for specific instructions on loading and using plug-ins with the application.

Cubase SX & Nuendo SX

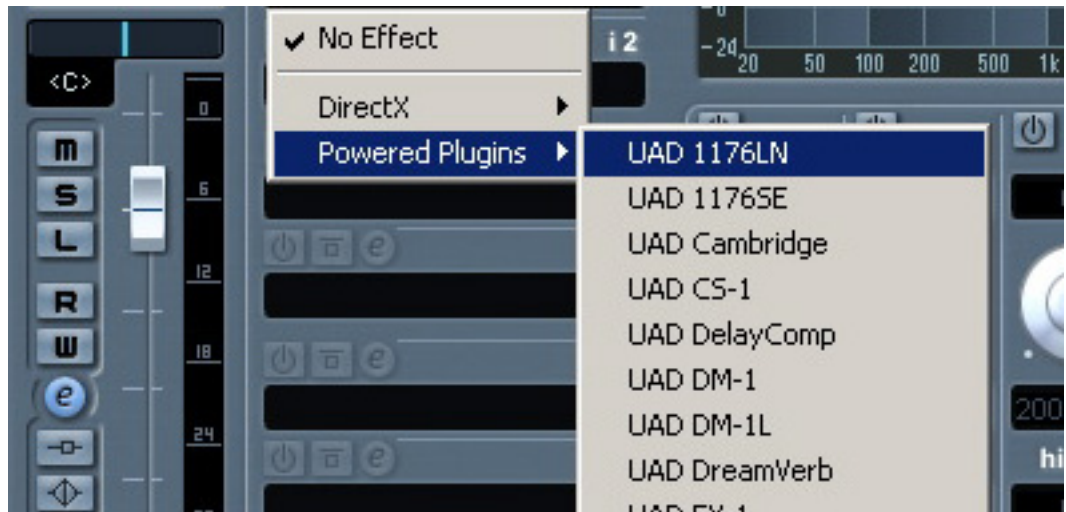

Figure 16. Launching a UAD Powered Plug-In in Steinberg Cubase and Nuendo

Logic Pro



Figure 17. Launching a UAD Powered Plug-In in Apple Logic Pro

The UAD Plug-In Window

One typical UAD plug-in window is shown in Figure 18. The graphical user interface (GUI) typically contains several control parameters for modifying the behavior of the plug-in, and display elements such as meters, for visual feedback. The UAD Toolbar (common to all UAD plug-ins) is also displayed.



Figure 18. Typical UAD plug-in window

Controls View

Some host applications have an alternate plug-in display mode feature called Controls View, Parameter Mode, or similar terminology. This mode typically displays the control parameters as a list with simple sliders, switches, and menus (the appearance is controlled by the host), which some users prefer. Consult the host documentation for how to display this view.



Figure 19. A UAD plug-in showing controls view

UAD Toolbar

Below every UAD Powered Plug-In (when displayed in normal GUI view) is the UAD Toolbar (Figure 20). The Toolbar has several useful features that make using UAD plug-ins more convenient.

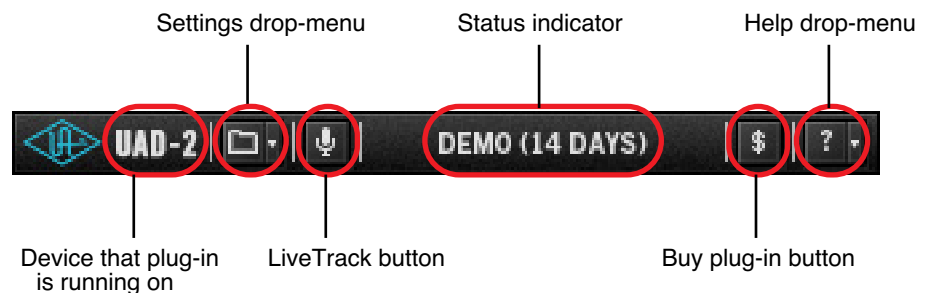

Figure 20. Anatomy of the UAD Toolbar

Settings Menu



The Settings menu provides a convenient way to manage your UAD plug-in parameter settings. To select the functions, click the folder icon in the Toolbar, then select an action from the drop-menu that appears.

The Settings load/save feature supports presets but not banks. To load and save banks, use the host's bank management feature (if available).

Note: UAD plug-in settings are saved within a project session file by the host software, and settings are recalled when the project file is loaded. This occurs automatically without using the preset load/save feature.

Preset/Settings Compatibility

Load/save and copy/paste of parameter values between the same UAD plug-in type is supported. You can also load/save/copy/paste between "SE" and "full" plug-ins of the same type, for example between UAD Neve 33609 and UAD Neve 33609SE when you need to squeeze out a bit more DSP performance without losing your settings.

Preset Families

Functions in the menu are also supported between CS-1 "family" plug-ins. Preset load/save and settings copy/paste are all interchangeable within the UAD CS-1 family, which includes CS-1, DM-1, DM-1L, EX-1, and RS-1.

Load/Save Preset

When the Load Preset or Save Preset function is selected, the standard operating system load/save file dialogs are presented. Preset files can then be loaded (if the plug-in is the same type), or saved to any disk location.

Default Preset Locations

When the load/save functions are used, the OS load/save file dialogs default to the standard UAD preset location. Although UAD presets can be loaded from (and saved to) any disk location, using the default location is a convenient method to organize all your presets in one location.

When saving, the Presets folder is created if it doesn't already exist. A subfolder with the UAD plug-in name is also created, so presets for the same plug-in are all in the same folder. When loading presets, the open file dialog looks inside the subfolder for that plug-in.

Windows



The default preset location is inside the Presets folder, which is created within the folder specified during software installation. For example, if the default location was selected when running the installer, the location would be:

- C:\Program Files\Universal Audio\Powered Plugins\Presets

Note: This default location can be changed during installation; the new location will be remembered as the default.

Mac



On Mac OS X systems, the default preset location is:

- Startup Disk/Library/Application Support/Universal Audio/Presets

Copy/Paste Settings



Settings can be copied and pasted directly between UAD plug-ins (within the compatibility guidelines) without using the interim step of creating a preset file.

To copy/paste settings between UAD plug-ins, select Copy Settings from the drop-menu of the source plug-in, then select Paste Settings from the drop-menu of the destination plug-in.

Note: If the menu displays “Cannot Paste Settings” then settings were not copied first, or the paste destination is an incompatible plug-in.

LiveTrack Mode

Overview



LiveTrack Mode reduces latency on an active UAD-2 plug-in to the lowest possible amount. This feature is highly useful for monitoring processed audio when recording live performances.

Reduced latency in LiveTrack Mode is accomplished by circumventing the standard buffering processes. Normally, UAD-2 signal data is buffered at the audio interface I/O sample buffer size (such as 128, 512, or 1024 samples) which results in a processing delay.

In LiveTrack Mode, UAD-2 signal data is transferred and processed “immediately” instead of being buffered, resulting in reduced latency.

Note: LiveTrack Mode is available exclusively with UAD-2 PCIe devices. When a UAD-2 FireWire device (UAD-2 Satellite or Apollo) are in use by the system, LiveTrack Mode cannot be used.

Increased Host Loading using LiveTrack

When LiveTrack is active, host CPU loading increases. The host load is directly proportional to the DSP load of the UAD plug-in(s) in LiveTrack mode, however host CPU is never used for Powered Plug-in processing.

Extra Latency using LiveTrack

When extra buffering is enabled ([page 61](#)) or when upsampled UAD plug-ins ([page 87](#)) are used with LiveTrack, latency is increased. Extra buffering adds 64 samples, and each upsampled plug-in using LiveTrack adds the value from [Table 7 on page 88](#).

Note: For more detailed information about latency and buffers, see [Chapter 9, “UAD Delay Compensation”](#).

LiveTrack Activation



To activate LiveTrack Mode, click the microphone icon in the UAD-2 Toolbar. The mode is active when the mic icon is red.

LiveTrack Mode can be activated simultaneously on multiple UAD-2 plug-ins. However, host system CPU loads will increase with each LiveTrack Mode instance.

Status Indicator

The Status indicator (see [Figure 20 on page 73](#)) displays information about the current state of the plug-in. Each state is described below.

Start Demo



When “START DEMO” is displayed, the 14-day trial period for the particular plug-in has never been activated. Clicking this button will start the demonstration period (you can also start the demo in the Control Panel’s Plug-In Status column [page 55](#)).

Demo Active



After starting the demo, and when the plug-in is still within the active 14-day trial period, the number of days remaining in demo mode is displayed here.

Important: The 14 day demo period can only be activated once, and cannot be stopped or restarted during this period! We recommend you do not activate demo mode until you have the opportunity to thoroughly check out its sound and functionality. See [“Demo Mode” on page 40](#) for more information.

Disabled



When “DISABLED” is displayed in red, the plug-in will not process audio. This can occur in two situations; either the demo period has expired (click the Buy button!), or the UAD DSP is overloaded and there are not enough device resources to run the plug-in.

Status Blank

When no text is displayed in the Status area, the plug-in is fully authorized (licensed) and operating normally. In this state, the Buy button is not displayed.

Buy Button



When the plug-in is not fully licensed, the Buy button is displayed. If the computer is connected to the internet, clicking Buy links to the UA online store so you can purchase the license. See [“UA Online Store” on page 41](#) for purchasing details.

Help Menu



The Help drop-menu contains a couple handy shortcuts for your convenience. To select the shortcuts, click the “question” icon in the Toolbar, then a shortcut from the drop-menu that appears.

Select “Manual” to open the UAD Plug-Ins Manual. Select “Web Info” to visit the product pages for the plug-in on our website (internet connection required).

Adjusting Parameters

The parameter settings for each of the UAD Powered Plug-Ins can be adjusted to achieve a desired effect. Parameter values are easily modified by dragging sliders, rotating knobs, clicking switches and buttons, or by selecting values in a drop-menu. The functions of all parameters are detailed in later chapters.

The parameter adjustment style can be Circular, Relative Circular, or Linear. For more information, see [“User Interface Settings” on page 63](#).

Note: *To increase resolution when adjusting rotary controls in circular and relative circular modes, increase the radius of the mouse relative to the knob while dragging (i.e. move the mouse farther away from the knob while dragging).*

Text Entry

Parameter values can be modified directly with text entry. To enter a parameter value using text entry, single-click the parameter value text. The text value will highlight, indicating it is ready to receive a new value. Type in a new value, then press Return, Enter, or Tab, or click outside of the text box. Press Esc if you want to revert to the prior setting without entering the new value.

Values entered via text entry are rounded to the closest significant digit. If an entered value is out of range, it will be ignored.

To enter time values, the units must be specified. m = milliseconds, and s = seconds. Examples: 400 milliseconds = 0.400s or 400m; 1.5 seconds = 1.5s or 1500m.

Scroll Wheel

If your mouse has a scroll wheel, it can be used to adjust knob and slider controls if the host application supports this functionality. Place the mouse cursor over any knob or slider control to increment or decrement the parameter value with the scroll wheel.

Keyboard Control (Mac)



If you control-click a control it selects that control for keyboard control. This is useful for when you're in circular mode, and you want to fine-adjust a control. Normally, clicking on a control in this mode makes the value jump to where you clicked. Control-clicking will select the control so that you can use the keyboard to adjust it, without making its value jump first.

Shortcuts

Table 3 on page 79 lists the keyboard shortcuts that are available for modifying parameter values. When using keyboard shortcuts, the last edited control will be modified (or, on Mac, you can use control-click to select a different control as the target for keyboard shortcuts without changing the control's value).

Note: *Not all host applications support sending keystrokes to plug-ins.*

Table 3. Keyboard shortcuts

Keyboard Action:	Result:
Control + Click Parameter (Mac only)	Select parameter for keyboard control (without changing its value)
Shift + Drag	Fine Control
UpArrow RightArrow Shift + PageUp	Increment Fine
DownArrow LeftArrow Shift + PageDown	Decrement Fine
Shift + UpArrow Shift + RightArrow PageUp	Increment Coarse
Shift + DownArrow Shift + LeftArrow PageDown	Decrement Coarse
Control + Click parameter (Windows) Modifier* + Click parameter (Mac) (*Modifier key set in Configuration Window)	Toggle initial editor setting (the value when the editor window was last opened)
Control + Shift + Click parameter (Windows) Modifier* + Shift + Click parameter (Mac) (*Modifier key set in Configuration Window)	Revert to initial editor setting (the value when the editor window was last opened)

DSP Loading Information

The UAD devices feature either one (UAD-2 Solo), two (UAD-2 Duo), or four (UAD-2 Quad) on-board DSP chips for processing Powered Plug-Ins.

Multi-DSP UAD-2 systems use significantly enhanced load balancing routines. UAD-2 plug-ins are always allocated as efficiently as possible, which is not necessarily on the DSP with the lowest resource usage.

UAD FireWire Devices

Because Firewire has significantly less bandwidth than the PCIe protocol, if UAD-2 Satellite and/or Apollo is running with UAD-2 PCIe card(s) in a multi-device system, UAD plug-ins will load on the UAD-2 card(s) before the Firewire device in order to maximize Firewire bandwidth. See [“FireWire Bandwidth vs. UAD DSP” on page 111](#) for more information.

More Loading Notes

- UAD DSP usage is proportional to the host application sample rate and system PCIe bus speed. Therefore, more plug-ins can be used simultaneously in a 44.1K session than in a 96K session, and likewise a higher speed bus will use less DSP load than a slower bus.
- Bypassing individual components will conserve DSP on some UAD plug-ins. For example, bypassing the compressor in the EX-1 when only the EQ is in use, and/or bypassing any of the unused bands of the EX-1 EQ will use less UAD DSP (unless DSP LoadLock is enabled).
- The UAD DSP resources required by each successive UAD Powered Plug-In instance will slightly decrease.
- A chart showing expected plug-in counts can be found on our website: uaudio.com/support/uad/compatibility/instance-chart.html

Host CPU Loads

- The host system memory and CPU are never used for Powered Plug-Ins processing. However, there will always be a small amount of load on the host CPU induced by data transfers and user interface operations. This is unavoidable when using any DSP device.
- When LiveTrack Mode is active, host CPU load is increased. See “LiveTrack Mode” on page 75 for details.

Automation

Every UAD Powered Plug-In parameter can be automated if this feature is supported by the host application. Each host application has its own particular methods for automation. Consult the host application documentation for specific instructions on using automation with the application.

UAD Powered Plug-Ins reduce their DSP load when bypassed or disabled, but not their memory load. This feature allows for automatable load balancing of DSP power, and keeps the track delay constant to avoid on/off clicks.

Note: *If there is not enough DSP available when automating, the plug-in may not turn on. When this occurs, “DISABLED” is displayed in the UAD Toolbar.*

External MIDI Control

UAD Powered Plug-In parameters can be controlled by an external MIDI controller, if this feature is supported by the host application. Each host application has its own particular methods for external MIDI control. Consult the host application documentation for specific instructions on using external MIDI control with the application.

Operating Levels

Except as noted in [Table 4](#) below, the internal operating level of most UAD Powered Plug-Ins is typically -18 dBFS. 0 dBFS is calibrated to $+4$ dBu with 18 dB of headroom, so 0 dBFS is the equivalent of $+22$ dBu in the analog domain.

Table 4. UAD Powered Plug-In Internal Operating Levels

UAD Powered Plug-In	Typical Internal Operating Level	0 dBFS Equivalent
Most	-18 dBFS	$+22$ dBu
Ampex ATR-102	-12 dBFS	$+16$ dBu
Manley Massive Passive	-14 dBFS	$+18$ dBu
Neve 33609 (selectable)	-14 dBFS -18 dBFS -22 dBFS	$+18$ dBu $+22$ dBu $+26$ dBu
Studer A800	-12 dBFS	$+16$ dBu

analog ears | digital minds

CHAPTER 8

Tempo Sync

Overview

The time-based parameters of several UAD Powered Plug-Ins can be synchronized to the tempo of the host application using the Tempo Sync feature.

When Tempo Sync is activated, the time-based parameters that are available for synchronization are changed to note duration values, and will sync to the tempo of the host application using the displayed note value.



Figure 21. The Tempo Sync feature within UAD DM-1L

Note: Not all host applications support Tempo Sync. In such hosts, the tempo sync features will not function.

Tempo Sync Plug-Ins

Tempo Sync is supported in the UAD plug-ins listed in [Table 5](#).

Table 5. UAD Plug-Ins with Tempo Synchronization

UAD CS-1	UAD Moog Filter
UAD Cooper Time Cube	UAD Moog Filter SE
UAD EP-34	UAD MXR Flanger/Doubler
UAD DM-1	UAD Roland RE-201
UAD DM-1L	UAD RS-1

Sync Activation To activate Tempo Sync, click the “Sync” button within the plug-in interface. The Sync button “LED” will illuminate and the time parameters will change from a time-based display to a note value (see [Figure 21](#)).

Note: When Tempo Sync is activated, the plug-in will automatically switch the time or rate parameter(s) to the nearest available note value(s) given the range of the parameter in question and the current tempo.

Available Note Values

The note values that are available for selection are listed in [Table 6 on page 83](#). The values are listed in musical notation as a division of measures. For example 1/4 = one quarter note, 1/1 = one whole note, 4/1 = four whole notes, and so forth.

The available note values were chosen to allow syncing to tempo in odd time signatures as well the common 4/4 time signature.

LFO rate parameters have their note values listed from longest to shortest, since long note values correspond to slow LFO rates.

Table 6. Tempo Sync available note values

1/64D*	1/8	5/8	4/1	
1/64	5/32*	1/1T	5/1	
1/32T	1/4T	1/2D	6/1	D = Dotted
1/32	1/8D	1/1	8/1	
1/16T	1/4	5/4	9/1	T = Triplet
1/32D	5/16	1/1D	12/1	
1/16	1/2T	7/4	16/1	* = RE-201 only
1/8T	1/4D	2/1		
1/16D	1/2	3/1		

A quarter note is always a quarter note, independent of the time signature. In different time signatures a quarter note can represent different numbers of musical beats (e.g. 6/8) or different fractions of a bar (e.g. 5/4). For example, say the time signature is 6/8 and the delay time tempo sync note value is 1/4. If a sound occurs on beat one of the measure then its delay will occur on beat 3, which is 1/4 note (i.e. two 8th notes) later.

Note: The “beat” value in a sequencer’s BPM tempo setting always refers to a quarter note, independent of time signature.

Range Limits

Some parameters in Tempo Sync mode cannot access the entire note value range in Table 4, because their maximum values would always be out of range above certain note values (assuming a maximum usable tempo of 300 BPM; 250BPM for Roland RE-201). These parameter limits are:

- DM-1, RS-1 time – 300ms: maximum 1/4D
- DM-1L time – 2400ms: maximum 3/1
- Roland RE-201 Head 1 range: 5/32 – 1/64
- Roland RE-201 Head 2 range: 1/4 – 1/32
- Roland RE-201 Head 3 range: 1/2T – 1/32D

Entering Values

In addition to adjusting the parameter knob, the two following methods can be used for entering Tempo Sync values.

Arrow Keys

After clicking the parameter to select it, the arrow keys can be used to scroll through available note values.

Text Entry

Direct text entry is also available (see “Text Entry” on page 78). Any notation values can be entered (fraction or decimal), and the values are automatically converted to the nearest appropriate setting.

For example: If 3/4 or 6/8 is entered using text entry, 1/2D is displayed because a dotted half note equals three quarter notes, which is the duration of one measure in a time signature of 3/4 or 6/8. If 12/8 is entered with text entry, 1/1D is displayed because a dotted whole note equals six quarter notes, which is the duration of one measure in a time signature of 12/8 (or two measures in a time signature of 3/4 or 6/8).

This means you can create a tempo sync duration of one measure for any time signature by simply typing in the time signature (assuming there is a match in the beat table).

Similarly, if 1/12 is entered with text entry, 1/8T is displayed because an eighth note triplet is equivalent to one-twelfth of a measure (if in 4/4 time).

Out of range

When a parameter note value is out of range of the current tempo note value, the note value is displayed in parentheses on a red background (Figure 22).



Figure 22. Tempo Sync note value display

Modes with Tempo Sync

The UAD DM-1 and UAD DM-1L plug-ins (and DM-1 within CS-1) have a Mode menu that switches the plug-in operation between delay, chorus, and flanger mode. In these plug-ins, when the Mode is set to DualDelay and Ping-Pong, the delay Time and modulation Rate parameters are simultaneously available for Tempo Sync.

However, when the plug-in is set to a Chorus or Flanger mode, only the Rate is available for Tempo Sync. This enables the more typical and musical chorus/flange effect by only syncing the modulation Rate to the tempo while the delay time remains constant.

Roland RE-201 Sync



When the RE-201 is in Tempo Sync mode, note values can be imprecise due to the fixed tape head relationships. Values that are imprecise approximations (but are within the available delay time range) are displayed with a “+” or “-” symbol. The leading head in the current mode is accurately synced; the other values are based on the fixed tape head relationship. Note that when a parameter note value is out of range of the current tempo note value, the note value flashes (instead of in parentheses on a red background as in Figure 22).

CHAPTER 9

UAD Delay Compensation

Latency & Delay Compensation

When UAD Powered Plug-Ins are used, audio data to be processed by a Powered Plug-In is sent by the host application to the UAD device. The audio is then processed by the UAD device and sent back to the host application. This back-and-forth shuffling of audio data is called “buffering” and it produces a latency (delay) in the audio signal being processed.

Latency is inherent in digital audio systems and it can be detected in certain situations. Latency time in a DAW is usually determined by the sample rate and audio I/O interface hardware buffer size settings.

If this latency is not compensated, the processed audio will not be perfectly aligned (synchronized) with unprocessed audio. Fortunately, modern audio plug-in host applications automatically compensate for this latency by simply enabling the delay compensation function in the preference settings. Most hosts provide full plug-in delay compensation throughout the entire signal path, including inserts, sends, groups/buses, and outputs

UAD latency and plug-in delay compensation is managed automatically by all modern DAWs using automatic plug-in delay compensation. Additionally, latency can be reduced to undetectable levels in the UAD-2 PCIe card by bypassing host buffering altogether (see “LiveTrack Mode” on page 75).

Note: *Delay compensation is fully automatic and requires no user intervention when UAD Powered Plug-Ins are used in hosts that support latency delay compensation.*

Host Application Settings

For optimum results, the delay compensation feature should be enabled in the host application. This will provide automatic compensation when UAD plug-ins are used. This option is usually found in the audio or plug-in preference settings window. The specific location of the setting for this option can be found in the host DAW documentation.

Latency compensation has various names depending on the host. It’s usually referred to as “Automatic Delay Compensation” (ADC), “Plug-In Delay Compensation” (PDC) or a similar related name.

Upsampled Plug-Ins

Some UAD plug-ins use an internal sample rate of 192 kHz to achieve sonic design goals. This upsampling results in a larger latency than other UAD plug-ins. Therefore, they require more compensation to remain perfectly synchronized with other tracks.

Note: *Compensating upsampled UAD plug-ins is performed automatically by the host application when latency compensation is enabled in the host.*

Upsampled Compensation Notes

- Compensating for upsampled UAD plug-ins is not required when these plug-ins are used for program material on the output bus, where latency is not a consideration (because the entire mix is delayed by the same amount).
- The latency in [Table 7 on page 88](#) is also produced when LiveTrack mode ([page 75](#)) is used with upsampled plug-ins.
- Upsampled plug-in latency cannot be displayed in the “[Plug-In Latency Section](#)” on [page 53](#) due to technical limitations.
- The Precision Multiband (PMB) and Ampex ATR-102 plug-ins have a significantly larger latency than other upsampled plug-ins because of their complex algorithms. Because manually compensating for these plug-ins in hosts that don’t support full plug-in delay compensation can be complicated, to avoid timing errors in these hosts we generally recommend using these plug-ins only on outputs, so no manual compensation is required.

Note: *Use the Precision Multiband and Ampex ATR-102 only on outputs (as their design was intended), or only in hosts that have full plug-in delay compensation.*

Upsampling Values Table

Table 7 lists the additional latency produced by upsampled UAD plug-ins.

Table 7. Upsampled UAD plug-ins with additional latencies

Upsampled Plug-in	Sample Rate (kHz)					
	44.1	48	88.2	96	176.4	192
Precision Limiter	64	69	129	140	259	281
Neve 33609 FATSO Jr./Sr. Massive Passive Moog Filter Studer A800 UA 1176 Limiter Collection	55	55	55	55	88	88
Precision Maximizer	67	67	67	67	42	42
Helios Type 69 Harrison 32C Neve 1073, 1081, 31102 Precision EQ Pultec EQ/Pultec-Pro SSL E Channel Strip Trident A-Range	31	31	13	13	0	0
Precision Multiband	15,360	16,896	30,720	33,792	61,440	66,048
Little Labs IBP	32	32	14	14	1	1
Lexicon 224	84	79	90	97	107	116
EMT 250* (see note)	75	11	85	24	107	50
Ampex ATR-102	2262	2455	4408	4798	8818	9598
MXR Flanger/Doubler	31	31	0	0	0	0

*EMT 250 Note

The EMT 250's anti-aliasing filters for its A/D and D/A conversion are not linear-phase filters; therefore our emulation does not have a latency that is the same at all frequencies. Thus, we cannot report to the delay compensation engines a delay that is correct for all frequencies. The value we report is good at low frequencies, but becomes off at high frequencies.

For example, when the plug-in is in Delay program mode and set with zero delay time and pre-delay values, the plug-in output will not be completely cancelled when mixing with flipped phase against an unprocessed track; high frequencies will leak through. However, the latency through the dry side of the wet/dry mix, and the latency when the plugin is bypassed via the EMT 250 Power switch, do not have this issue and will be fully compensated by the DAW.

Live Processing

The previous discussions of delay compensation applies primarily to playback and mixing of existing tracks. During recording (tracking), the primary concern usually centers around getting the absolute lowest possible latency out of your hardware and software combination. The lower the latency is, the closer you can get to a realtime, “ears match the fingers” performance situation in the digital environment where some latency is unavoidable.

Realtime latency is displayed in the System Information panel ([page 52](#)) within the UAD Meter & Control Panel application.

Live processing latency is determined by the audio interface I/O buffer size setting. The lower the buffer size, the lower the latency.

UAD-2 PCIe LiveTrack Mode

UAD-2 PCIe devices use an advanced buffering architecture that delivers no additional latency when tracking by using LiveTrack Mode. See “[LiveTrack Mode](#)” on [page 75](#) for details.

CHAPTER 10

UAD-2 SOLO/Laptop

Overview

ExpressCard™ is a computer expansion slot typically used in notebook computers. Utilizing a 2.5Gbps differential serial link, ExpressCard conveniently leaves slower USB and Firewire connections free for dongles, Audio I/O, and hard drives, while operating at full PCI Express bandwidth.

UAD-2 SOLO/Laptop is a compact ExpressCard version of the UAD-2 SOLO card. The UAD-2 SOLO/Laptop brings all the power of the UAD-2 to portable digital audio workstation users. The UAD-2 SOLO/Laptop enables large, professional mixes on notebook DAWs without the need for external cabling or a power supply. See “UAD-2 SOLO/Laptop Details” on page 92.

Once installed and configured, it is functionally identical to its UAD card counterparts (see “The UAD Hardware” on page 28 for a UAD hardware overview).

Note: *UAD-2 SOLO/Laptop is a discontinued product.*

Documentation

UAD SOLO/Laptop is a hardware system designed for use with UAD Powered Plug-Ins, which is the companion software package that includes the drivers, plug-ins, and software documentation.

Instructions in this chapter are specific to UAD-2 SOLO/Laptop only, and apply in addition to the other chapters. To get the most from this product, please review the following additional information:

Important Information

Important user information is presented on a printed document within the UAD ExpressCard product retail package. It provides details that may not be included in this manual. Please review the information carefully.

Technical Updates

Updated UAD technical information is regularly posted to the UA website. Please visit the UAD support pages for the latest bulletins:

- uaudio.com/support/uad/

ExpressCard Videos

Our support website contains many helpful videos that explain how to install the hardware and software, register and authorize the product, obtain optional plug-ins, and more:

- <http://www.uaudio.com/support/uad/videos.html>

UAD-2 SOLO/Laptop Instructions

All instructions that apply specifically to UAD-2 SOLO/Laptop are in the “UAD-2 SOLO/Laptop Details” section, beginning on [page 92](#).

UAD-2 SOLO/Laptop Details

Features

- UAD-2 Solo in a self-contained, compact ExpressCard/34 package (can be used in ExpressCard/54 slots with included adapter)
- 44.1-192k DSP Audio Accelerator for notebook computers
- Ultra-fast (2.5Gbps) ExpressCard/34 interface
- No external cables or power supply necessary
- Same potent DSP power as UAD-2 Solo

Package Contents

The UAD-2 SOLO/Laptop package should contain the following items:

- UAD-2 SOLO/Laptop ExpressCard
- ExpressCard/34 to ExpressCard/54 Adapter
- UAD DSP Family Quickstart Guide DVD
- UAD Powered Plug-Ins software CD-ROM
- Important Information Sheet
- Universal Audio Full Line Catalog

SOLO/Laptop System Requirements

To use the UAD-2 SOLO/Laptop, your system must meet the minimum system requirements for UAD Powered Plug-Ins (see [“System Requirements” on page 16](#)) in addition to the UAD ExpressCard product-specific requirements.

UAD-2 SOLO/Laptop requires the following hardware and software:

- UAD Powered Plug-ins software v5.3.1 or higher (included)
- Available ExpressCard/34 or ExpressCard/54 expansion slot
- UAD version 5.5.0 or higher is recommended for best performance

Software Installation

Install Software First

Software installation for UAD ExpressCard products is the exact same procedure as those for UAD cards. Install the software before the hardware. Please refer to [“UAD Software Installation” on page 18](#) for detailed procedures.

Software Updates

The CD-ROM in the retail package may not contain the latest UAD software. Please check our website for software updates:

- <http://www.uaudio.com/support/uad/downloads/>
- If the UAD software is already installed, the UAD Meter & Control Panel has a convenient button that links to the updates page (“Check for Updates” on page 52).

ExpressCard/34 to ExpressCard/54 Adapter

The UAD-2 SOLO/Laptop device uses the ExpressCard/34 form factor. When the device is installed in systems with the wider ExpressCard/54 slot, the enclosed ExpressCard/34 to ExpressCard/54 adapter should be used for the most reliable connection.

The adapter has two tabs on the bottom and one in the middle that snap into place on the SOLO/Laptop device.

To install the ExpressCard/34 to ExpressCard/54 Adapter:

1. Line up the bottom two tabs on the adapter with the corresponding holes on the SOLO/Laptop device. The wide end of the adapter aligns with the non-connector end of the ExpressCard.
2. Snap in the middle tab and the adapter will click into place. Done!

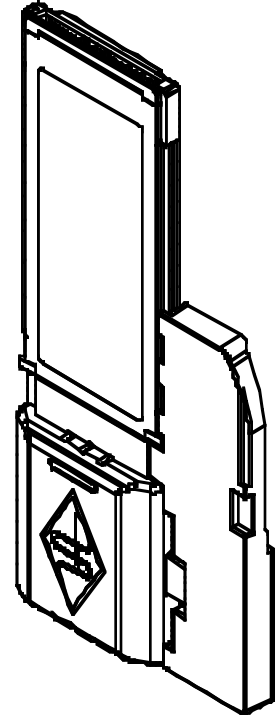

To remove the adapter, snap it off by holding the SOLO/Laptop device and gently bending the adapter down.

Inserting the SOLO/Laptop

Note: The UAD-2 SOLO/Laptop device may be inserted before or after the system is booted.

Important: Install the UAD software before inserting the device.

To install the UAD-2 SOLO/Laptop device:

1. Ensure that UAD v5.3.1 (or higher) software is already installed and that the system was restarted after software installation.
2. Ensure that all audio plug-in host software is quit.
3. Slide the UAD-2 SOLO/Laptop ExpressCard fully into the host computer’s ExpressCard/34 expansion slot (or ExpressCard/54 expansion slot with the adapter) until it is firmly seated.

4. The LED on the SOLO/Laptop will initially flash red/green, indicating the hardware is powered by the computer but the UAD drivers are not yet loaded. Within a few seconds of inserting the device (or after startup is complete, if inserted when powered down), the LED should glow steady green, indicating the UAD drivers are loaded.

UAD-2 SOLO/Laptop is ready for use.

Removing the SOLO/Laptop

Important: *The proper sequence must be followed before removing the UAD-2 SOLO/Laptop device from the computer to avoid system instability and/or data loss.*

Note: *The UAD-2 SOLO/Laptop device may be removed when the system is active, as long as the steps below are followed.*

To remove the UAD-2 SOLO/Laptop device:

1. Save your sessions and quit all UAD host software (audio applications and the UAD Meter & Control Panel).
2. Remove the UAD ExpressCard from the expansion slot. Done!

Note: *It is not necessary to power down the device in software using the "Power Off Card" function (Mac Menu Bar) or "Safely Remove Hardware" (Windows Task Bar) before removing the device.*

SOLO/Laptop Authorization

After initial installation, the UAD-2 SOLO/Laptop should be registered and authorized (it can run in demo mode for 14 days without authorization). See ["Authorization" on page 22](#) for full explanation and procedures.

Existing UAD Licenses

If you already have UAD device(s) in a desktop system, you can share those UAD licenses with UAD-2 SOLO/Laptop. This option is presented during initial device registration; please consider your options carefully when registering.

Important SOLO/Laptop Notes

For maximum system stability and reduced possibility of data loss, please observe these operational requirements when operating UAD-2 SOLO/Laptop:

Sleep

Important: Close sessions and remove UAD-2 SOLO/Laptop before sleep!

Before putting the computer into system sleep/hibernate/standby mode, quit all UAD host software and remove the UAD-2 SOLO/Laptop device. Otherwise, unpredictable behavior and/or loss of session data could occur.

“Hot” Removal

Important: Do not remove UAD-2 SOLO/Laptop while UAD plug-ins are loaded!

Removing the device when it is active could cause the system to crash. Quit all UAD hosts before removing the device.

ExpressCard/54 adapter (Windows)



Use the ExpressCard/34 to ExpressCard/54 adapter with ExpressCard/54 slots

The UAD-2 SOLO/Laptop device uses the ExpressCard/34 form factor. When the device is installed in systems with the wider ExpressCard/54 slot, the enclosed ExpressCard/34 to ExpressCard/54 adapter should be used for the most reliable connection. See “[ExpressCard/34 to ExpressCard/54 Adapter](#)” on page 93 for details.

Red/Green LED (Windows)



Reinsert the UAD-2 SOLO/Laptop if the LED flashes red/green.

Occasionally the LED on the UAD-2 SOLO/Laptop device may flash red and green after booting is complete and/or when inserting the device after boot. If this occurs, simply remove then reinsert the device, which should cause the LED to remain steady green.

CHAPTER 11

UAD-2 Satellite

Overview

UAD Powered Plug-Ins via FireWire

UAD-2 Satellite is a UAD-2 DSP accelerator that connects to the host computer via FireWire 800 or FireWire 400 and hosts UAD-2 Powered Plug-Ins on Mac OS X systems. Unlike previous UAD-2 PCIe products, UAD-2 Satellite is a completely external unit with power supply that does not require a PCIe or ExpressCard interface. This freedom from PCIe requirements enables the full UAD-2 Powered Plug-Ins library and DSP acceleration for select FireWire equipped Intel-based Apple computers – notably notebook and desktop-all-in-ones such as iMac, Mac mini, and MacBook Pro.

Once installed and configured, UAD-2 Satellite is functionally similar to its UAD-2 PCIe card counterparts. The main difference between UAD-2 Satellite and UAD-2 PCIe cards is differing architectures (FireWire versus PCIe). See [“The UAD Hardware” on page 28](#) and [“UAD-2 Family” on page 29](#) for UAD hardware overviews.

Note: *“LiveTrack Mode” is unavailable when UAD-2 Satellite is connected.*

Duo and Quad Versions

UAD-2 Satellite is available in two versions: Duo and Quad. The only difference between these two models is the number of processors inside the device (and therefore the available DSP horsepower). The Duo or Quad designator is silk-screened on the bottom of the Satellite housing.

Documentation

UAD-2 Satellite is designed for use with UAD Powered Plug-ins, the companion software package that includes the drivers, plug-ins, and documentation.

Instructions in this chapter are specific to UAD-2 Satellite operations only, and apply in addition to the other chapters. To get the most from your UAD-2 Satellite, please review the following additional information:

Important Information

Important user information is presented on a printed document within the UAD-2 Satellite retail package. This sheet provides late-breaking details that are not included in this manual. Please review the information carefully.

Technical Updates

Updated technical information and the latest UAD software is regularly posted to the UA website. Please visit the UAD support pages for the latest UAD-2 Satellite support bulletins:

- <http://www.uaudio.com/support/uad/satellite-support>

UAD-2 Satellite Instructions

All instructions that apply specifically to UAD-2 Satellite are in the “UAD-2 Satellite Installation” section beginning on [page 98](#).

About FireWire

This chapter contains information about the FireWire protocol and how to use it with UAD-2 Satellite. For details, see “[FireWire Basics](#)” on [page 105](#), “[FireWire Bandwidth](#)” on [page 109](#), “[FireWire Bandwidth vs. UAD DSP](#)” on [page 111](#), and “[FireWire Bus Power](#)” on [page 112](#).

UAD-2 Satellite Details

Important: *The information in these sections apply to UAD-2 Satellite ONLY. For UAD-2 Solo/Laptop, see [Chapter 10, “UAD-2 SOLO/Laptop”](#).*

Features

- UAD-2 Duo or Quad in an external housing chassis
- 44.1 – 192 kHz DSP Audio Accelerator for FireWire computers
- FireWire 800 & 400 interface
- Same potent DSP power as UAD-2 Duo or Quad
- Kensington Security Slot for anti-theft cables

Package Contents

The UAD-2 Satellite retail package should contain the following items:

- UAD-2 Satellite unit (Duo or Quad version)
- External power supply with international AC plug adapters
- FireWire 800 (9-pin) cable
- UAD Powered Plug-Ins software installer on CD-ROM
- Important Information Sheet
- Universal Audio Full Line Catalog

Satellite System Requirements

To use UAD-2 Satellite, your system must meet the minimum system requirements for UAD Powered Plug-Ins in addition to the UAD-2 Satellite product-specific requirements below.

UAD-2 Satellite requires the following hardware and software:

- Mac OS X 10.6.8 Snow Leopard or OS X 10.7.3 Lion (Intel systems only)
- Available FireWire 800 or FireWire 400 interface port
- See “System Requirements” on page 16 for additional requirements

UAD-2 Satellite Installation

Install Software First

The software installation procedure for UAD-2 Satellite is the exact same procedure as those for UAD cards. Install the software before the hardware unless you are updating a previous installation. Refer to “UAD Software Installation” on page 18 for detailed procedures.

Software Updates

The CD-ROM in the retail package may not contain the latest UAD software. Please check our website for software updates:

- <http://www.uaudio.com/support/uad/downloads.html>

If the UAD software is already installed, the UAD Meter & Control Panel has a convenient button that links to the updates page (“Check for Updates” on page 52).

Satellite Install Location

When selecting a location to position UAD-2 Satellite during installation and use, consider these points:

- The unit should be positioned on a secure, stable surface and not moved during operation. This will help prevent the disruption of signals from cables and/or connectors if they are accidentally bumped (or worse).
- For proper ventilation to prevent overheating, place UAD-2 Satellite on a hard, flat surface and do not cover the unit. Allow air to circulate underneath the chassis. Multiple UAD-2 Satellite units may be safely stacked.
- High levels of radio-frequency radiation could interfere with proper operation. If possible, avoid placement near unshielded monitors, radio transmitters, and similar equipment.

Security Slot



The Kensington Security Slot is on the rear panel. This feature helps prevent theft when used with an optional locking cable such as the Kensington MicroSaver Security Cable. Refer to the instructions that come with the optional cable.

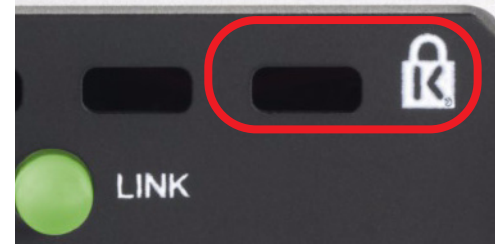

External Power Supply

UAD-2 Satellite includes an external international DC power supply with changeable AC connectors to match the AC socket in various countries (Figure 23).



Figure 23. UAD-2 Satellite external DC power supply and changeable AC connectors

To change the AC connector:

1. Press and hold the button on the AC connector marked "PUSH."
2. Rotate the AC prongs counter-clockwise to remove the connector.
3. Insert the desired connector and rotate clockwise until it snaps into place.

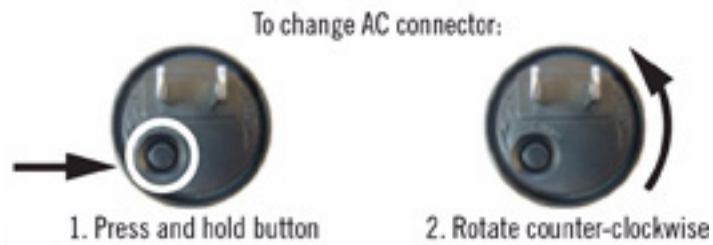

Figure 24. Changing the AC connector

Note: The removable connectors are keyed so they cannot be inserted incorrectly.

Connecting UAD-2 Satellite

Important: Install the UAD software before connecting UAD-2 Satellite (see “UAD Software Installation” on page 18). UAD-2 Satellite may be connected before or after the system is booted.

To connect UAD-2 Satellite:

1. Ensure that the UAD Powered Plug-Ins software is already installed and that the system was restarted after software installation. See “UAD Software Installation” on page 18 for specific instructions.
2. Ensure that all UAD plug-in host software is quit.
3. Select a suitable location for the UAD-2 Satellite chassis (see “Satellite Install Location” on page 98).
4. Connect the AC end of the External Power Supply to an AC outlet. If you need a different AC connector for your country, see page 99.
5. Connect external power supply output cable to the DC input on the rear panel of the UAD-2 Satellite chassis.
6. Connect one end of the FireWire cable to the FireWire port on the host computer.
7. Connect the other end of the FireWire cable to the UAD-2 Satellite chassis.
8. Turn on UAD-2 Satellite using the power switch on the rear panel. The unit may be powered on before connecting without consequence.

UAD-2 Satellite connections are complete.

You are now ready to use UAD-2 Satellite. See “UAD-2 Satellite Operation” on page 101. Additional connection methods are detailed later in this chapter.

Disconnecting UAD-2 Satellite

Important: The proper sequence must be followed before disconnecting UAD-2 Satellite from the computer to avoid unpredictable behavior and/or data loss.

To disconnect UAD-2 Satellite:

1. Save your sessions and quit all UAD host software (audio applications and the UAD Meter & Control Panel).
2. Disconnect UAD-2 Satellite from the FireWire port. Done!

Note: UAD-2 Satellite may be disconnected when it and/or the computer is powered, as long as the steps above are followed.

UAD-2 Satellite Operation

After the UAD Powered Plug-Ins software is installed ([page 18](#)) and UAD-2 Satellite is properly connected to the computer via FireWire ([page 98](#)), the system is ready for use. Refer to other chapters in this manual for software operating instructions.

All UAD-2 Satellite operations (except for hardware setup) are similar to the operation of other UAD-2 devices. See [“Important UAD-2 Satellite Notes” on page 103](#) for exceptions specific to UAD-2 Satellite.

About FireWire

For general information about FireWire and how it is used with UAD-2 Satellite and other FireWire devices, see [“FireWire Basics” on page 105](#) and [“FireWire Bandwidth” on page 109](#).

It is important to note that available FireWire bandwidth is unrelated to UAD DSP loads. See [“FireWire Bandwidth vs. UAD DSP” on page 111](#) for details.

Power Indicator

When power is applied to UAD-2 Satellite via the rear switch, the UA logo on the front panel glows. This power indicator does not represent the state of the UAD drivers or their link to UAD-2 Satellite (the [Rear Panel LED](#) indicates the operational state).



Figure 25. UAD-2 Satellite Power Indicator

Rear Panel LED

UAD-2 Satellite has a UAD link indicator on the rear panel. This LED provides information about the operational state of the device and its drivers. For more details, see [“UAD-2 LED” on page 26](#).



Figure 26. UAD-2 LED on Satellite rear panel

UAD-2 Satellite Authorization

After initial setup and before first use, UAD-2 Satellite should be registered and authorized (it can run in demo mode for 14 days without authorization). See [“Authorization” on page 22](#) for full explanation and procedures.

Existing UAD Licenses

If you already have another UAD device, you can share those UAD licenses with UAD-2 Satellite. This option is presented during initial device registration; please consider your options carefully when registering.

Hot Plugging

Hot plugging refers to the ability to disconnect UAD-2 Satellite while the host computer is active or sleeping, and reconnect it at a later time without rebooting. UAD-2 supports hot plugging (hot plugging is part of the FireWire specification).

As long as the UAD drivers are properly installed, if UAD-2 Satellite is hot-plugged into an active FireWire bus, the UAD drivers will load automatically and be ready for use.

However, disconnecting UAD-2 Satellite when UAD plug-ins are loaded could cause session data loss and/or unpredictable behavior. Quit all UAD hosts and the UAD Meter & Control Panel before disconnecting the device.

Disconnect

UAD-2 Satellite can be disconnected when it and/or the host computer is active or sleeping as long as no UAD host applications (including UAD Meter & Control Panel) are running.

Important: *Do not disconnect UAD-2 Satellite while UAD plug-ins are loaded.*

Reconnect

UAD-2 Satellite can be reconnected when the device and/or the host computer is powered up. The device will be detected and the UAD drivers will automatically load upon connection.

Adding a device to the active bus

Connecting or disconnecting a FireWire device to an active FireWire bus causes a “bus reset” (as specified by the FireWire protocol). When a FireWire bus reset occurs, all active UAD plug-ins are disabled. The session must be reloaded to reactivate UAD plug-ins.

Note: *Connect all FireWire devices to the bus before activating UAD plug-ins.*

System Sleep

System sleep while UAD-2 Satellite is active is not supported. Before sleeping the system, quit all plug-in host applications (including the UAD Meter & Control Panel) and disconnect UAD-2 Satellite. After wake, UAD-2 Satellite may be reconnected.

Important: *Quit all hosts and disconnect UAD-2 Satellite before system sleep.*

Important UAD-2 Satellite Notes

For maximum system stability and reduced possibility of data loss, please observe these requirements when operating UAD-2 Satellite:

- Due to differing architectures, [“LiveTrack Mode” on page 75](#) is unavailable when UAD-2 Satellite is connected. LiveTrack Mode is also unavailable with UAD-2 PCIe cards when UAD-2 Satellite is connected to the same system as the card(s).
- UAD-2 Satellite has a minimum hardware buffer requirement of 512 samples. The hardware I/O buffer setting for the host and audio interface can be adjusted to a value lower than 512 samples when UAD-2 Satellite is connected, and the UAD-2 Satellite drivers dynamically adjust to allow for the lower buffer setting while still maintaining UAD-2 Satellite's minimum buffer requirement of 512 samples.

Note: *For the lowest latency while tracking, disable any plug-ins currently running on UAD-2 Satellite from the input tracks and the monitoring and/or master output paths.*

- All devices on the FireWire bus share the available data bandwidth of the bus, including external hard drives and audio interfaces as well as UAD plug-ins. The amount of UAD DSP that is available for UAD plug-in processing can exceed the available FireWire bandwidth. For these reasons, the value of the [“UAD Bandwidth Allocation” on page 66](#) setting is critical. See [“FireWire Bandwidth” on page 109](#) and [“FireWire Bandwidth vs. UAD DSP” on page 111](#) for more details.
- All three FireWire ports on UAD-2 Satellite may be used concurrently as a FireWire hub, however FireWire bus power is not supplied to downstream devices. See [“Bus Power” on page 105](#) for details.
- See [“Mixing FireWire Speeds” on page 108](#) for important information about using FireWire 800 and FireWire 400 devices on the same bus.

- Although “Hot Plugging” on page 102 is supported, disconnecting UAD-2 Satellite when UAD plug-ins are running could cause unpredictable behavior. Quit all UAD hosts and the UAD Meter & Control Panel before disconnecting or powering down UAD-2 Satellite.

Important: Do not disconnect UAD-2 Satellite while UAD plug-ins are loaded.

- Once the host software is quit, you may connect or disconnect the unit even if the host computer and/or UAD-2 Satellite is powered on (see “Hot Plugging” on page 102).
- Connect all FireWire devices to the bus before activating UAD plug-ins. See “Adding a device to the active bus” on page 102 for details.
- As of UAD v5.9.0 (and higher), two UAD-2 Satellites can be used together in a single system. See Chapter 5, “Using Multiple UAD Devices” for additional information.
- Select a suitable location for the unit. See “Satellite Install Location” on page 98. UAD-2 Satellite units may be safely stacked.
- Do not bend sharp angles into or otherwise kink the FireWire cable. The cable can be damaged by improper handling.
- UAD-2 Satellite contains no user serviceable parts. Opening the unit will void the warranty.

Power Supply

- UAD-2 Satellite requires external DC power. It ships with an external power supply adapter that converts AC power to 12VDC @ 1.25A. AC input into the adapter can be 100V–240V at 50–60 Hz; several AC plug adapters are provided for international use.
- The power supply DC output connector is ring=ground/negative and tip=hot/positive. UAD-2 Satellite is diode-protected; the unit will not be damaged if the wrong DC polarity (or AC input) is connected.
- The Quad Satellite draws a maximum of 7 watts; the Duo draws 4 watts.
- The acceptable range of power input for UAD-2 Satellite is 9VDC – 15VDC @ 1A (9 Watts minimum).

Note: UAD-2 Satellite requires the external power supply. It cannot be powered by the FireWire bus, nor can it supply bus power to other FireWire devices.

FireWire Basics

FireWire (also known as “IEEE 1394” and “i.Link”) is a high-speed serial data interconnection protocol that is used to transfer digital information between devices. FireWire is commonly used to interconnect computer systems to hard drives, audio interfaces, and digital camcorders.

A complete discussion of FireWire is beyond the scope of this manual, but some of the main points and how they apply to UAD-2 Satellite are covered below.

FireWire vs. USB

FireWire is considered superior to USB for audio purposes because it does not rely on the host processor to manage low-level data housekeeping (among other reasons). FireWire typically outperforms USB at the same rated speeds.

FireWire Bus

FireWire devices are connected to a FireWire “bus” which is comprised of all devices in the serial data stream (Figure 28, Figure 29, and Figure 30 on page 107). The FireWire specification supports up to 63 peripherals per FireWire bus.

Many FireWire devices and host computers have more than one FireWire connector, but these connectors almost always attach to the same FireWire bus (most computers do not have more than one FireWire bus). It is possible to add another FireWire bus to a computer, typically by adding a PCIe-to-FireWire or ExpressCard-to-FireWire adapter card.

Bus Power

Some FireWire devices can be “bus powered” which means the device derives its operating electricity from the FireWire bus itself without a power supply of its own. See “FireWire Bus Power” on page 112 for details.

Important: UAD-2 Satellite cannot be bus powered and it does not supply bus power from its FireWire ports to other devices.

FireWire 400 vs. 800

The most common FireWire devices are available in two speeds: FireWire 400 (IEEE 1394a), which supports transfer speeds up to 400 megabits per second, and FireWire 800 (IEEE 1394b), which supports up to 800 megabits per second. It’s usually possible to determine the speed of the FireWire device by the type of FireWire connector it uses (see “FireWire Connectors” below).

Note: UAD-2 Satellite is a FireWire 800 device. See “Mixing FireWire Speeds” on page 108 for more information about using FW800 and FW400 devices on the same FireWire bus.

FireWire Connectors

FireWire 400 and FireWire 800 devices use different connectors (Figure 27 below). The connectors are not interchangeable; this helps to differentiate between the two device speeds.

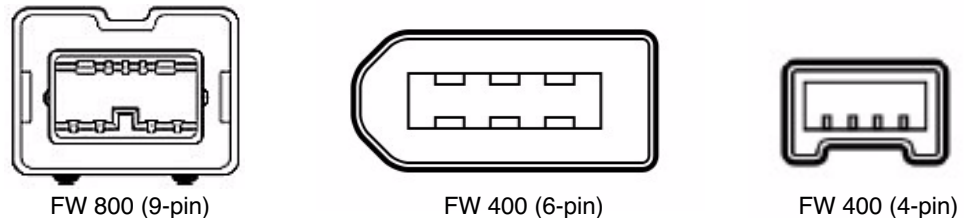

Figure 27. FireWire 800 and FireWire 400 (6-pin and 4-pin) connector types

FireWire 400 connectors

FireWire 400 devices typically have two types of connector: 4-pin and 6-pin. The small 4-pin FireWire 400 connector is common on digital camcorders and Windows notebook computers. The 6-pin connector is more common with hard drives and audio devices; the two extra pins allow the device to be bus powered (UAD-2 Satellite cannot be powered by the FireWire bus).

UAD-2 Satellite has one 6-pin FireWire 400 port.

FireWire 800 connector

FireWire 800 devices use a 9-pin connector. 9-pin to 6-pin FireWire adapter cables are available to connect FireWire 800 devices to a FireWire 400 bus (with reduced bandwidth). See “Mixing FireWire Speeds” on page 108 for more information.

UAD-2 Satellite has two FireWire 800 ports to facilitate easy daisy-chaining with other FireWire devices.

Hubs and Chains

FireWire devices can be connected to a central hub, such as a computer with multiple FireWire ports or a peripheral FireWire hub (Figure 28 on page 107), connected to each other serially in a “daisy-chain” (Figure 29 on page 107), or any combination of the two in a “tree-chain” topology (Figure 30 on page 107). Note the diagrams in these figures are only examples; devices may be connected in any order (see “Mixing FireWire Speeds” on page 108 for exceptions).

Additionally, UAD-2 Satellite can function as a FireWire hub, by using the unused ports on the unit to connect other FireWire devices as in [Figure 31](#). Note that UAD-2 Satellite does not supply FireWire bus power to downstream devices; see [“FireWire Bus Power”](#) on page 112 for details.

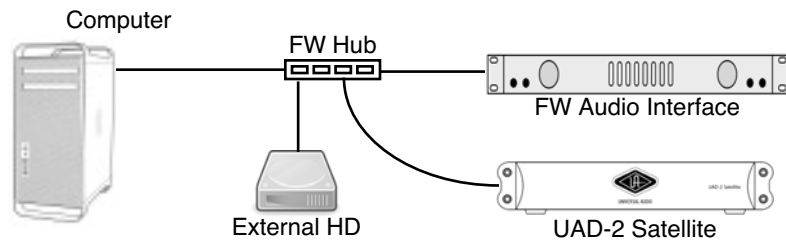

Figure 28. FireWire bus connections via a hub

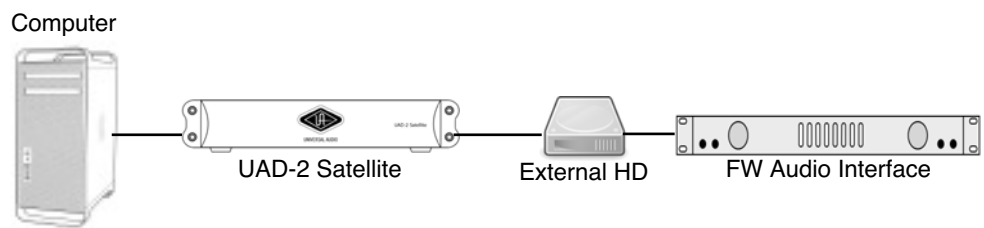

Figure 29. FireWire bus connection via daisy chain

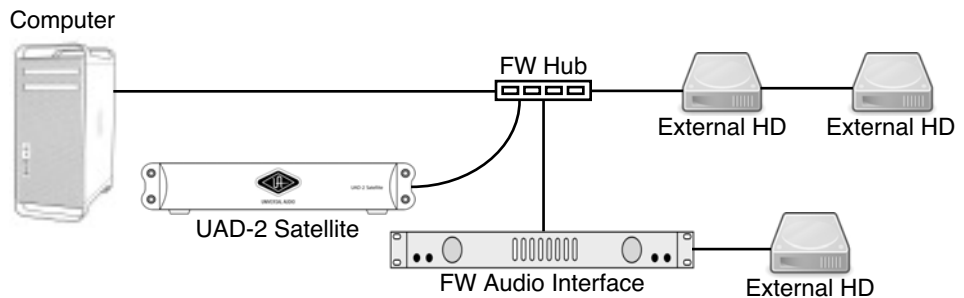

Figure 30. FireWire bus connections via hub and daisy chain

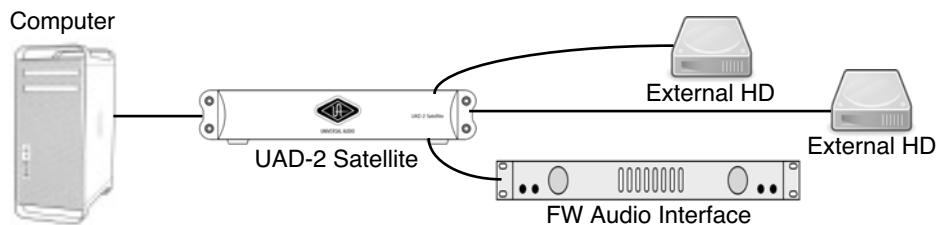

Figure 31. FireWire bus connections using UAD-2 Satellite as a hub

Connections

The ability to connect and disconnect FireWire devices while power is applied (or not) is part of the FireWire specification. Since UAD-2 Satellite is IEEE 1394 compliant, the device may be “hot plugged” while powered up.

Note: See “Hot Plugging” on page 102 for detailed information.

Mixing FireWire Speeds

Although FireWire 400 and FireWire 800 devices can be connected to the same FireWire bus via a hub or daisy-chain, special precautions must be observed to maximize bandwidth in these situations.

Note: See Figure 34 on page 109 for the recommended configuration when mixing FireWire bus speeds.

FireWire 800 devices on a FireWire 400 bus

FireWire 800 devices are backwards-compatible and can be connected to a FireWire 400 bus (using a 6-pin to 9-pin FireWire cable or adapter). However in this scenario (Figure 32) any 800 megabit-capable device on the bus (including UAD-2 Satellite) will operate at a maximum of 400 megabits because FireWire bandwidth cannot exceed the maximum bus speed of the host computer.

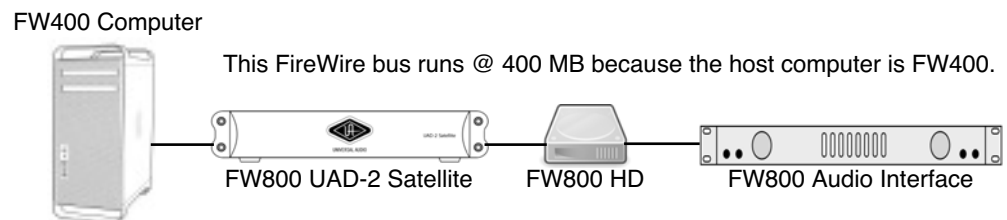

Figure 32. FireWire 400 bus – all devices run at 400 megabits

FireWire 400 devices on a FireWire 800 bus

FireWire 400 devices can be connected to a FireWire 800 bus (using a 6-pin to 9-pin FireWire cable or adapter). In Figure 33, all FireWire devices will operate at a maximum of 400 megabits because the FW800 device is located after the FW400 device in the daisy chain (the FW400 device forces all subsequent devices to run at FW400 speeds).

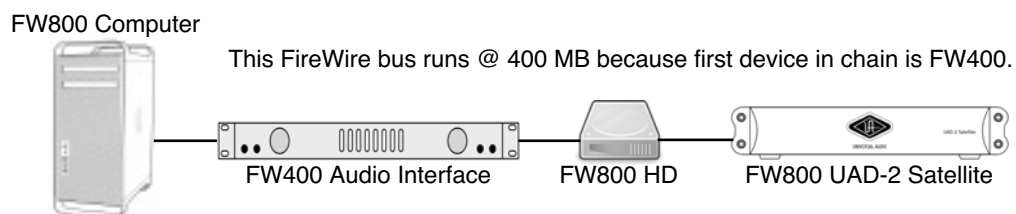

Figure 33. FireWire 800 bus – all devices run at 400 megabits (not a recommended setup)

It is possible to configure a FireWire bus to run at both FW400 and FW800 speeds simultaneously if the host computer bus is FW800, supporting maximum throughput for a mix of FW400+FW800 devices. This is accomplished by putting any/all FW400 devices AFTER any/all FW800 devices in a daisy chain (see [Figure 34 on page 109](#)).

Daisy-chain FireWire 400 devices AFTER the FireWire 800 devices in a FW800 bus

If (and only if) FireWire 400 devices are attached to a FireWire 800 bus after the end of all FireWire 800 devices in a daisy-chain ([Figure 34](#)), the FireWire 800 devices will operate at 800 megabits while the FireWire 400 device operates at 400 megabits.

Important: This is the recommended configuration when UAD-2 Satellite is sharing a FireWire 800 bus with FireWire 400 devices.

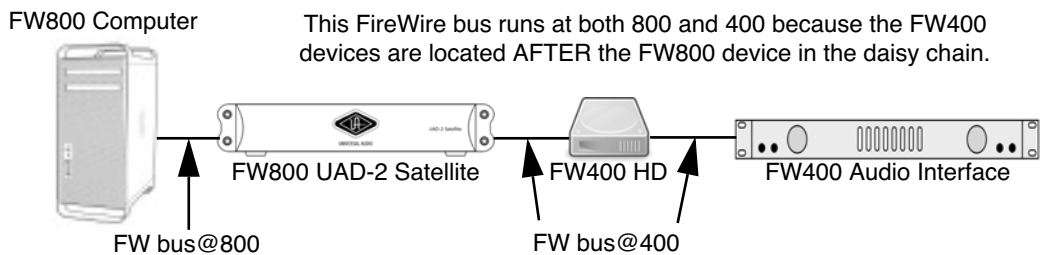

Figure 34. FireWire 800 bus – devices running at 800 and 400 megabits (recommended setup)

FireWire Bandwidth

All devices on a FireWire bus must share the available data bandwidth of the bus, including hard drives and audio interfaces as well as UAD-2 Satellite. If there is not enough FireWire bandwidth to handle all the data traffic on the bus, performance issues (such as audio clicks/pops/dropouts or UAD overloads) could occur.

Bandwidth Gauge

When UAD-2 Satellite is connected, the UAD Meter window displays the FireWire Bandwidth gauge ([Figure 35 on page 110](#)), showing the amount of FireWire bandwidth being used by UAD-2 Satellite and other FireWire devices on the bus. [Figure 36 on page 110](#) details all of the elements in the gauge.

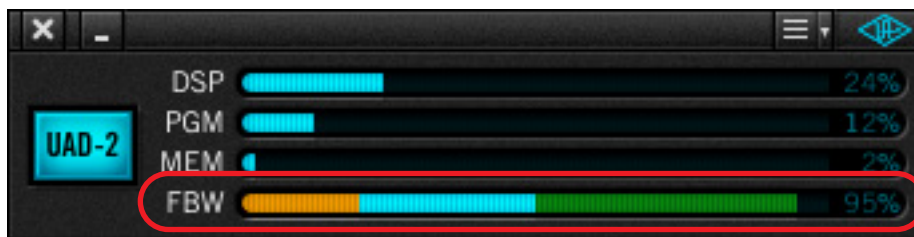

Figure 35. The UAD Meter with UAD-2 Satellite

Important: FireWire bandwidth is unrelated to UAD DSP loads. See “FireWire Bandwidth vs. UAD DSP” on page 111 for details.

Sharing Bandwidth

If UAD-2 Satellite is the only device on the FireWire bus, UAD processing traffic can use the entire bandwidth of the bus. However, if other FireWire devices are on the bus, the amount of bandwidth used for UAD traffic must be reduced so those devices will have enough bandwidth for their processes as well.

Bandwidth Control

The FireWire bandwidth used for UAD traffic is controlled using the “UAD Bandwidth Allocation” on page 66. By using the “FireWire Gauge” on page 69, it’s easy to determine how much bandwidth is being used by the non-UAD devices, so appropriate choices can be made when setting the UAD Bandwidth Allocation.

These settings, and all other UAD-2 Satellite FireWire parameters (Figure 37 on page 111), are made in the UAD Meter & Control Panel. See “FireWire Panel” on page 64 for detailed descriptions of the FireWire controls.

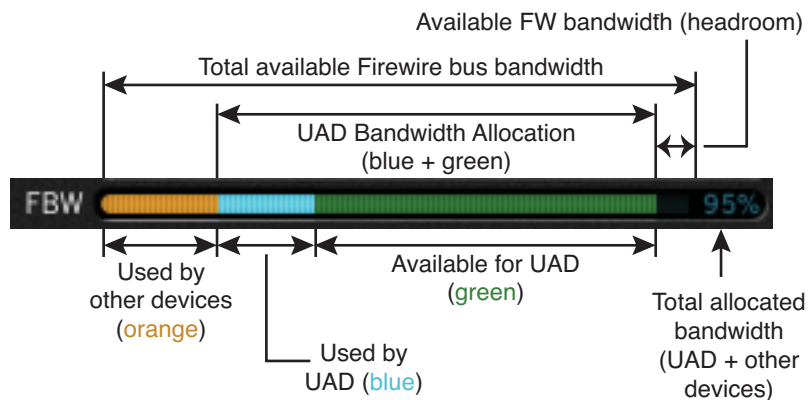

Figure 36. Elements of the UAD FireWire Gauge

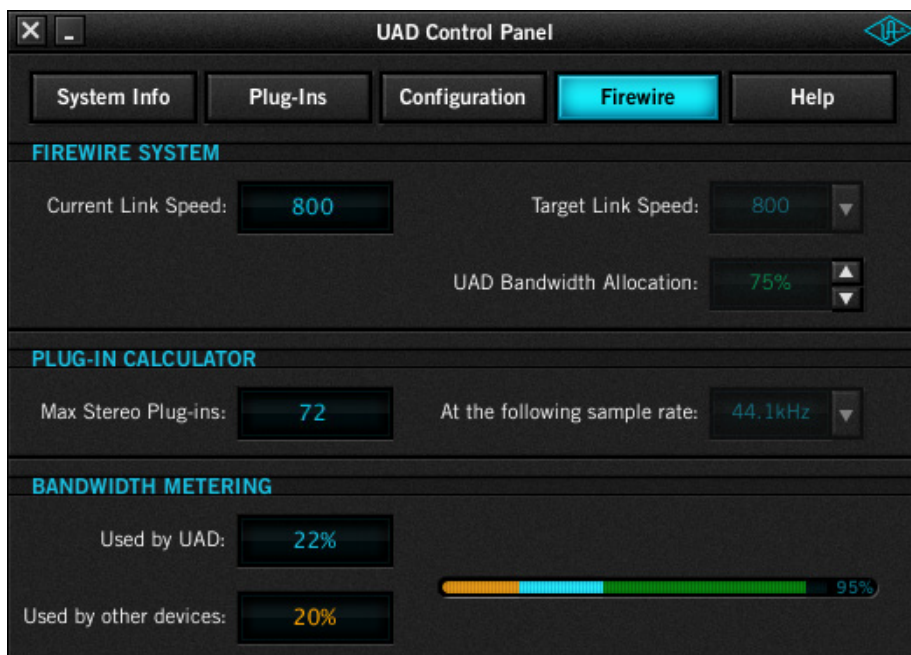

Figure 37. The UAD FireWire panel (control descriptions are in Chapter 6)

FireWire Bandwidth vs. UAD DSP

The amount of FireWire bandwidth used by UAD-2 Satellite depends on the number (the quantity) of UAD plug-ins that are loaded on the device; the amount of DSP used by a UAD plug-in (the quality) does not affect FireWire bandwidth at all.

In other words, each UAD-2 Satellite plug-in instance uses a fixed amount of FireWire bandwidth, regardless of how much DSP a given UAD plug-in uses. It is the audio data stream to and from a UAD plug-in that uses the FireWire bandwidth. The amount of digital signal processing occurring on the UAD device itself is unrelated to the FireWire traffic in and out of the device.

Therefore, with UAD-2 Satellite it is possible to run out of available FireWire bandwidth before running out of available UAD DSP. For example, running ten lightweight plug-ins such as UAD EX-1 on UAD-2 Satellite will use the same FireWire bandwidth as running ten DSP-intensive plug-ins such as UAD Moog Multi-Mode Filter. However, the EX-1s will use a fraction of the UAD DSP that UAD Moog Filter would require for the same instance count.

See ["DSP Loading Information"](#) on page 79 for additional notes.

Important: *FireWire bandwidth is unrelated to UAD DSP loads.*

FireWire vs. PCIe

The maximum possible data throughput even at FireWire 800 speeds is only a fraction of what is possible with PCIe. Therefore, if very high UAD plug-in counts are required, UAD-2 PCIe cards provide an alternate solution.

FireWire Bus Power

Some FireWire devices can be “bus powered” which means the device derives its operating electricity from the FireWire bus itself without a power supply of its own. This operating current, when available, is supplied via two conductors in FireWire cables and ports (4-pin FireWire 400 cables and ports cannot supply bus power).

Although bus powering is part of the FireWire specification, it is an optional feature. Not all FireWire devices are designed to use it nor are all devices designed to supply it, for a variety of reasons. For example, a device may require more current than can be supplied by bus power, or a device may be unable to provide enough current to its FireWire ports.

UAD-2 Satellite cannot be bus powered nor does it supply bus power from its FireWire ports to other devices. Therefore, when using a FireWire device that requires bus power, it is important to connect that device directly to a FireWire port that supplies bus power (such as the computer itself or an externally powered FireWire repeater that is specifically designed to supply bus power).

Important: *UAD-2 Satellite cannot be bus powered and it does not supply bus power from its FireWire ports to other devices.*

Bus Powering Example

Figure 38 on page 113 illustrates the proper method of connecting bus powered FireWire devices with UAD-2 Satellite. An externally powered FireWire repeater or hub that is specifically designed to provide bus power to connected devices must be used in this case.

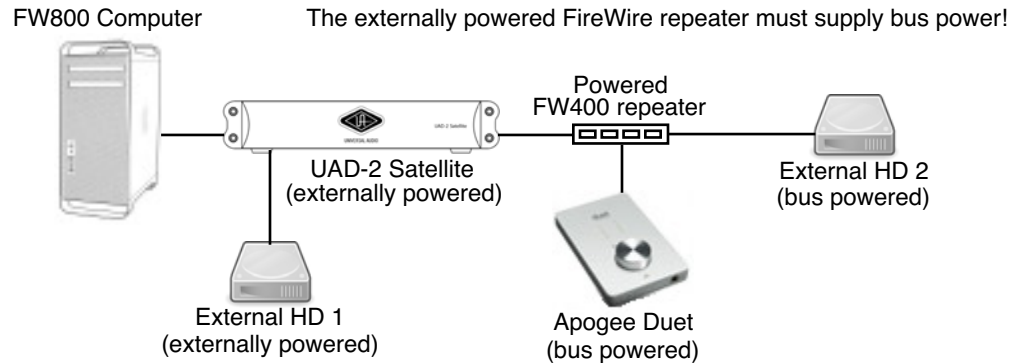

Figure 38. Proper connection of bus powered FireWire devices

This example uses the Apogee Duet, a popular audio interface with one FireWire port that can only be bus powered. If the Duet was connected directly to UAD-2 Satellite, it would not have power to operate because UAD-2 Satellite does not supply bus power. Therefore, the Duet must be connected to the externally powered FireWire repeater or hub that provides bus powering.

In this example, UAD-2 Satellite operates at FireWire 800 speeds because it is connected directly to a FireWire 800 computer. If external HD #1 is a FireWire 800 device and it is connected a FireWire 800 port on UAD-2 Satellite, it will also operate at FireWire 800 speeds. Because the FireWire repeater is a FireWire 400 device, all devices connected to it operate at FireWire 400 speeds. See ["Mixing FireWire Speeds" on page 108](#) for more about connecting devices of various speeds on the same FireWire bus.

Caveats

The quality and compatibility of powered FireWire repeaters and hubs can vary widely. Just because a FireWire repeater or hub is externally powered doesn't necessarily mean it provides bus power or that it is compatible with UAD-2 Satellite and other FireWire devices. For the latest compatibility information and specific repeater and hub recommendations, please visit the UAD-2 Satellite support page:

- www.uaudio.com/support/uad/satellite-support

CHAPTER 12

History

Bill Putnam Sr.

The name M.T. “Bill” Putnam retains a unique status in the audio industry hall of fame- it's legendary even among those who are considered to be legends themselves. Called the “father of modern recording” by no less a luminary than Bruce Swedien, and a “visionary, responsible for motivating new thinking,” by respected studio engineer Tom Hidley, Putnam was a true renaissance man in the world of sound and music. As a record producer, engineer, inventor, writer, singer, technician, studio owner and businessman, he excelled at combining his talents in a creative way. A pioneer in recording studio acoustics, Putnam is acknowledged to be the first person to use artificial reverberation for commercial recordings. He also developed the first multi-band equalizers, and with his company Universal Audio, was responsible for the development of classic equipment like the 1176LN and UREI® Time Align monitors. He was involved in the early development of stereophonic recording, and founded studios in Chicago, Hollywood and San Francisco whose legacy still lives on today.

Early Interests Born in 1920 in Danville, Illinois, he was influenced by his father, a businessman who also put on radio programs, including a number one country music show. Young Putnam's interests surfaced early; in Boy Scouts he earned a merit badge in wireless, building a crystal set and a one-tube radio. By 15 he was taking the ham radio operator's exam and constructing his own equipment. In high school both his artistic and technical sides emerged full on. He worked repairing radios and renting out P.A. systems, while also singing on weekends with dance bands (for five dollars a night, which included the P.A. rental!), developing his interest in the music business, and realizing, as he has said, that “musicians were my favorite people.”

Universal Recording Corp. Opens in Chicago Technical college followed, then work at radio stations, and radio engineering work for the Army during World War II. In 1946 Putnam started his own recording studio, Universal Recording Corp., in Evanston Illinois. His goals at the time, besides having a successful business, were the development of new recording techniques and specialized equipment for recording studios.

To that end the manufacturing company Universal Audio, which later became UREI®, was formed. Most of the equipment, including the console, for Universal Recording was built by



Universal Audio. It wasn't long before the company relocated to Chicago, and it was there, in 1947, that Putnam recorded what is generally accepted to be the first "pop" record to use artificial reverberation. The founder of the group The Harmonicats, Jerry Murad, wanted to record using an echo chamber like he'd heard on effects in spooky radio mysteries. Putnam not only financed the record for a piece of the profits, he came up with the idea of using the tiled men's room at Universal Recording to create that echo. The Harmonicats song "Peg-O-My-Heart," became the first million seller smash with more than 1,400,000 copies sold, and the rest was, well, history.

Landmark Recordings Bruce Swedien, a teenager at the time, recalls that the sound on "Peg-O-My-Heart" was a seminal influence on him. "It was the first pop music recording where artificially controlled reverb was used for artistic effect," he explains. "Many of the recordings that were done prior to that had reverb, but it was part of the acoustics of the recording environment. Bill's contribution to the art was that he literally came up with the design of the way the echo or reverb sound is sent from the recording desk and the way it's returned to the mix so that it can be used in a variable amount.

"I was a youngster in Minneapolis in the early 50s when I first heard "Peg-O-My-Heart," Swedien continues, "And I can remember it like it was yesterday. It had an extraordinary effect on me. I didn't understand how the techniques were done, but I knew it had tremendous artistic impact."

Putnam's engineering credits grew quickly; at that time he worked with artists such as Patti Page, Vic Damone and Dinah Washington, and had a million selling record on his own Universal Records label with "Jealous Heart" by Al Morgan. A number of firsts occurred at Universal: the first use of tape repeat, the first vocal booth, the first multiple voice recording, the first 8-track recording trials and experiments with half speed disc mastering.

Universal was becoming famous, doing recordings for the Chicago based labels VeeJay, Mercury and Chess. It was a hub for rhythm and blues recordings including cuts for Muddy Waters, Willie Dixon, Bo Diddley, Little Walter, and Chuck Berry. Jazz artists recorded by Putnam included Stan Kenton, Tommy Dorsey, Count Basie, Dizzy Gillespie, Ella Fitzgerald, Sarah Vaughn, Nat King Cole, and the master, Duke Ellington. Putnam was also producing records for Decca, as well as writing songs and lyrics.



With all this success, Universal Recording went through several incarnations, with the dream version completed in 1955. At that time it was the most advanced and largest independent recording facility in the country attracting top producers like Nelson Riddle, Mitch Miller and Quincy Jones. It was also at that time that Bruce Swedien went to work for the studio.

"It's absolutely true," he states. "Bill Putnam was the father of recording as we know it today. The processes and designs which we take for granted — the design of modern recording desks, the way components are laid out and the way they function, console design, cue sends, echo returns, multitrack switching — they all originated in Bill's imagination."

Murray Allen, who purchased Chicago's Universal Recording from Putnam in 1972 elaborates. "Bill was a brilliant person, highly talented, with a great set of ears," he says. "He was Duke Ellington's favorite engineer, among many, and at one time he had more singles in the top 40 than anybody else. At the time, if you needed something in sound, he was the guy. He designed systems for the Sands and other big showrooms in Las Vegas; John Kennedy flew him out to arrange the sound for the broadcast of his inauguration. He did it all."

Moving West- United Recording Corp. With his Chicago studio so successful, Putnam's clients began urging him to open a facility on the West Coast, and finally he was convinced. In 1957 he sold his interest in Universal Recording, started a new company called United Recording Corp. and moved to Hollywood, taking over a building at 6050 Sunset and starting construction on new studios. Stereo was taking off, and Putnam was determined to incorporate as many technological innovations into the complex as possible.

In 1958, Studio B was completed along with two reverb chambers. The facility soon grew to three studios, a mixdown room, three mastering rooms including one with stereo, and a small manufacturing plant, all in 15,000 square feet. The studios were busy around the clock, with projects from Ricky Nelson to voice-overs for Hanna Barbera cartoons like the Flintstones.

In the early 60s Western Recorders, one block away at 6000 Sunset, was acquired and re-modeled. The studio was renamed United Western, and business continued to grow. The talent behind and in front of the glass in those days reads like a who's who of classic recording: Bones Howe, Wally Heider and Lee Hirschberg were on staff. During the 60s and 70s the studios were jumping 24 hours a day, seven days a week with artists like Frank Sinatra, Bing Crosby, Dean Martin, Sammy Davis, Nat King Cole, Johnny Mercer and Ray Charles. Charles classic



"I Can't Stop Loving You" was recorded there, as well as Sinatra's "It Was A Very Good Year," and The Mamas and The Papas' "California Dreamin'". The United Western studios, still in existence today as both Cello Studios and Allen Sides' Ocean Way Recording, are still considered to be some of the best sounding rooms ever built.

Universal Audio and UREI Meanwhile, upstairs in the 6050 Sunset building Universal Audio was thriving, and changing names. Now called UREI®, the company had acquired the patent rights to the LA-2A leveling amplifier, and also to National Intertel, which became the Teletronix division of UREI®. It was a unique situation; Putnam was always searching for better ways to do things and the combination of studios and manufacturing led readily to new product ideas. Out of this synergy came the 1176LN leveling amplifier, the 1108 FET preamp and, in conjunction with Ed Long, the 813 family of speakers.

Mentor and Innovator Allen Sides, currently owner of Ocean Way Recording, whose studios today encompass almost unchanged what was part of United Western, calls Putnam "my best friend." "When Bill started designing control rooms they were about eight feet by six feet and they were calling them booths," he says. "He built the first of what we now call conventional control rooms, with speakers above the windows. The whole control room concept we think of today was Bill's. The first console that had equalizers in every channel was Bill's, the feedback equalizer was Bill's creation, he built all his own limiters, his own consoles, he could tune his own pianos; he basically did the whole deal.

"Around 1962 he was doing half speed cutting, to get the high frequencies on the discs," recalls Sides. "He'd designed his own mastering systems, because you couldn't do it any other way. He was recording on custom made 30ips machines and he was doing all the super hi fi stuff, like the Mercury Living Presence series."

Sides, who is renowned for both his golden ears and his abilities in the 'art of the deal,' appreciated Putnam on many levels. "He was an exceptional businessman, with a tremendous understanding of things," he says. "If I had a complex deal and I couldn't quite figure out how to approach it, I'd sit down with Bill and he'd reason it out in the most amazing way.

"There's a great story about when stereo was coming on. The record companies really weren't that interested — everyone was cost conscious. They didn't want to spend any more money and



they were saying that stereo was a waste of time. But Bill could see the potential, and around 1959 he started recording everything with feeds to two control rooms, one for a stereo mix, one for a mono mix. In late '58, '59 and '60 everything Bill did was recorded in both stereo and mono.

“When stereo hit big around '61, none of the record companies had any catalog. But Bill did — he had two and one half years worth. It was a lot of material — understand at that period of time he was doing about \$200,000 a month in the United Western Complex — which is like a million dollars a month now.

“So the record companies came to Bill and said, 'We'll pay you for the tape.' And he said, 'No, you can't pay for the tape, but if you repay me all the studio time that was used in the last two and a half years you have a deal.' And they did. They wrote him a check for the whole thing.”

It's recollections like these that bring home Putnam's visionary and entrepreneurial style. An undisputed leader in music recording and in recording technology, with innumerable accolades to his credit, it's his son, Bill Putnam, who perhaps sums it up best, in a way Bill Sr. himself might like. Bill Jr. says, simply, “He was a guy who built equipment to solve problems in the studio.”

“There's a whole school of what I'd call Bill Putnam engineers out there,” concludes Murray Allen. “People like Allen Sides and Bruce Swedien who worked with him and who really understood what recording sound should be about. They've carried on his tradition, and I think we all agree that it's very important for people to know what he contributed.”

Classic Compressors

The LA-2A and 1176 compressor/limiters long ago achieved classic status. They're a given in almost any studio in the world — relied upon daily by engineers whose styles range from rock to rap, classical to country and everything in between. With so many newer products on the market to choose from, it's worth looking at the reasons why these classics remain a necessary part of any professional studio's outboard equipment collection.

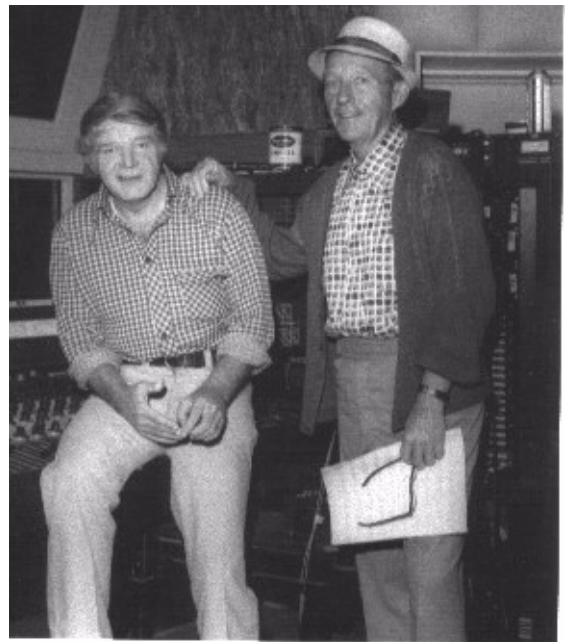

The basic concept of a compressor/limiter, is of course, relatively simple. It's a device in which the gain of a circuit is automatically adjusted using a predetermined ratio that acts in response to the input signal level. A compressor/limiter "rides gain" like a recording engineer does by hand with the fader of a console: it keeps the volume up during softer sections and brings it down when the signal gets louder. The dynamic processing that occurs at ratios below 10 or 12 to one is generally referred to as compression; above that it's known as limiting.

Modern day compressors offer a great degree of programmability and flexibility – older devices such as the 1176 and the LA-2A are more straightforward in their design. Perhaps it is this fact that has contributed to their appealing sound and the longevity of their popularity.

LA-2A

The LA-2A leveling amplifier, a tube unit with hand wired components and three simple controls, was introduced in the mid-1960s. It utilized a system of electro-luminescent optical gain control that was quite revolutionary. Gain reduction was controlled by applying the audio voltage to a luminescent driver amplifier, with a second matched photoconductive cell used to control the metering section. With its 0 to 40 dB of gain limiting, a balanced stereo interconnection, flat frequency response of 0.1 dB from 30-15,000 Hz and a low noise level (better than 70 dB below plus 10 dBm output), the LA-2A quickly became a studio standard. Originally patented by Jim Lawrence, it was produced by Teletronix in Pasadena, California, which became a division of Babcock Electronics Corporation in 1965. In 1967 Babcock's broadcast division was acquired by the legendary Bill Putnam's company, Studio Electronics Corporation shortly before he changed the company's name to UREI®. Three different versions of the LA-2A were produced under the auspices of these different companies before production was discontinued around 1969.

1176LN

It was Bill Putnam himself who, in 1966, was responsible for the initial design of the 1176. Its circuit was rooted in the 1108 preamplifier which was also designed by Putnam. As is evident from entries and schematics in his design notebook, he experimented with the recently developed Field Effect Transistor (F.E.T.) in various configurations to control the gain reduction in the circuit. He began using F.E.T.s as voltage variable resistors, in which the resistance between the drain and the source terminals is controlled by a voltage applied to the gate. His greatest challenge was to ensure that distortion was minimized by operating the F.E.T.s within a linear region of operation.



After several unsuccessful attempts at using F.E.T.s in gain reduction circuits, Putnam settled upon the straightforward approach of using the F.E.T. as the bottom leg in a voltage divider circuit, which is placed ahead of a preamp stage.

The output stage of the 1176 is a carefully crafted class A line level amplifier, designed to work with the (then) standard load of 600 ohms. The heart of this stage is the output transformer, whose design and performance is critical. Its primary function is to convert the unbalanced nature of the 1176 circuit to a balanced line output, and to provide the proper impedance matching to drive the line impedance of 600 ohms. These two jobs are accomplished by the primary and secondary windings whose turns' ratio defines the impedance ratio.

This transformer is critical due to the fact that it uses several additional sets of windings to provide feedback, which makes it an integral component in the operation of the output amplifier. Putnam spent a great deal of time perfecting the design of this tricky transformer and carefully qualified the few vendors capable of producing it.

The first major modification to the 1176 circuit was designed by Brad Plunkett in an effort to reduce noise—hence the birth of the 1176LN, whose LN stands for low noise. Numerous design improvements followed, resulting in at least 13 revisions of the 1176. Legend has it that the D and E blackface revisions sound the most “authentic”.

The original Universal Audio 1176LN designed by Bill Putnam was a major breakthrough in limiter technology – the first true peak limiter with all transistor circuitry offering superior performance and a signature sound. Evolved from the popular Universal Audio 175 and 176 vacuum tube limiters, the 1176LN retained the proven qualities of these industry leaders, and set the standard for all limiters to follow.



Pros Talk UA

Both the 1176 and the LA-2A remain in daily use. Busy engineers and producers' comments about both the 1176 and the LA-2A demonstrate their impact on the industry:

Mike Shipley:

Mike Shipley (Def Leppard, Shania Twain, Blondie): "I grew up using 1176s – in England they were the compressor of choice. They're especially good for vocals, which is also what I primarily use the LA-2 for. Most anything else I can do without, but I can't be without at least a pair of 1176s and an LA-2A. For example, on the Enrique Iglesias project I'm currently mixing, I'm using both an 1176 and an LA2 on his voice, which is not unusual for me.

"The 1176 absolutely adds a bright character to a sound, and you can set the attack so it's got a nice bite to it. I usually use them on four to one, with quite a lot of gain reduction. I like how variable the attack and release is; there's a sound on the attack and release which I don't think you can get with any other compressor. I listen for how it affects the vocal, and depending on the song I set the attack or release – faster attack if I want a bit more bite. My preference is for the black face model, the 4000 series – I think the top end is especially clean.

"The LA-2A is not as versatile, but it also has a sound that I really like. On certain voices you can crank it heavily, to where you almost want to put a piece of tape over the meter because there's so much gain reduction that you don't want anyone else to see it! I'm not particularly into overcompression, but when you use it that way there's something about it that just sounds really great. It does depend how it's set on the back, where there's a flat control that can be set to roll off certain frequencies when you reduce more gain. If you have a singer with an intensely piercing voice I find that compressor a good one, incredibly useful. It makes things warmer, especially when you crank it, and for thinner voices that can be just the ticket."

Allen Sides

Allen Sides has always been known for having golden ears when it comes to the sound of equipment. The owner of Ocean Way Studios in Los Angeles and Nashville, he's also a speaker designer and engineer who is especially respected for his work with live



musicians, including orchestra and string dates. Among his recent credits are work with the Goo Goo Dolls, Alanis Morissette and Green Day. Sides brings his different perspectives into play when he talks about using the 1176.

“The 1176 is standard equipment for my sessions. I just used them last night, as a matter of fact, on a project for singer Lisa Bonet that Rob Cavallo was producing at Ocean Way. We were recording drums and I used them on the left/right overheads as effects limiters. It's something I learned from (engineer) Don Landy, who worked with Randy Newman a lot. I mult the left and right overheads and bring them back on the console, then insert a pair of 1176s into a pair of the mults. Push in 20 to one and four to one simultaneously and it puts the unit into overdrive creating a very impressive sound.”

Murray Allen

Murray Allen is a veteran engineer and Director of Post Production for the San Francisco Bay Area company Electronic Arts. He has a fascination for gear both old and new and he explains why he thinks the 1176 has been so popular for so long. “It has a unique sound to it that people like, it's very easy to operate, and it does a great job. You have just two controls relative to the ratio of compression. You have input and output and you have attack and release. That's all there is. It's still my favorite limiter for Fender basses and string basses, because you don't know it's working. It doesn't change the way the bass sounds, it just keeps the level at a more controllable place.

Ken Kessie

Mixer Ken Kessie (En Vogue, Tony! Toni! Tone!, Celine Dion) is known for being experimental. “Seems like everybody knows the basic tricks for the 1176,” he says, “But here are two that might be lesser known. If you turn the attack knob fully counterclockwise until it clicks, the 1176 ceases to be a compressor and acts only as an amplifier. Sometimes this is the perfect sound for a vocal. And of course the unit can be overdriven, adding another flavor of distortion in case your plug-ins are maxed out!

“Then, for that hard-to-tame lead vocalist (the one that backs up from the mic to whisper and leans in for the big ending chorus), try an 1176 followed by a DBX 165. Use the 1176 as a compressor, and the DBX as a peak limiter...it's guaranteed to be smooth as silk.”



Jim Scott

Jim Scott shared a Grammy for Best Engineered Album for Tom Petty's Wildflowers. He's also known for his work with Red Hot Chili Peppers, Natalie Merchant and Wilco. "I use 1176s real conservatively and they still do amazing things," he comments. "I'm always on the four to one button, and the Dr. Pepper – you know, 10 o'clock, 2 o'clock, and it does everything I need.

"I always use them on vocals. I use them on room mics, on acoustic guitars – sometimes in mixing I'll sneak a little on a snare drum or a separated channel of a snare drum. I'm not one of those guys who leaves it on everything, but I'd have to say I've used an 1176 on everything at one time or another.

"They have an equalizer kind of effect, adding a coloration that's bright and clear. Not only do they give you a little more impact from the compression, they also sort of clear things up; maybe a little bottom end gets squeezed out or maybe they are just sort of excitingly solid state or whatever they are. The big thing for me is the clarity, and the improvement in the top end.

"The 1176 has that same kind of phenomenon, where, when you patch something through a Neve equalizer and you don't even engage the EQ, it sounds better. It's just a combination of the amps.

"I also use LA-2As all the time. I use them on bass, and it's one of the compressors I use for reverb. Often I'll send a bunch of things to one LA2A and bring it back into the console like a return – it's great for drums, great for kick drum especially.

"LA-2As warm things up. They're the opposite of the 1176 – they EQ all the warmth and low mids and bass. When you put bass and drums in them they get fatter and bigger. And unless you hit them way hard and make the tubes sizzle they don't really distort. Of course, you can get them to sound like an AC30 if you want to, just turn them all the way up. They are very loud, powerful amplifiers.

"I've also used both the 1176 and the LA-2A for stereo buss compressors – you just have to be a little bit careful that your mixes don't go one sided. Tom's [Petty's] records have often been mixed through 1176s. I've also done that with LA-2As – they are of course, more inconsistent piece to piece than the 1176s, because of the tubes and the difference in fatigue of the tubes.



"My big mentors were Andy Johns and Lee DeCarlo and Ron Nevison because they were all Record Plant guys. I learned how to make a rock and roll record from them. Although over the years it's become my own thing, my style still tends to be that Record Plant style, U87s, 1176s, LA-2As, 47 F.E.T.s...it's what I like."

Mike Clink

Producer/Engineer Mike Clink (Guns N' Roses, Sammy Hagar, Pushmonkey) also comes from the Record Plant school of recording. "I find that I actually use 1176s more now than I ever did," he comments. "I like them because they bring out the brightness and presence of a sound – they give it an energy. It seems like when I'm mixing I end up using an 1176 on the vocals every time. And if I want to compress a room sound I'll take a mono room mic, put an 1176 across it and push in all the buttons."

Bruce Swedien

Bruce Swedien is a master engineer who needs no introduction. He also is a die-hard 1176 fan. "I have two silverface 1176LNs in my rack that Bill Putnam personally picked out for me," he says. "I remember sitting at Bill's place in the Channel Islands, and talking about the 1176 and how I wanted a pair. The next time we went over he'd picked this pair out and they were sitting in his garage waiting for me. I love them on vocals. All of the Michael Jackson and James Ingram vocals that everyone has heard so much were done with at least one of those 1176s. I couldn't part with them for anything. They sound fabulous."



Thank You

We would like to thank you again for becoming a Universal Audio customer. We urge you subscribe to our email lists so we can keep you informed about UA product developments and promotions. Email preferences are set in your registration profile (see “My Profile” on page 42).

We always like to hear from our customers and welcome your comments and suggestions. If you have any questions you can email us at:

- info@uaudio.com

In case your audio toolbox needs might include hardware such our UA Classics series please be sure to have a look at our web site for more information about the entire UA family of products:

- www.uaudio.com

The Universal Audio Team

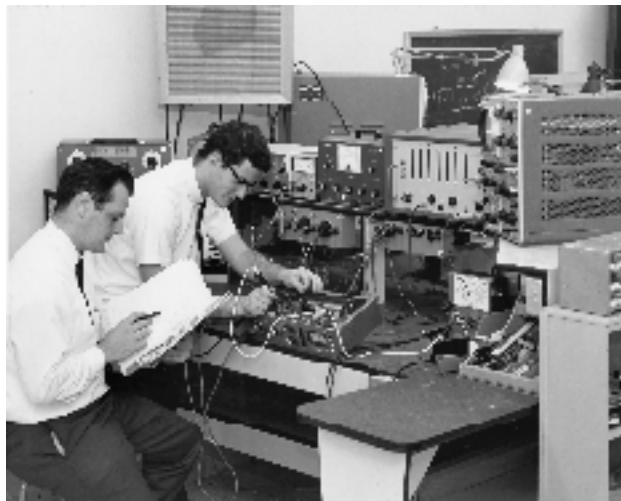

INDEX

Numerics

1176LN 119

A

Accessing Meter Functions 50
Account 41
Adjusting Parameters 73, 77
Always On Top 49
Audio Interface 34
Authorization 22, 35
Authorization File 38
Authorization Notes 39
Authorization Overview 37
Authorize Plug-Ins 38
Authorize Plug-ins button 55
Authorize Plug-Ins Procedure 23
Authorizing Multiple Cards 44
Automation 80
automation 80

B

Buy Button 57, 77
Buying Plug-Ins 42

C

Card Info Display 46
Card Status 54
Circular (jump) 63
Configuration Panel 58
Control Panel 51
Controls View 73
Copy/Paste Settings 75
Current Link Speed 65
Customer Support 14

D

DAW Environment 33
Default Preset Location 74
Default Preset Locations 74
Delay Compensation 86

Demo Activation 40
Demo Mode 40
Demo Notes 40
Desktop 49
Detailed System Profile 55
Disable Current 50
Disabling Cards 46
Disconnect 102
Documentation Overview 11
DSP 51
DSP Load 54
DSP Load Limiting Overview 59
DSP Loading Information 79
DSP LoadLock 60
DSP Settings 70

E

Emagic Logic Audio 72
External MIDI Control 81
Extra Buffering 61

F

Features 10
Feedback 14
Firewire Bandwidth 109
Firewire Bandwidth vs. UAD DSP 111
Firewire Basics 105
Firewire Bus Power 112
Firewire Panel 64
Firewire System 64

H

Hardware Installation 20
Help & Support Panel 69
Help Menu 57, 77
High Resolution 80
History 114
Host Application 33
Host Application Settings 86
Host Compatibility 61

INDEX

Host Computer 33
Host CPU 47
Host CPU Loads 80
Hot Disconnect 102
Hot Swapping 102

I

I/O Buffers and Latency 35
Info Display 64, 69
Install Software First 17, 93, 98
Installation 15
Installer 31
Installing the UAD Hardware 21
Introduction 8

L

LA-2A 118
Latency 53
latency 86
Latency & Delay Compensation 86
Latency Calculator 70
Latest Information 17
Launching a Powered Plug-In 71
Launching a UAD Powered Plug-In 71
Launching the Meter
 Windows 49
Launching the UAD Meter & Control Panel 49
Limit CPU Load 60
Limit DSP Load 60
Linear (slider) 63
Live Processing 89
LiveTrack Mode 75
Load Authorization File 38
Load/Save Preset 74
Logic Audio 72

M

Mac OS 13
Manual Conventions 12
Memory 51

Meter Elements 50
Meter On/Off Button 51
MIDI Control 81
Misc Settings 69
Mixed UAD System 44
Multicard DSP Loading 46
Multiple UAD Cards 44
My Profile 42
My Systems 38
My.uaudio.com 35, 36

N

Note Values 83
Nuendo 71

O

Offline Authorization 24
Online 13
Online Documentation 13
Optional Plug-Ins 31, 36

P

Package Contents 11, 92, 97
 parameter 77
Platforms 13
Plug-In Formats 34
Plug-In License Policy 44
Plug-Ins Panel 55
Power Requirement 45
Powered Plug-Ins 31
Preset/Settings Compatibility 74
Pro Tools Configuration Window 70
Program 51
Purchase Procedure 42
Purchasing Plug-Ins 42

R

ReadMe 11
Reconnect 102
Registration 41

INDEX

Relative Circular (grab) 63
Release all DSP resources on Audio Unit bypass 62
Release all DSP resources on AudioUnit bypass 62
Resource Gauges 50
resources 71

S

Satellite 96
Satellite System Sleep 103
Screen Shots 13
Scroll Wheel 78
Settings Menu 74
Shortcuts 78
Software Installation 18
Software Removal 27
Software Updates 17
Support Website 13
Supported Hosts 16
System 39
System Information Panel 52
System Overview 28
System Requirements 16, 17, 92, 98

T

Target Link Speed 66
Tempo Sync 82
Tempo Sync Modes 85
Tempo Sync Plugins 82
Text Entry 78
Thank You 125
The UAD System 11
Toggle initial value modifier 63
Toolbar 73
Transfer Video 43
Transferring UAD cards and licenses 43

U

UA Online Store 41
UAD 92, 97
UAD Bandwidth Allocation 66

UAD Control Panel 51
UAD Drivers 32
UAD Environment 28
UAD ExpressCard Products 90
UAD Hardware 21, 28
UAD Meter & Control Panel 32, 48
UAD Nomenclature 13
UAD Plug-In Window 72
UAD Software 31
UAD Software Installation 18
UAD Toolbar 73
UAD-2 Family 29
UAD-2 LED 26
UAD-2 Satellite 96
UAD-2 Satellite Notes 103
UAD-2 Satellite Operation 101
UAD-2 SOLO/Laptop 92, 97
UAD-2 SOLO/Laptop Important Notes 95
UAD-Xpander 29
UAD-Xtenda 29, 30
Unlicensed Plug-Ins 27
Upsampled Plug-Ins 87
Upsampling Values Table 88
Use Host Mode 63
User Documentation 32
User Interface Settings 63
Users Forum 14
Using Powered Plug-Ins 48, 71, 86, 101
Using the Meter 49
Using the UAD Meter 49
Using UAD Powered Plug-Ins 71

V

Verifying Installation 26
Video Documentation 13

W

Welcome 8
Windows 13
www 13, 14

INDEX

