

Randall®

A M P L I F I E R S

OLA ENGLUND SIGNATURE

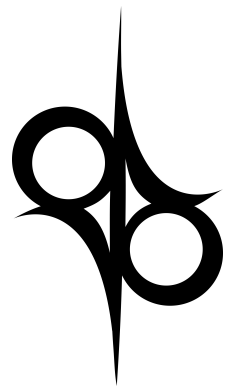

SATAN

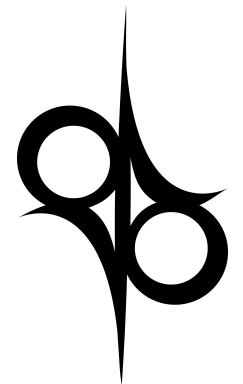

SATAN OPERATION MANUAL





Congratulations on the purchase of your new RANDALL OLA ENGLUND SIGNATURE SERIES Amplifier! We at Randall Amplification appreciate that you chose the SATAN, 120w head Amplifier and wish you years with tons of gain, great tone and enjoyable playing time.

Engineered by world renowned amp guru, Mike Fortin, this amplifier is the result of countless hours of listening tweaking and perfecting the tight and relentless attack that the circuit delivers. The design was developed with Ola to develop a more focused approach to tube amp performance than previously available in the market. Specifically, the 6irth, 6rind and Sweep controls offer more gain and tone flexibility for 7 & 8 string and drop tunings than any amp ever created.

Please review the safety instructions below and be aware that the documentation provided in this manual references 120volt USA versions of the models covered. Note that the POWER listed on the back of the unit should be for your countries' power standard.

Front and Rear Controls

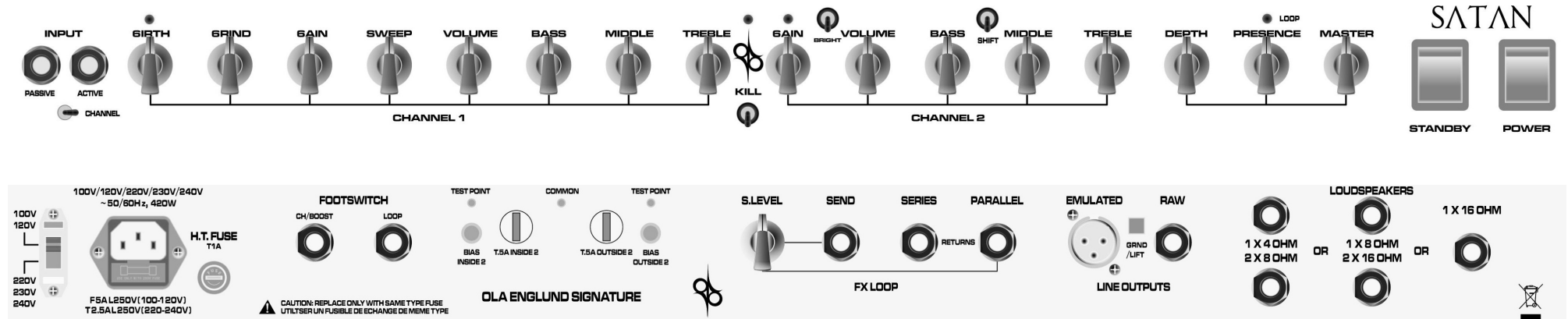



SATAN

Front Panel Controls

INPUT JACKS:
Active input changes the impedance to the first input tube to better match active pickups. Passive input for matching the impedance for passive pickups.

INPUT



PASSIVE ACTIVE

CHANNEL SELECTOR SWITCH:
This switches between channel 1 & channel two - performs same function as first button of footswitch



CHANNEL



CHANNEL 2

GAIN: Overall gain control for clean channel. Use this control along with the volume for ranges from crystal clean to slight break up.

BRIGHT: High frequency boost that becomes less active as GAIN control is increased.

VOLUME: Channel 2 volume control to balance output between channel 1. It affects the SEND level of the FX LOOP.

BASS: Passive interactive low frequency equalization for channel 2.

MIDDLE: Passive interactive midrange frequency equalization for channel 2.

TREBLE: Passive interactive high frequency equalization for channel 2.

SHIFT: 3 way switch that changes the voicing of the clean

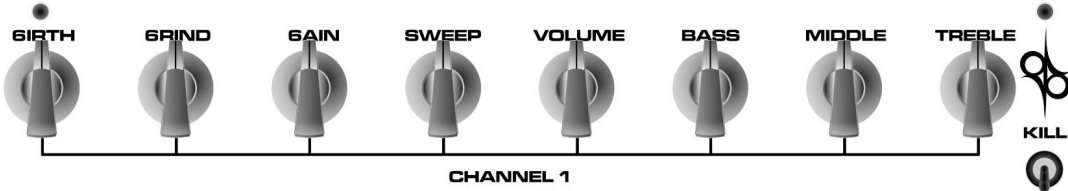

CHANNEL 1

6IRTH: Frequency selective gain control for bass

6RIND: Frequency selective gain control for treble

6AIN: Overall gain control with the sum of the LF and HF gains

SWEEP: Changes the frequency points of the tone stack creating shift in tonal character.

VOLUME: Channel 1 volume control to balance output between channel 2. It affects the send level of the FX LOOP. Proper channel 1 volume setting to start to the 3 o'clock position.

BASS: Passive interactive low frequency equalization for channel 1.

MIDDLE: Passive interactive midrange frequency equalization for channel 1.

TREBLE: Passive interactive high frequency equalization for channel 1.

KILL: Preset upper mids gain boost for channel 1. Full frequency boost for channel 2. Function is engaged via KILL switch or footswitch jack CH/BOOST activating KILL LED.

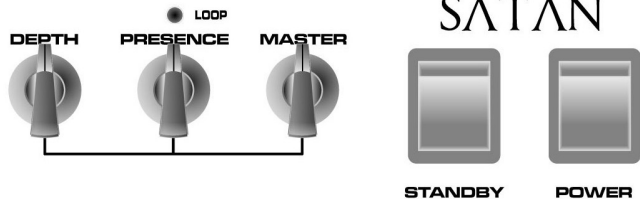

SATAN

DEPTH: Power amp control of low frequency interaction between amplifier and speakers.

PRESENCE: Power amp control of high frequency variable feedback.

MASTER: Controls the overall output of the amplifier post EQ

STANDBY: Breaks the output tubes cathodes only. Speaker Emulated output still functions in STANDBY.

POWER: On/off for the mains.

Rear Panel Controls

100V/120V/220V/230V/240V
~ 50/60Hz, 420W

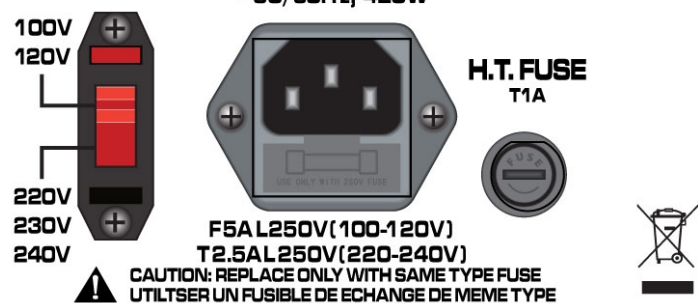

H.T. FUSE T1A

F5A L250V (100-120V)
T2.5A L250V (220-240V)

CAUTION: REPLACE ONLY WITH SAME TYPE FUSE
UTILISER UN FUSIBLE DE ECHANGE DE MEME TYPE

MAINS SWITCH: Selects the country voltage.
For 100-120VAC selections, change IEC fuse to T5A/250V fuse.
For 220-240VAC selections, change IEC fuse to T2.5A/250V fuse.
The H.T. Fuse remains unchanged.

MAINS INPUT: AC wall power via included IEC cord to a grounded outlet

HT FUSE: Protection for AC power faults.

FOOTSWITCH

CH/BOOST LOOP



CH/BOOST(KILL): TRS switching jack for footswitch, Tip to ground switching type. Tip=Channel and Ring=Boost select. (2 button LED footswitch included)

LOOP: 1/4" tip to ground switching jack to bypass loop via external switching unit or footswitch (not included)

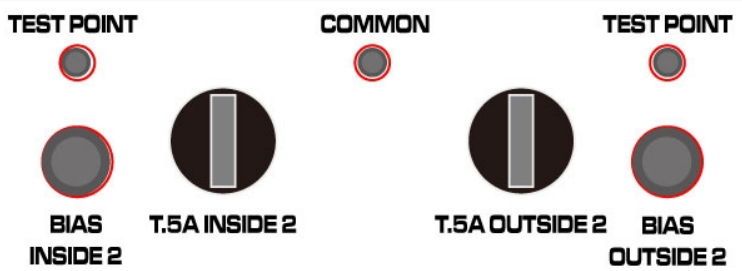

TEST POINT & BIAS:
Using a Digital Multi Meter, set it to DC mV(olts) and insert the black probe into the COMMON meter jacks and the red probe into either TEST POINT meter jack.
Set MASTER volume fully counter clockwise and take the amp off STANDBY, measure and set BIAS INSIDE 2 or BIAS OUTSIDE 2 located below the test points. Adjust the bias pots slowly.

Please note that the reading is the sum of 2 power tubes.

Amps ships stock with (2) 6L6 & (2) KT88
Factory settings for tubes at either TEST POINT is:
6L6=68mV & 6550/KT88 = 90mV.

T.5A FUSES: Fusing for the two inside pair and two outside pair of output tubes. In case of output tube failure, only the problem pair of tubes will drop out of circuit leaving you to finish your gig!

Rear Panel Controls

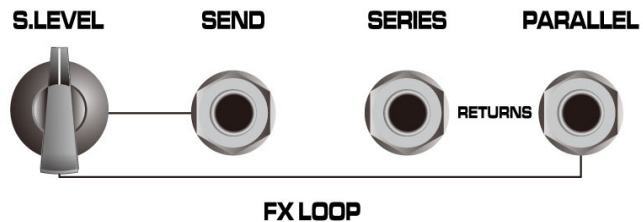

FX LOOP:

SERIES Operation:

The SEND jack plugs into the effects unit's input jack. The SERIES RETURN jack plugs into the effects unit's output jack. The audio path of the amplifier is interrupted and 100% of the signal is being sent to the SEND jack. The S.LEVEL control is used to adjust the amount of signal being sent to an effects unit. With stomp box pedals there are usually no input level indicators. In this case you will have to use your ears to set the S.LEVEL. Set the S.LEVEL up to the maximum setting just before you start to hear the undesirable front end clipping of your effects pedal. This setting of the S.LEVEL will usually be quite low for pedals. Setting the S.LEVEL for rack units is easier since they have input indicators.

PARALLEL Operation:

Your original, dry tone is unaffected allowing you to mix in the amount of effects. The SEND jack plugs into the effects unit's input jack. The PARALLEL RETURN jack plugs into the effects unit's output jack. The S.LEVEL control is used to adjust the amount of signal being sent to an effects unit. With stomp box pedals there are usually no input level indicators. In this case, again, you will have to use your ears to set the S.LEVEL. Set the S.LEVEL up to the maximum setting just before you start to hear the undesirable front end clipping of your effects pedal. This setting of the S.LEVEL will usually be quite low for pedals. Setting the S.LEVEL for rack units is easier since they have input indicators.

NOTE: When using effect units in the FX LOOP in PARALLEL mode, you must set the effects unit's mix control to 100%. By not doing so will cause phasing issues. Using the FX LOOP in SERIES mode will send 100% of the amp's signal out of the SEND jack. Please use caution as to the quality of the effects unit you want to put your entire tone through. This is a non "tone sucking" loop. If transparency is not achieved, then it is most likely caused by improper setting or application of the FX LOOP.

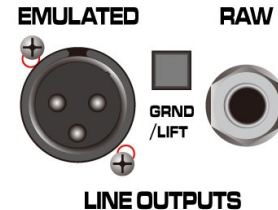

RAW: Unfiltered raw signal tapped off the loudspeakers jacks while amp is in operation mode (*off standby with speaker load attached*) This output can be fed to the slave input/power amp in/Effects loop return of another guitar amp or into the input of a power amp.

EMULATED: Transformer isolated Emulation of a Randall speaker 4x12 cabinet. Prefixed output is dependent on the channel volumes and is post fx loop and functions regardless of standby switch position.

GROUND LIFT: Lifts pin 1 on the EMULATED OUTPUT for ground loop issues while interfacing with external equipment such as mixers, recording interfaces or monitors.



LOUDSPEAKERS:

Parallel wired speaker jacks:

1x4 OHM - connect one 4 ohm speaker cabinets here

2x8 OHM - connect two 8 ohm speaker cabinets here

1x8 OHM - connect one 8 ohm speaker cabinets here

2x16 OHM - connect two 16 ohm speaker cabinets here

1x16 OHM - connect one 16 ohm speaker cabinets here

DO NOT CONNECT MORE SPEAKERS THAN SHOWN ABOVE

SATAN

Randall Warranty

Randall Amplifiers, a Division of U.S. Music Corporation warrants the product you have purchased to be free of defects in materials and workmanship in normal use for a period of two (2) years from the date of original purchase. This warranty shall run to the original purchaser when purchased from an Authorized Randall Dealer. The manufacturer warrants speakers for a period of (1) years. The manufacturer warrants tubes for a period of (90) days. Defective parts found during the applicable warranty period with proof of purchase will be replaced or repaired without charge if the complete product is returned to US Music Corp or any Authorized Randall Service Center within the U.S.A. Randall reserves the right to use materials readily available at the time of the repair. All Warranty service requires Proof of Purchase (sales receipt) to be presented at time of service request. Any repair or service performed by any person of entity other than an Authorized Service Center is not covered by this limited warranty. The customer pays transportation to and from Randall factory service or any Randall Authorized Service Center. Rental stock is warranted for (1) year from date of invoice to the Authorized dealer. Warranty on rental units is not transferable.

What is covered against manufacturing defects: Parts and Labor to correct any defect in materials used and any defect attributable to workmanship.

What is not covered:

Shipping Damage. Report damage upon receipt of item to the carrier (i.e. UPS). Freight carrier must be notified upon receipt of items to insure freight damage claim resolution. Shipping damage not filed with carriers within (48) hrs upon receipt will not be covered under warranty. Report any shipping damage within (48) hrs of receipt to the Randall Customer Service Dept at 1-847-949-0444, ext. 5120. Keep all original documents and packing materials to insure freight damage claim resolution. Merchandise that has been modified after original shipment from the Randall factory. Products whose serial numbers have been altered or removed. Exterior normal wear and tear damage to the finish due to misuse, operation outside the specified ratings, neglect or accident. Warranty claims by anyone other than the original purchaser. Randall is not responsible for any items left in protective covers or cases, (We strongly advise that all personal items such as chords, cables, tuners, etc... be removed!) freight charges to and from the factory or an Authorized service center on customer owned goods, any and all charges incurred from priority service requests (Rush Service) or priority shipping for replacement parts. Any and all charges if no problem is found.

Return Authorization

All items being returned for any reason must have a Return Authorization number. This RA# must be placed on the outside of the carton of the item being returned or the carton will be refused upon delivery. Please call the customer service department at 1-800-877-6863, ext. 5120, for the return authorization number. Dealer stock items will be returned to the dealer freight prepaid.

An Authorized Warranty Service Center must perform any and all field warranty service work. Customer will not pay for parts and/or labor provided the problem found is within warranty guidelines. Proof of purchase must be provided at the time of service request. Transportation charges to and from the Authorized Warranty Service Center are the responsibility of the customer. Rush service charges and special freight charges for required parts are not covered under warranty and are also the responsibility of the customer. If a unit is not easily transported to an authorized service center, the customer is responsible for technician travel charges. Any charges for labor or processing when no problem is found are also not covered under warranty. Any charges incurred for work performed by an unauthorized service center are the responsibility of the customer.

Warranty terms may vary per country, check warranty terms with local Distributor or at point of purchase.

IMPORTANT SAFETY INSTRUCTIONS

1. Read these instructions.
2. Keep these instructions.
3. Heed all warnings.
4. Follow all instructions.
5. Do not use this apparatus near water.
6. Clean only with a dry cloth.
7. Do not block any ventilation openings. Install in accordance with the manufacturer's instructions.
8. Do not install near any heat sources such as radiators, heat registers, stoves, or other apparatus (including amplifiers) that produce heat.
9. Do not defeat the safety purpose of the polarized or grounding- type plug. A polarized plug has two blades with one wider than the other. A grounding type plug has two blades and a third grounding prong. The wide blade or the third prong are provided for your safety. If the provided plug does not fit into your outlet, consult an electrician for replacement of the obsolete outlet.
10. Protect the power cord from being walked on or pinched particularly at plugs, convenience receptacles, and the point where they exit from the apparatus.
11. Only use attachments/accessories specified by the manufacturer.
12. Use only with a cart, stand, tripod, bracket, or other unit specified by the manufacturer, or sold with the apparatus. When a cart is used, use caution when moving the cart/apparatus combination to avoid injury from tip-over.
13. Unplug this apparatus during lightning storms or when unused for long periods of time.
14. Refer all servicing to qualified service personnel. Servicing is required when the apparatus has been damaged in anyway, such as power-supply cord or plug is damaged, liquid has been spilled or objects have fallen into the apparatus, the apparatus has been exposed to rain or moisture, does not operate normally, or has been dropped.



Portable Cart Warning

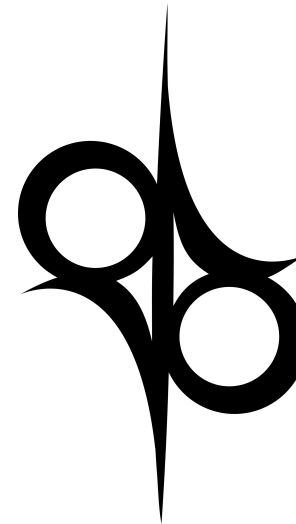

For detailed product videos please visit our website at :www.randallamplification.com

Randall Amplifiers is a Division of U.S. Music Corp.
1000 Corporate Grove Drive • Buffalo Grove, IL 60089
Tel: (800) 877-6863 • Fax: (847) 949-8444

