

GXD Amplifier



Quick Start Guide

EXPLANATION OF TERMS AND SYMBOLS

The term "**WARNING!**" indicates instructions regarding personal safety. If the instructions are not followed the result may be bodily injury or death.

The term "**CAUTION!**" indicates instructions regarding possible damage to physical equipment. If these instructions are not followed, it may result in damage to the equipment that may not be covered under the warranty.

The term "**IMPORTANT!**" indicates instructions or information that are vital to the successful completion of the procedure.

The term "**NOTE**" is used to indicate additional useful information.



The intent of the lightning flash with arrowhead symbol in a triangle is to alert the user to the presence of un-insulated "dangerous" voltage within the product's enclosure that may be of sufficient magnitude to constitute a risk of electric shock to humans.



The intent of the exclamation point within an equilateral triangle is to alert the user to the presence of important safety, and operating and maintenance instructions in this manual.



NOTE: This Quick Start Guide is based on the basic configuration as the amplifier comes from the factory. For detailed instructions for custom configurations refer to the GXD User Guide.

Rack-Mount the Amplifier

1. Secure the amplifier in the rack with eight screws (not supplied), four in front, four in back.

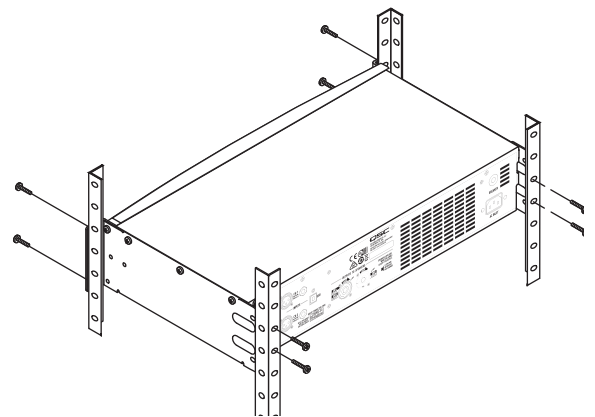

– Figure 1 –



Connections

Inputs (Channels 1 & 2)

Input Impedance: 40 kΩ Balanced, 20 kΩ Unbalanced
(Figure 2) See Table 1 for wiring

	POS	NEG	GROUND
XLR	2	3	1
1/4"	TIP	RING	SLEEVE

– Table 1 –

1. XLR female
2. 1/4" female TRS Phone Jack
3. USB Standard B connector - Used for updating the amplifier firmware.

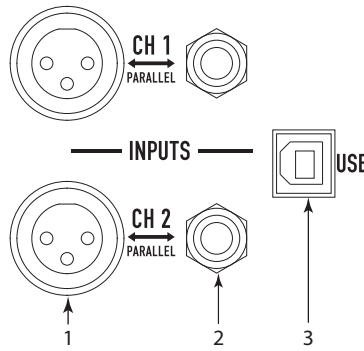

– Figure 2 –

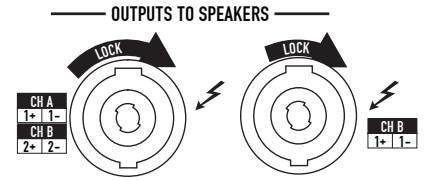

– Figure 3 –

Outputs (Channels A & B)

4Ω or 8Ω impedance (Figure 3)

1. NL4 – Do not combine the audio outputs in any way. Do not connect the audio outputs to ground.

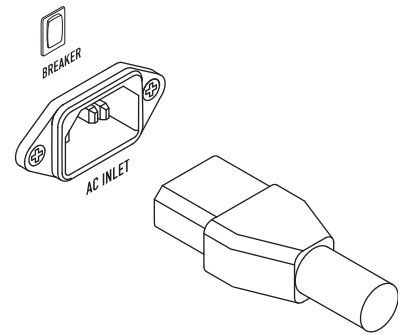

– Figure 4 –

AC Power

- A. Connect the IEC power cord to the AC receptacle on the rear of the amplifier. (Figure 4)

Controls

See Figure 5.

1. Channel A clip indicator
2. Channel A signal presence indicator
3. Power Switch/LED on/off
4. Adjust Channel A gain
5. Home – go to Home screen / view Preset screen
6. Enter – select highlighted item and/or confirm parameter change
7. Exit – return to previous screen and/or undo parameter change
8. Adjust Channel B gain, select and adjust controls
9. Channel B signal presence indicator
10. Channel B clip indicator

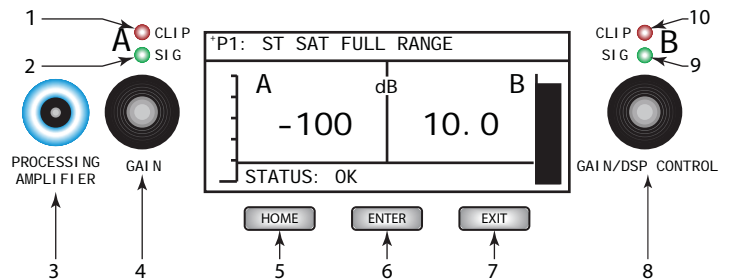

– Figure 5 –

GXD Amplifier Signal Flow

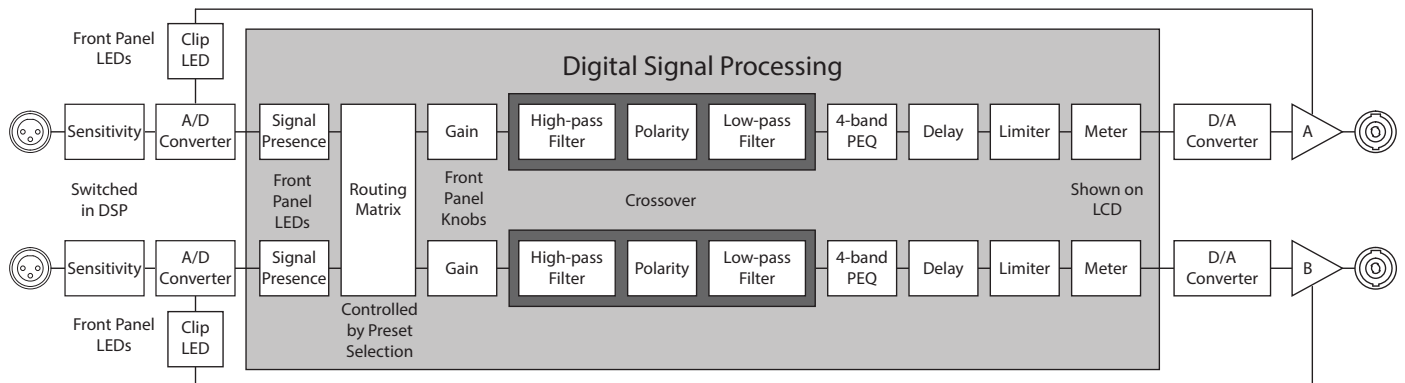

– Figure 6 –

Setup and Operation

Menu Tree

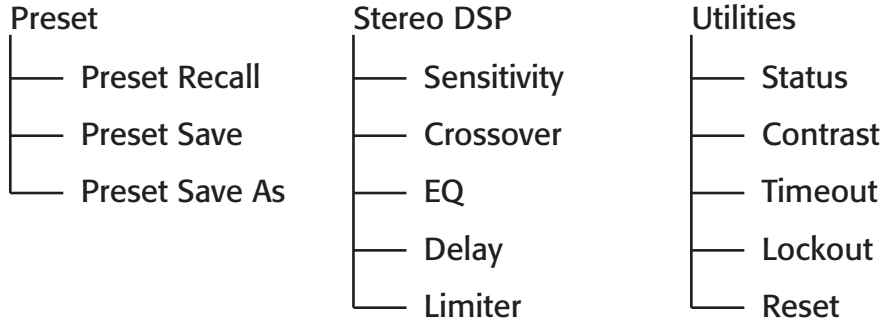

– Figure 7 –

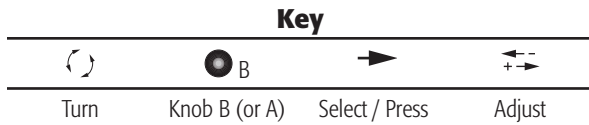

Home Screen

See Figure 8

From any screen → HOME

1. Currently active Preset (location and name)
2. Limit and Clip indicators
3. Output channel letter A and B
4. Output meter A and B (visual)
5. Output Gain (digital) Range = -100 to +10 dB
6. Amplifier Status

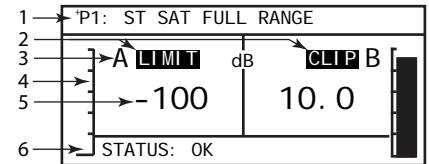

– Figure 8 –

Configurations

There are four basic types of configuration:

- 2-channels in, stereo DSP, 2-channels out (P1 through P7) **Figure 31**
- 2-channels in, separate DSP, 2-channels out (P8 through P10) **Figure 32**
- 1 or 2-channel in, separate DSP, 2-channels out (P11 through P18) **Figure 33**
- 1 or 2-channel in, stereo DSP, 2-channels out (P19 and P20) **Figure 34**

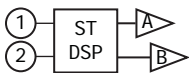

– Figure 9 –

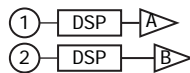

– Figure 10 –

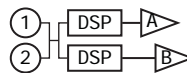

– Figure 11 –

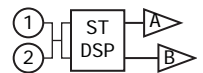

– Figure 12 –

The configurations are selected using the Presets. Refer to the GXD User Manual for details on all 20 available Configurations.

Presets

A preset configures the inputs and outputs, along with setting the DSP.

There are 20 Presets. See Figure 9.









From Home → 

1. Previous selection
2. Currently selected
3. Next selection
4. Instructions

Recall a Preset







Recall a preset to configure the amplifier to meet the requirements of your loudspeakers and installation.

There are 20 Presets. See Figure 10.

1. From Home → 
2.  ● B → Preset, → 
3.  ● B → Preset Recall, → 
4.  ● B → the preset you want, →  

Save Preset

















Saves the active preset with any DSP changes. See Figure 11.

1. From Home 
2.  ● B → Preset, → 
3.  ● B → Preset Save, →  

Save Preset As

Select the Location and/or change the Name to save changes you make to the DSP.

See Figure 12 and Figure 13.







1. From Home 
2.  ● B → Preset, → 
3.  ● B → Preset Save As, → 
4.  ● B → Location → 
5.  ● B → the Location (p1 to p20), → 
6.  ● B → Name, → 
7.  ● B → letter, number, hyphen, or space →  repeat. When finished → 
8.  ● B → Save, →  

Stereo DSP (Digital Signal Processing)

The DSP is set for both channels equally, at the same time. Any changes you make are made in real time – you hear the change as it is being made.

Sensitivity

See Figure 15 through Figure 17.

1. From Home → 
2.  ● B → STEREO DSP, → 
3.  ● B → Sensitivity, → 
4.  ● B → 1.2 V (+4 dBu) or 3.9 V (+14 dBu), → 

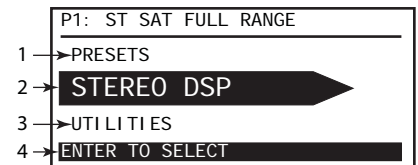

– Figure 13 –

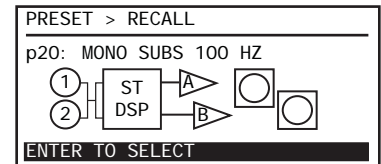

– Figure 14 –

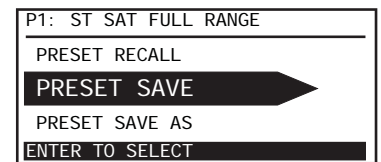

– Figure 15 –

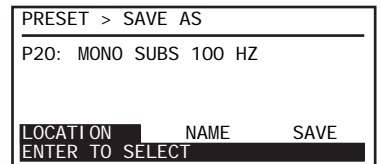

– Figure 16 –

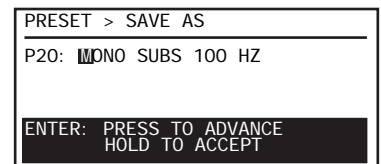

– Figure 17 –

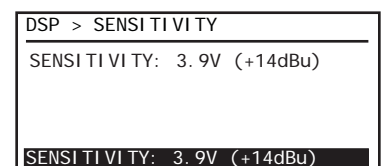

– Figure 18 –

Crossover and Polarity

See Figure 15 through Figure 17.

1. From Home → **ENTER**
2. **B** → STEREO DSP, → **ENTER**
3. **B** → Crossover, → **ENTER**
4. **B** → HPF, → **ENTER**
5. **B** ↔ Frequency (Bypass, 20 Hz to 4 kHz), → **ENTER**
6. **B** → LPF, → **ENTER**
7. **B** ↔ Frequency (Bypass, 59.8 Hz to 4 kHz), → **ENTER**
8. **B** → POL, → **ENTER**
9. **B** → positive (+) or negative (-), → **ENTER** **HOME**

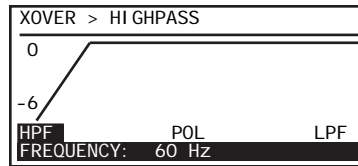

– Figure 19 –

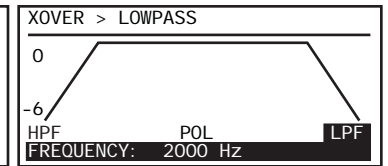

– Figure 20 –

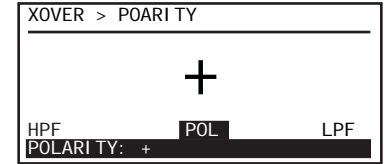

– Figure 21 –

EQ

See Figure 18 through Figure 20.

1. From Home → **ENTER**
2. **B** → STEREO DSP → **ENTER**
3. **B** → EQ → **ENTER**
4. **B** → Band 1, 2, 3, or 4 → **ENTER**
5. **B** → Gain, → **ENTER**
6. **B** ↔ Gain (-12 dB to +12 dB), → **ENTER**
7. **B** → Frequency, → **ENTER**
8. **B** ↔ Frequency (20 Hz to 20 kHz), → **ENTER**
9. **B** → BW (bandwidth), → **ENTER**
10. **B** ↔ BW (0.1 Octave to 3.0 Octave), → **ENTER** **HOME**

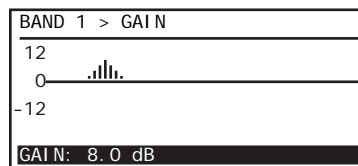

– Figure 22 –

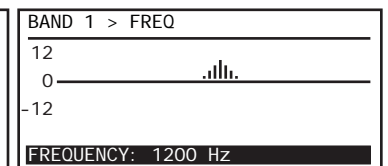

– Figure 23 –

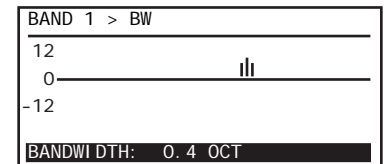

– Figure 24 –

Delay

See Figure 21

1. From Home **ENTER** from the Home screen.
2. **B** → STEREO DSP, press **ENTER**
3. **B** → Delay, → **ENTER**
4. **B** ↔ Delay (0.00 to 56.30 ft, or 17.16 m, or 50 ms), → **ENTER** **HOME**

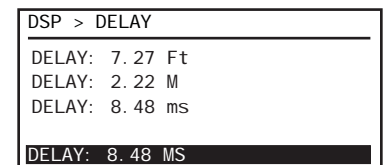

– Figure 25 –

Limiter

See Figure 22

1. From Home → **ENTER**
2. **B** → STEREO DSP, → **ENTER**
3. **B** → Limiter, → **ENTER**
4. **B** → Type, → **ENTER**
5. **B** → Mild, Medium, or Aggressive → **ENTER**
6. **B** → Power, → **ENTER**
7. **B** ↔ Power (see Table 2), → **ENTER**
8. **B** → Impedance (4 or 8 Ohms), → **ENTER** **HOME**

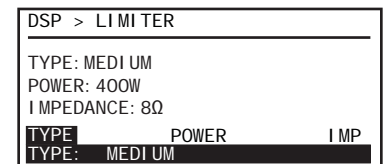

– Figure 26 –

Model	4Ω	8Ω
GXD4	5 W – 600 W	5 W – 400 W
GXD8	5 W – 1200 W	5 W – 800 W

– Table 2 –

Utilities

Status

See Figure 23

1. From Home, → **ENTER**
2. () ● B → Utilities, → **ENTER**
3. () ● B → Status → **ENTER**
 - a. Amp Total Run Time - Hours (HH:MM:SS)
 - b. Hardware - the version of the hardware unit
 - c. Firmware - the version of the firmware installed on the amplifier
4. When finished, → **HOME**

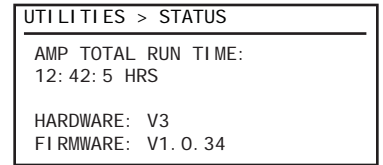

– Figure 27 –

Contrast

See Figure 24

1. From Home, → **ENTER**
2. () ● B → Utilities, → **ENTER**
3. () ● B → Contrast → **ENTER**
4. () ● B ↔ Contrast (0 to 10) → **ENTER** **HOME**

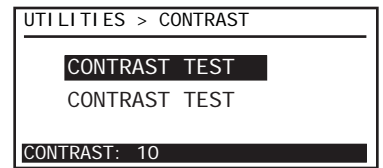

– Figure 28 –

Timeout

See Figure 25

1. From Home, → **ENTER**
2. () ● B → Utilities, → **ENTER**
3. () ● B → Timeout → **ENTER**
4. () ● B ↔ Timeout (NEVER, 30 Seconds, 1 Minute, or 5 Minute) → **ENTER** **HOME**

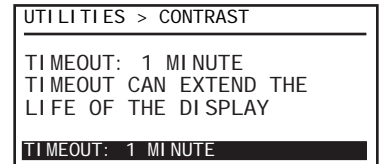

– Figure 29 –

Lockout

See Figure 26 through Figure 28

1. From Home, → **ENTER**
2. () ● B → Utilities, → **ENTER**
3. () ● B → Lockout → **ENTER**
4. () ● B → Unlock, Lock Processing, or Lock All → **ENTER**
5. () ● B → Unlock, Lock Processing, or Lock All → **ENTER** **HOME**

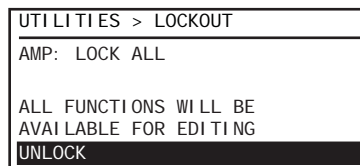

– Figure 30 –

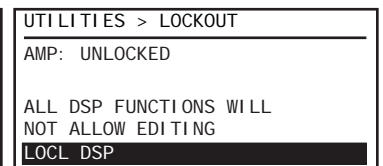

– Figure 31 –

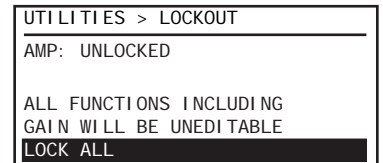

– Figure 32 –

Reset

1. From Home, → **ENTER**
2. () ● B → Utilities, → **ENTER**
3. () ● B → Reset → **ENTER**
4. () ● B → Factory Reset → **ENTER** → **ENTER**

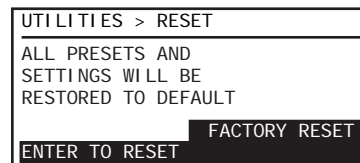

– Figure 33 –

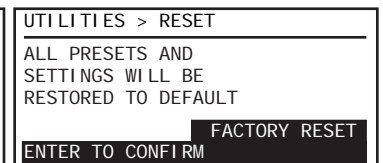

– Figure 34 –



Mailing Address:

QSC Audio Products, LLC
1675 MacArthur Boulevard
Costa Mesa, CA 92626-1468 USA

Telephone Numbers:

Main Number: (714) 754-6175
Sales & Marketing: (714) 957-7100 or toll free (USA only) (800) 854-4079
Customer Service: (714) 957-7150 or toll free (USA only) (800) 772-2834

Facsimile Numbers:

Sales & Marketing FAX: (714) 754-6174
Customer Service FAX: (714) 754-6173

World Wide Web:

www.qsc.com

E-mail:

info@qsc.com
service@qsc.com
tech_support@qsc.com

If you would like a full copy of the GXD User manual, visit the QSC Audio Products website at www.qsc.com, or contact Customer Service +1 714 957-7150 or toll free (USA only) (800) 772-2834 to receive a copy by mail.

Si desea obtener una copia completa del manual del usuario de la GXD, visite el sitio web de QSC Audio Products en www.qsc.com, o póngase en contacto con el Servicio al Cliente al +1 714 957-7150 o sin costo (sólo en EE.UU.) al (800) 772-2834 para recibir una copia por correo.

Pour obtenir un exemplaire complet du manuel d'utilisation de la GXD, allez sur le site Web QSC Audio Products à www.qsc.com ou contactez le service clientèle au +1 714 957-7150 ou au (800) 772-2834 (numéro vert - USA seulement) pour recevoir un exemplaire par courrier.

Ein vollständiges Exemplar des Benutzerhandbuchs für die GXD finden Sie auf der QSC Audio Products-Website unter www.qsc.com. Sie können sich unter +1 714 957-7150 oder unter der (nur in den USA) gebührenfreien Nummer +1 (800) 772-2834 auch an den Kundendienst wenden, um sich ein Exemplar zuschicken zu lassen.

如果您需要 GXD 产品用户手册的完整副本，请访问 QSC 音频产品网站 www.qsc.com，或致电客户服务部门 +1 714 957-7150，或拨打免费电话（仅限美国）(800) 772-2834 通过邮件获取副本。