



MFC *Version 2.0*
MUSIC PRODUCTION CENTER
10000

AKAI
professional



Operator's Manual

WARNING

To prevent fire or shock hazard,
do not expose this appliance to
rain or moisture.

Important Notice

The material in this document is copyright to AKAI professional M.I. Corp., and may not be quoted or reproduced in any form without written permission from the company.

LIMITED SOFTWARE WARRANTY POLICY

All the software provided with, or purchased especially for, AKAI professional products has been tested for functionality. AKAI professional M.I. Corp. will make its best efforts to correct reported software defects for future releases subject to technical practicabilities.

AKAI professional M.I. Corp. makes no warranty or representation either expressed or implied with respect to the system's performance or fitness for a particular purpose.

In no event will AKAI professional M.I. Corp. be liable for direct or indirect damages arising from any defect in the software or its documentation. Further, AKAI professional M.I. Corp. will not accept any liability for any programs, sounds, audio recording or sequences stored in or used with AKAI professional products, including the cost of recovery of such data.

The warranties, remedies and disclaimers above are exclusive and take precedence over all others, oral or written, express or implied, to the extent permitted by law in the geographical area of the product's use. No employee of AKAI professional M.I. Corp., agent, distributor or employee of an agent or distributor is authorised to offer any variation from this policy.

WARNING!!

To prevent fire or shock hazard, do not expose this appliance to rain or moisture.

1-En

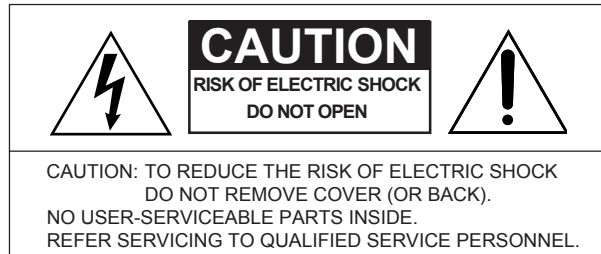

THE SYMBOLS ARE RULED BY UL STANDARDS (U.S.A.)

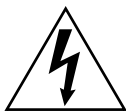

The lightning flash with arrowhead symbol, within an equilateral triangle, is intended to alert the user to the presence of uninsulated "dangerous voltage" within the product's enclosure; that may be of sufficient magnitude to constitute a risk of electric shock to persons.



The exclamation point within an equilateral triangle is intended to alert the user to the presence of important operating and maintenance (servicing) instructions in the literature accompanying the appliance.

5B-En

Caution - use of controls or adjustments or performance of procedures other than those specified herein may result in hazardous radiation exposure.

This appliance is not equipped with a fully disconnect main power switch. Even when the appliance is turned off, the power supply to the appliance is not completely turned off when the power cord is plugged in. Pull out the power cord when not using the appliance for long periods.

WARNING: WHEN USING ELECTRIC PRODUCTS, BASIC PRECAUTIONS SHOULD ALWAYS BE FOLLOWED, INCLUDING THE FOLLOWING:

WARNING

The MPC1000 is designed to be used in a standard household environment.

Power requirements for electrical equipment vary from area to area. Please ensure that your MPC1000 meets the power requirements in your area. If in doubt, consult a qualified electrician or AKAI professional dealer.

120 VAC	@ 60 Hz for USA and Canada
220~240 VAC	@ 50 Hz for Europe
240 VAC	@ 50 Hz for Australia

IMPORTANT SAFETY INSTRUCTIONS

1. Read these instructions.
2. Keep these instructions.
3. Heed all warnings.
4. Follow all instructions.
5. Do not use this apparatus near water.
6. Clean only with dry cloth.
7. Do not block any ventilation openings. Install in accordance with the manufacture's instructions.
8. Do not install near any heat sources such as radiators, heat register, stoves, or other apparatus (including amplifiers) that produce heat.
9. Do not defeat the safety purpose of the polarized or grounding-type plug. A polarized plug has two blades with one wider than the other. A grounding type plug has two blades and a third grounding prong. The wide blade or the third prong are provided for your safety. If the provided plug does not fit into your outlet, consult an electrician for replacement of the obsolete outlet.
10. Protect the power cord from being walked on or pinched particularly at plugs, convenience receptacles, and the point where they exit from the apparatus.
11. Only use attachments/accessories specified by the manufacturer.
12. Use only with the cart, stand, tripod, bracket, or table specified by the manufacturer, or sold with the apparatus. When a cart is used, use caution when moving the cart/apparatus combination to avoid injury from tip-over.

PORTABLE CART WARNING



S3125A

13. Unplug this apparatus during lightning storms or when unused for long periods of time.
14. Refer all servicing to qualified service personnel. Servicing is required when the apparatus has been damaged in any way, such as power-supply cord or plug is damaged, liquid has been spilled or objects have fallen into the apparatus, the apparatus has been exposed to rain or moisture, does not operate normally, or has been dropped.
15. Do not expose this apparatus to dripping or splashing and ensure that no objects filled with liquids, such as vases, are placed on the apparatus.

For U.K. customers only

WARNING
THIS APPARATUS MUST BE EARTHED
IMPORTANT

This equipment is fitted with an approved non-rewireable UK mains plug.

To change the fuse in this type of plug proceed as follows:

- 1) Remove the fuse cover and old fuse.
- 2) Fit a new fuse which should be a BS1362 5 Amp A.S.T.A or BSI approved type.
- 3) Refit the fuse cover.

If the AC mains plug fitted to the lead supplied with this equipment is not suitable for your type of AC outlet sockets, it should be changed to an AC mains lead, complete with moulded plug, to the appropriate type. If this is not possible, the plug should be cut off and a correct one fitted to suit the AC outlet. This should be fused at 5 Amps.

If a plug without a fuse is used, the fuse at the distribution board should NOT BE GREATER than 5 Amp.

PLEASE NOTE: THE SEVERED PLUG MUST BE DESTROYED TO AVOID A POSSIBLE SHOCK HAZARD SHOULD IT BE INSERTED INTO A 13 AMP SOCKET ELSEWHERE.

The wires in this mains lead are coloured in accordance with the following code:

GREEN and YELLOW	— Earth
BLUE	— Neutral
BROWN	— Live

As the colours of the wires in the mains lead of this apparatus may not correspond with the coloured markings identifying the terminals in your plug, please proceed as follows:

The wire which is coloured **GREEN** and **YELLOW** must be connected to the terminal which is marked with the letter **E** or with the safety earth symbol \perp or coloured **GREEN** or coloured **GREEN** and **YELLOW**.

The wire which is coloured **BLUE** must be connected to the terminal which is marked with the letter **N** or coloured **BLACK**.

The wire which is coloured **BROWN** must be connected to the terminal which is marked with the letter **L** or coloured **RED**.

THIS APPARATUS MUST BE EARTHED

Ensure that all the terminals are securely tightened and no loose strands of wire exist.

Before replacing the plug cover, make certain the cord grip is clamped over the outer sheath of the lead and not simply over the wires.

FCC WARNING

This equipment has been tested and found to comply with the limits for a Class B digital device pursuant to Part 15 of the FCC rules. These limits are designed to provide reasonable protection against harmful interference in a residential installation. This equipment generates, uses, and can radiate radio frequency energy and, if not installed and used in accordance with the instructions, may cause harmful interference to radio communications. However, there is no guarantee that interference will not occur in a particular installation. If this equipment does cause harmful interference to radio or television reception, which can be determined by turning the equipment off and on, the user is encouraged to try to correct the interference by one or more of the following measures:

- Reorient or relocate the receiving antenna.
- Increase the separation between the equipment and receiver.
- Connect the equipment into an outlet on a circuit different from that to which the receiver is connected.
- Consult the dealer or an experienced radio/TV technician for help.

21B-En

AVIS POUR LES ACHETEURS CANADIENS DU MPC1000

Le présent appareil numérique n'émet pas de bruits radioélectriques dépassant les limites applicables aux appareils numériques de la Class B prescrites dans le Règlement sur le brouillage radioélectrique édicté par le ministère des Communications du Canada.

27-F

This digital apparatus does not exceed the Class B limits for radio noise emissions from digital apparatus set out in the Radio Interference Regulations of the Canadian Department of Communications.

27-En

VENTILATION

Do not prevent the unit's ventilation, especially by placing the unit on soft carpet, in a narrow space, or by placing objects on the unit's chassis—top, side, or rear panels. Always keep the unit's chassis at least 10 centimeters from any other objects.

31C-En

CHANGES OR MODIFICATIONS NOT EXPRESSLY APPROVED BY THE MANUFACTURER FOR COMPLIANCE COULD VOID THE USER'S AUTHORITY TO OPERATE THE EQUIPMENT.

32-En

COPYRIGHT NOTICE

The AKAI professional MPC1000 is a computer-based device, and as such contains and uses software in ROMs. This software, and all related documentation, including this Operator's Manual, contain proprietary information which is protected by copyright laws. All rights are reserved. No part of the software or its documentation may be copied, transferred or modified. You may not modify, adapt, translate, lease, distribute, resell for profit or create derivative works based on the software and its related documentation or any part thereof without prior written consent from AKAI professional M.I. Corp., Yokohama, Japan.

Table of contents

Chapter 1: Introduction	2
Overview	2
Top panel	2
Front Panel	4
Rear Panel	4
Connecting MPC1000 to External Audio / MIDI device	5
Terminologies in MPC1000	6
Chapter 2: Basic Operation	9
Setting names	10
Entering number with Numeric key	11
Chapter 3: Sequencer feature	12
Recording the performance	13
Playing back a sequence	14
Other useful features for recording sequences	14
Detailed information on sequence feature	18
Track feature	21
MIDI sequencer feature	24
Chapter 4: Editing sequences	26
Selecting a region within a track to edit	26
Selecting the editing region by bar	29
Changing the order of tracks (TRACK MOVE)	30
Chapter 5: Step editing	31
About step edit	31
Screens	31
Events	32
Copying / Pasting an event	35
Moving an event	35
Deleting an event	35
Entering an event(Step recording)	36

Chapter 6: Song mode **37**

Structure of a song	37
Screens	37
Creating a song	38
Playing a song	38
Other features in the SONG	39

Chapter 7: Functions of a Pad **41**

Playing with pads	41
Setting the track mute with pads	42
Selecting a sequence to play with pads	43

Chapter 8: Q-Link slider **44**

Setting the slider	44
Recording the slider value in a sequence	45
AFTER key	45
Other features Q-Link slider	46

Chapter 9: Using the MPC1000 with External devices **47**

Sync with the MPC1000 as the master	47
Sync with the MPC1000 as the slave	47
Connecting the MPC1000 to the MIDI keyboard with the sound module	48
Setting the MIDI input	48
Cutting off the internal sound from a pad (Setting Local Control)	49
Changing sequence by Program Change from an external devices	49

Chapter 10: Recording a sample **50**

Recording the sample - detailed information -	51
Recording the digital signal	51
Recording the MAIN OUT	51
Other features	52

Chapter 11: Editing a sample 53

Setting the start / end points for the samples	53
Deleting an unnecessary part from a sample (DISCARD)	54
Deleting a selected range from sample and moving the data after the end point towards the start point (DELETE)	54
Silencing a range selected from a sample(SILENCE)	55
Saving part of a sample as a new sample (EXTRACT)	55
Sample widow feaures	55
Other editing functions	56
Dividing a phrase sample to several regions	59
Dividing a sample into regions of equal length.....	60
Adjust the strart / end point of the region	61
Converting divided samples to SLICED SAMPLES	62
Converting PATCHED PHRASE	62
Changing the tune and the tempo of a Patched phrase sample	63
Editing a Patched Phrase	63
Other available edits for Region	64
Setteing the loop	64
Linking the loop point to the start point	65

Chapter 12: Program 66

Creating a program	66
Assigning / Reassigning samples to the pads	66
Playing the sample while the Pad is being hit	67
Setting the volume and the tuning for a sample	67
Changing the sample volume with velocity	67
Changing the sample pitch with velocity	68
Playing several samples with one pad	68
Switching between samples using velocity	68
Setting the envelope for a pad	69
The functions in the Program window	71
Editing the sound of a sample	72
Limiting the number of the voice in the Program	73
Simulating the open / close hi-hat (setting the mute group)	74
Setting the overlap of the sounds on the same pad (voice overlap)	74

Editing a pad sample	75
Setting a LFO (Low Frequency oscillator)	77
Delete all the unused samples at the same time (PURGE)	78
Setting a MIDI note number to the pads	78
Assigning MIDI note numbers to the pads (changing the default setting)	78

Chapter 13: Mixer **79**

Setting the level and pan of the Pad	79
Setting the output for the sample	79
Selecting the pad to apply the effect	79
Mixer Automation	80
Shortcut between MIXER and Effect mode	80
Input Thru function	81
Applying effects to an incoming signal	81
Applying filters to an incoming signal	81
Using Q-Link features in INPUT THRU mode	82
Saving the setting of Input Thru	82

Chapter 14: Effect **83**

Applying effects to a specific pad sound	83
Applying effects of the FX2 to the effect sound of the FX1	84
Editing effects	84
Using the master effect	87
Editing the master effect	87
Editing the effect set	87
Shortcut between MIXER and Effect mode	88

Chapter 15: Save / Load	89
About a memory card	89
Saving the data	89
Saving data to the Internal Hard disk (option)	92
Loading a file	93
Renaming a file	96
Deleteing a file	96
Setting the auto load function	96
Formatting the memory card	97
Saving the data to the internal flash memory	97
 Chapter 16: Connecting the MPC1000 to your computer	 98
Connecting the MPC1000 to a Windows - based PC	98
Connecting the MPC1000 to the Macintosh	98
 Chapter 17: Other settings	 100
Foot switch	100
Adjusting the master level	100
Adjusting the contrast of LCD	100
Initialize to Factory Preset	101
Adjustment of Pad Sensitivity	101
 Specifications	 103
 Preset program list	 105
MIDI implementation chart	106
Index	108

MUSIC PRODUCTION CENTER
MPC 1000
Version 2.0

Operator's Manual

Chapter 1 : Introduction

Welcome to MUSIC PRODUCTION CENTER MPC1000. This operator's manual describes how to use an MPC1000.

Please read this manual before you start using your MPC1000, and keep it in a safe place so that you can refer to it as needed. In this manual, the names of the knobs and keys on panels and plugs are located in square brackets, as follows: [name] .

Overview

This chapter describes the name of each part and the function, and explains how to make connections and terminologies for the MPC1000.

■ Top Panel

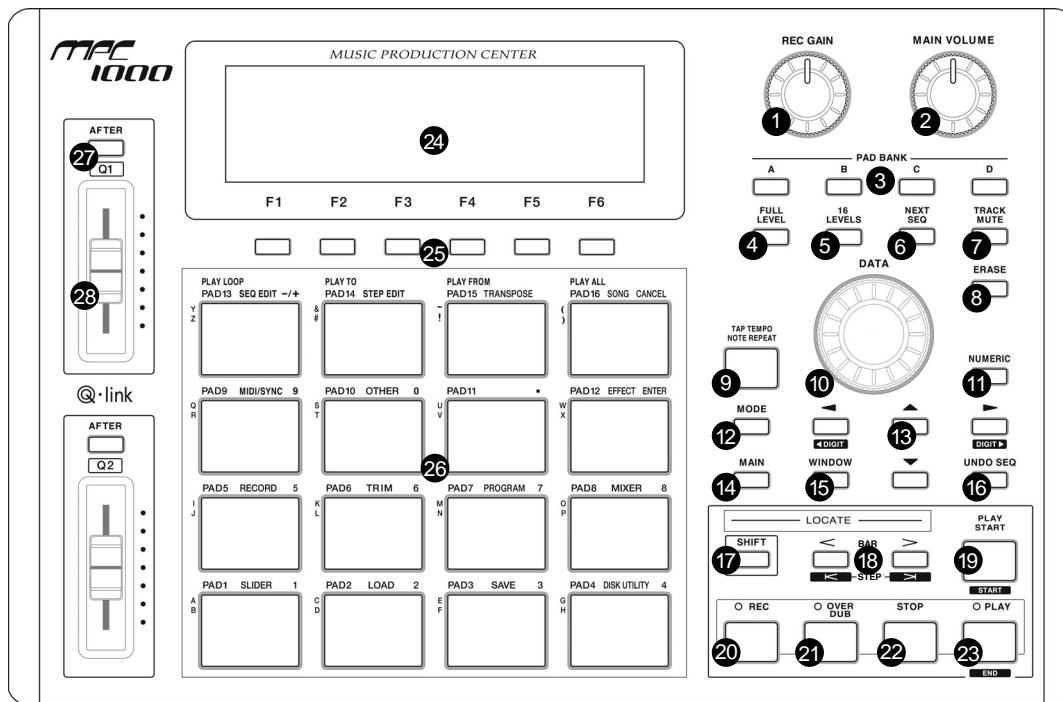

01. [REC GAIN] knob:

It controls the recording level of the incoming signal from [RECORD IN]. It cannot control the digital input level.

2. [MAIN VOLUME] knob:

It controls the levels of [STEREO OUT] and [PHONES] (headphone).

3. PAD BANK [A] through [D] keys:

Use these keys to switch between pad banks A, B, C, D. The LED above currently selected pad bank will be lit.

4. [FULL LEVEL] key:

When turned on (LED is lit), the MPC1000 always plays back at the maximum velocity (127).

5. [16 LEVELS] key:

When turned on, you can use 16 pads to change

the selected pad's velocity and tune in 16 steps.

For more information, see the "16 Level function" section on page 41.

6. [NEXT SEQ] key:

This key calls up the NEXT SEQ page, where you can switch sequences with pads.

For more information, see the "Selecting the sequence to play with pad" section on page 43.

7. [TRACK MUTE] key:

This key calls up the TRACK MUTE page where you can mute a track with pads. For more information, see the "Selecting track mute with pads" section on page 42.

8. [ERASE] key:

This key deletes event(s) within a track. You can delete events in real time on recording, or you can select the events to delete in the Erase window. For more information, see the "Erase feature" section on page 14.

9. [TAP TEMPO/NOTE REPEAT] key:

You can set a tempo by tapping this key to the desired tempo (TAP TEMPO feature). Also, by holding a pad while pressing this key, you can repeat a note according to the setting in T.C. (NOTE REPEAT feature). For more information, see the “Tap Tempo feature” section on page 18, and the “Note Repeat feature” section on page 17.

10. [DATA] wheel:

This changes the value of the currently selected field.

11. [NUMERIC] key:

If you press this key in any field, allowing you to enter numbers, the LED will blink and you can enter numbers using pads.

12. [MODE] key:

When you press this key (LED will blink), you can switch modes with pads.

13. [CURSOR] key: (▲ / ▼ / ◀ / ▶)

You can move the highlighted cursor up and down on the screen to select a field. In the value field, you can switch digits by pressing ◀ / ▶ keys, holding [SHIFT] key.

14. [MAIN] key:

Pressing this key displays MAIN mode, regardless the current mode.

15. [WINDOW] key:

Pressing this key, when the LED is lit, displays a pop up window where you can make a detailed setting of the field.

16. [UNDO SEQ] key:

When you record a sequence, the LED of this key will light up. Pressing this key, when the LED is lit, resets the system to its status before recording, and LED will be turned off.

17. [SHIFT] key:

You can use various features with a combination of another key.

18. [BAR] key: (< / >)

You can move sequences by bar. When you press </> keys holding the [SHIFT] key, you can step through sequences according to the value of the timing correct setting.

19. [PLAY START] key:

Plays a sequence from the start if LOOP:OFF.
If LOOP:ON plays sequence from loop start. Press [SHIFT] + [PLAY START] to go to start of sequence.

20. [REC] key:

Pressing the [PLAY START] key or the [PLAY] key holding this key starts recording to a sequence. Any event that is already recorded on the track will be replaced with new events.

You can punch in by pressing the [PLAY] + [REC] key while playing back a sequence, and punch out by pressing the [REC] key during recording.

For more information, see the “Punch In/Punch Out feature” section on page 17.

21. [OVER DUB] key:

This key is basically the same as the [REC] key, but it adds new events to the current events (over dub). You can punch in by pressing the [PLAY] + [OVER DUB] keys while playing back a sequence, and punch out by pressing the [OVER DUB] key while over dubbing.

22. [STOP] key:

This key stops the play back/recording of a sequence. If you hit this key 3 times quickly, you can stop all sound playing back.

23. [PLAY] key:

This key starts the play back of a sequence from its current position. Pressing the [SHIFT] + [PLAY] keys moves to the end of the sequence.

24. Display:

This is the LCD (Liquid Crystal Display) with backlight.

25. [F1] through [F6] keys:

These keys are used to call up pages to the bottom of the display, or to execute the feature assigned to the key. The available feature depends on the currently displayed screen.

26. [PAD1] through [PAD16]:

These are the drum pads to play the internal sampler. The pressure/strength you use to hit the pad controls the level of the sound. In TRACK MUTE mode, you can select a track and, in NEXT SEQ mode, you can select a sequence with a pad. You can also use these pads to select modes or to enter letters.

27. [AFTER] key:

When you turn on this key, the information of the Q-Link slider recorded on a track replaces the current value of the slider. For more information, see page 45.

28. [Q1] and [Q2] sliders

These sliders control the sound according to the setting in the SLIDER mode. For more information, see the “Q-Link slider” section on page 44.

■ Front Panel

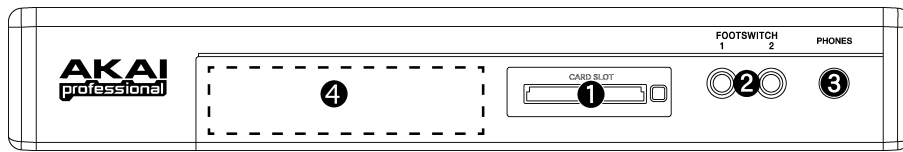

01. Compact flash slot:

This is a card slot for the compact flash memory card.

02. [FOOTSWITCH 1/2] plug:

This is where you connect a foot switch. You can use a foot switch to punch in/out. For more information, see the “Foot Switch” section on page 100.

There are two types of foot switches: normal open (the contact is open when it is not pressed), and normal closed (the contact is closed when it is not pressed).

If a foot switch has been connected to the MPC1000, when you turn on the power to the MPC1000, it automatically detects the type of foot switch connected. You can use either type of foot switch.

3. [PHONES] plug:

This is a stereo phone plug to connect a set of headphones. It sends out the same signal with the [STEREO OUT] plug.

4. 2.5 inch Hard Disk drive Bay:

Internal Hard Disk drive is installed inside. (The installation is done by removing the Front Panel.)
The kit-HDM10 (optional) and the 2.5 inch Hard Disk drive are needed.

■ Rear Panel

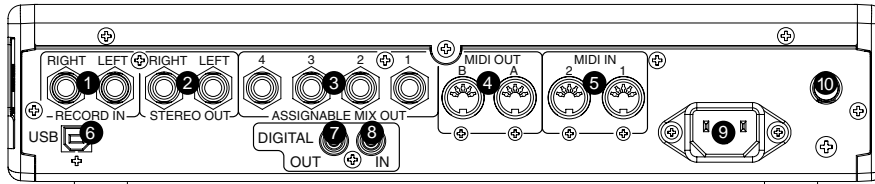

01. [RECORD IN L/R] plug:

This is an analog input for recording an analog signal. With a stereo phone plug, it can be used as balanced input.

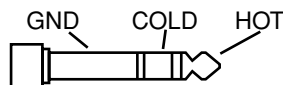

2. [STEREO OUT L/R] plug:

This is the main output .

3. [ASSIGNABLE MIX OUT 1/2/3/4] plug:

These are outputs you can use to output each pad sound separately. With external mixers or effecters, you can perform advanced mixing.

4. [MIDI OUT A/B] plug:

This is the MIDI output. Each output can send independent MIDI signals.

5. [MIDI IN 1/2] plug:

This is the MIDI input. MIDI signals from MIDI IN 1 and 2 will be merged (mixed).

6. [USB] plug (slave):

You use this plug to connect the MPC1000 to your PC and transfer data. For more information, see the “Connecting the MPC1000 to your computer” section on page 98.

7. [DIGITAL OUT] plug:

This is the coaxial digital output. It sends out the same signal as the [STEREO OUT] plug.

8. [DIGITAL IN] plug:

This is the coaxial digital input. Use this input to connect digital outputs such as a CD player and a DAT.

9. Power plug:

Plug in the AC cable here.

10. [POWER] switch:

It switches the power on/off of the unit.

■ Connecting MPC1000 to External Audio/MIDI device

The diagram below demonstrates how you can connect the MPC1000 to an external Audio/MIDI device.

Please note that this is one example, so, when you actually connect your devices, refer to the device's operator's manual.

Note: When you connect devices, make sure the power is turned off.

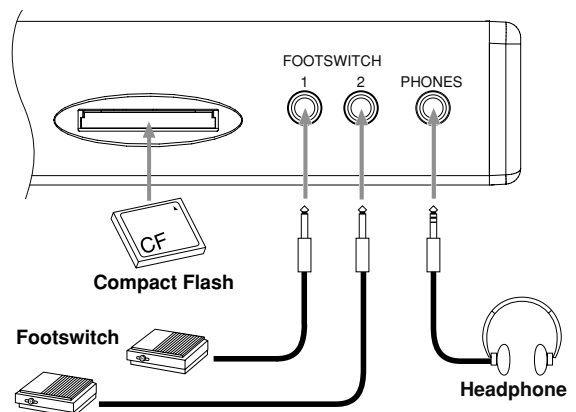
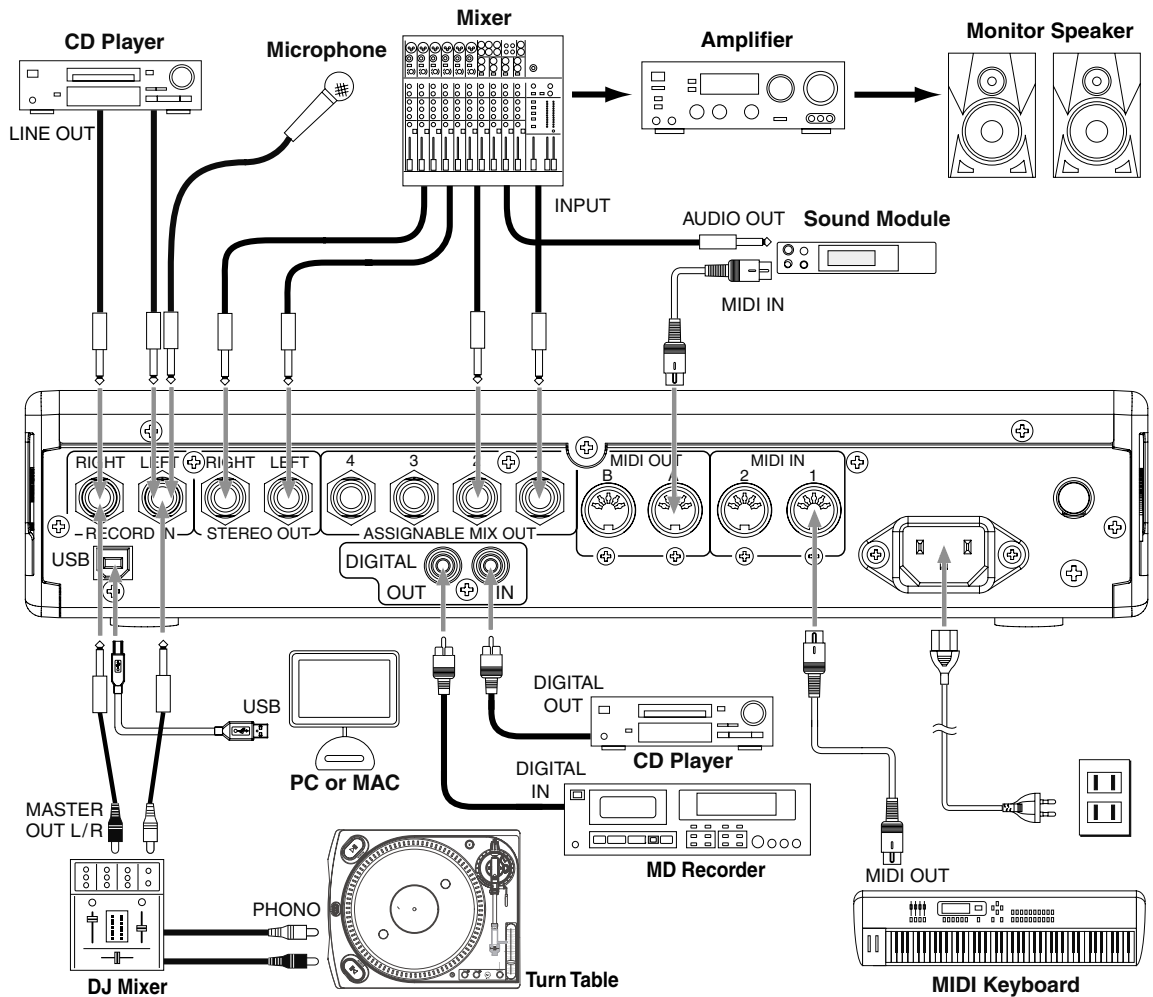

Terminologies in MPC1000

These are the basic terminologies you need to know to operate the MPC1000:

■ Sequence

Sequence is the most basic unit that you use when you create data with the MPC1000. The data from the MIDI keyboard or pads will be recorded to each track in a sequence.

A sequence has 64 tracks, each of which can hold performance data. You can create up to 99 sequences. The length of a sequence can be set from 1 bar to 999 bars. You can create a whole song with one sequence; however you can also create a song with a combination of several short sequences with the Song feature.

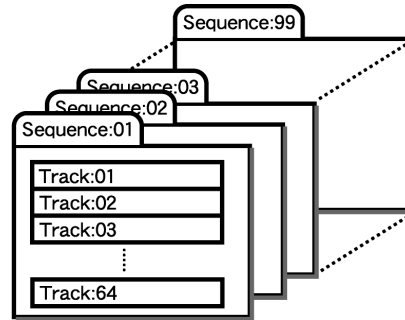

■ Track

A sequence has 64 tracks. Each track can record separate performance data. For example, you can record instruments separately on each track (ex. Piano sound in track 1, Bass on Track 2, Organ on Track 3, etc...). You can record one track at a time; however, you can play back already-recorded tracks while recording a new track. Each track has the track mute setting (whether play back the contents of the track or not). For example you record two Piano solos on Track 1 and Track4 and compare them using mute function. Performance data will be recorded on a track as a MIDI event. It does not record sounds directly on a track.

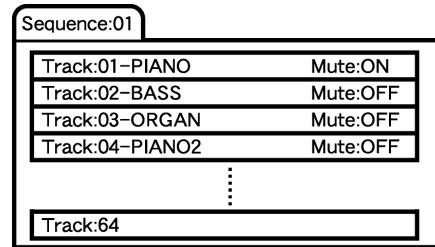

■ Song

With the song feature, you can play back sequences in a certain order. You can set the order and number of sequences to play back freely. This is useful when you wish to play back several songs in a row, or when you are creating a song with a combination of several sequence data.

With the MPC1000, you can create up to 20 songs. When you arrange sequences into a song, assign them to each step in the song. A step is like a “container” of sequences. A song has 250 steps.

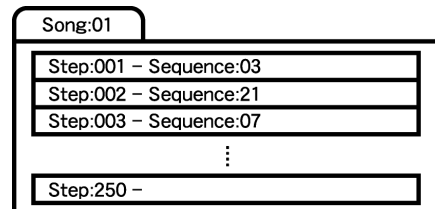

■ Sample

With the MPC1000, sound data that is loaded into the unit is called a sample. A sample is loaded to the MPC1000 when you record in RECORD mode, load from a memory card, or transfer from PC through USB. You can change the start/end point of a sample or set loop in TRIM mode. To play back sounds, you need to assign samples to pads in PROGRAM mode. There are 2 kinds of samples: Stereo sample (2-channel sample with left and right channels), and Mono sample (1-channel sample).

■ Drum Pad

The MPC1000 has 16 pads. You can play a sample that is assigned to a pad by hitting the pad. The MPC1000 has 4 pad banks that you can assign separate samples to. You can switch those 4 pad banks using the [PAD BANK] key, so you can use up to 64 pads. To assign samples to the pads, use the PROGRAM mode. The performance of the pad can be recorded to a track in a sequence.

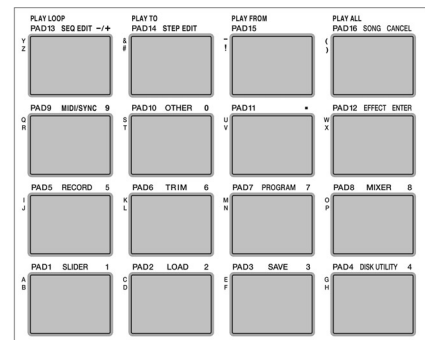

■ Program

Once you assign samples to the pads in the PROGRAM mode, you can play those samples with the pads. A set of 64 pads, each assigned samples, is called the Program. The program also has features that allow you to control the sound of samples, such as envelop and filter. You can make settings separately for each pad.

Program:01			
Pad bank	Pad	Sample	Level, Pan, Filter...
A	01	Side Stick	
A	02	Bass Drum	
A	03	Close Hihat	
		⋮	
D	16		

■ Note Number

This refers to the position (note) of the MIDI note event on the keyboard. For example, the note number for “Middle C” on the piano is “60”. The lowest key on the piano is “A-1” which is note number “21”. On a MIDI track, the MIDI keyboard performance data is recorded as a note number. On a Drum track, the note number is used to play back the sound in the internal sample. If you play the pads and recorded to a drum track, the note numbers assigned to the pad will be recorded on the track. When you play back this track, the sound assigned to the note number is played back.

■ RAM

RAM (Random Access Memory) is a space where you can load sounds or data temporarily. The MPC1000 comes with 16 MB (megabyte) of RAM that can record up to 136 seconds (monaural recording). The MB is a unit that represents the size of the memory. With the optional EXM128, you can increase your memory to 128MB.

The data loaded in the RAM will be deleted when you turn off the MPC1000. If you wish to save your recordings, you need to save on a memory card, or transfer the data to PC through USB.

■ Memory Card

The MPC1000 has a 32MB compact flash memory card. Compact Flash is a memory that is called “Flash Memory”. You can save the data on the flash memory like RAM, but the data will remain after you turn off the unit. By saving the recordings in the MPC1000’s RAM on the Memory card, you can save the data after you turn off the MPC1000. Please note that the MPC1000 cannot play back the data directly from a memory card. You have to load the data from a card to RAM to play back. There are several kinds of flash memory cards, but MPC1000 uses “compact flash” memory cards.

Chapter 2 : Basic Operation

In this chapter, we will describe the basic operation of the MPC1000.

■ MAIN Page

This is the main screen of the MPC1000, where you record and play back sequences. You can go back to this page at any time by pressing the [MAIN] key; for example, when you get lost while operating MPC1000 and want to go back to this page. You cannot go back to MAIN page by pressing [MAIN] key while processing (e.g. recording, loading/saving etc..).

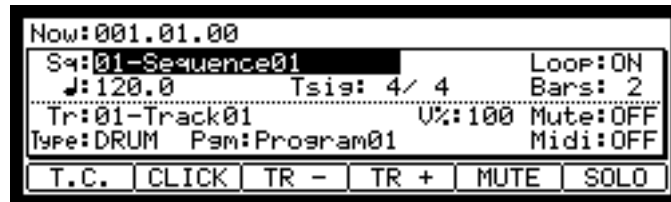

■ Cursor, Cursor Keys, Field, DATA Wheel

The highlighted part on the screen is called the “Cursor” (On above screen, [01-Sequence01] on Main screen is highlighted). You can move the cursor on the screen using four cursor keys on the panel. Usually they move to a specific locations such as right to colon (:). Those locations are called “field”, where you can make various setting, or enter values. To change the settings of a field, select the field and turn the [DATA] wheel on the panel.

This operation, selecting a field by using a cursor key and changing its settings with the [DATA] wheel, is the most basic operation of MPC1000.

■ Function Keys

Six keys (F1 to F6) aligned under the LCD (liquid crystal display) are function keys. Those keys correspond to each of the six functions that are displayed on the bottom of the LCD. Pressing each key activates its corresponding function. The function that each function key represents depends on the contents on the LCD.



When the LCD displays like this, pressing function keys starts some processing or displays windows.

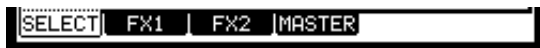

When LCD displays like this, you can switch pages using function keys F1 to F4. The currently selected page is displayed with black letters on a white background. Pressing F5 and F6 keys does not make any changes.

Some pages display the page selection and processing function at the same time (see below).



In this case, use F1 and F2 for switching pages, and F6 for activating processing. You cannot use F3, F4 and F5. In this book, function keys are described something like this: “[F1] (TRIM) key” - in the bracket, it shows the function displayed on LCD.

■ WINDOW key

The MPC1000 has so many functions that they cannot be displayed in one screen. For efficiency, each page only displays the most frequently used functions. If you want to make an advanced setting, press the [WINDOW] key. This opens a window for the detailed setting of the selected field. This is not available for all fields. When you select a field in which you can use the [WINDOW] key, the LED of the key is lit.

■ MODE key

With the MPC1000, each function (such as recording samples, editing samples, assigning samples to each pad, editing sequence data, loading from memory cards, etc..) has a separate screen. These screens are called “modes”. For example, you will use the RECORD mode to record samples, and the TRIM mode to edit samples, the [MODE] key switches modes. By pressing the [MODE] key and hitting a pad, you can switch modes. The mode that a pad corresponds to is displayed above each pad.

Setting names

The MPC1000 handles various types of data, from sound related data (such as samples and programs) to performance related data (such as sequences and tracks). These data are managed by names. In this section, you will learn how to name different data. Select a field which you wish to name with the cursor and turn the DATA wheel. The Name windows will show up. In the Name windows, you can name the data.

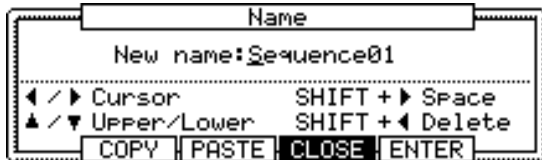

In this window, the cursor is displayed as an underscore instead of highlights.

You can enter the name, either by using pad or by using DATA wheel.

■ Entering letters with DATA wheel

You can change letters selected with a cursor by turning DATA wheel in the Name window. Move the cursor with RIGHT/LEFT cursor key and enter letters. You can enter letters using both DATA wheel and pads.

■ Entering letters with a pad

Two letters are assigned to each pad. By hitting a pad, the corresponding letter is entered. Below, we will describe how to enter "Bass 01" instead of "Sequence 01".

01. Press the UP cursor key to make the first letter capitalized.

Pressing the UP cursor key allows you to enter a capitalized letter.

02. Hit Pad 1 twice.

Hitting Pad 1 once enters A, twice enters B. Each time you hit the pad, the letter switches between A and B.

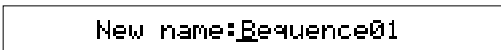

03. Press the RIGHT cursor key and move the cursor to the right.

If you enter the next letter using a different pad, the cursor will move to the right automatically. However, when you enter the letters which are assigned to the same pad, you need to press the RIGHT cursor key to move the cursor manually. In this example, A and B are assigned to the same pad. So, you need to move the cursor manually.

04. The next letter is a lower-case letter (" a "), so press the DOWN cursor key.

Pressing the DOWN cursor key allows you to enter lower case letters.

05. Hit Pad 1 once.

The lower case letter "a" is entered.



06. Hit Pad 10 once.

The cursor will move to the right automatically and a lower-case letter "s" is entered.

07. Press the RIGHT cursor key to move the cursor to the right and hit the pad 10 once.

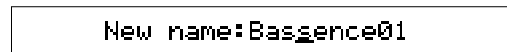

08. Press the RIGHT cursor key to move the cursor to the right and press RIGHT cursor key holding the [SHIFT] key.

The [SHIFT] + RIGHT cursor key inserts space.

09. Press the right cursor key to move the cursor one step to the right, and select "0" by turning the DATA wheel.

To enter numeric values, use the DATA wheels.

10. Press the RIGHT cursor key to move the cursor to the right, and select "1" by turning the DATA wheel.

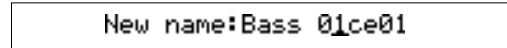

11. Press the RIGHT cursor key to move the cursor to the right, and press the LEFT cursor key four times holding the [SHIFT] key.

The [SHIFT] + LEFT cursor keys delete selected letters. Now "Bass 01" is entered instead of "Sequence 01".

12. Press [F5] (ENTER) to confirm the entry and close the window.

Pressing [F4] (CANCEL) cancels the entry and closes the window. In this case, the name does not change.

■ Other useful functions in the Name window

(Copy and Paste function)

With the copy and paste function, you can copy the letters in the “New name” field and paste to set a name to another data. This is useful when you wish to create similar names for different data.

If you press [F2] (COPY) key when Name window is open, the letters in the “New name” field will be copied (temporarily saved). When you press [F3] (PASTE) in the Name window, those copied letters can be pasted to the “New name” field.

Entering numbers with NUMERIC key

In the value fields such as the sample's TRIM page, you can enter numbers directly by using [NUMERIC] key.

01. Press the [NUMERIC] key on an available field.

The key's LED will blink and allows you to enter numbers using the pad.

02. Enter numbers by hitting the corresponding pads.

The number indicated on the upper right corner of the pad is entered. Pad 1 through 9 corresponds number 1 to 9 and Pad 10 corresponds to number 0. When you enter the wrong number, hit Pad 16. The number is canceled and you can enter the correct number.

03. Hit Pad 12.

That confirms your entry.

When you set the Time field, you can change the unit (digit) by hitting Pad 11. In fields where you can set +/-, you can switch + and - by hitting Pad 13.

Chapter 3 : Sequencer feature

The MPC1000 has a sequencer feature that allows you to record/playback your performance. With the sequencer feature, you can record the performance you created with the pads. And by playing back the recorded data, you can reproduce your performance. The actual performance will be recorded on a track within a sequence. For more information on sequences and tracks, see the “Terminologies in MPC1000” section on page 6.

The performance data you made by hitting the pads will be recorded on a track as a pad event. A track can contain other events, such as Q-Link slider information, tempo change etc... When you are using the MPC1000 with an external MIDI device, you can record the data from the external keyboard as MIDI events.

Note: Please note that Sequencer feature records only performance data (when and which pad you hit, etc...). It does not record the actual sound.

■ MAIN page

This is the page where you record/playback sequences. This is the MPC1000’s main operation mode and, unlike the other pages, you can display this page just pressing the [MAIN] key at any time.

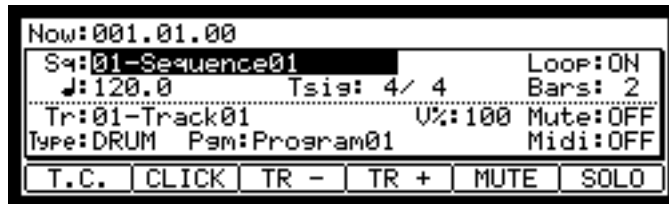

■ Now field

The Now field, which is located in the upper left corner of the screen, displays the current time of the sequence. It shows the bar, beat, tick (1 beat = 96 ticks), from left to right. For example, “002.03.00” means the third beat in the second bar. A tick is a unit that divides a beat (1/4 note) into 96 parts. For example, 1 beat equals one 1/4 note (96ticks), so one 1/8 note equals the half of 1 beat, which is 48 ticks.

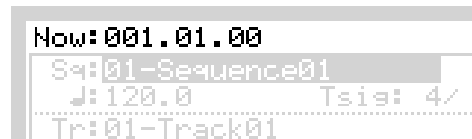

Below is the relationship between note and tick:

1/4 note	= 96 ticks	1/8 note	= 48 ticks	1/16 note	= 24 ticks
1/4 triplets	= 64 ticks	1/8 triplets	= 32 ticks	1/16 triplets	= 16 ticks

When you record/playback a sequence, the display updates constantly to show the current position of the sequence. You can move the cursor to the Now field to set the time manually.

■ Sequence / Sq field

A Sequence is the most basic unit when you create data with the MPC1000. Performance data from the MIDI keyboard or pad can be recorded on each track within a sequence. You can select a sequence in the Sq field. An unused sequence is indicated as (unused). All the settings in the MAIN page can be set separately for each sequence.



■ Track / Tr field

A sequence has 64 tracks where you can record various performance data separately. You can, for example, record Piano sounds on track 1, Bass on track 2, Organ on track 3 etc... In the Tr field, you can select a track within the sequence selected in the Sq field. An unused track is indicated as (unused). You can set Mute, Midi, V%, Type, and Pgm fields separately for each track.



Recording the performance

In this section, you will learn how to record the performance you made with pads to tracks in a sequence.

Note: To record your performance data to a sequence, you need to load a program to the MPC1000 that you play using the pads. By default, the MPC1000 automatically loads a preset program and demo sequence when you switch it on. Here, we assume that you have already loaded a program to the MPC1000. If you have not done so, do this now by loading a program from a memory card, or by recording a sample and assigning it to a pad, etc... For more information on loading a program, see the "Loading a file" section on page 93. For more information on recording a sample, see the "recording a sample" section on page 50.

01. Press the [MAIN] key.

The [MAIN] key displays the MAIN page where you record your sequences.

02. In the Sq field, select a sequence to which you wish to record your performance.

You can select any sequence for recording a performance; but here, select a sequence that says "unused". "Unused" indicates that the sequence is not used.

03. In the Tr field, select a track on which you wish to record your performance.

Your performance will be recorded on the track you select in the sequence. You can select any track, but here select "Tr:01".

04. In the Pgm field, select a program you wish to play.

You can select a program in the RAM by turning the DATA wheel.

05. Hit pads to check the sounds that are assigned to the pads.

You can play back the program selected in the Pgm field.

06. Press the [PLAY START] key while holding the [REC] key.

The recording will start after 4 counts.

07. Play the pads to record your performance.

By default, the sequence is set to 2 bars. After recording for 2 bars, the MPC1000 will start playing back the recorded performance. You can add to your original performance by continuing to play the pads when the track loops. The MPC1000 automatically switches to "over dub" recording and adds to the performance.

08. You can stop overdub recording by pressing [STOP] key.

09. Press the [PLAY] key to play your recorded performance.

10. If you do not like the performance, you can start a new recording by pressing the [REC]

[PLAY START] keys.

This cancels the currently recorded performance data and starts a new recording.

11. To add to the already recorded performance, press the [PLAY START] key while holding the [OVER DUB] key.

It plays back the currently recorded performance and you can add the new performance by hitting pads.

Tips: If you select another sequence in the Sq field, you can record a new performance separately. By playing back those sequences, you can create one whole song.

Tips: By default, the MPC1000 is set to load a demo sequence automatically when you turn it on. If you wish to remove the demo sequence and start from the scratch, see "Deleting all sequences" section on page 20.

Playing back a sequence

You can play back a recorded sequence by pressing the [PLAY START] key. The sequence will be played repeatedly until you press the [STOP] key. If you press the [PLAY] key again, the MPC1000 will resume the playback from where the previous play back was stopped.

Repeat play back of a sequence

You can play back several sequences in a series by using the Next Sequence feature. The Next Sequence feature allows you to select the next sequence to play, during playing back a sequence, so that you can play the sequences in a series.

01. In the Sq field in the MAIN page, select the sequence you wish to play first.
02. Press the [PLAY START] key to start the play back of the sequence.
03. Select the Sq field during play back, and select the next sequence to play.
Selecting a sequence in the Sq field during the playback brings up the Next field, where you can select the next sequence.
After playing back the currently selected sequence to the end, the MPC1000 will start playing back the sequence you select in the Next field. By repeating this step, you can play back several sequences continuously.

Tips: With the [NEXT SEQ] key, you can select the next sequence with a pad. For more information, see the “Selecting a sequence to play with pads” section on page 43.

Tips: In the SONG mode, you can set the order to play sequences. For more information, see the “SONG mode” section on page 37.

Other useful features for recording sequences

Undo Sequence feature

When overdubbing sequences, you can cancel the last recording and reset to the setting before the recording.

01. During overdubbing, press the [STOP] key to stop the overdub and press the [UNDO] key.
The LED of the [UNDO] key will be off and only the last added recording will be deleted. To restore the recording, press the [UNDO] key again to light the LED.

Note: You can use the [UNDO] key only for the last recording.

Erase feature

You can delete a certain pad performance by using the [ERASE] key. There are two ways to use this feature: by deleting real-time during overdub, and by selecting a pad and part to delete in the ERASE window when overdub is stopped.

Deleting in real time

01. Press the [PLAY START] key while holding the [OVER DUB] key to start overdub.
02. Hold the pad you wish to delete while holding the [ERASE] key.
From the performance data being recorded, only the section from where you press the [ERASE] key and pad and you release them will be deleted. By pressing the pad at the right timing, you can delete the performance data at a certain timing in the phrase.

Deleting in the Erase window

Performance data will be recorded in a track as an event. In the Erase window, you can select specific events in a track to delete.

01. Press the [STOP] key to stop a sequence.
02. Press the [ERASE] key.
The Erase window will open up.
The Tr field displays the number and the name of the selected track. To delete all the events of the track, select “Tr : 00 - ALL TRACKS” by turning the DATA wheel to the left.



03. In the Time field, specify the area to delete events.
You will select the start and end point of the area in the Time field. For example, to delete only the event in the first bar from 2-bar sequence, set “001.01.00 - 002.01.00”. In this case, the event at 002.01.00 point will not be deleted.
If you set the end point “002.01.00” like this, the area right before the end point will be included in the area.

002.01.00				
EVENT	EVENT	EVENT	EVENT	EVENT
001.04.93	001.04.94	001.04.95		002.01.01

04. In the Erase field, select NOTE ONLY.

Note field will open up.

05. Select the Note field.

If you wish to delete all events, leave it as ALL. To delete only events on a specific pad, hit the pad to delete. You can select several pads. If you hit a different pad by mistake, you can cancel the selection by hitting the pad again. To restart the pad selection, turn the DATA wheel to the left. The value in the Note field will be reset to ALL so that you can select pad from the beginning.

06. Press [F5] (DO IT) key.

The operation starts and the events of the selected pad within the selected area will be deleted.

Tips: When you delete events with the Erase field set to ALL EVENT, the MPC1000 will delete other events in the selected area as well as pad events. When you delete events with the Erase field set to EXCEPT Note, the MPC1000 will delete the other events other than the pad events in the selected area.

■ Timing correct feature

When recording a pad performance, it is hard to play the pads to the tempo. By using the timing correct feature, you can correct the timing of the pad event you recorded by hitting pads. There are two ways to use this feature: by correcting the timing in real time during the recording, and by correcting the recorded event after the recording.

- Real time timing correction

You can correct the timing real-time during the recording.

01. When a sequence is stop, press [F1] (T.C.) key in the MAIN page.

The Timing Correct window will open up.

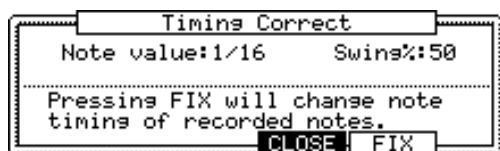

02. In the Note value field, set the value for timing correction.

For example, if you set "1/16", each position of the performance data will be moved to the nearest 1/16 note.

You can set the Note values as follows.

1/8 = 1/8 note, 1/8(3) = 1/8 note triplets, 1/16 = 1/16 note, 1/16(3) = 1/16 note triplets, 1/32 = 1/32 note, 1/32(3) = 1/32 note triplets, OFF = NO timing correction.

- Swing feature

You can set the swing value in the Swing% field. With the swing feature, the even numbered events set in the Note value field will be off the rhythm according to the value in the Swing% field. With this feature you can create the shuffle groove.

03. Press [F4] (CLOSE) key.

It closes the window.

Note: If you press [F5] (FIX) key, the MPC1000 will correct the timing of the recorded data.

Tips: If you press [F1] (T.C.) key during recording/playback, a small Timing Correct window will be displayed while you are holding the key. You can use the Note value field of this window to change the value for timing correction. It makes it easier to change the value during the recording.

- Correcting the timing of recorded events

You can correct the timing of recorded events.

01. When a sequence is stop, press [F1] (T.C.) key in the MAIN page.

Timing Correct window will open up.



02. In the Note value field, set the value for timing correction.

For example, if you set "1/16", each position of the performance data will be gridded to the nearest 1/16 note.

You can set the Note values as follows:

1/8 = 1/8 note, 1/8 (3) = 1/8 note triplets, 1/16 = 1/16 note, 1/16 (3) = 1/16 note triplets, 1/32 = 1/32 note, 1/32 (3) = 1/32 note triplets, OFF = NO timing correction.

- Swing feature

You can set the swing value in the Swing% field. With the swing feature, the even numbered events set in the Note value field will be off the rhythm according to the value in the Swing% field. With this feature you can create the shuffle groove.

03. Press the [F5] (FIX) key.

Timing Correct window will open up.

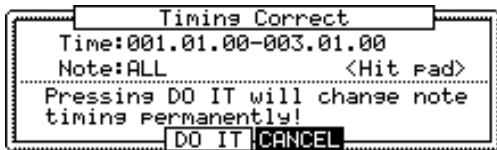

04. In the Time field, select the area to correct the timing.

05. In the Note field, hit the pad you wish to correct the timing.

To correct the timing of all events, leave it as ALL. To correct the timing of only events on a specific pad, hit the pad. You can select several pads. If you hit a different pad by mistake, you can cancel the selection by hitting the pad again. To restart the pad selection, turn the DATA wheel to the left. The value in the Note field will be reset to ALL so that you can select pad from the beginning.

06. Press [F3] (DO IT) key.

The timing correction will start and the window will be close.

■ Click/Metronome feature

In this section, you will learn about various settings for the metronome (click sound).

01. When a sequence is in stop mode, Press [F2] (CLICK) key in the MAIN page.

Click/Metronome window will open up.



Count in field

You can set how soon the recording/playback should start after the [PLAY] or the [PLAY START] key is pressed; right after the key is pressed, or after a 1-bar count.

- OFF Recording/playback will start right after the key is pressed without a count.
- REC ONLY There will be a count only for recording/overdub. Playback will be start without a count.
- REC+PLAY There will be a count for both recording and playback.

Rate field

You can select the rhythm for the metronome sound. The metronome will be played with 1/4 note if you set "1/4", and 1/8 note if you set "1/8".

In play field

You can select this if you want the metronome sound during playback. If you select YES, you will hear the metronome sound during playback.

In rec field

You can select this if you want the metronome sound during recording/overdub. If you select NO, you will not hear the metronome sound during the recording/overdub.

■ Note repeat feature

If you press a pad while holding the [NOTE REPEAT] key, the pad sound will be played repeatedly according to the value of the timing correct until you release the pad. You can also control its velocity by changing the strength used to press the pad. With the Note repeat feature, you can record a difficult phrase to record in real time, such as 16 beat hi hat, snare roll, etc...

01. Press the [NOTE REPEAT] key during recording / playback.

02. While holding the [NOTE REPEAT] key, press the pad to play repeatedly.

The pad's sound will be played repeatedly according to the value of the timing correct until you release the pad. You can also control its velocity by changing the strength to press the pad.

While holding down the [NOTE REPEAT] key, the bottom of display is changed as below. You can change the Timing correct value directly with pressing the [F1] through [F6] key.



The selected Timing correct value is highlighted.

Note : When you press the [F1] through [F6] key while pressing the [NOTE REPEAT] key, the other key's LED may be lit temporarily, but it is not trouble.

Note : As the [NOTE REPEAT] key is used together with the [TAP TEMPO] key, the tempo may be changed unexpectedly during the Note Repeat function.

For preventing this accident, set OFF in the Tap average field in the "MISC." page in the "OTHER" mode.

• Note Repeat Hold

You can also lock the "Note Repeat" feature by holding down the [NOTE REPEAT] key and then pressing the [SHIFT] key (or by holding down the [SHIFT] key and then pressing the [NOTE REPEAT] key). Pressing the [NOTE REPEAT] key again will unlock the "Note Repeat" feature.

■ Punch In/Punch Out feature

You can start the recording in the middle of the sequence during the playback ("Punch In").

You can also stop the recording in the middle of the sequence and resume the playback ("Punch Out"). This is useful when you re-record the part of the recorded sequence.

Punch In

Press the [PLAY], or the [PLAY START] key to playback a sequence. At the point where you wish to start the recording, press the [REC] key while holding the [PLAY] key. The MPC1000 will start the recording.

If you press the [OVER DUB] key and the [PLAY] key instead, the MPC1000 will start the over dubbing.

Punch Out

If you press the [REC], or the [OVER DUB] key during the recording/overdubbing, the MPC1000 will stop the recording/overdubbing and resume the playback.

Detailed information on sequence feature

■ Setting the length of a sequence

By default, a sequence is set to a 2-bar length, but you can set this length between 1 to 999 bars.

01. In the MAIN page, select the Bars field.
The Bar field displays the current value.
02. Turn the DATA wheel, or press [WINDOW] key.
The Change Bars window will open up.
03. In the New bars field, select the new number of bars.
If you set a larger number than the current value, empty bars will be added at the end of the sequence.
If you set a smaller number, the bars in the end of the sequence will be deleted.
04. Press [F5] (DO IT) key
That applies the new setting and closes the window.

■ Setting the time signature of the sequence

By default, the time of a sequence is set to the quadruple time (4/4), but you can change the setting.

01. In the MAIN page, select Tsig field.
The Tsig field displays the current value.
02. Turn the DATA wheel or press the [WINDOW] key.
The Change Tsig window will open up.

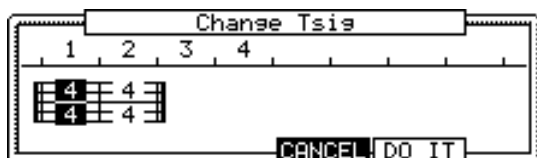

The upper part of the screen indicates the number of bars. The currently selected time is displayed below it.

03. Select the desired time signature, and set to this.
Select the bar to change the time with the right/left cursor keys and change the time with DATA wheel. will be displayed under the time display at the bar to which you changed the setting.
04. Press [F5] (DO IT) key
That changes the time signature of the bars and closes the window.

■ Setting tempo

You can set the tempo in the \downarrow (Tempo) field of the MAIN page. You can set the tempo for a sequence between 30.0 and 300.0. You can change the tempo after you create the sequence. You can also change the tempo in the sequence by inserting the tempo change event in the STEP EDIT mode.

• Tap tempo feature

You can set the tempo using the [TAP TEMPO] key as well as in the \downarrow (Tempo) field. Tap the [TAP TEMPO] key to the desired tempo. The MPC1000 will calculate the tempo starting with the timing that you tap with the [TAP TEMPO] key, and set the sequence's tempo to that. The MPC1000 takes the average interval of 4 taps of the [TAP TEMPO] key. You can set the number of taps used to calculate the tempo in the Tap average field in the MISC. page in OTHER mode.

Note : By setting OFF in Tap average field, the Tap tempo function will be invalidity.



• Changing tempo of all sequences at one time

You can change the tempo of all sequences to the same tempo at one time. You can change the tempo of each sequence at any time after you create the sequence, but it is useful to change all the sequence at one time when you are creating one song with several sequences.

01. In the MAIN page, select \downarrow (Tempo) field and press the [WINDOW] key.
The Tempo Change window will open.
02. Press [F5] (FIX) key.
The Fix Tempo window will open.
03. In the Fix tempo field, set the tempo.
04. Press [F3] (DO IT) key.
It changes the tempo of all of the sequences to the value set in the Fix tempo field.

• About Tempo change

With the STEP RECORDING feature in the STEP EDIT mode, you can insert the tempo change even in a track, so that you can change the tempo within a sequence. When you use the tempo change feature, select the \downarrow (Tempo) field in the MAIN mode and press the

[WINDOW] key to open the Tempo Change window and set the Tempo change field to ON.

When you turn the tempo change feature on, the **Tempo** field in the MAIN page will be displayed as below.

```
Sq:01-Sequence01
J:120.0 Tsig: 4/4
```

The tempo display on the left is the original tempo set for the sequence. On the right, the tempo you changed with the tempo change event will be displayed. The sequence will actually be played at the tempo in the right.

To move to the STEP EDIT mode, press [F2] (EDIT) key in the Tempo Change window.

■ Setting the loop for a sequence

By default, the MPC1000 has the sequence loop feature on. It is useful when you create a short sequence. With the sequence loop feature, you can overdub a new performance while playing back a sequence repeatedly. However, when you are working on a long song, created as a single sequence, it may be better to loop only the part of the song that needs to be changed. Also, when you wish to play freely without worrying about the bars or times, it is better to turn the loop feature off. In this section you will learn how to set the loop feature.

01. In the MAIN page, select the Loop field.

You can switch the sequence loop features ON/OFF by turning the DATA wheel.

In this field, you can only set the loop at ON/OFF. You can set the start/end points of the loop in the Loop window.

02. Press the [WINDOW] key.

The Loop window will open. The MPC1000 will repeat the part you set in the First bar and Last bar fields. If you set END in the Last bar field, the last bar of the sequence is always the end of the loop. Even if you edit a sequence and change its length, the last bar of the sequence is still the end of the loop.

The Number of bars field displays the length of the bars to loop. The Last bar field and the Number of bars field work together. Changing the value in the Last bar field also changes the value in the Number of bars field.

03. Press [F4] (CLOSE) key.

This closes the window and goes back to MAIN page.

Extending the sequence length automatically

Usually, the length of a sequence is set based on the value of the Bars field in the MAIN page. However, when you are recording/overdubbing with

the Loop field set to OFF, the length of a sequence will be extended automatically. For example, when the Bars field is set to 2, If you start recording with the loop field set to OFF, the recording will continue after second bar until you press the [STOP] key. And the number of the bar when you actually pressed the [STOP] key will be set as the new length for the sequence. This is useful when you do not know the length of the song.

Tips: When you press the [PLAY START] key when the First bar is not 1, the MPC1000 will start the playback from the bar set in the First bar field instead of from the beginning of the sequence.

■ Changing the default settings

Some settings for a sequence (such as number of the bars, time, tempo, loop) are automatically set to the default setting when you create a new sequence. You can change the default settings for your convenience.

01. In the MAIN page, set the Loop field, field, Tsig field, Bars field as you like.
02. Select the Sq field and press the [WINDOW] key.
The Sequence window will open.
03. Press [F3] (USER) key.
The User Default window will open.
04. Press [F5] (DO IT) key.
The values currently set in the Loop, , Tsig, Bars field in the MAIN page will be saved as default setting. The Next time you create a new sequence, these values are applied.

■ Changing the sequence name

01. In the Sq field in the MAIN page, select a sequence that you wish to change the name of.
02. Press the [WINDOW] key.
The Sequence windows will open.
03. In the Sequence name field, enter the new name.
For more information for setting the name, see the "Setting the name" section on Page 10.
04. Press [F4] (CLOSE) key.
It closes the window and goes back to MAIN page.

■ Changing the default name for a sequence

Usually, when you create a new sequence, the name will be set to the default name as “Sequence## (## will be the sequence number)” automatically. You can change the default name.

01. In the MAIN page, select the Sq field.
02. Press the [WINDOW] key.
The Sequence window will open.
03. In the Default name field, enter the new name.
For more information for setting the name, see the “Setting the name” section on Page 10.
04. Press [F4] (CLOSE) key.
This closes the window and goes back to the MAIN page.

■ Copying a sequence

You can copy a sequence to another sequence.

01. In the Sq field in MAIN mode, select a sequence to copy.
02. Press the [WINDOW] key.
The Sequence window will open.
03. Press [F5] (COPY) key.
The Copy Sequence window will open.
04. In the Sq field (below), select a sequence to copy to.
05. Press [F5] (DO IT) key.
Copying the sequence will start. To cancel the operation, press the [F4] (CANCEL) key.

■ Copying a sequence parameter

You can copy a sequence parameter to another sequence

01. In the Sq field in MAIN mode, select a sequence parameter to copy.
02. Press the [WINDOW] key
The Sequence window will open.
03. Press [F5] (COPY) key.
The Copy Sequence window will open.

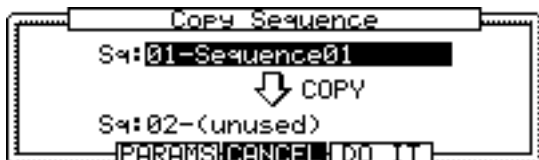

04. In the Sq field (below), select a sequence to copy to.
05. Press [F3] (PARAMS) key
Copying the sequence parameter will start. To cancel the operation, press the [F4] (CANSEL) key.

■ Deleting a sequence

You can remove a sequence from the memory of the MPC1000.

01. In the Sq field in MAIN mode, select a sequence to delete.
02. Press the [WINDOW] key.
The Sequence window will open.
03. Press [F2] (DELETE) key.
The Delete Sequence window will open.
04. Press [F5] (DO IT) key.
That deletes the selected sequence and changes its name to “unused”.

■ Deleting all sequences

You can delete all the sequence data in the memory at one time.

01. In the MAIN mode, select the Sq field and press the [WINDOW] key.
The Sequence window will open.
02. Press [F2] (DELETE) key.
The Delete Sequence window will open.
03. Press [F3] (ALL SQ) key.
The Delete ALL Sequences window will open.
04. Press [F5] (DO IT) key.
That deletes all the sequences and changes their names to “unused”.

■ Handling the duration (the length of a note) at the loop boundary

When you are recording a sequence in the loop mode, you can specify how the MPC1000 should operate when it reaches the boundary of the loop (it reaches the end of the sequence and jumps back to the beginning) while you are holding a pad.

01. Press the [MODE] key and then the [PAD 10] (OTHER) key.
That switches to the OTHER mode.
02. Press [F2] (MISC.) key.
The MISC. page will be displayed.

03. Select the Truncate duration field and select the option how to handle the duration between loops.

TO SEQUENCE LENGTH

The MPC1000 records as played up to sequence length.

TO SEQUENCE END

The MPC1000 cuts the note at the end of the sequence even if you hit the pad. You cannot record beyond the loop.

AS PLAYED

The MPC1000 records your performance as it is played.

Track features

■ Setting the track type

You can set the track type in the Type field in the MAIN page. There are two types of track: DRUM and MIDI. They are called DRUM track and MIDI track respectively.

Below are the differences of each track type.

DRUM Select this track type when you play the MPC1000's internal sampler by hitting pads. The DRUM track data will be managed per pad.

MIDI Select this track type when you use the MPC1000 as a MIDI sequencer with external MIDI devices (MIDI keyboard etc...). The MIDI track data is managed per MIDI note event. For more information, see the "MIDI sequencer feature" section on Page 24.

■ Selecting a program

When you wish to play the internal program with the MPC1000

In the Pgm: field, select the internal program loaded in the internal memory by turning the DATA wheel. You can play the samples in the selected program by hitting the pads. If you select "OFF" or "No.", the MPC1000 does not play the internal programs/samples, but instead will 'trigger' an external sound module such as a synth.

MIDI Program/Bank changes will also be transmitted to the external sound module.

- Setting the MIDI Program number on an Internal Program

You can set the MIDI Program Number to transmit to an external MIDI sound module when the sequence is selected. When you select "No." in the Pgm: field, the MIDI Program number field will appear in the right side of the Pgm: field. You can set the MIDI Program Number from 1 to 128. The selected MIDI Program Number will be transmitted from the selected MIDI OUT in Midi field when the sequence is selected or the [PLAY START] key is pressed.

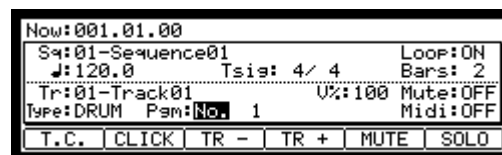

With the cursor in the Pgm: field, pressing the [WINDOW] key will open the Program Change window.

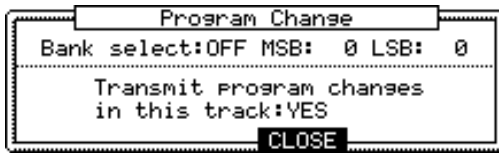

You can select MIDI Bank changes and the Program Changes in this window. You can also turn “OFF” MIDI Program changes for the current track.

Bank Select: (ON/OFF)

You can select whether a “Bank Select” message is transmitted or not.

MSB:/ LSB: (0-127)

You can set “MSB” (Control Change # 0) and “LSB” (Control Change #32) of a MIDI Bank Select message from 0 to 127.

Transmit program changes in this track: (YES / NO)

You can select whether a “MIDI Program Change” message is transmitted or not on the selected Track.

■ Track velocity feature

Allows you to adjust the Velocity ratio on the selected Track while the sequence is playing.

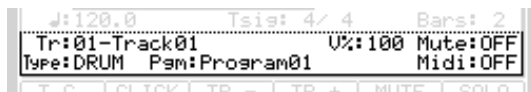

Select the “V%:” field in the MAIN page and adjust the Velocity ratio by turning the DATA wheel from 1% to 200%.

Note: Changing the “V%” has no effect while recording sequence data, it will only effect the playback of a sequence. If the velocity is set to 127 (maximum), any setting over 100% will have no effect.

■ Track mute feature

You can set the track mute in the Mute field on the MAIN page.

You can set the mute for each track independently. For example, let’s assume you have recorded a Piano solo on track 1 and another piano solo on track 2. By setting either track to mute, you can compare these two piano solos and choose the better one. If you set the mute ON for a track, the MPC1000 won’t play back that track.

Tips: With the [TRACK MUTE] key, you can set the track mute with a pad. For more information, see the “Setting the track mute with pads” section on page 41.

■ Setting the MIDI Output channel

You can set the MIDI output channel in the MIDI field on the MAIN page.

You can set the MIDI output channel for each track independently. You need to set the output channel when you use the MPC1000 to play an external MIDI sound module. You do not have to set this when you are using the internal sampler.

The MPC1000 has two MIDI outputs. Channels 1A through 16A will be sent out via MIDI OUT A, MIDI channels 1B through 16B will be sent out via MIDI OUT B.

■ Changing a track name

01. In the Tr field in the MAIN page, select a track you wish to change the name on.
02. Press the [WINDOW] key.
The Track window will open.
03. In the Track name field, enter the new name.
For more information for setting the name, see the “Setting the name” section on Page 10.
04. Press [F4] (CLOSE) key.
This closes the window and goes back to the MAIN page.

■ Changing the default name for a track

Usually, when you create a new track, the name will be automatically set as default “Track## (## indicates track number). You can change the default track name.

01. In the MAIN page, select the Tr field.
02. Press the [WINDOW] key.
The Track window will open.
03. In the Default name field, enter the new name.
For more information about setting the name, see the “Setting the name” section on Page 10.
04. Press [F4] (CLOSE) key.
This closes the window and goes back to the MAIN page.

■ Copying a track

You can copy a track to another track.

01. In the Tr field of the MAIN mode, select a track to copy.
02. Press the [WINDOW] key.
The Track window will open.
03. Press [F5] (COPY) key.
The Copy Track window will open.
04. In the Tr field (below), select a track to copy to.
05. Press [F3] (DO IT) key.
Copying the sequence will start. To cancel the operation, press [F4] (CANCEL) key.

■ Deleting a track

You can remove a track from the memory of the MPC1000.

1. In the Tr field in MAIN mode, select a track to delete.
2. Press the [WINDOW] key.
The Track window will open.
3. Press [F2] (DELETE) key.
The Delete Track window will open.
4. Press [F5] (DO IT) key.
That deletes the selected track and changes its name to "unused".

■ Deleting all tracks

You can delete all the track data in the memory at one time.

01. In the MAIN mode, select the Tr field and press the [WINDOW] key.
The Track window will open.
02. Press [F2] (DELETE) key.
The Delete Track window will open.
03. Press [F3] (ALL TR) key.
The Delete ALL Tracks window will open.
04. Press [F5] (DO IT) key.
That deletes all the tracks and changes their names to "unused".

■ Selecting a track with function keys

You can select a track in the Tr field in the MAIN page. You can also select a track using [F3] (TR -) key and [F4] (TR +) keys. With [F3] (TR -) and [F4] (TR +) keys, you can select a track without moving a cursor to the Tr field.

■ Solo function of a track

When you are working on a sequence that has many tracks, it is useful to use the solo function to play back only the selected track. For example, when you are recording various instruments on several tracks, you can check the contents of each track with this feature.

01. In the Tr field in the MAIN page, select a track you wish to play back.
02. Press [F6] (SOLO) key and start recording/playback of the sequence.
The [F6] (SOLO) key will be highlighted and the MPC1000 plays back only the selected track and mutes all the other tracks.
03. To cancel the solo, press [F6] (SOLO) key again.
The MPC1000 plays back all tracks.

MIDI sequencer features

When you are playing the internal sound module with the pads, you can start recording just by selecting the desired program in the Pgm field in the MAIN page. However, the MPC1000 can be used as a MIDI sequencer. By connecting an external MIDI keyboard to it, you can record the data from the keyboard and control the external sound module.

■ About MIDI...

MIDI is a standard for transferring the performance data between electronic instruments regardless of the manufacturer. Devices are connected using a special cable called MIDI cable. For example, when you connect the keyboard's MIDI OUT to MIDI IN of the MIDI sound module, the performance data you made with your keyboard will be sent to the MIDI sound module, which plays the sound. MIDI can transfer only the performance data, not the actual sound. To transfer as much data as possible through one MIDI cable, there are MIDI channels. By using a MIDI channel, you can transfer different performance data to each channel separately. You can transfer the performance data to up to 16 channels. The MIDI channel is very important when you handle MIDI.

You must set the same MIDI channels for both the keyboard and the sound module even if you play the sound from the keyboard. For example, if the keyboard's output channel is set to 1, the sound module's input channel should also be 1. Some sound modules can receive several channels. In that case, you can assign a separate instrument (Piano, Bass, Strings etc...) to each separate channel.

■ About MIDI sequencer

A MIDI sequencer is a device that can record and play back MIDI data. The MPC1000 can be used as a MIDI sequencer. When you connect an external MIDI keyboard to use the MPC1000 as a MIDI sequencer, connect the keyboard's MIDI OUT to MPC1000's MIDI IN, and the MPC1000's MIDI OUT to the external MIDI sound module's MIDI IN. Thus, you can record the keyboard performance to the MPC1000 and play sounds from the MIDI sound module. In this section, you will learn how to record the performance data from the external MIDI keyboard to the MPC1000 and play sounds from the external sound module.

01. Connect the external MIDI devices as described in the "Connecting MPC1000 to External Audio/MIDI device" section on page 6.

Connect the MIDI OUT of the keyboard to the MPC1000's MIDI IN, and the MPC1000's MIDI OUT to MIDI IN of the external sound module.

Note: You may still want to connect the MPC1000's stereo out to a mixer so that you can hear a metronome sound even when you use the MPC1000 as a MIDI sequencer.

02. In the Type field, select MIDI.

03. In the Pgm field, select OFF or No.

If you select it to the OFF or No., the MPC1000 does not play internal programs. If you select it to the No. and set MIDI Program number, MPC1000 transmit the MIDI Program number to the external sound module for selecting the sound in it when the sequence is selected.

04. In the Midi field, select a MIDI channel.

Here, you set the MIDI channel to send the MIDI data on. Set the same channel as the one on of the sound module.

Tips: By default the MPC1000's input MIDI channel is set to receive all MIDI channels, so you don't have to set the channel to the keyboard's MIDI channel.

05. Play the keyboard to make sure the sound module works.

If you don't hear any sound, check the connection and make sure you have the correct settings for the keyboard and the sound module.

06. Press the [PLAY START] key while holding the [REC] key. The recording starts after 4 counts.

07. Play the keyboard in time with the click sound.

By default, sequence is set to 2 bars. After recording for 2 bars, the MPC1000 will start playing back the recorded performance. If you make another performance with pads, you can add the performance to the currently recorded one. This is called "over dub".

08. You can stop over dub by pressing the [STOP] key.

09. Press the [PLAY] key to play the recorded performance.

10. If you don't like the performance, you can start the new recording by pressing the [REC] + [PLAY START] key. It cancels the currently recorded performance data and starts the new recording.

12. To add the recording to the already recorded data, press the [PLAY START] key while holding [OVER DUB] key.

This plays back the currently recorded performance and you can add the new performance by hitting pads.

Tips: If you select another sequence in the Sq field, you can record a new performance separately. By playing back those sequences, you can create one whole song.

Tips: You can use the other useful features for sequence recording (see page 14) like when you record the performance data from pads.

Tips: For more information on how to connect a MIDI keyboard with sound module to the MPC1000, see the “connecting MPC1000 to a MIDI keyboard with sound module” section on page 48.

■ Handling the sustain pedal

In this section, you will learn how to set the option to handle the sustain pedal information when you are connecting the MPC1000 to the external MIDI keyboard to use it as a MIDI sequencer.

Sustain pedal data is a MIDI event used to make the sound continue after a key on the keyboard is released. Usually a foot switch controls this data. The keyboard sends out Sustain pedal data as separate event from note event, so normally the sequencer recognize this data as separate data. However, when you are over-dubbing on a short sequence loop, it might be better to convert the sustain pedal data to the recorded note's duration (the length of the note).. For example, if you record the sustain pedal data as it is, once you press the sustain pedal during the loop, the sustain will be applied to all the data after that. If you convert the sustain pedal data to a note's duration, the movement of the sustain pedal will not affect the other notes.

Thus, the MPC1000 is set to convert the sustain pedal data to a note's duration by default, but you can change the setting to record the data as the sustain pedal data.

01. Press the [MODE] key and then the [PAD 10] (OTHER) key.

It switches to OTHER mode.

02. Press [F2] (MISC.) key.

The MISC. page will be displayed.

03. In the Sustain pedal to duration field, select the option how to handle sustain pedal.

YES The MPC1000 converts the sustain pedal information into duration.

NO The MPC1000 records the sustain pedal information as it is.

Chapter 4 : Editing sequences

There are two ways to edit sequences. You can select a region and edit all events at one time, or you can edit each event in detail. In this section, you will learn about the SEQ EDIT mode, where you can select a region to edit your event(s).

Selecting a region within a track to edit

You can edit the events within a region that you set in the track. This is done in the EVENTS page of the SEQ EDIT mode, which can be accessed by pressing the [MODE] key and then the [PAD 13].

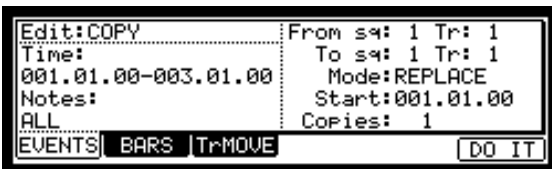

■ Selecting a region for the editing

In the EVENTS page, there are 3 different editing options in the Edit field: COPY, MOVE and TRANSPOSE. The procedure to select the editing region is the same for all three options. Let us begin with the selection of the editing region.

• Setting the time

Select the Time field in the EVENTS page of the SEQ EDIT mode.

In the Time field, you can set the start and end points of the editing region. For example, to edit the first bar of a 2-bar sequence, set this field to "001.01.00 - 002.01.00". In this case, the event at the "002.01.00" point will not be edited.

If you set the end point "002.01.00", like in this picture, the area right before this point will be included in the area.

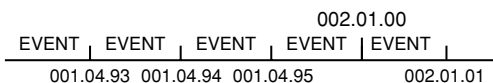

• Setting the pad/note number

01. Select the Notes field in the EVENTS page of the SEQ EDIT mode.

The display of the Notes field depends on the type of the track that you have selected.

• When DRUM track is selected:

In default, the field is set to ALL, which means the MPC1000 will edit all the pads. If you wish to edit only a specific pad, position the cursor in the Notes field and hit the desired pad. The pad number will be displayed in the Notes field. You can select several pads. If you hit a different pad by mistake, you can cancel the selection by hitting the pad again. To restart the pad selection, turn the DATA wheel to the left. The value in the Note field will be reset to ALL so that you can select the pad that you want from the beginning.

When MIDI track is selected:

The display changes to show the selected region by note number.

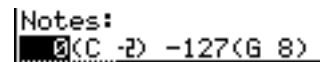

You will set the upper limit and the lower limit of the note in the field, The MPC1000 will edit only the events within the note numbers set in this field.

■ Copying events (COPY)

You can copy events within the selected region to another place. The source data will remain in the original location.

01. Select the Edit field in the EVENT page of the SEQ EDIT mode, and select COPY.

The various fields necessary for the copying will be displayed.

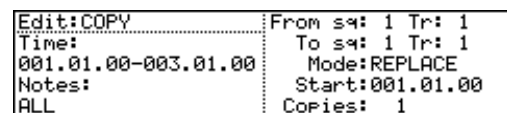

02. In the Time field and the Notes field, select the region and notes that you wish to copy.

03. In the From sq field and the Tr field in the right, select the source sequence and track.

04. In the To sq and the Tr field in the right, select the destination sequence and track.

Tips: In the EVENTS page, the From sq, Tr field and the To sq, Tr field only display the sequence number and the track number respectively, but pressing the [WINDOW] key when the cursor is in the From sq, Tr or To sq, Tr field, will bring up the Select window, where you can browse the sequence or track name to select.

05. In the Mode field, specify how to copy the data to the destination.

REPLACE The MPC1000 will overwrite the destination with the source data. The data that is already in the destination will be removed.

MERGE The MPC1000 will merge the source data with the data that is already in the destination.

06. In the Start field, set the start point of destination time. The MPC1000 will start the copy to the time set here.

07. In the Copies field, set the number of times to copy. To copy the same phrase repeatedly, enter the number of copies in the Copies field. You can copy it repeatedly with one operation.

08. Press the [F6] (DO IT) key. The MPC1000 will start copying the data.

■ Moving events (MOVE)

You can move events within the selected region to another location. Unlike the copy function, this function will remove the source data from the original location.

01. Select the Edit field in the EVENT page of the SEQ EDIT mode, and select MOVE.

The various fields necessary for moving will be displayed.

Edit:MOVE	From sq: 1 Tr: 1
Time:	To sq: 1 Tr: 1
001.01.00-003.01.00	Mode:REPLACE
Notes:	Start:001.01.00
ALL	

02. In the Time field and the Notes field, select the region that you wish to move.

03. In the From sq field and the Tr field on the right, select the source sequence and track.

04. In the To sq and the Tr field on the right, select the destination sequences and tracks.

Tips: In the EVENTS page, the From sq, Tr field and the To sq, Tr field only display the sequence number and the track number respectively, but pressing the [WINDOW] key when the cursor is in the From sq, Tr or To sq, Tr field, will bring up the Select window, where you can browse the sequence or track name to select.

05. In the Mode field, specify how to move the data to the destination.

REPLACE The MPC1000 will overwrite the destination with the source data. The data that is already in the destination will be removed.

MERGE The MPC1000 will merge the source data with the data that is already in the destination.

06. In the Start field, set the start point of destination time. The MPC1000 will start moving the event to the time selected here.

07. Press the [F6] (DO IT) key. The MPC1000 will start moving the event.

■ Changing the key (Pitch) of the event/ the pad event to other pad (TRANPOSE)

You can transpose (change the key of) the note events. This operation changes the selected track, whether it's a DRUM track or a MIDI track.

01. Select the Edit field in the EVENT page of the SEQ EDIT mode, and select TRANPOSE.

The various fields necessary for the transpose will be displayed.

Edit:TRANPOSE	Edit sq: 1 Tr: 1
Time:	Amount: 0
001.01.00-003.01.00	
Notes:	
ALL	

02. In the Time field and the Notes field, select the region that you wish to edit.

03. In the Edit sq field and the Tr field on the right, select the sequence and track that you wish to edit.

When the MIDI track is selected, the Amount field is displayed. Set the amount of the transpose in the Amount field. The unit of the amount is semi tone.

When the DRUM track is selected, the Pad field is displayed. You can change the selected pad event to another pad event. To do this, select the pad event you wish to change in the Notes field and then select the destined Pad in the Pad field.

In the Edit sq field and Tr field, you can select ALL by turning the DATA wheel.

When you select ALL, the Transpose is performed on all sequence or all tracks.

Note : When you select ALL, the Transpose is performed only in the MIDI tracks, not in the DRUM tracks.

04. Press the [F6] (DO IT) key. The MPC1000 will start processing your changes.

■ Changing the timing of an event (SHIFT TIMING)

You can shift the timing of the note event.

01. Select the Edit field in the EVENT page of the SEQ EDIT mode, and select SHIFT TIMING.

The various fields necessary for the Shift Timing will be displayed.

```

Edit:SHIFT TIMING      Edit sq: 1 Tr: 1
Time:
001.01.00-003.01.00  Direction:LATER
Notes:                Amount: 0
ALL
    
```

02. In the time field and the Notes field, select the region that you wish to edit.

03. In the Edit sq field and the Tr field on right, select the sequence and track that you wish to edit.

In the Edit sq field and the Tr field, you can select ALL by turning the DATA wheel. When you select ALL, the MPC1000 will shift the timing of all the sequence and tracks. .

04. In the Amount field, set the amount of Shift timing.

You can set by tick.

05. Select the direction of Shift Timing.

- EARIER: Shifts forwards
- LATAR: Shifts back

06. Press the F6 (DO IT) key

The MPC1000 will start processing your changes.

■ Changing the Velocity of an event (Velocity)

You can change the velocity of any note event.

01. Select the Edit field in the EVENT page of the SEQ EDIT mode, and select Velocity.

The various fields necessary for changing the velocity will be displayed.

```

Edit:VELOCITY         Edit sq: 1 Tr: 1
Time:
001.01.00-003.01.00  Mode:ADD VALUE0
Notes:                Value: 1
ALL
    
```

02. In the time field and the Notes field, select the region that you wish to edit.

03. In the Edit sq field and the Tr field on right, select the sequence and track that you wish to edit.

In the Edit sq field and the Tr field, you can select ALL by turning the DATA wheel. When you select ALL, the MPC1000 will change the velocity of the sequence and all its tracks.

04. In the MODE field, choose the method of velocity change.

ADD VALUE: Adds the value selected in the Value: field to the note.

SUB VALUE: Subtracts the value selected in the Value: field from the note.

MULTI VAL%: Multiplies the Velocity (percent) by the value selected in the Value: field.

SET TO VALUE: Sets the note to the Velocity selected in the Value: field..

05. In the Value field, set the value to be adjusted.

You can set the Value between 0 and 127. When you select "MULTI VAL%" in the Mode field, you can set the Value between 0 and 200.

06. Press the F6 (DO IT) key

The MPC1000 will start processing your changes.

■ Changing the duration of an event (DURATION)

You can change the Duration of any note event.

01. Select the Edit field in the EVENT page of the SEQ EDIT mode, and select DURATION.

The various fields necessary for changing the duration will be displayed.

```

Edit:DURATION         Edit sq: 1 Tr: 1
Time:
001.01.00-003.01.00  Mode:ADD VALUE0
Notes:                Value: 1
ALL
    
```

02. In the time field and the Notes field, select the region that you wish to edit.

03. In the Edit sq field and the Tr field on right, select the sequence and track that you wish to edit.

In the Edit sq field and the Tr field, you can select ALL by turning the DATA wheel. When you select ALL, the MPC1000 will change the Duration of the sequence and all its track.

04. In the MODE field, select how you want to change the Duration.

ADD VALUE : Adds the value selected in the Value: field to the note.

SUB VALUE : Subtracts the value selected in the Value: field from the note.

MULTI VAL% : Multiplies the Velocity (percent) by the value selected in the Value: field.

SET TO VALUE : Sets the note to the Velocity selected in the Value: field..

05. In the Value field, set the value to be adjusted.

You can set the Value between 0 and 9999. When you select "MULTI VAL%" in the Mode field, you can set the Value between 0 and 200.

06. Press the F6 (DO IT) key

The MPC1000 will start processing your changes.

Selecting the editing region by bar

You can edit the sequence by bar. This is done in the BARS page in the SEQ EDIT mode, which can be accessed by pressing the [MODE] key and then the [PAD 13].

■ Copying bars (COPY)

You can copy bars within the selected region to another place. The length of the destination sequence will be extended to add the copied bars.

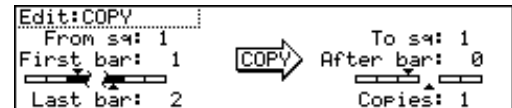

01. Select the Edit field in the BARS page of the SEQ EDIT mode, and select COPY.

The various fields necessary for copying will be displayed.

02. In the From sq field, select the source sequence.

03. In the To sq, select the destination sequence.

Tips: In the EVENTS page, the From sq, Tr field and the To sq, Tr field only display the sequence number and the track number respectively, but pressing the [WINDOW] key when the cursor is in the From sq, Tr or To sq, Tr field, will bring up the Select window, where you can browse the sequence or track name to select.

04. In the First bar field, select the first bar of the source sequence.

05. In the Last bar field, select the last bar of the source sequence.

06. In the After bar field, select the destination.

The selected bars will be copied to the end of the bar set here.

07. In the Copies field, select the number of times to copy the data.

To copy the same phrase repeatedly, enter the number of copies in the Copies field. You can copy it repeatedly with one operation.

08. Press the [F6] (DO IT) key.

The MPC1000 will start copying the bars.

■ **Inserting a bar (INSERT)**

To insert empty bars in the sequence, proceed as follows:

01. Select the Edit field in the BARS page of the SEQ EDIT mode, and select INSERT.

The various fields necessary for inserting bars will be displayed.

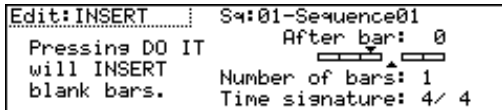

02. In the Sq field, select the sequence that you wish to insert the bars.

03. In the After bar field, select the location to insert the bars in.

The selected bars will be inserted at the end of the bar set here.

04. In the Number of bars field, set the number of bars to insert.

05. In the Time signature field, select the time signature of the bars to insert.

06. Press the [F6] (DO IT) key.

The number of empty bars selected will be inserted at the selected location.

■ **Deleting a bar (DELETE)**

To delete the selected bar(s) in the sequence, proceed as follows:

01. Select the Edit field in the BARS page of the SEQ EDIT mode, and select DELETE

The fields necessary for deleting the bars will be displayed.

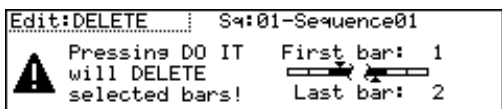

02. In the Sq field, select the bars to delete.

03. In the First bar field, specify the first bar to delete.

04. In the Last bar field, specify the last bar to delete.

05. Press the [F6] (DO IT) key.

The selected bar(s) will be deleted.

Changing the order of tracks (TRACK MOVE)

When you are creating a song by combining several short sequences, normally you would use the SONG feature to play back sequence in the specified order. The MPC1000 can convert the song data with short sequences to one long sequence. To do this, you need to arrange the order of the tracks in each sequence. In this section, you will learn how to use the track move function that allows you to change the order of the tracks in a sequence.

You can set the track move in the TrMOVE (Track move) page of the SEQ EDIT mode, which can be accessed by pressing the [MODE] key and then the [PAD 13].

01. In the SEQ EDIT mode, press the [F3] (TrMOVE) key. The TrMOVE (Track move) page will be displayed.

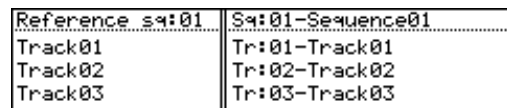

02. In the Sq field, select the track that you wish to change the order.

03. In the Reference sq field, select the sequence to be used as the reference when changing the order.

For example, if you want other tracks to follow the order in sequence 01, you should select sequence 01 in the Reference sq field.

04. Using the down cursor key, move the cursor to the track list.

05. You can scroll through the list by turning the DATA wheel. Select the track that you wish to move.

06. Press the [F6] (SELECT) key.

This selects the track.

To select a track again, press the [F5] (CANCEL) key.

07. Select the destination by turning the DATA wheel.

The list will scroll with the track selected in steps 5 and 6 fixed.

Refer to the list on the left to select the destination position.

08. Press the [F6] (MOVE) key.

The track will move to the selected location and the order will be changed.

Chapter 5 : Step editing

There are two ways to edit sequences. You can select a region and edit several events at one time, or you can edit each event in detail. In this section, you will learn about the STEP EDIT mode, where you can edit each event in detail.

About step edit

Each track has the performance data you made with pads, or MIDI note information from an external MIDI keyboard. The Step Edit function allows you to edit each event separately. There are other types of events than Pad and MIDI note information. There are also events specific to the MPC1000, such as Q-Link slider information and tempo information, and MIDI events such as pitch bend and modulation wheel.

Step edit is done in the STEP EDIT mode, which is accessed by pressing the [MODE] key and then [PAD 14].

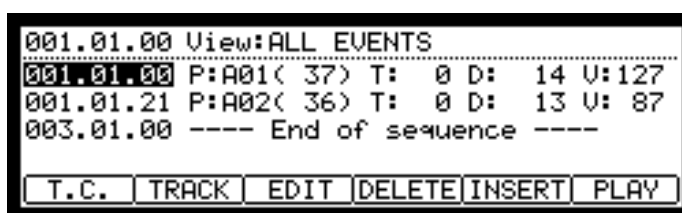

Screens

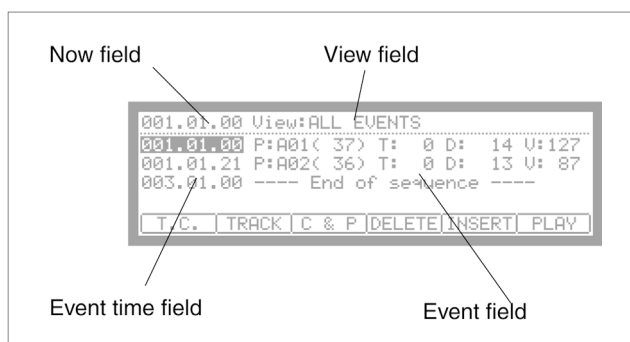

■ Now field

The time display on the upper left corner on the screen is the Now field. The Now field always displays the current position of a sequence. This is the same as the Now field in the MAIN page.

■ View field

You can set the type of events to display in the event list in this field. The event list displays only the events set in this field. It is useful when you wish to edit only specific events.

■ Event list

The event list is displayed below the Now field and the View field. It lists the events within the active track.

■ Event time field

The event time field is displayed to the left of the event list. It displays the positions of the events within the track.

■ Event field

The Event field is displayed to the right of the event time field. The display differs depending on the type of event. You can change the value by moving the cursor.

■ Basic operation

Event list

When the cursor is in the Now field or View field, pressing the down cursor key moves the cursor to the event list.



You can scroll through the event list with the up and down cursor keys. When the cursor is in the event time field, you can scroll through the list by turning the DATA wheel.

When the cursor is in the event time field, pressing the left cursor key moves the cursor to the Now field.

In the event list, you can select several events at one time by pressing the down cursor key while holding the [SHIFT] key.

[F1] (T.C.) key

This key works the same as the [F1] (T.C.) key in the MAIN page. You can set the timing correction. For more information, see the “Timing correct feature” section on page 15.

[F2] (TRACK) key

Pressing this key displays the window to change tracks until you release the key. You can select a track without switching back to the MAIN page.

[F6] (PLAY) key

Pressing this key plays back the selected event.

Editing method

In the step edit page, the events in the track are listed. You can select the event with up/down cursor keys and the field with right/left cursor keys. You can change the value in the field by turning the DATA wheel.

Events

■ Pad event

This is the event that is recorded when you hit the pads in the DRUM track.

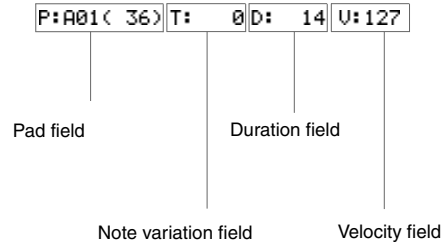

P (pad) field

You can set the pad number in this field.

Note variation field

In the above picture, the area that displays “T” is the note variation field. You can select the type of note variation data to record with the Q-Link sliders.

- T Tune (pitch)
- F Filter
- L Layer
- A Attack time
- D Decay time

About the note variation

Note variation data, which is used for the Q-Link sliders or 16LEVELS function, is the information used to control the sound of a pad, and is saved in the track along with the pad event. With the note variation data, you can switch the sounds of the pad even when you are playing back the same pad.

Note variation value field

In this field, displayed to the right of the note variation field, you can set the note variation value.

D (duration) field

You can specify the length of a note.

V (velocity) field

You can set the velocity of the pad.

■ Tempo change event

Tempo change event is used to change the tempo within the sequence.

The tempo change event is different from other events. It does not belong to a specific track.

By selecting TEMPO in the View field, you can display the tempo change event information separately, regardless of the selected track. Even when you have selected ALL EVENTS in the View field, the tempo change event will not be displayed in the event list.

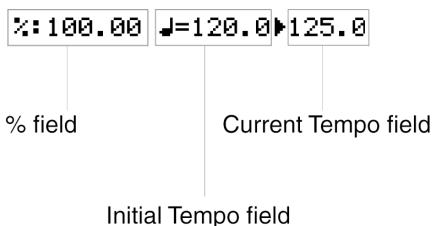

% field

You can set the amount of the tempo change.

Initial tempo field, Current tempo field

The field on the left with a note symbol is the initial tempo field. The field on the right is the current tempo field.

The initial tempo field displays the original tempo set in the tempo field of the sequence, the Current tempo field displays the new tempo changed by the setting in the % field.

■ Effect select event

This event is used to switch the effect selection within the sequence.

EFFECT SELECT:01

■ Real Time event

This is the real time event assigned on Q-Link sliders.

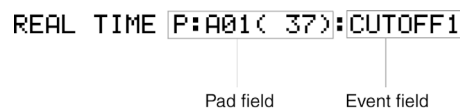

Pad field

You can set the pad number in this field.

Event field

You can set the event variation in this field.

TUNE : the pitch of the sample

CUTOFF1+2 : the cutoff frequency of both Filter 1 and Filter 2

LEVEL : the volume level of the sample

CUTOFF1 : the cutoff frequency of Filter 1

CUTOFF2 : the cutoff frequency of Filter 2

RESO 1+2 : the resonance value of both Filter 1 and Filter 2

RESO 1 : the resonance value of Filter 1

RESO 2 : the resonance value of Filter 2

PAN : the panning position

Note : Both the LEVEL and PAN events share the Q-Link value. For more information, see Page 44 "Chapter 9 : Q-Link slider".

The events described above are specific events to the MPC1000.

Below are the MIDI events that you use when using the MPC1000 as a MIDI sequencer.

Note: How a MIDI event effects an external sound module depends on the specification of the sound module. For more information about the effect of each MIDI event, see the operation manual of your sound module.

■ **Note event**

This is a MIDI note event.

N: 36(C 1) D: 14 U:127

N (Note number) field

You can set the note number in this field. A note number indicates the location on a keyboard as a numbers, with the middle C of the piano as note number 60.

D (duration) field

You can specify how long a note is held (length of a note). In the MIDI standard, pressing a key is called "Note on", releasing a key is called "Note off". In this field, you will set the time from Note on to Note off.

V (velocity) field

You can set the velocity of the note event. In the MIDI standard, the speed used to trigger a note is called velocity. The velocity is shown in 127 steps, with 127 the maximum.

■ **Pitch bend event**

You can set the pitch bend. Normally this event is used to control the pitch in real time.

PITCH BEND : 0

■ **Control change event**

The control change, which is used for various applications, is the most versatile event in the MIDI standard. The control change event consists of a control number, which determines the type of the control change, and the control change value.

CC: 1-BANK SELECT MSB : 0

CC field

You can select the type of the control change in this field, and the control change value in the field on the right.

■ **Program change event**

PROGRAM CHANGE : 1

You can set the program change. This event is normally used to switch the sound of an external sound module. If program numbers are assigned to programs in the internal sampler section, you can switch the programs that are assigned to the track within the sequence.

■ **Channel pressure event**

CHANNEL PRESSURE U: 0

You can set the channel pressure. Normally, a Channel pressure event is used for aftertouch. This feature allows you to control the sound depending on the pressure used to press the keyboard.

■ **Poly pressure event**

POLY PRESSURE : 60(C 3) U: 0

The Poly pressure event is used for aftertouch much like the channel pressure event, however the Poly pressure event can be set to different values for each individual note.

■ **Exclusive data event**

EXCLUSIVE 120Byte

Exclusive data event is used to set the sound module, or to give a more detailed setting to the sound module, which cannot be done using control changes. The MPC1000 can edit the exclusive data as well as record and play them back. However, the type of exclusive data you can receive and their functions are determined by each manufacturer.

Editing the exclusive data

An exclusive data event displays only the size of the event data and you cannot edit this event directly. To edit the exclusive data, you need to select the desired exclusive data event and press the [WINDOW] key to display the Edit Exclusive Event window.

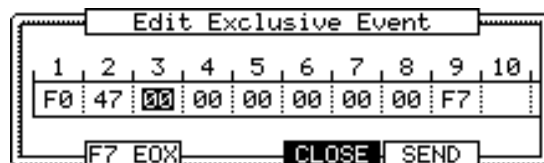

The data of each byte will be displayed. You can scroll through the display with right/left cursor keys. Select the byte that needs change, and change the setting with the DATA wheel.

To change the length of the exclusive data, press the [F2] (F7 EOX) key. Pressing the [F2] (F7 EOX) key enters "F7", which indicates the end of the exclusive data, to the selected byte.

Pressing the [F5] (SEND) key sends out the currently set exclusive data.

When you finish editing, press the [F4] (CLOSE) key and close the window.

Copying / pasting an event

To copy the selected event and paste it to another location, proceed as follows.

01. In the event list, select the event that you wish to copy.

You can select several events by pressing the down cursor key while holding the [SHIFT] key.

02. Press the [F3] (EDIT) key and the [F4] (COPY) key at the same time.

When you press the [F3] (EDIT) key, the display of the [F4] and the [F5] key will change to (COPY) and (PASTE) respectively until you release the key.



03. In the Now field, select the time position that you wish to paste the event to.

04. Press the [F3] (EDIT) key and the [F5] (PASTE) key at the same time.

The selected event will be pasted.

Moving an event

To move the selected event to another location, proceed as follows. The difference between Copy/Paste command is that the selected event is not in the original location after the Move function.

01. In the Event list, select the Event that you wish to move.

You can select several Events by pressing the down cursor key while holding the [SHIFT] key.

02. Press the [F3] (EDIT) key and the [F2] (MOVE) key at the same time.

When you press the [F3] (EDIT) key, the display of the [F2], [F4], and [F5] key will change to (MOVE), (COPY), and (PASTE) respectively until you release the key..



03. Move Event window will open.



Time= : the selected event time (the start point) is displayed. You can not change this value.

Move to : You set the time where you wish to move the selected event.

04. Press the [F5] (DO IT) key.

The selected event will be moved.

Deleting an event

To delete the selected Event, proceed as follows.

01. In the Event list, select the Event that you wish to delete.

You can select several Events by pressing the down cursor key while holding the [SHIFT] key.

02. Press the [F4] (DELETE) key.

The selected Event will be deleted.

Note : You can delete the Event by pressing the [Erase] key in Step Edit mode.



For more information, see "Chapter 3 : Sequencer feature, Erase feature" on page 14.

After done the copying / deleting an Event, you can revert back the previous status by pressing the [UNDO] key.

Entering an event (Step recording)

In the STEP EDIT mode, when you hit a pad, or when the MPC1000 receives MIDI data from an external device, you can record the event in the current time position (the time displayed in the Now field). Move the event to the desired time position by moving through the event list with the up/down cursor keys, or by setting the time position in the Now field, and you can add events to the desired time position one by one. This method, recording each event individually when MPC1000 is in the stop mode, is called step recording.

01. In the STEP EDIT mode, Press the [REC] key or the [OVER DUB] key.

The LED of the [OVER DUB] key will be lit, which indicates that you can now enter events by hitting a pad.

02. Move through the list with the up/down cursor keys, or select the Now field, to select the time position to insert event.

03. Hit a pad.

The event of the pad will be recorded.

04. Press the [STOP] key.

The LED of the [OVER DUB] key will be turned off and you can finish the step recording.

■ Detailed setting for step recording

Pressing the [WINDOW] key in the STEP EDIT mode brings up the Step Edit Options window, where you can make various settings for the step recording.

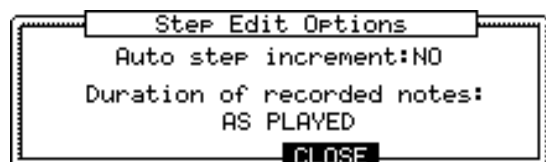

Auto step increment field

If you select YES, the MPC1000 will automatically update the sequence according to the setting of the timing correct when it receives a pad event or a note event.

Duration of recorded notes field

You can determine how the length that a pad (MIDI keyboard) is pressed affects the event to be recorded during step recording.

AS PLAYED The length that a pad (MIDI keyboard) is pressed will be applied to the event.

When you hit a pad (MIDI keyboard), the metronome sound will start automatically. Refer to the metronome sound to set the length to press a key. When you release a pad (MIDI keyboard), the length that a key was pressed will be entered in the D (duration) field.

TC VALUE% When set to 100%, the value set in the timing correct will be entered in the D (duration) field, regardless of the length that you actually pressed the pad (MIDI keyboard). Selecting the TC VALUE% will display the field, where you can set the percentage of the duration to apply to the current timing correct value. (Ex. 50% will set duration to one-half timing correct value.)

■ Inserting an event

During the step recording, you can enter events using the insert function as well as using pads and MIDI keyboard.

01. Move to the time position that you wish to insert the event, and press the [F5] (INSERT) key.

The Insert Event window will open.

02. In the Type field, select the event to insert, and press the [F5] (DO IT) key.

The selected event will be inserted.

Hint: After done the Step recording, you can go back the previous status by pressing the [UNDO] key.

Chapter 6 : Song mode

In the SONG mode, you can set the order of multiple sequences and play them in a series. The SONG mode is useful when you are creating a song by combining short sequences. You can check the structure of an entire song while working, so you can finish the song easily. You cannot record the performance in the SONG mode, you can convert the song that you created in the SONG mode to one long sequence so that you can record/edit it like you would a normal sequence.

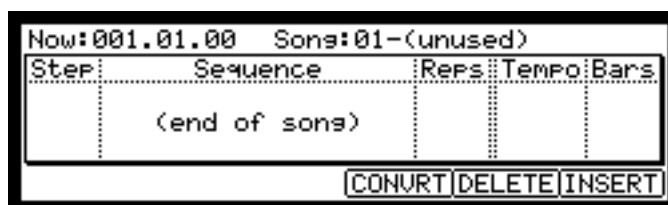

Structure of a song

The MPC1000 can handle up to 20 songs. Each song has 250 steps. You can create a song by assigning sequences to each step in the list. For each step, you can assign a sequence, and also set the number of times the MPC1000 should repeat the sequence. You can create a song in the SONG mode, which can be accessed by pressing the [MODE] key and then the [PAD 16].

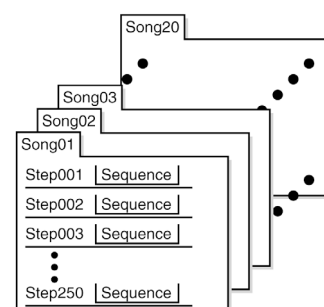

Screens

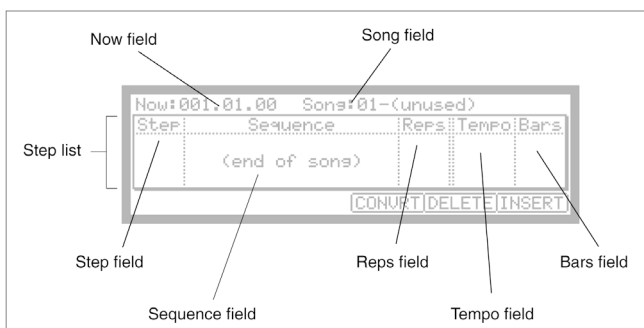

■ Step list

The list that is displayed below the Now field and the Song field is the step list, which is used to assign the sequences to each step. Pressing the down cursor key when the Now field or the Song field is selected moves the cursor to the step list. When there are many steps with different sequences assigned, you can scroll through the list with the up/down cursor keys. Pressing the left cursor key in the Step field of the step list moves the cursor to the Now field.

■ Step field

This field displays the step number. You can scroll through the list by turning the DATA wheel.

■ Sequence field

You can assign the sequences in this field by turning the DATA wheel.

■ Now field

The time display on the upper left corner on the screen is the Now field. The Now field always displays the current position of a sequence. This is the same as the Now field in the MAIN page.

■ Song field

You can set the song number in this field. The song name will be displayed to the right of the number. If there is an unused song, it is displayed as (unused).

■ Reps field

You can set the number of times to repeat the sequence.

■ Tempo field

Displays the tempo of the selected sequence. You can change the tempo of the sequence, but if you are using the same sequence in another step, the tempo of that sequence will be changed as well.

■ Bars field

Displays the number of bars of the selected sequence. This field only displays the number of bars, you cannot make any changes in this field.

Creating a song

01. Press the [MODE] key and then the [PAD 16] (SONG).
The SONG page will be displayed.

02. In the Song field, select a song whose name is (unused).

03. Move the cursor to (end of song) and select the sequence to play first using the DATA wheel.

Turning the DATA wheel creates the new step and you can select a sequence. Then the new song will be created and its name will change from (unused) to Song## (## indicates the song number).

04. In the Reps field, set the times to repeat a sequence.

The MPC1000 will repeat the sequence the number of times set here before starting to play the next step.

1 - 99 The MPC1000 will repeat the sequence the selected number of times.

HOLD The MPC1000 will repeat the sequence until you press the [F4] (SUDDEN) or the [F6] (NEXT) key.

If you set the Reps field to 0, the MPC1000 will finish the play back after the previous step. It will not play the next step.

05. Select the (end of song) field by pressing the down cursor key, and select the sequence that you want played back next.

Assign the sequences in the desired order by repeating the steps 03. and 04.

06. Press the [PLAY START] key.

The assigned sequence will be played in the selected order.

■ Deleting a step

To delete a step in the list, proceed as follows.

01. Select the step that you wish to delete.

You can select the step by using the up/down cursor keys in the step list.

02. Press the [F5] (DELETE) key.

The selected step will be deleted and the following steps will be moved forward.

■ Inserting a step

To insert a step in a song, proceed as follows.

01. In the Step list, select a step that you wish to insert a new step into.

The new step will be inserted before the selected step.

02. Press [F6] (INSERT) key.

A new step with the same contents as the select step will be inserted right before the selected step.

Playing a song

You can play the song by pressing the [PLAY START] key. To play from the middle of the song, select the position that you wish to start the playback, using the cursor, and press the [PLAY] key.

During the playback, the function key will change as follows.



[F4] (SUDDEN) key

If you press this key during the playback, the MPC1000 will skip to the next step before it finishes the current sequence.

[F6] (NEXT) key

If you press this key during the play back, the MPC1000 will skip to the next step after it finishes playing back the current sequence regardless of the number of repeats in the Reps field.

Tips : If HOLD is selected for a step in the Reps field, the MPC1000 will not go to the next step until you press the [F4] (SUDDEN) key or the [F6] (NEXT) key.

Other features in the SONG

■ Changing the song name

01. In the Song field of the SONG page, select a song that you wish to change the name of.
02. Press the [WINDOW] key.
The Song window will open.
03. In the Song name field, enter the new name.
For more information for setting the name, see the "Setting names" section on Page 10.
04. Press the [F4] (CLOSE) key.
It closes the window and goes back to the SONG page.

■ Copying a song

To copy a song to another song, proceed as follows.

01. In the Song field of the SONG mode, select a song that you wish to copy.
02. Press the [WINDOW] key.
The Song window will open.
03. Press the [F5] (COPY) key.
The Copy Song window will open.
04. In the Song field (below), select a song that you wish to copy the selected song to.
05. Press the [F3] (DO IT) key.
The MPC1000 will start copying the song. To cancel the operation, press the [F4] (CANCEL) key instead.

■ Deleting a song

To remove the selected song from the memory of MPC1000, proceed as follows.

01. In the Song field of the SONG mode, select a song that you wish to delete.
02. Press the [WINDOW] key.
The Song window will open.
03. Press the [F2] (DELETE) key
The Delete Song window will open.
04. Press the [F5] (DO IT) key.
This deletes the selected song and changes its name to "unused".

■ Deleting all the songs

You can delete all the song data in the memory at one time. Proceed as follows.

01. In the SONG mode, select the Song field and press the [WINDOW] key.
The Song window will open.
02. Press the [F2] (DELETE) key.
The Delete Song window will open.
03. Press the [F3] (ALL SG) key.
The Delete ALL Songs window will open.
04. Press the [F5] (DO IT) key.
All the songs will be titled (unused).

■ Setting all sequences to the same tempo

Each sequence has its own tempo. When you are creating a song in the Song mode, it is useful to change all the sequences to have the same tempo at once. With this feature, you can change all the sequences that you are using for a song to the same tempo at once.

01. In the Tempo field of the step list, press the [WINDOW] key.
The Tempo Change window will be displayed.
02. Press the [F5] (FIX) key.
The Fix Tempo window will be displayed.
03. In the Fix tempo field, select the desired tempo.
04. Press the [F3] (DO IT) key.
All the sequences used in the song will be set to the tempo that is set in the Fix tempo field.

■ Ignoring tempo change events in a sequence

You can set the MPC1000 to ignore tempo change events that are set set in a sequence.

01. In the Tempo field in the step list, press the [WINDOW] key.
The Tempo Change window will be displayed.

02. Select a setting in the Ignore tempo change events in sequence field.

NO The MPC1000 will execute the tempo change events in the sequence.

YES The MPC1000 will ignore the tempo change events in the sequence.

03. Press the [F4] (CLOSE) key.
This closes the window.

■ Converting a song to a sequence

You can convert a song to one long sequence. You can record or over dub to the converted sequence in the MAIN mode like other sequences. You can also edit the sequence in the STEP EDIT mode or the SEQ EDIT mode.

01. In the SONG mode, press the [F4] (CONVRT) key.
The Convert Song to Seq window will be displayed.

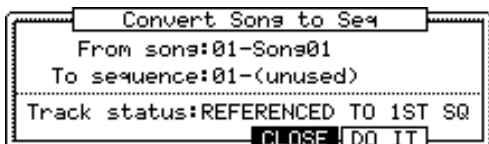

02. In the From song field, select the song that you wish to convert.

03. In the To seq field, select the destination sequence.

04. In the Track status field, select the track status after conversion to a sequence.

REFERENCED TO 1ST SQ :

The setting data (such as MIDI output, Mixer setting, Tempo, etc) of each track in the 1st Sequence of the Song will be used for all tracks in the following sequences.

MUTE TRACKS IGNORED :

The muted tracks in the sequences of the Song will not be converted.

MERGED ON MIDI CHANNEL

The track in the sequence of the Song will be merged to the track according to the MIDI output channel.

For example:

The track data of MIDI output channels 1A-16A will be merged to tracks 1-16.

The track data of MIDI output channels 1B-16B will be merged to track 17-32.

Note : If the track is set to OFF in Midi field in the MAIN page, the data in the track will not be merged after Convert Song to Seq. If you wish to convert the tracks for an internal program, set the MIDI output channel for the track temporary.

04. Press the [F5] (DO IT) key

The song will be converted to a sequence.

Note : During Song Conversion

(When selected "REFERENCED TO 1ST SQ and MUTE TRACKS IGNORED)

When you convert a song, the specific settings used in each track within the sequence, such as track type, MIDI channel setting, selection of the program, etc, will be set to the values that you set in step 1. If the track setting of the sequence in another step is different from those in the step 1, the song may not be converted properly. To avoid this, it is better to make the track settings and the order of each sequence the same. For more information on how to change the order of the tracks, see the "Changing the order of the tracks" section on page 30.

Chapter 7 : Functions of a pad

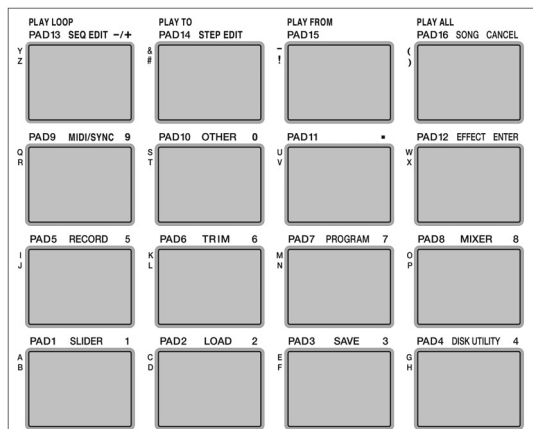

The MPC1000 has 16 drum pads. The pads perform various function besides making sounds when hit. In this section, you will learn about various functions of the pad.

Playing with pads

By assigning the sounds in memory to a pad, you can play those sounds.

Below are some useful functions when playing with pads.

■ Switching pad banks

The MPC1000 has 16 pads, but you can play up to 64 samples by switching between the four pad banks. The LED of the currently selected pad bank (from banks A through D) is turned on. By pressing the desired [PAD BANK] key, you can switch pad banks.

■ Full level function (FULL LEVEL key)

You can control the level of the sound by the velocity used to hit the pads, but if you press the [FULL LEVEL] key, the MPC1000 will play the sample at the maximum level regardless of the velocity.

If you press the [FULL LEVEL] key, the LED will be lit, and the full level function will be activated. To deactivate this function, press the [FULL LEVEL] key again.

■ 16 level function (16LEVELS key)

You can play a sound using 16 parameter levels assigned to the 16 pads.

01. Hit the pad that you wish to play in 16 levels.
02. Press the [16 LEVELS] key.

The Assign 16 Levels window will be displayed. The Pad field displays the pad you selected in step 1.

03. In the Type field, select the type of the parameter that you wish to play in 16 levels.

You can select the following parameters;

VELOCITY	The MPC1000 will play the velocity in 16 levels.
TUNE	The MPC1000 will play the pitch in 16 levels by semitone.
FILTER	The MPC1000 will play the filter cutoff value in 16 levels.
LAYER	The MPC1000 will play the layer value in 16 levels.
DECAY	The MPC1000 will play the decay value in 16 levels.
ATTACK	The MPC1000 will play the attack value in 16 levels.

When TUNE is selected, the Original key pad field will be displays. In this field, you can specify the pad that plays the original key pad.

04. Press the [F5] (TurnON) key.

The window closes and the LED of the [16 LEVELS] key is turned on, which indicates you can play in 16 levels. Pressing the [16 LEVELS] key turns its LED off and deactivates the 16 levels function.

Tips: When you select VELOCITY in the Type field, the velocity of the pad event can be played in 16 levels, but if you select an option other than VELOCITY, the note variation value will be played in 16 levels. The note variation data can change the value of a specific parameter when you play the pad's sample. For example, if you select TUNE in the Type field, when you hit the pad, the note variation data of TUNE will be sent to the sampler section with the pad event, and the TUNE value will be changed according to the pad you played.

During Sequence recording, the Note variation data will be recorded with the note event and you can play back the sequence exactly what was played. The note variation value is also used for the Q- Link slider function.

Setting the track mute with pads

You can mute/unmute tracks in real time during playback by hitting the pads. This is useful when you have several instruments assigned to different tracks, so that you can play a song and switch tracks on/off using the pads while playing back your sequence.

Pressing the [TRACK MUTE] key brings up the track mute page.



■ TRACK MUTE Screen

Now field

Like the Now field in the MAIN page, this field displays the current time position of the sequence.

Sq field

Like the Sq field in the MAIN page, you can select a sequence in this field.

Track list

The track list is displayed under the Now field and the Sq field.

The track list displays the first 8 letters of the track name. The tracks are displayed according to the position of the pads; Track 1 on the lower left and track 16 on the upper right. You can display 16 pads at one time, but you can display 1 to 64 tracks by switching pad banks. The track whose track mute is set to off will be highlighted.

Operation

Hitting a pad when the track mute page is displayed switches the track mute setting of that track instead of playing the sound.

■ Solo function

With the Solo function, you can play back only the selected track.

01. Hit the pad that corresponds to the track that you wish to play, while pressing the [F6] (SOLO) key.

The [F6] (SOLO) will be highlighted and MPC1000 will play only the selected track while it mutes the other tracks. You can switch the tracks to play, by hitting a pad.

02. Pressing the [F6] (SOLO) key deactivates the solo function.

■ Setting the track mute in solo mode

Solo function switches the track mute setting temporary. Turning off the solo function resets the track mute settings for each track to the same status as before the solo function was activated. However, you can also turn off the solo function while keeping the track mute setting unchanged. With this feature, you can make a performance starting with many tracks followed by only a simple rhythm track and then gradually add tracks.

Operation

When the solo function is on, press the [F6] (SOLO) key while holding the [SHIFT] key.

The Solo function will be deactivated and the mute setting for the track set to solo will be turned off. The setting for other tracks will be turned on.

Selecting a sequence to play with pads

You can select a sequence that you wish to play next, by hitting the pads. This is useful for live performances, which change a song structure in real time. Also, you can check the relationship between sequences while you are working on a song with several short sequences.

Pressing the [NEXT SEQ] key brings up the next sequence page.

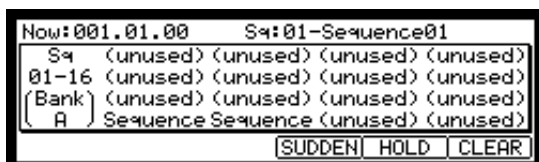

• NEXT SEQ Screens

Now field

Like the Now field in the MAIN page, it displays the current time position of the sequence.

Sq field

Like the Sq field in the MAIN page, you can select a sequence in this field.

Sequence list

The sequence list is displayed under the Now field and the Sq field.

The sequence list displays the first 8 letters of the sequence name. The sequences are displayed according to the position of the pads; Sequence 1 on the lower left and sequence 16 on the upper right. You can display 16 pads at one time, allowing you to display 1 to 64 sequences by switching pad banks.

Note: You cannot select a sequence between 65 and 99 using pads, but you can select them in the Sq field.

- Operation -

01. In the Sq field, select a sequence that you wish to play first.

02. Start to play back the Sequence.

03. Select another sequence that you wish to play next, using a pad.

The number and name of the selected sequence will be displayed below the Sequence list. The MPC1000 will switch to the next sequence after it plays the current sequence to the end.

Tips: You can change the next sequence by hitting the pads until the current sequence ends.

Tips: When no other sequence is selected, the MPC1000 will continue to playback the current sequence over and over.

Tips: You can cancel the next sequence that is displayed below the sequence list, by pressing the [F6] (CLEAR) key.

SUDDEN key

Normally, the MPC1000 will switch to the next sequence after it plays the current sequence to the end. However, you can also switch to the next sequence before the MPC1000 finishes playing back the current sequence by pressing the [F4] (SUDDEN) key. It is useful for the live performance, where you need to switch to the next phrase at a certain cue.

01. Select the next sequence with the pads, and press the [F4] (SUDDEN) key.

The MPC1000 will switch to the next sequence at the point the key is pressed.

Tips: If you press the pad while holding the [F4] (SUDDEN) key, the MPC1000 will switch to the next sequence at the point the pad is hit.

HOLD key

Normally, when the next sequence is selected, the MPC1000 will switch to the next sequence after it finishes playing the current sequence. If you press the [F5] (HOLD) key, the MPC1000 will keep playing back the current sequence until you press the [F5] (HOLD) again. It is useful for the live performance, where you wish to change the phrase according to the response of the audience.

01. Select the next sequence with the pad, and press the [F5] (HOLD) key.

The key will be highlighted and the MPC1000 will keep playing back the current sequence, instead of switching to the next sequence.

If you press the [F5] (HOLD) key again, the Hold function will turn off and the MPC1000 will switch to the next sequence after it finishes playing back the current sequence.

Tips: If you press the [F4] (SUDDEN) key when the hold function is on, the MPC1000 will switch to the next sequence right away.

Chapter 8 : Q-Link slider

By using the Q-Link sliders, you can control certain pad parameters (filter, tune, etc...) with a slider or knob. There are two ways (NOTE ON and REALTIME) for controlling the sound by Q-Link.

NOTE ON, the sound will be affected to the position of Q-LINK slider at the point the Pad is hit. But the sound will not be affected by changing the Q-Link sliders after hitting the pad. REALTIME, you can change the sound during playing back by changing the Q-LINK slider.

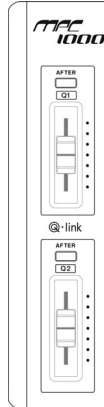

In this section, you will learn how to set the Q-Link sliders. This is done in the SLIDER mode, which can be accessed by pressing the [MODE] key and then the [PAD 1] (SLIDER) key. The SLIDER mode has 2 pages, [F1] (Q1) and [F2] (Q2), and you can set the Q-Link slider 1 and 2 separately.

Setting the slider

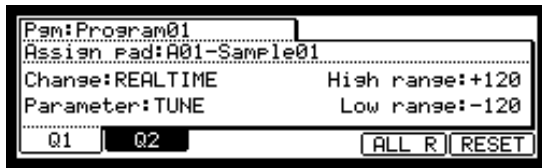

01. In the Assign pad field, select the pad to which you wish to assign Q-Link by hitting it.

The effect of the slider will be applied to the selected pad. If you do not wish to use the Q-Link function for any pad, select OFF by turning the DATA wheel.

02. In the Change field, select the condition for changing the parameter.

NOTE ON : The setting value of the Q-LINK slider at hitting the pad affects to the sound. If you change the Q-LINK slider while the sound is playing back, the sound will not be changed. The information of the slider position will be sent to the sampler section as Note Variation data. The Note Variation data is included in the Pad Event and converts the specific parameter value to slider position data. For example,

when you select TUNE as a parameter, by moving the slider, you can affect the sample tune.

REAL TIME : If you change the Q-LINK slider while the sound is playing backs, the sound will be changed. When REAL TIME is selected, the information of Q-LINK slider is recorded as a Q-LINK event, not as Note Variation data.

03. In the Parameter field, select the parameter you wish to control.

• When the REAL TIME is selected in the Change field

TUNE : This controls the sample's pitch.
LEVEL : This controls the sample's volume level.
CUTOFF1+2 : This controls the cutoff frequency of both Filter 1 and Filter 2.
CUTOFF1 : This controls the cutoff frequency of Filter 1.
CUTOFF2 : This controls the cutoff frequency of Filter 2.
RESO1+2 : This controls the resonance value of both Filter 1 and Filter 2.
RESO1 : This controls the resonance value of Filter 1.
RESO2 : This controls the resonance value of Filter 2.
PAN : This control the sample's pan position.

• When the NOTE ON is selected in the Change field

TUNE : This controls the sample's pitch.
FILTER : This controls the cutoff frequency Filter.
LAYER : This allows you to alter the HIGH and LOW Range at which the Event will be triggered.
ATTACK : This controls the attack time of the Amp Envelop.
DECAY : This controls the decay time of the Amp Envelope.

04. In the High range field and Low range field, set the upper and lower limit of the sliders.

The value of the controlled parameter is determined by the value set here. The value depends on the type of the parameter selected in the Parameter field.

TUNE :

-120 - +120 This controls the sample pitch with "10" equals a semitone.

LEVEL : 0 -100

This control the sample volume level.

CUTOFF1+2 / CUTOFF1 / CUTOFF2 : -50 - +50

This offsets the cut off frequency of the currently selected filter. The value set in the PROGRAM mode is used as 0.

RESO1+2 / RESO1 / RESO2 : -50 - +50

This offsets the resonance of the currently selected filter. The value set in the PROGRAM mode is used as 0.

LAYER : 0 - 127

This value switches layers instead of Velocity.

ATTACK : 0 - 100

The attack time of the envelope will be replaced with this value.

DECAY : 0 - 100

The decay time of the envelope will be replaced with this value.

Note : When you change the LEVEL or the PAN on REAL TIME by Q-Link slider, some noise may occur depending on the sound.

■ Resetting the Q-Link slider value

You can reset (back to the original value) the altered value of Q-Link slider.

Example : When you control the Tune of the Pad Event with REAL TIME, the Tune will keep the changed value after you change the Q-Link slider. If you press the [F5] (ALL R) key or the [F6] (RESET) key, the changed value resets to its original value.

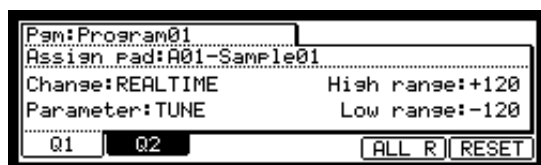

[F5] (ALL R) : All parameter changed with REAL TIME resets to the original value.

[F6] (RESET) : Only the parameter being displayed in Slider page resets to the original value.

Recording the slider value in a sequence

When you use the Q-Link slider while recording a sequence, the Note Variation data will be recorded into the track of the sequence.

When the NOTE ON is selected in the Change field, the value of the Q-Link slider will be recorded as Note Variation information with the Pad Event.

When the REAL TIME is selected in the Change field, the value of the Q-Link slider will be recorded as Q-Link event, independent of the Pad Event.

AFTER key

This key sets the operation of the Q-Link slider, when a sequence is recorded, the Note Variation data is played back.

The operation of the [AFTER] key is different with "NOTE ON" or "REAL TIME".

When the "NOTE ON" is selected,

If the [AFTER] key is OFF, (the LED is off), if you move the Q-Link slider while playing back a sequence with Note Variation, the Pad's Note Variation is played as recorded. If you hit a Pad during playback, the Pad that you hit will have the effect of Q-Link slider.

If the [AFTER] key is ON (the LED is lit.), if you move the Q-Link slider while playing back a sequence with Note Variation, the Note Variation value will be replaced with the current position of the Q-Link slider.

When the "REAL TIME" is selected,

If the [AFTER] key is OFF, (the LED is off), if you move the Q-Link slider while playing back a sequence with Note Variation, the recorded Pad's sound will be changed.

If the [AFTER] key is ON (the LED is lit.), the recorded Q-Link Event will be ignored and the current Q-Link slider position will be used while playing back a sequence with Note Variation.

While recording a sequence,

If the [AFTER] key is OFF, when you move the Q-Link slider, the new Q-Link Event will be recorded and added to the existing Q-Link Events.

If the [AFTER] key is ON, when you move the Q-Link slider, the new Q-Link event will be recorded and will erase any previous Q-Link Events.

Other features of Q-Link slider

Q-Link slider also have the following features.

■ Feature in MIXER mode

In the L/PAN page in the MIXER mode, the Q-Link slider work as follows :

Q1 slider : This can control the level of the selected pad.

Q2 slider : This can control the pan of the selected pad.

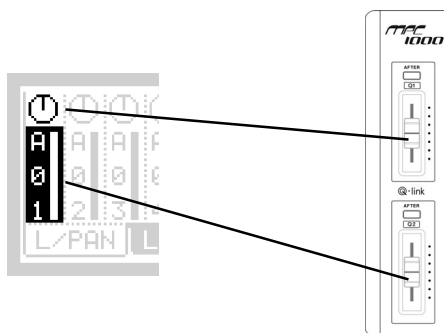

■ Feature in TRIM mode

In the TRIM page and LOOP page within TRIM mode, holding in the [AFTER] key while manipulating the Q-Link sliders.

[AFTER] key + Q1 slider

TRIM page : This can adjust the start point.

LOOP page : This can adjust the loop start point.

[AFTER] key + Q2 slider

TRIM page : This can adjust the end point.

LOOP page : This can adjust the loop end point.

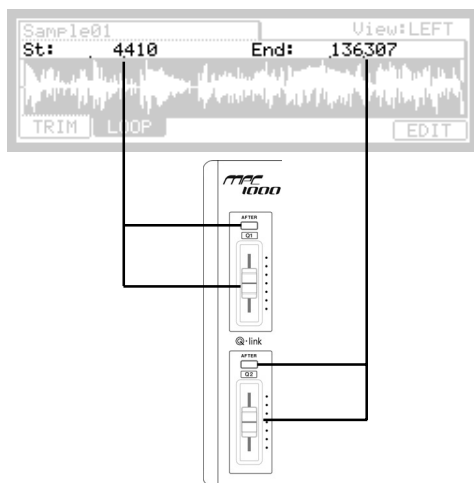

Chapter 9 : Using the MPC1000 with external devices

In this section, you will learn how to sync the MPC1000 to the other MIDI devices using MIDI clock. MIDI clock is a function of the MIDI standard and allows several MIDI devices to synchronize. If your MIDI device supports MIDI clock, you can use the device and the MPC1000 in sync. If you are not sure if your MIDI device supports MIDI clock or not, refer to the device's operation manual.

Sync with the MPC1000 as the master

When you play the MPC1000's sequence, the connected MIDI device will follow. MIDI clock data will be sent from the MPC1000 to the connected MIDI device. In this case, the MPC1000 is called the "master", and the connected MIDI device the "slave".

01. Connect the MIDI OUT of the MPC1000 to MIDI IN of the external MIDI device using a MIDI cable.

The MPC1000 has two MIDI OUTs: MIDI OUT A, MIDI OUT B, MIDI OUT C, and MIDI OUT D. You can connect to any MIDI output, but for this example connect to the MIDI OUT B.

02. Select the MIDI/SYNC mode by pressing the [MODE] key and hitting the [PAD 9] (MIDI/SYNC).

03. Press the [F2] (SYNC) key.

The SYNC page will be displayed.

04. Select the Sync out field and then select the output of the MIDI clock.

You can send out MIDI clock from any of MIDI OUT A or B. When you select "AB", MIDI clock is sent from both MIDI OUT A and B. In this example, since you have connected the external MIDI device to MIDI OUT B in step 1, select MIDI OUT B.

05. Press the [MAIN] key.

The main page, where you play back the sequence, will be displayed.

06. Set the external MIDI device to receive the MIDI clock.

Refer to the device's operation manual.

07. Press the [PLAY START] key.

The MPC1000 starts playback and the external MIDI device should start playback at the same time.

Sync with the MPC1000 as the slave

The external MIDI sequencer triggers the MPC1000. When the external MIDI sequencer starts playback, the MPC1000 starts playback as well. The MIDI clock is sent from the external MIDI sequencer to the MPC1000. In this case, the external MIDI sequencer works as the master, and the MPC1000 as the slave.

01. Connect the MIDI IN of the MPC1000 to MIDI OUT of the external MIDI device using the MIDI cable.

The MPC1000 has two MIDI Ins: MIDI IN 1 and MIDI IN 2. You can connect to either MIDI IN, but here, connect to the MIDI IN 2.

02. Select the MIDI/SYNC mode by pressing the [MODE] key and hitting the [PAD 9] (MIDI/SYNC).

03. Press the [F2] (SYNC) key.

The SYNC page will be displayed.

04. Select the "Sync in" field and select the input of the MIDI clock.

You can receive the MIDI clock from both MIDI IN 1 and 2. In this example, as you have connected the external MIDI device to MIDI IN 2 in step 1, select MIDI OUT 2.

05. Press the [MAIN] key.

The main page, where you play back the sequence, will be displayed.

06. Set the external MIDI device to send out the MIDI clock. Refer to the device's operation manual.

07. Start the playback of the external MIDI sequencer.

The MPC1000 starts the playback as well. (EXT) will be displayed in the  (Tempo) field.

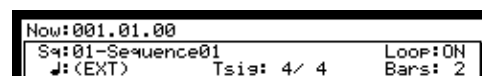

Note: The tempo being set in the sequence will be displayed during stopping the sequence.

Note: The MIDI clock signal has tempo information. The slave device will follow the master device's tempo regardless of its original tempo.

Note: The MIDI clock signal does not have time information. If the time settings of the master and the slave are different, they will still play in sync but their time position display may be different.

Connecting the MPC1000 to the MIDI keyboard with the sound module

In this section, you can learn how to connect the MPC1000 to a MIDI keyboard which has an internal sound module to use the MPC1000's sequencer feature.

Normally, The MIDI keyboard with the sound module is set to generate the sound from the internal sound module when you play the keyboard. However, The MPC1000 sends out any incoming MIDI signals to the MIDI keyboard at the MIDI output. So, if you play the keyboard, the performance will be played in duplicate. To use the MPC1000 as a sequencer, you need to change the setting on the MIDI keyboard so that the MPC1000, not the MIDI keyboard, plays the keyboard's internal sound module.

Normally this could be done by changing the setting called "local control". By setting the MIDI keyboard's local control to OFF, you can use the external keyboard and its internal sound module separately.

In this case, the MIDI signal flows as in the figure in the right.

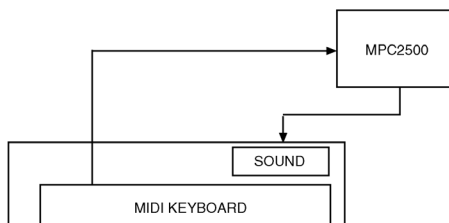

The performance data from the MIDI keyboard will be entered to the MPC1000.

It will not be sent to the internal sound module.

The MIDI output of the MPC1000 will be sent back to the MIDI keyboard, which will play the keyboard's sound module.

For more information about the setting of your MIDI keyboard's local control, see the keyboard's operation manual.

If your MIDI keyboard does not have a local control setting, deactivate the MPC1000's soft through function. In this case, the MPC1000 will output only the data that is recorded on the track, not the incoming MIDI signal.

However, if you do this, you cannot use some MPC1000 features, such as note repeat.

01. Select the MIDI/SYNC mode by pressing the [MODE] key and hitting the [PAD 9] (MIDI/SYNC).

02. Press the [F1] (MIDI) key.

The MIDI page will be displayed.

03. Select the Soft thru field and select OFF.

The soft thru field determines how to output the incoming MIDI signal.

You can select the following options:

- OFF The MPC1000 will not output the incoming MIDI signal.
- AS TRACK The MPC1000 refers to the MIDI channel setting of the sequence's track. The channel information of the incoming MIDI signal will be replaced with the MIDI channel selected the track.
- OMNI- A The MPC1000 will output the incoming MIDI data as it is from MIDI OUT A.
- OMNI- B The MPC1000 will output the incoming MIDI data as it is from MIDI OUT B.
- OMNI- AB The MPC1000 will output the incoming MIDI data as it is from both MIDI OUT A and B.

Setting the MIDI input

Normally, the MPC1000 can receive the incoming MIDI data regardless of the MIDI channel, so you do not have to worry about the MIDI channel of the connected MIDI devices. You can change the setting to receive only the data on a specific MIDI channel.

01. Select the MIDI/SYNC mode by pressing the [MODE] key and hitting the [PAD 9] (MIDI / SYNC).

02. Press the [F1] (MIDI) key.

The MIDI page will be displayed.

03. Select the Active track receive channel field and select the MIDI channel from which you wish to receive the data.

If you set this field to ALL, the MPC1000 will receive all channels. If you select any channel from 1 to 15, the MPC1000 will receive only the selected channel.

Cutting off the internal sound from a Pad (Setting Local Control)

You can cut off the internal sound from a Pad. When the “Pad to Internal sound “ field to OFF, the pad information does not come from an internal sound but is sent out from MIDI OUT. The internal sound can be played by incoming MIDI IN signal from the external MIDI device.

01. Select the MIDI/SYNC mode by pressing the [MODE] key and hitting the [PAD 9] (MIDI/SYNC).
02. Press the [F1] (MIDI) key.
03. Select the “Pad to internal sound” field and use the DATA wheel to select “OFF” .

Changing a sequence by Program Change from an external device

The MPC1000 can change to a different sequence by MIDI Program Change message from an external MIDI device.

01. Select the MIDI/SYNC mode by pressing the [MODE] key and then hitting the [PAD 9] (MIDI/SYNC).
02. Press the [F1] (MIDI) key.

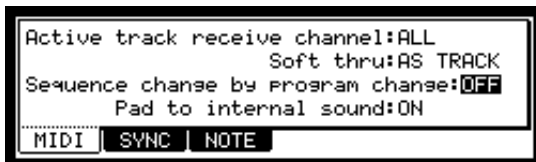

03. Cursor down to the “Sequence change by program change” field and use the DATA wheel to chose “ON”.
The sequence of the same number as the incoming Program Change number will be selected.

Chapter 10 : Recording a sample

In this chapter, you will learn how to record from an analog external device (CD player's analog output, microphone, etc...) so that you can play the sound by hitting the pads.

■ Preparing the recording

01. Connect the external device to the RECORD IN, which is located on the MPC1000's rear panel.

The format of the analog input of the MPC1000 is standard phone jack. If your device's format is different, you will need an adapter.

02. Press the [MODE] key and then [PAD 5] (RECORD).

When you press the [MODE] key, its LED will blink. Pressing [PAD 5] with the [MODE] key's LED on displays the RECORD page, where you set the setting for the recording.



03. Select the Input field, and select the recording source.

ANALOG The MPC1000 will record the incoming signal from the RECORD IN on the rear panel.

DIGITAL The MPC1000 will record the incoming signal from the DIGITAL IN on the rear panel.

MAIN OUT The MPC1000 will record the same signal with the signal from the STEREO OUT on the rear panel.

For this example, please select ANALOG.

04. Select the Mode field and select STEREO or MONO.

STEREO The MPC1000 will record the left and right channel signals as a stereo sample.

MONO L The MPC1000 will record only the left channel signal.

MONO R The MPC1000 will record only the right channel signal.

05. Play the source. Check the level meter on screen and adjust the recording level using the [REC GAIN] knob.

Note: When you select DIGITAL or MAIN OUT in the Input field, you cannot adjust the recording level with the [REC GAIN] knob.

The level meter moves according to the input level. If the meter goes too far to the right, the sound will be distorted, but if the sound level is too low, the sample will gain a lot of noise. Set the level as high as possible without reaching the right edge (clip).

06. Select the Threshold field and set the threshold level to start the recording.

When the MPC1000 is in the recording enable mode, it starts the recording automatically when the level of the incoming source exceeds the threshold level. If you set the threshold level too high, the MPC1000 may not start the recording when you play the input source, or the beginning of the recording may be missing. If you set the threshold level too low, the MPC1000 may start the recording before you play the external source. Set this to the appropriate level using the level meter. The threshold level will be indicated as "□" as the figure below.

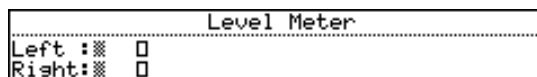

07. Select the Time field and set the recording time.

The MPC1000 will record for the time set in this field. We recommend you set the time a little longer than the actual recording time. You can finish the recording manually.

■ Starting the recording

08. Press [F6] (RECORD) key.

The MPC1000 will be in the record ready mode, and the bottom of the screen will change as below.

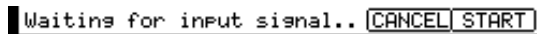

This indicates that the MPC1000 is waiting for the incoming signal. It starts the recording when the input signal exceeds the threshold level.

Pressing the [F5] (CANCEL) key cancels the record ready mode and resets the MPC1000.

Pressing the [F6] (START) key starts the recording, even when the incoming signal does not exceed the threshold level.

Note: If you press the [F6] (RECORD) key when the external source is higher than the threshold level, the MPC1000 will start the recording right after you press the [F6] (RECORD) key.

09. Play the external source.

The MPC1000 will start the recording automatically when the level of the input signal exceeds the threshold level. During the recording, the bottom of the screen will change as below:

Recording...

CANCEL STOP

The MPC1000 stops the recording at the time set in the Time field.

You can stop the recording manually before the time set in the Time field, by pressing the [F6] (STOP) key.

To cancel the recording, press the [F5] (CANCEL) key.

After the MPC1000 ends the recording, the Keep or Retry window will be displayed.

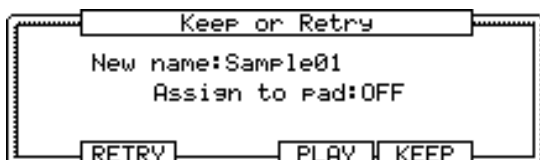

10. Check the recorded sample by pressing [F4] (PLAY) key.

If you press the [F4] (PLAY) key, you can play back the recorded sample until you release the key.

If you do not like the recording, you can remove the recording and return to the RECORD page by pressing the [F2] (RETRY) key. If you like the recording and decide to keep it, proceed to the next step.

11. Select the New name field with the cursor, and set the name for the sample.

In the New name field, the recorded sample will have a new name automatically. You can select the New name field with the cursor and change the sample name if needed. For more information about setting the sample name, see the "Setting names" section on page 10.

12. Select the Assign to pad field with the cursor and select the pad to which you wish to assign the sample.

You can select the pad directly by hitting the pad when the cursor is in the Assign to pad field. If you just wish to keep the recorded sample in the MPC1000's memory and not to assign to the pad, select OFF with the DATA wheel.

13. Press the [F5] (KEEP) key.

This closes the Keep or Retry windows and goes back to the RECORD page.

Note: The recorded sample will be removed when you switch the unit off. To keep the sample, you need to save on a memory card or import it to a PC. For more information about saving the data, see the "Save / Load" section on page 89 or see the "Connecting the MPC1000 to your computer" section on page 98.

Recording the sample - detailed information

In this section, you will learn about several features regarding the recording which were not described in the "Recording the sample" section.

Recording the digital signal

Here, you will learn how to record a digital signal.

Note: You can record only from the devices whose sampling rate is set to 44.1kHz (ex. CD player). The MPC1000 does not support the other sampling rates.

Note: The format of the MPC1000's digital input is coaxial type. If your digital device has an optical output, you cannot connect it to the MPC1000 directly. You will need an adapter.

■ Preparing the recording

01. Connect the external device to the DIGITAL IN which is located on the MPC1000's rear panel.

02. Press the [MODE] key and then [PAD 5] (RECORD) to display the RECORD page.

03. Select the Input field and select DIGITAL.

When you select DIGITAL, a digital device MUST be connected to the MPC1000.

04. Select the Mode field and select STEREO or MONO.

05. Play the source. Check the level meter on screen.

Note: With the digital recording, you cannot adjust the recording level.

06. Select the Threshold field and set the threshold level to trigger the recording.

07. Select the Time field and set the recording time.

For the next steps, proceed as described in the "Starting the recording" section on page 50.

Recording the MAIN OUT

In this section, you will learn how to record the same signal found on the STEREO OUT of the MPC1000. With this feature, you can add the effects to the recorded sample and re-record it, or you can record the phrase that you created with the sequence feature, as one sample.

■ Preparing the recording

01. Prepare the system so that you can play the desired sound by hitting the pads or playing back the sequence.

The sound that the MPC1000 will actually record is exactly the same as the sound from the STEREO

OUT. Before going back to the RECORD mode, set the program and sequence so that the desired sound will be output from the STEREO OUT.

02. Press the [MODE] key and then [PAD 5] (RECORD) to display the RECORD page.
03. Select the Input field and select MAIN OUT.
04. Select the Mode field and select STEREO or MONO.
05. Select the Time field and set the recording time.

Note: When the MAIN OUT is selected, you cannot adjust the recording level. When the MAIN OUT is selected, the recording level is decided by the setting of Master level in the GLOBAL page of the OTHER mode. The initial setting of the Master level is -12dB as the output sound will not distort when many samples are played back simultaneously. If you record one sample through MAIN OUT with this setting, the recorded sample level is lower than the original sample level. In this case, if you set the Master level to 0dB , the recorded sample level is same as the original sample level.

Note: When MAIN OUT is selected, the level meter is not displayed.

For the next steps, proceed as described in the “Starting the recording” section on page 50.

of the incoming signal. However, the peak hold displays the maximum level and keep the level even when the level decreases.



To reset the peak hold display, press the [F1] [F2] (RESET PEAK) key in the RECORD page.

■ Sample Memory Window

When you press the [WINDOW] key in the RECORD page, the Sample Memory window will be displayed.



The Free memory field displays the time you can record with the current memory. Below it, the status of the memory is indicated as bar graph.

Below the bar graph, the total amount of the RAM in the MPC1000 is displayed.

Other Features

■ Monitoring feature

In the Monitor field of the RECORD page, you can determine if you want to monitor the input signal (output the signal from the STEREO OUT) in RECORD mode or not.

- ON You can monitor the input signal. This is useful when you record sounds directly from the CD player.
- OFF You cannot monitor the input signal. For example: when you send the signal to the MPC1000 through a mixer, both the source sound and the monitored sound may be sent to the mixer. To avoid this, you should set this to OFF.

■ Peak hold/Reset peak feature

The level meter in the RECORD page has the peak hold feature. This is a useful feature for adjusting the signal level during recording. Normally, the display of the level meter changes in real time according to the level

Chapter 11 : Editing a sample

In this section, you will learn about the TRIM mode, where you can set the sample's start/end points, or the loop.

Setting the start / end points for the sample

The start/end points sets the part of the sample data, which will actually be played back. The recorded sample may have an unnecessary part at the beginning, which may make it more difficult to place the sound in the correct spot timing when hitting the pad. You can fix this problem by adjusting the start point. You can also adjust both the start and end points to play only a part of the phrase. If the sample has empty parts at the end, which consumes unnecessary memory, you can delete the empty parts by adjusting the end point and using the edit feature.

Start/end points are displayed in sample points. The sample point is the minimum unit used for sample editing. The MPC1000 has the 44100 sample points per second.

■ About the waveform display

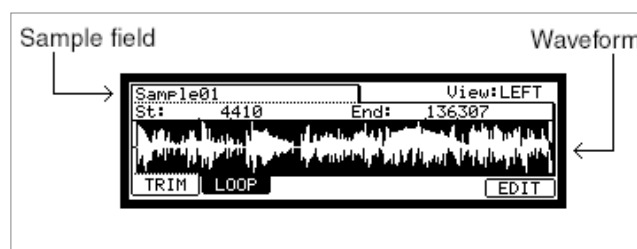

The TRIM page displays the waveform of the sample selected in the Sample field.

It displays the waveform of the whole sample, with the parts set by start/end points highlighted. If you select a stereo sample, you can select the channel (LEFT/RIGHT) to display in the View field.

■ Adjusting the start point

01. Press the [MODE] key and then the [PAD 6] (TRIM).

When you press the [MODE] key, its LED will blink. Press the [PAD 6] while the [MODE] key's LED is blinking to display the TRIM page.

02. Select the Sample field and select a sample you wish to edit.

The Sample field is located in the upper left corner of the screen, which displays the sample name. It displays the waveform of the selected sample.

03. Select the St (start) field and adjust the start point.

You can change the start point by turning the DATA wheel.

If you press the left/right cursor key while holding the [SHIFT] key, you can select the digit with the DATA wheel.

You can also enter the value directly with using the [NUMERIC] key and pads. When you press the [NUMERIC] key, its LED will blink, which indicates you can enter number with pads.

04. Hit the pad to check the start point.

When you hit the pad, the MPC1000 plays the sample. The playback method varies depending on the pad.

If you hit the [PAD 14] (PLAY TO), the MPC1000 will play the sample before the start point.

If you hit the [PAD 15] (PLAY FROM), the MPC1000 will play the sample from the start point.

If you hit the [PAD 16] (PLAY ALL), the MPC1000 will play the whole sample regardless of the start/end point settings.

If you hit any pad from the [PAD 1] to [PAD 12], the MPC1000 will play from the start point to the end point.

■ Adjusting the end point

05. Select the End field and adjust the end point.

You can change the end point by turning the DATA wheel.

If you press the left/right cursor key while holding the [SHIFT] key, you can select the digit with the DATA wheel.

You can also enter the value directly with using the [NUMERIC] key and pads. When you press the [NUMERIC] key, its LED will blink, which indicates you can enter number with pads.

→ Next page

06. Hit the pad to check the end point.

When you hit the pad, the MPC1000 plays the sample. The playback method varies depending on the pad.

If you hit the [PAD 14] (PLAY TO), the MPC1000 will play the sample until the end point.

If you hit the [PAD 15] (PLAY FROM), the MPC1000 will play the sample from the end point.

If you hit the [PAD 16] (PLAY ALL), the MPC1000 will play the whole sample regardless of the start/end point settings.

If you hit any pad from the [PAD 1] to [PAD 12], the MPC1000 will play from the start point to the end point.

■ Zooming in/out of the waveform

With the Fine window, you can zoom in to a part of the waveform and edit the part in details. Press the [WINDOW] key in the TRIM page, when the cursor is either in the St (Start) or End field, and the Fine window will be displayed.

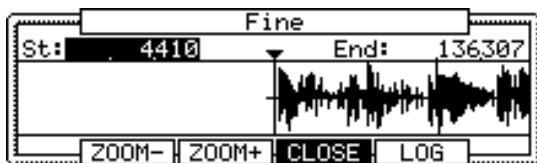

In the Fine windows, the waveform display varies depending on the location of the cursor. When you select the St (Start) field with the cursor, it displays the start point in the center of the window. When you select the end field, it displays the end point in the center.

If you press the [F2] (ZOOM-) key the waveform will be zoomed out, if you press the [F3] (ZOOM+) key, it will be zoomed in.

■ LINEAR and LOGARITHMIC displays

The vertical axis indicates the sample's level. Normally, the waveform display is set to LINEAR, which displays the sample level as it is. However, some parts (fade out part etc...) may not be displayed in the waveform if the level is too low. In this case, you can switch to the LOG (logarithmic) display by pressing the [F5] (LOG) key and you can see the parts whose level is low. When you switch to the LOG mode, the display in the [F5] key will change to LINEAR. To switch back to the LINEAR mode, press the [F5] key again.

Deleting an unnecessary part from a sample (DISCARD)

The MPC1000 plays back only the part of the sample from the start point to the end point. The parts outside these points are not used for the playback. With the Discard function, you can delete these unnecessary parts and save the memory space.

01. Adjust the start/end points.

Set the points so that the MPC1000 plays back only the necessary part.

02. Press the [F6] (EDIT) key.

The Sample Edit window will be displayed.

03. In the Edit field, select DISCARD.

04. Press the [F5] (DO IT) key.

The data outside the start/end points will be deleted. The deleted data will be returned to the available memory.

Deleting a selected range from sample and moving the data after the end point towards the start point. (DELETE)

01. Adjust the start/end points.

Set the range so that you wish to delete with the start/end point.

02. Press the [F6] (EDIT) key.

The Sample Edit window will be displayed.

03. In the Edit field, select DELETE.



04. Press the [F5] (DO IT) key

The Keep or Retry window will be displayed.

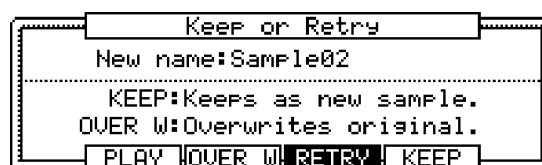

New name field : Set the name for the new sample

[F2] (PLAY) : You can audition the new sample.

[F3] (OVER W) : You can delete the original sample and keep the new sample by pressing this key. The sample name remains.

[F4] (RETRY) : This will return to the Sample Edit window without keeping the new sample.

[F5] (Keep) : Allows you to save the new sample. You can also name the sample in the New name field.

Silencing a range selected from a sample (SILENCE)

01. Adjust the start/end points.

Set the range you wish to silence with the start/end point.

02. Press the [F6] (EDIT) key.

The Sample Edit window will be displayed.

03. In the Edit field, select SILENCE.



04. Press the [F5] (DO IT) key

The Keep or Retry window will be displayed.

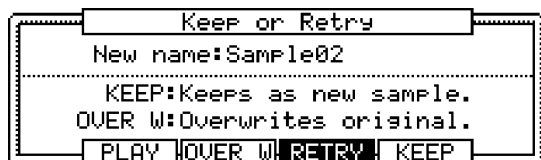

New name field : Enter a name for the new sample.

[F2] (PLAY) : You can audition the new sample.

[F3] (OVER W) : You can delete the original sample and keep the new sample. The sample name remains.

[F4] (RETRY) : This returns to the Sample Edit window without keeping the new sample.

[F5] (Keep) : Allows you to save the new sample. You can also name the Sample In the New name field.

Saving part of a sample as a new sample (EXTRACT)

You can extract the part of the sample set with the start/end points, as a new sample. For example, you can extract the snare sounds from the recorded drum loop and save it as a new sample to use it separately.

01. Adjust the start/end points.

Set the desired part with the start and end points.

02. Press the [F6] (EDIT) key.

The Sample Edit windows will be displayed.

03. In the Edit field, select EXTRACT.

04. In the New name field, set the name for the new sample.

05. Press the [F5] (DO IT) key.

The part between the start/end points will be saved as a new sample.

Sample window features

Pressing the [WINDOW] key in the sample field bring up the Sample window. In the Sample window, you can make several settings for the selected sample.

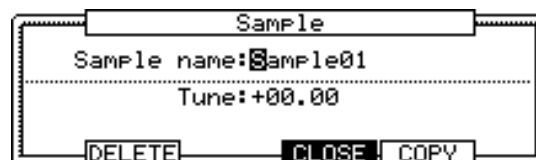

■ Changing the sample name

01. In the Sample field in the TRIM page, select a sample that you wish to change the name of.

02. Press the [WINDOW] key.

The Sample windows will open.

03. In the Sample name field, enter the new name.

For more information for setting the name, see the "Setting names" section on Page 10.

04. Press [F4] (CLOSE) key

It closes the window and goes back to TRIM page.

■ Changing the pitch of a sample

In the Tune field, you can set the sample's pitch. The 2 digits in the left is semitones, the 2 digits in the right is cents (100 cents = 1 semitone). You can change the pitch in the PROGRAM mode as well. The changes you

made in the Sample window will be applied to the actual sample. So if you assign one sample to several pads, or use one sample in several programs, the change will be applied to all of them. To change the sample of a specific pad, use the PROGRAM mode.

■ Copying a sample

You can copy a sample and create a new sample.

01. In the Sample field in the TRIM mode, select a sample to copy.
02. Press the [WINDOW] key.
The Sample window will open.
03. Press the [F5] (COPY) key.
The Copy Sample window will open.
04. In the New name field, set the name to the newly created sample.
For more information regarding setting the name, see the "Setting names" section on Page 10.
05. Press the [F3] (DO IT) key.
The MPC1000 will start copying the sample. To cancel the operation, press the [F4] (CANCEL) key instead.

■ Deleting a sample

You can remove a sample from the memory of the MPC1000.

01. In the Sample field in the TRIM mode, select a sample to delete.
02. Press the [WINDOW] key.
The Sample window will open.
03. Press [F2] (DELETE) key.
The Delete Sample window will open.
04. Press [F5] (DO IT) key.
This deletes the sample you have selected.

■ Deleting all samples

You can delete all the sample data in the memory at one time.

01. In the TRIM page, select the Sample field and press the [WINDOW] key.
The Sample window will open.
02. Press [F2] (DELETE) key.
The Delete Sample window will open.
03. Press [F3] (ALL) key.
The Delete ALL Samples window will open.
04. Press [F5] (DO IT) key.
This deletes all the samples from the MPC1000's memory.

Other editing functions

■ NORMALIZE

When you assign a sample recorded at low level, its playback level will also be low. You can set the levels of pads in the MIXER mode, but you have to set some pads to a lower level. With the normalize function; you can increase the sample level to the highest level possible without being distorted.

01. In the sample field, select the sample you wish to adjust the level of.
02. Press the [F6] (EDIT) key.
The Sample Edit window will be displayed.
03. In the Edit field, select NORMALIZE.
04. Press the [F5] (DO IT) key.
Normalizing will start. It may take some time to process depending on the length of the sample.

■ REVERSE

Allows you to reverse the selected sample.

01. In the sample field, select the sample you wish to reverse.
02. Press the [F6] (EDIT) key.
The Sample Edit window will be displayed.
03. In the Edit field, select REVERSE.
04. Press the [F5] (DO IT) key.
The MPC1000 will begin processing the sample . It may take some time to process depending on the length of the sample.

■ TIME STRETCH (Changing the length of the sample)

With the Time Stretch function, you can lengthen or shorten the selected sample without changing the pitch. This is useful when you want to match one sample to another which has different tempo.

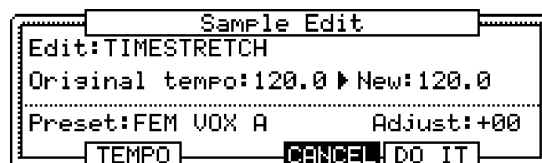

01. In the sample field, select the sample you wish to TIME STRECH.
02. Press the [F6] (EDIT) key.
The Sample Edit window will be displayed.

03. In the Edit field, select TIMESTRETCH.
04. In the Original tempo field, set the new tempo you would like to TIME STRECH the sample to.

In the Original tempo field, the tempo of the selected Sequence is already displayed.

If you do not know the tempo of the selected sample, you can use the DETECT TEMPO page to find out the tempo.

• Using the DETECT TEMPO

- I. Set the start point and the end point of the sample to match to the length of one bar at 4/4.

In the Sample Edit window, press the [F2] (TEMPO) key.

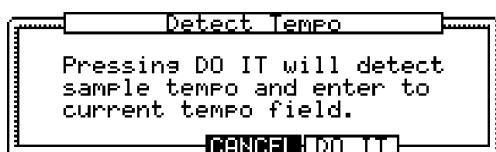

- II. Press the [F5] (DO IT) key.

The window will go back to the Sample Edit window and the calculated tempo in the DETECT TEMPO will be set automatically in the Original Tempo field.

Note : Depending on the sample, the DETECT TEMPO may not be able to detect the the correct tempo.

05. In the new field, set the desired new tempo.

Tips : If you want to change the sample length with %, you can use the following method. For example, if you wish to lengthen the sample by 120%, you set the original tempo to 100, then set the new tempo to 120. Now you can get the 120% longer sample.

06. In the Preset field and Adjust field if necessary.

Preset : The MPC1000 uses 18 preset algorithms to carry out the timestretch process, so you can select a preset that nearest resembles your sample's content. If the results are not to your liking, try experimenting with different presets.

Each preset is divided into A, B or C:

A : Standard quality timestretch with fast processing.

B : Better quality timestretch with slower processing.

C : Highest quality timestretch with even slower processing.

Time stretch Presets :

01. FEM VOX (Female voice)
02. MALE VOX (male voice)
03. LOW MALE VOX (low male voice)
04. VOCAL

05. HFREQ RHYTHM (High frequency Rhythm section)
06. MFREQ RHYTHM (Middle frequency Rhythm section)
07. LFREQ RHYTHM (Low frequency Rhythm section)
08. PERCUSSION
09. LFREQ PERC. (Low frequency Percussion)
10. STACCATO
11. LFREQ SLOW (Low frequency Slow music)
12. MUSIC 1
13. MUSIC 2
14. MUSIC 3
15. SOFT PERC. (Soft percussion)
16. HFREQ ORCH. (High frequency Orchestra)
17. LFREQ ORCH. (Low frequency Orchestra)
18. SLOW ORCH. (Slow orchestra)

Adjust : You can use this to 'tweak' the selected preset. If your selected preset is close to what you're looking for, but still needs a little fine tuning, try a few different settings here until you get the best result. A (+) value will help improve high frequency and percussive sounds while a (-) value will help improve bass sound. Most of the time, this can be left at zero.

07. Press the [F5] (DO IT) key.

The Keep or Retry window will be displayed after executing the timestretch.

It may take some time to process depending on the length of the sample.

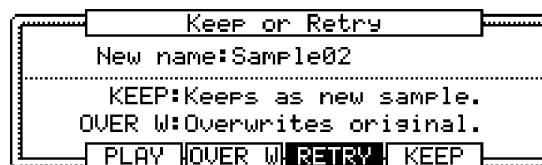

New name field:

You can enter a new name for the sample.

[F2] (PLAY) :

You can audition the new sample.

[F3] (OVER W) :

You can delete the original sample and keep the new sample.

[F4] (RETRY) :

It returns to Sample Edit window without keeping the new sample.

[F5] (KEEP) :

You can keep the new sample with the name set in the New Name field.

■ PITCH SHIFT (Changing the pitch of the sample)

With the Pitch Shift function, you can change the pitch of the selected sample without changing the length. This is useful when you want to change the pitch of the phrase sample in the sequence without changing the tempo..

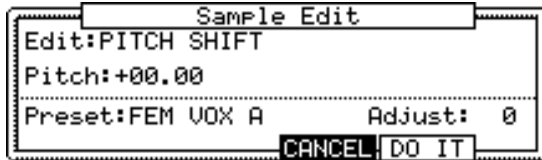

01. In the sample field, select the sample you wish to change the pitch..

02. Press the [F6] (EDIT) key.

The Sample Edit window will be displayed.

03. In the Edit field, select PITCH SHIFT.

04. In the Pitch field, set the pitch amount you wish to change..

Pitch : -12.00 - +12.00

This determines the amount of the pitch shift in semi tone and cent step. For example, if you enter +1.00, the sample will pitch up one semi tone. If you enter +12.00, the sample will pitch up one octave.

05. Set the Preset field and Adjust field if necessary.

Preset : The MPC1000 uses 18 preset algorithms to carry out the pitch shift process, so you should select a preset that closely resembles your sample's content. If you are not happy with the results, try experimenting with different presets.

Each preset is further divided into A, B or C:

- A: Standard quality pitch shift with fast processing
- B: Better quality pitch shift with slower processing
- C: Highest quality pitch shift with slower processing.

Pitch shift Presets:

01. FEM VOX (Female voice)
02. MALE VOX (male voice)
03. LOW MALE VOX (low male voice)
04. VOCAL
05. HFREQ RHYTHM (High frequency Rhythm section)
06. MFREQ RHYTHM (Middle frequency Rhythm section)
07. LFREQ RHYTHM (Low frequency Rhythm section)
08. PERCUSSION
09. LFREQ PERC. (Low frequency Percussion)
10. STACCATO
11. LFREQ SLOW (Low frequency Slow music)
12. MUSIC 1
13. MUSIC 2
14. MUSIC 3
15. SOFT PERC. (Soft percussion)

16. HFREQ ORCH. (High frequency Orchestra)

17. LFREQ ORCH. (Low frequency Orchestra)

18. SLOW ORCH. (Slow orchestra)

Adjust : You can use this to 'tweak' the selected preset. If your selected preset is close to what you're looking for, but still needs a little fine tuning, try a few different settings here until you get the best result. A (+) value will help improve high frequency and percussive sounds while a (-) value will help improve bass sound. Most of the time, this can be left at zero.

06. Press the [F5] (DO IT) key.

The Keep or Retry window will be displayed after executing the Pitch shift.

Lengthy samples will take longer to process.

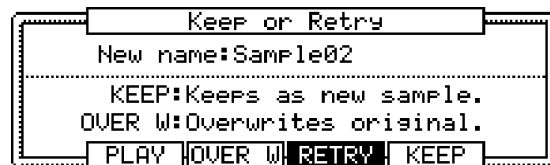

New name field:

You can enter the new name for the sample.

[F2] (PLAY) :

You can audition the new sample.

[F3] (OVER W) :

You can delete the original sample and keep the new sample.

[F4] (RETRY) :

Returns to Sample Edit window without keeping the new sample.

[F5] (KEEP) :

You can keep the new sample with the name set in the New Name field.

Dividing a phrase sample to several regions

The MPC1000 will allow you to divide a phrase sample into several regions. (Divides a sample to several regions of equal length.)

The divided sample can be used the following two ways. "SLICED SAMPLES" will assign each divided region to a pad. "PATCHED PHRASE" is one sample which has the divided regions and the sequence data for playing the divided regions. You can change the tempo freely when playing the sequence.

Note : If you use a stereo sample, only the left channel is used.

Dividing a phrase sample

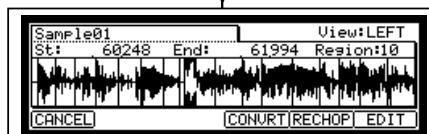
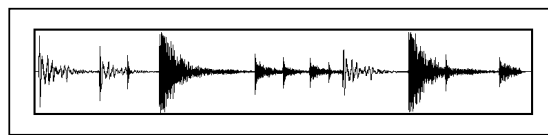

*Adjusting the start/end point of the region
(P.60)*

Converting to SLICED SAMPLES

Converting to PATCHED PHRASE

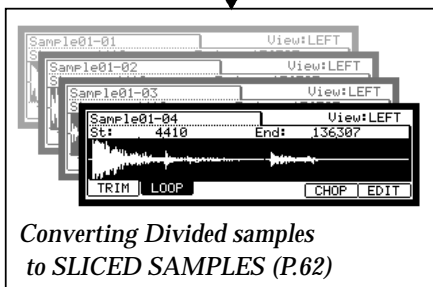

*Converting Divided samples
to SLICED SAMPLES (P.62)*

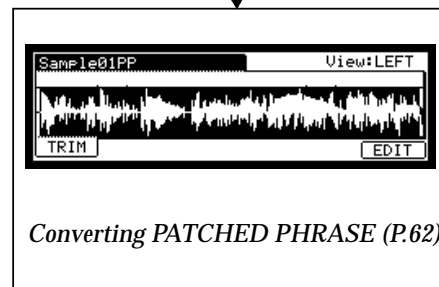

Converting PATCHED PHRASE (P.62)

Dividing a sample into regions of equal length

The MPC1000 will divide a sample into separate regions of equal length. You choose the number of sections.

01. In the Sample field within the TRIM page, select a sample you wish to edit.



You can set the sample range you wish to edit by adjusting the start/ end point.

For more information about adjusting the start/end point, see “Adjusting the start point” and “Adjusting the end point” section on page 53.

02. Press the [F5] (SLICE) key.

The SLICE window will be displayed.

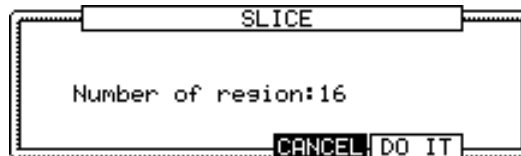

Number of Region (2 - 64) : You set the number of regions you wish to divide the sample into.

03. Press the [F5] (DO IT).

The MPC1000 will start dividing the sample, and then go to the “SLICE” page.

The next step is to adjust the divided regions.

Adjusting the start / end point of the region.

A Region is each part of a sample that is divided with the sliced point.

01. After pressing the [F5] (DO IT) in the "SLICE" window, the "SLICE" page will be displayed.

You can adjust the start/end point of each region in this page.

In the SLICE page, hitting Pad 1-12 will trigger each selected region.

Tips : If you want to re-try dividing a sample, press the [F5] (RECHOP) key. The "SLICE" window will be displayed and you can set it again..

If you want to stop the "SLICE" feature, press the [F1] (CANCEL) key. The display will go back to the "TRIM" page.

02. In the Region field, select the region number you wish to use to adjust the start/end point.

The selected regions waveform will become the reversal display.

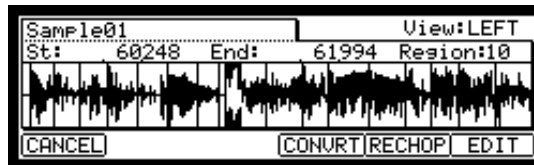

03. In the St: field, adjust the start point of the region.

You can change the start point by turning the DATA Wheel key. If you press the left/right cursor key while holding the [SHIFT] key, you can select individual digits to change with the DATA wheel.

Note : Each start point of a region is same as the end point of the previous region. If you change the start point of a region, the end point of the previous region will be changed automatically.

04. In the End: field, adjust the end point of the region.

You can change the end point the same way as the start point.

Note : Each end point of a region is same as the start point of the next region. If you change the end point of a region, the start point of the next region will be changed automatically.

If you want to re-try Dividing a sample, press the [F5] (RECHOP) key. The "SLICE" window will be displayed and you can try a different setting.

If you press the [F6] (EDIT) key, the Region Edit window will be displayed. You can extract, divide, or combine regions in this page. Refer to page 64 "Other available edits for Region".

If you wish to cancel the SLICE function, press the [F1] (CANCEL) key, the TRIM page will be displayed.

After adjusting the start/end point of the region, you can convert the regions to SLICED SAMPLES or PATCHED PHRASE.

Converting Divided samples to SLICED SAMPLES

05. After adjusting the parameters within each region, press the [F4] (CONVRT) key.

The Convert window will be displayed.

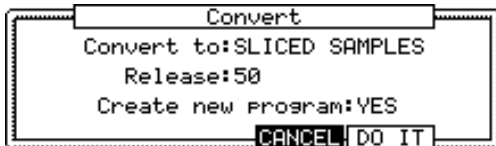

Here you can select two different ways for converting the divided sample, SLICED SAMPLE or PATCHED PHRASE

06. In the Convert to: field, select SLICED SAMPLES.

Release :

This sets the length that is added to the release after dividing a sample. If you set this to larger value, the release of the divided sample will be long and the sample data will be larger in size as well.

Create new program (YES / NO) :

If you set this to YES, the MPC1000 makes a Program where each region is assigned to pads, from PAD A01 – D16, in order.

07. After adjusting each parameter, press the [F5] (DO IT) key.

The MPC1000 will process the SLICED SAMPLES and then the "TRIM" page, with the divided sample, will be displayed.

The new sample name of the divided sample will be the original sample name and a number.

For Example:

```
Sample01 > Sample01-1
           Sample01-2
           Sample01-3
```

Converting PATCHED PHRASE

05. After adjusting the parameters within each region in the SLICE page, press the [F4] (CONVRT) key.

The Convert window will be displayed.



06. In the Convert to: field, select PATCHED PHASE

Release:

This sets the length that is added to the release after dividing a sample. If you set this to larger value, the release of the divided sample will be long and the sample data will be larger in size as well.

Original Tempo (30.0 – 300.0):

This sets the original tempo for the patched phrase. In the Original tempo field, the automatically calculated original tempo is already displayed. If you know the original tempo of the sample, you should enter it.

Note: The auto-calculated tempo is done with the original pitch (Tune), regardless of the TUNE setting. Depending upon the sample, the auto-calculated tempo may not work correctly.

The Patched Phrase sample is each region sample and the trigger timing of the sample together. If the original tempo setting is not correct, it may not work correctly.

07. After adjusting each parameter, press the [F5] (DO IT) key.

The MPC1000 will start processing the PATCHED PHRASE, then the "TRIM" page with the new sample will be displayed.



The new name of the patched phrase sample will be the original sample with "PP" added to the end.

For Example : Sample01 > Sample01PP.

You can assign the patched phrase sample to a pad in a program as well as an ordinary sample. The tempo of the patched phrase sample will change with the sequence tempo.

Note: You can not adjust the start/ end point of a patched phrase in TRIM mode. (The TRIM page of the patched phrase does not display the start/ end point.).

Changing the tune and the tempo of a patched phrase sample

If you press the [WINDOW] key in the Sample field of the TRIM page, the Sample window will be displayed. You can set the sample name, tune, and the original tempo of the patched phrase.

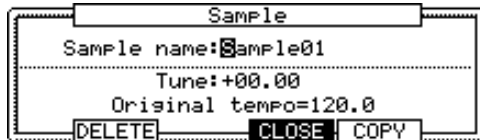

Sample name : You can enter a new name.

Tune: This sets the pitch of the patched phrase.

Original tempo : This sets the tempo of the patched phrase. The Original tempo setting is important for playing the patched phrase correctly. If the patched phrase sample cannot be played with the correct tempo, adjust the Original tempo.

Pressing [F4] (CLOSE) key will go back to the TRIM page.

Editing a Patched Phrase

You can extract a region in a Patched phrase as a sample or convert the Patched Phrase to a sample.



01. Select the Patched Phrase in the TRIM page, and press the [F6] (EDIT) key.

The Patched Phrase Edit window will be displayed.

02. In the edit field, select the type you wish to edit.

EXTRACT

This extracts the selected region of the Patched Phrase as a sample.



Region :

You select the number of the region you wish to extract.

New sample :

You can select a new name for the new sample.

[F2] (PLAY) :

You can audition the region by pressing this key.

[F4] (CANCEL):

You can cancel the Extract by pressing this key

03. Press the [F5] (DO IT) key.

The MPC1000 will start processing the Extract, and then the display will go back to the TRIM page.

RESTORE

This converts the selected Patched Phrase to an ordinary sample.



Tempo : This set the tempo of the sample.

[F4] (CANCEL) : You can cancel the Extract process by pressing this key

03. Press the [F5] (DO IT) key.

The MPC1000 will begin processing the Restore, and then the display will go back to the TRIM page.

Other available edits for Region

By using the Edit function in the SLICE page, you can divide one region into two regions or combine continuous regions into one region. You can also extract the selected region as another sample.

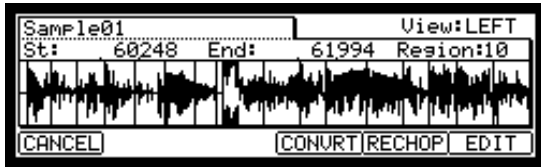

01. In the SLICE page, press the [F6] (EDIT) key.
The Region Edit window will be displayed.

02. In the Edit field, select the type you wish to edit.

EXTRACT

You can extract the selected region as another sample.

03. In the Edit field, select the EXTRACT.



Region: You select the number of the region you wish to extract.

New sample: You can select a new name for the new sample.

04. Press the [F5] (DO IT) key.

The MPC1000 will start the extract process. Pressing [F4] (Cancel) will cancel the extract and the display go back to the SLICE page.

DIVIDE REGION

You can divide the selected region to two regions.

03. In the Edit field, select DIVIDE REGION.

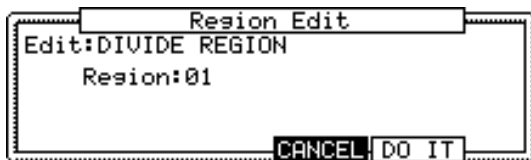

Region: You select the number of regions you wish to divide.

04. Press the [F5] (DO IT).

The MPC1000 will start dividing regions. Pressing [F4] (Cancel) will cancel the process and the display will go back to the SLICE page.

COMBINE REGION

You can combine the continuous regions to one region.

03. In the Edit field, select COMBINE REGION.

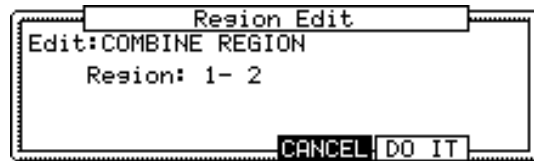

Region : You select the numbers of regions you wish to combine.

For example, if you set this 1-5, the regions from 1 to 5 will be combined.

04. Press the [F5] (DO IT) key.

The MPC1000 will start combining the regions. Pressing [F4] (Cancel) will cancel the process and the display will go back to the SLICE page.

Setting the loop

The loop feature plays the sample repeatedly. With the loop feature, you can play the sample from the loop point to the end point repeatedly. To activate the loop feature, turn on the loop field, which is located in the upper right corner of the LOOP page. When the loop feature is on, the MPC1000 first plays the part from the start point set in the TRIM page to the end point, and then plays the part from the loop point set in the LOOP page to the end point repeatedly.

Note : If you set the pad to ONE SHOT in the PROGRAM mode, the MPC1000 will play the sample assigned to that pad like when the loop is off, even when the loop feature is on. When you use the loop feature, set the pad's play mode to NOTE ON. For more information, see the "Playing the sample while the pad is being hit" section in the page 67.

■ Adjusting the loop point

01. In the TRIM mode, press the [F2] (LOOP) key.

The LOOP page will be displayed.



02. Select the Sample field and select a sample you wish to edit.

The Sample field is located in the upper left corner of the screen, which displays the sample name. It displays the waveform of the selected sample.

03. Select the Lp (loop) field and adjust the loop point.

You can change the loop point by turning the DATA wheel. If you press the left/right cursor key while holding the [SHIFT] key, you can select the digit with the DATA wheel.

You can also enter the value directly using the [NUMERIC] key and pads. When you press the [NUMERIC] key, its LED will blink, which indicates you can enter numbers with pads.

04. Hit the pad to check the loop point.

When you hit the pad, the MPC1000 plays the sample. The playback method varies depending on the pad.

If you hit the [PAD 13] (PLAY LOOP), the MPC1000 will play the sample from the loop point to the end point repeatedly.

If you hit the [PAD 14] (PLAY TO), the MPC1000 will play the part before the loop point.

If you hit the [PAD 15] (PLAY FROM), the MPC1000 will play the sample from the loop point.

If you hit the [PAD 16] (PLAY ALL), the MPC1000 will play the whole sample.

If you hit any pad from the [PAD 1] to [PAD 12], the MPC1000 will first play from the start point to the end point, and then play from the loop point to the end point repeatedly.

■ Adjusting the end point

05. Select the End field and adjust the end point.

Note: The end point of the loop is the same with the end point of the sample, which is set in the TRIM page.

If you change the end point in the LOOP page, the end point in the TRIM page will be changed as well.

■ Zooming in/out of the waveform

With the Loop Fine window, you can zoom into a part of the waveform and edit the part in details. Press the [WINDOW] key in the LOOP page, when the cursor is either in the Lp (loop) or End field, and the Loop Fine window will be displayed.

The waveform of the end point is displayed in the left of the waveform display, and the waveform of the loop point in the right, so you can adjust the loop and end points while checking the relationship of the waveform. If you press the [F2] (ZOOM-) key the waveform will be zoomed out, if you press the [F3] (ZOOM+) key, it will be zoomed in.

■ LINEAR and LOGARITHMIC displays

The vertical axis indicates the waveform's level. Normally, the waveform display is set to LINEAR, which displays the sample level as it is. However, some parts (fade out part etc...) may not be displayed as the waveform if the level is too low. In this case, you can switch to the LOG (logarithmic) display by pressing the [F5] (LOG) key and you can see the parts whose level is low. When you switch to the LOG mode, the display in the [F5] key will change to LINEAR. To switch back to the LINEAR mode, press the [F5] key again.

Linking the loop point to the start point

When you loop the whole sample (ex: loop the phrase sample to the rhythm), it is better to set the start and loop point to the same value so that you can change both points at the same time.

01. In the LOOP page, select the Σ \square \square \square (start/loop link) field.

02. Turn the DATA wheel and set the field to Σ \square \square \square (locked by the key).

Loop point is set to the value of the start point. If you change the loop point later, the start point will be changed as well and vice versa.

If you reset the start/loop link field, you can set the start point and loop point separately.

Chapter 12 : Program

In this section, you will learn how to edit a program. This is done in the PROGRAM mode, which can be accessed by pressing the [MODE] key and then the [PAD 7] (PROGRAM).

Pgm:	Program01	Lvl	Tune	Range
A	1: Sample01	100	+00.00	0-127
0	2:	100	+00.00	0-127
	3:	100	+00.00	0-127
1	4:	100	+00.00	0-127

SAMPLE | FILTER | PARAMS | NOTE | LFO | PURGE

Creating a program

To create a new program, proceed as follows.

Note : the MPC1000 is set to load the preset program automatically when turned on. You can set the MPC1000 to start without loading preset program. For more information, see the “Setting the auto load function” on page 96.

- Press the [MODE] key and then the [PAD 7] (PROGRAM).
When you press the [MODE] key, its LED will blink.
When you press the [PAD 7] with the [MODE] key's LED blink, you can enter the PROGRAM mode.
- Select the Pgm field and press the [WINDOW] key.
The Program window will be displayed.
- Press the [F3] (NEW) key.
The New Program window will be displayed.
- In the New name field, turn the DATA wheel.
The name window will be displayed. Set the name for the new program and press the [F5] (ENTER) key. For more information about setting the name, see the “Setting names” section on page 10.
- In the New Program window, press the [F5] (DO IT) key.
The new program will be created.
The new program is “empty”, which means it does not have any samples assigned. To play the program, you need to assign samples to the pads in the SAMPLE page of the PROGRAM mode.

Assigning/Reassigning samples to the pads

You need to assign samples to the pads in the PROGRAM mode so that you can play the samples with the pads. In this section, you will learn how to assign samples to these pads and how to change the current assignment.

- Press the [MODE] key and then the [PAD 7] (PROGRAM).
When you press the [MODE] key, its LED will blink.
When you press the [PAD 7] with the [MODE] key's LED blinking, you can enter the PROGRAM mode.
Pressing the [F1] (SAMPLE) key displays the SAMPLE page.

Pgm:	Program01	Lvl	Tune	Range
A	1: Sample01	100	+00.00	0-127
0	2:	100	+00.00	0-127
	3:	100	+00.00	0-127
1	4:	100	+00.00	0-127

SAMPLE | FILTER | PARAMS | NOTE | LFO | PURGE

The Pgm field in the upper left corner displays the name of the currently selected program. You can change the selected program in the Pgm field.

- Hit the pad you wish to assign a sample to.
The pad number will be displayed in the left (the section which says A01 in the above picture). The pad number will change according to the pad you hit.
- Select the 1 field and select the sample to assign to the pad.
You can select the sample currently stored in the MPC1000's RAM by turning the DATA wheel.
You can assign samples by selecting 2 through 4 fields. If you assign samples to 2 through 4 fields, you can play several samples by hitting the pad once.

Playing the sample while the pad is being hit

When you play a sample by hitting the pad, the sample will be played until the end regardless of the length you hit the pad for. This is useful when you play short drum sounds. However, when you play a long sample such as a phrase sample, it is better to set the MPC1000 to play the sample only when you hold the pad. In this section, you will learn how to play the sample when you hit the pad.

01. In the SAMPLE page of the PROGRAM mode, hit the pad you wish to change.

The pad number display in the left of the screen will change according to the pad that you hit.

02. Select the 1 field and press the [WINDOW] key.

The Play Mode window will be displayed.

03. Select the Layer 1 field and select the option.

ONE SHOT The MPC1000 plays the sample until the end regardless of how long you hold the pad.

NOTE ON The MPC1000 plays the sample only while you hold the pad.

04. Press the [F4] (CLOSE) key to close the window.

It will bring you back to the SAMPLE page.

Note : When you loop the sample, set the play mode to **NOTE ON**. When you select **ONE SHOT**, the loop feature will not work even when it is on.

Setting the volume and the tuning for a sample

You can set the volume and the tuning for samples that are assigned to the pads.

01. In the SAMPLE page of the PROGRAM mode, hit the pad you wish to change its volume and pitch.

The pad number display in the left of the screen will change according to the pad you hit.

02. Select the Lvl field.

Pad	Program	Lvl	Tune	Range
A	1: Sample01	100	+00.00	0-127
α	2:	100	+00.00	0-127

03. Adjust the volume to the desired level while checking the level by hitting pad.

04. Select the Tune field.

The Tune field has two fields divided by a decimal point. The 2 digits on the left set the tuning by semitones.

The 2 digits on the right change the tuning by cents (100 cents = 1 semitone).

05. Adjust the pitch to the desired level while checking the tune by hitting pad.

Changing the sample volume with velocity

You can control the sample volume by velocity (how hard you hit the pad). With this feature, you can play the pads like real drums; when you hit the pad strongly, the sound will be loud and vice versa.

01. In the SAMPLE page of the PROGRAM mode, hit the pad you wish to edit.

The pad number display in the left of the screen will change according to the pad you hit.

02. Select the Lvl field.

03. Press the [WINDOW] key.

The Amp Envelope window will be displayed.

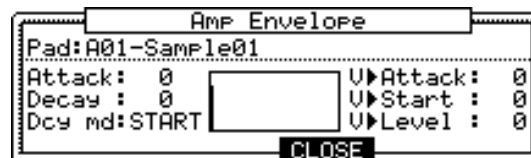

04. Select the V>Level field.

05. Adjust the field to the desired value while checking the level by hitting the desired pad.

If you set this field to 0, the sample will be played back at the maximum level regardless of the amount of pressure. The larger you set the value, the bigger the difference of the level will be.

You can set the more detailed setting for a sample volume by using the other parameters in the Amp Envelope window. For more information about setting them, see the Setting the Amp envelope on page 69.

Changing the sample pitch with velocity

You can control the sample pitch by velocity (how hard you hit the pad).

01. In the SAMPLE page of the PROGRAM mode, hit the pad you wish to edit.

The pad number display in the left of screen will change according to the pad you hit.

02. Select the Tune field.

03. Press the [WINDOW] key.

The Pitch Modulation window will be displayed.

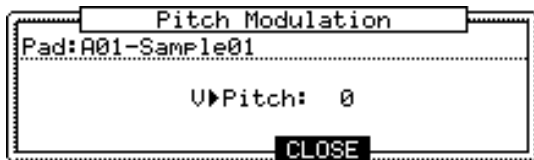

04. Select the V>Pitch field.
05. Adjust the field to the desired value while checking the level by hitting the desired pad.

If you set this field to 0, the sample pitch will not change with velocity. The larger you set the value, the higher the pitch will be.

Playing several samples with one pad

You can assign up to 4 samples to one pad. When you assign more than one sample to a pad, you can play several samples by hitting one pad.

01. In the SAMPLE page of the PROGRAM mode, select the desired pad.

The pad number display in the left of the screen will change according to the pad you hit.

The Pgm field in the upper left corner displays the name of the currently selected program. You can change the currently selected program in the Pgm field.

02. Select the 1 field and select the sample to assign to the pad.

You can select the samples currently saved in the MPC1000's memory by turning the DATA wheel.

03. Select the 2 field and select the sample to assign to the pad.

When you hit the pad, both samples, which are as-

signed to the pad in the 1 field and the 2 fields, will be played at the same time.

04. Assign the samples to the 3 and 4 fields if necessary.

Switching between samples using velocity

When you assign more than one sample to a pad, you can switch between samples by the velocity used to hit the pad.

01. In the SAMPLE page of the PROGRAM mode, select the desired pad by hitting it.

02. Assign the samples to the 1 field and the 2 field.

03. Select the Range field in the same row with the 1 field, and set the velocity range to trigger the sample assigned to the field.

Pgm:Program01	Lvl	Tune	Range
A: 1:Sample01	100	+00.00	0-127
A: 2:Sample02	100	+00.00	0-127

The Range field has two fields to set the upper and the lower limits. You can set the lower limit in the left field and the upper limit in the right field. Here, set the upper limit (the right field) to 63.

04. Select the Range field in the same row with the 2 field, and set the velocity range to trigger the sample assigned to the field.

Pgm:Program01	Lvl	Tune	Range
A: 1:Sample01	100	+00.00	0- 63
A: 2:Sample02	100	+00.00	64-127

In this example, set the lower limit (the left field) to 64.

05. Check the result by hitting the pad.

If you hit the pad strongly, the MPC1000 will play the sample assigned to the 2 field. If you hit the pad weakly, the MPC1000 will play the sample assigned to the 1 field.

Tips : The pressure used to hit the pad will be displayed in the 128 steps (0 to 127). The maximum level is 127. This is the same with the "MIDI velocity", which indicates the pressure used to play the keyboard.

Tips : You can also use the Q- Link slider to switch layers. For more information, see the "Chapter8 Q-Link Slider" section on page 44.

Setting the envelope for a pad

You can set the envelope for the samples assigned to the pads. The MPC1000 has two envelopes, one is the Amp Envelope for the volume and the other is the Filter envelope for sound character.

■ Setting the Amp Envelope

01. In the SAMPLE page of the PROGRAM mode, select the pad you wish to make a setting by hitting it.

02. In the Lvl field, press the [WINDOW] key.

The Amp Envelope window will be displayed.

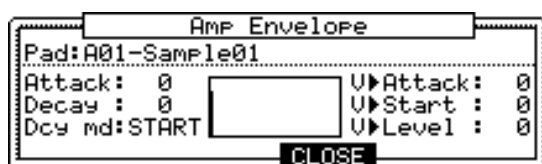

Pad field :

The selected pad will be displayed.

Attack field :

You can set the sample's attack time in this field.

The larger the value, the longer it will take for the sound to start. (fade in)

Decay field :

You can set the samples decay time in this field.

The larger you set the value, the slower the fade out becomes.

Dcy md (decay modulation) field :

You can set the start point that the decay starts the fade out in this field.

START :

The decay will begin right after the attack time set in the Attack field.

END :

The start point of the decay will be set so that the fade out will end at the sample's end point.

Tips : When you work with drum sounds or phrase sampling, select END. Select START if you need the fade out effect for the phrase.

V > Attack field : You can control the sample's attack time by velocity. The larger you set the value, the slower the sound will start by velocity. If you set this field to 0, the attack time is constant, regardless of the velocity.

V > Start field : You can control the sample's start point by velocity. The larger you set the value, the bigger delay the sample start point will be by velocity. If you set this field to 0, the sample start point is constant, regardless of the velocity.

V > Level field : You can control the sample's volume by velocity. The larger you set the value, the bigger the difference of the level will be. If you set this field to 0, the sample will be played back at the maximum level regardless of the velocity.

■ **Setting the Filter Envelope**

01. In the FILTER page of PROGRAM mode, select the pad you wish to filter by hitting it.

02. In the Type field, press the [WINDOW] key.

The Filter Envelope window will be displayed.



Pad field : The selected pad will be displayed.

Filter field : The selected Filter type will be displayed.

Time field : You can set the time of the filter envelope. It is the time from the beginning (the value set in the Amount field) to the original cut off frequency.

Amount field : You can set the depth of the filter envelope. If you set this field to a “ + ” value, the cut off frequency will start higher than the original cut off frequency and goes back to the original frequency within the time set in the Time field. If you set this field to a “ - ” value, the cut off frequency will start lower than the original cut off frequency and go back to the original frequency within the time set in the Time field.

V>Time field : You can control the filter envelope time by velocity. If you set this field to a “ + ” value, the time will be closer to the time set in the Time field with higher velocity, If you set this field to a “ - ” value, It works exactly opposite. If you set this field to 0, the time is constant by velocity.

V>Amount field : You can control the depth by velocity. If you set this field to a “ + ” value, the beginning cut off frequency will start closer to the frequency set in the Amount field with higher velocity, If you set this field to a “ - ” value, It works exactly opposite. If you set this field to 0, the depth is constant by velocity.

V>Freq. Field: You can control the cut-off frequency with velocity. The larger the velocity, the higher the cut-off frequency. If you set this field to 0, the cut-off frequency is constant by velocity.

The functions in the Program window

Pressing the [WINDOW] key in the Pgm field brings up the Program window. In the Program window, you can edit the setting for the selected program.

■ Changing the program name

01. In the Pgm field of the PROGRAM page, select a program that you wish to change the name.
02. Press the [WINDOW] key.
The Program windows will open.
03. In the Program name field, enter the new name.
For more information for setting the name, see the “Setting names” section on Page 10.
04. Press [F4] (CLOSE) key.
It closes the window and goes back to PROGRAM mode.

■ Copying a program

You can copy a program to make a new program.

01. In the Pgm field in PROGRAM mode, select the program that you wish to copy.
02. Press the [WINDOW] key.
The Program window will open.
03. Press [F5] (COPY) key.
The Copy Program window will open.
04. In the New name field, set the name for the new program.
For more information regarding setting the name, see the “Setting names” section on Page 10.
05. Press [F3] (DO IT) key.
Copying the program will start. To cancel the operation, press [F4] (CANCEL) key instead.

■ Deleting a program

You can remove a program from the memory of the MPC1000.

01. In the Pgm field in PROGRAM mode, select the program that you wish to delete.
02. Press the [WINDOW] key.
The Program window will open.
03. Press [F2] (DELETE) key
The Delete Program window will open.
04. Press [F5] (DO IT) key.
This deletes the selected program.

■ Deleting all programs

You can delete all the program data in the memory at the same time.

01. In the PROGRAM mode, select the Pgm field and press the [WINDOW] key.
The Program window will open.
02. Press [F2] (DELETE) key.
The Delete Program window will open.
03. Press [F3] (ALL PG) key.
The Delete ALL Programs window will open.
04. Press [F5] (DO IT) key.
This deletes all the programs.

■ Setting the program change number

You can switch the programs assigned to a track within the sequence by setting the program change numbers in the sequence by setting the program change numbers in the sequence. You do not have to set the program change numbers if you do not need to switch the programs. To switch the programs, program change events are used. You can enter these events in the STEP EDIT mode. For more information about entering the program change events, see the “Step editing” section on page 31.

01. In the Pgm field of the PROGRAM mode, press the [WINDOW] key.
The Program window will be displayed.

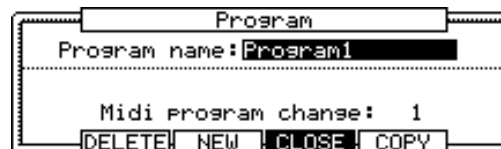

02. Select the MIDI program change field and set the program change number.
If a track has a program change event with the same number set in this field, the MPC1000 switches the program at the event while playing back the sequence. If you do not wish to switch the program during the playback, set this field to OFF.

Editing the sound of a sample

Each pad has a parameter to change the sound, which is called "Filter". You can edit the sound of the sample by editing this parameter. This is done in the FILTER page of the PROGRAM mode.

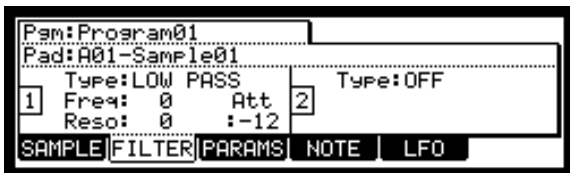

Each pad has two filters. You can create a more complicated sound by combining these two filters. Also you can link these two filters to make a more powerful filter.

■ Setting the Filter

01. In the PROGRAM mode, press the [F2] (FILTER) key.

The FILTER page will be displayed. You can select the program to edit in the Pgm field.

02. Select the pad you wish to edit for the sound by hitting it.

The Pad field displays the pad number of the selected pad. To the right of the pad number, the name of the sample assigned to the pad is displayed.

03. Select the Type field of filter 1 (to the left) and select which filter type to use.

The MPC1000 has several types of filter to edit the sound. With these filters, you can cut or boost the specific frequency of the sound.

LOW PASS This filter cuts out the high frequencies and passes the low frequencies. This filter is frequently used in the electronic instruments such as synthesizers.

HIGH PASS This filter cuts out the low frequencies and passes the high frequencies.

BAND PASS The filter passes the specific frequencies and cuts out the other frequencies.

LOW PASS 2 The resonance gain of this filter is set higher than "LOW PASS". It can be done the self-oscillation if the resonance value is set to very high.

OFF No filter is used.

04. Select the Freq field and set the cut off frequency.

The cut off frequency is the frequency that triggers the filter. When you select the LOW PASS filter, if you set the cut off frequency too low, the sound will seem dull. This is because most of the higher frequencies of sound are cut off by the filter. When you select the HIGH PASS filter, if you set the cut off frequency too high, most of the lower frequencies are cut off, which results in a more hollow sound.

05. Set the Reso field to adjust the resonance of the filter.

If you set the resonance value at a larger value, the frequencies set in the Freq field will be boosted more. It is hard to describe the effect of the resonance, because it differs depending on the cut off frequency and filter type. Experiment several settings in the Type field, Freq field, and Reso field.

Note : If you notice distorted sound while using the FILTER, you can use the Att parameter to adjust the level of the signal sent to the filter, and remove the unwanted distortion.

06. Set the filter of the filter 2 (to the right) in the same way.

Tips : You do not have to edit both filter 1 and 2. If you do not need the filter, set the Type field to OFF.

■ Linking the two filters

You can link the two filters to make it as one powerful filter. To link the filters, select the LINK in the Type field for the filter 2 (in the right).

The MPC1000 will ignore the settings in the Freq field and the Reso field for the filter 2 and apply the same setting as those for the filter 1, which provides you with a powerful filter effect.

■ Controlling the sound with velocity

You can control the cutoff frequency of the filter by the velocity used to hit the pad. With this feature, you can control the sound by changing the velocity used to hit the pad.

01. In the PROGRAM mode, press the [F2] (FILTER) key.

The FILTER page will be displayed.

02. Select the desired pad by hitting it.

The Pad field displays the pad number of the selected pad.

03. Select any of the Type, Freq, or Reso fields and press the [WINDOW] key.

The Filter Envelope window will be displayed.

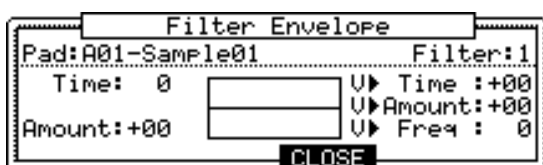

04. Select the V> Freq field.

The larger the value you set, the more drastic a change you can make to a sample by how hard you hit the pad.

Refer to “Setting the Filter Envelope” about the other parameter in the Filter Envelope window.

Tips : You can set the V>Freq for the filter 1 and 2 separately.

Limiting the number of the voice in the Program

Normally, the pad sounds in the program are played polyphonic, when you hit the pad several times. But you may wish to play the program with the pad sound of monophony, such as the program being made by the SLICED SAMPLE function. In this case, you can set the limit of voice number on the pad in the program.

01. In the Program mode, press the [F3] (PARAMS) key

The PARAMETER page will be displayed.

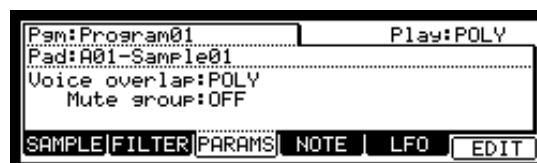

02. In the Play field, select MONO.

Play field :

POLY The MPC1000 overlaps the sound in the program.. (Polyphony)

MONO The MPC1000 does not overlap the sound in the program.. (Monophony)

Note : This is the setting of the whole Program, but you can set each pad in the program to the voice overlap (POLY or MONO) respectively. Refer to Page 74 “Setting the overlap of a sound on the same pad (voice overlap)”.

Simulating the open/close hi-hat (setting the mute group)

Normally, when you hit a pad when another pad is played back, the samples of these two pads will be played back overlapped. With the mute group function, you can stop the playback of the sample of a pad when you hit another pad. You can simulate the open/close hi-hat; the sound of the open hi-hat will stop when the close hi-hat sound is triggered.

You can use this function by setting two pads to the same mute group. The pads set to the same mute group will not be played at the same time.

01. In the PROGRAM mode, press the [F3] (PARAMS) key. The PARAMS page will be displayed.

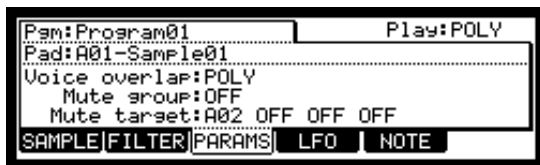

02. Select one of the pads to set the mute group, by hitting the pad.
03. In the Mute group field, select a number. You can set any number except OFF.
04. Select the other pad to set the mute group, by hitting the pad.
05. In the Mute group field, set the same number you set for the first pad in the step 3.

You must set the same number to activate the mute group.

Hit one pad while playing back another. The first sample will be stopped and only the sample of the pad you hit will be played.

Tips : You can set the mute group to more than two pads.

Note : If you set the Play field to MONO, each pad sample cannot be played with Polyphony, regardless of which mute group you assign it to. When you use a mute group, set the Play field to POLY.



■ Mute Target feature

You can use the Mute Target feature for stopping the playback of the sample of a pad when you hit another pad, except using the mute group.

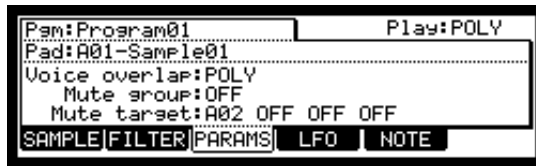

If you use the Mute group, the playback of the pads in the same mute group are stopped.

But if you use the Mute Target, it allows you to set “to stop the pad A02 when hitting the pad A01, but not to stop the pad A01 when hitting the pad A02”.

For example, in the Mute target field in the pad A01, select the pad A02, and in the Mute target group in the pad A02, not select the pad A01. In this case, the playback of the pad A02 will be stopped by hitting the pad A01, but the playback of the pad A01 will not be stopped by hitting the pad A02.

You can set the maximum four mute target pads.

Setting the overlap of the sounds on the same pad (voice overlap)

Normally, when you hit the same pad several times, the same sound will be overlapped. When you use the MPC1000 as a drum machine, you can make the performance sound natural with this feature. However, when you are using a phrase sample, it may be better not to overlap the same sound. With the voice overlap function, you can set the MPC1000 not to overlap the same pad sound.

01. In the PROGRAM mode, press the [F3] (PARAMS) key. The PARAMS page will be displayed.
02. Select the desired pad by hitting it.
03. In the Voice overlap field, select MONO.

POLY The MPC1000 overlaps the sound.

MONO The MPC1000 does not overlap the sound.

If you select MONO, when you hit the pad several times, only the pad that was hit last will be played.

Note : If you set the Play field to MONO, each pad sample cannot be played with Polyphony, regardless of the Voice overlap setting. When you use the voice overlap function, set the Play field to POLY.



Editing a pad sample

You can edit a pad sample without going to TRIM mode. While editing a pad sample in Program mode, you can use “Time stretch” edit and “Pitch Shift” edit.

Note : You can edit the pad sample assigned only in Layer 1 in SAMPLE page.

■ Time Stretch (Changing the length of the sample)

The Time Stretch edit can lengthen or shorten the selected sample without changing the pitch. This is useful when you want to match one sample to another (even though they have different tempos), to fit a sample into a specific period of time or into a track.

- In the Program mode, press the [F3] (PARAMS) key.
The PARAMS page will be displayed.

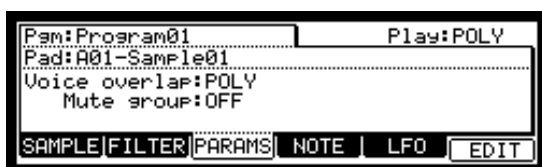

- Select the desired pad by hitting it.
- Press [F6] (EDIT) key.
The Pad Sample Edit key will be displayed.
- In the Edit field, select the TIMESTRETCH.

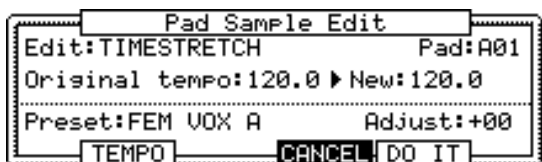

In the Pad field, the selected pad for edit is displayed. This field displays only the selected pad number in the Parameter page...

- The Original tempo field will be displaying the tempo of the currently selected sequence, so you will need to set it to the original tempo of the selected sample.
If you do not know the tempo of the selected sample, you can use the DETECT TEMPO page and the MPC1000 will find out for you.

• Using the DETECT TEMPO

- In the Pad Sample Edit window, press the [F2] (TEMPO) key.

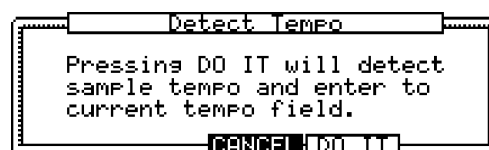

- Press the [F5] (DO IT) key.

The Pad Sample Edit window will be displayed and the calculated tempo in the DETECT TEMPO will be set automatically in the Original Tempo field.

Note : Depending upon the sample (such as a single snare drum sample), the DETECT TEMPO may not be able to detect the correct tempo.

- In the new field, set the desired new tempo.

Tips : If you wish to change the sample length with %, you can use the following method. For example, if you want to lengthen the sample with 120%, simply set the original tempo to 100, and then set the new tempo to 120. Now you can get the 120% longer sample.

- Set the Preset field and Adjust field if necessary.

Preset : The MPC1000 uses 18 preset algorithms to carry out the timestretch process, so you should select a preset that nearest resembles your sample's content. If you are not happy with the result, try experimenting with different presets.

Each preset is further divided into A, B or C:

- A : Standard quality timestretch with fast processing.
- B : Better quality timestretch with slower processing.
- C : Highest quality timestretch with slower processing.

Time stretch Presets :

- FEM VOX (Female voice)
- MALE VOX (male voice)
- LOW MALE VOX (low male voice)
- VOCAL
- HFREQ RHYTHM (High frequency Rhythm section)
- MFREQ RHYTHM (Middle frequency Rhythm section)
- LFREQ RHYTHM (Low frequency Rhythm section)
- PERCUSSION
- LFREQ PERC. (Low frequency Percussion)
- STACCATO
- LFREQ SLOW (Low frequency Slow music)
- MUSIC 1
- MUSIC 2
- MUSIC 3
- SOFT PERC. (Soft percussion)

- 16. HFREQ ORCH. (High frequency Orchestra)
- 17. LFREQ ORCH. (Low frequency Orchestra)
- 18. SLOW ORCH. (Slow orchestra)

Adjust : You can use this to 'tweak' the selected preset. If your selected preset is close to what you're looking for, but still needs a little fine tuning, try a few different settings here until you get the best result. A (+) value will help improve high frequency and percussive sounds while a (-) value will help improve bass sound. Most of the time, this can be left at zero.

- 08. Press the [F5] (DO IT) key.

The Keep or Retry window will be displayed after executing the timestretch.

Lengthy sample will take longer to process.

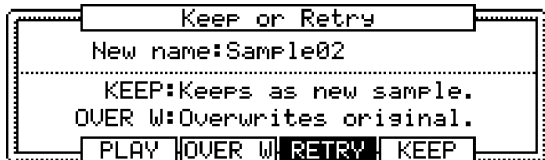

New name field:

You can enter a new name for the sample.

[F2] (PLAY) :

You can audition the new sample.

[F3] (OVER W) :

You can delete the original sample and keep the new sample.

[F4] (RETRY) :

It returns to the Pad Sample Edit window without keeping the new sample.

[F5] (KEEP) :

You can keep the new sample with the new name set in the New Name field.

■ **PITCH SHIFT (Changing the pitch of the sample)**

The Pitch Shift edit can change the pitch of the selected sample without changing its length. This is useful when you want to change the pitch of a phrase sample in the sequence without changing the tempo..

- 01. In the Program mode, press the [F3] (PARAMS) key.

The PARAMS page will be displayed.

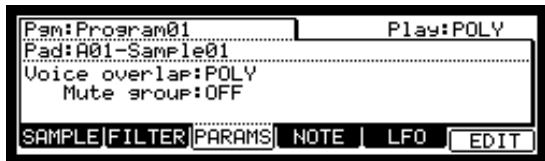

- 02. Select the desired pad by hitting it.

- 03. Press the [F6] (EDIT) key.

The Pad Sample Edit window will be displayed.

- 04. In the Edit field, select PITCH SHIFT.

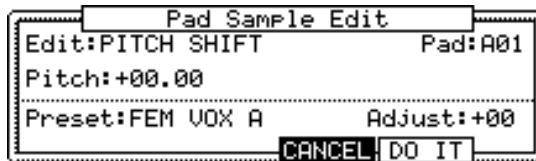

- 05. In the Pitch field, set the pitch amount you want to change..

Pitch : -12.00 - +12.00

This determines the amount of the pitch shift in semi tone and cent step. For example, if you set +1.00, the sample pitch will be one semi tone up. If you set +12.00, the sample pitch will be one octave up.

- 06. Set the Preset field and Adjust field if necessary.

Preset :

The MPC1000 uses 18 preset algorithms to carry out the Pitch shift process, so you should select a preset that nearest resembles your sample's content. If the results are not close enough what you're looking for, try experimenting with different presets.

Each preset is further divided into A, B or C:

- A : Standard quality Pitch shift with fast processing
- B : Better quality Pitch shift with slower processing
- C : Highest quality Pitch shift with slower processing.

Pitch shift Presets:

- 01. FEM VOX (Female voice)
- 02. MALE VOX (male voice)
- 03. LOW MALE VOX (low male voice)
- 04. VOCAL
- 05. HFREQ RHYTHM (High frequency Rhythm section)
- 06. MFREQ RHYTHM (Middle frequency Rhythm section)
- 07. LFREQ RHYTHM (Low frequency Rhythm section)
- 08. PERCUSSION
- 09. LFREQ PERC. (Low frequency Percussion)
- 10. STACCATO
- 11. LFREQ SLOW (Low frequency Slow music)
- 12. MUSIC 1
- 13. MUSIC 2
- 14. MUSIC 3
- 15. SOFT PERC. (Soft percussion)
- 16. HFREQ ORCH. (High frequency Orchestra)
- 17. LFREQ ORCH. (Low frequency Orchestra)
- 18. SLOW ORCH. (Slow orchestra)

Adjust : You can use this to 'tweak' the selected preset. If your selected preset is close to what you're looking for, but still needs a little fine

tuning, try a few different settings here until you get the desired result. A (+) value will help improve high frequency and percussive sounds while a (-) value will help improve bass sound. Most of the time, this can be left at zero.

06. Press the [F5] (DO IT) key.

The Keep or Retry window will be displayed after executing the Pitch shift.

Lengthy samples will take longer to process.

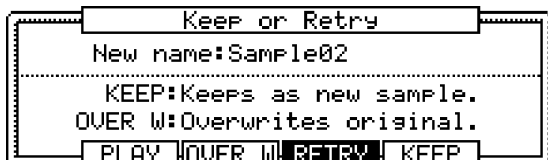

New name field:

You can enter the new name for the sample.

[F2] (PLAY) :

You can audition the new sample.

[F3] (OVER W) :

You can delete the original sample and keep the new sample.

[F4] (RETRY) :

It returns to Pad Sample Edit window without keeping the new sample.

[F5] (KEEP) :

You can keep the new sample with the name set in the New Name field.

Setting a LFO (Low Frequency Oscillator)

You can set the LFO on the pad sample in the Program. By using the LFO, you can get a more powerful sound. For example, if you set the Pitch in the LFO page, the pad sound can have the vibration effect, and if you set the Level in the LFO, the pad sound can have the tremolo effect. The MPC1000 can set the Filter or Pan in the LFO page as well as the Pitch or Level.

01. In the Program mode, press the [F5] (LFO) key.

The LFO page will be displayed.

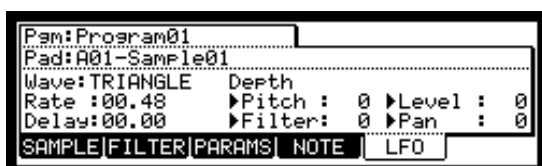

In the Pgm field, you can select the Program you wish to edit.

02. Select the desired pad by hitting it.

In the Pad field, the selected pad will be displayed.

Wave field:

You can select the wave for the LFO from TRIANGLE, SINE, SQUARE, SAW, SAW DOWN, or RANDOM.

Rate field (00.00 – 99.00)

You can set the cycle (speed) of the LFO. This setting value is based on the Beat and Tick. The cycle (speed) will be changed with the tempo of the sequence. For example, if you wish to set the cycle of the LFO to one beat of the sequence, you would set this value to "01.00", if you want to set the cycle to an 1/8 note, set it to "00.48" and so on.

Delay field (00.00 – 99.00)

You can set the delay time (the time before starting the LFO) with the Beat and the Tick. For example, if you wish to start the LFO after one beat from starting from the point of triggering a sample, set it to "01.00".

Pitch field (0-100)

You can set a value to change the pitch of the sample. (Vibrate effect).

The lower this value, the less pitch variation you will get, and vice versa the higher this value, the more pitch variation.

Filter field (0 – 100)

You can set this value to change the filter of the sample. (WOW effect)

The lower this value, the less the WOW becomes, and vice versa. This parameter works is based upon the setting in the Filter page.

Level field (0 – 100)

You can set this value to change the level of a sample. (Tremolo effect)

The lower this value, the less tremolo effect, the larger the value, the more tremolo effect.

Pan field (00.00 – 99.00)

You can set this value to change a pan of a sample. (Auto-Panning).

The lower this value, the narrower the panning effect, the larger this value, the wider the panning effect will be.

Delete all the unused samples at the same time (PURGE)

When you use the MPC1000 to record or load several samples, you may have unused samples (samples not assigned to any pads in the program) in the MPC1000's memory. In this case, it is time consuming to browse the contents of the program for unused samples and delete them one by one. With the PURGE function, you can delete all the unused samples at the same time.

01. In the PROGRAM mode, press the [F1] (SAMPLE) key.
The SAMPLE page will be displayed.
02. Press the [F6] (PURGE) key.
The Purge Samples window will be displayed.
03. Press the [F5] (DO IT) key.
All the samples, which are not assigned to the program, will be deleted at the same time.

Setting a MIDI note number to the pads

The performance data you made by hitting the MPC1000's pads is sent to the internal sampler and sequencer section directly. You can also send the data as a MIDI signal at the same time. The performance data will be sent as MIDI note information. To do so, you need to determine which MIDI note to send out when you hit each pad.

Also, when you load sequence data, which was created with the external sequencer, to the MPC1000 and play the internal sampler section, you have to determine which pad to play by the MIDI note data in the sequence data.

In this section, you will learn how to assign MIDI notes to the pads.

01. In the PROGRAM mode, press the [F4] (NOTE) key.
The NOTE page will be displayed.

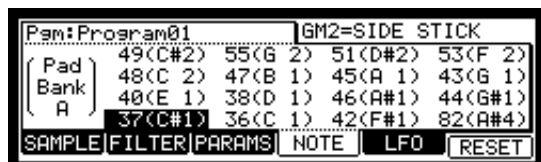

02. Select the desired pad by hitting it.
The note number of the selected pad will be highlighted.
03. Select the note number with the DATA wheel.
In the upper right corner of the screen, the MIDI GM standard name of the drum, which represents

the selected note number, is displayed.

To reset the setting to the default, press the [F6] (RESET) key. All the notes assigned to the pads will be reset to the default setting.

Assigning MIDI note numbers to the pads (changing the default setting)

Normally, when you hit a pad, the MPC1000 will output the MIDI note data assigned to the pad in the program.

However, when the selected track does not have any program assigned, hitting a pad sends out the default MIDI note number, instead of the number set in the program. When you create a new program, this setting will be used as the default setting. You can change this default pad setting in the MIDI/SYNC mode, which can be accessed by pressing the [MODE] key and then the [PAD 9] (MIDI/SYNC).

01. Press the [MODE] key and then the [PAD 9] (MIDI/SYNC).
You can enter the MIDI/SYNC mode.
02. Press the [F3] (NOTE) key.
The NOTE page will be displayed.
03. Select the desired pad by hitting it.
The note number of the selected pad will be highlighted.
04. Select the note number with the DATA wheel.
In the upper right corner of the screen, the MIDI GM standard name of the drum, which represents the selected note number, is displayed.
To reset the setting to the default, press the [F6] (RESET) key. All the notes assigned to the pads will be reset to the default setting.

Chapter 13 : Mixer

In this section, you will learn about the mixer feature. In the MIXER mode, you can edit several settings while checking the status of the pads graphically. This is done in the MIXER mode, which can be accessed by hitting the [MODE] key and then the [PAD 8] (MIXER) on page 83.

Setting the level and pan of the pad

01. Press the [MODE] key and then the [PAD 8] (MIXER).

When you press the [MODE] key, its LED will blink. By pressing [PAD 8] while the [MODE] key's LED is blinking, you will enter the MIXER mode. Pressing the [F1] (L/PAN) key brings up the Level/Pan page.

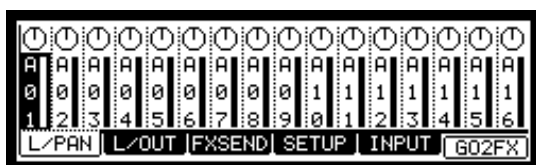

In this display, each column indicates pad 1 through 16, starting from the left, and the currently selected pad is highlighted. The bar display on the bottom indicates the current level. Longer bars indicate higher levels.

The circle in the top of the column indicates the pan setting. The location of the line within the circle indicates the current pan setting.

02. Hit the desired pad.

The column of the selected pad will be highlighted. You can select several pads by hitting pads while holding in the [SHIFT] key. You can also select all pads in the PAD BANK by pressing a [PAD BANK] key while holding in the [SHIFT] key.

Tips : When you select several pads and change a parameter (Level or Pan), the parameter on each pad will be changed relatively with keeping the balance.

03. Press the down cursor key to set the level, and the up cursor to set the pan.

When you press the up cursor key, the cursor will move to the pan display, and you can change the pan setting with the DATA wheel. When you press the down cursor key, the cursor will move to the level display and you can change the level setting with the DATA wheel.

Tips : You can also use the [Q2] (SLIDER) to manipulate the Level, and the [Q1] (SLIDER) to manipulate the Pan of the currently highlighted column(s).

Setting the output for the sample

The MPC1000 has 4 outputs (assignable mix out) as well as the stereo out.

To use an external FX processor to effect a specific pad, assign it one of the assignable mix outs. Now, route cables from that assignable mix outs to your FX processors Inputs. Finally, route cables from your FX processors outputs to the MPC1000s RECORD IN. Now you can either re-sample with the desired effect, or utilize the MPC1000s INPUT THRU feature. In this section, you will learn how to change the output of the sample of the pad.

Note : For more information about connecting to the external effecter or mixer and about the operation of them, see the operation manual of these devices.

01. In the MIXER mode, press the [F2] (L/OUT) key.

The Level/OUT page will be displayed.

Each column indicates pad 1 through 16 from the left and the currently selected pad is highlighted. The display at the top is the field, where you will assign a specific pad to a specific assignable output.

02. Hit the desired pad.

The column for the selected pad will now be highlighted.

03. Press the up cursor key.

You can change the setting by turning the DATA wheel.

ST	The pad will be output to the stereo out.
1/2	The pad will be output to the assignable mix out 1/2.
3/4	The pad will be output to the assignable mix out 3/4.

Tips : The output setting is made in stereo pairs. If you wish to output eight monaural signals separately from the eight assignable mix outs, use the pan settings in the L/PAN page. For example, to use the assignable mix out 1/2 as two mono outs, in the L/OUT page, set the output to 1/2 and set the pan setting of the pad you wish to output from the out 1 and 2 to L and R respectively.

Selecting the pad to apply the effect

With the MPC1000, you can route specific pad(s) to either of two(2) internal FX. To do this, you need to route the pads sample in the FX SEND section.

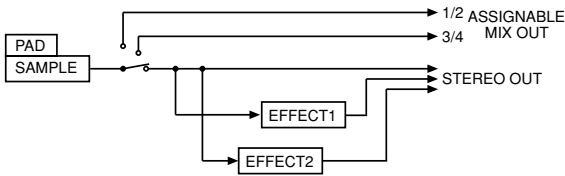

Tips : This picture displays the signal flow of the sample sound to the stereo out through the effect section. As you can see in this picture, you can only apply the effects to a pad whose outputs are set to the stereo out.

You cannot apply the effects to a pads whose outputs are set to the assignable mix output.

01. In MIXER mode, press the [F3] (FXSEND) key.

The FX SEND page will be displayed. Each column indicates pad 1 through 16 from the left to right, and the currently selected pad is highlighted. The display at the top indicates the output setting. The bar display on the bottom indicates the current send level. To adjust this level: simply cursor down and use the DATA wheel.

02. Hit the desired pad.

The column of the selected pad will be highlighted.

03. Press the UP cursor key.

The FX Send field for the effect setting will be selected. You can change the setting by turning the DATA wheel.

- OF No effect will be used.
- 1 The effect 1 will be used. The Pad sound will be sent to the FX1 of the effect section.
- 2 The effect 2 will be used. The Pad sound will be sent to the FX2 of the effect section.

04. Press the DOWN cursor key and adjust the FXSEND level by turning the DATA wheel, when the effect is selected either Reverb or Delay.

Tips : You can also adjust the FXSEND level on the currently highlighted pad(s) by using the [Q2] (SLIDER).

Mixer Automation

The MPC1000 can record the information such as Level and Pan changes so that they will automate during sequence play back.



01. In the MIXER mode, press the [F4] (SETUP) key. The SETUP page will be displayed.

02. In the Record mix changes: field, select YES with the DATA wheel.

If you set this field to YES and change the LEVEL or PAN in the L/PAN page during the sequence is recording, the changed data will be recorded into the sequence. The sequence will be played with changing the Level or the Pan as you did during the recording.

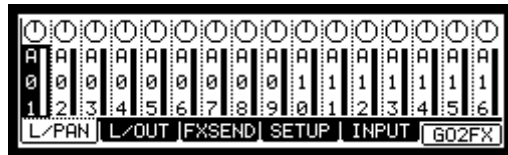

The mixing data recorded in the sequence is displayed in STEP EDIT page as follows and you can edit it same as other MIDI event.

```
P:A0< 36> :LEVEL      : 100
P:A0< 36> :PAN        : L63
```

Note : Level event shares with Level of Q-Link.

Shortcut between MIXER and Effect mode.

While in MIXER mode, you can easily switch to EFFECT mode by using the [F6] (GO2FX) key.

While in EFFECT mode, you can easily switch to MIXER mode by using the [F5] (GO2MIX) key.

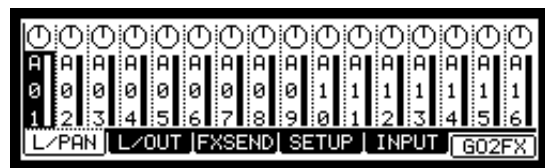

The following menus are available in MIXER/EFFECT mode:

MIXER mode	EFFECT mode
L / PAN page	MASTER page
L / OUT page	MASTER page
FXSEND page	FX page which is selected in FX field.
SETUP page	MASTER page
INPUT page	MASTER page

Tips : This is especially useful when searching for the right effect for the right sample.

Input Thru function

The MPC1000 can mix the incoming signal from REC IN or DIGITAL IN with the play back sound from the MPC1000. You can also route the Input Thru signal to the internal Effects and two (2) Filters. You can control the level, pan, the cut off frequency, the resonance, etc of incoming signal with the Q-Link sliders and knobs.

Applying effects to an incoming signal

Note : In this explanation, some Effect should be selected first. If you don't select any Effect, select some Effect with referring to "Chapter 14 : Effect" on page 83.

01. In MIXER mode, press the [F5] (INPUT) key.

The INPUT page will be displayed.

You can also get to the INPUT page by pressing the [F5] (INPUT) key in the MIXER mode.

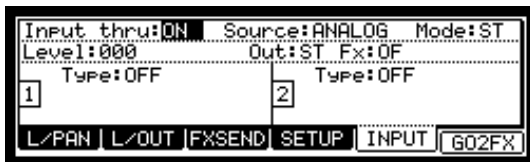

02. In the Input thru field, select ON.

03. Set the following parameters.

Source field : You can select the input signal, ANALOG or DIGITAL.

Mode field : You can select the input signal, ST (Stereo), L (L channel) or R (Right channel)

Level field : You can set the input level. If you select ANALOG in the Source field, adjust the [REC GAIN] volume with using the level meter in the RECORD mode in advance. If you select DIGITAL in the Source field, you cannot use the [REC GAIN] volume.

Pan field : *Note : This field will be displayed only when you select L or R in the Mode field. This will allow you to set the pan position.*

Out field : You can select the outputs of the input thru signal, ST, 12, or 34.

In this example, select the "ST". Remember, you can only route the Input Thru signal to the internal FX if you choose ST as an output.

FX field : You can select the effect of the input thru signal. OF (Off), 1 (Effect 1) or 2 (Effect 2). If you select OF, the input thru signal is not applied any effect.

In this example, select the "1" or "2".

Send field : You can set the effect send level of the Input thru signal. This field will be displayed only when the Effect is selected to REVERB or DELAY in the FX field.

Applying filters to an incoming signal

You can apply the internal filters to the incoming signal from REC IN (Analog) or DIGITAL IN (Digital). You can also control the cut-off frequency and Resonance in real-time by using Q-Link slider.

01. In MIXER mode, press the [F5] (INPUT) key.

The INPUT page will be displayed.

You can also get to the INPUT page by pressing the [F5] (INPUT) key in the MIXER mode.

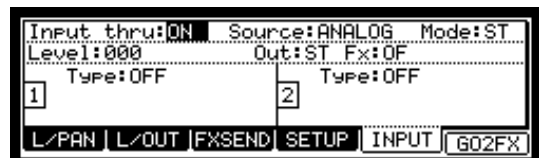

Set the necessary parameter in each field while referring to the Applying effects to an incoming signal.

02. In the Type field, select the filter type.

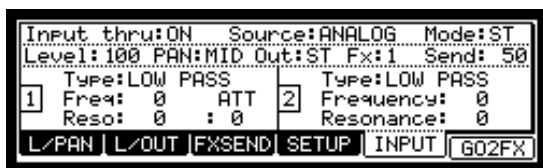

Setting set the filter type is same as in the Filter page while in PROGRAM mode. Refer to “Editing the sound of a sample” in the PROGRAM mode.

Note: You cannot use the Filter Modulation with INPUT THRU.

Using Q-Link feature in INPUT THRU mode

You can control the input level, pan, and the filter’s parameter (Cut-off frequency and Resonance) in real-time by using Q-Link slider.

Note: You cannot record the real-time control of the INPUT THRU into the sequence.

Note: In this explanation, the necessary setting on the filter and the input level/pan for INPUT THRU mode should be entered first. If you haven’t set any parameter for them, set them while referring to “Applying effects to an incoming signal” and “Applying filters to an incoming signal”

01. Select SLIDER mode by pressing [MODE] key then hitting PAD 1 (SLIDER)

02. In the Assign pad field, select IN.

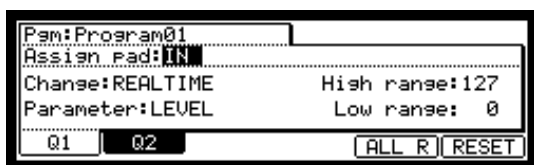

Note: Only “REALTIME” will be available in the Change field.

03. In the Parameter field, adjust the desired parameter.

LEVEL : This control the input signal volume level.

CUTOFF1+2 : This controls the cutoff frequency of both Filter 1 and Filter 2.

CUTOFF1 : This controls the cutoff frequency of Filter 1.

CUTOFF2 : This controls the cutoff frequency of Filter 2.

RESO1+2 : This controls the resonance value of both Filter 1 and Filter 2.

RESO1 : This controls the resonance value of Filter 1.

RESO2 : This controls the resonance value of Filter 2.

PAN : This control the sample’s pan position.

04. In the High range field and Low range field, set the upper and lower limit of the slider or knobs.

The value of the controlled parameter is determined by the value set here. The value depends on the type of the parameter selected in the Parameter field.

LEVEL : 0 –100.

This is linked to the value in Level field in the INPUT page. If you change the slider, the value will be changed depending on the value in INPUT page.

CUTOFF1+2 / CUTOFF1 / CUTOFF 2 : -50 - +50

This value also offsets the current setting in the INPUT page.

RESO1+2 / RESO1 / RESO2 : -50 - +50

Again, this value offsets the current setting in the INPUT page.

Note: In the Input THRU mode, you cannot record the moving of Q-Link in the sequence.

Saving the setting of Input Thru

You can save the setting of the Input Thru as the separate file independent from the Program or Sequence file.

If you save the internal memory data using “SAVE ENTIRE MEMORY”, the Input thru file will be saved with the Project file. The Input Thru setting is contained in an Input Thru file.

When you load the Project file, the Input Thru file will be loaded automatically along with the Project file. You can also load only the Input Thru file. The Input Thru file (. IPT file) is saved as the file with IPT – and the project name.

Chapter 14 : Effect

In this section, you will learn how to select and edit effects. The MPC1000 has two stereo effects and one master effect. To apply the effects to a specific pad sound, use the two stereo effects. To apply effects to the entire sound, use the master effect.

Note : The effect settings will be saved with the ALL file, which is created when you save the data by selecting SAVE ALL SEQs & SONGs.

Applying effects to a specific pad sound

You can apply effects to the selected pad sound. Here, let's apply BIT GRUNGER to the selected pad sound.

01. Press the [MODE] key and then the [PAD 12] (EFFECT).
The EFFECT mode will be displayed.

02. Press the [F1] (SELECT) key.
The SELECT page will be displayed.

03. Move the cursor to the FX1 type field and turn the DATA wheel, or press the [WINDOW] key.
The Select Effect window will be displayed. You can select the effect type by turning the DATA wheel.

04. Select BIT GRUNGER and press the [F5] (SELECT) key.
This closes the window and goes back to the SELECT page.
BIT GRUNGER is selected in the FX1 type field.

05. Press the [MODE] key and then the [PAD 8] (MIXER) to display the MIXER mode.
You select the pad for the effect in the MIXER mode.

06. Press the [F3] (FXSEND) key.
The FX SEND page will be displayed.

07. Hit the desired pad.
This pad will be selected and its display will be highlighted.

08. Press the UP cursor key to select the FX Send field.
The FX Send field for the effect setting will be selected.

OF No effect will be applied to the pad.

1 The effect of the FX1 will be applied to the pad.

2 The effect of the FX2 will be applied to the pad.

Here, select 1.

When you hit the selected pad, the processed sound will be played.

The effected sound will be output from the stereo out.

Tips : you can apply the effect to several pads. The effect of the FX 1 is applied to all the pads whose FX SEND are set to 1 in the FX SEND page of the MIXER mode.

Tips : you can set the effects in details. For more information about detailed editing of each effect, see the "Editing effects" section.

Note : You cannot apply the effects to the pads whose outputs are NOT set to ST (stereo out) in the L/OUT page of the MIXER mode.

Like FX 1, you can use the effects of the FX 2 by selecting an effect in the FX2 type field of the SELECT page in the MIXER mode and setting the FX SEND field to 2 in the FX SEND page of the MIXER mode.

■ Applying reverb

When you select Reverb in the FX type, you need to apply this effect to a specific pad in a slightly different way. Here, assume you have selected REVERB in the FX2 type field.

01. Select REVERB in the FX2 type field and then select the FX SEND page of the MIXER mode.

02. Hit the desired pad.

03. Press the up cursor key to select the FX SEND field and select 2 in the field.

You cannot apply the reverb effect by just selecting the FX SEND. To apply the effect, you need to adjust the signal level sent to the reverb in the send level field.

04. To adjust the signal level sent to the reverb, press the down cursor key and turn the DATA wheel.

This field is called the Send level field, and it displays the value as the bar. The larger the signal level is, the greater the reverb effect becomes.

Tips : You can adjust the send level field to adjust the amount of the reverb for each pad, individually.

Applying effects of the FX2 to the effect sound of the FX1

Normally, the effect sound is sent to the stereo out directly. For example, when using the PHASE SHIFTER in the FX1 and REVERB in the FX2, you cannot apply REVERB in the FX2, since the effect sound of the FX1 is sent to the stereo out. By using the To FX2 field, you can send the output of the FX1 to the FX2 to apply the effect of FX2.

- In the SELECT page of the EFFECT mode, set the To FX2 field to YES.

The sound from the FX1 will be sent to the FX2.

If you set 1 to a pad in the FX SEND page of the MIXER mode, you can apply the effects of both FX 1 and 2 to them.

If you set 2 to a pad in the FX SEND page of the MIXER mode, you can apply the effects of FX2.

Editing effects

In this section, you will learn how to edit effects.

When you press the [F2] (FX1) key in the EFFECT mode, the FX1 page will be displayed, where you can edit the effects selected in the FX1. Likewise, when you press the [F3] (FX2) key in the EFFECT mode, the FX2 page will be displayed, where you can edit the effects selected in the FX2. Also, you can change the effects assigned to FX1 and 2 by selecting the effect type in the FX type field, which is located at the top of each page.

Tips : If you press the [F5] (BYPASS) key in the FX1 and FX2 pages, you can turn off the effects temporarily. This is useful to compare the effected sound and the original sound.

Below is a brief overview on each effect.

■ BIT GRUNGER

This effect adds distortion to the sound to lower the quality of the sound and create the lo-fi sound.

Depth field Sets the amount to lower the sound quality. The larger the value is, the more lo-fi sound will be created.

■ 4 BAND EQ (4 band equalizer)

This effect is the equalizer, which can adjust the 4 frequency bands to correct or process the sound. Low/Hi EQ is a shelving type equalizer, which boosts or cuts the frequencies higher or lower than the specified frequency. The Mid1/2 is a peaking type equalizer, which boosts or cuts the specified frequency and the harmonics surrounding the frequency.

Low frq field You can set the low frequency range.

Low Gain field You can adjust the gain of the low frequency range.

Mid1 frq field You can set the frequency of the mid frequency range 1.

Mid1 Gain field You can set the gain of the mid frequency range 1.

Mid1 Q field You can set the band range of the mid frequency range 1.

Mid2 frq field You can set the frequency of the mid frequency range 2.

Mid2 Gain field You can set the gain of the mid frequency range 2.

Mid2 Q field You can set the frequency range of the mid frequency range 2.

High frq field You can set the frequency of the high frequency range.

High Gain field You can set the gain of the high frequency range.

■ COMPRESSOR

This effect compresses sound which exceeds a certain level, to make the sound levels even.

Threshold field

any signals, which exceed the level set here, will be compressed. The lower the value is, the better the result will be.

Gain field

You can adjust the overall level here. As you lower the value in the Threshold field, the overall level is also lowered. You can adjust the final level in this field.

Ratio field

You can set the compression ratio here. The larger you set the value, the greater the compression becomes and you can make the overall level even.

Attack field

You can set the time it takes to start the compression after the incoming signal exceeds the level set in the Threshold field.

Release field

You can set the time it takes to finish the compression after the incoming signal falls below the level set in the Threshold field.

■ PHASE SHIFTER

This effect adds sounds with different phases to the original sound, to create a swelling or rotating sound.

Sweep rate field

You can set the speed of the modulation here.

Offset L/R field

You can set the amount of the phase shift of L and R. If you set this field to 00, L and R will be in sync. As you increase the value, the phases of the L and R will shift and you can create the complicated effect.

Feedback field

You can set the feed back level from the output to the effect input. The effect will be boosted and create more a unique sound.

Sweep width field

You can set the depth of the modulation here.

Mid point field

You can set the center frequency for the phase shift. If you set this value high, the phase shift will be applied around the high frequency range.

L/R sweep sync field

If you set it to ON, the Sweep rate will be set at the same cycle for both the Left and Right. If you set to OFF, the sweep rate of the right channel will be set slightly higher than that of the left channel. You will be able to create a more complicated effect.

■ TREMOLO

TREMOLO changes the sound level periodically to add a periodic modulation to the amplitude of sound.

Rate field

You can set the speed of the modulation.

Depth field

You can set the depth of the modulation.

Invert field

You can set the inversion of the L/R modulation. When set to OFF, both L and R will be modulated in the same way. When set to ON, L and R will be inverted to create a more complex effect.

SeqSync field

You can set the Rate (the speed of the modulation) with the Beat and the Tick of the tempo in the sequence. When it is set to ON, the display in the Rate field will change to Beat and Tick..

■ FLYING PAN

This effect changes the normal position of the sound periodically and creates the effect, in which it makes the sound feel like is rotating around your head.

**Sweep rate field**

You can set the speed of the sound rotation. The higher the value is, the faster the rotation becomes.

Width field

You can set the shift range of the position (move range). If you set this value higher, the position of the sound changes more drastically.

Sweep curve bend field

You can set the type of the movement of the position.

Pan law field

You can set how to move the position. If you select LINER, the position moves horizontally. If you select ROTATE, the position rotates in circle.

SeqSync field

You can set the Sweep rate (the speed of the sound rotation) with the Beat and the Tick of the tempo in the sequence. When it is set to ON, the display in the Sweep rate field will change to Beat and Tick.

■ REVERB

This effect adds the reverberation to the original sound, to give the spatial effect and depth to the sound.

Input filter field

You can set the cut off frequency of the low-pass filter that you wish to apply to the input signal.

Time field

You can set the length of the reverb. If you set this value higher, you can enhance the special scope of the sound.

HF damp field

You can set the quality of the reverb. The lower value creates harder sounds, and the higher value creates a softer sound.

Reverb level field

You can set the level of the reverb.

■ DELAY

This effect adds delay to the original sound.

Note : DELAY can be selected only in FX2.

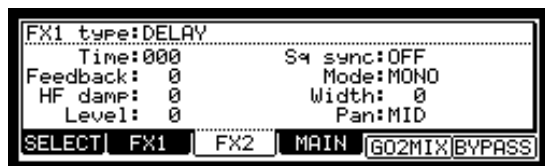

Time field

You can set the delay time of the first delay sound. If the Sq sync field is set to OFF, you can set it to the maximum 999 msec. If the Sq sync field is set to ON, you can set it with the Beat and the Tick.

Feedback field

You can set the feed back level from the output to the effect input. The higher the value is, the more the delay sounds are created.

HF damp field

You can set the quality of the delay sound (High Frequency damp). If you set it to a lower value, it makes the delay sound like a classic analog delay effect.

Level field

You can set the volume level of the delay sound.

Sq sync field (ON/OFF)

You can synchronize the delay sound to the tempo of the sequence. . When it is set to ON, the display in the Time field will change to Beat and Tick. For example, if you set the Time field to "01.00", the delay time will be adjusted automatically to 1/4 notes.

Mode field (PAN/MONO)

This determines whether the delay will be mono or stereo.

MONO : A standard monaural delay.

PAN : A Stereo panning delay that will pan the delays from left to right.

Width field

You select the width of a stereo panning delay. The higher this value is, the wider the delay sound is.

Pan field

You can set the pan position of the delay sound.

■ CHORUS and FLANGER

FLANGER adds modulated delay sounds to the original sound to give a ringing effect to the sound.

Both CHORUS and FLANGER add modulated delay sounds to the original sound to give a ringing effect to the sound. The settings are the same for both effects.

Note : You can select CHORUS and FLANGER only in the FX2.

Slow sweep rate field

You can set the modulation speed here.

Slow sweep depth field

You can set the depth of the modulation here.

Vibrato rate field

You can set the detailed speed of the modulation here.

Vibrato depth field

You can set the detailed depth of the modulation here.

Feedback field

You can set the feed back level from the output to the effect input. The effect will be boosted and create a more unique sound.

L/R sweep sync field

If you set it to ON, the Sweep rate will be set at the same cycle for both the Left and Right. If you set it to OFF, the sweep rate of the right channel will be set slightly higher than that of the left channel and you can also create a more complicated effect.

Using the master effect

The master effect is applied to the overall sound from the stereo out. You can use it separately from the effects of FX1 and FX2. The effects you can use as the master effect are a 4 band equalizer and compressor. With these effects you can add the final touches to the sound.

01. In the EFFECT mode, press the [F4] (MASTER) key.

The MASTER page will be displayed. In the MASTER page, you can edit the master effect.

```
EQ: OFF
-----
H: 1000 +00
1: 0500 +00 00
2: 0250 +00 00
L: 0100 +00
```

02. To use the 4 band EQ, select ON in the EQ field.
03. To use the compressor, select ON in the Compressor field.

Note : If you use neither effects, set these fields to OFF.

Editing the master effects

In this section, you will learn how to edit the master effects in details.

■ 4 band EQ

This is the 4 band EQ (equalizer), which consists of two shelving type Eqs for a high frequency and a low frequency and a 2 band parametric EQ. With the equalizers, you can boost or lower a specific frequency to control the sound from the stereo out.

H field, L field

You can set the frequency and the gain of the equalizers for high frequency (H) and low frequency (L). You can set the frequency in the left field and the gain in the right field.

If you increase the gain in the H field, you can boost the frequency that is higher than the selected frequency.

If you lower the gain, you can lower the level of the frequency that is higher than the selected frequency.

If you increase the gain in the L field, you can boost the frequency lower than the selected frequency.

If you lower the gain, you can lower the level of the frequency lower than the selected frequency.

1 field, 2 field

You can set the parametric equalizer, which can control the sound around the selected frequency. The field has the settings for frequency, gain and Q (from the left).

If you increase the gain, you can boost the sound around the selected frequency. If you lower the gain, you can lower the level of the sound around the selected frequency.

Q setting determines how to change the sound around the selected frequency when you change the gain setting. If you set this value larger, only the narrow range around the selected frequency will be changed. As you lower the value, the range will be wider.

■ Compressor

This effect compresses the signal level that exceeds the selected level to make the volume even as a whole.

The fields are the same as those of the COMPRESSOR, which is selected in the FX1 and 2.

Editing the effect set

The effect set is a set of FX1/FX2/MAIN effect types and their settings. Each effect set can have different settings individually. You can switch the effect sets in the Eff field of the SELECT page.

Tips : You can switch the effect sets within the sequence by entering the EFFECT SELECT event to the sequence.

For more information, see the “Step editing” section on page 31.

In this section, you will learn how to change the name of, copy, and reset the effect set.

■ Changing the name of the effect set

01. In the Eff field of the SELECT page, press the [WINDOW] key.

The Effect Set window will be displayed.

02. In the Effect name field, turn the DATA wheel.

The Name window will be displayed and you can change the effect set name. For more information about the operation in the Name window, see page 10.

03. In the Name window, press the [F5] (ENTER).

It confirms the name and closes the Name window.

■ Copying the effect set

01. In the Eff field of the SELECT page, press the [WINDOW] key.

The Effect Set window will be displayed.

02. In the Effect Set window, press the [F5] (COPY) key.

The Copy Effect Set window will be displayed.

03. In the Eff field (up), select the source effect set.

04. In the Eff field (down), select the destination effect set.

05. Press the [F3] (DO IT) key.

The effect set selected in the Eff field (up) will be copied to the effect set selected in the Eff field (down). Pressing the [F4] (CANCEL) key cancels the operation and closes the window.

■ Resetting the effect set

You can reset the setting for the effect set to the default settings.

01. In the Eff field of the SELECT page, press the [WINDOW] key.

The Effect Set window will be displayed.

02. In the Effect Set window, press the [F2] (RESET) key.

The Reset Effect Setting window will be displayed.

03. In the Eff field, select the effect set you wish to reset.

04. Press the [F5] (DO IT) key.

The settings of the effect set selected in the Eff field will be reset to the default settings. Pressing the [F4] (CANCEL) key cancels the operation and closes the window.

Shortcut between MIXER and Effect mode

You can move from EFFECT mode to MIXER mode with the functional key.



While in EFFECT mode, you can easily switch to MIXER mode by using the [F5] (GO2MIX) key.

The following menus are available in MIXER/EFFECT mode:

MIXER mode	EFFECT mode
L / PAN page	MASTER page
L / OUT page	MASTER page
FXSEND page	FX page which is selected in FX field.
SETUP page	MASTER page
INPUT page	MASTER page

Tips : This is especially useful when searching for the right effect for the right sample.

Chapter 15 : Save / Load

The sample or sequence data you made in the MPC1000 will be deleted when you turn off the unit. If you wish to keep the data, you need to save it to a memory card. You can use the saved files again by loading them into the MPC1000.

About a memory card

The MPC1000 can use the memory card called “compact flash”. The MPC1000 comes with one 32MB (megabyte) compact flash card. You can use any memory card that supports compact flash.

Tips: MB indicates the size of the memory card. The larger this number is, the more data you can store.

Note: The size of the compact flash card that MPC1000 can handle is from 32MB to 2GB.

Note: When you use a new compact flash card with the MPC1000, you need to format the card before use it. For more information about formatting the card, see the “Formatting the memory card” section on page 97.

Saving the data

In this section, you will learn how to save the data. This is done in the SAVE page, which can be accessed by pressing the [MODE] key and then the [PAD 3] (SAVE).

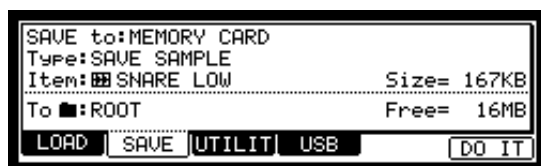

■ Selecting the destination

You can set the location in the memory card to save the data. Here, you will learn how the data will be saved in the memory card and how to select the destination.

01. Insert a compact flash card in the memory card slot, and press the [MODE] key and then the [PAD 3](SAVE).
The SAVE page will be displayed.

Note : Make sure that you insert the compact flash card completely in the slot.

02. In the Save to field, select MEMORY CARD.

03. Select the To field and press the [WINDOW] key.



The Directory window will be displayed. In this window, you can browse the contents of the memory card. The files in the memory card are saved in the directories hierarchically, like other computer files. The folder selected in the To field is displayed in the left of the directory list, and the contents of the folder is displayed in the right of the list. In the picture above, the ROOT folder is selected and the folder has an AUTOLOAD folder.

04. Move through the directory using the left/right cursor keys.

You can use left/right cursor keys to move through the directories. For example, in the picture above, if you press the right cursor key to select the AUTOLOAD folder and then press the right cursor key again, the AUTOLOAD folder will be displayed in the left and the contents of the AUTOLOAD folder will be displayed in the right. If you press the left cursor key, the cursor will move to the left list, and if you press the left cursor key again, the upper directory will be selected and displayed.

Tips: The ROOT folder indicates the top directory of the memory card. There is no other upper directory.

05. Select the folder you wish to save the data to.

The folder whose icon is highlighted (in black) in the left list will be selected as the destination. Even when a folder is selected by the cursor in the right list, the folder in the left list will be selected.

06. Press the [F4] (CLOSE) key.

This closes the window. The folder selected in the Directory window is selected in the To field.

Tips: You can also select the destination folder in the To field of the SAVE page. You can select a folder in the same directory that the currently selected folder is located in, by turning the DATA wheel in the To field. If the currently selected folder has a

folder inside, you can select that folder (in the lower directory) by pressing the right cursor key. You can also move to the upper directory by pressing the left cursor key.

■ Creating a new folder

You can create a new folder and select it as the destination.

01. In the Directory window, select a directory you wish to create a new folder to.

The new folder will be created in the folder currently selected in the left list.

02. In the Directory window, press the [F5] (NEW) key.

The Name window will be opened. Enter the folder name in the window.

For more information about setting the name, see the "Setting names" section on page 10.

03. In the Name window, press the [F5] (ENTER) key.

The new folder will be created in the selected directory. In the Directory window, the new folder is selected.

■ Saving a sample

You can save samples one by one.

01. In the To field of the SAVE page, select the destination folder.

02. In the Type field, select SAVE A SAMPLE.

03. In the Item field, select the sample to save.

You can select the sample data in the memory by turning the DATA wheel.

04. Press the [F6] (DO IT) key.

The MPC1000 starts saving the sample.

- When the destination folder has the data with the same name

If the destination folder already has the data with the same name, the File Exists window will be displayed. To cancel the operation, press the [F4] (CANCEL) key.

To overwrite the data in the memory card with the new data, press the [F2] (REPLAC) key. The data in the memory card will be replaced with the new data. Pressing the [F5] (RENAME) key brings up the Name window, where you can change the name of the file you are about to save. When you enter the name in the Name window and press the [F5] (ENTER) key, the MPC1000 will start to save the data.

■ Saving a program

You can save a program and the samples used for the program.

01. In the To field of the SAVE page, select the destination folder.

02. In the Type field, select SAVE A PROGRAM.

03. In the Item field, select the program to save.

You can select the program data in the memory by turning the DATA.

04. Press the [F6] (DO IT) key.

The Save a Program window will be displayed.

05. In the Save a Program window, make settings for each field.

Save field

You can choose whether or not to save the sample data (sounds) with the program data.

WITH SAMPLES

The MPC1000 will save the program data and the samples used for the program.

Normally you should select this option. When you load the saved program, the MPC1000 will load the samples automatically.

PROGRAM ONLY

The MPC1000 will save only the program data. It does not save the sample data. When you are sure that the samples used for the program are in the selected folder, you can reduce the time to save the data by selecting this operation.

Replace same samples field

You can set how to handle files when the destination location already has a sample with the same name.

NO The MPC1000 will not save the file with the same name. If you loaded the data from the memory card and edited only the program, select NO.

YES The MPC1000 will overwrite the data with the new data, which you are about to save. If you have loaded the data from the memory card and edited the sample data, select YES.

06. Press the [F5] (DO IT) key.

The MPC1000 will start to save the data.

Note : If the destination folder already has the data with the same name, the File Exists window will be displayed.

■ Saving all the programs and the samples at the same time

01. In the To field of the SAVE page, select the destination folder.
02. In the Type field, select SAVE ALL PROGRAMS & SAMPLES.
03. Press the [F6] (DO IT) key.
The Save ALL Programs window will be displayed.
04. In the Save a Program window, make the settings for each field.

Make new folder field

When you save the data you can create a new folder, inside in the current folder selected in the To field, and save the data in the new folder. When you use SAVE ALL PROGRAMS & SAMPLES, a lot of data may be saved. With the Make new folder option, you can easily create a folder for the data you wish to save.

NO The MPC1000 will save the data in the selected folder. A new folder is not created.

YES The MPC1000 will create a new folder and save the data in that folder.

If you select NO, the Replace same files field will be displayed. If the destination folder already has the file with the same name, select NO to cancel the operation and select YES to replace the data in the memory card with the new data. When you select YES, the Folder name field will be displayed. Enter the folder name in this field.

05. Press the [F5] (DO IT) key.
The MPC1000 will start saving the data.

■ Saving a sequence

You can save sequences one by one.

01. In the To field of the SAVE page, select the destination folder.
02. In the Type field, select SAVE A SEQUENCE
03. In the Item field, select the sequence that you wish to save.
You can select the sequence data in the memory by turning the DATA wheel.
04. Press the [F6] (DO IT) key.
Save a Sequence window will be displayed.

05. In the Type field, select the file type.

SEQ The sequence will be saved as a MPC1000 file. The data specific to the MPC1000 will be saved with the sequence. Normally, select this.

MID The sequence will be saved as the Format 1 of SMF (Standard MIDI File). The SMF is a file format set by MIDI standard. If you wish to load the MPC1000's sequence data to another sequencer, select this option. However, the data specific to the MPC1000 can not be saved.

06. Press the [F5] (DO IT) key.
The MPC1000 will start saving the data.

Note : If the destination folder already has the data with the same name, the File Exists window will be displayed. For more information about the Existing window, see the "Saving a sample" section on page 90.

■ Saving all the sequences and the songs at the same time

You can save all the sequences and the songs in the MPC1000 at the same time.

The MPC1000 will save the data as one file called "ALL file", which include all the sequence and the songs, instead of saving individual sequences and song files. When you load the ALL file, you can reset all the sequences and the songs to the status when they are saved. The ALL file includes the effect set data.

01. In the To field of the SAVE page, select the destination folder.
02. In the Type field, select SAVE ALL SEQs AND SONGS.
03. Press the [F6] (DO IT) key.
The Save ALL Seqs & Songs window will be displayed.
04. In the File name field, select the file name to save.
05. Press the [F5] (DO IT) key.
The MPC1000 will start saving the data.

■ Saving all the data in the memory at the same time

You can save sample/program/ALL files at the same time.

When you save the data, a project file will be saved, as well as a sample, program and ALL files. The project file does not have actual sample or sequence data, but it has the information about the sample/program/ALL files that are saved when you save the data. When you load the project file, the sample/program/ALL files saved with the project file will be loaded automatically and set the MPC1000 to the same status when you saved the data. For example, if you select SAVE ENTIRE MEMORY when you save the data after finish working on it for the day, you can start the MPC1000, the next day, from where you finished the previous day.

01. In the To field of the SAVE page, select the destination folder.

02. In the Type field, select SAVE ENTIRE MEMORY.

03. Press the [F6] (DO IT) key.

The Save Entire Memory window will be displayed.

04. In the Project name field, select the name of the project file to save.

05. In the Replace same files field, set how to handle the file when you already have the data with the same name as the loading file in the unit.

NO The MPC1000 will not save the file with the same name.

YES The MPC1000 will overwrite the data by with new file.

06. Press the [F5] (DO IT) key.

The MPC1000 will start saving the data.

About Input Thru (.IPT) file

If you use "SAVE ENTIRE MEMORY" to save the Internal memory data, the Input thru file will be saved with the Project file. The Input Thru file contains the setting of the Input Thru in the MPC1000. When you load the Project file, the Input Thru file will be loaded automatically with the Project file. You can also load only the Input Thru file (IPT File) in the Load page.

■ Creating the Autoload folder

When you create an AUTOLOAD folder on the memory card, the MPC1000 will load the contents of the AUTOLOAD folder automatically when you switch on the unit with the memory card in the card slot. You can load the most frequently used drum set program or sequence data automatically.

01. In the Type field, select SAVE ENTIRE MEMORY.

AUTOLOAD folder will be created in the ROOT folder, which is located at the top directory, so you do not have to select the destination folder.

02. Press the [F6] (DO IT) key.

The Save Entire Memory window will be displayed.

03. Press the [F2] (A.LOAD) key.

The Save Auto load File window will be displayed.

04. Press the [F5] (DO IT) key.

The MPC1000 will create the AUTO LOAD folder in the ROOT folder and save all the data in that folder. If the ROOT folder already has the AUTOLOAD folder, the Autoload Folder Exists window will be displayed.

To replace the current AUTO LOAD folder with a new one, press the [F2] (REPLAC) key. In this case, the contents of the current AUTOLOAD folder will be deleted.

To keep the current AUTOLOAD folder, press the [F4] (CANCEL) key to cancel the operation, go to the Directory folder and change the name of the current AUTOLOAD folder.

Saving data to the internal hard disk (option)

You can save data to the internal hard disk drive (option) as well as the memory card, if the internal hard disk is installed to the MPC1000. When you save the data to the internal hard disk, select HARD DISK, instead of MEMORY CARD, in the Save to field as in procedure "02" Saving data. The other procedure is sama as Saving the data to memory card.

Loading a file

In this section, you will learn how to load a file. The MPC1000 can load a file from the Memory Card, the Internal Flash Memory, the Internal Hard Disk (option). This is done in the LOAD page, which is accessed by pressing the [MODE] key and then the [PAD 2] (LOAD).



■ Selecting a file

To select a file to load, proceed as follows:

01. Press the [MODE] key and the [PAD 2] (LOAD).

The LOAD page will be displayed. To load a file from the memory card, insert the compact flash card in the memory card slot.

Note : Make sure that you insert the compact flash card completely in the slot.

02. Select the LOAD from field and select the memory you wish to load the data from.

INTERNAL MEMORY The MPC1000 will load the data from the internal preset memory. Normally, when you switch on the MPC1000, it will load the data from the preset memory, but you can load these files individually by selecting INTERNAL MEMORY in this field.

MEMORY CARD The MPC1000 will load the files from the memory card in the card slot.

HARD DISK The MPC1000 will load the files from the internal HARD DISK. (Option)

03. Select the folder field or File field, and press the [WINDOW] key.



The Directory window will be displayed. You can also select a file in the folder, and in the File field of the LOAD page, but it is easier to use the Directory window, which displays the files in the list.

In the Directory window, you can browse the files in the

memory. The files in the memory card are saved in the directories hierarchically, like the other computer files.

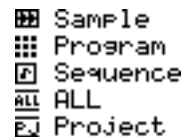

The folder selected in the folder field is displayed in the left of the directory list, and the files selected in the File field are displayed in the right of the list. In the picture above, the SNARE LOW file in the AUTOLOAD folder is selected. Each file has an icon according to their types.

04. Move through the directory using the left/right cursor keys.

You can use left/right cursor keys to move through the directories. For example, when a folder is selected in the right list, if you select the folder with the cursor and press the right cursor key, the selected folder will be moved to the left list and the contents of that folder will be displayed in the right. If you press the left cursor key, the upper directory will be displayed.

Tips : The ROOT folder is the top directory of the memory card. There is no other directory above the ROOT folder.

05. Select the file you wish to load.

06. Press the [F5] (LOAD) key.

The MPC1000 will start loading the data. The next procedures differ depending on the type of selected file.

Tips : You can also select files and switch directories in the File field of the LOAD page. You can select a folder at the same directory level that the currently selected folder is located in, by turning the DATA wheel in the File field. If you have selected a folder in the File field, you can move to the lower directory by pressing the right cursor key. You can also move to the upper directory by pressing the left cursor key in the File field.

Tips : When the sample is selected in File: field in LOAD page, you can audition the sample by pressing [F5](PLAY) key

About View field...

The View field of the LOAD page is normally set to ALL FILES to display all types of the files in the File field or Directory window. You can change the setting of the View to display only the selected type of files. It is useful when you need to find a file from a large list of the files. Select the View field and select the file type to display by turning the DATA wheel.

■ Loading a sample

You can load a sample file one by one. You can also assign the sample to the pad.

01. Select a sample file and load it. The Load a Sample window will be displayed.

You can listen to the sample by pressing the [F2] (PLAY) key.

To cancel the loaded sample, press the [F4] (DISCARD) key.

02. Select the pad to assign the selected sample by hitting it.

When you hit the pad, the pad number will be displayed in the Assign to pad field.

If you do not wish to assign the sample to any pad, select OFF by turning the DATA wheel to the left.

03. Press the [F5] (KEEP) key.

The loaded sample will be assigned to the selected pad.

Tips : You can load the “.snd” files. This includes files from MPC3000/2000/2000XL.

■ Loading a program

You can load a program file one by one.

01. Select a program file and load it. The Load a Program window will be displayed.

To cancel the operation, press the [F4] (CANCEL) key.

02. In the Load field, select if you wish to load the samples as well.

WITH SAMPLES

The MPC1000 will load the samples used for the program as well. Normally select this option.

PROGRAM ONLY

The MPC1000 will load only the program file. It does not load the samples. Select this option when you wish to create a new program by assigning different samples to the saved program.

03. If you selected WITH SAMPLES in the Load field, make settings in the Replace same samples in memory field.

You can set how to handle the file when you already have the data with the same name as the loading file in the unit.

NO The MPC1000 will not load the sample with the same name.

YES The MPC1000 will overwrite the data by the new data.

04. Press the [F5] (DO IT) key.

The MPC1000 will start loading the data.

• Deleting the data in the memory before loading

When you press the [F2] (CLEAR) key instead of the [F5] (DO IT) key in step 4., you can clear the MPC1000's memory and load only the selected program in the memory.

01. In the step 4, press the [F2] (CLEAR) key instead of the [F5] (DO IT) key.

The CAUTION window will be displayed. If you press the [F5] (DO IT) key, the MPC1000 will start loading the program after it clears all its internal memory.

Note : If you do this operation, all the data saved in the unit will be deleted.

■ Loading a sequence

You can load a sequence file one by one.

01. Select the sequence file and load it. The Load a Sequence window will be displayed.
02. In the Load into field, select the destination sequence number.
Select the sequence number to load the data to.
03. Press the [F5] (DO IT) key.
The MPC1000 will start loading the data.

■ Loading the ALL file

You can load the ALL file, which has sequence and song data. When you load the ALL file, all the sequences and songs, which are currently in the MPC1000, will be replaced by the new data.

01. Select the ALL file and load it. The Load ALL (SEQS&SONGS) File window will be displayed.
02. Press the [F5] (DO IT) key.
The MPC1000 will start loading the data.
Loading an individual sequence from the ALL file

• You can load an individual sequence from the ALL file

01. Select the ALL file and load it. The Load ALL (SEQS&SONGS) File window will be displayed.
02. Press the [F3] (SEQ) key.
The Load a Sequence window will be displayed.
03. In the Load file field, select the sequence to load.
In the Load file field, you can select a sequence data in the ALL file.
04. In the Load into field, select the destination sequence.
Select the sequence number to load the data to.
05. Press the [F5] (DO IT) key.
The MPC1000 will start loading the data.

• Loading only the effect set from the ALL file

The ALL file has effect set file, which has the effect setting information. You can load only the effect set from the ALL file.

01. Select the ALL file and load it. Load ALL (SEQS&SONGS) File window will be displayed.
02. Press the [F2] (EFFECT) key.
The Load Effect File window will be displayed.

03. In the Load file field, select the effect set to load.
04. In the Load into field, select the destination effect set.
Select the effect set number to load the data to.
If you select ALL in the Load file field, the current effect set in the unit will be replaced by the data from the ALL file.
05. Press the [F5] (DO IT) key.
The MPC1000 will start loading the data.

■ Loading a folder

You can load a folder and load all the files within the folder at the same time. You can load program, sample, and ALL files.

01. Select a folder and load it. The Load Folder window will be displayed.
02. Make a setting in the Replace same files in memory field.
You can set how to handle the file when you already have the data with the same name as the loading file in the unit.

NO The MPC1000 will not load the file with the same name.

YES The MPC1000 will overwrite the data in the unit by the loaded file.
03. Press the [F5] (DO IT) key.
The loading will begin.

• Loading the folder after deleting the data in the memory

When you press the [F2] (CLEAR) key instead of the [F5] (DO IT) key in step 3, you can clear the MPC1000's memory and load the selected folder.

01. In the step 3, press the [F2] (CLEAR) key instead of the [F5] (DO IT) key.
The CAUTION window will be displayed. If you press the [F5] (DO IT) key, the MPC1000 will start loading the folder after it clears all its internal memory.

Note : If you do this operation, all the data saved in the unit will be deleted.

Note : If the folder has several ALL file, the MPC1000 will load only one of them.

■ Loading a project

When you use SAVE ENTIRE MEMORY mode to save the data, the MPC1000 will load the project file that will be created. When you load a project file, all the data currently saved in the unit will be overwritten by the data that the project file will load.

01. Select a project file and load it. The CAUTION window will be displayed.
02. Press the [F5] (DO IT) key.
The loading will begin.

■ Loading an Input Thru file

If you use "SAVE ENTIRE MEMORY" to save the internal memory data the Input thru file will be saved with the Project file. The Input Thru file contains the settings of Input Thru in the MPC1000.

When you load the Project file, the Input Thru file will be loaded automatically with the Project file. You can also load only the Input Thru (.IPT file) file in the Load page.

Renaming a file

You can change the name of the file in the memory card.

01. In the To field of the SAVE page, press the [WINDOW] key.
The Directory window will be displayed.
02. Select the desired file with a cursor key.
You can move through directories with the left/right cursor keys.
03. Press the [F3] (RENAME) key.
The Name window will be displayed.
04. Enter the new name and press the [F5] (ENTER) key.
For more information about setting the name, see the "Setting names" section on page 10.

Note : If you change the file name, the MPC1000 may not be able to load the file properly. For example, the samples used for a program are saved in the program file as the sample name. IF you change the name of the sample file, the MPC1000 cannot find it when loading the program.

Deleting a file

You can delete the files in the memory card.

01. Open the Directory window in the SAVE page.
02. Select the desired file with a cursor key.
You can move through the directories with left/right cursor keys.
03. Press the [F2] (DELETE) key.
The Delete File window will be displayed.
04. Press the [F5] (DO IT) key.
The selected file will be deleted.

Note : You can select a folder and delete it. If you delete a folder, all the files in that folder will be deleted.

Setting the auto load function

In default, the auto load function, which loads the preset sounds and demo sequence automatically when you switch on the MPC1000, is activated. You can deactivate this function so that the MPC1000 will not load anything when switched on.

01. Press the [WINDOW] key in the LOAD from field of the LOAD page.
The Load Setup window will be displayed.
02. In the Autoload field, set the field to OFF.
03. Press the [F4] (CLOSE) key to close the window.
Next time you switch on the MPC1000, it will not load anything.

Tips : You can load the preset sounds and the demo sequence separately by selecting the INTERNAL MEMORY in the LOAD from field of the LOAD page.

Tips : When you insert the memory card, which has AUToload folder, into card slot and switch on the MPC1000, the MPC1000 will load the AUToload folder in the memory card automatically, regardless of the setting in the Autoload field.

Formatting the memory card

You can format the memory card. Please note that if you format the card, all the data in the card will be deleted.

01. Press the [MODE] key and then the [PAD 2] (LOAD) or the [PAD 3] (SAVE).
02. Press the [F3] (UTILIT) key.
The Utility page will be displayed.
03. Press the [F6] (DO IT) key.
The CAUTION window will be displayed.
04. Press the [F5] (DO IT) key.
The MPC1000 will start formatting the card.

Saving the data to the internal flash memory

If you select INTERNAL MEMORY in the SAVE to field of the LOAD page, you can save the data to the MPC1000's internal flash memory. This is available only when SAVE ALL PROGRAMS&SAMPLES or SAVE ALL SEQS&SONGS is selected in the Type field. You cannot save the individual sample or sequence data.

The saved data will be loaded automatically when you turn on the MPC1000, like the preset program and the demo sequence.

Note : The internal flash memory has the factory preset program and demo sequence. When you save the data into the internal flash memory, the new data will overwrite the factory data.

■ When SAVE ALL SEQS & SONGS is selected

01. Select INTERNAL MEMORY in the SAVE to field of the Save page.
02. Select SAVE ALL SEQS & SONGS in the Type field.
03. Press the [F6] (DO IT) key.
The CAUTION window will be displayed. In this window, press the [F5] (DO IT) key.
The CAUTION window will be displayed again, asking for the confirmation. Press the [F3] (DO IT) key to save the data.

■ When SAVE ALL PROGRAMS & SAMPLES is selected

The internal flash memory cannot have the file that is larger than 5 MB. Make sure that the value in the Size field, which will be displayed when you select SAVE ALL PROGRAMS & SAMPLES in the Type field of the SAVE page, does not exceed 5M.

01. In the SAVE to field of the Save page, select INTERNAL MEMORY.
02. In the Type field, select SAVE ALL PROGRAMS & SAMPLES.
03. Press the [F6] (DO IT) key.
The CAUTION window will be displayed. In this window, press the [F5] (DO IT) key.
The CAUTION window will be displayed again, asking for the confirmation. Press the [F3] (DO IT) key to save the data.

Tips : The INTERNAL folder in the compact flash memory that comes with the MPC1000 contains the same factory preset programs and demo sequences that are saved in a MPC1000's flash memory. You can reset the flash memory to the default data, by loading these files from the INTERNAL folder and saving them into the flash memory.

Chapter 16 : Connecting the MPC1000 to your computer

The MPC1000 supports the USB mass storage class. When you connect the MPC1000 to a PC that supports USB mass storage class, the PC will recognize the memory card (the Internal Hard Disk (option)) in the MPC1000 as a removable media drive. You can transfer the data between the recognized memory card /the Internal Hard Disk (optional) and the PC.

You can save the data on the memory card /the Internal Hard Disk (optional) to the PC, or you can load the data from the PC to the memory card /the Internal Hard Disk (optional) .

You need Windows 2000/Me/XP or later version, or MacOS 9.x/10.x or later version.

Note : The computer cannot recognize the MPC1000's internal memory directly. To save the data in the internal memory to the computer, you need to save the data to the memory card first / the Internal Hard Disk (optional). Also, the data from the computer will be saved to the memory card / the Internal Hard Disk (optional). To use the data in the MPC1000, load the data from the memory card / the Internal Hard Disk (optional).

Connecting the MPC1000 to a Windows - based PC

01. Insert the memory card in the card slot of the MPC1000.
02. Press the [MODE] key and then the [PAD 2] (LOAD), or the [PAD 3] (SAVE).
In the Load from or Save to field, select MEMORY CARD. If you wish to load /save to/from the internal hard disk, select HARD DISK.
03. In the LOAD page or SAVE page, press the [F4] (USB) key.
This brings up the USB page, which you use to connect the MPC1000 to the PC. That is all for the MPC1000.
04. Connect the MPC1000's USB slave jack to the PC's USB host jack via USB cable.
05. When you connect the MPC1000 to the PC for the first time, the message, " Found New Hardware " will be displayed and follow the instruction on the display.
Once the PC recognizes the MPC1000, its "Removal" icon will be displayed in the task bar. In the Device Manager, the MPC1000 will be displayed as a USB Mass Storage Device.
06. In My computer, the MPC1000 is displayed as a removable disk.
To save the data to a PC, select the data and drag and drop it from the removable disk to the hard disk.
To load the data, select the data and drag and drop it from the hard disk to the removal media.
07. When you finish the data transfer, click the "Removal" icon on the PC's task bar and select the " Stop USB Mass Storage Device - Drive(:)" .

Note: In the " (:)", the alphabet is displayed, which indicates the drive in the PC.

When you select to stop the device, the "USB Mass Storage Device is ready to remove safely." dialog box will be displayed.

08. Remove the USB cable from the USB jacks of the MPC1000 and the PC.

Note: Make sure that you do Step 07 "Remove the device" before disconnecting the USB cable.

Note: You can transfer the data between the MPC1000 and the PC only when the USB page is displayed. You can not move to another page or mode from USB page unless you disconnect the USB cable.

Connecting the MPC1000 to the Macintosh

01. Insert the memory card to the MPC1000's card slot.
02. Press the [MODE] key and then the [PAD 2] (LOAD), or [PAD 3] (SAVE).
In the Load from or Save to field, select MEMORY CARD. If you wish to load /save to/from the internal hard disk, select HARD DISK.
03. In the LOAD page, or the SAVE page, press the [F4] (USB) key.
This brings up the USB page, which you use to connect the MPC1000 to the PC. That is all for the MPC1000.
04. Connect the MPC1000's USB slave jack to your computer's USB host jack via USB cable.
05. Removal media will be displayed on the desktop.
To save the data in the computer, select the data and drag and drop it from the removable disk to the hard disk. To load the data from the computer, select the data and drag and drop it from the hard disk to the removal media.

06. After you finish the data transfer, select the removable media and drag and drop to the trash can.

When you drag the removal media to the Dock's recycle bin under Mac OS 10.x, the icon will change to the eject icon.

07. Remove the USB cable from the USB jacks of the MPC1000 and the computer.

Note: Make sure that you do Step 06 before disconnecting the USB page.

Note: You can transfer the data between the MPC1000 and the PC only when the USB page is displayed.

You can not move to another page or mode from USB page unless you disconnect the USB cable.

Chapter 17 : Other settings

In this section, you will learn about the other features, which were not mentioned in the other chapters.

Foot switch

You can connect up to 2 foot switch to the MPC1000 and assign several functions (ex. Start/Stop a sequence, etc...) to them.

01. Connect a foot switch to the MPC1000's FOOTSWITCH jack.
02. Press the [MODE] key, and then the [PAD 10] (OTHER). You will enter to the OTHER mode.
03. Press the [F3] (FOOTSW) key.
This brings up the FOOTSW page, where you can make settings for the foot switch.
04. Select the function to assign to the foot switch 1 in the Footswitch 1 field, and the function to assign to the foot switch 2 in the Footswitch 2 field.

You can select the following functions.

PLAY START	It works the same as the PLAY START key.
PLAY	It works the same as the PLAY key.
STOP	It works the same as the STOP key.
PLAY/STOP	When you step on the switch in stop mode, the MPC1000 will start the playback. When you step on the switch in play mode, the MPC1000 will stop the playback.
REC+PLAY	It works as the same when you press the REC key and the PLAY key simultaneously (recording).
OVER DUB+PLAY	It works as the same when you press the OVER DUB and PLAY keys simultaneously (overdub).
REC/PUNCH	When you step on the switch in stop mode, the MPC1000 will start the playback, when you step on the switch in play mode, it starts recording, in recording mode, it starts playback.
OVER DUB/PUNCH	When you step on the switch in stop mode, the MPC1000 will start the playback, when you step on the switch in play mode, it starts overdubbing, in overdub mode, it starts playback.

TEMPO TAP	It works the same as the TEMPO/NOTE REPEAT key.
PAD1 through 16	The MPC1000 will play the selected pad at the fixed velocity of 127 (maximum).
F1 through F6	They work the same as the function keys 1 through 6.
PAD BANK A through D	They work the same as the PAD BANK keys.
REPEAT	It works the same as the NOTE REPEAT key.

Adjusting the master level

You can adjust the level of the headphone and the stereo out by turning the MAIN VOLUME knob. The MAIN VOLUME changes the analog signal level. This will also adjust the entire level of the MPC1000 digitally.

01. Press the [MODE] key and then the [PAD 10] (OTHER).
It switches to the OTHER mode.
02. Press the [F1] (GLOBAL) key.
The GLOBAL page will be displayed.
03. In the Master level field, set the level.

You will set the digital signal level, which will be sent out to the DA converter. The MPC1000 can output up to 32 sounds simultaneously. There is the great difference in the level when you play single sample and play 32 sounds. If you increase the value in the Master level field, you can increase the entire level of the MPC1000 to create more powerful sound with less noise. However, if you playback many sounds at the same time, the level may be overloaded, which may cause distortion. If you decrease the value in the Master level field, you can prevent distortion when you play many sounds at the same time. However, you cannot have a good result in respect to the noise or punch of the sound. Set the appropriate value in the Master level field depending on the application.

Adjusting the contrast of LCD

You can adjust the contrast of the LCD display by turning the DATA wheel with holding [SHIFT] key. Adjusting the contrast of LCD can be done in any page.

Initialize to Factory Preset

Various Sample and Sequence settings can be saved to Compact Flash when the file is saved. The global settings found in the MPC1000 (listed below) are saved to the internal Flash Memory and stored when the MPC1000 is turned off. You can re-initialize the Factory Preset settings using the following procedure.

01. Turn the MPC1000 on while holding the [ERASE] key.
02. Release the [ERASE] key after the display shows [MPC1000 (##MB installed)].

Now the MPC1000 is reset to the Factory Preset settings.

The following global settings are stored in the MPC1000 :

Timing Correct (Note value, Swing%)

Click/Metronome (Count in, Rate, In play, In rec)

Step Edit Options (Auto step increment, Duration of recorded notes)

Active track receive channel

Soft thru

Sync in

Sync out

Master level

Sustain pedal to duration

Truncate duration

Tap average

Footswitch 1

Footswitch 2

Autoload

LCD contrast

Adjustment of Pad Sensitivity

Each time you hit a pad, the MPC1000 determines how hard you hit the pad, and converts this to a MIDI Velocity value. This parameter is used to determine the strength/weakness of the internal sound during playback.

If you find it difficult to achieve a comfortable velocity range for your playing style, e.g. you can not get a velocity of 127 even you hit the Pad very hard, or vice versa, you get velocity 127 easily even you hit the Pad softly, you can adjust the Pad Sensitivity and the velocity curve as desired.

* The Pad sensitivity and the Velocity curve can be adjusted for each Pad separately.

01. Press the [MODE] key and then the [PAD 10] (OTHER).

02. Press [F4] (PAD) key.

The Pad page will be displayed.

03. Select the Pad you wish to adjust the Pad Sensitivity by hitting it.

The selected Pad Number will be displayed in the upper left corner of the screen. The number of the current Pad sensitivity and the current Velocity curve will be displayed in Pad sensitivity field and Velocity curve field. The velocity number will be displayed in the right "Velocity" field depending on how hard you hit the Pad. (The range of Velocity is between 1 and 127).

The bar meter will be displayed the strength of pressing the Pad while pressing the Pad.

04. Select the Pad Sensitivity field and Adjust the Pad sensitivity number as you hit the Pad.

If the Pad sensitivity number is set to low number, it's harder to get a high velocity value even if you hit the Pad hard. If the Pad sensitivity number is set to high number, it may become too easy to get high velocities even hitting the Pad softly.

You should set the Pad sensitivity number to 1 (Minimum), and increase the Pad sensitivity number while hitting the Pad until the velocity number at the right displays 127 when you hit the Pad with the strength you wish to use to get Velocity 127.

Velocity Curve maps

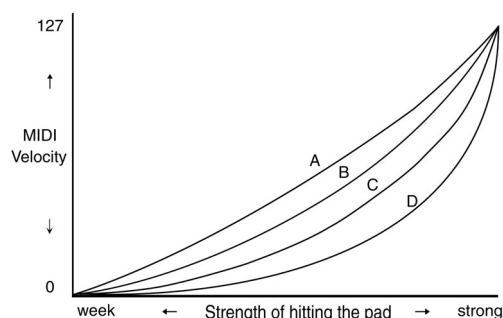

05. Select the Velocity curve field and adjust the Velocity curve while hitting the Pad.

The velocity curve maps the strength of hitting the Pad to MIDI velocity data. If the Velocity response is not enough even with a range hard/soft Pad hits, try switching the velocity curve from A-B-C- D.

Specifications

General

Display	240 x 64 dot graphic LCD w/back light
Memory card slot	Compact Flash (The size of the compact flash card that MPC1000 can handle is from 32MB to 2GB)
Dimensions (W x H x D)	330 x 75.5 x 228.2(Max 234.6)
Weight	3.45kg
Power requirement	19W

Sound generator

Sampling rate	44.1kHz
Memory capacity	16MB standard (11.5MB for sound memory), expandable to 128MB
Recording time	136sec. (16MB, MONO), 24m28sec. (128MB, MONO)
Memory expansion slot	1 x for optional EXM128
Data format	16-bit linear
Polyphony	32
Dynamic filtering	2 x 2-pole filter per voice
Filter type	Low pass, Band pass, High pass
Preset sound memory	5MB
Number of programs	24

Effects

Effects	2 stereo effects and Master effect
Effect type	Chorus, Flanger, Bit grunger, 4 band EQ, Compressor, Phase shifter, Tremolo, Flying pan, Reverb, Delay
	Master effect: 4 band EQ, Compressor

Sequencer

Maximum events	100,000 notes
Resolution	96 parts per 1/4-note
Sequences	99
Tracks per sequence	64
MIDI output channels	32 (16 channels x 2 outputs)
Song mode	20 songs, 250 steps per song
Drum pad	16 (velocity and pressure sensitive)
Drum pad banks	4
Sync mode	MIDI clock

Inputs/Outputs

Record input (L and R)	1/4-inch stereo phone x 2, balanced -40dBu, input impedance 11k ohms; Max. Input level +10dBu
Digital input	RCA-pin x 1 S/PDIF
Stereo output (L and R)	1/4-inch phone x 2 unbalanced +11dBu, output impedance 1k Ohms, Max. output level +17dBu
4 individual outputs	1/4-inch phone x 4 unbalanced +11dBu, output impedance 1k Ohms, Max. output level +17dBu
Phones output	1/4-inch stereo phone x 1, 200mW / 100 ohms
Digital output	RCA-pin x 1 S/PDIF
MIDI inputs	5-pin DIN x 2
MIDI outputs	5-pin DIN x 2
USB	Slave connector x 1, USB MASS STORAGE CLASS support (You need Windows 2000/Me/XP or later version, or MacOS 9.x/10.x or later version.)
Footswitches	1/4-inch phone x 2

Standard accessories

Standard accessories 32MB Compact Flash card, Power cable, Operator's manual

Options

EXM128 128MB expansion memory card
Kit - HDM10 The installation kit for Internal Hard Disk drive

Data Compatibility

MPC1000	SEQ, WAV, PGM
MPC2000/2000XL	SEQ, WAV, SND, PGM (Most parameters of PGM file can be loaded.)
MPC2500	SEQ, WAV, PGM
MPC4000	SEQ, WAV, PGM (DRUM program only. Only note assign and tune are loaded.)
MPC3000	SND (THRU Computer)
Z4/Z8	WAV, PGM (DRUM program only. Only note assign and tune are loaded.)
S5000/6000	WAV only (THRU Computer)
S1000/3000	No compatibility

Preset program list

MPC1000's internal flash memory and the compact flash memory card that comes with the unit have the following factory preset programs.

Internal Flash Memory

- DJ-Hip_Set
- Nuskool_Set
- Ill_Hip_Set
- E-Kit
- Standard_Set
- UK_Kit
- R-D&B_Set
- LA_Kit
- R_Bass
- Rock_GTR
- Arp_Wave
- Str&Bass
- M_Bass

Compact Flash Memory Card

- INTERNAL
 - DJ-Hip_Set
 - Nuskool_Set
 - Ill_Hip_Set
 - E-Kit
 - Standard_Set
 - UK_Kit
 - R-D&B_Set
 - LA_Kit
 - R_Bass
 - Rock_GTR
 - Arp_Wave
 - Str&Bass
 - M_Bass

- Autoload
 - DJ-Hip_Set
 - Nuskool_Set
 - Ill_Hip_Set
 - E-Kit
 - Standard_Set
 - UK_Kit
 - R-D&B_Set
 - LA_Kit
 - R_Bass
 - Rock_GTR
 - Arp_Wave
 - Str&Bass
 - M_Bass

Note : The internal flash memory and the compact flash memory card also have the demo sequence, which is created with the preset program.

Note : The INTERNAL folder in the compact flash memory that comes with the MPC1000 contains the same factory preset programs and demo sequences that are saved in a MPC1000's flash memory.

AKAI professional M.I. Corp.
 Model : MPC1000 (Sampler Section)

Date : September, 2005
 Version : 2.0

MIDI Implementation Chart

Function	***	Transmitted	Recognized	Remarks
Basic Channel	Default	X	1 - 16	
	Changed	X	1 - 16	
Mode	Default	X	1	
	Messages	X	X	
	Altered	X	X	
Note Number		X	35 - 98	
	True Voice	X	35 - 98	
Velocity	Note on	X	O	
	Note off	X	X	
After Touch	Key's	X	X	
	Ch's	X	O	Used in Note Repeat feature
Pitch Bend		X	X	
Control Change	0 - 127	X	X	
Program Change		X	0 - 127	
	True #			
System Exclusive		X	X	
System Common	: Song Position	X	X	
	: Song Select	X	X	
	: Tune	X	X	
System Real Time	: Clock	X	X	
	: Commands	X	X	
Aux Messages	: Local on/off	X	X	
	: All Note Off	X	O	
	: Active Sense	X	X	
	: Reset	X	X	
Notes:				

Mode 1 : OMNI ON, POLY Mode 2 : OMNI ON, MONO
 Mode 3 : OMNI OFF, POLY Mode 4 : OMNI OFF, MONO

O : YES
 X : NO

AKAI professional M.I. Corp.
Model : MPC1000 (Sequencer Section)

Date : September, 2005
Version : 2.0

MIDI Implementation Chart

Function	***	Transmitted	Recognized	Remarks
Basic Channel	Default	1 - 16	1 - 16	
	Changed	1 - 16	1 - 16	
Mode	Default	3	1	
	Messages	X	X	
	Altered	X	X	
Note Number		0 - 127	0 - 127	
	True Voice	0 - 127	0 - 127	
Velocity	Note on	O	O	
	Note off	X	X	
After Touch	Key's	O	O	
	Ch's	O	O	
Pitch Bend		O	O	
Control Change	0 - 127	O	O	
Program Change		O	O	
	True #	0 - 127	0 - 127	
System Exclusive		O	O	
System Common	: Song Position	O	O	
	: Song Select	X	X	
	: Tune	X	X	
System Real Time	: Clock	O	O	
	: Commands	O	O	
Aux Messages	: Local on/off	X	X	
	: All Note Off	O	X	
	: Active Sense	X	X	
	: Reset	X	X	
Notes:				

Mode 1 : OMNI ON, POLY Mode 2 : OMNI ON, MONO
Mode 3 : OMNI OFF, POLY Mode 4 : OMNI OFF, MONO

O : YES
X : NO

INDEX

[%]

% field 33

[1]

1 - 4 field 66
16 level function 41

[A]

Active track receive channel field 48
AFTER key 45
Amount field 27
Amp Envelope 69
Assign pad field 44
Assign to pad field 51
Attack field 69
Autoload field 96
Auto step increment field 36

[B]

Barsfield 37

[C]

CC field 34
Channel pressure event 34
Click, Metronome feature 16
Control change event 34
Copies field 27
Count in field 16
Cursor, Cursor key 3/9
Current tempo field 33

[D]

DATA Wheel 3/9
Dcy md field 69
Decay field 69
Detect Tempo 57
Drum pad 7
Duration of recorded notes field 36
D field 32/34

[E]

Edit field 26
Effect select event 33
End field 53
Erase feature 14
Event field 31
Event list 31
Event time field 31
Exclusive data event 34

[F]

Field 9
Filter 72
Filter envelope 70
Footswitch field 100
Freq field 72
Full level function 41
Function key 9
FX Send field 80/83
FX1 type field 83
FX2 type field 83

[G]

GO2FX 80
GO2MIX 88

[H]

High range / Low range field 50
HOLD Key 48

[I]

Initial tempo field 33
Ignore tempo change events in
sequence field 40
In play field 16
In rec field 16
Input field 50
Input thru function 81

[L]

Layer 1 field 67
LFO 77
LOAD from field 93
Load field 94
Local control 49
Lp field 64
Lvl field 67

[M]

MAIN page 9
Make new folder field 91
Master level field 100
8
MIDI 24
MIDI sequencer 24
Mixer automation 80
MODE key 3/9
MOVE 35/40
Monitor field 52
Mute group field 74
Mute target feature 74

[N]

N field 34
Note event 34
Now field 12
Note repeat feature 17
Note variation value field 32
Note variation field 32
Numeric keys 3

[O]

Out field 79

[P]

P field 32
Pad bank 41
Pad event 32
Pad sample edit 75
Parameter field 44
PATCHED PHRASE 44
Peak hold/Reset pak feature 52
Pgm field 66
Pitch bend event 34
Pitch shift 58
Poly pressure event 34
Program 7
Program change event 34
Punch In/Punch Out feature 17

[R]

RAM 8
Range field 68
Rate field 16
Reference sq field 30
Region 60
Replace same files in memory field 95
Replace same files field 92
Replace same samples in memory field
94
Replace same samples field 90
Reps field 37/38
Reso field 72
Reverse 56

[S]

Sample	8
Sample field	53
Save field	90
Send level field	90
Sequence	6
Sequence field	42
Sequence list	43
Shift Timing	28
SLICED SAMPLE	59, 62
Soft thru field	48
Solo function	42
Song	6
Song field	37
Sq field	12
St field	53
Start / Loop link field	65
Step field	37
Step list	37
SUDDEN key	43
	25
Sustain pedal to duration field	25
Sync in field	47
Sync out field	47
Swing feature	15

[T]

Tap tempo feature	18
Tempo change event	33
Tempo field	37
Threshold field	50
Timing correct feature	15
Time Stretch	56
To FX2 field	84
Truncate duration field	20
Tr field	12
Track	6
Track list	43
Track mute feature	22
Track type	21
Track velocity feature	22
Tune field	67
Type field (16 LEVELS)	41
Type field (PROGRAM)	72

[U]

Undo sequence feature	14
-----------------------	----

[V]

V > Freq field	73
V > Level field	67
View field (LOAD)	93
View field (STEP EDIT)	31
Voice overlap field	74
V field	32/34

[W]

WINDOW key	3/9
------------	-----



AKAI professional M.I. Corp.



Printed in China