

KROME

MUSIC WORKSTATION

Parameter Guide

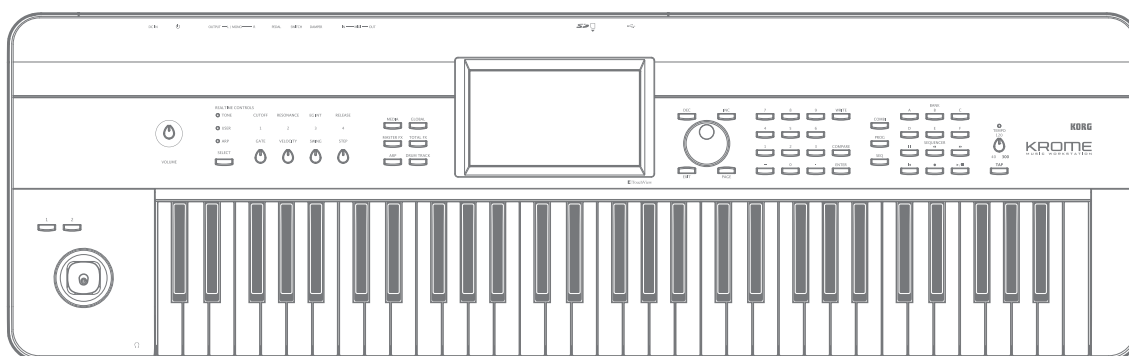

EDS-X Enhanced Definition
Synthesis - eXpanded

RIMS

KORG

About this manual

The manuals and how to use them

The KROME comes with the following manuals.

- Video Manual (approximately 60 minutes)
- Quick Start Guide (printed and PDF)
- Operation Guide (PDF)
- Parameter Guide (PDF)
- Voice Name List (PDF)

All of these manuals are on the included accessory disc. A printed copy is included only for the Quick Start Guide.

Video Manual

This video illustrates the main functionality of the KROME.

Quick Start Guide

This provides a simple explanation of the KROME's functions. To begin, please watch the Video Manual and read the Quick Start Guide.

Operation Guide

Put simply, the Operation Guide is designed to answer the question, "How do I do this?"

It explains the names and functions of each part of the KROME, basic operation, an overview of each mode, how to edit sounds, record on the sequencer, and so on.

This guide also explains the basics of effects, the Arpeggiator, Drum Track, and Drum Kits.

Finally, it also contains a troubleshooting guide as well as supplemental information such as a list of specifications.

Parameter Guide

The Parameter Guide is designed to answer the question, "What does this do?"

Organized by mode and page, the Parameter Guide includes information on each and every parameter in the KROME.

Voice Name List

The Voice Name List lists all of the sounds and setups that are in the KROME when it is shipped from the factory, including Programs, Combinations, Multisamples, Drumsamples, Drum Kits, Arpeggio Patterns, Drum Track Patterns, Template Songs, and Effect Presets.

PDF versions

The KROME PDF manuals are designed for easy navigation and searching. They include extensive PDF contents information, which generally appears on the side of the window in your PDF reader and lets you jump quickly to a specific section. All cross-references are hyper-links, so that clicking on them automatically takes you to the source of the reference.

Conventions in this manual

References to the KROME

The KROME is available in 88-key, 73-key, and 61-key models. The manuals refer to all models without distinction as "the KROME." The front panel and rear panel illustrations in the manual show the 61-key model, but they apply identically to the other models.

Abbreviations for the manuals: QS, OG, PG, VNL

In the documentation, references to the manuals are abbreviated as follows.

QS: Quick Start Guide

OG: Operation Guide

PG: Parameter Guide

VNL: The Voice Name List

Symbols, , , Note, Tips

These symbols respectively indicate a caution, a MIDI-related explanation, a supplementary note, or a tip.

Example screen displays

The parameter values shown in the example screens of this manual are only for explanatory purposes, and may not necessarily match the values that appear in the Display of your instrument.

MIDI-related explanations

CC# is an abbreviation for Control Change Number.

In explanations of MIDI messages, numbers in square brackets [] always indicate hexadecimal numbers.

* All other product and company names are trademarks or registered trademarks of their respective holders.

Table of Contents

| | |
|--|-----------|
| About this manual | ii |
| Program mode | 1 |
| PROG Page Select | 1 |
| PROG P0: Play | 2 |
| 0-1: Main | 2 |
| 0-3: Mixer & Drum Track | 5 |
| 0-5: Arpeggiator | 6 |
| 0-7: Tone Adjust | 7 |
| PROG P1: Basic/Controllers | 12 |
| 1-1: Program Basic | 12 |
| 1-2: Note-On/Scale | 14 |
| 1-3: Controllers Setup | 16 |
| PROG P2: OSC/Pitch | 17 |
| 2-1: OSC1 Setup | 17 |
| 2-2: OSC1 Velocity | 19 |
| 2-3: OSC1 Pitch | 20 |
| 2-5: OSC2 Setup | 22 |
| 2-6: OSC2 Velocity | 22 |
| 2-7: OSC2 Pitch | 23 |
| 2-10: Pitch EG | 23 |
| PROG P3: Filter | 26 |
| 3-1: Filter1 | 26 |
| 3-2: Filter1 Keyboard Track | 28 |
| 3-3: Filter1 Modulation | 29 |
| 3-4: Filter1 LFO Mod. | 30 |
| 3-5: Filter1 EG | 31 |
| 3-6: Filter2 | 34 |
| 3-7: Filter2 Keyboard Track | 34 |
| 3-8: Filter2 Modulation | 34 |
| 3-9: Filter2 LFO Mod. | 34 |
| 3-10: Filter2 EG | 34 |
| PROG P4: Amp/EQ | 35 |
| 4-1: Amp1/Driver1 | 35 |
| 4-2: Amp1 Modulation | 36 |
| 4-3: Amp1 EG | 38 |
| 4-5: Amp2/Driver2 | 40 |
| 4-6: Amp2 Modulation | 40 |
| 4-7: Amp2 EG | 40 |
| 4-10: EQ | 41 |
| PROG P5: LFO | 42 |
| 5-1: OSC1 LFO1 | 42 |
| 5-2: OSC1 LFO2 | 44 |
| 5-5: OSC2 LFO1 | 44 |
| 5-6: OSC2 LFO2 | 44 |
| 5-10: Common LFO | 45 |
| PROG P6: AMS/Common Key Track (AMS Mixer/Common Keyboard Track) | 46 |
| 6-1: OSC1 AMS Mix1 | 46 |
| 6-2: OSC1 AMS Mix2 | 51 |
| 6-4: OSC 2 AMS Mix1 , 6-5: OSC 2 AMS Mix2 .. | 51 |
| 6-9: Common KeyTrk 1 (Common Keyboard Track 1) | 51 |
| 6-10: Common KeyTrk 2 (Common Keyboard Track 2) | 52 |
| PROG P7: ARP/DT (Arpeggiator/Drum Track) | 53 |
| 7-1: ARP Setup | 53 |
| 7-2: ARP Scan Zone | 55 |
| 7-4: Drum Track Pattern | 55 |
| 7-5: Drum Track Program | 56 |
| PROG P8: Routing/IFX (Insert Effect) | 58 |
| 8-1: Routing | 58 |
| 8-2: Insert FX Setup | 59 |
| 8-3: IFX1 | 60 |
| 8-4: IFX2, 8-5: IFX3, 8-6: IFX4, 8-7: IFX5 | 60 |
| PROG P9: MFX/TFX/LFO (Master/Total Effect/ LFO) | 61 |
| 9-1: Routing | 61 |
| 9-2: MFX1 | 62 |
| 9-3: MFX2, 9-4: TFX | 62 |
| 9-5: Common FX LFO | 63 |
| Program: Menu Command | 64 |
| Combination mode | 69 |
| COMBI Page Select | 69 |
| COMBI P0: Play | 70 |
| 0-1: Program T01-08, 0-2: Program T09-16 | 70 |
| 0-3: Mixer T01-08, 0-4: Mixer T09-16 | 73 |
| 0-5: ARPEGGIATOR A, 0-6: ARPEGGIATOR B | 74 |
| 0-7: Tone Adjust | 75 |
| Controls | 76 |
| COMBI P1: Controllers | 78 |
| 1-1: Controllers Setup | 78 |
| COMBI P2: EQ | 79 |
| 2-1: EQ Trim T01-08, 2-2: EQ Trim T09-16 | 79 |
| 2-3: EQ Gain T01-08, 2-4: EQ Gain T09-16 | 80 |
| COMBI P3: Timbre Param (Timbre Parameters) | 81 |
| 3-1: MIDI T01-08, 3-2: MIDI T09-16 | 81 |
| 3-3: OSC T01-08, 3-4: OSC T09-16 | 81 |
| 3-5: Pitch T01-08, 3-6: Pitch T09-16 | 82 |
| 3-7: Scale T01-08, 3-8: Scale T09-16 | 83 |

COMBI P4: Zone/Delay84
 4-1: Key Zone T01-08, 4-2: Key Zone T09-16
 (Keyboard Zones T01-08, T09-16)..... 84
 4-3: Vel Zone T01-08, 4-4: Vel Zone T09-16
 (Velocity Zones T01-08, T09-16) 85
 4-5: Delay T01-08, 4-6: Delay T09-16..... 86

COMBI P5: MIDI Filter87
 5-1: <1> T01-08, 5-2: <1> T09-16 87
 5-3: <2> T01-08, 5-4: <2> T09-16 88
 5-5: <3> T01-08, 5-6: <3> T09-16 88
 5-7: <4> T01-08, 5-8: <4> T09-16 89
 5-9: <5> T01-08, 5-10: <5> T09-16 89
 5-11: <6> T01-08, 5-12: <6> T09-16 90

**COMBI P7: ARP/DT (Arpeggiator/Drum Track)
91**
 7-1: Setup T01-08, 7-2: Setup T09-16 91
 7-3: Arpeggiator A, 7-4: Arpeggiator B 92
 7-5: ARP Scan Zone 93
 7-7: Drum Track 93

COMBI P8: Routing/IFX (Insert Effect)..... 95
 8-1: Routing1 T01-08, 8-2: Routing1 T09-16.... 95
 8-3: Insert FX Setup 96
 8-4: IFX1 97
 8-5: IFX2, 8-6: IFX3, 8-7: IFX4, 8-8: IFX5 97
 8-9: FX Control T01-08, 8-10: FX Control T09-16.... 98

**COMBI P9: MFX/TFX/LFO (Master/Total Effect/
 LFO)..... 99**
 9-1: Routing 99
 9-2: MFX1 99
 9-3: MFX2, 9-4: TFX 100
 9-5: Common FX LFO 100

Combination: Menu Command101

Sequencer mode.....105

An overview of Sequencer mode105

SEQ Page Select.....108

SEQ P0: Play/REC.....109
 0-1: Program T01-08, 0-2: Program T09-16... 109
 0-3: Mixer T01-08, 0-4: Mixer T09-16..... 113
 0-5: Arpeggiator A, 0-6: Arpeggiator B 114
 0-7: Tone Adjust 115
 0-8: Preferences 116
 0-9: Play Loop T01-08, 0-10: Play Loop T09-16 .. 119
 Controls 120

SEQ P1: Controllers122
 1-1: Setup 122

SEQ P2: EQ.....123
 2-1: Trim T01-08, 2-2: Trim T09-16 123
 2-3: EQ T01-08, 2-4: EQ T09-16 124

SEQ P3: Track Param (Track Parameters) . .125
 3-1: MIDI T01-08, 3-2: MIDI T09-16 125
 3-3: OSC T01-08, 3-4: OSC T09-16 126
 3-5: Pitch T01-08, 3-6: Pitch T09-16 127
 3-7: Scale T01-08, 3-8: Scale T09-16 128

SEQ P4: Zones/Delay129
 4-1: Key Zone T01-08, 4-2: Key Zone T09-16
 (Keyboard Zones T01-08, T09-16) 129
 4-3: Vel Zone T01-08, 4-4: Vel Zone T09-16
 (Velocity Zones T01-08, T09-16) 130
 4-5: Delay T01-08, 4-6: Delay T09-16 131

SEQ P5: MIDI Filter133
 5-1: <1> T01-08, 5-2: <1> T09-16 133
 5-3: <2> T01-08, 5-4: <2> T09-16 134
 5-5: <3> T01-08, 5-6: <3> T09-16 134
 5-7: <4> T01-08, 5-8: <4> T09-16 135
 5-9: <5> T01-08, 5-10: <5> T09-16 135
 5-11: <6> T01-08, 5-12: <6> T09-16 136

SEQ P6: Track Edit.....137
 6-1: Track Edit 137
 6-2: Track View 138
 6-3: Track Name 142

**SEQ P7: ARP/DT (Arpeggiator/DrumTrack)
143**
 7-1: ARP Setup T01-08, 7-2: ARP Setup T09-16... 143
 7-3: Arpeggiator-A, 7-4: Arpeggiator-B 144
 7-5: ARP Scan Zone 145
 7-7: Drum Track 145

SEQ P8: Routing/IFX (Insert Effect)148
 8-1: Routing1 T01-08, 8-2: Routing1 T09-16 ... 148
 8-3: Insert FX Setup 149
 8-4: IFX1 150
 8-5: IFX2, 8-6: IFX3, 8-7: IFX4, 8-8: IFX5 150
 8-9: FX Control T01-08, 8-10: FX Control T09-16
 150

**SEQ P9: MFX/TFX/LFO (Master/Total Effect/
 LFO).....152**
 9-1: Routing 152
 9-2: MFX1 153
 9-3: MFX2, 9-4: TFX 153
 9-5: Common FX LFO 154

SEQ P10: Pattern/RPPR155
 10-1: Pattern Edit 155
 10-2: Pattern Name 157
 10-3: RPPR Setup 157

SEQ P11: Cue List.....160
 11-1: Cue List 160

Sequencer: Menu Command163

**System Exclusive events supported in
 Sequencer mode191**
 KROME sequencer file formats 192

| | | | |
|--|------------|---|------------|
| Global mode | 193 | Routing | 240 |
| Global Page Select | 193 | Mixer | 243 |
| Global P0: Basic Setup | 194 | Controlling the Insert Effects via MIDI | 244 |
| 0-1: Basic | 194 | Master Effects (MFX1, 2) | 245 |
| 0-2: System Preference | 196 | In/Out | 245 |
| Global P1: MIDI | 198 | Routing | 245 |
| 1-1: MIDI Basic | 198 | Mixer | 246 |
| 1-2: MIDI Routing | 200 | Controlling the Master Effects via MIDI | 247 |
| Global P2: Controllers | 202 | Total Effect (TFX) | 248 |
| 2-1: Foot Controllers | 202 | In/Out | 248 |
| 2-2: MIDI CC# Assign | 202 | Routing | 248 |
| Global P3: Scales | 203 | Mixer | 248 |
| 3-1: Scales | 203 | Using MIDI to control the Total Effect | 248 |
| Global P4: Category | 204 | Outputs | 248 |
| 4-1: Program Main | 204 | Main Outputs | 248 |
| 4-2: Program Sub | 204 | Effect/Mixer Block Diagrams | 249 |
| 4-3: Combination Main, 4-4: Combination Sub .. | 204 | Dynamics (Dynamic) | 251 |
| Global P5: Drum Kit | 205 | 000: No Effect | 251 |
| 5-1: Sample Setup | 206 | 001: Stereo Compressor | 251 |
| 5-2: Sample Parameters | 207 | 002: Red Comp | 251 |
| 5-3: Driver/EQ | 208 | 003: Stereo Limiter | 252 |
| 5-4: Velocity Split | 209 | 004: Multiband Limiter | 253 |
| 5-5: Voice/Mixer | 210 | 005: St.MasteringLimtr (Stereo Mastering Limiter) .. | 253 |
| Global P6: Arpeggio Pattern | 211 | 006: Stereo Gate | 253 |
| 6-1: Pattern Setup | 211 | EQ and Filters (EQ/Filter) | 255 |
| Arpeggio Pattern Edit | 213 | 007: St.Parametric4EQ | |
| Tool Tablet | 214 | (Stereo Parametric 4-Band EQ) | 255 |
| Global: Menu Command | 216 | 008: St. Graphic 7EQ | |
| Media mode | 223 | (Stereo Graphic 7-Band EQ) | 255 |
| Media: File | 225 | 009: St.Exciter/Enhncr (Stereo Exciter/Enhancer) .. | 256 |
| 0-1: Load | 225 | 010: Stereo Isolator | 256 |
| 0-2: Save | 226 | 011: St. Wah/Auto Wah (Stereo Wah/Auto Wah) | 257 |
| 0-3: Utility | 226 | 012: St. Vintage Wah | |
| 0-8: Media Information | 226 | (Stereo Vintage/Custom Wah) | 258 |
| Media: Menu Command | 227 | 013: VOX Wah | 258 |
| Effect Guide | 235 | 014: St. Random Filter (Stereo Random Filter) | 259 |
| Overview | 235 | 015: Multi Mode Filter (Stereo Multi Mode Filter) .. | 260 |
| Effects in each mode | 235 | 016: St. Sub Oscillator (Stereo Sub Oscillator) .. | 260 |
| Dynamic modulation (Dmod) and Tempo | | 017: Talking Modulator | 261 |
| Synchronization | 236 | 018: Stereo Decimator | 261 |
| Common FX LFOs | 237 | 019: St. Analog Record (Stereo Analog Record) | 262 |
| FX Control Buses | 238 | Overdrive, Amp models, and Mic models (OD | |
| Effect I/O | 239 | Amp Mic) | 263 |
| Insert Effects (IFX1-IFX5) | 240 | 020: OD/Hi.Gain Wah | |
| In/Out | 240 | (Overdrive/Hi.Gain Wah) | 263 |
| | | 021: St. Guitar Cabinet (Stereo Guitar Cabinet) | 264 |
| | | 022: St. Bass Cabinet (Stereo Bass Cabinet) | 264 |
| | | 023: Bass Amp Model | 265 |
| | | 024: Bass Amp+Cabinet (Bass Amp Model+Cabinet) .. | 265 |
| | | 025: TrebleBST (Treble Booster) | 266 |
| | | 026: Tube PreAmp Model | |
| | | (Tube PreAmp Modeling) | 266 |
| | | 027: St. Tube PreAmp | |
| | | (Stereo Tube PreAmp Modeling) | 266 |

028: Mic Model+PreAmp
(Mic Modeling + PreAmp) 267

Chorus, Flanger, and Phaser (Cho/Fln Phaser)268

029: Stereo Chorus 268
 030: Vintage Chorus..... 268
 031: Black Chorus..... 269
 032: EP Chorus 269
 033: St.HarmonicChorus (Stereo Harmonic Chorus) . 269
 034: St. Biphase Mod.
(Stereo Biphase Modulation) 270
 035: Multitap Cho/Delay
(Multitap Chorus/Delay)..... 270
 036: Ensemble 271
 037: Polysix Ensemble 271
 038: Stereo Flanger 271
 039: Vintage Flanger 272
 040: St. Random Flanger (Stereo Random Flanger) .. 272
 041: St. Env. Flanger (Stereo Envelope Flanger) 273
 042: Stereo Phaser. 273
 043: Small Phaser 274
 044: Orange Phaser 274
 045: Black Phaser 274
 046: U-VIBE. 274
 047: St. Random Phaser
(Stereo Random Phaser) 275
 048: St. Env. Phaser (Stereo Envelope Phaser)..... 276

Modulation and Pitch Shift (Mod./P.Shift) 277

049: Stereo Vibrato 277
 050: St. Auto Fade Mod.
(Stereo Auto Fade Modulation) 277
 051: 2Voice Resonator 278
 052: Doppler 279
 053: Scratch 279
 054: Grain Shifter 280
 055: Stereo Tremolo 281
 056: TEX Treml (TEX Tremolo) 281
 057: St. Env. Tremolo (Stereo Envelope Tremolo).... 281
 058: Stereo Auto Pan 282
 059: St. Phaser + Trml (Stereo Phaser + Tremolo) 283
 060: St. Ring Modulator
(Stereo Ring Modulator) 283
 061: Detune 284
 062: Pitch Shifter..... 285
 063: Pitch Shifter BPM..... 285
 064: Pitch Shift Mod. (Pitch Shift Modulation) . 286
 065: Organ Vib/Chorus (Organ Vibrato/Chorus)286
 066: Rotary Speaker 287
 067: St.EP Tone+Trml (Stereo EP Tone+Tremolo).... 288

Delay289

068: L/C/R Delay. 289
 069: Stereo/CrossDelay 289
 070: St. Multitap Delay (Stereo Multitap Delay) 290
 071: St. Mod Delay (Stereo Modulation Delay) . 290
 072: St. Dynamic Delay (Stereo Dynamic Delay)..... 291
 073: St. AutoPanningDly
(Stereo Auto Panning Delay) 292
 074: Echo Plus..... 293

075: Tape Echo293
 076: Auto Reverse293
 077: Sequence BPM Dly (Sequence BPM Delay)..... 294
 078: L/C/R BPM Delay..... 295
 079: Stereo BPM Delay 295
 080: St.BPM Mtap Delay
(Stereo BPM Multitap Delay)..... 296
 081: St.BPM Mod. Delay
(Stereo BPM Modulation Delay)..... 296
 082: St.BPMAutoPanDly
(Stereo BPM Auto Panning Delay) 297
 083: Tape Echo BPM297

Reverb and Early Reflections (Reverb ER) .299

084: Reverb Hall.....299
 085: Reverb SmoothHall.....299
 086: Reverb Wet Plate299
 087: Reverb Dry Plate299
 088: Reverb Room299
 089: Reverb BrightRoom.....299
 090: Reverb2 Spring.....300
 091: Reverb2 Hall.....300
 092: Reverb2 Plate300
 093: Reverb2 Room300
 094: Early Reflections300

Mono-Mono Serial (Mono-Mono).....301

095: P4EQ - Exciter
(Parametric 4-Band EQ - Exciter) 301
 096: P4EQ - Wah
(Parametric 4-Band EQ - Wah/Auto Wah)..... 301
 097: P4EQ - Cho/Flng
(Parametric 4-Band EQ - Chorus/Flanger)..... 302
 098: P4EQ - Phaser
(Parametric 4-Band EQ - Phaser)..... 302
 099: P4EQ - Mt. Delay
(Parametric 4-Band EQ - Multitap Delay) 303
 100: Comp - Wah (Compressor - Wah/Auto Wah).... 303
 101: Comp - Amp Sim
(Compressor - Amp Simulation)..... 304
 102: Comp - OD/HiGain
(Compressor - Overdrive/Hi.Gain)..... 304
 103: Comp - P4EQ
(Compressor - Parametric 4-Band EQ)..... 305
 104: Comp - Cho/Flng
(Compressor - Chorus/Flanger)..... 305
 105: Comp - Phaser (Compressor - Phaser)..... 306
 106: Comp - Mt. Delay
(Compressor - Multitap Delay) 306
 107: Limiter - P4EQ
(Limiter - Parametric 4-Band EQ) 307
 108: Limiter - Cho/Flng
(Limiter - Chorus/Flanger)..... 307
 109: Limiter - Phaser 308
 110: Limiter - Mt.Delay (Limiter - Multitap Delay) ... 308
 111: Exciter - Comp (Exciter - Compressor)..... 309
 112: Exciter - Limiter 309
 113: Exciter - Cho/Flng (Exciter - Chorus/Flanger).... 310
 114: Exciter - Phaser 310
 115: Exciter - Mt.Delay (Exciter - Multitap Delay) ... 311
 116: OD/HG - Amp Sim
(Overdrive/Hi.Gain - Amp Simulation)..... 311

| | |
|--|------------|
| 117: OD/HG - Cho/Flng (Overdrive/Hi.Gain - Chorus/Flanger) | 312 |
| 118: OD/HG - Phaser (Overdrive/Hi.Gain - Phaser) | 312 |
| 119: OD/HG - Mt.Delay (Overdrive/Hi.Gain - Multitap Delay) | 313 |
| 120: Wah - Amp Sim (Wah - Amp Simulation) | 313 |
| 121: Decimator - Amp (Decimator - Amp Simulation) | 314 |
| 122: Decimator - Comp (Decimator - Compressor) | 314 |
| 123: AmpSim - Tremolo (Amp Simulation- Tremolo) | 314 |
| 124: Cho/Flng - Mt.Dly (Chorus/Flanger - Multitap Delay) | 315 |
| 125: Phaser - Cho/Flng (Phaser - Chorus/Flanger) | 315 |
| 126: Reverb - Gate | 316 |
| Mono/Mono Parallel (Mono//Mono) | 317 |
| 127: P4EQ // P4EQ (Parametric 4-Band EQ // Parametric 4-Band EQ) | 319 |
| 128: P4EQ // Comp (Parametric 4-Band EQ // Compressor) | 319 |
| 129: P4EQ // Limiter (Parametric 4-Band EQ // Limiter) | 319 |
| 130: P4EQ // Exciter (Parametric 4-Band EQ // Exciter) | 319 |
| 131: P4EQ // OD/HG (Parametric 4-Band EQ // Overdrive/Hi.Gain) | 319 |
| 132: P4EQ // Wah (Parametric 4-Band EQ // Wah) | 319 |
| 133: P4EQ // Cho/Flng (Parametric 4-Band EQ // Chorus/Flanger) | 320 |
| 134: P4EQ // Phaser (Parametric 4-Band EQ // Phaser) | 320 |
| 135: P4EQ // BPM Dly (Parametric 4-Band EQ // Multitap BPM Delay) | 320 |
| 136: Comp // Comp (Compressor // Compressor) | 320 |
| 137: Comp // Limiter (Compressor // Limiter) | 320 |
| 138: Comp // Exciter (Compressor // Exciter) | 320 |
| 139: Comp // OD/HG (Compressor // Overdrive Hi.Gain) | 321 |
| 140: Comp // Wah (Compressor // Wah) | 321 |
| 141: Comp // Cho/Flng (Compressor // Chorus/Flanger) | 321 |
| 142: Comp // Phaser (Compressor // Phaser) | 321 |
| 143: Comp // BPM Dly (Compressor // Multitap BPM Delay) | 321 |
| 144: Limiter // Limiter | 321 |
| 145: Limiter // Exciter | 322 |
| 146: Limiter // OD/HG (Limiter // Overdrive/Hi.Gain) | 322 |
| 147: Limiter // Wah | 322 |
| 148: Limiter // Cho/Fl (Limiter // Chorus/Flanger) | 322 |
| 149: Limiter // Phaser | 322 |
| 150: Limiter // BPM DI (Limiter // Multitap BPM Delay) | 322 |
| 151: Exciter // Exciter | 323 |
| 152: Exciter // OD/HG (Exciter // Overdrive/Hi.Gain) | 323 |
| 153: Exciter // Wah | 323 |
| 154: Exciter // Cho/Fl (Exciter // Chorus/Flanger) | 323 |
| 155: Exciter // Phaser | 323 |
| 156: Exciter // BPM DI (Exciter // Multitap BPM Delay) | 323 |
| 157: OD/HG // OD/HG (Overdrive/Hi.Gain // Overdrive/Hi.Gain) | 324 |
| 158: OD/HG // Wah (Overdrive/Hi.Gain // Wah) | 324 |
| 159: OD/HG // Cho/Fln (Overdrive/Hi.Gain // Chorus/Flanger) | 324 |
| 160: OD/HG // Phaser (Overdrive/Hi.Gain // Phaser) | 324 |
| 161: OD/HG // BPMDly (Overdrive/Hi.Gain // Multitap BPM Delay) | 324 |
| 162: Wah // Wah | 324 |
| 163: Wah // Cho/Flng (Wah // Chorus/Flanger) | 325 |
| 164: Wah // Phaser | 325 |
| 165: Wah // BPM Dly (Wah // Multitap BPM Delay) | 325 |
| 166: Cho/Fl // Cho/Fl (Chorus/Flanger // Chorus/Flanger) | 325 |
| 167: Cho/Fl // Phaser (Chorus/Flanger // Phaser) | 325 |
| 168: Cho/Fl // BPMDly (Chorus/Flanger // Multitap BPM Delay) | 325 |
| 169: Phaser // Phaser | 326 |
| 170: Phaser // BPMDly (Phaser // Multitap BPM Delay) | 326 |
| 171: BPM DI // BPM DI (Multitap BPM Delay // Multitap BPM Delay) | 326 |
| Double Size | 327 |
| 172: St. Mltband Limiter (Stereo Multiband Limiter) | 327 |
| 173: PianoBody/Damper (PianoBody/Damper Simulation) | 327 |
| 174: Vocoder | 328 |
| 175: OD/HyperGain Wah (Overdrive/Hyper Gain Wah) | 328 |
| 176: GuitarAmp + P4EQ (Guitar Amp Model + Parametric 4-Band EQ) | 329 |
| 177: G.Amp Clean Combo | 329 |
| 178: G.Amp California | 329 |
| 179: G.Amp Tweed | 329 |
| 180: G.Amp Modded OD | 330 |
| 181: BassTubeAmp+Cab. (Bass Tube Amp Model + Cabinet) | 330 |
| 182: EP Cabinet/Drive | 331 |
| 183: St. Mic + PreAmp (Stereo Mic Modeling + PreAmp) | 331 |
| 184: Multitap Cho/Delay (Multitap Chorus/Delay) | 331 |
| 184: St. Pitch Shifter (Stereo Pitch Shifter) | 332 |
| 185: St. PitchShift BPM (Stereo Pitch Shifter BPM) | 333 |
| 186: Rotary SpeakerOD (Rotary Speaker Overdrive) | 333 |
| 188: L/C/R Long Delay | 334 |
| 189: St/Cross Long Delay (Stereo/Cross Long Delay) | 334 |
| 190: Hold Delay | 335 |
| 191: LCR BPM Long Dly (L/C/R BPM Long Delay) | 336 |
| 192: St. BPM Long Dly (Stereo BPM Long Delay) | 336 |
| 193: Early Reflections | 337 |

Appendices339

Alternate Modulation Sources (AMS) 339

- Alternate Modulation Overview 339
- AMS (Alternate Modulation Source) List..... 340
- Alternate Modulation settings..... 342

Dynamic Modulation Sources (Dmod) ... 346

- Dynamic Modulation Source List 346

Controller Assignments348

- SW1/2 Assignments..... 348
- Realtime Controls Knobs 1-4 Assignments.... 348
- Knobs 1-4 349
- Foot Switch Assignments..... 349
- Foot Pedal Assignments 350

System exclusive messages affected by Create Excl Data, Erase Excl Data, and Event Edit.352

MIDI transmission when the KROME's controllers are operated.....354

KROME and MIDI CCs.....356

- Responses to standard MIDI controllers 356
- Parameters controlled by MIDI CCs #70-79..... 358

MIDI applications359

- About MIDI..... 359
- Settings when connected to a MIDI device or computer..... 359
- Messages transmitted and received by the KROME . 360

Compatibility with the M50.....369

MIDI Implementation370

Program mode

PROG Page Select

You can select Program mode pages in several ways.

1. Press the PAGE button.

Alternatively, press the mode button on the upper left side of the display, and then press the right side of the menu.

“Page Select” shows an abbreviated name for each page.

The page prior to pressing the PAGE button is shown in light blue.

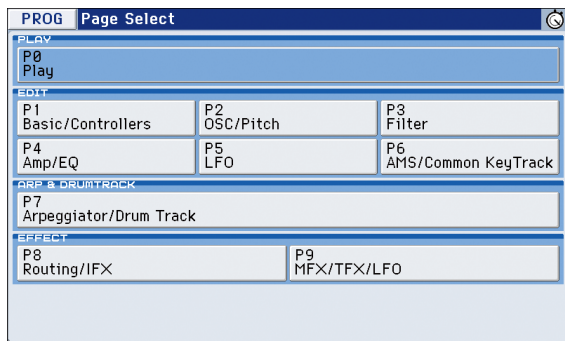

2. Select the desired page in the display.

Other ways to select pages

- Hold down the PAGE button and press numeric keys 0–9 to jump to the corresponding page.
For example, hold down the PAGE button and press numeric key 4 to jump to the P4: Amp/EQ page.
- Press the EXIT button to return to the Play page. If something other than the main page is selected, press the EXIT button to access the main page.

| | Page | Main content |
|------------------|----------------------------|--|
| PLAY | P0: Play | Select and play programs. (see p.2) Oscillator and Drum track level settings. (see p.5) Simple drum track editing. (see p.6) Simple arpeggiator editing. (see p.6) Tone Adjust settings. (see p.8) |
| | P1: Basic/Controllers | Basic program settings, such as voice assign mode. (see p.12) SW1, 2, and knob settings. (see p.16) |
| EDIT | P2: OSC/Pitch | Oscillator selection and pitch settings. (see p.17) |
| | P3: Filter | Filter 1, 2(tone) settings. (see p.26) |
| | P4: Amp/EQ | Amp 1, 2 (volume) settings. (see p.35) Amp 1, 2 driver and pan settings. (see p.40) 3-band parametric EQ settings. (see p.41) |
| | P5: LFO | LFO settings. (see p.42) |
| | P6: AMS/Common KeyTrack | AMS Mixer settings. (see p.46) Common keyboard tracking settings. (see p.52) |
| ARP & DRUM TRACK | P7: Arpeggiator/Drum Track | Arpeggiator settings. (see p.53) Drum track settings. (see p.55) |
| EFFECT | P8: Routing/IFX | Oscillator output bus and master effect send level settings. (see p.58) Insert effect routing, selection, and settings. (see p.59) |
| | P9: MFX/TFX/LFO | Master effect routing, selection, and settings. (see p.62) Total effect selection and settings. (see p.62) Common FX LFO settings (see p.63) |

PROG P0: Play

This is the main Program mode page. Here, you can:

- Select a program to play.
- Select patterns and programs for the Drum Track.
- Adjust the oscillator and drum track levels.
- Make simple edits for the Arpeggiator.
- Adjust the Realtime Contorols.
- Use the Tone Adjust function to make simple edits for program parameters

MIDI All MIDI data in Prog P0: Play is transmitted and received on the global MIDI channel **MIDI Channel** (Global 1–1a).

Tip: Auto Song Setup

The Auto Song Setup feature copies the current Program or Combination into a Song, and then puts the KROME in record-ready mode.

If inspiration for a phrase or song strikes you while you're playing, you can use Auto Song Setup to start recording immediately. For more information, please see "Auto Song Setup" on page 106.

0–1: Main

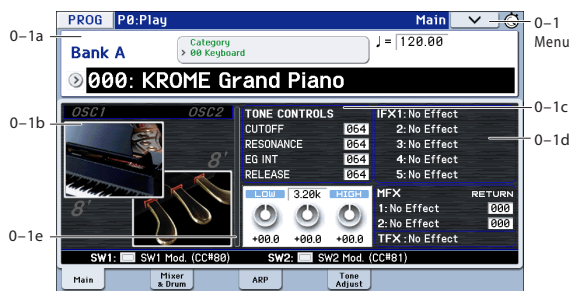

0–1a: Program Select

Bank (Bank Select) [A...F, GM, g(1)...g(9), g(d)]

This is the Bank containing the current Program.

Press the BANK A–F button to select a bank.

- To select the GM bank, use the numeric keys.
 GM: While holding down [0], press [-].
 g(1)–g(9): While holding down [0], press a variation number [1]–[9]. If the bank contains no variation programs, the basic GM sound set will be selected. (An "*" symbol is shown at the beginning of the program name.)
 g(d): While holding down [0], press [.]

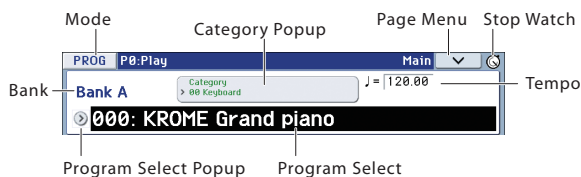

Program Select

[A...F: 0...127, GM, g(1)...g(9), g(d): 1...128]

Here you can select a program.

To switch programs

- Choose **Program Select**, use the numeric keys 0–9 to enter a program number, and press the ENTER button.
- Choose **Program Select**, and turn the VALUE dial or use the INC/DEC buttons.
- Press the Program Select Popup to view and select from the Bank/Program Select menu organized by bank.
- Press the Category Popup to view and select from the Category/Program Select menu organized by category.
- You can use a foot switch to select programs. (see "Foot Switch Assign" on page 202 and "List of Foot Switch assignments" on page 349)
- You can select programs by transmitting a MIDI Program Change from a connected external MIDI device.

Bank/Program Select menu:

1. Press the popup button at the left of Program Select to open the Bank/Program Select menu.
2. Press one of the tabs on the left to select a specific bank. The Variation button is active if Bank GM is selected; pressing it will switch the banks in the following order: GM→g(1)→g(2)→...→g(8)→g(9)→GM.
3. From the list, You can touch a Program's name directly, or use the INC and DEC buttons.

Use the scroll bar to view information not currently shown.

Note: If you want to find a sound by its program name, use the Find function (see p.2).

4. Press the OK button to confirm your choice, or press the Cancel button to exit without switching Programs.

Bank/Program Select menu

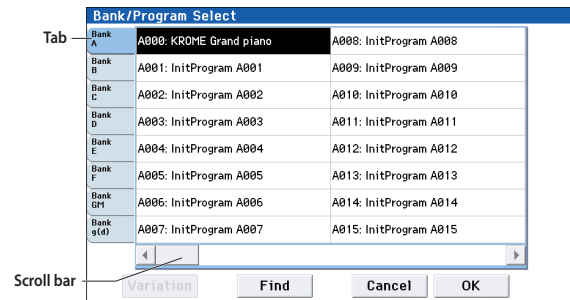

Find (search function)

Here's how to search for a program by part of its name.

1. In the Bank/Program Select menu or the Category/Program Select menu, select the tab that you want to search.

Note: The programs in the selected tab will be the target for searching.

2. Press the Find button on the lower left side to open the dialog box.

Find menu

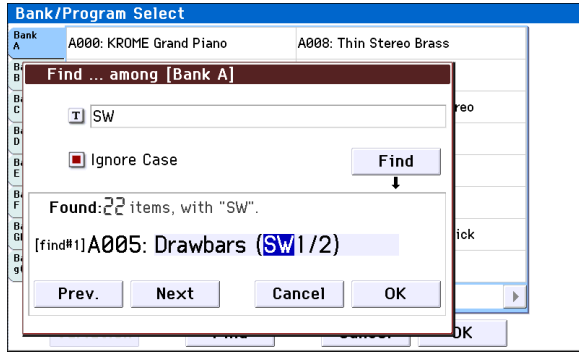

3. Press the "T" button, and enter the desired search text in the text field. When you've entered the text, press the OK button.
 4. If the "Ignore Case" check box is selected, the search will not distinguish between uppercase and lowercase.
 5. Press the Find button to search for the text that you entered.
 6. Use the Prev. and Next buttons to find the previous or next sound.
 7. Press the OK button to select a program in the list.
- If you press the Cancel button, the selection will be cancelled.
8. Press the OK button to execute, or press the Cancel button to cancel your selection.

Category [00...17/00...07]

Here, you can select programs by main category and sub-category. All programs are classified into eighteen main categories, and each category is classified into eight sub-categories. You can use these main categories and sub-categories to find and select programs. Here you can select a program by its main category and sub-category.

Category/Program Select menu:

1. Press the Category popup button (above the Program Select parameter) to open the Category/Program Select menu.
2. Press one of the tabs on the left or right to select the desired category.

Note: Only Categories and Sub-categories that are assigned to programs can be selected from the tabs.

3. Select a program from the list. You can touch a Program's name directly, or use the INC and DEC buttons.

Use the scroll bar to browse through all Programs in the Category.

You can search for a program by a portion of its name (see p.2).

Category/Program Select menu

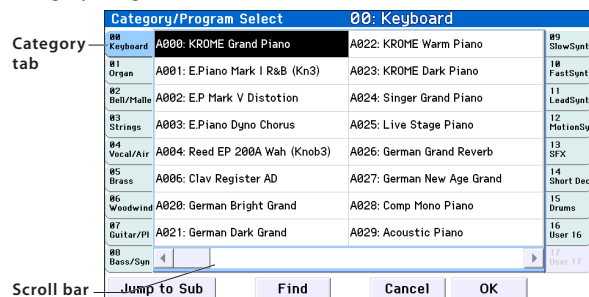

4. To select from a sub-category, press the Jump to Sub button.

Press one of the left tabs to select a sub-category.

Note: Only Sub-categories that are assigned to Programs can be selected from the tabs.

To confirm your selection, press the OK button. If you decide to cancel, press the Cancel button. You will return to the main categories.

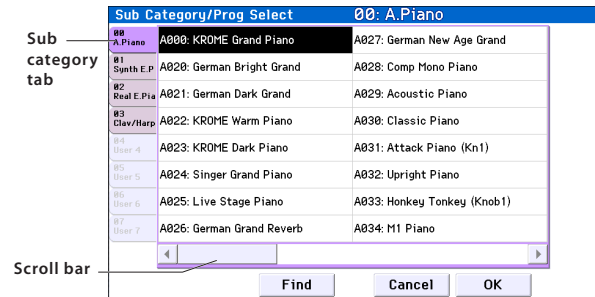

5. Press the OK button to confirm your choice, or press the Cancel button to exit without changing the Program.

Note: You can assign a category to a Program in the Write Program dialog.

J (Tempo) [40.00... 300.00, EXT]

This is the tempo for the current Program, which applies to the arpeggiator, tempo-synced LFOs, and tempo-synced effects. 040.00...300.00 allows you to set a specific tempo in BPM, with 1/100 BPM accuracy. In addition to using the standard data entry controls, you can use the TEMPO knob to adjust the bpm, or just play a few quarter-notes on the TAP button. EXT is displayed if the MIDI Clock (Global 1-1a) is set to External MIDI or External USB. This is also shown if the MIDI Clock setting is Auto and MIDI clock data is being received from an external device. If the tempo source is EXT, the arpeggiator etc. will synchronize to MIDI clock data from an external MIDI device.

Mode

This indicates the mode that's currently selected.

When you press this button, the mode menu will appear. In the mode menu, press the name of the desired mode. If you select the same mode where you were prior to accessing the mode menu, the Page Select menu of that mode will appear. If you press the area to the right of the mode name, the page select menu for the corresponding mode will appear.

To close the menu, press the Close button or the EXIT button.

If you accessed this menu from Global or Media mode, it will include an item named Return. Pressing Return will take you back to the mode and page where you were prior to selecting Global or Media mode.

When accessed from Program, Combination, or Sequencer mode

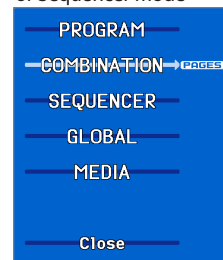

When accessed from Global or Media mode

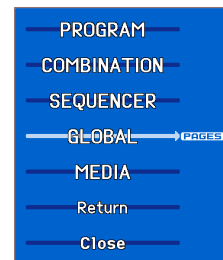

Stop Watch

When you press the button on the upper right side of the display, the screen will show the amount of time that has elapsed since the power was turned on. You can use the START/STOP button and RESET button to measure a duration.

- START/STOP: Starts/stops the stopwatch.
- RESET: Resets the stopwatch to 000:00:00.



0-1b: Program Information

The following information for the selected program is displayed:

OSC Pictures

This shows a graphic for the oscillator. In the case of double oscillators or double drums, the **Octave** (footage of the oscillator's basic pitch) is also shown.

If you want to change the oscillator's graphic, double-click the graphic, and change the setting in the menu. You can also set this in P1-Program Basic "OSC Picture" (see p.12).

SW1, SW2

These are the functions controlled by the SW1, SW2 switches.

0-1c: Controls AMSOURCE

This indicates the settings of the REALTIME CONTROLS knobs (the name of the operable parameters and their current value), and the 3-band EQ settings.

The currently selected REALTIME CONTROLS knob functions and the EQ settings are shown. Use the SELECT button to select the function controlled by the knobs.

The functions of the TONE CONTROLS knobs are fixed. You can assign various functions to the USER CONTROLS knobs. A MIDI control change is assigned to each function.

When you move a knob, it sends out the corresponding MIDI CC.

Unless otherwise noted, "scaling" means that the parameters are at their programmed values when the controller is at 64, at their minimum when the controller is at 0, and at their maximum when the controller is at 127. For another look at this, please see the diagram below.

CC parameter scaling

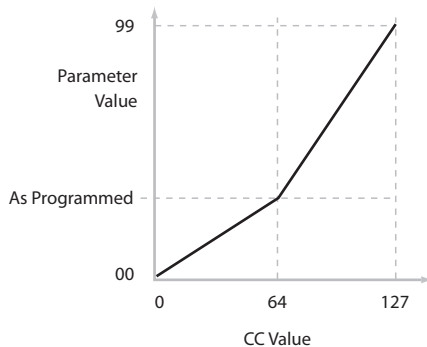

TONE CONTROLS

CUTOFF (Filter Cut Off) [000...127]

This knob scales the cutoff frequencies of Filters A and B, and transmits and receives MIDI CC #74.

RESONANCE (Filter Resonance) [000...127]

This knob scales the resonance of Filters A and B, and transmits and receives MIDI CC #71.

EG INTENSITY (Filter EG Intensity) [000...127]

This knob scales the effect of the Filter EG on the cutoff frequencies of Filters A and B. It also transmits and receives MIDI CC#79.

RELEASE (EG Release) [000...127]

This knob scales the release time of the Filter and Amp EGs, and transmits and receives MIDI CC#72.

USER CONTROLS

1...4 [000...127]

You can set Realtime Controls USER knobs 1-4 to a wide variety of modulation functions, using the P1: Basic/Controllers- Controllers Setup page.

Many of the functions scale a particular set of Program parameters. All of the settings also correspond to MIDI messages usually CCs.

ARP CONTROLS

The functions of knobs 1-4 are fixed. The knobs will control the duration of the arpeggiated notes, their velocity, the pitch range, and the length of the arpeggio pattern.

GATE [-64...+00...+63]

Adjusts the duration (gate time) of the arpeggiated notes (See "Gate" on page 54).

VELOCITY [-64...+00...+63]

Adjusts the velocity of the arpeggiated notes (See "Velocity" on page 54).

SWING [-64...+00...+63]

Adjusts the degree of shuffle for the arpeggio pattern (See "Swing" on page 54).

STEP [-64...+00...+63]

This changes the length and resolution of the arpeggio pattern.

Turning the knob toward the left will shorten the pattern's length (**Length**) in units of one half. Turning the knob toward the right will shorten the interval between arpeggiated notes (**Resolution**) in units of one half. When the knob is in the center (12 o'clock), the number of steps and the speed will be as specified by the **Length** and **Resolution** (See "Resolution" on page 54).

EQ (Low, Mid [Hz], Mid, High)

This indicates the 3-band EQ settings. You can edit the values.

Low [-18.00...+00.0...+18.0]: Adjusts the gain of the 80 Hz low-shelving EQ in 0.5 dB steps.

Mid [Hz] [100...10.0k]: Adjusts the center frequency of the mid-sweepable EQ.

Mid [-18.00...+00.0...+18.0]: Adjusts the gain of the mid-sweepable EQ in 0.5 dB steps.

High [-18.00...+00.0...+18.0]: Adjusts the gain of the 10 kHz high shelving EQ in 0.5 dB steps.

0-1d: Effect

IFX 1, 2, 3, 4, 5

MFX 1, 2 [000...127]

TFX

Here you can view the effects that are assigned to the insert effects, master effects, and total effect.

For the master effects you can adjust the send amounts.

The MASTER FX and TOTAL FX buttons respectively turn master effects 1/2 and the total effect on/off (see Global).

MIDI Changing the **Enable MFX1&2** and **Enable TFX** settings will respectively transmit the control change messages CC#94 (effect control 4) or CC#95 (effect control 5). The transmitted value will be 0 for off, and 127 for on.

0-1e: Velocity Meter

This meter shows the note-on velocity value.

- This indicates the note-on velocity values on the global MIDI channel, produced by the keyboard, MIDI IN, or arpeggiator. (If multiple note-on messages are received simultaneously, the highest velocity will be displayed.)
- The meter will respond even if Key Zone or Vel Zone settings are set so that the note does not actually sound.
- This meter indicates the note-on velocity value; it does not respond to changes in the Volume knob setting, nor to changes in the level of the audio signal produced by the Filter, Amp, EG, LFO, EQ, or effects.

✓ 0-1: Menu Command

- 0: **Write Program** see p. 64
- 1: **Exclusive Solo** see p. 64
- 2: **Auto Song Setup** see p. 65

For more information, please see "Program: Menu Command" on page 64.

0-3: Mixer & Drum Track

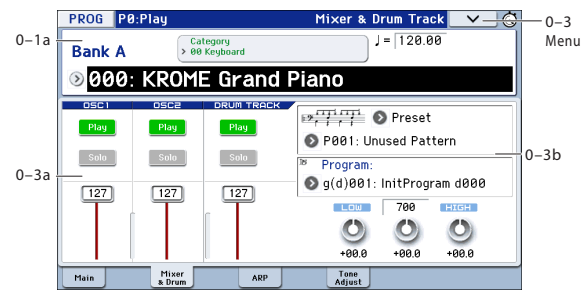

0-3a: OSC/DrumTrack Mixer

Here, you can adjust the volume and change the Play/Mute and Solo On/Off settings of oscillators 1 and 2 and the drum track.

OSC Play/Mute:

OSC1 Play/Mute [Play, Mute]

Play: Oscillator 1 will sound.

Mute: Oscillator 1 will be muted (silent).

OSC2 Play/Mute [Play, Mute]

Play: Oscillator 2 will sound.

Mute: Oscillator 2 will be muted (silent).

Note: OSC2 Play/Mute cannot be set for a program whose **Oscillator Mode** is Single or Drums.

DRUM Track Play/Mute 1 [Play, Mute]

Play: The drum track will sound.

Mute: The drum track will be muted (silent).

OSC Solo:

OSC1 Solo [Off, On]

Switches the Solo status on/off for oscillator 1.

OSC2 Solo [Off, On]

Switches the Solo status on/off for oscillator 2.

DRUM Track Solo [Off, On]

Switches the Solo status on/off for the drum track.

Note: Solo applies to oscillators 1 and 2, the drum track.

Note: OSC2 Solo cannot be set for a program whose **Oscillator Mode** is Single or Drums.

Note: The Solo On/Off setting is not saved when you write the program.

Exclusive Solo [Off, On]

The menu's **Exclusive Solo** parameter also affects the way that Solo works. If **Exclusive Solo** is off (unchecked), Multiple Solos will be active, allowing you to turn Solo on/off for more than one of the items: oscillators 1 and 2, and the drum track. Each time you press a Solo button, the solo setting will toggle on and off.

If **Exclusive Solo** is on (checked), only one of the applicable items can be soloed. In this mode, pressing a Solo button automatically disables any previous solos.

Tip: You can also toggle **Exclusive Solo** by holding ENTER and pressing 2 on the numeric keypad.

OSC Volume:

OSC 1 Volume [000...127]

This slider adjusts the volume of Oscillator 1.

OSC 2 Volume [000...127]

This slider adjusts the volume of Oscillator 2.

DRUM Track Volume [000...127]

Adjusts the volume of the drum track.

Velocity Meter

This meter shows the note-on velocity value of the global MIDI channel and the drum track's **Prog MIDI Ch** (see p.5).

0-3b: Drum Track

The Drum Track provides an easy way for you to play back a rhythm section using the KROME's high-quality drum programs and a rich variety of drum patterns.

Pattern Bank [Preset, User]

Pattern No. [P000...605, U000...999]

Select the pattern you want to use in the drum track. You can create user patterns in Seq P10: Pattern/RPPR- Pattern Edit.

Drum Track Program

[A...F: 000...127, GM, g(1)...g(9), g(d): 001...128]

Select the program that will play the drum track pattern.

Note: Only programs of the Drums category can be selected.

 The MIDI channel of the drum track is specified by the Global P1: MIDI- MIDI Basic page DrumTrack **Prog MIDI Ch**. MIDI message transmission for a pattern is specified by **Prog MIDI Out**. Program changes are not transmitted or received.

High Gain [-18.0...+00.0...+18.0dB]

This controls the gain of the 10 kHz High Shelf EQ, in increments of 0.5 dB.

Mid Frequency [100Hz...10kHz]

This sets the center frequency for the Mid sweep EQ.

Mid Gain [-18.0...+00.0...+18.0dB]

This controls the gain of the Mid Sweep EQ, in increments of 0.5 dB.

Low Gain [-18.0...+00.0...+18.0dB]

This controls the gain of the 80 Hz Low Shelf EQ, in increments of 0.5 dB.

Note: These parameters can also be set from P7: ARP/DT (Arpeggiator/Drum Track).

0-3: Menu Command

- 0: **Write Program** see p. 64
- 1: **Exclusive Solo** see p. 64
- 2: **Auto Song Setup** see p. 65

For more information, please see "Program: Menu Command" on page 64.

0-5: Arpeggiator

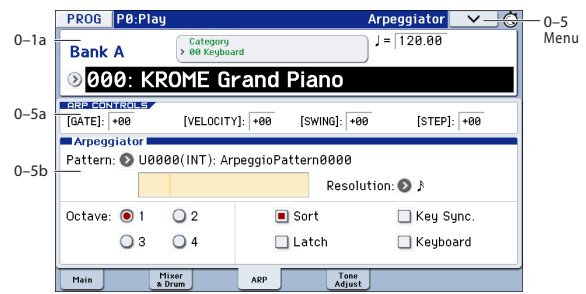

Arpeggiator parameters are edited in P7: ARP/DT (Arpeggiator/Drum Track), but major parameters can be edited here as well. When you are playing in Prog P0: Play, you can edit the arpeggiator in realtime, such as changing the arpeggio in realtime.

To write (save) the edited content, use **Write Program**. You can also use the TEMPO knob, TAP button and the arpeggio control (ARP) knobs GATE, VELOCITY, SWING, and STEP to edit the arpeggio in realtime.

0-5a: ARP CONTROLS

ARP CONTROLS

This shows the value of each parameter for the ARP assignments of the REALTIME CONTROLS knobs (see p.4 and p.54).

GATE [-64...+00...+63]

VELOCITY [-64...+00...+63]

SWING [-64...+00...+63]

see p.4, p.54

STEP [-64...+00...+63]

see p.4

0-5b: Arpeggiator

Pattern [P0...P4, U000 (INT)...U0899(INT), U0900(USER)...U1027(USER)]

Arpeggio Pattern Preview

This shows a graphic of the steps of the user arpeggio pattern.

Resolution [♪₃, ♪₃, ♪₃, ♪₃, ♪₃, ♪₃, ♪₃, ♪₃, ♪₃, ♪₃]

Octave [1, 2, 3, 4]

Sort [Off, On]

Latch [Off, On]

Key Sync. [Off, On]

Keyboard [Off, On]

Make settings for the program arpeggiator. For more information, please see "PROG P7: ARP/DT (Arpeggiator/Drum Track)" on page 53.

Note: These parameters can also be set from P7: ARP/DT (Arpeggiator/Drum Track).

✓ 0-5: Menu Command

- 0: Write Program see p. 64
- 1: Exclusive Solo see p. 64
- 2: Auto Song Setup see p. 65
- 3: Copy Arpeggiator see p. 66

For more information, please see “Program: Menu Command” on page 64.

0-7: Tone Adjust

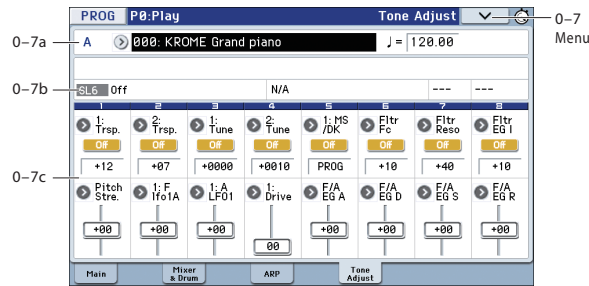

The Tone Adjust function assigns important program parameters and easy-edit parameters to the switches and sliders in the display for quick edits of selected parameters.

Tip: In Combination and Sequencer modes, Tone Adjust also lets you edit Program parameters without the need to save a different version of the original Program. For more information on Tone Adjust in these modes, please see “0-7c: Tone Adjust” on page 75 and page 115.

Absolute (Abs), Relative (Rel), Meta parameter

There are three kinds of Tone Adjust parameters: Absolute, Relative, and Meta.

Absolute parameters usually edit a single Program parameter, such as **Oscillator 1 Drive**. The Program and Tone Adjust parameters mirror one another; when you change one, the other will change to match.

Relative parameters typically adjust two or more Program parameters simultaneously. For instance, **F/A EG Attack Time** affects a total of six Program parameters. The value of the Relative parameter shows the amount of change to these underlying Program parameters.

If the Relative parameter is set to 0 (the slider in the display is at the center position), the value of the corresponding program parameter will not change.

The definitions of higher and lower settings can vary, depending on the specific parameter. Unless noted otherwise, they work as follows:

When the Relative parameter is at +99 (the maximum), the Program parameters are all at their maximum as well. Similarly, when the Relative parameter is at -99 (the minimum), the Program parameters are at zero.

Relative Tone Adjust parameter scaling

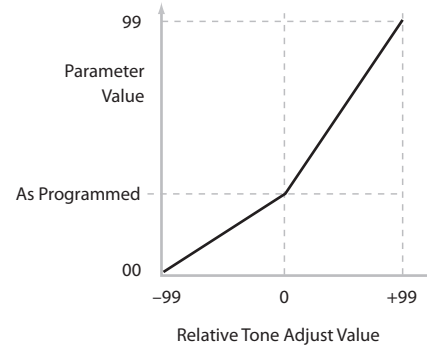

A few of the Program parameters controlled by Relative Tone Adjust are bipolar, meaning that they can be either positive or negative (instead of just positive). When these Program parameters are set to negative values, the Tone Adjust parameter may behave differently from the description above.

For instance, if the EG Intensity is set to a negative value, Relative Tone Adjust values will range from 0 to -99, the inverse of the diagram above. EG Sustain works differently; if it's set to a negative value, Tone Adjust values range from 0 down to the programmed value, and then up to +99, as shown below.

Relative Tone Adjust parameter scaling: EG Sustain

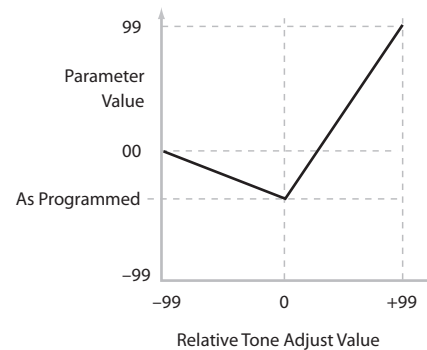

Meta parameters don't affect Program parameters directly. Instead, they affect the way that other Tone Adjust parameters work. For instance, **Multisample Min #** and **Max #** set the minimum and maximum values of the Tone Adjust **Multisample** parameter.

Saving Tone Adjust Edits

Tone Adjust edits are saved in two different ways, depending on whether the parameter is **Relative** or **Absolute**. (For more information, please see “Absolute (Abs), Relative (Rel), Meta parameter” below.)

Edits to **Relative** parameters affect the sound immediately, but don't change the underlying Program parameter settings until the Program is saved. When the Program is saved, the KROME calculates the combined effects of Tone Adjust and dedicated CC modulation (from the Real Time knobs, for instance), and saves the results into the Program parameters directly. At that point, all of the Relative parameters are reset to 0.

Edits to **Absolute** parameters are immediately reflected in the corresponding on-screen parameters, and vice-versa.

Tone Adjust and MIDI SysEx

The Tone Adjust edits all send and receive MIDI System Exclusive messages. You can use this to record and play back Tone Adjust edits with a sequencer, including the built-in sequencer.

Note: System exclusive messages are not Tone Adjust parameters; they are linked to the actual value. For example, if a slider in the display is assigned to control filter resonance, and you move this slider while recording to the sequencer, the slider movement will be recorded, but the change in filter resonance will not be recorded. This means that if you later reassign the Tone Adjust parameter to control **LFO1 Speed**, playing back the sequencer will cause the LFO speed (not the filter resonance) to change.

Interaction between Tone Adjust and MIDI CCs

A number of the Common Tone Adjust parameters can affect parameters which are also modulated by dedicated MIDI CCs. The specific CC numbers are noted in the descriptions for the individual Tone Adjust parameters. For more information, please see “Tone Adjust Parameters” on page 10.

Tone Adjust and the CCs work independently. It’s possible, for instance, for Tone Adjust to reduce the value of a parameter, and then for a CC to increase it again.

Tone Adjust scales the parameter first, and then the CC scales the result of the Tone Adjust.

0–7a: Program Select & Tempo

Bank (Bank Select) [A...F, GM, g(1)...g(9), g(d)]

Program Select [A...F: 000...127, GM, g(1)...g(9), g(d): 001...128]

Tempo [040.00...300.00, EXT]

This area displays information about the program selected for editing: the program bank/number/ name, and the tempo used to control the arpeggiator etc. For more information, please see “0–1a: Program Select” on page 2.

0–7b: Selected parameter information

Selected parameter information

This status line shows detailed, read-only information about the currently selected Tone Adjust parameter.

| Control | Assignment | Value | Type | Stored Value |
|---------|------------------|-------|------|--------------|
| SW1 | [OSC1] Transpose | +12 | Rel | +00 |

Control [SW1...8, SL1...8]

This is the controller in the display to which the Tone Adjust parameter is assigned.

SW: Switch

SL: Slider

Assignment

This shows the full name of the parameter assigned to the controller. You can change this using the Assign parameter, below.

Value

This shows the current value of the parameter. The range of values will vary depending on the parameter assigned to the control.

Type [Rel, Abs, Meta]

This shows the type of parameter, which relates to how edits to the parameter are adjusted and saved. For more information, please see “Absolute (Abs), Relative (Rel), Meta parameter” on page 7.

Stored Value

This shows the original value of the parameter, before the effects of Tone Adjust. It applies only to Tone Adjust parameters which control a single Program parameter.

If you un-assign a **Relative** parameter from a control, it will revert to this value.

0–7c: Tone Adjust

Here, you can assign Tone Adjust parameters to switches and sliders in the display.

Switches 1...8

Tone Adjust switches in the display act a little differently than sliders.

When a switch is assigned to a **Relative** parameter, or an **Absolute** parameter with more than two states:

Switch On = On Value (see below)

Switch Off = the Program’s stored value

When a switch is assigned to a two-state **Absolute** parameter, such as **Hold**, the switch status directly reflects the parameter value:

Switch On = On

Switch Off = Off

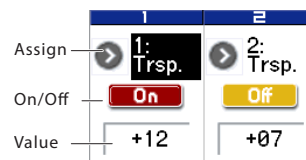

Assign

This lets you assign a Tone Adjust parameter to the displayed switch. For a full list of the available choices, please see “Common Tone Adjust Parameters” and “Tone Adjust Parameters” below.

On Value [Depends on parameter]

The parameter is set to this value when the switch is On.

When the switch is assigned to a two-state **Absolute** parameter, such as **Hold**, this will always be the same as the **Switch Status** (see below).

Switch Status [Off, On]

This simply shows whether the switch is On or Off.

Sliders 1...8

Assign

This lets you assign a Tone Adjust parameter to the displayed slider. For a full list of the available choices, please see “Common Tone Adjust Parameters” and “Tone Adjust Parameters” below.

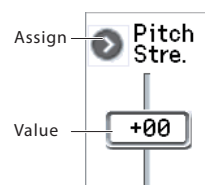

Per-Oscillator parameters apply to OSC1 and 2 individually, and are marked as such: OSC1 and OSC2.

Each slider can be assigned to only one parameter, and each parameter can be assigned to only one slider.

To swap a parameter from one slider to another, you'll need to first un-assign it from the old slider, and then assign it to the new slider.

Value

This shows the current value of the parameter. The range of values will depend on the parameter assigned to the slider.

Common Tone Adjust Parameters

These parameters affect both Oscillators 1 and 2.

Unless otherwise noted, all of the Common Tone Adjust parameters are **Relative**.

Note: At the right of each parameter, the (value range and CC#) are shown in parentheses.

Off. This means that the Tone Adjust control has no effect.

Filter Cutoff. (-99...+99, CC#74)

This scales the cutoff frequency of all of the filters at once. It affects both Filters A and B.

Filter Resonance. (-99...+99, CC#71)

This scales the resonance of all of the filters at once. It affects both Filters A and B.

Filter EG Intensity. (-99...+99, CC#79)

This scales the effect of the Filter EG on the cutoff frequency. It affects Filters A and B simultaneously.

-99 means no modulation. +99 means maximum.

Modulation is in the same direction, positive or negative, as the original Program. For instance, if the original Program's EG Intensity was set to -25, then setting the Tone Adjust to +99 moves the EG Intensity to -99.

Amp Velocity Intensity. (-99...+99)

This scales the effect of velocity on the Amp level.

-99 removes the velocity modulation entirely. +99 means maximum modulation in the same direction, positive or negative, as the original Program.

F/A EG Attack Time. (-99...+99, CC#73)

This scales the attack times of the Filter and Amp EGs, along with other related parameters.

When the value is +1 or more, this also affects the Amp EG's Start and Attack Levels, Start Level AMS, and Attack Time AMS, as described below:

Between values of +1 and +25, the Start Level, Start Level AMS, and Attack Time AMS will change from their programmed values to 0. Over the same range, the Attack Level will change from its programmed value to 99.

F/A EG Decay Time. (-99...+99, CC#75)

This scales the decay and slope times of the Filter and Amp EGs. It interacts with CC# 75.

F/A EG Sustain Level. (-99...+99, CC#70)

This scales the sustain levels of the Filter and Amp EGs.

F/A EG Release Time. (-99...+99, CC#72)

This scales the release times of the Filter and Amp EGs.

Filter EG Attack Time. (-99...+99)

This scales the attack times of the Filter EGs.

Filter EG Decay Time. (-99...+99)

This scales the decay and slope times of the Filter EGs.

Filter EG Sustain Level. (-99...+99)

This scales the sustain levels of the Filter EGs.

Filter EG Release Time. (-99...+99)

This scales the release times of the Filter EGs.

Amp EG Attack Time. (-99...+99)

This scales the attack times of the Amp EGs.

Amp EG Decay Time. (-99...+99)

This scales the decay and slope times of the Amp EGs.

Amp EG Sustain Level. (-99...+99)

This scales the sustain levels of the Amp EGs.

Amp EG Release Time. (-99...+99)

This scales the release times of the Amp EGs.

Pitch EG Attack Time. (-99...+99)

This scales the attack times of the Pitch EG.

Pitch EG Decay Time. (-99...+99)

This scales the decay and slope times of the Pitch EG.

Pitch EG Sustain Level (N/A). (-99...+99)

This scales the sustain levels of the Pitch EG.

Pitch EG Release Time. (-99...+99)

This scales the release times of the Pitch EG.

Pitch LFO1 Intensity. (-99...+99, CC#77)

This scales the effect of LFO1 on the Pitch.

-99 removes the LFO modulation entirely. +99 means maximum modulation in the same direction, positive or negative, as the original Program.

LFO1 Speed. (-99...+99, CC#76)

This scales LFO1's frequency. When the LFO is in MIDI/Tempo mode, this adjusts the Base Note. For more information, please see "Frequency" on page 42.

LFO1 Fade. (-99...+99)

This scales LFO1's fade-in time. For more information, please see "Fade" on page 43.

LFO1 Delay. (-99...+99, CC#78)

This scales LFO1's delay time - the time between note-on and the onset of the LFO. For more information, please see "Delay" on page 43.

This parameter interacts with CC# 78.

LFO1 Stop. (PROG/Off/On, Absolute)

This **Absolute** parameter controls whether LFO1 is stopped or running. For more information, please see "Stop" on page 42.

The **PROG** setting restores the Program's original values. For example, if you set this to PROG when the oscillator 1 LFO is stopped and oscillator 2 is playing, the original setting of the parameter will be used.

LFO2 Speed. (-99...+99)

This scales LFO2's frequency. When the LFO is in MIDI/Tempo mode, this adjusts the Base Note. For more information, please see "Frequency" on page 42.

LFO2 Fade. (-99...+99)

This scales LFO2's fade-in time. For more information, please see "Fade" on page 43.

LFO2 Delay. (-99...+99)

This scales LFO2's delay time - the time between note-on and the onset of the LFO. For more information, please see "Delay" on page 43.

LFO2 Stop. (PROG/Off/On, Absolute)

This **Absolute** parameter controls whether LFO2 is stopped or running. For more information, please see "Stop" on page 42.

Common LFO Speed. (-99...+99)

This scales the Common LFO's frequency. When the LFO is in MIDI/Tempo mode, this adjusts the Base Note.

Unison. (Off/On, Absolute)

This **Absolute** parameter turns **Unison** on and off. For more information, please see "Unison" on page 13.

Number Of Voices. (2...6, Absolute)

This **Absolute** parameter sets the number of Unison voices.

If **Unison** is not **On**, this parameter has no effect. For more information, please see “Number of Voices” on page 13.

Detune. (00...99, Absolute)

This **Absolute** parameter sets the amount of detuning between the Unison voices. If **Unison** is not **On**, this parameter has no effect. For more information, please see “Detune” on page 13.

Thickness. (Off/01...09, Absolute)

This **Absolute** parameter sets the pattern of detuning between the Unison voices. If **Unison** is not **On**, or if **Detune** is set to **0**, this parameter has no effect. For more information, please see “Thickness” on page 13.

Tone Adjust Parameters

Macro parameters

The following three parameters affect both Oscillator 1 and Oscillator 2.

Note: In the list below, at the right of each parameter, the value range and edit type are shown in parentheses.

Pitch Stretch. (-12...+12, Relative)

This special control increases the Oscillator **Tune** parameter while lowering the **Transpose** parameter. The result is that the pitch stays the same, but the mapping of the samples to the keys changes. You can use this to create interesting shifts in timbre.

Hold. (Off/On, Absolute)

This lets you turn Hold on and off. For more information, please see “Hold” on page 14.

Reverse. (PROG/Off/On, Absolute)

This turns Reverse on/off for multisamples that allow the reverse setting for both oscillators. **PROG** restores the Program’s original settings. Reverse plays the waveform from end to start; the effect is only noticeable with unlooped samples.

Per-Oscillator parameters

These parameters affect each Oscillator separately. In the list, the parameters for Oscillator 1 appear first, with each name prefaced by OSC1; the parameters for Oscillator 2 appear next, prefaced by OSC2.

Unless otherwise specified, all of the Per-Oscillator parameters are **Absolute**.

Note: In the list below, the items in parentheses are (value, edit type) respectively.

Tune. (-1200...+1200, Relative)

This **Relative** parameter adds to or subtracts from the Oscillator’s Tune setting, as described under “Tune” on page 17.

Transpose. (-60...+60, Relative)

This **Relative** parameter adds to or subtracts from the Oscillator’s Transpose setting, as described under “Transpose” on page 17.

Note: as with **Transpose**, below, this is a simple addition or subtraction, as opposed to the more complex “scaling” function.

MS/DKit Select. (PROG/0...540, Absolute)

In Single or Double Programs, this lets you select a new Multisample for the Oscillator. In Drum Programs, it lets you select a different Drum Kit.

In general, it’s best to use this in conjunction with the **MS Type** and **MS/DKit Bank** parameters, as described below.

PROG restores the Program’s original Multisamples (or the Drum Kit, for a Drum Program), including all velocity ranges and **Reverse** and **Start Offset** settings.

You can also limit the range of the control by using the **Min #** and **Max #** parameters, described below.

For Single and Double Programs:

MS/DKit Select overrides all of the Multisample Velocity zones, so that the newly selected Multisample plays over the entire velocity range.

By default, you can select from the same Bank as the original Program’s MS1.

You can use the **MS/DKit Bank** parameter, described below, to change these defaults as desired.

For Multisamples only:

You can use the Tone Adjust **Reverse** and **Start Offset** parameters to modify the newly selected Multisample. By default, the **Reverse** is set to **Off**, and its **Start Offset** is set to **0**.

For Drum Programs:

By default, you can select from the same Bank as the original Program’s Drum kit. You can use the **MS Bank** parameter, described below, to select a different Bank.

MS Bank. (Mono, Stereo..., Meta)

This Meta-parameter modifies the **MS/Dkit Select** parameter, so that you can select Multisamples from any Bank you like.

MS/DKit Min #. (0...540, Meta)

This Meta-parameter sets a minimum value for the **MS/Dkit Select** parameter. You can use this in conjunction with the **MS/DKit Max #** parameter, below, so that front panel value dial selects only from a small set of choices. This is particularly convenient with the internal, in which similar Multisamples are grouped together. For instance, this makes it easy to select between a group of bells, or a set of electric basses.

MS/DKit Max #. (0...540, Meta)

This Meta-parameter sets a maximum value for the **MS/Dkit Select** parameter. Please see **MS/DKit Min #**, above, for more information.

Start Offset. (Off, 1th...8th, Absolute)

This allows you to change the Start Offset of the Multisample specified by the **MS Select** parameter. It applies only when:

The Program is a Single or Double (not a Drum Kit)

For more information, please see “Offset (Start Offset)” on page 18.

Drive. (0...99, Absolute)

This controls the Oscillator’s **Drive** parameter, as described under “Drive” on page 35.

Low Boost. (0...99, Absolute)

This controls the Oscillator’s **Low Boost** parameter, as described under “Low Boost” on page 35.

Pitch Slope. (-1.0...2.0, Absolute)

This controls the Oscillator’s **Pitch Slope** parameter, as described under “Pitch Slope” on page 20.

LFO 1 Waveform. (Triangle...Rad6, Absolute)

This selects the waveform for the Oscillator’s **LFO 1**, as described under “Waveform” on page 42.

LFO 2 Waveform. (Triangle...Rnd6, Absolute)

This selects the waveform for the Oscillator’s **LFO 2**, as described under “Waveform” on page 42.

Amp LFO 1 Intensity. (-99...+99, Absolute)

This controls the depth and direction of Amp modulation from LFO1, as described under “Intensity (LFO1)” on page 38.

Amp LFO 2 Intensity. (-99...+99, Absolute)

This controls the depth and direction of Amp modulation from LFO2, as described under “Intensity (LFO1)” on page 38.

Filter LFO 1 Intensity to A. (-99...+99, Absolute)

This controls the depth and direction of Filter A cutoff

modulation from LFO1, as described under “Intensity to A” on page 30.

Filter LFO 1 Intensity to B. (-99...+99, Absolute)

This controls the depth and direction of Filter B cutoff modulation from LFO1, as described under “Intensity to B” on page 31.

Filter LFO 2 Intensity to A. (-99...+99, Absolute)

This controls the depth and direction of Filter A cutoff modulation from LFO2, as described under “Intensity to A” on page 30.

Filter LFO 2 Intensity to B. (-99...+99, Absolute)

This controls the depth and direction of Filter B cutoff modulation from LFO2, as described under “Intensity to B” on page 31.

Pitch LFO 1 AMS Intensity. (-12.00...+12.00, Absolute)

You can use an AMS source, such as aftertouch, to modulate the depth of pitch modulation (vibrato) from LFO1. This controls the intensity of that AMS modulation. For more information, please see “Intensity” on page 21.

Pitch LFO 2 AMS Intensity. (-12.00...+12.00, Absolute)

This is similar to Pitch LFO 1 AMS Intensity, above.

Default Tone Adjust Settings

You can use the Tone Adjust function to edit all of the important program parameters on this single page. Most of the preset sounds use the default layout shown below. You can customize these default settings for each program.

For details on the Tone Adjust function, please see “0-7b: Selected parameter information” on page 8.

Tone Adjust parameters

This applies to common tone adjust parameters and tone adjust parameters following the “0-7b: Selected parameter information” on page 8.

Default Tone Adjust Settings

| Controller | Default settings |
|------------|--------------------------|
| SW1 | [OSC1] Transpose |
| SW2 | [OSC2] Transpose |
| SW3 | [OSC1] Tune |
| SW4 | [OSC2] Tune |
| SW5 | [OSC1]MS/DKit Select |
| SW6 | Filter Cutoff |
| SW7 | Filter Resonance |
| SW8 | Filter EG Intensity |
| Slider1 | [OSC1&2] Pitch Stretch |
| Slider2 | [OSC1] Filter LFO1 Int A |
| Slider3 | [OSC1] Amp LFO Int |
| Slider4 | [OSC1] Drive |
| Slider5 | F/A EG Attack Time |
| Slider6 | F/A EG Decay Time |
| Slider7 | F/A EG Sustain Level |
| Slider8 | F/A EG Release Time |

✓ 0-7: Menu Command

- 0: Write Program see p. 64
- 1: Exclusive Solo see p. 64
- 2: Auto Song Setup see p. 65
- 3: Copy Tone Adjust see p. 65
- 4: Reset Tone Adjust see p. 65

For more information, please see “Program: Menu Command” on page 64.

PROG P1: Basic/Controllers

1-1: Program Basic

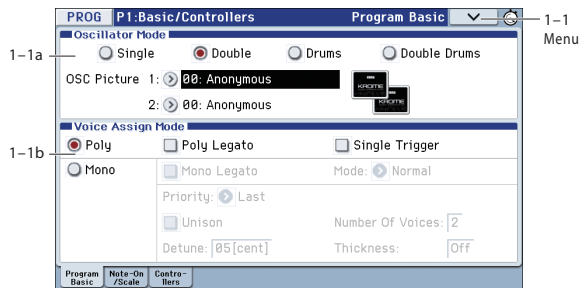

This page contains all of the basic settings for the Program. Among other things, you can:

- Set up the Program to be a Single, a Double, a Drum Kit, or a Double Drum Kit.
- Set the Program to play polyphonically or monophonically.

1-1a: Oscillator Mode

Oscillator Mode

[Single, Double, Drums, Double Drums]

Specifies the Program's oscillator assignment; whether it will use one or two oscillators, or a drum kit.

Single: The program will use **one oscillator** (Oscillator 1, Filter 1, Amplifier 1). In this case, the program will normally have a **maximum of 120-note polyphony**.

Double: The program will use **two oscillators** (Oscillator 1/2, Filter 1/2, Amplifier 1/2). In this case the program will normally have a **maximum of 60-note polyphony**.

Drums: The program will use **one oscillator** (as when Single is selected), but Oscillator 1 will be assigned a drum kit instead of a multisample. In this case the program will normally have a **maximum of 120-note polyphony**.

Double Drums: The Program will use two oscillators to play two Drum Kits. In this case the Program will normally have a maximum of 60-note polyphony.

OSC Picture 1, 2 **[MS Names...]**

Here you can specify a graphic for oscillators 1 and 2 that will be shown in the main P0 Play page.

To open the menu, press the popup button or press the preview area twice in succession.

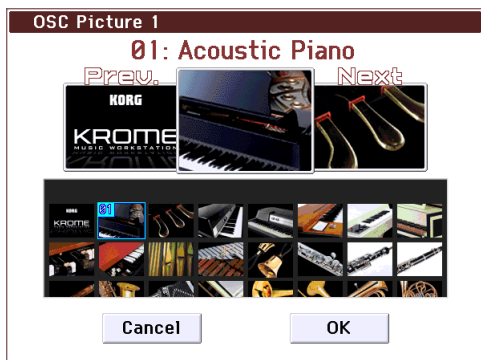

To choose the graphic, press the graphic view at the bottom of the menu or the left or right graphics in the upper part. To confirm your selection, press the OK button or press the upper middle graphic twice in succession.

OSC Picture 2 is unavailable if the **Oscillator Mode** is Single or Drums.

1-1b: Voice Assign Mode

Voice Assign Mode **[Poly, Mono]**

Select the basic voice allocation mode. Depending on which one you select, various other options will appear, such as **Poly Legato (Poly mode only)** and **Unison (Mono mode only)**.

Poly: The program will play polyphonically, allowing you play chords.

Mono: The program will play monophonically, producing only one note at a time.

Poly Legato **[Off, On]**

Poly Legato is available when the **Voice Assign Mode** is set to **Poly**.

Legato means to play note so that they are smooth and connected; the next note is played before the last note is released. This is the opposite of playing detached.

On (checked): When you play a legato phrase, only the first note of that phrase (and within approximately the first 30msec) will use the normal multisample start point specified by **Start Offset** (Prog 2-1a); all subsequent notes will use the legato start point specified for each multisample.

Note: This is a useful way to simulate the percussive attack of a tonewheel-type organ.

Off (unchecked): Notes will always use the setting of the **Start Offset**, regardless of whether you play legato or detached.

With some Multisamples, **Poly Legato** may not have any effect.

Single Trigger **[Off, On]**

Single Trigger is available when the **Voice Assign Mode** is set to **Poly**.

On (checked): When you play the same note repeatedly, the previous note will be silenced before the next note is sounded, so that the two do not overlap.

Off (unchecked): When you play the same note repeatedly, the notes will overlap.

Mono Legato **[Off, On]**

This is available when the **Voice Assign Mode** is set to **Mono**.

Legato means to play notes so that they are smooth and connected; the next note is played before the last note is released. This is the opposite of playing detached.

When **Mono Legato** is On, the first note in a legato phrase will sound normally, and then subsequent notes will have a smoother sound, for more gentle transitions between the notes.

The **Mode** parameter, below, switches between two different Mono Legato effects, each of which achieves this smoothness in a different way. See the description of that parameter for more details.

On (checked): When you play with legato phrasing, the notes within a legato phrase will sound smoother, according to the setting of the **Mode** parameter, below.

Off (unchecked): Legato phrasing will produce the same sound as detached playing.

Mode [Normal, Use Legato Offset]

This parameter is available only when **Mono Legato** is **On**.

Normal: When you play legato, the multisample, envelopes, and LFOs will not be reset; only the pitch of the oscillator will change. This setting is particularly effective for wind instruments and analog synth sounds.

 With this option, the pitch may occasionally be incorrect, depending on which multisample you play, and where on the keyboard you play.

Use Legato Offset: When you play legato, the second and subsequent notes will use the legato start point specified for each multisample, rather than the **Start Offset** (Start Offset 2-1a) setting.

This is effective when used with a multisample for which you've assigned a specific legato offset point. For example, you might use it to control the attack of a breathy, slow-attack sax sound. On some multisamples, this will have no effect.

Envelopes and LFOs will still be reset, as they are with detached playing.

Priority [Low, High, Last]

Priority is available when the **Voice Assign Mode** is set to **Mono**.

This parameter determines what happens when more than one note is being held down.

Low: The lowest note will sound. Many vintage, monophonic analog synths work this way

High: The highest note will sound.

Last: The most recently played note will sound.

Unison [On, Off]

Unison can be used in **Mono** mode.

On (checked): When Unison is on, the Program uses two or more stacked, detuned voices to create a thick sound.

Use the **Number of Voices** and **Detune** parameters to set the number of voices and amount of detuning, and the **Thickness** parameter to control the character of the detuning.

Off (unchecked): The Program plays normally.

Number of Voices [2...6]

This controls the number of detuned voices that will be played for each note when using **Unison**. It applies only when **Unison** is **On**.

Detune [00...99 cents]

Detune is available when **Unison** is **On**.

This parameter sets the tuning spread for the Unison voices, in cents (1/100 of a semitone). The **Thickness** parameter, below, controls how the voices are distributed across the detune amount. When **Thickness** is **Off**, the voices are distributed evenly, centered around the basic pitch.

For instance, let's say that the **Number of voices** parameter is set to **3**, **Detune** is set to **24**, and **Thickness** is **Off**:

Voice one will be detuned down by 12 cents, voice two will not be detuned, and voice three will be detuned up by 12 cents.

| Voice | Detune |
|-------|--------|
| 1 | -12 |
| 2 | 0 |
| 3 | +12 |

As another example, let's say that **Detune** is still set to **24** and **Thickness** is still **Off**, but **Number of voices** is set to **4**:

Voice one will still be detuned down by 12 cents, voice two will be detuned down by 4 cents, voice three will be detuned up by 4 cents, and voice 4 will be detuned up by 12 cents.

| Voice | Detune |
|-------|--------|
| 1 | -12 |
| 2 | -4 |
| 3 | +4 |
| 4 | +12 |

Thickness [Off, 01...09]

Thickness is available when **Unison** is **On**.

This parameter controls the character of the detuning for the unison voices.

Off: Unison voices will be evenly distributed across the Detune range, as shown above.

01-09: Unison voices will be detuned in an asymmetric way, increasing the complexity of the detune, and changing the way in which the different pitches beat against one another. This creates an effect similar to vintage analog synthesizers, in which oscillators would frequently drift slightly out of tune. Higher numbers increase the effect.

✓ **1-1: Menu Command**

- 0: **Write Program** see p. 64
- 1: **Exclusive Solo** see p. 64
- 2: **Auto Song Setup** see p. 65
- 3: **Copy Oscillator** see p. 65
- 4: **Swap Oscillator** see p. 65

For more information, please see "Program: Menu Command" on page 64.

1-2: Note-On/Scale

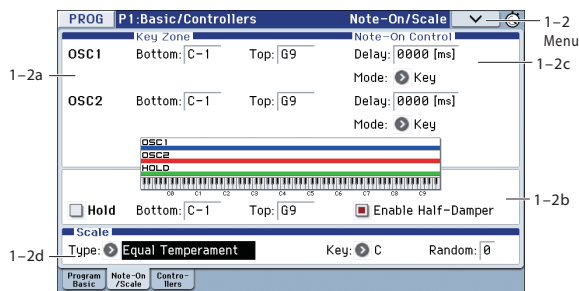

Here, you can make the following settings.

- Make keyboard split settings for OSC1, OSC2, and Hold.
- Enable/disable the half-damper function.
- Select the basic scale of the program.

1-2a: Key Zone

You can create keyboard splits by setting top and bottom key limits for Oscillators 1 and 2. Also, you can control the keyboard range over which the **Hold** parameter takes effect.

Note: You can also set the note values and velocity values by holding down an edit cell or the ENTER button and playing a key (see OG p.10).

OSC 1 Bottom [C-1...G9]

This sets the lowest key on which Oscillator 1 will play.

OSC 1 Top [C-1...G9]

This sets the highest key on which Oscillator 1 will play.

OSC 2 Bottom [C-1...G9]

This sets the lowest key on which Oscillator 2 will play.

OSC 2 Top [C-1...G9]

This sets the highest key on which Oscillator 2 will play.

Hold [On, Off]

Hold is like permanently pressing down on the sustain pedal. In other words, notes continue to sound as if you were holding down the key - even after you lift your fingers from the keyboard.

Unless the **Sustain Level** is set to 0 in Amp EG 1 (and Amp EG 2 in a Double Program), the sound will play for the entire length of the multisample(s).

On (checked): The **Hold** function is enabled for the range set by the **Hold Bottom** and **Hold Top** parameters, below.

Off (unchecked): Notes will play normally. This is the default setting.

Using Hold with Drum Kits

Hold can be especially useful for drum programs, since it lets the drum samples ring out naturally. In general, when you set the **Oscillator Mode** to **Drums**, it's good to set **Hold** to **On**.

Once you've turned on **Hold** for a drum program, the function is controlled on a note-by-note basis according to settings within the selected Drum Kit.

If a key's **Enable Note Off Receive** parameter (Global 5-4a) is unchecked, the note will be held.

If the key's **Enable Note Off Receive** parameter is checked, it will not be held.

If you turn off **Hold** in the Program, no keys will be held - regardless of their **Enable Note Off Receive** setting.

Using Hold with Acoustic Pianos

Hold is also useful for simulating the top octaves of an acoustic piano, in which notes always sustain until they fade out naturally, regardless of how long you hold the key.

The **Hold Bottom** and **Hold Top** parameters are designed for exactly this purpose. They let you limit the effect of the Hold parameter to a specific range of the keyboard.

Hold Bottom [C-1...G9]

This sets the lowest key affected by the Hold function.

Hold Top [C-1...G9]

This sets the highest key affected by the Hold function.

1-2b: Half-Damper Control

A half-damper pedal is a special type of continuous foot pedal, such as the Korg DS-1H. In comparison to a standard footswitch, half-damper pedals offer more subtle control of sustain, which can be especially useful for piano sounds.

The KROME will automatically sense when a half-damper is connected to the rear-panel DAMPER input. For proper operation, you will also need to calibrate the pedal, using the **Half Damper Calibration** command in the Global menu.

The off and full-on positions of the half-damper work just like a standard footswitch. In conjunction with the **Enable Half-Damper** parameter, below, intermediate positions allow a graduated control of sustain, similar to the damper pedal of an acoustic piano.

Enable Half-Damper [On, Off]

When this is **On** (checked), Half-Damper pedals, normal sustain pedals, and MIDI CC# 64 will all modulate the Amp EG, as described below.

When this is **Off** (un-checked), the pedals and MIDI CC#64 will still hold notes as usual, but will not modulate the Amp EG.

Half-Damper Pedal and Release Time

The amount of modulation depends on whether the Amp EG **Sustain Level** is set to 0 (as is the case with most acoustic piano sounds), or set to 1 or more. The modulation is continuous, from 1x (no change) to 55 times longer; the table below shows a selection of representative points.

Half-Damper modulation of Amp EG Release Time

| CC#64 Value | Multiply Amp EG Release Time by... | |
|-------------|------------------------------------|------------------------|
| | If Sustain = 0 | If Sustain = 1 or more |
| 0 | 1x | 1x |
| 32 | 2.1x | 2.1x |
| 64 | 3.2x | 3.2x |
| 80 | 5.9x | |
| 96 | 22.3x | |
| 127 | 55x | |

1-2c: OSC1/2 Note-On Control

OSC1 Delay [0000ms...5000ms, KeyOff]

This specifies the time from when you press a key until oscillator 1 actually begins to sound.

This is most useful in Double Programs, for delaying one oscillator in relation to the other.

KeyOff is a special setting. Instead of delaying the sound by a particular amount of time, the sound will play as soon as you release the key. You can use this to create the "click" heard when a harpsichord note is released, for instance.

In general, when you use the **KeyOff** setting, it's also best to set the oscillator's Amp EG **Sustain Level** to 0.

Mode [Key, Key + Damper]

Normally, you play notes simply by pressing keys on the keyboard. In special cases, however, you can set this parameter so that you must first be holding down the damper pedal, and then press a key, in order to play a note. For instance, this can be useful when modeling the behavior of a piano soundboard.

Key is the normal mode.

When you select **Key + Damper**, notes will only sound if the damper pedal is being held down. When the damper pedal is released, all notes will be stopped even if they are still being held down.

OSC2 Delay [0000ms...5000ms, KeyOff]

Mode [Key, Key + Damper]

This specifies the time from when you press a key until oscillator 2 actually begins to sound.

See **OSC1 Delay** and **Mode**, above.

1-2d: Scale

Type

[Equal Temperament...User Octave Scale15]

Selects the basic scale for the Program.

Note that for many of the scales, the setting of the **Key** parameter, below, is very important.

Equal Temperament: This is the most widely used scale by far, in which each semitone step is spaced at equal pitch intervals.

Equal Temperament allows easy modulation, so that a chord progression played in the key of C sounds roughly the same as the same progression played in F#. Sacrificed, however, is some of the purity of individual intervals offered by the scales below.

Pure Major: In this temperament, major chords of the selected key will be perfectly in tune.

Pure Minor: In this temperament, minor chords of the selected key will be perfectly in tune.

Arabic: This scale includes the quarter-tone intervals used in Arabic music.

Pythagoras: This scale is based on ancient Greek music theory, and is especially effective for playing melodies. It produces completely pure fifths, with one exception, at the expense of detuning other intervals— thirds in particular.

As much as Pythagoras might have liked to do so, it's not possible to make all the fifths pure while also keeping the octave in tune. For the sake of the octave, one of the fifths the interval from the sharp fourth degree to the sharp first degree is made quite flat.

Werkmeister (Werkmeister III): This scale was one of the many temperament systems developed towards the end of the Baroque period. These "Well-Tempered" tunings were aimed at allowing relatively free transposition although you'll still notice that the different keys maintain their own distinct characteristics, unlike Equal Temperament.

J.S. Bach was referring to these new scales in his title, "The Well-Tempered Clavier." As such, this group are particularly appropriate for late baroque organ and harpsichord music.

Kirnberger (Kirnberger III): This is a second "Well-Tempered" tuning, dating from the early 18th century.

Slendro: This is an Indonesian gamelan scale, with five notes per octave.

When **Key** is set to C, use the C, D, F, G and A notes. Other keys will play the normal equal-tempered pitches.

Pelog: This is another Indonesian gamelan scale, with seven notes per octave.

When **Key** is set to C, use the white keys. The black keys will play the equal tempered pitches.

Stretch: This tuning is used for acoustic pianos.

User All Notes Scale: This is a user-programmed scale with different settings for all 128 MIDI notes. You can set up this scale in Global mode (Global 3-1b).

User Octave Scale 00-15: These are user-programmed scales with settings for each of the 12 notes in an octave. You can set them up in Global mode (Global 3-1a).

Key (Scale Key) [C...B]

Selects the key of the specified scale.

This setting does not apply to the **Equal Temperament**, **Stretch**, and **User All Notes** scales.

 If you're using a scale other than Equal Temperament, the combination of the selected scale and the **Key** setting may skew the tuning of the note. For example, A above middle C might become 442 Hz, instead of the normal 440 Hz. You can use the Global Mode's **Master Tune** (Global 0-1a) parameter to correct this, if necessary.

Random [0...7]

This parameter creates random variations in pitch for each note. At the default value of 0, pitch will be completely stable; higher values create more randomization.

This parameter is handy for simulating instruments that have natural pitch instabilities, such as analog synths, tape-mechanism organs or acoustic instruments.

✓ 1-2: Menu Command

- 0: **Write Program** see p. 64
- 1: **Exclusive Solo** see p. 64
- 2: **Auto Song Setup** see p. 65
- 3: **Copy Oscillator** see p. 65
- 4: **Swap Oscillator** see p. 65

For more information, please see "Program: Menu Command" on page 64.

1-3: Controllers Setup

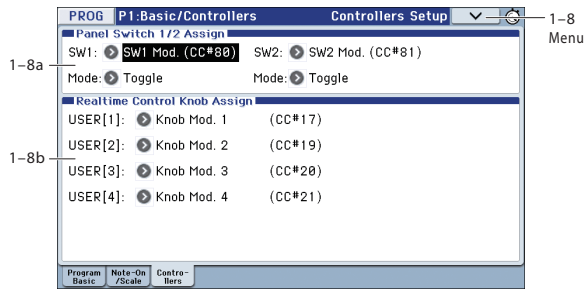

Here you can specify the SW1 and SW2 switch and front panel 1-4 knobs of the program when Realtime Controls USER is selected.

1-3a: Panel Switch 1/2 Assign

SW1 (SW1 Assign) [Off, ..., JS-Y Lock]

This assigns the function of SW1. For more information, please see “List of SW 1/2 assignments” on page 348.

Note: If you change the function setting, the status is reset to off.

Note: The on/off status of the SW1, SW2 switches is memorized when you save the program.

Mode (SW1 Mode) [Toggle, Momentary]

This specifies the on/off operation when you press the SW1 switch.

Toggle: The state will alternate between On and Off each time you press the SW1 switch.

Momentary: The state will remain On only while you continue holding down the SW1 switch.

SW2 (SW2 Assign) [Off, ..., JS-Y Lock]

Mode (SW2 Mode) [Toggle, Momentary]

This assigns the function of SW2. The functions that can be assigned to SW2 are the same as for SW1, with the substitution of SW2 Mod. (CC#81) instead of the SW1’s SW1 Mod. (CC#80).

1-3b: Realtime Controls Knob Assign

Here you can select the functions (mainly types of control change) that are assigned to knobs 1-4 when **Control Assign** (0-8b) Realtime Controls USER is selected. (See “Realtime Controls Knobs 1-4 Assignments” on page 348)

The functions you assign here are active when you use the SELECT button to select USER, and operate knobs 1-4.

USER [1] [Off, ..., MIDI CC#95, CC#102...119]

USER [2] [Off, ..., MIDI CC#95, CC#102...119]

USER [3] [Off, ..., MIDI CC#95, CC#102...119]

USER [4] [Off, ..., MIDI CC#95, CC#102...119]

∨ 1-3: Menu Command

- 0: **Write Program** see p. 64
- 1: **Exclusive Solo** see p. 64
- 2: **Auto Song Setup** see p. 65

For more information, please see “Program: Menu Command” on page 64.

PROG P2: OSC/Pitch

These pages control the first and most basic elements of sounds: the Multisamples that the oscillators play, and the pitch at which it plays them. For instance, you can:

- Select Multisamples for Single and Double Programs, or Drum Kits for Drums and Double Drums Programs.
- Set up velocity splits, crossfades, and layers for Single and Double Programs.
- Set the basic pitch of the sound, including the octave, fine tuning, and so on.
- Control pitch modulation using a variety of controllers such as LFO, pitch EG, and the joystick.

Note that when the **Oscillator Mode** is set to **Single** or **Drums**, only Oscillator 1's filters are active; the pages for Oscillator 2's filters will be grayed out.

Multisamples, and Drum Kits

Multisamples and Drum Kits allow you to play samples in different ways.

- Multisamples lay out one or more samples across the keyboard. For instance, a very simple guitar Multisample might have six samples one for each string.
- As the name suggests, Drum Kits are optimized for playing drum samples.

Velocity splits, crossfades, and layers

Each oscillator has eight velocity zones that allow different keyboard velocities to switch the multisample or drum sample that is actually sounded.

For each zone, you can specify the threshold (boundary value) and crossfade (how velocity will smoothly fade between the samples of adjacent zones). This allows you to create velocity-switched or layered sounds, such as the following examples.

- Velocity splits in which the zones are cleanly separated at their threshold
- Velocity crossfades in which the zones will smoothly crossfade beyond their threshold.
- Velocity layers in which additional sounds are added for a velocity region above a specified threshold.

Note: If the **Oscillator Mode** is Drums or Double Drums, the velocity zone settings already specified for the drum kit will be applied, and will not be shown in the screen. The velocity zones for a drum kit can be edited in Global P5 Drum Kit (see p.205). Pressing the Jump to Drum Kit Edit button shown in the screen will take you directly to Global P5.

2-1: OSC1 Setup

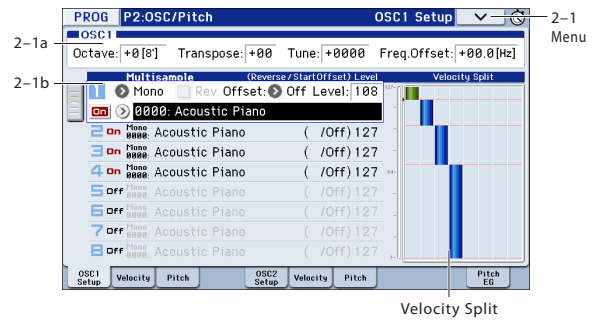

Program's sounds are based on multisamples, and this page lets you set up all of the basic multisample-related settings. Among other things, you can:

- Select Multisamples for the Oscillator (in a Single or Double Program), or select the Drum Kit for a Drum Program
- Set the Oscillator's basic pitch

2-1a: OSC1 Frequency

"Oscillator Mode" Single, Double

OSC1 Frequency

Octave [-2[32'], -1[16'], +0[8'], +1[4']]

This sets the basic pitch of the Oscillator, in octaves. The default is +0[8']. The standard octave of a multisample is +0[8'].

Transpose [-12...+12]

This adjusts the pitch in semitones, over a range of ±1 octave.

Tune [-1200...+1200]

This adjusts the pitch in cents, over a range of ±1 octave. A cent is 1/100 of a semitone.

Frequency Offset [-10.0Hz ... +10Hz]

This adjusts the pitch by increments of 0.1 Hz. **Frequency Offset** is different from **Tune** in that, when used to detune the two oscillators, it can create a constant beat frequency across the range of the keyboard.

2-1b: Multisamples

Use the slider on the left to check the settings of each drum sample shown in abbreviated form. Drag the slider to view the settings.

1: Multisample 1

If you want to create a simple setup with only a single Multisample, just set up Multisample1 as desired, and then set the **Threshold Velocity** to 1 and the **Crossfade** (**Crossfade Range**) to Off.

Multisample On/Off [Off, On]

Specifies whether the multisample 1 will sound.

It will sound if this is On.

Bank [Mono, Stereo, XL, M, XL, St]

This is displayed if **Multisample On/Off** is On.

You can choose between looking at mono and stereo Multisamples.

Mono, Stereo: Conventional monaural or stereo multisamples.

XL.M (eXtra Large Mono), XL.St (eXtra Large Stereo): High-capacity monaural or stereo multisamples.

Note that stereo Multisamples will require twice as many voices as mono Multisamples.

Multisample select [List of Multisample]

This specifies a multisample.

Some multisamples have an upper limit; notes played above that limit will not sound.

When you press the **Multisample Select** popup button, the multisample list will appear, allowing you to select a multisample from the list.

Use the tabs to select a category, and select a multisample within the category.

You can search for a multisample by a portion of its name (see p.2).

Press the OK button to confirm the selection, or the Cancel button to cancel.

| ROM Multisample | | Keyboard | | |
|-----------------|----------------------------|-----------------------------|--------|---------|
| Keyboard | 0000: Acoustic Piano | 0008: EPiano-Mark V v115 | Ethnic | Plucked |
| Organ | 0001: APiano-M1 | 0009: EPiano-Mark V v119 | Synth | Wave |
| Mallet/Bell | 0002: APiano-SG | 0010: EPiano-Mark V v122 | Wave- | Station |
| Woodwind | 0003: Electric Grand Piano | 0011: EPiano-Mark V v127 | Single | Wave |
| Brass | 0004: EPiano-Mark V v056 | 0012: EPiano-Mark I Key Off | DWGS | |
| Choir | 0005: EPiano-Mark V v080 | 0013: EPiano-Mark V Key Off | SE 1 | |
| Strings | 0006: EPiano-Mark V v094 | 0014: EPiano-Dyno Key Off | SE 2 | |
| Guitar | 0007: EPiano-Mark V v106 | 0015: EPiano-200A Key Off | Drum | Wave |
| Bass | | | | |

Rev (Reverse) [Off, On]

This plays the selected multisample in reverse without looping it.

Note: If an individual sample within the multisample is already set to reverse, it will play in reverse without this setting.

On (checked): The multisample will play in reverse.

For velocity zones that are not selected (shown as one line), "Rev" On is indicated as [R].

Off (unchecked): The multisample will play normally.

Offset (Start Offset) [Off, 1st...8th]

In addition to simply starting playback from the beginning, Multisamples can have up to 8 different pre-programmed alternate starting points.

The **Start Offset** specifies whether to use the normal start point (**Off**), or to use one of the alternate start points (**1st-8th**).

Some Multisamples may have fewer than 8 pre-programmed points, in which case only the available points can be selected.

Level [000...127]

This sets the basic volume level of the multisample. The Amp section can modify this basic level extensively with envelopes, LFOs, keyboard tracking, and other modulation; for more information, please see "PROG P4: Amp/EQ" on page 35.

Depending on the multisample, high **Level** settings may cause distortion when playing many notes at a time. If this occurs, lower the **Level**.

2...8: (Multisample 2...8)

These are the multisample settings for the Multisample 2-8. The parameters are exactly the same as those for Multisample 1.

Velocity Split

This shows the velocity zones for the oscillator's eight multisamples and for each oscillator.

The meter to the left indicates the note-on velocity. This allows you to verify the multisamples and oscillators that will sound at each velocity (See "0-1e: Velocity Meter" on page 5).

2-1c: OSC1 (Drum Kit Frequency)

"Oscillator Mode" Drums, Double Drums



Octave [-2[32'], -1[16'], +0[8'], +1[4']]

This adjusts the pitch in octave units. When using a drum kit, set the Octave to 8'.

When editing a drum program, you must set this parameter to 8'. With other settings, the sounds of the drum kit will be assigned to the wrong notes of the keyboard.

Transpose [-12...+12]

This adjusts the location of the instruments in the selected drum kit. Unless you need to change this, leave it at 0.

Tune [-1200...+1200]

This adjusts the pitch in one-cent units.

The pitch of each drum kit can be adjusted in Global P5: Drum kit.

Freq. Offset (Frequency Offset) [-10.0Hz ... +10Hz]

This adjusts the pitch by increments of 0.1 Hz. **Frequency Offset** is different from **Tune** in that, when used to detune the two oscillators, it can create a constant beat frequency across the range of the keyboard.

2-1d: Drum Kit

These parameters appear when the **Oscillator Mode** is set to Drums or Double Drums.

Drum Kit [000...031 (INT), 032...047 (USER), 048...056 (GM)]

This selects a drum kit.

Jump to Drum kit Edit Page button

Pressing this button will take you directly to Global P5: Drum Kit where you can edit the drum kit selected by **Drum Kit Select**. Even if **Oscillator Mode** is set to Double Drums, you will hear only the kit that was selected. If the GM drum kit was selected, the last-selected drum kit will be selected. As desired, use "Copy Drum Kit" to copy the GM drum kit to the USER bank.

✓ 2-1: Menu Command

- 0: **Write Program** see p. 64
- 1: **Exclusive Solo** see p. 64
- 2: **Auto Song Setup** see p. 65
- 3: **Copy Oscillator** see p. 65
- 4: **Swap Oscillator** see p. 65

For more information, please see "Program: Menu Command" on page 64.

2-2: OSC1 Velocity

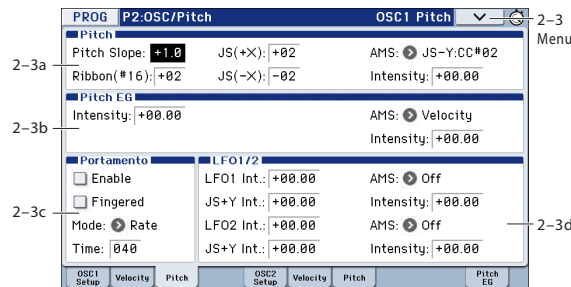

Here you can make the following settings.

- Velocity zone for oscillator 1
- The multisample's velocity split and crossfade settings

2-2a: OSC 1 Velocity Zone

Velocity can be used to switch between sounding oscillators 1 and 2. Here you can specify the velocity zone for oscillator 1.

This velocity zone setting takes priority over the velocity settings of multisamples 1-8. The status of the settings is indicated by the graph on the right side of the screen. This lets you make settings while comparing them with the velocity split graph.

Bottom [001...127]

This sets the lowest velocity at which the Oscillator 1 will sound.

Top [001...127]

This sets the highest velocity at which the Oscillator 1 will sound.

Note: The **OSC1 Top** velocity must be greater than the **OSC1 Bottom** velocity.

Note: You can also set the note value and velocity value by holding down the edit cell or the ENTER button and playing a note on the keyboard (see OG p.10).

2-2b: Multisample Velocity Zone

Here you can specify the velocity zone for each of the oscillator's eight multisamples.

Threshold Velocity [001...127]

This sets the lowest velocity at which the Multisample will sound. Multisample1's **Threshold Velocity** can be equal to, but not lower than, that of Multisample2.

Crossfade (Crossfade Range) [Off, 001...127]

This sets the range of velocities over which Multisample1 will fade into Multisample2, going up from the **Threshold Velocity**.

For instance, if the **Threshold Velocity** is set to 64, and the **Crossfade** is set to 20, MS2 will start to fade in at velocities of 84 and below.

When velocities are within the **Crossfade**, the Oscillator will use twice as much polyphony as it would normally.

Note: You can only fade between two zones at once.

Note: You can touch and drag to change this value (See "EG, Velocity Split" on page 6 of the Operation guide.).

This shows the velocity zone.

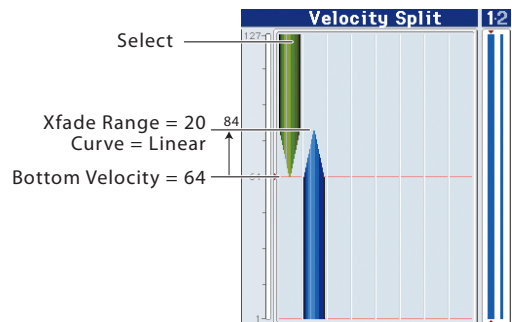

Curve [Linear, Power, Layer]

This controls the volume curve of the crossfade. **Linear** and **Power** (short for Equal Power) let you fine-tune the way that the two Multisamples mix together; one or the other may be more appropriate for a given pair of Multisamples. **Layer**, true to its name, lets you layer the two Multisamples together without any crossfading.

Linear means that the two samples will each be at 50% of their full volume in the middle of the crossfade. Sometimes, this may create a dip in the volume level; if so, try using **Power** instead.

Power, short for Equal Power, means that the two samples will each be at around 70% of their full volume in the middle of the crossfade. Sometimes, this may create a bump in the volume level, in which case you might try selecting **Linear** instead.

Layer means that the two Multisamples will be layered together, both at full volume, for the entire range of the crossfade.

Crossfade Curves

Linear

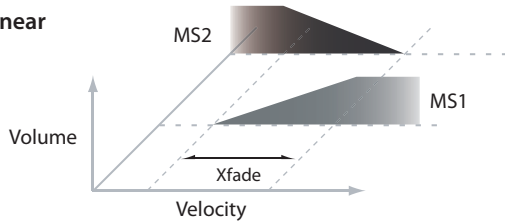

Power

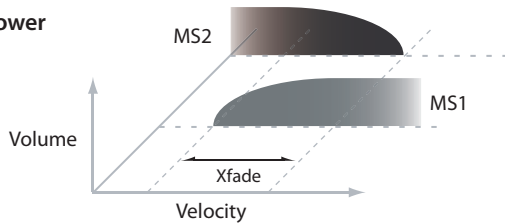

Layer

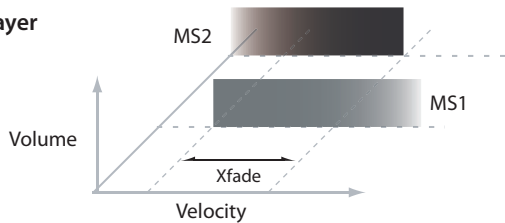

Velocity Split Zone

This specifies the velocity zone for each of the oscillator's eight multisamples. The meter shows the note-on velocity value.

Velocity Split

This shows the velocity zones for the oscillator's eight multisamples and for each oscillator.

The meter at the left indicates the note-on velocity. This allows you to verify the multisamples and oscillators that will sound at each velocity (See "0-1e: Velocity Meter" on page 5).

2-2c: OSC1 Velocity

"Oscillator Mode" Drums, Double Drums

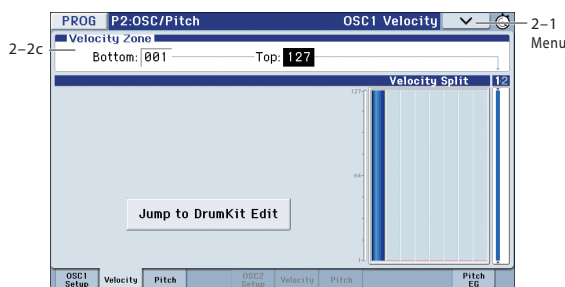

Velocity can be used to switch between the drum kits sounded by oscillators 1 and 2. Here you can specify the velocity zone for oscillator 1. The status of the settings will be indicated in the graph on the right side of the screen. This lets you edit settings while comparing them with the velocity split graph.

Bottom [001...127]

This sets the lowest velocity at which the Oscillator 1 will sound.

Top [001...127]

This sets the highest velocity at which the Oscillator 1 will sound.

The OSC1 Top velocity must be greater than the OSC1 Bottom velocity.

Note: You can also set the note value and velocity value by holding down the edit cell or the ENTER button and playing a note on the keyboard (see OG p.10).

Velocity Split

This shows the velocity zone for the oscillator.

The meter on the left shows the note-on velocity values for the global MIDI channel. This lets you verify the multisamples that will sound at each velocity (See "0-1e: Velocity Meter" on page 5).

Jump to Drum kit Edit Page button

See "Jump to Drum kit Edit Page button" on page 19.

2-2: Menu Command

- 0: Write Program see p. 64
- 1: Exclusive Solo see p. 64
- 2: Auto Song Setup see p. 65
- 3: Copy Oscillator see p. 65
- 4: Swap Oscillator see p. 65

For more information, please see "Program: Menu Command" on page 64.

2-3: OSC1 Pitch

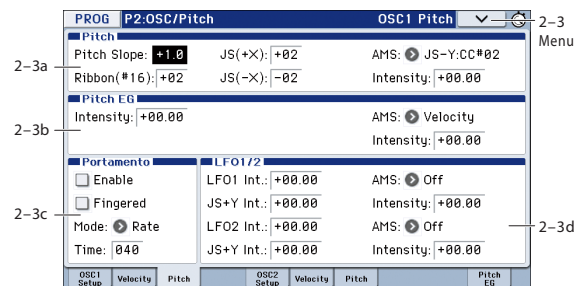

This page contains all of the settings for Oscillator 1's pitch modulation. For example, you can:

- Specify pitch bend controlled by the joystick X (or an incoming pitch bend message) set to independent Bend Up and Bend Down, or controlled by an incoming message CC#16 (the ribbon control message etc).
- Use Pitch Slope to control how the pitch changes when you play up and down the keyboard.
- Assign AMS modulation for pitch.
- Set up initial amounts of pitch modulation from the Pitch EG and LFO1/2, as well as AMS modulation of LFO and EG amounts.
- Set up Portamento.

2-3a: Pitch

Pitch Slope [-1.0...+2.0]

Normally, this should be set to the default of +1.0.

Pitch Slope, pitch, and note

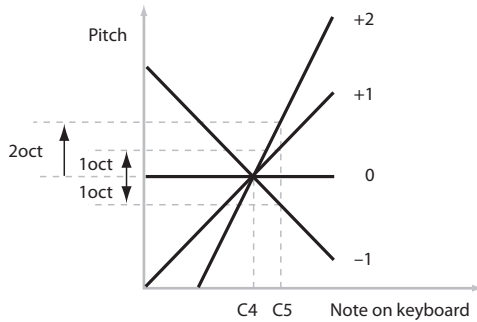

Positive (+) values cause the pitch to rise as you play higher on the keyboard, and **negative (-)** values cause the pitch to fall as you play higher on the keyboard.

When this is set to **0**, playing different notes on the keyboard won't change the pitch at all; it will be as if you're always playing C4. This can be useful for special effects sounds, for instance.

Ribbon [-12...+12]

Specify in semitones how the pitch will change when CC#16 is received.

With a positive (+) setting, the pitch will rise when the value of CC#16 is higher than the center value of 64. With a negative (-) setting, the pitch will fall.

JS (+X) [-60...+12]

Specify in semitones how the pitch will change when the joystick is moved to the right (or when a pitch bend message is received). For normal pitch bend, set this to a positive value.

For example, if you set this to **+12** and move the joystick all the way to the right, the pitch will rise one octave above the original pitch.

JS (-X) [-60...+12]

Specify in semitones how the pitch will change when the joystick is moved to the left (or when a pitch bend message is received). For normal pitch bend, set this to a negative value.

For example, if you set this to **-60** and move the joystick all the way to the left, the pitch will fall five octaves below the original pitch. You can use this to create guitar-style downward swoops.

AMS (Pitch) [List of AMS Sources]

This selects a AMS source to control the pitch. For a list of AMS sources, please see "AMS (Alternate Modulation Source) List" on page 340.

Intensity [-12.00...+12.00]

This controls the depth and direction of the pitch modulation, in semitones.

For example if you set **AMS (Pitch)** to **JS+Y: CC#01** and then move the joystick in the +Y direction, the pitch will rise if this parameter is set to a **positive (+)** value, or fall if this parameter is set to a **negative (-)** value.

2-3b: Pitch EG

Intensity [-12.00...+12.00]

This controls the initial effect of the Pitch EG on Oscillator 1's frequency, in half-steps, before any AMS modulation.

The Pitch EG's shape can swing all the way from +99 to -99. When the **Intensity** is set to a **positive (+)** value, positive values from the EG raise the pitch, and negative values lower the pitch.

When the **Intensity** is set to a **negative (-)** value, the effect of the EG is reversed; positive EG values mean lower pitches, and negative EG values mean higher pitches.

AMS (Pitch EG) [List of AMS Sources]

This selects any AMS modulation source to scale the amount of the Pitch EG.

For a list of AMS sources, please see "AMS (Alternate Modulation Source) List" on page 340.

Intensity [-12.00...+12.00]

This controls the depth and direction of the pitch EG AMS modulation. The AMS modulation and the initial Intensity are added together to determine the Pitch EG's final effect.

With **positive (+) values**, greater modulation will increase the effect of the Pitch EG, as shown in example **B** below.

With **negative (-) values**, greater modulation will introduce the opposite effect of the Pitch EG—like inverting the polarity of the envelope. You can use this in several different ways:

- You can set an initial positive amount with the Intensity parameter, and then reduce this amount with AMS. In this case, the final effect of the EG is simply diminished, and not actually inverted, as shown in example **C**.
- You can also set the AMS Intensity amount to be greater than the initial Intensity. In this case, the EG will have a positive effect with low modulation amounts, and an inverted effect at higher modulation amounts as shown in example **D**.

Pitch EG AMS

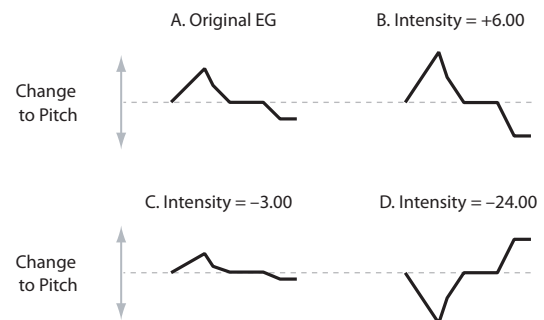

2-3c: Portamento

Portamento lets the pitch glide smoothly between notes, instead of changing abruptly.

Enable [Off, On]

On (checked): Turns on Portamento, so that pitch glides smoothly between notes.

Off (unchecked): Turns off Portamento. This is the default state.

Fingered [Off, On]

This parameter allows you to control Portamento through your playing style. When it's enabled, playing legato will turn on Portamento, and playing detached will turn it off again.

This option is only available when Portamento **Enable** is turned on.

On (checked): Turns on Fingered Portamento.

Off (unchecked): Turns off Fingered Portamento.

Mode [Rate, Time]

Rate means that Portamento will always take the same amount of time to glide a given distance in pitch - for instance, one second per octave. Put another way, gliding

several octaves will take much longer than gliding a half-step.

Time means that Portamento will always take the same amount of time to glide from one note to another, regardless of the difference in pitch. This is especially useful when playing chords, since it ensures that each note in the chord will end its glide at the same time.

Time [000...127]

This controls the portamento time. Higher values mean longer times, for slower changes in pitch.

This option is only available when Portamento **Enable** is turned on.

Assigning SW1 or SW2 to Portamento On/Off

You can turn portamento on/off by using the two assignable switches SW1 and SW2.

To do so:

1. Go to the Prog P1: Basic/Controllers– Controllers Setup page.
2. Under Panel Switch Assign, set either SW1 or SW2 to Porta.SW (CC#65).

Now, the selected switch will enable and disable Portamento.



If you assign portamento to SW1/2, MIDI portamento controller #65 will be transmitted each time you use the switch. You can also turn portamento on/off by receiving MIDI controller #65.

2-3d: LFO1/2

LFO1 and LFO2 can both control the pitch. You can control the strength of each LFO's modulation in three different ways:

- Set an initial amount of LFO modulation, using the **LFO1 Int.**, **LFO2 Int.** parameters.
- Use **JS +Y Int.** to adjust the amount of LFO produced by JS+Y operations.
- Use any AMS source to scale the amount of the LFO.

The results are added together to produce the total LFO effect.

LFO1

LFO1 Int. (LFO1 Intensity) [-12.00...+12.00]

This controls the initial effect of the LFO on the pitch, in semitones, before any **JS+Y Int.** or AMS modulation.

Negative (-) settings will invert the phase of the LFO.

JS+Y Int. (LFO1 JS+Y Intensity) [-12.00...+12.00]

Specify the depth of pitch modulation produced by OSC1 LFO1 when the joystick is moved in the +Y (away) direction (or when CC#1 is received). (Joystick control in the +Y direction is called "JS +Y.")

This parameter sets the maximum amount of LFO modulation added by JS+Y, in semitones.

As this value is **increased**, moving the joystick in the +Y direction will cause the OSC1 LFO1 to produce deeper pitch modulation.

Negative (-) settings will invert the phase of the LFO. You can also use this to reduce the initial amount of the LFO, as set by **LFO1 Int.**, above. For example:

1. Set **LFO1 Int.** to +7.00.

The LFO will now have a fairly strong effect on the pitch, bending it by a perfect 5th.

2. Set **JS+Y Int. Intensity** to -7.00.

Now, if you move the joystick up, the effect of the LFO will fade away. When the joystick is all the way at the top of its range, the LFO will be completely cancelled out.

AMS (LFO1) [List of AMS Sources]

This selects any AMS modulation source to scale the amount of the LFO applied to pitch.

For a list of AMS sources, please see "AMS (Alternate Modulation Source) List" on page 340.

Intensity [-12.00...+12.00]

This controls the depth and direction of the **AMS (LFO1)** modulation for pitch.

With a setting of 0, modulation will not be applied. With a setting of 12.00, the OSC1 LFO1 will apply a maximum of +/-1 octave of pitch modulation.

For example if **AMS (LFO1)** is set to **JS+Y: CC#01** and you move the joystick in the +Y direction, pitch modulation from OSC1 LFO1 will be applied in positive phase if this is a **positive (+)** value, or applied in negative phase if this is a **negative (-)** value.

LFO1 Int., **JS+Y Int.**, and **AMS (LFO1)** settings are summed to determine the depth and direction of pitch modulation produced by OSC1 LFO1.

LFO2:

The parameters for LFO2 are identical to those for LFO1. For more information, please see the descriptions under LFO1, above.

✓ 2-3: Menu Command

- 0: **Write Program** see p. 64
- 1: **Exclusive Solo** see p. 64
- 2: **Auto Song Setup** see p. 65
- 3: **Copy Oscillator** see p. 65
- 4: **Swap Oscillator** see p. 65

For more information, please see "Program: Menu Command" on page 64.

2-5: OSC2 Setup

On this page you can specify the basic oscillator pitch for oscillator 2, and assign the multisamples.

It is available when the **Oscillator Mode** is set to **Double** or **Double Drums**; if not, the page will be grayed out.

The parameters are identical to those for Oscillator 1, as described under "2-1: OSC1 Setup" on page 17.

2-6: OSC2 Velocity

On this page you can specify the velocity zones for oscillator 2 itself and for the multisamples.

It is available when the **Oscillator Mode** is set to **Double** or **Double Drums**; if not, the page will be grayed out.

The parameters are identical to those for Oscillator 1, as described under "2-2: OSC1 Velocity" on page 19.

2-7: OSC2 Pitch

This page controls the pitch settings for Oscillator 2. It is available when the **Oscillator Mode** is set to **Double** or **Double Drums**; if not, the page will be grayed out. The parameters are identical to those for Oscillator 1, as described under “2-3: OSC1 Pitch” on page 20.

2-10: Pitch EG AMSSource

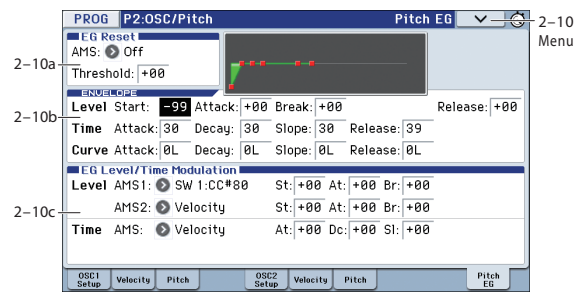

The Pitch EG, or Envelope Generator, lets you create complex, time-varying changes to the pitch of Oscillators 1 and 2. The parameters on this page control the shape of the EG. For instance, you can:

- Create the basic EG shape by setting the levels and times of each segment.
- Control the curvature of each EG segment, for subtle control over the modulation time of the EG.
- Set up complex modulation of EG levels and times.
- Set up an AMS source, such as an LFO, to restart the EG.

To control how much effect the EG has on the pitch, use the Pitch EG parameters on the P2: OSC/Pitch– OSC1 Pitch page and OSC2 Pitch page, as described under “2-3b: Pitch EG” on page 21.

Differences from the other EGs

The Pitch EG is different from the Filter and Amp EGs in several ways:

- The single Pitch EG is shared by both Oscillator 1 and Oscillator 2.
- The Sustain level is always 0.
- The Level modulation has two AMS sources instead of one, and the Time modulation has one AMS source instead of three.

Pitch EG is also an AMS source

You can use the Pitch EG as an AMS source to modulate other parameters, just like the keyboard tracking and LFOs. Simply select the Pitch EG in the AMS list for the desired parameter.

2-10a:EG Reset

AMS (EG Reset AMS) [List of AMS Sources]

This selects an AMS source to reset the EG to the start point. For instance, you can use a tempo-synced LFO to trigger the EG in a repeating rhythm. This reset is in addition to the initial note-on, which always causes the EG to start.

For a list of AMS sources, please see “AMS (Alternate Modulation Source) List” on page 340.

Threshold [–99...+99]

This sets the AMS level which will trigger the EG reset. Among other things, you can use this to adjust the exact point in an LFO’s phase at which the EG will be reset, effectively controlling its “groove” against other rhythmic effects.

When the threshold is **positive**, the EG triggers when passing through the threshold moving upwards. When the threshold is **negative**, the EG triggers when passing through the threshold moving downwards.

Note: For several LFO waveform types, or if the LFO cycle is fast, the LFO output may not always keep up with high values such as +99 or -99.

In this case, setting the **Threshold** to these values may cause inconsistent behavior, or may mean that the EG will not reset at all. If this happens, reduce the **Threshold** until the EG triggers consistently.

2-10b:Envelope

Pitch EG

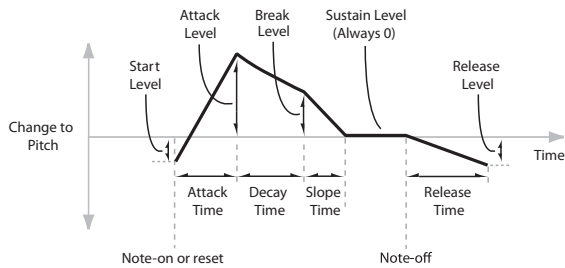

The envelope moves to a specified level over the specified time, and then moves to the next specified level over the specified time. It produces a modulation signal corresponding to this movement.

The parameters below let you set four levels, the amount of time it takes to go from each of the levels to the next, and the shape (from linear to curved) of each transition.

Level

Each of the four levels can be either positive or negative.

Positive levels will make the pitch (or other AMS destination) go up from its programmed value; **negative** levels will make it go down.

Note that, unlike the Filter and Amp EGs, the Pitch EG's Sustain Level is always 0.

Start [-99...+99]

This sets the initial level at note-on.

Attack [-99...+99]

This sets the level at the end of the Attack time.

Break [-99...+99]

Break, short for Break Point, sets the level at the end of the Decay time.

Release [-99...+99]

This sets the level at the end of the Release time.

Time

Higher values mean longer times, as shown below:

| EG Value | Actual Time |
|----------|--------------|
| 10 | 10 ms |
| 20 | 44 ms |
| 30 | 104 ms |
| 40 | 224 ms |
| 50 | 464 ms |
| 60 | 944 ms |
| 70 | 1.8 seconds |
| 80 | 3.8 seconds |
| 90 | 10.9 seconds |
| 99 | 87.3 seconds |

Attack [00...99]

This sets how long the EG takes to move from the Start level to the Attack level.

For the fastest possible attack time, you can set the Start level to +99; in this case, the EG will start instantaneously at its maximum value.

Decay [00...99]

This sets the time it takes to move from the Attack level to the Break level.

Slope [00...99]

This sets how long the EG takes to move from the Break level to the Sustain level (which for the Pitch EG is always 0). Once it reaches the Sustain, the EG will stay there until note-off, unless it is reset via AMS.

Release [00...99]

This sets how long it takes the EG to move from the Sustain level to the Release level.

Note: You can touch and drag to change this value (See “* EG, Velocity Split” on page 6 of the Operation guide.).

Curve

For the sake of simplicity, most of the diagrams in this manual show envelopes as being made out of straight lines. In actuality, though, envelopes are more likely to be made out of curves.

In other words, each segment's level will change quickly at first, and then slow down as it approaches the next point. This tends to sound better than straight, linear segments.

Classic analog synth envelopes made these curved shapes naturally. The KROME goes a step further than vintage synths, however, and lets you control the amount of curvature separately for each of the four envelope segments.

Pitch EG Curve

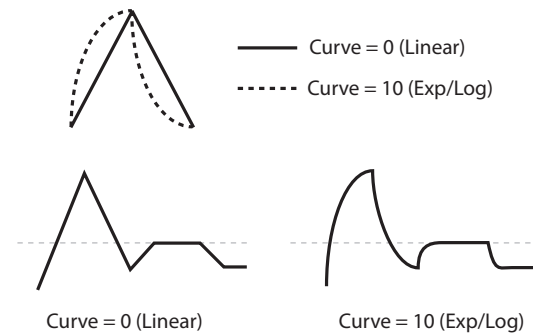

When you change the curvature, the EG times remain the same. However, greater curvature will tend to sound faster, because the value changes more quickly at the beginning.

Different curve settings for up and down

You may find that different amounts of curvature are suitable for segments which go up and segments which go down.

For instance, a curve of 3 is a good default setting for upward segments, such as Attack. On the other hand, a curve of 6 or more is good for downward segments, such as Decay and Release.

Attack [0L (Linear), 1...9, 10E (Exp/Log)]

This sets the curvature of the Attack segment - the transition from the Start level to the Attack level.

Decay [0L (Linear), 1...9, 10E (Exp/Log)]

This sets the curvature of the Decay segment - the transition from the Attack level to the Break level.

Slope [0L (Linear), 1...9, 10E (Exp/Log)]

This sets the curvature of the Slope segment - the transition from the Break level to the Sustain level (which for the Pitch EG is always 0).

Release [0L (Linear), 1...9, 10E (Exp/Log)]

This sets the curvature of the Release segment - the transition from the Sustain level to the Release level.

2-10c:EG Level/Time Modulation

Level

These settings let you use two different AMS sources to control the Level parameters of the EG. For each of the two AMS sources, the Start, Attack, Decay, and Break levels each have their own modulation intensities.

By using different settings for each of the three levels, you can cause both subtle and dramatic changes to the EG shape, as shown below.

Note: Once the EG has started a segment between two points, that segment can no longer be modulated. This includes both the time of the segment, and the level reached at the end of the segment.

For instance, if the EG is in the middle of the Decay time, you can no longer modulate either the Decay time or the Break level.

This also means that modulating the Start level, Attack level, or Attack time will not affect notes that are already sounding, unless the EG is then re-started via EG Reset.

Pitch EG Level Modulation

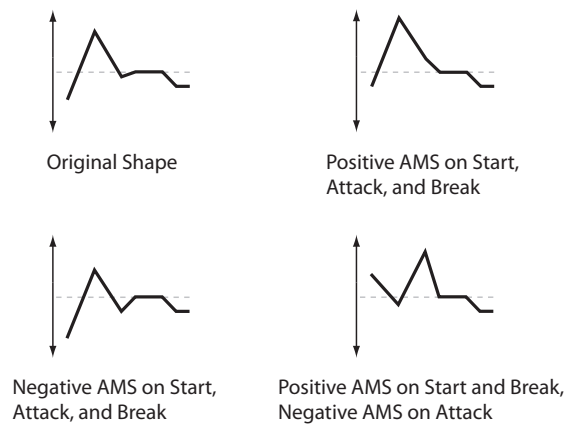

AMS1 [List of AMS Sources]

This selects the first AMS source to control the EG's Level parameters. For a list of AMS sources, please see "AMS (Alternate Modulation Source) List" on page 340.

St (Start) [-99...+99]

This controls the depth and direction of the AMS modulation for the Start level. For example, if you set the AMS1 source to Velocity and set St to +99, the Start level will increase as you play harder. If you instead set St to -99, the Start level will decrease as you play harder.

At (Attack) [-99...+99]

This controls the depth and direction of the AMS modulation for the Attack level.

Br (Break) [-99...+99]

This controls the depth and direction of the AMS modulation for the Break level.

AMS2

This selects the second AMS source for controlling the EG's Level parameters. The Start, Attack, Decay, and Break levels share this source, but each has its own modulation intensity. The parameters of AMS2 are identical to those of AMS1, above.

Time

These settings let you use an AMS source to control the Time parameters of the EG. The Attack, Decay, and Slope times share this AMS source, but each has its own modulation intensity.

Pitch EG Time Modulation

AMS=Velocity, Intensity = a positive (+) value

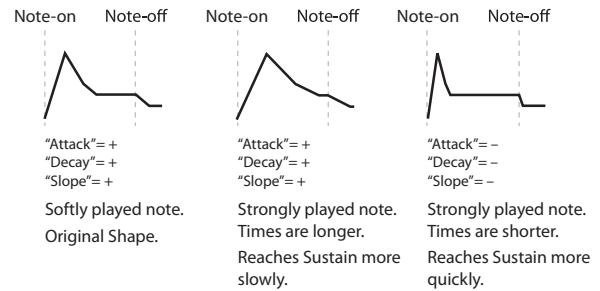

AMS

AMS [List of AMS Sources]

This selects the AMS source to control the EG's Time parameters. Velocity and Keyboard Track can both be useful here, for instance.

For a list of AMS sources, please see "AMS (Alternate Modulation Source) List" on page 340.

At (Attack) [-99...+99]

This controls the depth and direction of the AMS modulation for the Attack time.

For example, if you set the AMS source to Velocity and set Attack to +99, the Attack time will get much longer at higher velocities. If you instead set Attack to -99, the Attack time will get much shorter at higher velocities.

When the AMS source is at its maximum value for instance, when Velocity is at 127 a setting of +8 will make the Attack time almost twice as long, and a setting of -8 will cut the Attack time almost in half.

Dc (Decay) [-99...+99]

This controls the depth and direction of the AMS modulation for the Decay time.

Sl (Slope) [-99...+99]

This controls the depth and direction of the AMS modulation for the Slope time.

✓ **2-10: Menu Command**

- 0: **Write Program** see p. 64
- 1: **Exclusive Solo** see p. 64
- 2: **Auto Song Setup** see p. 65
- 3: **Copy Oscillator** see p. 65
- 4: **Swap Oscillator** see p. 65

For more information, please see "Program: Menu Command" on page 64.

PROG P3: Filter

Filtering can make subtle or dramatic changes to the oscillator's timbre. Each oscillator has two multimode resonant filters, A and B, as well as a dedicated filter envelope and keyboard tracking generator.

These pages let you control all aspects of the filters. Among other things, you can:

- Make basic settings for each oscillator's filters, including routing, modes, cutoff, resonance, etc.
- Set up filter modulation, including keyboard tracking, the filter envelope, LFO modulation, and AMS control.

Note that when the **Oscillator Mode** is set to **Single**, only Oscillator 1's filters are active; the pages for Oscillator 2's filters will be grayed out.

When 24 dB/oct is selected, only the controls for Filter A are active; the controls for Filter B will be grayed out.

Serial and Parallel Routing

Serial

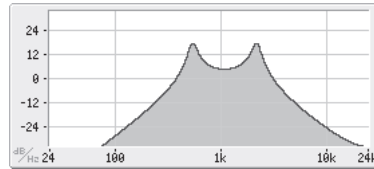
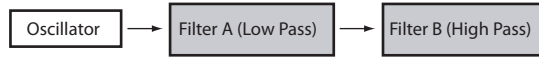

Parallel



Low Pass: 12dB/oct

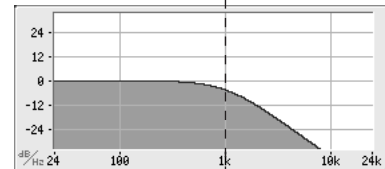

Low Pass: 24dB/oct

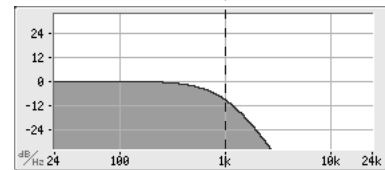

3-1: Filter1

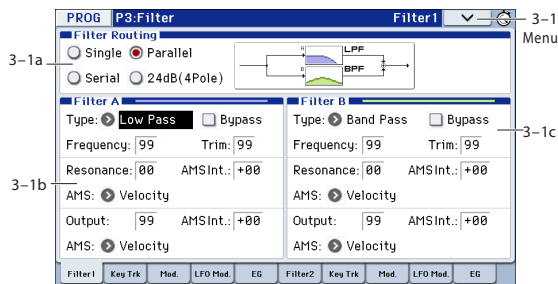

This page contains all of the basic settings for Oscillator 1's Filter A and Filter B. For example, you can:

- Set up the filters to produce a single 12 dB/oct filter, dual 12 dB/oct filters in either serial or parallel routing, or a single 24 dB/oct filter.
- Set each of the two filters to Low Pass, High Pass, Band Pass, or Band Reject modes.
- Set the cutoff, resonance, and input and output levels of each filter, including modulation of resonance and output level.

3-1a: Filter Routing

Filter Routing

[Single, Serial, Parallel, 24dB(4Pole)]

Each oscillator has two filters, Filter A and Filter B. This parameter controls whether one or both of the filters are used, and if both are used, it controls how they are connected to each other.

Single. This uses only Filter A as a single 2-pole, 12 dB/octave filter (6 dB for Band Pass and Band Reject). When this option is selected, the controls for Filter B will be grayed out.

Serial. This uses both Filter A and Filter B. The oscillator first goes through Filter A, and then the output of Filter A is processed through Filter B.

Parallel. This also uses both Filter A and Filter B. The oscillator feeds both filters directly, and the outputs of the two filters are then summed together.

24dB/oct. This merges both filters to create a single 4-pole, 24 dB/octave filter (12 dB for Band Pass and Band Reject). In comparison to Single, this option produces a sharper roll-off beyond the cutoff frequency, as well as a slightly more delicate resonance. Many classic analog synths used this general type of filter.

3-1b: Filter A

Filter Type

[Low Pass (12dB/oct), High Pass (12dB/oct), Band Pass (6dB/oct), Band Reject (6dB/oct)]

The filter will produce very different results depending on the selected filter type. The selections will change slightly according to the selected **Filter Routing**, to show the correct cutoff slope in dB per octave.

Low Pass (12dB/oct). This cuts out the parts of the sound which are **higher** than the cutoff frequency. Low Pass is the most common type of filter, and is used to make bright timbres sound darker.

High Pass (12dB/oct). This cuts out the parts of the sound which are **lower** than the cutoff frequency. You can use this to make timbres sound thinner or more buzzy.

Band Pass (6dB/oct). This cuts out all parts of the sound, both highs and lows, except for the region around the cutoff frequency. Since this filter cuts out both high and low frequencies, its effect can change dramatically depending on the cutoff setting and the oscillator's multisample.

With low resonance settings, you can use the Band Pass filter to create telephone or vintage phonograph sounds. With higher resonance settings, it can create buzzy or nasal timbres.

Band Reject (6dB/oct). This filter type also called a notch filter—cuts only the parts of the sound directly around the cutoff frequency. Try modulating the cutoff with an LFO to create phaser-like effects.

Filter Types and Cutoff Frequency

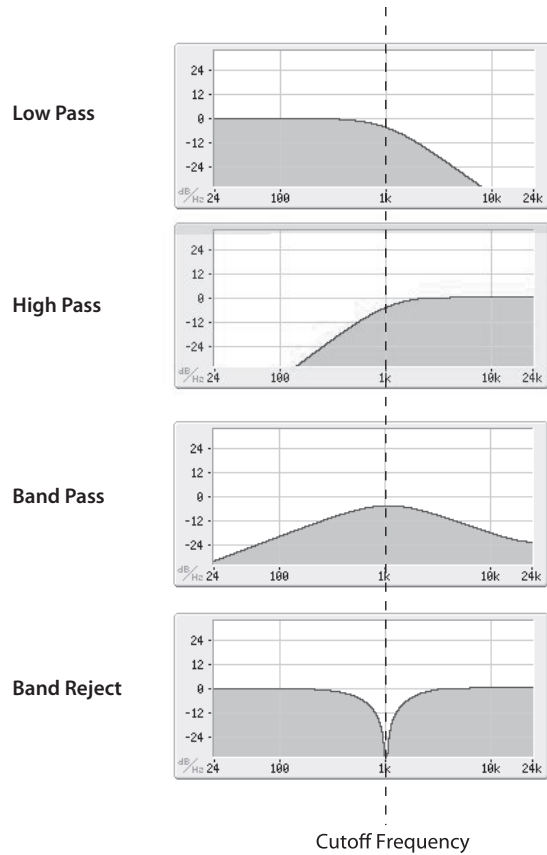

Bypass [Off, On]

This lets you bypass Filter A completely. If **Bypass** is **Off**, Filter A functions normally. When **Bypass** is **On**, Filter A will have no effect.

Frequency [00...99]

This controls the cutoff frequency of Filter A, in increments of 1/10 of an octave. The specific effect of the cutoff frequency will change depending on the selected **Filter Type**.

Trim [00...99]

This adjusts the volume level at the input to the filter. If you notice that the sound is distorting, especially with high **Resonance** settings, you can turn the level down here, or at the **Output**.

Resonance [00...99]

Resonance emphasizes the frequencies around the cutoff frequency. When this is set to 0, there is no emphasis, and frequencies beyond the cutoff will simply diminish smoothly. At medium settings, the resonance will alter the timbre of the filter, making it sound more nasal, or more extreme. At very high settings, the resonance can be heard as a separate, whistling pitch. To make the resonance track the keyboard pitch, please see "Key Follow" on page 29.

Resonance

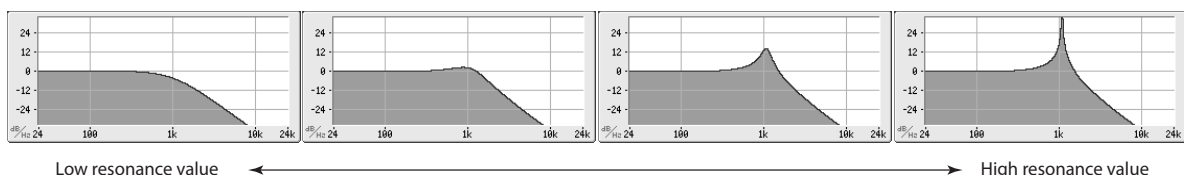

AMS (Resonance) [List of AMS Sources]

This selects a AMS source to control the Resonance amount. For a list of AMS sources, please see "AMS (Alternate Modulation Source) List" on page 340.

AMS Int. [-99...+99]

This controls the depth and direction of the Resonance modulation.

For example, if Velocity has been selected, changes in keyboard velocity will affect the resonance. With positive (+) values, the resonance will increase as you play more strongly, and as you play more softly the resonance will approach the level specified by the **Resonance** setting. With negative (-) values, the resonance will decrease as you play more strongly, and as you play more softly the resonance will approach the level specified by the **Resonance** setting.

The resonance level is determined by adding the **Resonance** and **AMS Int.** values.

Output [00...99]

This controls the output level of Filter A. You can use this to balance the volumes of Filters A and B when the **Routing** is set to Parallel, or to turn down the volume to avoid clipping later in the signal chain.

AMS (Output AMS) [List of AMS Sources]

This selects a modulation source to control the output level of Filter A. For a list of AMS sources, please see "AMS (Alternate Modulation Source) List" on page 340.

AMS Int. [-99...+99]

This controls the depth and direction of the output level modulation.

3-1c: Filter B

Filter B is available when the **Filter Routing** is set to **Serial** or **Parallel**. Otherwise, the parameters in this section will be grayed out.

The parameters for Filter B are identical to those for Filter A. For more information, please see the descriptions under Filter A, above.

3-1: Menu Command

- 0: **Write Program** see p. 64
- 1: **Exclusive Solo** see p. 64
- 2: **Auto Song Setup** see p. 65
- 3: **Copy Oscillator** see p. 65
- 4: **Swap Oscillator** see p. 65

For more information, please see "Program: Menu Command" on page 64.

3-2: Filter1 Keyboard Track

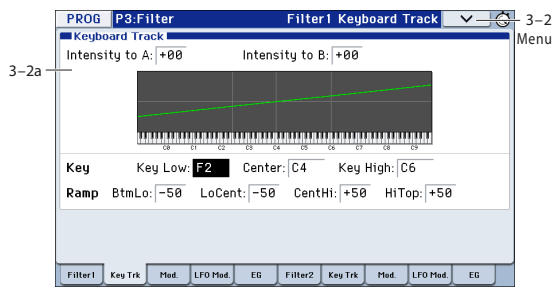

This page contains the settings for Oscillator 1's filter keyboard track. Among other things, you can:

- Set up complex keyboard tracking shapes, and control how the tracking affects filter cutoff.

Filter B is available when the **Filter Routing** is set to **Serial** or **Parallel**. Otherwise, the parameters for Filter B will be grayed out.

3-2a: Keyboard Track

Most acoustic instruments get brighter as you play higher pitches. At its most basic, keyboard tracking re-creates this effect by raising the lowpass filter cutoff frequency as you play higher on the keyboard. Usually, some amount of key tracking is necessary in order to make the timbre consistent across the entire range.

The KROME keyboard tracking can also be much more complex, since it allows you to create different rates of change over up to four different parts of the keyboard. For instance, you can:

- Make the filter cutoff increase very quickly over the middle of the keyboard, and then open more slowly or not at all in the higher octaves.
- Make the cutoff increase as you play lower on the keyboard.
- Create abrupt changes at certain keys, for split-like effects.

How it works: Keys and Ramps

The keyboard tracking works by creating four ramps, or slopes, between five keys on the keyboard. The bottom and top keys are fixed at the bottom and top of the MIDI range, respectively. You can set the other three keys named **Key Low**, **Center**, and **Key High** to be anywhere in between.

The four Ramp values control the rate of change between each pair of keys. For instance, if the **Lo Cent (Low-Center)** Ramp is set to 0, the value will stay the same between the **Key Low** key and the **Center** key.

The Key value will be the break point, and the slope of the lower and higher regions on the keyboard is specified by the Ramp.

At the **Center** key (the main hinge), the keyboard tracking has no effect.

Intensity to A [-99...+99]

This controls how much the keyboard tracking will affect Filter A's cutoff frequency. The overall effect of the Keyboard Track is a combination of this Intensity value and the overall Keyboard Track shape.

With **positive values (+)**, the effect will be in the direction specified by keyboard tracking; if the ramp goes up, the filter cutoff will **increase**.

With **negative values (-)**, the effect will be in the opposite direction; if the ramp goes up, the filter cutoff will decrease.

Keyboard Track Shape and Intensity

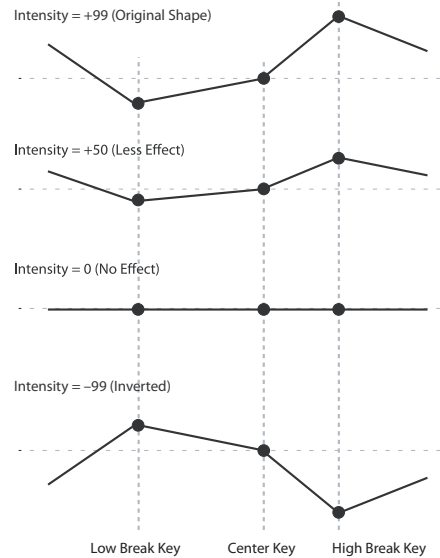

Intensity to B [-99...+99]

This controls how much the keyboard tracking will affect Filter B's cutoff frequency.

Key

Key Low [C-1...G9]

This specifies the note at which the two sloped lines in the lower range will be connected.

Center [C-1...G9]

This specifies the note that will be the break point for the center of keyboard tracking. At this key, the keyboard tracking has no effect on the filter cutoff, or on any AMS destinations.

Key High [C-1...G9]

This specifies the note at which the two sloped lines in the upper range will be connected.

Note: You can also set the note value and velocity value by holding down the edit cell or the ENTER button and playing a note on the keyboard (see OG p.10).

Ramp

Positive ramp values mean that the keyboard tracking output increases as you play farther from the **Center Key**; negative ramp values mean that it decreases.

Because of this, the meanings of positive and negative ramp settings will change depending on whether the ramp is to the left or right of the **Center Key**.

Btm Lo (Bottom-Low) and Lo Cent (Low-Center): negative ramps make the keyboard tracking's output go down as you play lower on the keyboard, and positive ramps make the output go higher.

Cent Hi (Center-High) and Hi Top (High-Top): negative ramps make the keyboard tracking's output go down as you play higher on the keyboard, and positive ramps make the output go up.

The effect on the filter cutoff is a combination of the ramp values, as set below, and the **Intensity to A (B)** parameters. When **Intensity to A (B)** is set to +99, a ramp of 50 changes the filter frequency by 1 octave for every octave of the keyboard, and a ramp of +99 changes the frequency by 2 octaves for every octave of the keyboard.

Btm Lo (Bottom-Low) [-Inf, -99...+99, +Inf]

This sets the slope between the bottom of the MIDI note range and the **Key Low** key. For normal key track, use negative values.

Lo Cent (Low-Center) [-Inf, -99...+99, +Inf]

This sets the slope between the **Key Low** and **Center** keys. For normal key track, use negative values.

Cent Hi (Center-High) [-Inf, -99...+99, +Inf]

This sets the slope between the **Center** and **Key High** keys. For normal key track, use positive values.

Hi Top (High-Top) [-Inf, -99...+99, +Inf]

This sets the slope between the **Key High** key and the top of the MIDI note range. For normal key track, use positive values.

+Inf and -Inf ramps

+Inf and -Inf are special settings which create abrupt changes for split-like effects. When a ramp is set to +Inf or -Inf, the keyboard tracking will go to its extreme highest or lowest value over the span of a single key.

+Inf and -Inf Ramps

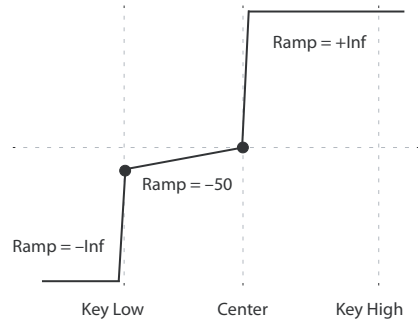

Note: if you set the **Cent Hi** ramp to +Inf or -Inf, the **Hi Top** parameter will be grayed out. Similarly, if you set the **Lo Cent** ramp to +Inf or -Inf, the **Btm Lo** ramp will be grayed out.

Key Follow

To create the classic Key Follow effect, in which the filter frequency tracks the pitch of the keyboard:

1. Set the **Filter Frequency** to 30.
2. Set the **Keyboard Track Intensity** to +99.
3. Set the **Btm Lo** and **Lo Cent** ramps to -50.
4. Set the **Cent Hi** and **Hi Top** ramps to +50.
5. Set the **Center Key** to C4.

The settings for the **Key Low** and **Key High** keys don't matter in this case.

Filter Keyboard Track is also an AMS source

You can use the filter keyboard tracking as an AMS source to modulate other parameters, just like the envelopes and LFOs. Simply select **Filter KTrk** in the AMS list for the desired parameter.

✓ **3-2: Menu Command**

- 0: **Write Program** see p. 64
- 1: **Exclusive Solo** see p. 64
- 2: **Auto Song Setup** see p. 65
- 3: **Copy Oscillator** see p. 65
- 4: **Swap Oscillator** see p. 65

For more information, please see "Program: Menu Command" on page 64.

3-3: Filter1 Modulation

This page contains the settings for Oscillator 1's filter modulation. Among other things, you can:

- Control the effect of the **Filter Envelope** on filter cutoff.
- Assign **AMS** modulation for filter cutoff.

Filter B is available when the **Filter Routing** is set to **Serial** or **Parallel**. Otherwise, the parameters for Filter B will be grayed out.

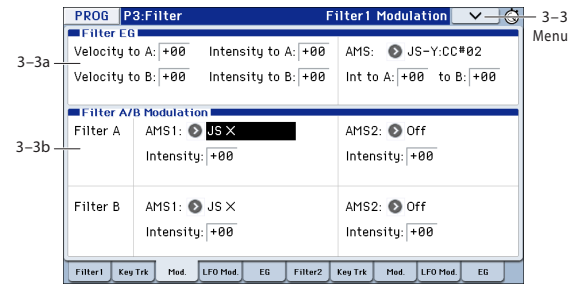

3-3a: Filter EG

The Filter EG modulates the Filter A and B cutoff frequencies over time. You can control how strongly the EG will affect the filters in three different ways:

- Set an initial amount of EG modulation, using the **Intensity to A** and **B** parameters.
- Use velocity to scale the amount of the EG applied to the filter.
- Use any AMS source to scale the amount of the EG applied to the filter.

You can use all three of these at once, and the results are added together to produce the total EG effect.

To set up the EG itself, including attack and release times, levels, and so on, please see "3-5: Filter1 EG" on page 31.

Velocity to A [-99...+99]

This lets you use velocity to scale the amount of the Filter EG applied to Filter A.

Velocity control of Filter EG

In all examples below, Intensity to A = +50

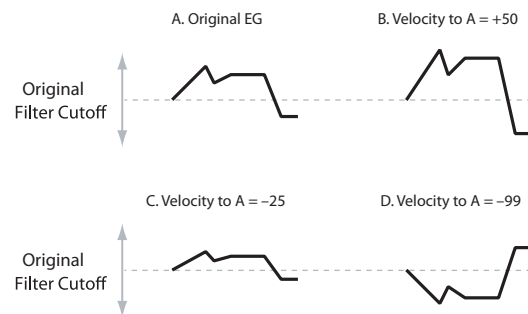

With **positive (+) values**, playing more strongly will increase the effect of the Filter EG, as shown in example **B** above.

With **negative (-) values**, playing more strongly will introduce the opposite effect of the Filter EG—like inverting the polarity of the envelope. You can use this in several different ways:

- You can set an initial positive amount with the Intensity to A/B parameters, and then reduce this amount with velocity. In this case, the final effect of the EG is simply diminished, and not actually inverted, as shown in example C above.
- You can also set the Velocity to A/B amounts so that they are greater than the initial amounts of Intensity to A/B. In this case, the EG will have a positive effect at low velocities, and an inverted effect at high velocities as shown in example D.

Velocity to B [–99...+99]

This lets you use velocity to scale the amount of the Filter EG applied to Filter B. For more information, please see “Velocity to A” above.

Intensity to A [–99...+99]

This controls the initial effect of the Filter EG on Filter A’s cutoff frequency, before any velocity or AMS modulation.

The Filter EG’s shape can swing all the way from +99 to –99. Positive values increase the cutoff frequency, and negative values decrease the cutoff frequency. For instance, please see the graphic “Velocity control of Filter EG” above. The EG shape in example A rises up at first, and then falls below 0 towards the end.

When **Intensity to A** is set to a **positive (+)** value, the EG’s effect will match its shape. When the EG rises above 0, the cutoff frequency will increase.

With **negative (–)** values, the effect will be in the opposite direction; when the EG rises above 0, the filter cutoff will decrease.

Intensity to B [–99...+99]

This controls the initial effect of the Filter EG on Filter B’s cutoff frequency, before any velocity or AMS modulation. For more information, please see “Intensity to A” above.

AMS (Filter EG AMS) [List of AMS Sources]

This selects any AMS modulation source to scale the amount of the Filter EG applied to Filters A and B. The two filters share a single AMS source, with separate intensity settings. Otherwise, the AMS modulation will work in the same way as the **Velocity to A** parameter, described above.

For a list of AMS sources, please see “AMS (Alternate Modulation Source) List” on page 340.

Int to A (AMS Intensity to A) [–99...+99]

This controls the depth and direction of the EG AMS modulation for Filter A.

Int to B (AMS Intensity to B) [–99...+99]

This controls the depth and direction of the EG AMS modulation for Filter B.

3–3b: Filter A/B Modulation

This section lets you assign any two AMS sources to control Filter A, and another two AMS sources to control Filter B. This modulation is added to the basic Filter A and B cutoff frequencies, as set on the Filter 1 page.

Filter A

AMS1 (Filter A AMS1) [List of AMS Sources]

This selects the first modulation source for controlling Filter A’s cutoff frequency. For a list of AMS sources, please see “AMS (Alternate Modulation Source) List” on page 340.

Intensity (AMS1 Intensity) [–99...+99]

This controls the depth and direction of AMS1.

AMS2 (Filter A AMS2) [List of AMS Sources]

This selects the second modulation source for controlling Filter A’s cutoff frequency. For a list of AMS sources, please see “AMS (Alternate Modulation Source) List” on page 340.

Intensity (AMS2 Intensity) [–99...+99]

This controls the depth and direction of AMS2.

Filter B

The parameters for Filter B are identical to those for Filter A. For more information, please see the descriptions under Filter A, above.

✓ **3–3: Menu Command**

- 0: **Write Program** see p. 64
- 1: **Exclusive Solo** see p. 64
- 2: **Auto Song Setup** see p. 65
- 3: **Copy Oscillator** see p. 65
- 4: **Swap Oscillator** see p. 65

For more information, please see “Program: Menu Command” on page 64.

3–4: Filter1 LFO Mod.

LFO1, LFO2, and the Common LFO can all modulate Filter A and B’s cutoff frequencies. You can control the strength of each LFO’s modulation independently for each filter, in three different ways:

- Set an initial amount of LFO modulation, using the **Intensity to A** and **B** parameters.
- Use JS-Y to scale the amount of the LFO.
- Use any AMS source to scale the amount the LFO.

You can use each of these methods for each of the three LFOs, and do so separately for both Filter A and Filter B. The results are added together to produce the total LFO effect.

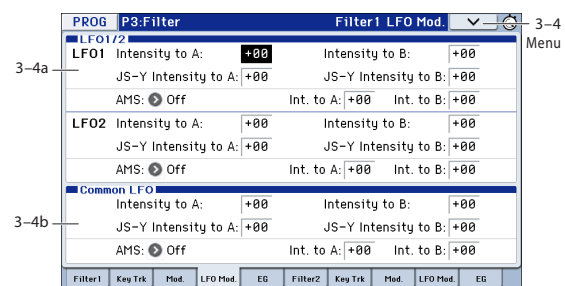

3–4a: LFO 1/2

LFO1

Intensity to A [–99...+99]

This controls the initial effect of the LFO on Filter A’s cutoff frequency, before any JS-Y or AMS modulation.

Negative (–) settings will invert the phase of the LFO. You can produce interesting effects by using the same LFO to modulate two different parameters (such as Filter A and Filter B), but with one set to a positive intensity, and the other set to a negative intensity.

LFO modulation of Filter Cutoff

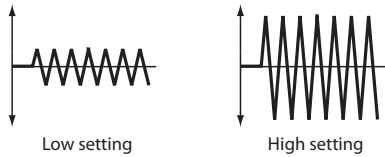

Intensity to B [-99...+99]

This controls the initial effect of the LFO on Filter B's cutoff frequency, before any JS-Y or AMS modulation.

JS-Y Intensity to A [-99...+99]

This adjusts the depth by which the LFO will modulate the cutoff frequency of filter A when you move the joystick from the center in the -Y direction (toward yourself) (or when CC#2 is received). (Joystick control in the -Y direction is called "JS -Y".)

Negative (-) settings will invert the phase of the LFO. You can also use this to reduce the initial amount of the LFO, as set by **Intensity to A**, above. For example:

1. Set Intensity to A to +50.

The LFO will now have a fairly strong effect on the filter cutoff.

2. Set JS-Y Intensity to A to -50.

Now, if you move the joystick down, the effect of the LFO will fade away. When the joystick is all the way at the bottom of its range, the LFO will be completely cancelled out.

JS-Y Intensity to B (LFO1) [-99...+99]

This lets you use JS-Y to scale the amount of the LFO applied to Filter B.

AMS (LFO1) [List of AMS Sources]

This selects any AMS modulation source to scale the amount of the LFO applied to Filters A and B. The two filters share a single AMS source, but with separate intensity settings.

For a list of AMS sources, please see "AMS (Alternate Modulation Source) List" on page 340.

Intensity to A (LFO1) [-99...+99]

This controls the depth and direction of the LFO1 AMS modulation for Filter A.

For example, if **AMS** is set to **JS+Y: CC#01**, **positive** settings mean that **YS+Y** will increase the amount of LFO1 applied to Filter A.

Intensity to B (LFO1) [-99...+99]

This controls the depth and direction of the LFO1 AMS modulation for Filter B.

LFO 2

The parameters for LFO2 are identical to those for LFO1. For more information, please see the descriptions under LFO1, above.

3-4b: Common LFO

The parameters for the Common LFO are identical to those for LFO1. For more information, please see the descriptions under LFO1, above.

Note that while LFO1 and LFO2 are separate for each voice, the Common LFO is shared by all voices in the Program. This makes it useful when you want all of the voices to have an identical LFO effect.

✓ **3-4: Menu Command**

- 0: **Write Program** see p. 64
- 1: **Exclusive Solo** see p. 64
- 2: **Auto Song Setup** see p. 65
- 3: **Copy Oscillator** see p. 65
- 4: **Swap Oscillator** see p. 65

For more information, please see "Program: Menu Command" on page 64.

3-5: Filter1 EG

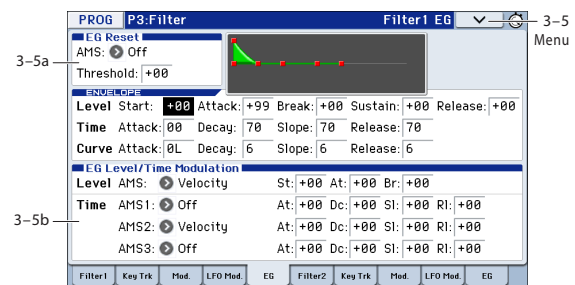

The Filter EG, or Envelope Generator, lets you create complex, time-varying changes to the cutoff frequencies of Filters A and B. The parameters on this page control the shape of the EG. Among other things, you can:

- Create the basic EG shape by setting the levels and times of each segment.
- Control the curvature of each EG segment, for subtle control over the modulation shape of the EG.
- Set up complex modulation of EG levels and times.
- Set up an AMS source, such as an LFO, to restart the EG.

To control how much effect the EG has on the filters, use the Filter EG parameters on the P3: Filter- Modulation page, as described under "3-3a: Filter EG" on page 29.

Filter EG is also an AMS source

You can use the Filter EG as an AMS source to modulate other parameters, just like the keyboard tracking and LFOs. Simply select the Filter EG in the AMS list for the desired parameter.

3-5a: EG Reset

AMS [List of AMS Sources]

This selects an AMS source to reset the EG to the start point. For instance, you can use a tempo-synced LFO to trigger the EG in a repeating rhythm. This reset is in addition to the initial note-on, which always causes the EG to start.

For a list of AMS sources, please see "AMS (Alternate Modulation Source) List" on page 340.

Threshold [-99...+99]

This sets the AMS level which will trigger the EG reset. Among other things, you can use this to adjust the exact point in an LFO's phase at which the EG will be reset, effectively controlling its "groove" against other rhythmic effects.

When the threshold is **positive**, the EG triggers when passing through the threshold moving upwards. When the threshold is **negative**, the EG triggers when passing through the threshold moving downwards.

Note: With some LFO shapes, and with faster LFO speeds, the LFO may not always reach the extreme values of +99 or -

99. In this case, setting the **Threshold** to these values may cause inconsistent behavior, or may mean that the EG doesn't reset at all. If this happens, reduce the **Threshold** until the EG triggers consistently.

3-5b: Envelope

Filter EG

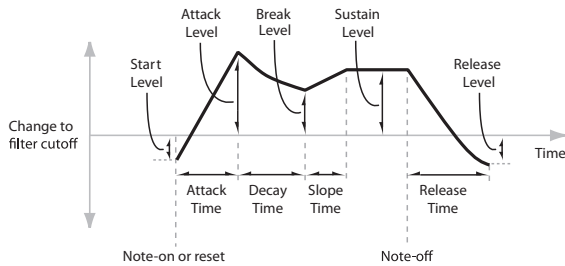

An envelope creates a modulation signal by moving from one level to another over a specified time, and then moving to another level over another period of time, and so on.

The parameters below let you set five levels, the amount of time it takes to go from each of the levels to the next, and the shape (from linear to curved) of each transition.

Level

Each of the five levels can be either positive or negative.

Positive levels will make the cutoff frequency (or other AMS destination) go up from its programmed value; **negative** levels will make it go down.

Start [-99...+99]

This sets the initial EG level at note-on.

Attack [-99...+99]

This sets the level at the end of the Attack time.

Break [-99...+99]

Break, short for Break Point, sets the level at the end of the Decay time.

Sus (Sustain) [-99...+99]

This sets the level at the end of the Slope time. Once it reaches the Sustain level, the EG will stay there until note-off, unless it is reset via AMS.

Release [-99...+99]

This sets the level at the end of the Release time.

Time

Higher values mean longer times, as shown below:

| EG Value | Actual Time |
|----------|--------------|
| 10 | 10 ms |
| 20 | 44 ms |
| 30 | 104 ms |
| 40 | 224 ms |
| 50 | 464 ms |
| 60 | 944 ms |
| 70 | 1.8 seconds |
| 80 | 3.8 seconds |
| 90 | 10.9 seconds |
| 99 | 87.3 seconds |

Attack [00...99]

This sets how long the EG takes to move from the Start level to the Attack level.

For the fastest possible attack time, you can set the Start level to +99; in this case, the EG will start instantaneously at its maximum value.

Decay [00...99]

This sets the time it takes to move from the Attack level to the Break level.

Slope [00...99]

This sets how long the EG takes to move from the Break level to the Sustain level. Once it reaches the Sustain level, the EG will stay there until note-off (unless it is reset via AMS).

Release [00...99]

This sets how long it takes the EG to move from the Sustain level to the Release level.

Note: You can touch and drag to change this value (See “* EG, Velocity Split” on page 6 of the Operation guide.).

Curve

For the sake of simplicity, most of the diagrams in this manual show envelopes as being made out of straight lines. In actuality, though, envelopes are more likely to be made out of curves.

In other words, each segment's level will change quickly at first, and then slow down as it approaches the next point. This tends to sound better than straight, linear segments.

Classic analog synth envelopes made these curved shapes naturally. The KROME goes a step further than vintage synths, however, and lets you control the amount of curvature separately for each of the four envelope segments.

Filter EG Curve

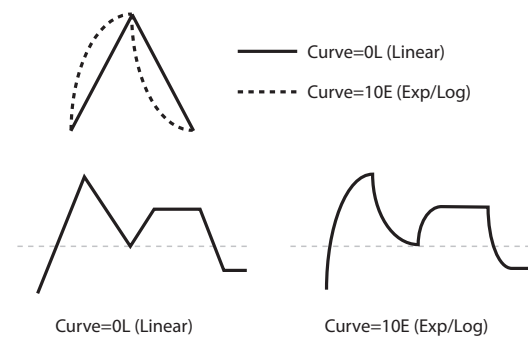

When you change the curvature, the EG times remain the same. However, greater curvature will tend to sound faster, because the value changes more quickly at the beginning.

Different curve settings for up and down

You may find that different amounts of curvature are suitable for segments which go up and segments which go down.

For instance, a curve of 3 is a good default setting for upward segments, such as Attack. On the other hand, a curve of 6 or more is good for downward segments, such as Decay and Release.

Attack [0L (Linear), 1...9, 10E (Exp/Log)]

This sets the curvature of the Attack segment - the transition from the Start level to the Attack level.

Decay [0L (Linear), 1...9, 10E (Exp/Log)]

This sets the curvature of the Decay segment - the transition from the Attack level to the Break level.

Slope [0L (Linear), 1...9, 10E (Exp/Log)]

This sets the curvature of the Slope segment - the transition from the Break level to the Sustain level.

Release [0L (Linear), 1...9, 10E (Exp/Log)]

This sets the curvature of the Release segment - the transition from the Sustain level to the Release level.

3-5c: EG Level/Time Modulation

Level

These settings let you use any AMS source to control the Level parameters of the EG. The Start, Attack, and Break levels share a single AMS source, but can each have different modulation intensities.

By using different settings for each of the three levels, you can cause both subtle and dramatic changes to the EG shape, as shown below.

Once an EG segment begins, it can't be modulated

Once the EG has started a segment between two points, that segment can no longer be modulated. This includes both the time of the segment, and the level reached at the end of the segment.

For instance, if the EG is in the middle of the Decay time, you can no longer modulate either the Decay time or the Break level.

As another example, let's say that you've assigned the Common LFO to modulate Break Level. The LFO may be moving all the time, but the Break Level is only affected by the LFO's value at the instant that the Decay segment starts. After that, the level is fixed.

Finally, this also means that modulating the Start level, Attack level, or Attack time will not affect notes that are already sounding, unless the EG is then reset via AMS.

Filter EG Level Modulation

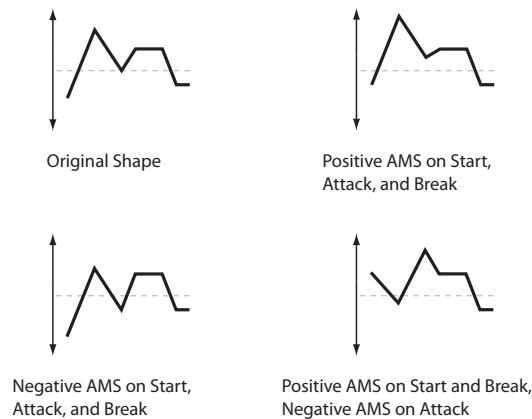

AMS [List of AMS Sources]

Selects an AMS source to control the EG's Level parameters.

For a list of AMS sources, please see "AMS (Alternate Modulation Source) List" on page 340.

St (Start) [-99...+99]

This controls the depth and direction of the AMS modulation for the Start level.

For example, if you set the AMS source to Velocity and set St (Start) to +99, the Start level will increase as you play harder. If you instead set St (Start) to -99, the Start level will decrease as you play harder.

At (Attack) [-99...+99]

This controls the depth and direction of the AMS modulation for the Attack level.

Br (Break) [-99...+99]

This controls the depth and direction of the AMS modulation for the Break level.

Time

These settings let you use three different AMS sources to control the Time parameters of the EG. For each of the three AMS sources, the Attack, Decay, Slope, and Release times each have their own modulation intensities.

Filter EG Time Modulation

AMS=Velocity, Intensity = a positive (+) value

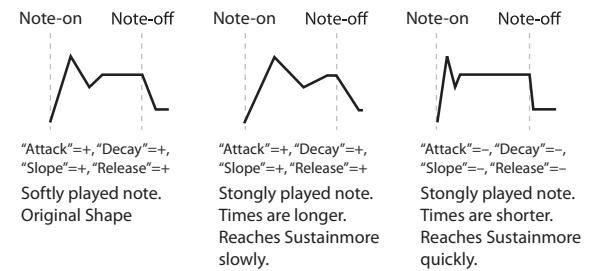

AMS1 [List of AMS Sources]

Selects the first AMS source to control the EG's Time parameters. Velocity and Keyboard Track can both be useful here, for instance.

For a list of AMS sources, please see "AMS (Alternate Modulation Source) List" on page 340.

At (Attack) [-99...+99]

This controls the depth and direction of the AMS modulation for the Attack time.

For example, if you set the AMS source to Velocity and set At (Attack) to +99, the Attack time will get much longer at higher velocities. If you instead set At (Attack) to -99, the Attack time will get much shorter at higher velocities.

When the AMS source is at its maximum value for instance, when Velocity is at 127 a setting of +8 will make the Attack time almost twice as long, and a setting of -8 will cut the Attack time almost in half. (See page 342)

Dc (Decay) [-99...+99]

This controls the depth and direction of the AMS modulation for the Decay time.

Sl (Slope) [-99...+99]

This controls the depth and direction of the AMS modulation for the Slope time.

RI (Release) [-99...+99]

This controls the depth and direction of the AMS modulation for the Release time.

AMS2 and AMS3

These select the second and third AMS sources, respectively, for controlling the EG's Time parameters. Each has its own intensities for Attack, Decay, Slope, and Release. The parameters of both AMS2 and AMS3 are identical to those of AMS1, above.

∨ 3–5: Menu Command

- 0: **Write Program** see p. 64
- 1: **Exclusive Solo** see p. 64
- 2: **Auto Song Setup** see p. 65
- 3: **Copy Oscillator** see p. 65
- 4: **Swap Oscillator** see p. 65
- 5: **Sync Both EGs** see p. 66

For more information, please see “Program: Menu Command” on page 64.

3–6: Filter2

This page controls Oscillator 2’s basic filter 2 settings. It is available only when the **Oscillator Mode** is set to **Double** or **Double Drums**; if not, the page will be grayed out.

The parameters are identical to those for Oscillator 1, as described under “3–1: Filter1” on page 26.

3–7: Filter2 Keyboard Track

This page contains the settings for Oscillator 2’s keyboard track. Among other things, you can:

- Set up complex keyboard tracking shapes, and control how the tracking affects filter cutoff.
- Control the effect of the Filter Envelope on filter cutoff.
- Assign AMS modulation for filter cutoff.

Filter B is available when the **Filter Routing** is set to **Serial** or **Parallel**. Otherwise, the parameters for Filter B will be grayed out.

3–8: Filter2 Modulation

This page controls Oscillator 2’s filter modulation. It is available when the **Oscillator Mode** is set to **Double** or **Double Drums**; if not, the page will be grayed out.

The parameters are identical to those for Oscillator 1, as described under “3–3: Filter1 Modulation” on page 29.

3–9: Filter2 LFO Mod.

This page controls Oscillator 2’s LFO filter modulation. It is available when the **Oscillator Mode** is set to **Double** or **Double Drums**; if not, the page will be grayed out.

The parameters are identical to those for Oscillator 1, as described under “3–4: Filter1 LFO Mod.” on page 30.

3–10: Filter2 EG

This page controls Oscillator 2’s Filter EG. It is available when the **Oscillator Mode** is set to **Double** or **Double Drums**; if not, the page will be grayed out.

The parameters are identical to those for Oscillator 1, as described under “3–5: Filter1 EG” on page 31.

PROG P4: Amp/EQ

Oscillators 1 and 2 have separate controls for volume (also called “amplitude,” or “amp” for short); pan; and Drive; as well as dedicated amp envelopes and keyboard tracking generators. Additionally, both Oscillators share a three-band EQ.

These pages let you control all of these related parameters. Among other things, you can:

- Set up the Driver circuit, which adds saturation and bass boost to the timbre.
- Set the pan position and pan modulation.
- Control amp level and modulation, including keyboard tracking, the amp envelope, LFO modulation, and AMS control.
- Set up the three-band Track EQ.

Note that when the **Oscillator Mode** is set to **Single**, only Oscillator 1’s amp, pan, and drive parameters are active; the pages for Oscillator 2 will be grayed out.

4-1: Amp1/Driver1

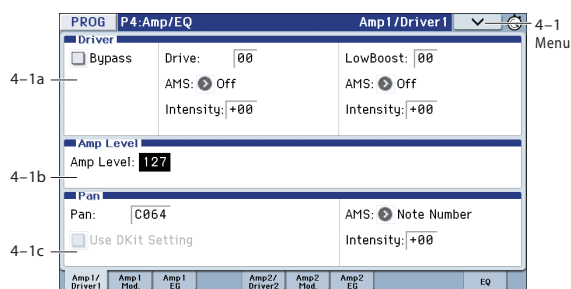

This page controls the basic settings for the Amp/EQ section. Here, you can:

- Set up the Driver circuit.
- Set the initial volume level.
- Control the pan position and pan modulation.

4-1a: Driver

The Driver adds saturation and overdrive to the sound, for everything from subtle fattening to drastic distortion. Unlike an overdrive effect, the Driver processes each voice individually, so the timbre stays the same regardless of how many voices are being played.

The two main parameters, **Drive** and **Low Boost**, work together to create the overall Driver effect. **Drive** contributes edge and bite, and **Low Boost** provides the body as well as boosting the bass.

Bypass [Off, On]

On (checked): the Driver is completely removed from the signal path.

Drive [00...99]

This controls the amount of edge and bite in the timbre. Low settings will produce mild saturation, and higher settings create more obvious distortion.

Often, it’s useful to increase the **Low Boost** along with the **Drive**.

Note: Even when the **Drive** amount is set to 0, the Driver circuit still affects the timbre. If your goal is a completely pristine sound, use the Bypass control instead.

AMS (Drive) [List of AMS Sources]

This selects an AMS modulation source to control the **Drive** amount.

For a list of AMS sources, please see “AMS (Alternate Modulation Source) List” on page 340.

Intensity [-99...+99]

This controls the depth and direction of the AMS modulation for Drive.

Low Boost [00...99]

This low-frequency EQ controls the body character of the sound. The specific EQ frequencies affected will change with the **Drive** setting.

Higher amounts increase the bass boost, and will also intensify the effect of the **Drive** parameter.

AMS [List of AMS Sources]

This selects an AMS modulation source to control the **Low Boost** amount.

For a list of AMS sources, please see “AMS (Alternate Modulation Source) List” on page 340.

Intensity [-99...+99]

This controls the depth and direction of the AMS modulation for **Low Boost**.

4-1b: Amp Level

Amp Level [000...127]

This controls the basic volume level of Oscillator 1, before keyboard tracking, velocity, and other modulation.

Mixer, DrumTrack and volume

You can control the Oscillator volume directly from the sliders in the 0-3 Mixer & Drum Track page. This is a separate parameter, in addition to **Amp Level**.

MIDI and volume

MIDI You can control the Program’s overall volume via MIDI using both Volume (CC#7) and Expression (CC#11). When used one at a time, the two controllers work in exactly the same way: a MIDI value of 127 is equal to the **Amp Level** setting, and lower values reduce the volume.

If both CC#7 and CC#11 are used simultaneously, the one with the lower value determines the maximum volume, and the one with the higher value scales down from that maximum.

This is controlled on the global MIDI channel (Global 1-1a).

4-1c: Pan

Pan [Random, L001...C064...R127]

This controls the stereo pan of Oscillator 1. A setting of L001 places the sound at the far left, C064 in the center, and R127 to the far right.

When this is set to **Random**, the pan position will be different for each note-on.

MIDI You can also control pan via MIDI Pan (CC#10). A CC#10 value of 0 or 1 places the sound at the far left, 64 places the sound at the location specified by the **Pan** parameter, and 127 places the sound at the far right. This is controlled on the global MIDI channel (Global 1-1a).

Note: Random cannot be selected via a MIDI control change. You'll need to select it here.

AMS (Pan) [List of AMS Sources]

This selects an AMS source to modulate Pan.

For a list of AMS sources, please see "AMS (Alternate Modulation Source) List" on page 340.

Intensity [-99...+99]

This controls the depth and direction of the AMS modulation for Pan.

For example, if **Pan** is set to C064 and **AMS** is set to Note Number, **positive (+)** intensities will cause the sound to move toward the right as you play higher than C4, and toward the left as you play lower than C4. **Negative (-)** intensities will have the opposite effect.

Use DKit Setting [Off, On]

This option is available only when the **Oscillator Mode** is set to **Drums** or **Double Drums**.

Unlike standard Programs, Drum Kits can have a different pan setting for every note. This parameter lets you choose whether to use the Drum Kit pan settings, or to use the Program's pan setting instead.

On (checked): The Program will use the Drum Kit's per-note pan settings; pan AMS will still apply (Global 5-5b). This is the default setting.

Off (unchecked): The Program will ignore the Drum Kit's settings, and use the Program pan instead.

All keys of the drum kit will use the **Pan** setting.

4-1: Menu Command

- 0: **Write Program** see p. 64
- 1: **Exclusive Solo** see p. 64
- 2: **Auto Song Setup** see p. 65
- 3: **Copy Oscillator** see p. 65
- 4: **Swap Oscillator** see p. 65

For more information, please see "Program: Menu Command" on page 64.

4-2: Amp1 Modulation

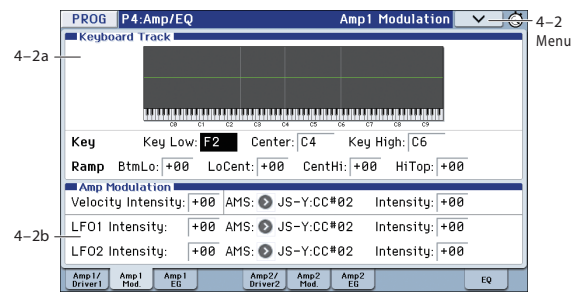

This page contains the settings for Oscillator 1's Amp level modulation. Among other things, you can:

- Set up complex keyboard tracking shapes to control the Amp level.
- Assign AMS modulation for the Amp level.
- Control the effect of the LFOs on the Amp level.

The total effect of the modulation can increase the volume to a maximum of two times louder than the **Amp Level** setting.

4-2a: Keyboard Track

Keyboard tracking lets you vary the volume as you play up and down the keyboard. Usually, some amount of key tracking is necessary in order to make the volume consistent across the entire range.

KROME's keyboard tracking can be fairly complex, if desired. You can create different rates of change over up to four different parts of the keyboard. For instance, you can:

- Make the volume increase very quickly over the middle of the keyboard, and then increase more slowly or not at all in the higher octaves.
- Make the volume increase as you play lower on the keyboard.
- Create abrupt changes at certain keys, for split-like effects.

Key:

Key Low [C-1...G9]

This specifies the note that will be the break point connecting the two sloped lines in the low region.

Center [C-1...G9]

This specifies the note that will be the break point in the center of keyboard tracking. At this key, the keyboard tracking has no effect on the volume, or on any AMS destinations.

Key High [C-1...G9]

This specifies the note that will be the break point connecting the two sloped lines in the high region.

Note: You can also set the note value and velocity value by holding down the edit cell or the ENTER button and playing a note on the keyboard (see OG p.10).

Ramp:

Positive ramp values mean that the keyboard tracking output increases as you play farther from the **Center Key**; negative ramp values mean that it decreases.

Because of this, the meanings of positive and negative ramp settings will change depending on whether the ramp is to the left or right of the **Center Key**.

Btm Lo (Bottom-Low) and Lo Cent (Low-Center): negative ramps make the keyboard tracking's output go down as you play lower, and positive ramps make the output go higher.

Cent Hi (Center-High) and Hi Top (High-Top): negative ramps make the keyboard tracking's output go down as you play higher, and positive ramps make the output go up.

Differences from other Keyboard Tracks

There are several differences between the Amp keyboard tracking and the Filter and Common keyboard tracking. For example, the results of the **Ramp** values are different. As shown in the graphic "Amp Keyboard Tracking," below, negative slopes are more steep than positive slopes. Also, the amp does not have separate control of Intensity. Instead, Intensity is always fixed at the maximum amount, allowing keyboard tracking to change the volume from complete silence to twice as loud as the programmed level.

Btm Lo (Bottom-Low) [-Inf, -99...+99, +Inf]
This sets the slope between the bottom of the MIDI note range and the **Key Low** key. For normal key track, use negative values.

Lo Cent (Low-Center) [-Inf, -99...+99, +Inf]
This sets the slope between the **Key Low** and **Center** keys. For normal key track, use negative values.

Cent Hi (Center-High) [-Inf, -99...+99, +Inf]
This sets the slope between the **Center** and **Key High** keys. For normal key track, use positive values.

Hi Top (High-Top) [-Inf, -99...+99, +Inf]
This sets the slope between the **Key High** key and the top of the MIDI note range. For normal key track, use positive values.

| Ramp | Change in level |
|------|--------------------------|
| -Inf | Silent in one half-step |
| -99 | Silent in one whole-step |
| -95 | Silent in one octave |
| -48 | Silent in two octaves |
| -25 | Silent in four octaves |
| 00 | no change |
| +25 | x2 in four octaves |
| +50 | x2 in two octaves |
| +99 | x2 in one octave |
| +Inf | x2 in one half-step |

+Inf and -Inf ramps

+Inf and -Inf are special settings which create abrupt changes for split-like effects. When a ramp is set to +Inf or -Inf, the keyboard tracking will go to its extreme highest or lowest value over the span of a single key.

When a ramp is set to +Inf, the keyboard tracking will go to its highest value (double the programmed volume) over a single half-step.

Similarly, when a ramp is set to -Inf, the keyboard tracking will go to its lowest value (complete silence) over a single half-step.

Note: If you set the **Cent Hi (Center-High)** ramp to +Inf or -Inf, the **Hi Top (High-Top)** parameter will be grayed out. Similarly, if you set the **Lo Cent (Low-Center)** ramp to +Inf or -Inf, the **Btm Lo (Bottom-Low)** ramp will be grayed out.

Amp KTrk is also an AMS source

You can use the keyboard tracking as an AMS source to modulate other parameters, just like the envelopes and LFOs. Simply select Amp KTrk in the AMS list for the desired parameter.

4-2b: Amp Modulation

You can modulate the Amp level by both velocity and an AMS source.

This modulation scales the basic Amp level and Amp EG level parameters. The resulting volume is determined by multiplying the volume changes of the amp EG by other values such as AMS. If these original levels are low, the maximum volume available with modulation will also be reduced.

Velocity Intensity [-99...+99]

With **positive (+)** values, the volume will increase as you play harder.

With **negative (-)** values, the volume will decrease as you play harder.

Velocity modulation of Amp level, with Amp EG

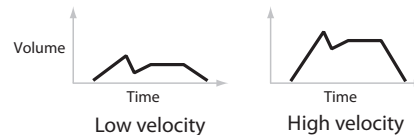

Amp Keyboard Tracking

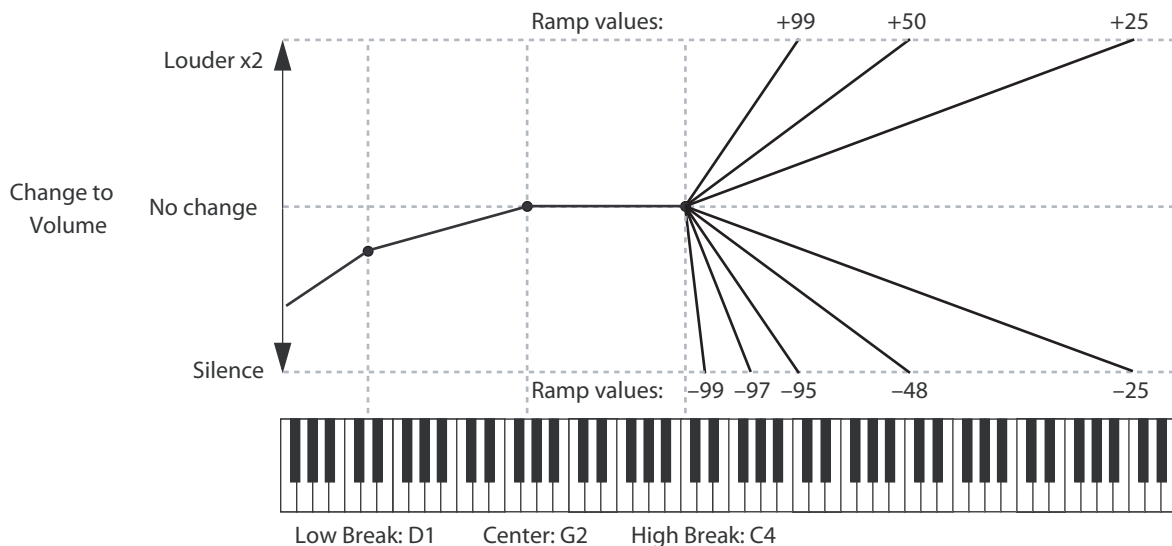

AMS [List of AMS Sources]

This selects any AMS modulation source to control the Amp1 level. For a list of AMS sources, please see “AMS (Alternate Modulation Source) List” on page 340.

Intensity [-99...+99]

This controls the depth and direction of the modulation. For example, if AMS is set to JS+Y: CC#01, positive (+) values of this parameter will make the volume increase when move the joystick in the +Y direction.

Note that if the other modulation settings have already raised the volume to its maximum level (double the Amp Level and Amp EG level settings), the volume cannot be increased any further.

LFO 1/2

You can modulate the Amp level with both LFO1 and LFO2.

LFO1

Intensity (LFO1) [-99...+99]

This controls the depth and direction of LFO1’s effect on the oscillator’s volume.

Negative (-) values will invert the LFO waveform.

AMS (LFO1) [List of AMS Sources]

This selects an AMS modulation source to scale the amount of the LFO1 applied to the Amp level.

For a list of AMS sources, please see “AMS (Alternate Modulation Source) List” on page 340.

Intensity [-99...+99]

This controls the depth and direction of the LFO1 AMS modulation for the Amp level.

LFO2

The parameters for LFO2 are identical to those for LFO1. For more information, please see the descriptions under LFO1, above.

∨ **4-2: Menu Command**

- 0: Write Program see p. 64
- 1: Exclusive Solo see p. 64
- 2: Auto Song Setup see p. 65
- 3: Copy Oscillator see p. 65
- 4: Swap Oscillator see p. 65

For more information, please see “Program: Menu Command” on page 64.

4-3: Amp1 EG

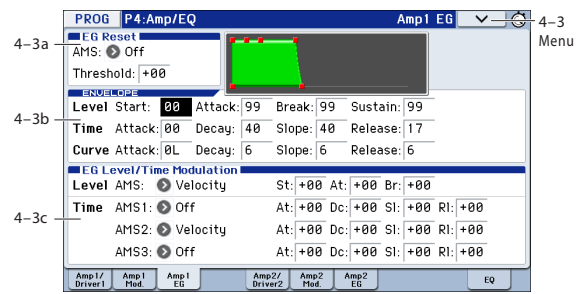

These parameters let you create time-varying changes in the volume of oscillator 1.

4-3a: EG Reset

AMS [List of AMS Sources]

This selects an AMS source to reset the EG to the start point. For instance, you can use a tempo-synced LFO to trigger the EG in a repeating rhythm. This reset is in addition to the initial note-on, which always causes the EG to start.

For a list of AMS sources, please see “AMS (Alternate Modulation Source) List” on page 340.

Note: Once the Amp EG is in its Release segment, it cannot be reset. (Otherwise, the sound might keep playing forever!)

Threshold [-99...+99]

This sets the AMS level which will trigger the EG reset.

Among other things, you can use this to adjust the exact point in an LFO’s phase at which the EG will be reset, effectively controlling its “groove” against other rhythmic effects. When the threshold is **positive**, the EG triggers when passing through the threshold moving upwards. When the threshold is **negative**, the EG triggers when passing through the threshold moving downwards.

Note: With some LFO shapes, and with faster LFO speeds, the LFO may not always reach the extreme values of +99 or -99. In this case, setting the **Threshold** to these values may cause inconsistent behavior, or may mean that the EG doesn’t reset at all. If this happens, reduce the **Threshold** until the EG triggers consistently.

4-3b: Envelope

These parameters specify how the amp 1 EG will change over time.

Amp EG

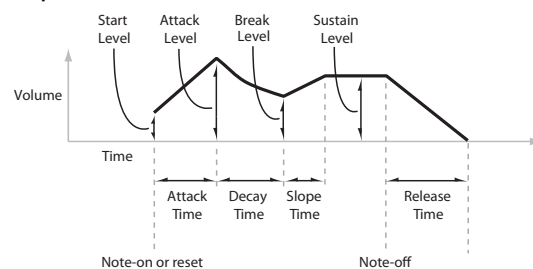

Level

Start [00...99]

This sets the initial volume level at note-on.

Attack [00...99]

This sets the level at the end of the Attack time.

Break [00...99]

Break, short for Break Point, sets the level at the end of the Decay time.

Sustain [00...99]

This sets the level at the end of the Slope time. Once it reaches the Sustain level, the EG will stay there until note-off (unless it is reset via AMS).

Time

Higher values mean longer times, as shown below.

| EG Value | Actual Time |
|----------|--------------|
| 10 | 10 ms |
| 20 | 44 ms |
| 30 | 104 ms |
| 40 | 224 ms |
| 50 | 464 ms |
| 60 | 944 ms |
| 70 | 1.8 seconds |
| 80 | 3.8 seconds |
| 90 | 10.9 seconds |
| 99 | 87.3 seconds |

Attack [00...99]

This sets how long the EG takes to move from the Start level to the Attack level.

For the fastest possible attack time, you can set the Start level to +99; in this case, the EG will start instantaneously at its maximum value.

Decay [00...99]

This sets the time it takes to move from the Attack level to the Break level.

Slope [00...99]

This sets how long the EG takes to move from the Break level to the Sustain level. Once it reaches the Sustain level, the EG will stay there until note-off (unless it is reset via AMS).

Release [00...99]

This sets how long it takes the EG to move from the Sustain level to silence.

Curve

For the sake of simplicity, most of the diagrams in this manual show envelopes as being made out of straight lines. In actuality, though, envelopes are more likely to be made out of curves.

In other words, each segment's level will change quickly at first, and then slow down as it approaches the next point. This tends to sound better than straight, linear segments.

Classic analog synth envelopes made these curved shapes naturally. The KROME goes a step further than vintage synths, however, and lets you control the amount of curvature separately for each of the four envelope segments.

When you change the curvature, the EG times remain the same. However, greater curvature will tend to sound faster, because the value changes more quickly at the beginning.

Amp EG Curve

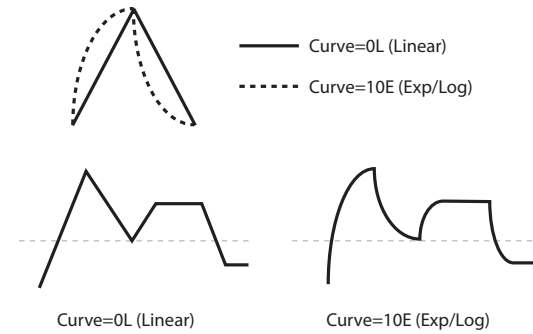

Different curve settings for up and down

You may find that different amounts of curvature are suitable for segments which go up and segments which go down.

For instance, a curve of 3 is a good default setting for upward segments, such as Attack. On the other hand, a curve of 6 or more is good for downward segments, such as Decay and Release.

Attack [0L (Linear), 1...9, 10E (Exp/Log)]

This sets the curvature of the Attack segment - the transition from the Start level to the Attack level.

Decay [0L (Linear), 1...9, 10E (Exp/Log)]

This sets the curvature of the Decay segment - the transition from the Attack level to the Break level.

Slope [0L (Linear), 1...9, 10E (Exp/Log)]

This sets the curvature of the Slope segment - the transition from the Break level to the Sustain level.

Release [0L (Linear), 1...9, 10E (Exp/Log)]

This sets the curvature of the Release segment - the transition from the Sustain level to the Release level.

4-3c: EG Level/Time Modulation

Level

These settings let you use any AMS source to control the Level parameters of the EG. The Start, Attack, and Break levels share a single AMS source, but can each have different modulation intensities.

By using different settings for each of the three levels, you can cause both subtle and dramatic changes to the EG shape, as shown below.

Once an EG segment begins, it can't be modulated

Once the EG has started a segment between two points, that segment can no longer be modulated. This includes both the time of the segment, and the level reached at the end of the segment.

For more information, please see "Once an EG segment begins, it can't be modulated" on page 33.

Amp EG Level Modulation

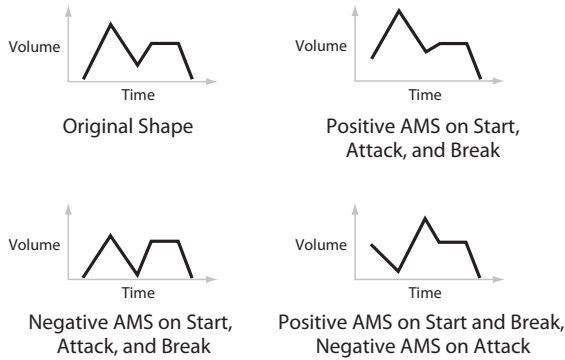

AMS [List of AMS Sources]

This selects an AMS source to control the EG's Level parameters.

For a list of AMS sources, please see "AMS (Alternate Modulation Source) List" on page 340.

St (Start) [-99...+99]

This controls the depth and direction of the AMS modulation for the Start level.

For example, if you set the AMS source to Velocity and set **St (Start)** to +99, the Start level will increase as you play harder. If you instead set **St (Start)** to -99, the Start level will decrease as you play harder.

At (Attack) [-99...+99]

This controls the depth and direction of the AMS modulation for the Attack level.

Br (Break) [-99...+99]

This controls the depth and direction of the AMS modulation for the Break level.

Time

These settings let you use three different AMS sources to control the Time parameters of the EG. For each of the three AMS sources, the Attack, Decay, Slope, and Release times each have their own modulation intensities.

Amp EG Time Modulation

AMS=Velocity, Intensity = a positive (+) value

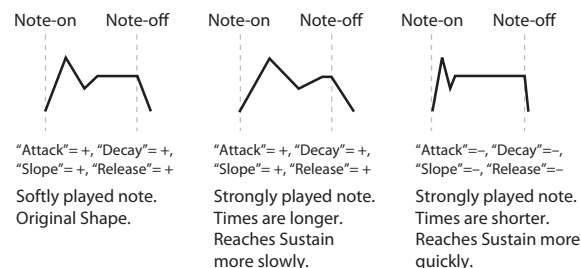

AMS1 [List of AMS Sources]

Selects the first AMS source to control the EG's Time parameters. Velocity and Keyboard Track can both be useful here, for instance.

For a list of AMS sources, please see "AMS (Alternate Modulation Source) List" on page 340.

At (Attack) [-99...+99]

This controls the depth and direction of the AMS modulation for the Attack time.

For example, if you set the AMS source to Velocity and set **At (Attack)** to +99, the Attack time will get much longer at

higher velocities. If you instead set **At (Attack)** to -99, the Attack time will get much shorter at higher velocities.

When the AMS source is at its maximum value for instance, when **Velocity** is at 127 a setting of +8 will make the segment time almost twice as long, and a setting of -8 will cut the segment time almost in half.

Dc (Decay) [-99...+99]

This controls the depth and direction of the AMS modulation for the Decay time.

Sl (Slope) [-99...+99]

This controls the depth and direction of the AMS modulation for the Slope time.

Rl (Release) [-99...+99]

This controls the depth and direction of the AMS modulation for the Release time.

AMS2 and AMS3

These select the second and third AMS sources, respectively, for controlling the EG's Time parameters. Each has its own intensities for Attack, Decay, Slope, and Release. The parameters of both AMS2 and AMS3 are identical to those of AMS1, above.

4-3: Menu Command

- 0: Write Program see p. 64
- 1: Exclusive Solo see p. 64
- 2: Auto Song Setup see p. 65
- 3: Copy Oscillator see p. 65
- 4: Swap Oscillator see p. 65

For more information, please see "Program: Menu Command" on page 64.

4-5: Amp2/Driver2

This page controls Oscillator 2's basic level, pan, and driver settings. It is available when the **Oscillator Mode** is set to **Double** or **Double Drums**; if not, the page will be grayed out.

The parameters are identical to those for Oscillator 1, as described under "4-1: Amp1/Driver1" on page 35.

4-6: Amp2 Modulation

This page controls Oscillator 2's amp modulation. It is available when the **Oscillator Mode** is set to **Double** or **Double Drums**; if not, the page will be grayed out.

The parameters are identical to those for Oscillator 1, as described under "4-2: Amp1 Modulation" on page 36.

4-7: Amp2 EG

This page controls Oscillator 2's amp EG. It is available when the **Oscillator Mode** is set to **Double** or **Double Drums**; if not, the page will be grayed out.

The parameters are identical to those for Oscillator 1, as described under "4-3: Amp1 EG" on page 38.

4-10: EQ

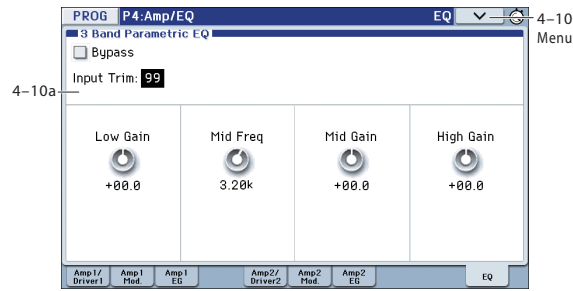

This three-band EQ, with sweepable mid, is shared by both of the Program's oscillators 1, 2.

In Combinations and Sequencers, each timbre and track has its own individual EQ. You can import the Program's EQ settings into Tracks and Timbres by using the Combination and Sequencer **Auto Load Program EQ** options.

4-10a:3 Band Parametric EQ

Bypass [On, Off]

On (checked): All of the EQ will be disabled, including the **Input Trim**.

Bypass is useful for comparing the results of the EQ with the original signal.

Input Trim [00...99]

This controls the volume level going into the EQ. The setting corresponds to the volume; 50 corresponds to -12 dB, and 25 corresponds to -24 dB.

High settings of the **Low**, **Mid**, and **High Gain** controls can cause substantial increases in the overall level. You can compensate for this by turning down the input trim.

Low Gain [-18.0...+00.0...+18.0[dB]]

This controls the gain of the 80 Hz Low Shelf EQ, in increments of 0.5 dB.

Mid Frequency [100(Hz)...10.00k(Hz)]

This sets the center frequency for the Mid sweep EQ.

Mid Gain [-18.0...+00.0...+18.0[dB]]

This controls the gain of the Mid Sweep EQ, in increments of 0.5 dB.

High Gain [-18.0...+00.0...+18.0[dB]]

This controls the gain of the 10 kHz High Shelf EQ, in increments of 0.5 dB.

✓ 4-10: Menu Command

- 0: **Write Program** see p. 64
- 1: **Exclusive Solo** see p. 64
- 2: **Auto Song Setup** see p. 65
- 3: **Copy Oscillator** see p. 65
- 4: **Swap Oscillator** see p. 65

For more information, please see "Program: Menu Command" on page 64.

PROG P5: LFO

Each of the Oscillators 1, 2 has two LFOs, which you can use to modulate the filter, amp, pitch, and many other parameters.

The two Oscillators also share a single Common LFO, similar to the global LFO on some vintage analog synths.

These pages let you set up all of the parameters for all five LFOs.

5-1: OSC1 LFO1 AMSSource

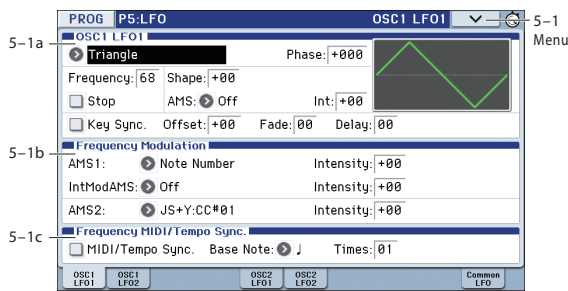

This page has all of the controls for the first LFO of Oscillator 1. For instance, you can:

- Select the LFO's basic waveform, and modify it with the **Shape** parameter.
- Control the LFO's frequency, and assign AMS controllers to modulate the frequency.
- Use the **Key Sync** parameter to choose whether the LFO runs separately for each voice, or is synchronized across all of the voices
- Use the **Fade** and **Delay** parameters to control how long the LFO waits to start after note-on, and whether it starts abruptly or fades in slowly.
- Set the LFO to sync to MIDI tempo.

5-1a: OSC 1 LFO 1

Waveform [Triangle...Random6 (Continuous)]

This selects the basic LFO waveform, as shown in the graphic below.

Most of the waveforms should be self-explanatory, but a few will benefit from more details:

Guitar is intended for guitar vibrato, and its shape is specifically tuned for this purpose. The waveform is positive-only, so that when used for pitch, it will only bend up, and not down.

Random1 (S/H) generates traditional sample and hold waveforms, in which the level changes randomly at fixed intervals of time.

Random2 (S/H) randomizes both the levels and the timing.

LFO waveform

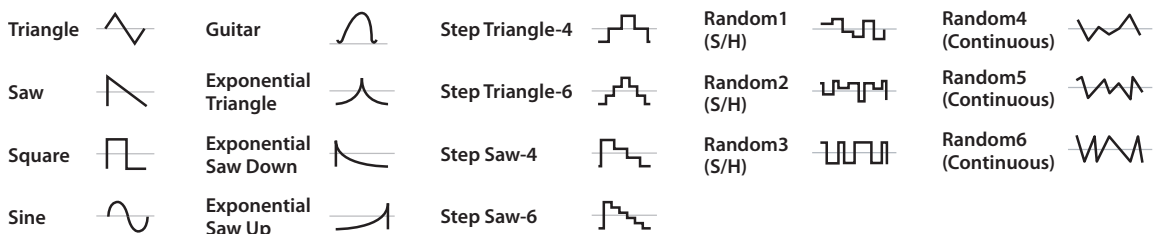

Random3 (S/H) generates a pulse wave with random timing. It's the opposite of traditional sample and hold; the timing varies, but the levels don't.

Random4-6 (Continuous) are smoothed versions of Random 1-3, with ramps instead of steps. You can use them to create more gentle random variations.

Phase [-180...+180, Random]

This controls the phase of the waveform at the start of the note, in steps of 5 degrees.

If **Key Sync** is Off, the Start Phase will apply only to the first note of the phrase.

Frequency [00...99]

This controls the speed of the LFO, before any modulation. Higher values mean faster speeds, as shown in the table below.

By using AMS modulation, you can also get speeds much faster and much slower than are available through this basic setting.

| Frequency Value | Frequency in Hz |
|-----------------|-----------------|
| 00 | 0.014 Hz |
| 10 | 0.112 Hz |
| 20 | 0.422 Hz |
| 30 | 0.979 Hz |
| 40 | 1.79 Hz |
| 50 | 2.84 Hz |
| 60 | 4.14 Hz |
| 70 | 5.69 Hz |
| 80 | 7.49 Hz |
| 90 | 9.53 Hz |
| 99 | 26.25 Hz |
| 99 + Fine 99 | 32 Hz |

Stop [Off, On]

On (checked): Instead of the LFO operating normally, it will ignore the **Frequency** setting. The LFO will maintain the initial value (determined by the combination of **Waveform**, **Phase**, **Shape**, and **Offset**) until the note-off.

Since the value will change only at note-on, using a Random waveform will produce a fixed value that changes randomly at each note-on (or at the first note-on).

Off (unchecked): The LFO will operate normally.

Shape [-99...+99]

Shape adds curvature to the basic waveform. As you can see in the graphic below, this can make the waveforms either more rounded or more extreme. It can also be useful to emphasize certain value ranges, and de-emphasize others.

For example, let's say that you are using a triangle LFO to modulate filter cutoff. If **Shape** emphasizes the high value range, the filter will spend more time at the higher

frequencies. If it emphasizes the low range, the filter will spend more time at the lower frequencies.

LFO Shape

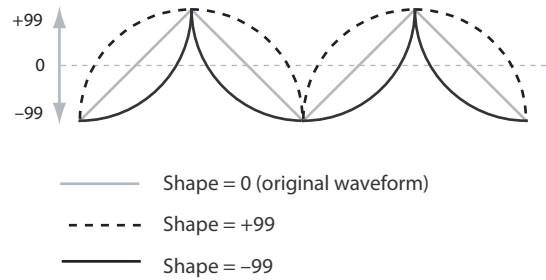

Note: Shape does **not** affect the Square and Random3 waveforms, since their values are always either +99 or -99. When these are selected, **Shape** is grayed out.

AMS (Shape) [List of AMS Sources]

This selects a AMS source for controlling the LFO's Shape. Modulating the shape can dramatically alter the effect of the LFO try it out!

For a list of AMS sources, please see "AMS (Alternate Modulation Source) List" on page 340.

AMS Int (Intensity) [-99...+99]

This controls the depth and direction of the AMS (Shape) modulation.

Key Sync. [Off, On]

On (checked): When Key Sync is **On**, the LFO starts each time you press a key, and an independent LFO runs for each note. This is the normal setting.

Off (unchecked): When Key Sync is **Off**, the LFO starts from the phase determined by the first note in the phrase, so that the LFOs for all notes being held are synchronized together. The **Fade** and **Delay** settings will only apply to the first note's LFO.

Note that even if Key Sync is Off, each note's LFO speed may still be different if you modulate the Frequency by note number, velocity, key scaling, or other note-specific AMS sources.

Offset [-99...+99]

By default, almost all of the LFO waveforms are centered around 0, and then swing all the way from -99 to +99. This parameter lets you shift the LFO up and down, so that for instance it's centered on 50, and then swings from -49 to +149.

For example, let's say that you're using an LFO for vibrato. If the **Offset** is 0, the vibrato will be centered on the note's original pitch, bending it both up and down.

If the **Offset** is +99, on the other hand, the vibrato will only raise the pitch above the original note.

Offset settings and pitch change produced by vibrato

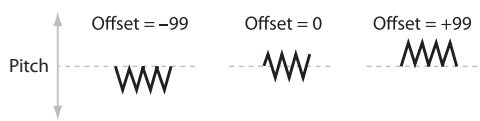

The one exception to this is the Guitar waveform, which is designed to emulate bending a string on a guitar so that the pitch only goes up, and not down. Because of this, the waveform is centered on 50, and not on 0. Of course, you can always use a negative **Offset** to shift it back down below 0 again!

Since Offset affects the output values of the LFO, it's important to note that it affects the signal after the Shape function, as shown below:

How the LFO signal is affected by Shape and Offset

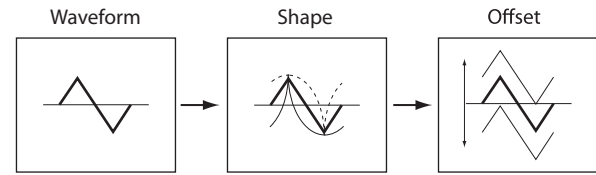

Fade [00...99]

The LFO can fade in gradually, instead of simply starting immediately at full strength. This parameter specifies the time from when the LFO begins to play until it reaches its maximum amplitude.

If the **Delay** parameter is being used, then the fade will begin after the delay is complete.

When **Key Sync** is **Off**, the fade will apply only to the first note in the phrase.

LFO Fade and Delay

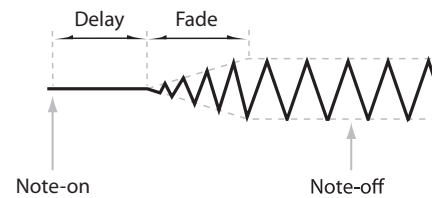

Delay [00...99]

This sets the time from note-on until the LFO starts.

When **Key Sync** is **Off**, the delay applies only to the first note of the phrase.

5-1b: Frequency Modulation

You can use two alternate modulation sources (AMS) to adjust the speed of the LFO.

AMS1 (Frequency) [List of AMS Sources]

This selects the first AMS source for the LFO1's frequency. For a list of AMS sources, please see "AMS (Alternate Modulation Source) List" on page 340.

Note that you can use LFO2 to modulate LFO1's frequency.

Intensity [-99...+99]

This sets the initial amount of **AMS1 (Frequency)**. The **Int Mod AMS** then adds to this initial amount.

When AMS is at its maximum value (for example by moving the joystick fully away from yourself), the AMS affects the frequency as shown below:

| Intensity | Change to LFO Frequency | |
|-----------|-------------------------|--------|
| +99 | 64x | Faster |
| +82 | 32x | |
| +66 | 16x | |
| +49 | 8x | |
| +33 | 4x | |
| +16 | 2x | Slower |
| -16 | 1/2x | |
| -33 | 1/4x | |
| -49 | 1/8x | |
| -66 | 1/16x | |
| -82 | 1/32x | |
| -99 | 1/64x | |

Int Mod AMS (Intensity Mod AMS)

[List of AMS Sources]

This selects a secondary AMS source to scale the intensity of AMS1.

For a list of AMS sources, please see “AMS (Alternate Modulation Source) List” on page 340.

Intensity [-99...+99]

This controls the depth and direction of the **Int Mod AMS**. Even if the main AMS1 Intensity is set to 0, **Int Mod AMS** can still control the final amount of AMS A over the full +/-99 range.

For example, if AMS1 is set to the **Pitch EG**, and **Int Mod AMS** is set to **JS+Y:CC#01**, **positive** settings mean that YS+Y will increase the intensity of the Pitch EG modulation of LFO Frequency.

AMS2 (Freq. AMS2) [List of AMS Sources]

This selects the second AMS source for the LFO1’s frequency. For a list of AMS sources, please see “AMS (Alternate Modulation Source) List” on page 340.

Intensity [-99...+99]

This controls the amount of modulation from AMS2 (Freq. AMS2).

5-1c: Frequency MIDI/Tempo Sync.

MIDI/Tempo Sync. [Off, On]

When MIDI/Tempo Sync is **On**, the LFO will synchronize to the system tempo, as set by either the Tempo knob or MIDI Clock. The LFO speed will be controlled by the **Base Note** and **Times** parameters, below. All settings for **Frequency** and **Frequency Modulation** will be ignored.

When MIDI/Tempo Sync is **Off**, the **Frequency** and **Frequency Modulation** settings will determine the speed of the LFO, and the tempo settings will have no effect.

Base Note (Sync. Base Note) [♪ ... ♩]

This sets the basic speed of the LFO, relative to the system tempo. The values range from a 32nd note to a whole note, including triplets.

Times (Sync. Times) [01...32]

This multiplies the length of the **Base Note**. For instance, if the **Base Note** is set to a sixteenth note, and **Times** is set to 03, the LFO will cycle over a dotted eighth note.

✓ 5-1: Menu Command

- 0: **Write Program** see p. 64
- 1: **Exclusive Solo** see p. 64
- 2: **Auto Song Setup** see p. 65
- 3: **Swap LFO 1&2** see p. 66

For more information, please see “Program: Menu Command” on page 64.

5-2: OSC1 LFO2 AMSource

This is Oscillator 1’s second LFO. Its parameters are exactly the same as those for the first LFO, as described under “5-1: OSC1 LFO1” on page 42—except that LFO1 cannot modulate LFO2.

5-5: OSC2 LFO1 AMSource

This page controls Oscillator 2’s first LFO. It is available when the **Oscillator Mode** is set to **Double** or **Double Drums**; if not, the page will be grayed out.

The parameters are identical to those for Oscillator 1, as described under “5-1: OSC1 LFO1” on page 42.

5-6: OSC2 LFO2 AMSource

This page controls Oscillator 2’s second LFO. It is available when the **Oscillator Mode** is set to **Double** or **Double Drums**; if not, the page will be grayed out.

Its parameters are exactly the same as those for the first LFO, as described under “5-1: OSC1 LFO1” on page 42—except that LFO1 cannot modulate LFO2.

5-10: Common LFO AMSource

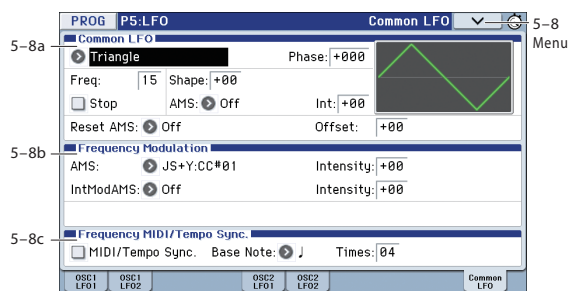

This is a single, Common LFO, global for all voices in the Program like the modulation LFOs in some vintage analog synths.

Differences from LFO1/2

The Common LFO starts running as soon as you select the Program, and only resets when you tell it to do so explicitly via the Reset Source control, below. This is different from LFO1/2's **Key Sync** parameter, which resets whenever all notes are released.

The Common LFO's persistence can be handy if you want to create a constant rhythm with an LFO, and then play "underneath" that rhythm without re-triggering it. For instance, you can use a MIDI controller in your sequencer to reset the Common LFO every few bars, regardless of what notes are being played.

The Common LFO has most of the same controls as LFO1/2. However, it does not include the **Delay**, **Fade**, and **Key Sync** settings, since these only make sense for per-voice LFOs.

5-10a:Common LFO

Waveform [Triangle...Random6 (Continuous)]

This selects the basic LFO waveform. For a complete list of the waveforms and more details, please see the entry under LFO1 "Waveform" on page 42.

Phase [-180...+180, Random]

The **Reset AMS**, described above, lets you reset the Common LFO. This is the phase from which the LFO will start when it is reset.

Frequency [00...99]

This controls the speed of the LFO, before any modulation. Higher values mean faster speeds. For a complete description, please see the entry under LFO1 "Frequency" on page 42.

Stop [Off, On]

On (checked): Instead of the LFO operating normally, it will ignore the **Frequency** setting. Instead, the LFO simply generates a single value when the Program is selected, and then holds that value until you select another Program, or until you reset the LFO via AMS.

Note: This is different from LFO1/2, in which the value is reset with every note-on.

You can use this in conjunction with the Random waveforms to create static, random modulation, with the value changing only when you first select the Program.

Off (unchecked): When Stop is Off, the LFO will function normally.

Shape [-99...+99]

Shape adds curvature to the basic waveform. For more details, please see the entry under LFO1 "Shape" on page 42.

Note: Shape does **not** affect the Square and Random3 waveforms, since their values are always either +99 or -99.

AMS (Shape) [List of AMS Sources]

This selects a AMS source for controlling the LFO's Shape. Modulating the shape can dramatically alter the effect of the LFO try it out!

For a list of AMS sources, please see "AMS (Alternate Modulation Source) List" on page 340.

AMS Int (AMS Intensity) [-99...+99]

This controls the depth and direction of the AMS (Shape) modulation.

Reset AMS [List of AMS Sources]

This selects an AMS source to reset the LFO to the Start **Phase**. The LFO resets when the AMS value passes the halfway mark: +50 for most AMS sources, or 64 for MIDI controllers.

To create an effect similar to the per-voice LFO's **Key Sync** setting, set this to **Gate 2+ Damper**.

Offset [-99...+99]

By default, almost all of the LFO waveforms are centered around 0, and then swing all the way from -99 to +99. This parameter lets you shift the LFO up and down, so that for instance it's centered on 50, and then swings from -49 to +149.

For a complete description, please see the entry under LFO1 "Offset" on page 43.

5-10b:Frequency Modulation

These parameters are identical to the Frequency Modulation settings for LFO1, as described under "5-1b: Frequency Modulation" on page 43.

5-10c:Frequency MIDI/Tempo Sync

These parameters are identical to the Frequency MIDI/Tempo Sync for LFO1, as described under "5-1c: Frequency MIDI/Tempo Sync." on page 44.

5-10: Menu Command

- 0: **Write Program** see p. 64
- 1: **Exclusive Solo** see p. 64
- 2: **Swap LFO 1&2** see p. 66

For more information, please see "Program: Menu Command" on page 64.

PROG P6: AMS/Common Key Track (AMS Mixer/Common Keyboard Track)

Each Oscillator has two AMS Mixers, which are simple but powerful tools for combining and modifying AMS signals.

The two Oscillators also share two Common keyboard tracking generators, in addition to the dedicated keyboard tracking for the Filter and Amp.

These pages let you control all of these modulation sources.

Note that when the **Oscillator Mode** is set to **Single**, only Oscillator 1's AMS Mixers are active; the pages for Oscillator 2 will be grayed out.

6-1: OSC1 AMS Mix1 AMSource

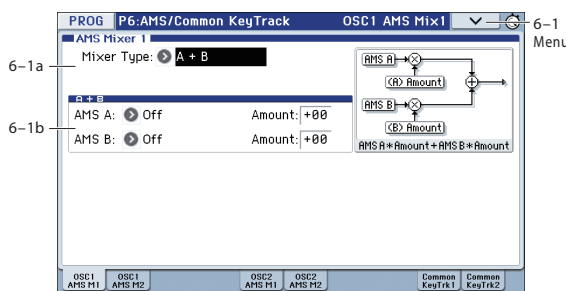

The AMS Mixers combine two AMS sources into one, or process an AMS source to make it into something new.

For instance, they can add two AMS sources together, or use one AMS source to scale the amount of another. You can also use them to change the shapes of LFOs and EGs in various ways, modify the response of realtime controllers, and more.

You can select the output of the AMS mixers as an AMS source in the same way as an LFO or EQ.

This also means that the original, unmodified inputs to the AMS Mixers are still available as well. For instance, if you use LFO1 as an input to an AMS Mixer, you can use the processed version of the LFO to control one AMS destination, and the original version to control another.

Finally, you can cascade the two AMS Mixers together, by using AMS Mixer 1 as an input to AMS Mixer 2.

6-1a: AMS Mixer 1

Mixer Type [A+B, Amt Ax B, Offset, Smoothing, Shape, Quantize, Gate Control]

This controls the type of processing performed by AMS Mixer 1. Each of the Mixer Types is discussed in detail over the next several pages.

A+B adds two AMS sources together. For more information, please see "A+B" on page 46.

Amt Ax B scales the amount of one AMS source with the other. For more information, please see "Amt Ax B" on page 47.

Offset adds or subtracts a constant value to or from an AMS source. For more information, please see "Offset" on page 47.

Smoothing specifies the smoothness of movement between two values. You can use this to smooth sudden changes such as an abrupt movement of the joystick or sharp angle of the LFO. For more information, please see "Smoothing" on page 48.

Shape adds curvature to the AMS input. For more information, please see "Shape" on page 48.

Quantize turns smooth transitions into discrete steps. For more information, please see "Quantize" on page 49.

Gate Control uses a third AMS source to switch between two AMS inputs (or a fixed value). For more information, please see "Gate Control" on page 49.

A+B

AMS Mixer, Type = A+B

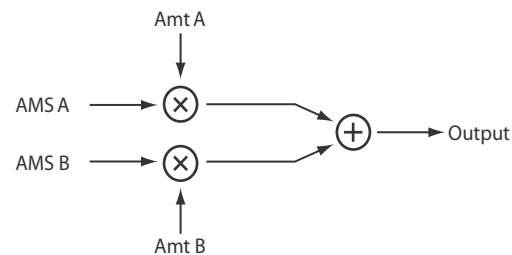

A+B merges two AMS sources into one. This can be handy when you need to add one more modulation source to a parameter, but you've already used up all of the available AMS slots.

For instance, let's say that you're using an LFO to modulate **Filter Resonance**, and then you decide that it would be interesting to scale that parameter with an EG as well. Resonance has only a single AMS input, but you can easily merge the LFO and the EG together using the A+B AMS Mixer:

1. Assign the LFO to AMS A.
2. Assign the EG to AMS B.
3. Assign the AMS Mixer as the Filter Resonance AMS source.

AMS Mixer A+B example

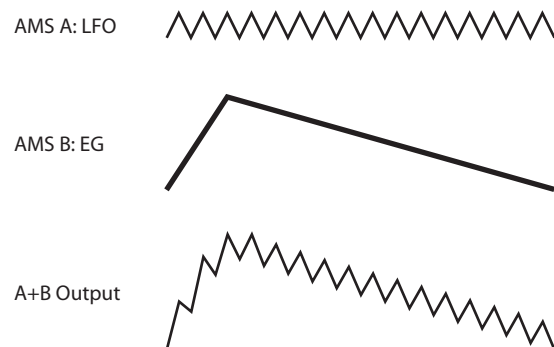

AMS A [List of AMS Sources]

This selects the first AMS input.

For a list of AMS sources, please see "AMS (Alternate Modulation Source) List" on page 340.

AMS A Amount [-99...+99]

This controls the depth and direction of the AMS A input.

AMS B [List of AMS Sources]

This selects the second AMS input.

For a list of AMS sources, please see "AMS (Alternate Modulation Source) List" on page 340.

AMS B Amount [-99...+99]

This controls the depth and direction of the AMS B input.

Amt AxB

AMS Mixer, Type = Amt A x B

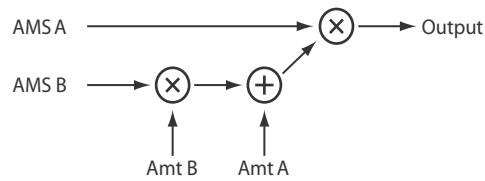

This Mixer Type uses AMS B to scale the amount of AMS A. For instance, you can control the amount of LFO1 with the Filter EG, or control the amount of the Pitch EG with the joystick.

AMS Mixer Amt AxB example

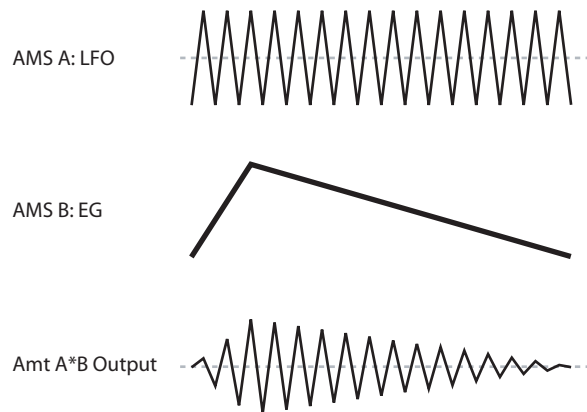

AMS A [List of AMS Sources]

This selects the first AMS source, which can then be scaled by AMS B.

For a list of AMS sources, please see "AMS (Alternate Modulation Source) List" on page 340.

AMS A Amount [-99...+99]

This controls the initial amount of AMS A, before modulation from AMS B. Input from AMS B then adds to this initial amount.

Even if Amount A is set to 0, AMS B can still control the final amount of AMS A over the full +/-99 range.

AMS B [List of AMS Sources]

This selects the second AMS source, to scale the amount of AMS A.

For a list of AMS sources, please see "AMS (Alternate Modulation Source) List" on page 340.

AMS B Amount [-99...+99]

This controls the depth and direction of the AMS B modulation of AMS A.

For example, if AMS A is set to LFO1 and AMS B is set to the Filter EG, **positive** settings mean that the EG will increase the amount of LFO1.

Tip: use SW 1/2 to turn an AMS source on and off

You can use Amt AxB to "gate" an AMS source:

1. Set AMS A to the desired source, and set the AMS A Amount to 0.
2. Set AMS B to SW1 or 2, and AMS B Amount to +99.

Now, SW1 or 2 will turn AMS A on and off.

Offset

AMS Mixer, Type = Offset

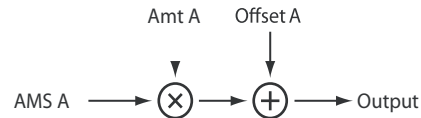

This simple processor adds a constant offset to the input, and also allows you to double the gain of an AMS source.

For instance, you can use this to convert a bipolar LFO (both negative and positive) to a unipolar LFO (positive only). To do this:

1. Select the LFO as the AMS A input.
2. Set the AMS A Amount to 50.

This cuts the overall level of the LFO in half, so that instead of swinging between -99 and +99, it only swings between -50 and +50.

3. Set the AMS A Offset to 50.

This adds 50 to the LFO level, so that it now swings between 0 and +99, as shown below.

AMS Mixer Offset examples

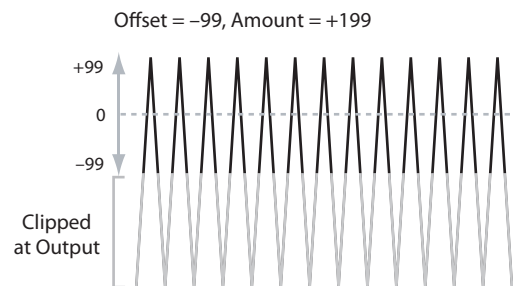
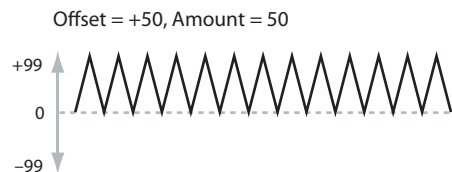
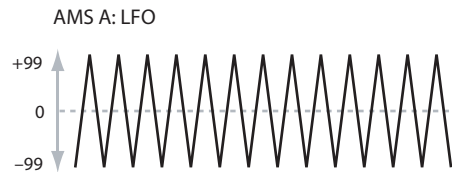

AMS A [List of AMS Sources]

This selects the AMS source to be offset.

For a list of AMS sources, please see "AMS (Alternate Modulation Source) List" on page 340.

AMS A Amount [-199...+199]

This controls the basic level of AMS A.

+199 doubles the original signal level, while -199 doubles the original signal level and inverts the phase. The values are clipped only at the output; internally, they can be greater than the normal range of -99 to +99.

AMS A Offset [-199...+199]

This controls the amount of offset for AMS A.

Setting Offset to +199 shifts an AMS input of -99 all the way to +99. In conjunction with high AMS A Amount values, this can be useful for creating clipped shapes, such as shown in the last of the "AMS Mixer Offset examples" above.

Smoothing

This Mixer Type smooths out the AMS input, creating more gentle transitions between values. You have separate control of the amount of smoothing during the attack (when the signal is increasing) and decay (when it's decreasing).

The higher the Attack and Decay settings, the more the input will be smoothed.

Low settings provide subtle controller smoothing, creating more gradual aftertouch, for instance. Higher settings create auto-fade effects, transforming a quick gesture into a longer fade-in and/or fade-out event.

Smoothing can also be used to alter the shape of programmable mod sources, such as LFOs and EGs. For instance, you can turn a "blip" into a simple envelope shape, as shown below.

AMS Mixer Smoothing examples

Original AMS A:



Smoothing with Long Attack and Short Decay:

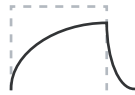

Smoothing with Short Attack & Long Decay:



AMS A [List of AMS Sources]

This selects the AMS source to be smoothed.

For a list of AMS sources, please see "AMS (Alternate Modulation Source) List" on page 340.

AMS A Attack [00...+99]

This controls the attack time of the smoother, or how long it takes the smoother to reach a new, higher value.

Higher Attack settings mean longer times.

Depending on how quickly the AMS input value is changing, high Attack settings may mean that the value is never quite reached, as shown in "AMS Mixer Shape examples" above.

AMS A Decay [00...+99]

This controls the decay time of the smoother, or how long it takes the smoother to reach a new, lower value.

Higher Decay settings mean longer times.

Shape

This Mixer Type adds curvature to the AMS input. This applies deformation to the AMS input. You can use this to customize a controller curve, such as the exponential curve of the joystick or the logarithmic curve of velocity control. It can also alter the shape of programmable modulation sources, such as EGs and LFOs.

Note: Shape only affects AMS signals which already have some amount of slope, such as EGs, triangle and sine LFOs, and so on. It does not affect signals which only contain abrupt transitions, such as square waves.

AMS A [List of AMS Sources]

This selects the AMS input source to be shaped.

For a list of AMS sources, please see "AMS (Alternate Modulation Source) List" on page 340.

Shape [-99...+99]

This controls the amount of curvature, and whether the curves are concave or convex. As you can see in the graphic examples, the shape will tend to emphasize certain value ranges, and de-emphasize others.

For example, let's say that you are using a triangle LFO, through **Shape**, to modulate filter cutoff. If Shape emphasizes the high value range, the filter will spend more time at the higher frequencies. If it emphasizes the low range, the filter will spend more time at the lower frequencies.

Mode [Symmetric, Asymmetric]

This selects whether the Shape parameter will produce one or two curves. The graphic "AMS Mixer Shape examples" may help to visualize how this works.

Asymmetric will produce a single curve, extending from -99 to +99.

Symmetric will produce two matching curves extending outwards from 0 to -99 and +99, respectively.

Bipolar and Unipolar AMS sources

To understand Shape, it helps to understand the difference between **bipolar** and **unipolar** AMS sources.

Bipolar sources can swing all the way from -99 to +99, with 0 in the middle. Most LFOs are bipolar, for instance; so is Pitch Bend.

Generally, bipolar AMS sources will work better with the **Asymmetric** mode, but **Symmetric** may also produce interesting results.

Unipolar sources only go from 0 to 99, with 50 in the middle. MIDI controllers, such as JS+Y (CC#1), are all unipolar. In practice, EGs are usually programmed to be unipolar, even though the Filter and Pitch EGs do allow both positive and negative levels.

With unipolar sources, it's almost always better to use the **Symmetric** mode. The **Asymmetric** mode can cause offsets and other strange results.

AMS Mixer Shape examples

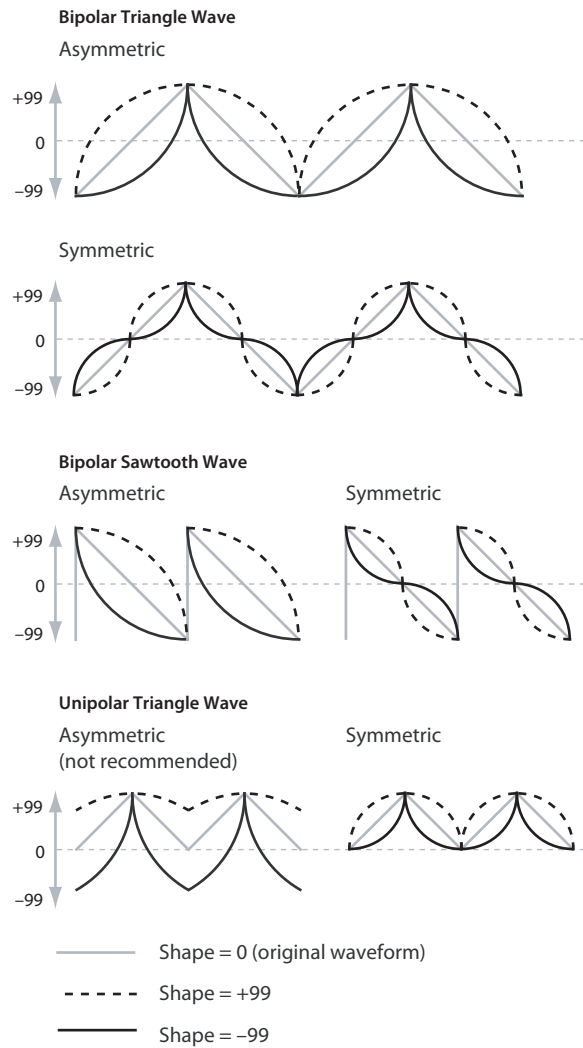

Quantize

This Mixer Type changes the input from a continuous signal into a series of discrete steps. Instead of moving smoothly between values, it will snap immediately from one value to another.

You can use this to change the shape of LFOs or EGs, or to force a controller to land on a few specific values.

AMS Mixer Quantize examples

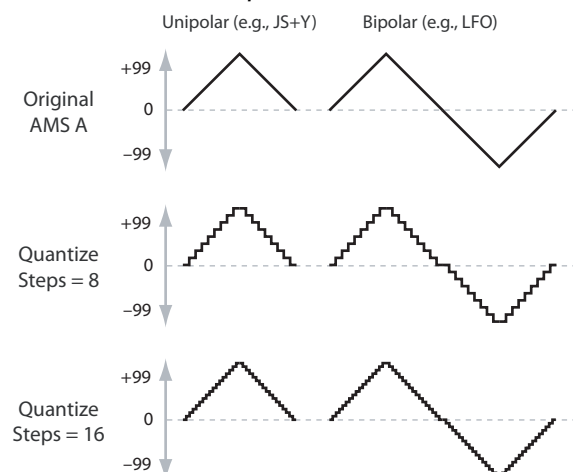

AMS A

[List of AMS Sources]

This selects the AMS input source to be quantized.

For a list of AMS sources, please see “AMS (Alternate Modulation Source) List” on page 340.

Number Of Steps

[2...32]

This controls the severity of the effect. The lower the number of steps, the more “steppy” the output will be.

For instance, when this is set to 2, there will be “steps” at 0, 50, and 99. With a bipolar AMS input, there will also be steps at -50 and -99.

As another example, when it is set to 5, there will be steps at 0, 20, 40, 60, 80, and 99 (as well as -20, -40, -60, -80, and -99 for bipolar inputs).

Tip: Quantized Joystick Pitch Bend

You can use the joystick to create quantized pitch bends that simulate sliding across the frets of a guitar, or jump-bend sounds caused by differences in the length of the tube of a trumpet. To do so:

1. Select the AMS Mixer as the Oscillator Pitch AMS input.
2. Set the Pitch AMS Intensity to any exact half-step value, such as +5.00, +7.00, etc.
3. Set the JS(+X), JS(-X) amount to 0.00.
4. In the AMS Mixer, select the JS X as AMS A.
5. Set the Number Of Steps to the same number you used in Step 2.

Now, playing the joystick will create quantized pitch bends. JSX will still produce smooth pitch bends, as usual, so you can use both techniques together.

Gate Control

AMS Mixer, Type = Gate Control

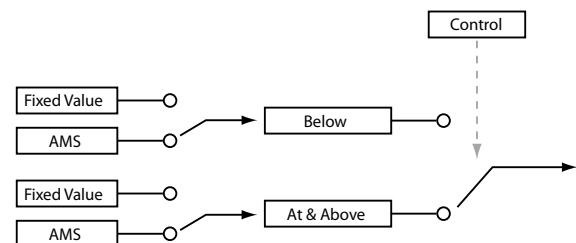

This Mixer Type lets you set up two different AMS sources (or fixed AMS amounts), and then switch between the two using a third AMS source.

It's similar to an audio gate with a side-chain, but with even more flexibility since you get to choose what happens when the gate is closed (below the threshold), as well as when it's open (above the threshold).

You can also choose whether the gate will be able to open and close continuously in response to the control source, or whether it only opens or closes at the beginning of the note, and then stays that way over the note's entire duration.

You can use the Gate to:

- Use a foot-switch (or other controller) to apply pitch-bend or other effects to some notes, but not to others
- The parameter will be applied when the controller reaches a specific threshold. For example, the velocity value could control the filter resonance only if the velocity value exceeds 90.
- Use the joystick, switches, or controllers to change between two separate LFOs (or other AMS sources).

Gate Control:

Source [List of AMS Sources]

This selects the AMS source to control the gate.

Control At Note-On Only [Off, On]

When this is enabled (checked), the value of the **Control Source** at note-on will select the output (**Below Threshold** or **At & Above Threshold**). The selected output will then remain active throughout the duration of the note, regardless of any subsequent change in the **Control Source's** value.

Note that the output value itself can continue to change; only the selection of **Below** or **At & Above** is fixed.

Threshold [-99...+99]

This sets the value of the **Control Source** at which the gate opens or closes.

Gate Output:

If the value of the **Control Source** is less than the **Threshold**, the Gate outputs the preset value or AMS source selected under **Below Threshold**.

If the value of the **Control Source** is greater than or equal to the **Threshold**, the Gate outputs the preset value or AMS source selected in the **At & Above Threshold** parameter.

Below Threshold [Fixed Value, AMS A]

This selects whether **Below Threshold** uses a preset value, or the selected AMS source.

Fixed Value [-99...+99]

This lets you set a specific value to be used when the **Control Source** is less than the **Threshold**. This only applies when **Below Threshold** is set to **Fixed Value**.

AMS A [List of AMS Sources]

This lets you set an AMS source to pass through the Gate when the **Control Source** is less than the **Threshold**. This only applies when **Below Threshold** is set to **AMS A**.

At & Above Thresh (At & Above Threshold) [Fixed Value, AMS B]

This selects whether **At & Above Threshold** uses a preset value, or the selected AMS source.

Fixed Value [-99...+99]

This lets you set a specific value to be used when the **Control Source** is greater than or equal to the **Threshold**. This only applies when **At & Above Threshold** is set to **Fixed Value**.

AMS B [List of AMS Sources]

This lets you set an AMS source to pass through the Gate when the **Control Source** is greater than or equal to the **Threshold**. This only applies when **At & Above Threshold** is set to **AMS B**.

Tips on using the Gate

Selective pitch-bend, using a switch

You can use **Control At Note-On Only** to apply an effect to some notes, but not others, based on the state of an AMS source at the start of the note. For instance:

1. Set the **Control Source** to **Foot SW: CC#82**
2. Set **Control At Note-On Only** to **On** (checked).
3. Set the **Threshold** to 50.
4. Set **Below Threshold** to a **Fixed Value** of +00.
5. Set **At & Above Threshold** to **AMS B: JS X**.

6. On the **OSC Pitch** page, assign the **AMS Mixer** to control the pitch.
7. Turn off the foot switch, and while holding down a chord, move the joystick in the X-direction. The pitch will not change.

(If the pitch changes, go to the **OSC Pitch** page and set **Pitch JS (+X)** and **JS (-X)** to +00.)

8. Turn on the foot switch, and add a new note to the previous chord.
9. Move the joystick in the X-direction; pitch bend will be applied only to the newly-played note.

The new note will bend, but the original chord (played before you pressed on the foot-switch) will not.

Selective pitch-bend, using only the joystick

You can also use a single AMS source as both the **Control Source** and a value source:

1. Set the **Control Source** to **JS X**.
2. Set **Control At Note-On Only** to **On** (checked).
3. Set the **Threshold** to 00.
4. Set **Below Threshold** to **AMS A: JS X**.
5. Set **At & Above Threshold** to a **Fixed Value** of 00.
6. On the **OSC Pitch** page, assign the **AMS Mixer** to control the pitch.
7. With the joystick in the center, play a chord, and hold it through step 9.
8. Bend the joystick to the left, and then play a new note above the chord.

(If the pitch changes, go to the **OSC Pitch** page and set **Pitch JS (+X)** and **JS (-X)** to +00.)

9. Use the joystick to bend the pitch of the new note.

The new note will bend, but the original chord (played before you bent the joystick down) will not. This method is particularly good for bending the top note of a chord up to pitch.

Generating a static value

Sometimes, it can be handy to have a preset value as an AMS source. The Gate is one way to create this. To do so:

1. Set both **Below Threshold** and **At & Above Threshold** to **Fixed Value**, and enter the same value into each.

Now, the AMS mixer will always generate this static value.

✓ 6-1: Menu Command

- 0: **Write Program** see p. 64
- 1: **Exclusive Solo** see p. 64
- 2: **Auto Song Setup** see p. 65
- 3: **Copy Oscillator** see p. 65
- 4: **Swap Oscillator** see p. 65

For more information, please see "Program: Menu Command" on page 64.

6-2: OSC1 AMS Mix2 AMSource

This is the second AMS Mixer for Oscillator 1. The parameters are exactly the same as those for AMS Mixer 1, as described under “6-1a: AMS Mixer 1” on page 46.

6-4: OSC 2 AMS Mix1 AMSource,

6-5: OSC 2 AMS Mix2 AMSource

This page controls the two AMS Mixers for Oscillator 2. These are available only when the **Oscillator Mode** is set to **Double** or **Double Drums**; if not, the page will be grayed out.

The parameters are identical to those for Oscillator 1, as described under “6-1: OSC1 AMS Mix1” on page 46.

6-9: Common KeyTrk 1 (Common Keyboard Track 1)

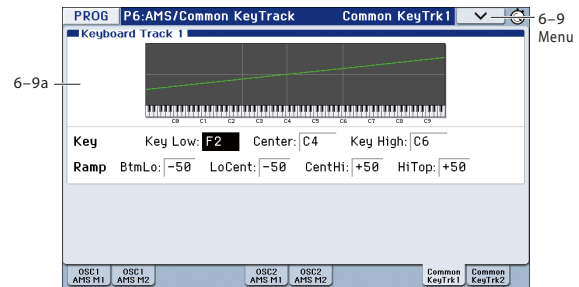

The two Oscillators share two Common keyboard tracking generators, in addition to each Oscillator’s dedicated keyboard tracking for the Filter and Amp. You can use these Common keytracks as AMS sources for modulating most AMS destinations.

The Common Keyboard Track parameters are shared by the entire Program, but the actual AMS values are calculated individually for each voice.

What does Keyboard Tracking do?

At its most basic, keyboard tracking lets you vary the modulation amount as you play up and down the keyboard. This can be useful for making the timbre consistent across the entire range, or adjusting parameters according to pitch.

The KROME keyboard tracking can be fairly complex, if desired. You can create different rates of change over up to four different parts of the keyboard. For instance, you can:

- Make the modulation increase very quickly over the middle of the keyboard, and then increase more slowly or not at all in the higher octaves.
- Make the modulation increase as you play lower on the keyboard.
- Create abrupt changes at certain keys, for split-like effects.

Common Keyboard Tracking

At the Center Key, the AMS value is always 0.

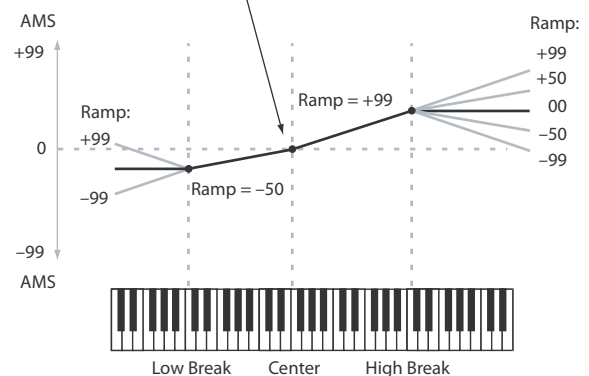

For more information, please see “3-2: Filter1 Keyboard Track” on page 28.

6-9a: Keyboard Track 1 AMSource

Key

Low Break [C-1...G9]

This specifies the note that will be the break point connecting the two sloped lines in the low region.

Center [C-1...G9]

This specifies the note that will be the break point in the center of keyboard tracking. At this **key**, the keyboard tracking has no effect on the AMS destinations.

High Break [C-1...G9]

This specifies the note that will be the break point connecting the two sloped lines in the high region.

Note: You can also set the note value and velocity value by holding down the edit cell or the ENTER button and playing a note on the keyboard (see OG p.10).

Ramp

Positive ramp values mean that the keyboard tracking output increases as you play farther from the **Center Key**; negative ramp values mean that it decreases.

Because of this, the meanings of positive and negative **Ramp** settings will change depending on whether the ramp is to the left or right of the **Center Key**.

Bottom-Low and Low-Center: negative ramps make the keyboard tracking's output go down as you play lower on the keyboard, and positive ramps make the output go higher.

Center-High and High-Top: negative ramps make the keyboard tracking's output go down as you play higher on the keyboard, and positive ramps make the output go up.

Bottom-Low [-Inf, -99...+99, +Inf]

This sets the slope between the bottom of the MIDI note range and the **Low Break** key. For normal key track, use negative values.

Low-Center [-Inf, -99...+99, +Inf]

This sets the slope between the **Low Break** and **Center** keys. For normal key track, use negative values.

Center-High [-Inf, -99...+99, +Inf]

This sets the slope between the **Center** and **High Break** keys. For normal key track, use positive values.

High-Top [-Inf, -99...+99, +Inf]

This sets the slope between the **High Break** key and the top of the MIDI note range. For normal key track, use positive values.

The table below shows how the **Ramps** affect the AMS output:

| Ramp value | AMS change |
|------------|----------------------------|
| -Inf | goes to -99 in 1 half-step |
| -99 | -20 per octave |
| -50 | -10 per octave |
| 0 | no change |
| +50 | +10 per octave |
| +99 | +20 per octave |
| +Inf | goes to +99 in 1 half-step |

+Inf and -Inf ramps

+Inf and -Inf are special settings which create abrupt changes for split-like effects. When a ramp is set to +Inf or

-Inf, the keyboard tracking will go to its extreme highest or lowest value over the span of a single key.

+Inf and -Inf Ramps

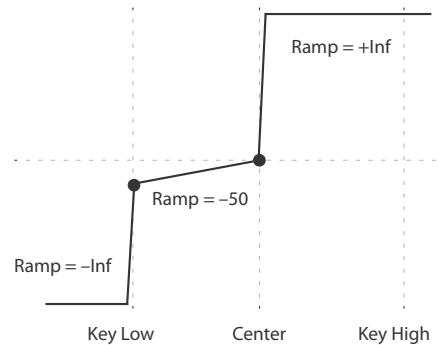

Note: If you set the **Center-High** ramp to +Inf or -Inf, the **High-Top** parameter will be grayed out. Similarly, if you set the **Low-Center** ramp to +Inf or -Inf, the **Bottom-Low** ramp will be grayed out.

6-9: Menu Command

- 0: **Write Program** see p. 64
- 1: **Exclusive Solo** see p. 64
- 2: **Auto Song Setup** see p. 65
- 3: **Copy Oscillator** see p. 65
- 4: **Swap Oscillator** see p. 65

For more information, please see "Program: Menu Command" on page 64.

6-10: Common KeyTrk 2 (Common Keyboard Track 2)

Here you can make settings for the second common keyboard track.

For more information, please see "6-9: Common KeyTrk 1 (Common Keyboard Track 1)" on page 51.

PROG P7: ARP/DT (Arpeggiator/Drum Track)

Here you can make settings for the arpeggiator used by the program.

You can make settings so that when you select a program, these arpeggiator settings will automatically switch to the arpeggiator settings that are memorized in the selected program. (Global P0: 0-1c Load ARP when changing "Program" on page 195)

The arpeggiator can be switched on/off by the ARP button. When on, the key LED will light up.

The settings of the ARP button, TEMPO, arpeggio control (ARP) GATE, VELOCITY, SWING and STEP knobs can be saved for each program.

Note: The parameters below that are marked with "*" can also be edited in "P0: Play- Arpeggiator."

 These settings will be valid when "Load ARP when changing" **Program** (Global 0-1c) is checked.

 You can control the arpeggiator from an external sequencer, or record note data generated by the arpeggiator onto an external sequencer. (See OG page 96)

Note: **Pattern, Resolution, Octave, Sort, Latch, Key Sync, Keyboard,** and **Tempo** can also be set from the P0: Play, Arpeggio page.

7-1: ARP Setup

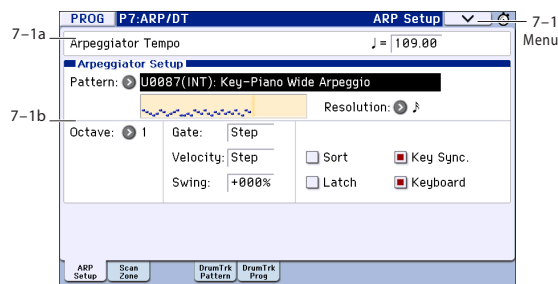

7-1a: Tempo

Tempo* [040.00...300.00, EXT]

Sets the tempo, expressed as beats per minute.

You can also adjust this by turning the front panel TEMPO knob. Alternatively, you can set the tempo by pressing the TAP button at the desired interval.

 When **MIDI Clock** (Global P1: 1-1b) is set to either **External MIDI** or **External USB**, this parameter will indicate **EXT**, and the arpeggiator will synchronize to the MIDI Clock received from an external MIDI device. If **MIDI Clock** is set to Auto, this indication will be shown only if MIDI clock data is being received from an external device. When the EXT indication is shown, the arpeggiator etc. will synchronize to MIDI clock data from the external MIDI device.

7-1b: Arpeggiator Setup

Pattern* [P0...P4, U0000(INT)...U0899(INT), U0900(USER)...U1027(USER)]

Selects the arpeggio pattern.

| Preset/User No | Contents |
|---------------------------|-----------------------------|
| P0...P4 | Preset arpeggio patterns |
| U0000(INT)...U0899(INT) | Preloaded arpeggio patterns |
| U0900(USER)...U1027(USER) | User arpeggio patterns |

Note: U0000(INT)–U1027(USER) are rewritable. Use Global P6: Arpeggio Pattern to create arpeggio patterns.

Example: Preset pattern

The way in which the pattern is played will depend on settings such as **Octave** and **Sort**. P0–P4 in the following diagrams show how the arpeggio will be played when **Octave** is set to 1, and **Sort** is checked. P4: RANDOM is only one possibility.

P0: UP

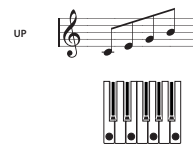

P1: DOWN

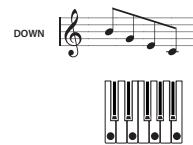

P2: ALT1

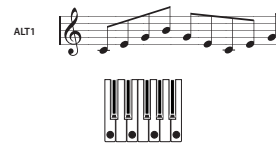

P3: ALT2

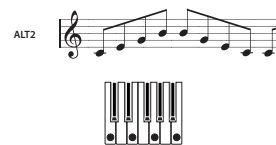

P4: RANDOM

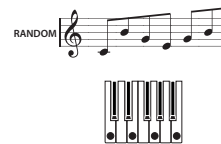

Octave* [1, 2, 3, 4]

Specifies the number of octaves in which the arpeggio will be played.

 If a user arpeggio pattern is selected, the range of the arpeggio will depend on the **Octave Motion** (Global P6: 6-1b) setting.

7-2: ARP Scan Zone

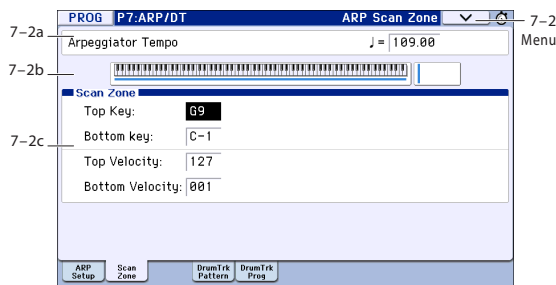

7-2a: Arpeggiator Tempo

(Tempo) [040.00...300.00, EXT]

For more information, please see “(Tempo)*” on page 53.

7-2b: Zone Map

This shows the Scan Zone.

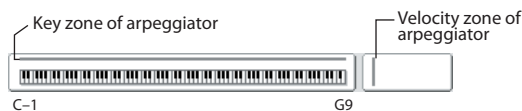

7-2c: Scan Zone

This shows the *Scan Zone* setting.

Top Key [C-1...G9]

Bottom Key [C-1...G9]

These parameters specify the range of notes (keys) for which the arpeggiator will function. **Top Key** is the upper limit, and **Bottom Key** is the lower limit.

The arpeggiator will operate when you play keys within the specified range. Keys outside of this range can be played in the normal manner, and will not be affected by the arpeggiator on/off.

For example if you set **Pattern** to P0: UP, check **Latch**, set **Top Key** to B3, and **Bottom Key** to C-1, playing a note B3 or lower will trigger the arpeggiator. Since **Latch** is on, the arpeggio will continue even after you release the keys. You can use the C4 and higher keys to play conventionally along with the arpeggio sounded by the B3 and lower keys. To change the arpeggio, play keys in the range of B3 and below.

Top Velocity [001...127]

Bottom Velocity [001...127]

Specifies the range of velocities for which the arpeggiator will function. **Top Velocity** is the upper limit, and **Bottom Velocity** is the lower limit.

The arpeggiator will operate when you play notes with a velocity (playing strength) that is within the specified range. Notes played with a velocity outside this range will be sounded normally, without regard to the arpeggiator on/off.

Note: You can also set the note value and velocity value by holding down the edit cell or the ENTER button and playing a note on the keyboard (see OG p.10).

7-2: Menu Command

- 0: **Write Program** see p. 64
- 1: **Exclusive Solo** see p. 64

- 2: **Auto Song Setup** see p. 65
- 3: **Copy Arpeggiator** see p. 66

For more information, please see “Program: Menu Command” on page 64.

7-4: Drum Track Pattern

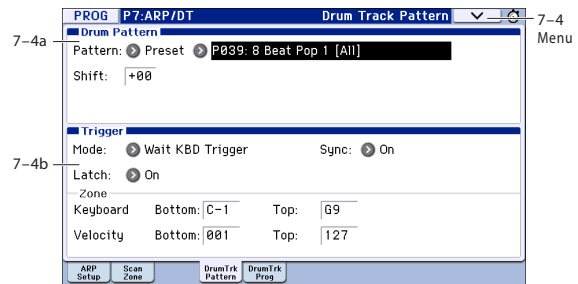

Here you can select a drum track pattern and specify how it will sound.

MIDI In Program mode, the drum track patterns are triggered on the Global MIDI channel. The MIDI transmit channel is specified by the DrumTrack **Prog MIDI Ch** (Global P1: MIDI- MIDI Basic). Use the DrumTrack **Prog MIDI Out** (Global P1: MIDI- MIDI Basic) setting to specify whether the pattern will transmit MIDI note data. The default setting is channel 10.

The drum track program will not transmit or receive MIDI program changes.

7-4a: Drum Pattern

Pattern [Preset, User]

[(Preset): P000...P605, (User): U000...U999]

This selects the drum pattern.

| Preset/User No. | Contents |
|-----------------|----------------------------------|
| P000 | Off |
| P000...P605 | Preset drum patterns |
| U000...U999 | For user/preloaded drum patterns |

- U000–U999 can be written. Patterns you create in Sequencer mode can be converted into user drum patterns. (See page 188)

Shift [-24...+00...+24]

This transposes the drum pattern in semitone steps. This means that the instruments of the drum kit will change.

7-4b: Trigger

Trigger Mode [Start Immediately, Wait KBD Trig]

Start Immediately: When you press the DRUM TRACK button to turn it on (LED lit), the drum track pattern will start according to the **Sync** setting. When you turn it on, the drum track pattern will stop.

Wait KBD Trig: When you press the DRUM TRACK button to turn it on (LED lit), the drum pattern will wait to start. When you play the keyboard, or when a MIDI note-on is received, the drum pattern will start according to the **Sync** setting.

⚠ If you've selected **Start Immediately**, the DRUM TRACK button will always be saved in the OFF state.

Sync [Off, On]

Off: The drum pattern will not synchronize to the currently-running arpeggiator, but will start immediately.

On: The drum pattern will synchronize to the currently-running arpeggiator.

Note: Use P7-1: Arpeggiator Setup **Key Sync** to specify whether the arpeggiator will synchronize to the currently-running drum pattern.

Latch [Off, On]

This specifies whether the drum track will continue playing even after you take your hand off the keyboard.

This setting is available if **Trigger Mode** is set to Wait KBD Trig.

Off: The pattern will stop when you take your hand off the keyboard (i.e., when all notes are off).

On: The pattern will continue playing until the DRUM TRACK button is turned off (LED unlit), regardless of whether you are performing via the keyboard or via MIDI.

Zone:

Keyboard

Bottom [C-1...G9]

Top [C-1...G9]

This is valid if **Trigger Mode** is set to Wait KBD Trig.

It specifies the range of keys that will start the drum pattern.

Velocity

Bottom [001...127]

Top [001...127]

This is valid if **Trigger Mode** is set to Wait KBD Trig.

It specifies the range of velocities that will start the drum pattern.

Note: You can also set the note value and velocity value by holding down the edit cell or the ENTER button and playing a note on the keyboard (see OG p.10).

7-4: Menu Command

- 0: Write Program see p. 64
- 1: Exclusive Solo see p. 64
- 2: Auto Song Setup see p. 65
- 3: Copy Drum Track see p. 65
- 4: Erase Drum Track Pattern see p. 66

For more information, please see "Program: Menu Command" on page 64.

7-5: Drum Track Program

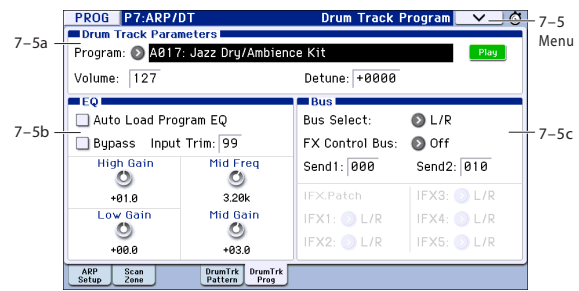

7-5a: Drum Track Parameters

Program Select [Drum Category Programs]

Here you can select the drum program that will be used by the drum track.

Note: Only programs of the Drum category can be selected.

⚠ If data is loaded or a system exclusive message is received so that the selected program is no longer a Drum category program, it will be replaced with the first program of the Drum category.

MIDI The drum track program will not transmit or receive MIDI program changes.

Volume [000...127]

This adjusts the volume of the drum track program.

Play/Mute [Mute, Play]

This mutes the drum track program. The setting will alternate each time you press the Play/Mute button.

Mute: The drum track program will not be heard (Mute).

Play: The drum track program will be heard (Play).

Using the Mixer & Drum Track page to make Drum Track settings

You can use the P0-3: Mixer & Drum Track page to edit the **Play/Mute**, **Solo On/Off**, and **Volume** settings of the drum track. (See "0-3a: OSC/DrumTrack Mixer" on page 5.)

Detune [-1200...+1200]

This adjusts the pitch in one-cent steps. One cent is 1/100th of a semitone.

The pitch of each drum kit is specified in Global P5: Drum Kit.

MIDI You can control this using RPNs.

7-5b: EQ

Auto Load Program EQ [Off, On]

On (checked): When you switch the drum track program, the 3-band EQ values specified for the program will automatically be loaded. Normally you will leave this checked.

You are free to edit the 3-band EQ values that are automatically loaded. You will be making changes based on the settings of the original program.

Off (unchecked): The 3-band EQ values specified for the program will not be loaded when you switch the drum track program.

Bypass [On, Off]

When Bypass is checked, all of the EQ will be disabled, including the **Input Trim**.

Bypass can be convenient for comparing the results of the EQ with the original signal.

Input Trim [00...99]

This controls the volume level going into the EQ. This setting corresponds to the volume; a value of 50 corresponds to -6 dB, and a setting of 25 corresponds to -12 dB.

High settings of the **Low**, **Mid**, and **High Gain** controls can cause substantial increases in the overall level. You can compensate for this by turning down the input trim.

High Gain [-18.0...+00.0...+18.0[dB]]

This controls the gain of the 10 kHz High Shelf EQ, in increments of 0.5 dB.

Mid Frequency [100Hz...10k(Hz)]

This sets the center frequency for the Mid sweep EQ.

Mid Gain [-18.0...+00.0...+18.0[dB]]

This controls the gain of the Mid Sweep EQ, in increments of 0.5 dB.

Low Gain [-18.0...+00.0...+18.0[dB]]

This controls the gain of the 80 Hz Low Shelf EQ, in increments of 0.5 dB.

7-5c: Bus

Bus Select [Dkit, L/R, IFX1...5, Off]

This specifies the bus that will output the drum track program.

Dkit: The **Bus (IFX/Output) Select**, **FX Control Bus**, **Send1 (to MFX1)**, and **Send2 (to MFX2)** settings (Global 5-5b) for each key of the drum kit used by the selected drum track program will be valid. Choose this setting if you want to apply separate insert effects to each drum instrument.

Note: When making Dkit settings, you will normally use **IFX.Patch** to specify the output destination.

L/R: Output to the L/R bus.

IFX1, 2, 3, 4, 5: Output to the IFX1-5 bus.

Off: The sound will not be output to the L/R bus, or IFX1-5 bus. Use the Off setting if you have connected the drum track program output in series to a master effect. Use **Send1 (to MFX1)** or **Send2 (to MFX2)** to adjust the send level.

FX Control Bus [Off, 1, 2]

This sends the output of the drum track program to the FX Control bus (two mono channels FX Ctrl1, 2).

The FX Control bus is used when you want to use another audio signal to control the input of an effect. You can use the two FX Control buses (two mono channels) to freely control the effects in a variety of ways. For more information, please see "FX Control Buses" on page 238.

Send 1 [000...127]

Send 2 [000...127]

These specify the send level at which the output of the drum track program will be sent to each master effect.

Send 1: Send the signal to master effect 1.

Send 2: Send the signal to master effect 2.

If **Bus (IFX/Output) Select** is set to IFX1-5, the send levels to the master effects are set by the post-IFX1-5 **Send1** and **Send2** (Prog 8-2a).

 You can use CC#93 to control **Send 1**, and CC#91 to control **Send 2**.

IFX.Patch:

IFX1 [L/R, IFX1...5, Off]

IFX2 [L/R, IFX1...5, Off]

IFX3 [L/R, IFX1...5, Off]

IFX4 [L/R, IFX1...5, Off]

IFX5 [L/R, IFX1...5, Off]

Here, you can patch the **Bus (IFX/Output) Select** setting specified for each key of the drum kit, temporarily changing its connection destination from the originally specified insert effect to some other destination. This can be executed only if the drum track program's **Bus (IFX/Output) Select** is set to DKit and the **Bus (IFX/Output) Select** (Global 5-5b) for each key of the drum kit is set to IFX1-5.

As the patch destination, choose an insert effect or L/R, IFX1-5, or Off as the output bus.

Note: If you want to return the drum kit to its previous state, change these settings to IFX1→IFX1, IFX2→IFX2, IFX3→IFX3, IFX4→IFX4, and IFX5→IFX5.

For the preloaded kits, snare sounds are normally sent to IFX1, kick sounds to IFX2, and other sounds to IFX3. In such cases if you set **Bus Select** to Dkit, these sounds will be sent to IFX1, IFX2, and IFX3, but IFX1 and IFX2 are set for normal (non-drum) programs. In such cases, you can use **IFX.Patch** to route these drum sounds to unused IFX; for example, you might send the snare sounds to IFX3, kick sounds to IFX4, and other sounds to IFX5. For more information, please see "Effect Guide" on page 235.

✓ **7-5: Menu Command**

- 0: **Write Program** see p. 64
- 1: **Exclusive Solo** see p. 64
- 2: **Auto Song Setup** see p. 65
- 3: **Copy Drum Track** see p. 65
- 4: **Erase Drum Track Pattern** see p. 66

For more information, please see "Program: Menu Command" on page 64.

PROG P8: Routing/IFX (Insert Effect)

Here, you can make settings for the insert effects. For instance, you can:

- Send the output of an oscillator to an insert effect
- Route a sound to an insert effect
- Make detailed settings for insert effects

For more information, please see “Effect Guide” on page 235.

8-1: Routing

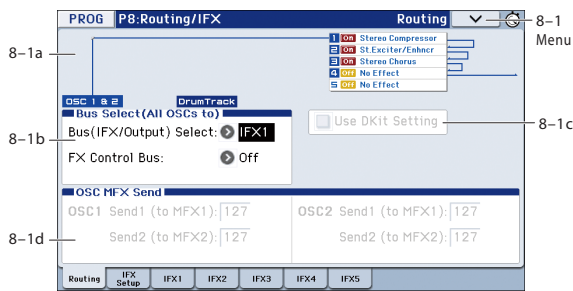

8-1a: Routing Map

This graphic shows an overview of the insert effects.

Here you can view the status of the input bus to the insert effect **Bus (IFX/Output) Select**, the effect you’re editing, and its on/off status and chain status.

This page lets you adjust the routing of the oscillators to the insert effects. To adjust the other settings shown in this graphic, please see “8-2: Insert FX Setup” on page 59.

8-1b: Bus Select (All OSCs to)

Bus (IFX/Output) Select [L/R, IFX1...5, Off]

This specifies the output bus for oscillators 1 and 2.

L/R: The oscillators will be output to the L/R bus. Normally you will choose L/R.

IFX1...5: Output to the IFX1–5 busses.

Off: The oscillator will not be output from the L/R bus, or IFX1–5 busses. Choose the Off setting if you want the program oscillator output of the timbre to be connected in series to a master effect. Use **Send1 (to MFX1)** and **Send2 (to MFX2)** to specify the send levels.

FX Control Bus [Off, 1, 2]

Sends the output of the oscillator 1, 2 to an FX Control bus (two-channel mono FX Ctrl 1 or 2).

Use the FX Control busses when you want a separate sound to control the audio input of an effect. You can use two FX Control busses (each is a two-channel mono bus) to control effects in various ways.

For more information, please see “FX Control Buses” on page 238.

8-1c: Use Dkit Setting

Use DKit Setting [Off, On]

This is shown if **Oscillator Mode** (Prog 1–1a) is set to **Drums** or **Double Drums**. If **Oscillator Mode** is set to **Single** or **Double**, this setting is ignored.

On (checked): The **Bus (IFX/Output) Select**, **FX Control Bus**, **Send 1**, and **Send 2** settings (Global 5–5b) for each key of the selected drum kit will be used. Check this if you want to apply an individual insert effect to each drum instrument.

Tip: In most preloaded drumkits, the drum instruments have the same **Bus (IFX/Output) Select** settings according to their type, as follows.

Snares → IFX1

Kicks → IFX2

Other → IFX3

Off (unchecked): The **Bus (IFX/Output) Select** (Prog 8–1b), **FX Control Bus** (Prog 8–1b), **OSC MFX Send** (Prog 8–1d) settings will be used. All drum instruments will be sent to the specified bus.

8-1d: OSC MFX Send

OSC1:

OSC1 Send1 (to MFX1) [000...127]

Sets the volume (send level) at which the output of oscillator 1 will be sent to master effect 1. This applies only when **Bus (IFX/Output) Select** (Prog 8–1b) is set to **L/R** or **Off**.

If **Bus (IFX/Output) Select** is set to **IFX1–IFX5**, the send levels to master effects 1 and 2 are set by **Send 1** and **Send 2** (Prog 8–2a) after passing through IFX1–5.

OSC1 Send2 (to MFX2) [000...127]

Sets the volume (send level) at which the output of oscillator 1 will be sent to master effect 2. For more information, please see “OSC1 Send1 (to MFX1)” on page 58.

OSC2:

OSC2 Send1 (to MFX1) [000...127]

OSC2 Send2 (to MFX2) [000...127]

Sets the volume (send level) at which the output of OSC2 will be sent to master effects 1 and 2. These parameters will be valid when **Oscillator Mode** is set to **Double** or **Double Drums** and **Bus (IFX/Output) Select** is set to **L/R** or **Off**.

MIDI CC#93 controls OSC 1/2’s Send 1 level, and CC#91 controls the Send 2 level. These are controlled on the global **MIDI Channel** (Global 1–1a). The actual send level is determined by multiplying these values with the send levels of each oscillator.

✓ 8-1: Menu Command

- 0: **Write Program** see p. 64
- 1: **Exclusive Solo** see p. 64
- 2: **Auto Song Setup** see p. 65
- 3: **Copy Insert Effect** see p. 66
- 4: **Swap Insert Effect** see p. 67

For more information, please see “Program: Menu Command” on page 64.

8-2: Insert FX Setup

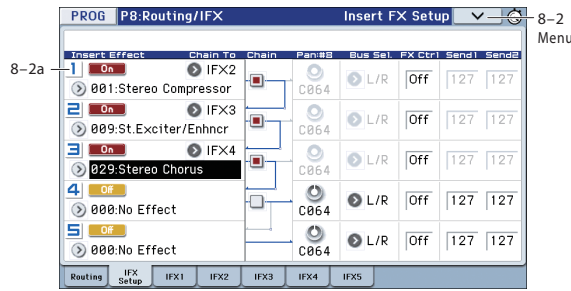

8-2a: Insert Effect

Here, you can choose the type of each insert effect 1 through 5, its on/off status, chaining, and adjust the post-IFX mixer settings.

For insert effects, the direct sound (Dry) is always stereo-in and out. The input/output configuration of the effect sound (Wet) depends on the effect type.

For more information, please see “Insert Effects (IFX1–IFX5)” on page 240.

Insert Effect:

IFX1...4 [000...193]

IFX5 [000...171]

This selects the effect type for insert effect.

IFX5 cannot use double-size effects (172–193). If you use a double-size effect, the next insert effect will be unavailable. For example if you select a double-size effect for IFX1, you won't be able to use IFX2.

Category/IFX Select menu

When you press the popup button, the Category/IFX Select menu will appear, letting you select effects by category. Use the tabs to select a category, and then select an effect within that category. Press the OK button to execute your selection, or press the Cancel button to cancel.

IFX1...5: IFX On/Off [Off, On]

Switches the insert effect on/off.

If this is off, the input will simply be passed to the output. (When 000:No Effect is selected, there's no difference between On and Off.)

The setting will alternate between on and off each time you press the button.

 Separately from this setting, you can use MIDI CC #92 (on the global MIDI Channel (Global 1–1a)) to turn all insert effects off. A value of 0 turns them off, and values of 1–127 restore the original setting.

Chain:

IFX1: Chain to [IFX2...IFX5]

IFX2: Chain to [IFX3...IFX5]

IFX3: Chain to [IFX4...IFX5]

You can chain up to five insert effects together in series, to create more complex effects. Set up the chain using this parameter, and then enable it using the **Chain** check box, below.

Effects must be chained in ascending numeric order. For example, IFX1 can be chained to any of IFX2 through IFX5, and IFX2 can be chained to IFX3 through IFX5.

You can chain two or more effects into the same downstream effect. For instance, both IFX1 and IFX2 can be chained to IFX5.

Effects can also join a chain in the middle. For instance, you can chain IFX3 to IFX4 to IFX5, and then chain IFX2 to IFX5 as well.

The **Pan:#8**, **Bus (Bus Select)**, **Ctrl (FX Control Bus)**, and **Send1/2** settings apply only to the last effect in the chain. However, any effect in the chain can be sent to the FX Control buses.

IFX1: Chain [Off, On]

IFX2: Chain [Off, On]

IFX3: Chain [Off, On]

IFX4: Chain [Off, On]

This enables the chain, as set up by the **Chain to** parameter, above.

Pan:#8:

Pan: #8 (Post IFX PanCC#8) [L000...C064...R127]

Specifies the panning immediately after the insert effect.

 You can use CC#8 to control this.

Bus Sel.:

Bus Sel. (Bus Select) [Off, L/R]

Specifies the bus to which the signal will be sent immediately after the insert effect.

L/R: The signal will be sent to the L/R bus, which passes through TFX and then goes to the AUDIO OUTPUT L/R outputs. This is the default setting.

Off: The signal will not be sent directly to the L/R outputs. This setting is useful if you want to:

Use **Send 1** or **2** to route the signal entirely through the master effects, without sending the dry signal to the outputs.

Use the **FX Control Bus** to route the signal to an effects side-chain, such as a gate or vocoder, without being heard directly at the outputs.

FX Ctrl:

FX Ctrl (FX Control Bus) [Off, 1, 2]

Sends the post-IFX signal to the FX Control busses. For more information, please see “FX Control Bus” on page 58.

 If you're using **Ctrl (FX Control Bus)** as an input signal for Vocoder etc., a feedback loop will occur if you output to the same bus as specified here, and oscillation will occur. Set this with care to avoid creating a loop.

Send1/2:

Send1 [000...127]

Send2 [000...127]

These adjust the level at which the post-IFX signal is sent to master effects 1 and 2. This is valid if **Bus (Bus Select)** is set to L/R or Off.

 You can use CC#93 to control the Send 1 level, and CC#91 to control the Send 2 level. The global MIDI channel specified by **MIDI Channel** (Global 1–1a) is used for these messages.

8-2: Menu Command

- 0: Write Program see p. 64
- 1: Exclusive Solo see p. 64
- 2: Auto Song Setup see p. 65
- 3: Copy Insert Effect see p. 66
- 4: Swap Insert Effect see p. 67

For more information, please see “Program: Menu Command” on page 64.

8-3: IFX1

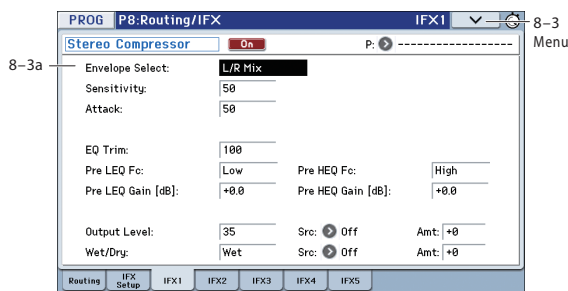

8-3a: Insert Effect 1 (IFX1)

Here you can edit the parameters of the insert effect you selected in the P8: Routing/IFX- Insert FX Setup page.

MIDI Effect dynamic modulation (Dmod) is controlled on the global **MIDI Channel** (Global 1-1a). For more information, please see “Dynamic Modulation Source List” on page 346.

IFX1 On/Off [Off, On]

This turns the insert effect on and off. It is linked with the on/off setting in the Insert FX Setup page.

P (Effect Preset) [P00, P01...15, U00...15, -----]

Effect Presets let you easily store and recall all of the settings for an individual effect. You can store up to 16 user presets for each effect type, in addition to 15 re-writable factory presets.

The same presets appear in all of the modes (Program, Combination, and Sequencer).

Note that edits to effects parameters are automatically stored with the Program you don't need to store them as an Effect Preset. Presets just make it easier to re-use your favorite settings.

For instance, you can save an Effect Preset while working on a particular Program, and then later use the same Effect Preset in a different Program, Combination, or Song.

P00: Initial Set: These are the default settings that are recalled when you select an effect type in the Insert FX Setup page. You can't save your own settings here.

P01...P15: Preset data is saved in this area. We recommend that you store your settings in U00-U15.

U00...U15: These are areas in which you can store your own settings.

-----: This shows that no Effect Preset has been selected. You'll see this if you've just selected an effect, written a Program, or selected a new Program. Selecting this setting from the menu will not have any effect.

Note: Programs save the effects parameter settings, but they don't save the number of the selected Effect Preset. If you

select an Effect Preset, and then save the Program, the Effect Preset setting will revert to “-----.”

Using Effect Presets

1. Select an effect in the Insert FX Setup page.
 2. The **P00: Initial Set** settings will be recalled. **P** (Effect Preset) will indicate -----.
 3. Use “**P** (Effect Preset)” to select an effect preset: **P00-P15** or **U00-U15**.
- The stored parameters will be recalled. Note that this will overwrite all parameters of the effect.
4. Edit the recalled parameters as desired.
 5. If you've come up with settings you like and want to save them as a new preset, use the **Write FX Preset** menu command.

IFX1 Parameters:

IFX1 Parameters

This tab shows the parameters for IFX1, as selected on the Insert FX Setup page.

For details on the specific parameters of each effect, please see “Insert Effects (IFX1-IFX5)” on page 240.

8-3: Menu Command

- 0: Write Program see p. 64
- 1: Exclusive Solo see p. 64
- 2: Auto Song Setup see p. 65
- 3: Copy Insert Effect see p. 66
- 4: Swap Insert Effect see p. 67
- 5: Write FX Preset see p. 67

For more information, please see “Program: Menu Command” on page 64.

8-4: IFX2, 8-5: IFX3, 8-6: IFX4, 8-7: IFX5

Here you can edit the effect parameters for the insert effects selected in the Insert FX Setup page.

The parameters for IFX2-IFX5 are the same as for IFX1.

PROG P9: MFX/TFX/LFO (Master/Total Effect/LFO)

Here, you can make settings for the master effects and total effect. For instance, you can:

- Route a sound to an master effects and total effect
- Make common LFO settings for effects
- Make detailed settings for master effects and total effect

For more information, please see “Effect Guide” on page 235.

9-1: Routing

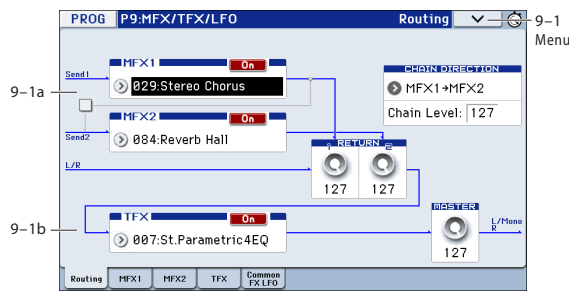

Here you can specify the type of master effects and total effect, and turn them on/off.

The master effects are sent to the L/R bus. The total effect is inserted into the L/R bus.

9-1a: MFX1, 2

The master effect does not output the direct sound (Dry). Adjust the **Return 1** and **Return 2** return levels to return the signal to the L/R bus and mix it with the L/R bus signal.

The master effects are stereo-in/out, but depending on the selected effect type, the output may be monaural. For more information, please see “In/Out” on page 240.

MFX1:

MFX1 [000...193]

This selects the effect type for master effect 1. You can use any of the available effects, without limitation. If you choose 000:No Effect, the output from the master effect is muted.

Category/MFX Select menu

When you press the popup button, the Category/MFX Select menu will appear, letting you select effects by category. Use the tabs to select a category in the menu, and then select an effect within that category. Press the OK button to execute your selection, or press the Cancel button to cancel.

MFX1 On/Off [Off, On]

Switches the master effect 1 on/off. When off, the output will be muted. This will alternate between on and off each time it is pressed.

Tip: An easy way to disable the master effects is to turn off the front panel MASTER FX button. MFX 1/2 will be temporarily disabled, and will stay off even if you switch programs or modes. When you turn the switch on, the master effects will be enabled, and you will obtain the effects specified by the program or combination.

Note: The MASTER FX button is linked with Global P0-1 Effect Global SW **Enable MFX1&2** (see p.5).

MIDI Separately from the settings here, you can use control change #94 to turn master effects 1 and 2 off. A value of

0 turns them off, and values of 1–127 restore the original setting. The global MIDI channel specified by **MIDI Channel** (Global 1–1a) is used for this message.

Return 1 [000...127]

This specifies the return level from the master effect to the L/R bus.

Note: The L/R bus is sent to TFX, and then output to the main L/MONO and R output jacks.

MFX2:

MFX2 [000...171]

MFX2 On/Off [Off, On]

Return 2 [000...127]

These parameters specify the effect type for master effect 2, its on/off status, and the return level from master effect 2 to the L/R bus. For more information, please see “MFX1:” above.

MFX2 cannot use double-size effects (172–193).

Additionally, if you select a double-size effect for MFX1, you won’t be able to use MFX2.

Chain:

Chain On/Off [Off, On]

On (checked): Chain (series connection) will be turned on for MFX1 and MFX2.

Chain Direction [MFX1...MFX2, MFX2...MFX1]

Specifies the direction of the connection when MFX1 and MFX2 are chained.

MFX1→MFX2: Connect from MFX1 to MFX2.

MFX2→MFX1: Connect from MFX2 to MFX1.

Chain Level [000...127]

When chain is On, this sets the level at which the sound is sent from the first master effect to the next master effect.

If you select a double-size effect, the **Chain** settings will be ignored.

9-1b: TFX

These are the parameters for the total effect, which is placed at the final stage of the L/R bus. After passing through the total effect, the sound is output to AUDIO OUTPUT L/ MONO and R.

For the total effect, the direct sound (Dry) is always stereo-in/out. The input/output configuration of the effect sound (Wet) will depend on the selected effect type.

The total effect is stereo-in and stereo-out, but the output may be monaural depending on the type of effect you select.

For more information, please see “In/Out” on page 240.

TFX:

TFX [000...171]

This selects the effect type for total effect.]

TFX cannot use double-size effects (172–193).

Category/TFX Select menu

When you press the popup button, the Category/TFX Select menu will appear, letting you choose effect types by category. Use the tabs to select an effect category in the

menu, and then choose an effect within that category. Press the OK button to execute your choice, or press the Cancel button to cancel.

TFX On/Off [Off, On]

This turns total effect on/off. If this is off, the input will be passed directly through. The setting will alternate between on/off each time you press this.

Tip: An easy way to disable the total effect is to turn off the front panel TOTAL FX button. TFX will be temporarily disabled, and will stay off even if you switch programs or modes. When you turn the switch on, the total effect will be enabled, and you will obtain the effect specified by the program or combination.

Note: The TOTAL FX button is linked with Global P0-1 Effect Global SW Enable TFX (see p.5).

MIDI Alternatively, you can send control change #95 to turn the total effect off. A value of 0 turns the total effect off, and values of 1–127 restore the original setting. The global MIDI channel specified by **MIDI Channel** (Global 1–1a) is used for this message.

9–1c: Master Volume

Master Volume [000...127]

This specifies the final level of the audio output that has passed through total effect, and output from AUDIO OUTPUT L/MONO and R.

✓ **9–1: Menu Command**

- 0: **Write Program** see p. 64
- 1: **Exclusive Solo** see p. 64
- 2: **Auto Song Setup** see p. 65
- 3: **Copy MFX/TFX** see p. 67
- 4: **Swap MFX/TFX** see p. 67
- 5: **Write FX Preset** see p. 67

For more information, please see “Program: Menu Command” on page 64.

9–2: MFX1

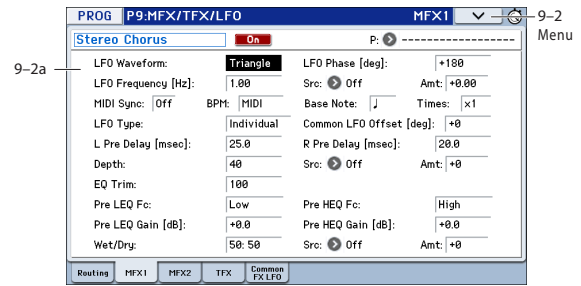

9–2a: MFX1

Here you can edit the parameters of the effect you choose for MFX1 in the P9: MFX/TFX/LFO– Routing page.

MIDI Effect dynamic modulation (Dmod) is controlled on the global **MIDI Channel** (Global 1–1a). For more information, please see “Dynamic Modulation Source List” on page 346.

MFX1 On/Off [Off, On]

This turns master effect 1 on/off. It is linked with the on/off setting in the P9: MFX/TFX/LFO– Routing page.

The setting will alternate between On and Off each time you press this.

MIDI Alternatively, you can use CC#94 to turn Master effects 1/2 off. CC#95 will turn the Total effect off. A value of 0 is Off, and a value of 1–127 selects the original setting. This is controlled on the global MIDI channel specified by **MIDI Channel** (Global 1–1a).

P (Effect Preset) [P00, P01...15, U00...15, -----]

This selects the effect preset. For more information, please see “P (Effect Preset)” on page 60.

MFX1 Parameters

Here, you can edit the parameters of the master effect selected in the P9: MFX/TFX/LFO– Routing page.

For details on the master effects, please see “Master Effects (MFX1, 2)” on page 245.

✓ **9–2: Menu Command**

- 0: **Write Program** see p. 64
- 1: **Exclusive Solo** see p. 64
- 2: **Auto Song Setup** see p. 65
- 3: **Copy MFX/TFX** see p. 67
- 4: **Swap MFX/TFX** see p. 67
- 5: **Write FX Preset** see p. 67

For more information, please see “Program: Menu Command” on page 64.

9–3: MFX2, 9–4: TFX

These pages let you edit the parameters of Master Effect 2 and Total Effect. To select different effects types, use the P9: MFX/TFX/LFO– Routing page.

The parameters for MFX2, TFX is the same as for MFX1. For more information, please see “9–2: MFX1” on page 62.

9–5: Common FX LFO

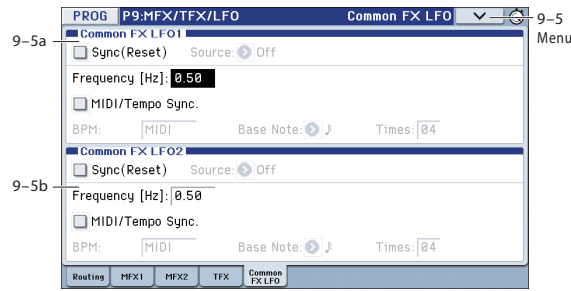

The two Common FX LFOs allow you to synchronize LFO-based modulation for multiple effects, such as phasers, flangers, filters, and so on.

The Common LFOs control only the frequency, MIDI synchronization, and reset options; each individual effect still has its own settings for the LFO waveform and phase. Within the individual effects, you can choose whether to use one of the Common LFOs, or to use the individual effect's frequency, sync, and/or reset settings instead. This is done via the effect's **LFO Type** parameter; select **Individual** to use the effect's settings, or **Common 1** or **2** to use the Common LFOs.

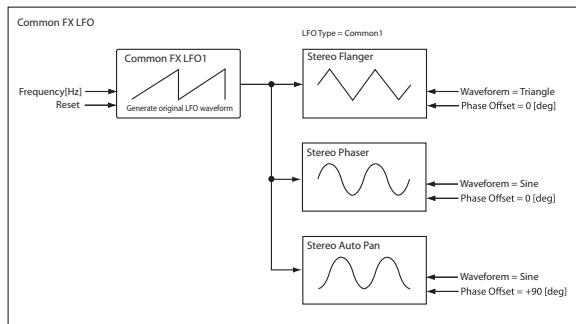

MIDI Dmod (Dynamic Modulation) is controlled on the global MIDI channel specified in Global mode P1.

9–5a: Common FX LFO1

Sync (Reset) [Off, On]

This specifies whether the Common FX LFO will be reset.

If this is on, operating the **Source** (below) will reset the phase of the LFO.

Source (Dmod Source) [List of Dmod Sources]

If **Sync (Reset)** is on, this selects the Dmod source that will reset the Common LFO. For a complete list of Dmod sources, please see “Dynamic Modulation Source List” on page 346.

MIDI This will be off when the modulation source specified by **Source** has a value below 64, and on when the value is above 64. The LFO will be reset when this value rises from a level below 64 to a level higher than 64.

Frequency [0.02...20.00 (Hz)]

This specifies the frequency of the Common FX LFO. Higher values make the LFO faster.

MIDI/Tempo Sync [Off, On]

Off (unchecked): The speed of the Common FX LFO will be determined by the **Frequency** setting.

On (checked): The speed of the Common FX LFO will be determined by the **BPM**, **Base Note**, and **Times** settings (see below).

BPM [MIDI, 40.00...300.00]

Base Note [Musical notation]

Times [01...32]

The frequency of the Common FX LFO will be the length of the **Base Note** note value multiplied by the **Times** value, relative to the tempo specified by the **BPM** value. If **BPM** is set to **MIDI**, this will operate according to the **Tempo** (Prog 0–1a) setting. If **MIDI Clock** (Global 1–1a) is set to **External**, this will follow the MIDI clock of the master device.

9–5b: Common FX LFO2

The parameters are identical to those for Common FX LFO1, as described under “9–5a: Common FX LFO1” above.

✓ 9–5: Menu Command

- 0: **Write Program** see p. 64
- 1: **Exclusive Solo** see p. 64
- 2: **Auto Song Setup** see p. 65
- 3: **Copy MFX/TFX** see p. 67
- 4: **Swap MFX/TFX** see p. 67

For more information, please see “Program: Menu Command” on page 64.

Program: Menu Command

ENTER + 0–9: shortcuts for menu commands

Each page has a set of menu commands, which provide access to different utilities, commands, and options, depending on the page you're currently on. You can use the menu commands entirely from the touch-screen, by pressing the menu button in the upper right-hand corner of the screen and then selecting an option from the menu that appears.

Even though each page may have its own unique menu commands, the menus are standardized as much as possible. For instance, WRITE is almost always the first menu item in Program, Combination, and Sequencer modes.

You can take advantage of this standardization by using a shortcut to access any of the first ten menu items:

1. Hold down the ENTER button.
2. Press a number (0–9) on the numeric keypad to select the desired menu command, starting with 0.

For instance, press 0 for the first menu command, 1 for the second, and so on.

If the menu command just toggles an option on and off (such as Exclusive Solo), then you're done. If the command calls up a dialog box, the dialog will appear on the display, and you can proceed just as if you'd selected the command from the touch-screen.

Tip: While this command is open, the ENTER button will operate as the OK button and the EXIT button will operate as the Cancel button.

Procedure for menu commands

1. Select the menu command.
 2. Make settings in the dialog box.
- For details on the content of each dialog box, refer to the explanation of each command.
3. To execute, press the OK button. To cancel without executing, press the Cancel button.

Write Program

This command writes an edited Program into the KROME internal memory. It is available on every page in Program mode.

Write Program lets you:

- Save your edits
- Rename the Program
- Assign the Program to a Category
- Copy the Program to a different Bank and number

 Be sure to **Write** any Program that you wish to keep. An edited Program cannot be recovered if you do not write it before turning off the power or selecting another Program.

Note: You can also access and execute this command by pressing the WRITE button.

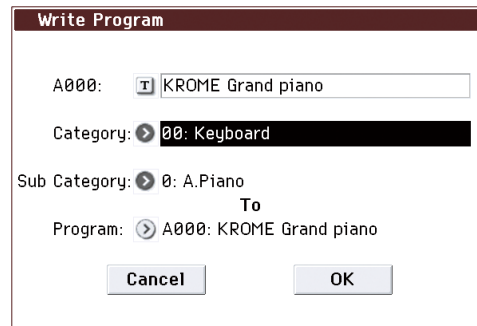

1. The upper line of the dialog shows the Bank, number, and Program name.

If you wish to modify the program name, press the text edit button to move to the text edit dialog box, and enter the desired program name.

2. In Category and Sub Category, specify the category of the program that you are writing.

The category can be used to find this Program when selecting a program in Program, Combination, or Sequencer modes.

Note: You can edit these category names in the Global P4: Category page. For more information, please see “4–1: Program Main” and “4–2: Program Sub” on page 204.

3. Press “To Program” to specify the destination Bank and number.

You can also use the BANK A–F buttons to select a bank.

You cannot save to banks G–g(d). If you've edited a program from banks G–g(d) and want to save it, save the edited program to a bank A–F.

Exclusive Solo

The behavior of the Solo function will alternate each time you select **Exclusive Solo**.

The Solo function can operate in one of the following two ways.

• Multiple Solo

The specified OSC1, OSC2, or drum track will be soloed. The solo on/off setting will alternate each time you press the Solo button.

• Exclusive Solo

Only one source - OSC1, OSC2, or the drum track - will be soloed.

Note: Solo operations can be performed in the P0–3: Mixer & Drum Track page of each mode.

Note: The Solo function applies to each mode. All sources are handled as a single group. In the case of Exclusive Solo, all other sources will be off if even one source is being soloed.

1. Use the menu to select Exclusive Solo.

When you select this item, a check mark will be added at the left of **Exclusive Solo** in the menu. The check mark will appear or disappear each time you select this item.

No check mark: Multiple Solo

Check mark: Exclusive Solo

Alternatively, you can turn this setting on/off by holding down the ENTER button and pressing numeric key 1.

Auto Song Setup

This command automatically copies the settings of the program or combination to a song, and enables the record-standby condition (See “Tip: Auto Song Setup” on page 2.).

Note: You can also access and execute this command by pressing the REC (●) button.

Copy Tone Adjust

Tone Adjust tab of the play page.

This command replaces the current Tone Adjust settings with those of any other Program, Combination Timbre, or Song Track.

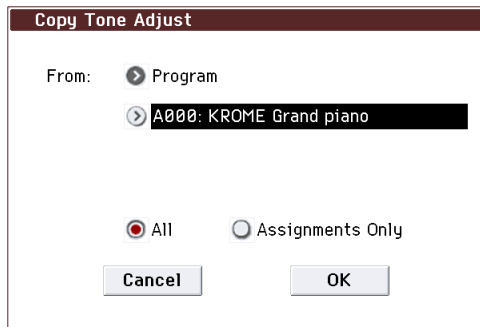

1. Use the **From** field to select the copy-source mode, bank, and number.

You can use the front-panel BANK buttons to select the desired bank.

2. In the **Timbre** field (if you’ve selected a **Combination**) or **Track** field (if you’ve selected a **Song**), select the **Timbre** or **Track** to copy from.
3. Select either **All** or **Assignments Only** to specify the Tone Adjust parameters you want to copy.

All: This copies both the Tone Adjust parameter assignments and values.

Assignments Only: This copies only the Tone Adjust parameter assignments, without the values.

Reset Tone Adjust

Tone Adjust tab of the play page.

This command resets the Tone Adjust settings for all of the displayed Switches and Sliders to their default values.

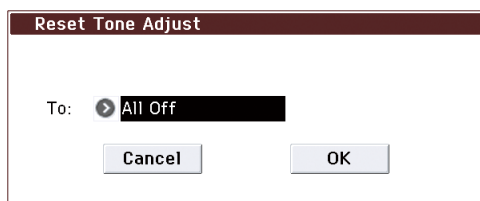

1. Use the **To** field to specify how the Switches 1–8 and Sliders 1–8 parameters will be reset.

All Off: All will be reset to Off.

Default Setting: The parameters will be reset to the default values.

Copy Oscillator

Copy Oscillator is available on all of the tabs under the OSC/Pitch, Filter, Amp/EQ, AMS/Common KeyTrack pages.

This command is used to copy the settings from one oscillator to another.

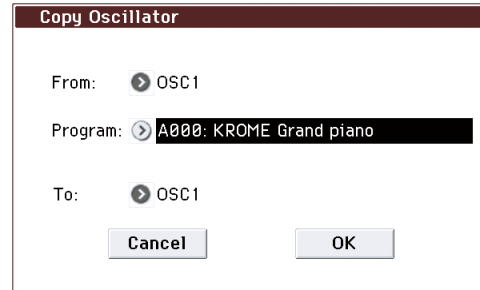

1. Use the **From** field to select the oscillator that you want to copy.
2. Use **Program** to select the bank and number of the copy-source program.

You can press a BANK SELECT button to select the desired bank.

3. In **To**, specify the copy destination oscillator.

Swap Oscillator

Swap Oscillator is available on all of the tabs under the OSC/Pitch, Filter, Amp/EQ, AMS/Common KeyTrack pages.

This command exchanges the settings of oscillators 1 and 2.

Note: This can be selected only if **Oscillator Mode** (Prog 1–1a) is **Double** or **Double Drums**.

Copy Drum Track

Copy Drum Track is available on the DrumTrk Pattern tab or DrumTrk Program tab of the ARP/DT page.

This command copies settings from the specified program, combination/timbre, or song.

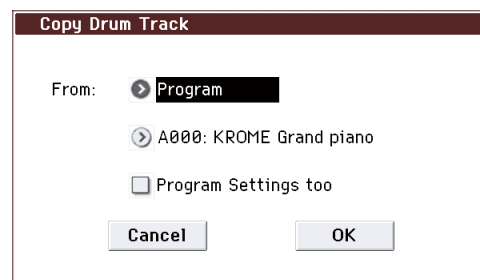

1. Use the **From** field to select the mode, bank, and number of the desired copy-source. You can press a BANK button to select the desired bank.
2. If you execute this command in **Program** mode, and select **Program** in **From**, the additional field **Program Settings too** will appear.

On (checked): The parameter settings of the Drum Track Pattern page and Drum Track Program page will be copied.

Off (unchecked): The parameter settings of the Drum Track Pattern page will be copied.

If you execute this command in **Combination** or **Sequencer** mode, the parameter settings of the Drum Track Program page will be copied. However, the **MIDI Channel** setting will not be copied.

Erase Drum Track Pattern

Erase Drum Track is available on the DrumTrk Pattern tab or DrumTrk Program tab of the ARP/DT.

This erases the drum track pattern you specify.

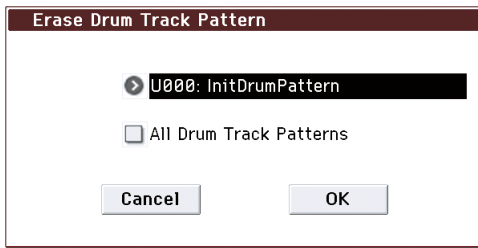

1. Select the user drum track pattern you want to erase.
2. If you check All Drum Track Patterns, all user drum track patterns will be erased.

Sync Both EGs

Sync Both EGs is available on the Filter 1/2 EG and Amp 1/2 EG pages.

This option allows you to edit the EGs of Oscillator 1 and Oscillator 2 together. When it is checked, editing the Filter EG of either Oscillator 1 or 2 will change both Filter EGs simultaneously. Similarly, editing the Amp EG of either Oscillator will change both Amp EGs.

This option is available when the Oscillator Mode is set to Double or Double Drums.

1. Select Sync Both EGs.

The display will indicate "SYNC BOTH EG's" and the two EGs will be synchronized.

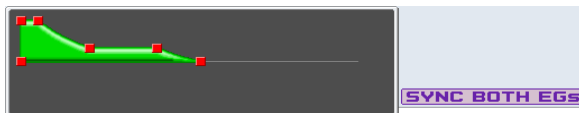

2. If you no longer want the EGs to be synchronized, select Sync Both EGs once again.

The indication will disappear from the display.

Swap LFO 1&2

Swap LFO 1 & 2 is available on all of the LFO pages, except for the Common LFO tab.

This command copies the settings of LFO1 to LFO2, and vice-versa.

Note: If LFO2 is being used to modulate LFO1, this command will erase that modulation routing.

Copy Arpeggiator

Copy Arpeggiator is available on the Arp A tab and Arp B tab of Play/REC Control page or Setup tab, Arp A tab, Arp B tab, Scan Zone tab of the ARP/DT page.

This command can be used to copy arpeggio settings from another location to the current program.

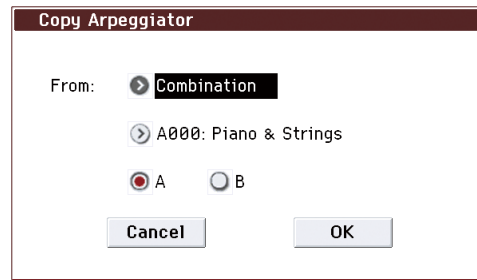

1. Use the From field specify the source of the arpeggio settings (mode, bank, number) that you wish to copy.
2. If you are copying from Combination, or Song, specify whether you wish to copy from A or B.

Copy Insert Effect

Copy Insert Effect is available on all of the IFX pages.

This command copies effects settings from within the current Program, from other Programs, Combinations, or Songs.

To execute the Copy Insert Effect command, press the OK button. To cancel, press the Cancel button.

⚠ If you're copying from a master effect, the result will not be identical due to differences in the routing and level settings of the master effects.

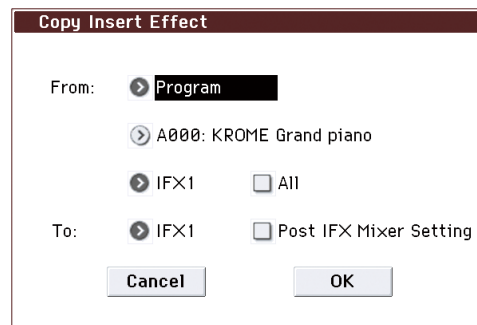

From (Mode) [Program, Combination, Song]

This selects whether you'll copy from a Program, a Combination, or a Song.

From (Bank and Number) [Bank and Number]

For Programs and Combinations, this selects the Bank and Number from which to copy. When this parameter is selected, you can also use the front-panel BANK buttons to select Banks.

(Effects slot select) [IFX 1...5, MFX 1&2, TFX]

Select which of the effects you wish to copy.

You can also copy from a master effect and total effect.

All [check-box]

When this is enabled, the settings of all insert effects (the contents of the Insert FX page and the effect parameters of IFX1-5, but not Ctrl Ch) will be copied.

To [IFX 1...5]

This selects the insert effect copy destination.

Post IFX Mixer Settings [check-box]

When this is checked, the Pan, Bus (Bus Select), Ctrl (FX Control Bus), and Sends 1 and 2 settings that follow the copy source insert effect will also be copied.

When this is not checked, only the effect type and its parameters will be copied.

Copying 000: No Effect

Copying a single effect set to "000: No Effect" will not work: no data will be copied.

If either **All** or **All used** is selected, and "000: No Effect" exists within a chain, it will be copied. However, if the entire chain consists of "000: No Effect," nothing will be copied.

Swap Insert Effect

Swap Insert Effect is available on all of the IFX pages.

This command exchanges the effects, and their internal parameters, between two IFX slots.

All of the parameters shown on the IFX 1–5 pages will be copied.

Other IFX slot parameters will not be affected, including Pan, Sends 1 and 2, Chain, AUX Bus, and FX Control Bus.

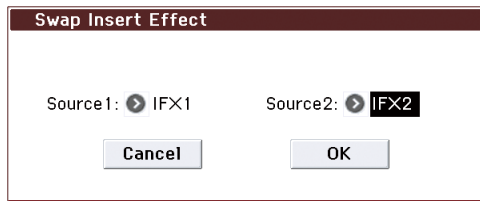

1. In Source 1 and Source 2, select each of the insert effects that you wish to swap.

Copy MFX/TFX

Copy MFX/TFX is available on all of the MFX/TFX/LFO pages.

This command lets you copy any desired effect settings from Program, Combination, or Song.

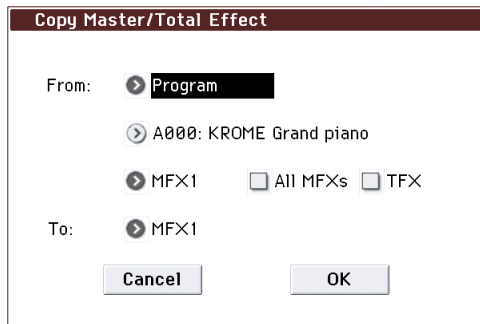

1. Use the From field to select the copy source mode, bank, and number.

You can also use the BANK buttons to select the desired bank.

2. Select the effect that you want to copy.

You can copy from an insert effect by selecting IFX1–5.

If you copy from an insert effect, the result may not be exactly the same, due to differences in routing and level settings.

If you select MFX1 or MFX2, the **Return** level will be copied at the same time.

You can copy settings from a total effect by selecting TFX.

If you check **All MFXs**, all master effect settings will be copied.

If you check **TFX**, all total effect settings will be copied. Master Volume settings will not be copied.

3. In To, specify the copy destination master effects or total effect.

Swap MFX/TFX

Swap MFX/TFX is available on all of the MFX/TFX/LFO pages.

This command swaps (exchanges) settings between MFX1, MFX2, TFX.

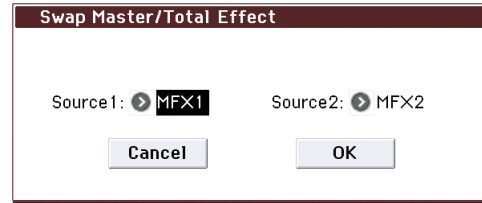

1. Use Source 1 and Source 2 to select the master effect(s) or total effect(s) that you want to swap.

Write FX Preset

Write FX Preset is available on all of the effects parameter editing pages, including IFX 1–5, MFX 1 and 2, and TFX.

This command saves the edited effect into the KROME's internal memory.

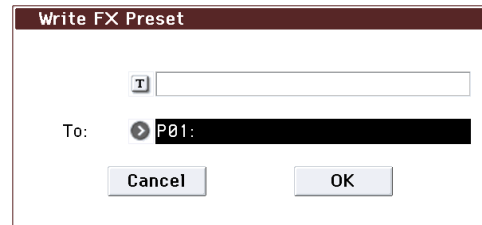

1. Press the text edit button to open the text edit dialog box, and input a name for the effect preset.
2. Use the To field to select the writing destination. We recommend that you use U00–U15.

Combination mode

COMBI Page Select

You can use the following ways to select the pages in Combination mode.

1. Press the PAGE button to access “Page Select.”

Alternatively, press the mode button on the upper left side of the display, and then press the right side of the menu.

“Page Select” shows an abbreviated name for each page.

The page in which you were prior to pressing the PAGE button is shown in light blue.

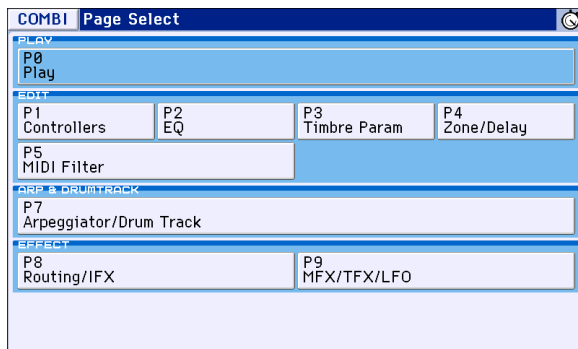

2. Select the desired page in the display.

Other ways to select pages

- Hold down the PAGE button and press a numeric key, 0–9, to specify a page number; you will move to the corresponding page.
For example if you want to access the P3: Timbre Param page, hold down the PAGE button and press numeric key 3.
- Pressing the EXIT button will take you to the P0: Play page. If a page other than the Program T01–08 page is selected, pressing the EXIT button will take you to the Program T01–08 page.

| | Page | Main content |
|------------------|----------------------------|--|
| PLAY | P0: Play | Select and play combinations. (see p.70) Program selection for each timbre. (see p.71) Pan and volume settings etc. for each timbre. (see p.73) Simple arpeggiator editing. (see p.74) Editing from the Tone Adjust (see p.75) |
| | P1: Controllers | SW1, 2, and knob function settings. (see p.78) |
| EDIT | P2: EQ | EQ settings for each timbre. (see p.79) |
| | P3: Timbre Param | Various parameter settings for each timbre (MIDI channel, OSC selection, Pitch setting, etc.) (see p.81) |
| | P4: Zone/Delay | Key split and layer settings. (Key zone and velocity zone) (see p.84) Time delay from note-on to beginning of sound. (see p.86) |
| | P5: MIDI Filter | MIDI transmit/receive filter settings. (see p.87) |
| ARP & DRUM TRACK | P7: Arpeggiator/Drum Track | Arpeggiator settings. (see p.92) Drum track settings. (see p.93) |
| EFFECT | P8: Routing/IFX | Oscillator output bus and master effect send level settings. (see p.95) Insert effect routing, selection, and settings. (see p.97) |
| | P9: MFX/TFX/LFO | Master effect routing, selection, and settings. (see p.99) Total effect selection and settings. (see p.100) Common FX LFO settings (see p.100) |

COMBI P0: Play

This is the main page of Combination mode. Among other things, you can:

- Select combinations
- Select a program for each timbre, and specify its Play/ Mute and Solo On/Off status.
- Edit the Arpeggiator in simple ways
- Use the Tone Adjust function to make simple edits for program parameters

Tip: Auto Song Setup

The Auto Song Setup feature copies the current Program or Combination into a Song, and then puts the KROME in record-ready mode.

If inspiration for a phrase or song strikes you while you're playing, you can use this function to start recording immediately.

For more information, please see "Auto Song Setup" on page 106.

0-1: Program T01-08, 0-2: Program T09-16

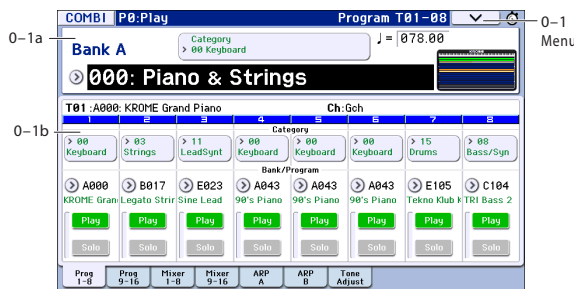

This is the main page for selecting and playing Combinations. You can also set the Program, Play/Mute, and Solo On/Off for each of the Timbres 1-8 and 9-16.

0-1(2)a:Combination Select

Bank [A...D]

This indicates the currently selected combination bank.

- Press one of the BANK A-D buttons to select the desired bank.

Each bank contains rewritable combination program areas for 128 combinations (a total of 512).

| Bank | No. | Description |
|---------|-----------|------------------------|
| A, B, C | 000...127 | Preloaded combinations |
| D | 000...127 | User combinations |

Note: Pressing one of the BANK A-F buttons while the **Program Select** parameter is selected will change the timbre program bank (rather than the combination bank).

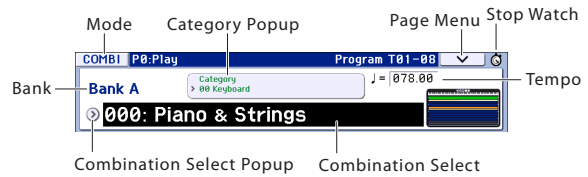

Combination Select [000...127]

Here you can select the desired Combination.

To switch combinations

- Choose **Combination Select**, use numeric keys 0-9 to input the desired combination number, and press the ENTER button.
- Choose **Combination Select** and turn the VALUE dial or use the INC/DEC buttons.
- If the "0-1a: Combination Select" parameter is selected, the BANK A-D buttons will switch combination banks.
- Press the Combination Select Popup to view and select from the Bank/Combination Select menu organized by bank.
- Press the Category Popup to view and select from the Category/Combination Select menu organized by category.
- You can use a foot switch to select combinations. For more information, please see the Global parameter "Foot Switch Assign" on page 202. For a list of the functions that can be assigned to the footswitch, please see "Foot Switch Assignments" on page 349.
- You can transmit MIDI program changes from a connected external MIDI device.

Bank/Combination Select menu:

1. Press the popup button located at the left of "Combination Select" to access the Bank/Combination Select menu.
2. Press one of the tabs at left or right to select a bank.
3. Select a combination from the list. You can directly press your choice within the list, or use the INC/DEC buttons.

If the screen cannot display all of the available items, use the scroll bar.

Note: If you want to search for a sound by its combination name, use the Find function (see p.2).

4. Press the OK button to execute, or press the Cancel button to cancel your selection.

Bank/Combination Select menu

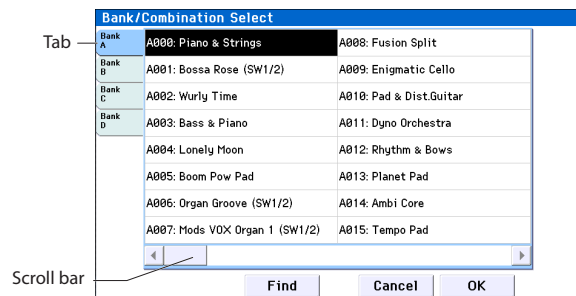

Category [00...17/00...07]

Here, you can select the combination category.

All programs are classified using eighteen main categories and eight sub-categories. You can select a category, and then select a combination within that category. When you press the popup button, the Category/Combination Select menu will appear.

Category/Combination Select menu:

You can select combinations by category and sub-category. All combinations are organized into up to eighteen categories, and each category is further organized into eight sub-categories. You can use these categories and sub-categories to select combinations.

1. Press the Category popup button (above the Combination Select parameter) to open the Category/Combination Select menu.

2. Press one of the tabs on the left and right to select the desired category.

Note: You cannot select the category tab of a category to which no combinations have been assigned.

3. Select a combination from the list. You can directly press your choice within the list, or use the INC/DEC buttons.

If there are more combinations than can be shown in the screen, use the scroll bar to see the remaining combinations.

Note: If you want to search for a sound by its combination name, use the Find function (see p.2).

Category/Combination Select menu

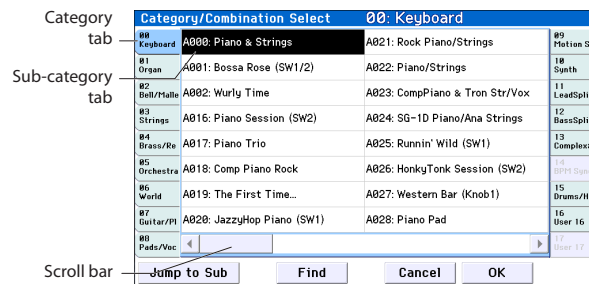

4. To select from a sub-category, press the Jump to Sub button to access SubCategory/Program Select.

Press one of the left tabs to select a sub-category.

Note: Sub-categories not assigned to any programs cannot be selected from the tabs.

Press the OK button to confirm your selection, or press the Cancel button to cancel it. You will return to the main categories.

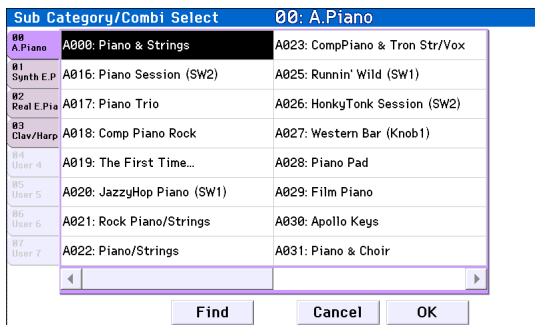

5. Press the OK button to execute, or press the Cancel button to cancel your selection.

Note: The category of each combination can be specified in the "Write Combination" dialog box.

Tempo [40.00... 300.00, EXT]

This is the tempo for the current Combination, which applies to tempo-synced LFOs and effects, arpeggiator, and tempo-synced effects.

040.00...300.00 allow you to set a specific tempo in BPM, with 1/100 BPM accuracy. In addition to using the standard data entry controls, you can use the TEMPO knob to adjust the bpm, or just play a few quarter-notes on the TAP button.

If MIDI Clock (Global 1-1a) is set to External MIDI or External USB, EXT is shown. This is also shown if MIDI Clock is Auto and MIDI clock data is being received from an external device. If tempo is EXT, arpeggiator etc. will synchronize to MIDI clock data from an external MIDI device. For more information, please see "MIDI Clock (MIDI Clock Source)" on page 199.

Mode, Stop Watch

See "a: Mode button" on page 4 of the Operation guide.

See "l: Stopwatch button" on page 5 of the Operation guide.

0-1(2)b: Timbre Program Select

Selected Timbre Info

This area shows information on the timbre selected for editing. T: Timbre number/program bank/number/name, Ch: MIDI channel/number.

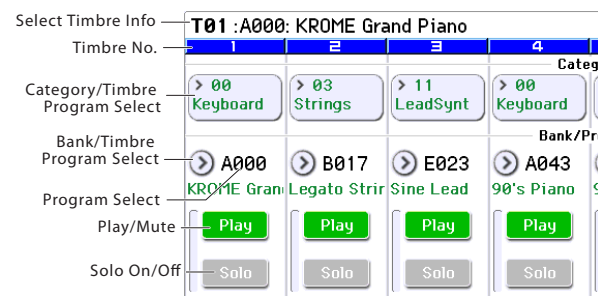

Timbre Number

This indicates the timbre number. Below each timbre number are shown various parameters which you can edit for that timbre.

Timbre 01 (Timbre Number):

Category (Timbre Program) [00...17/00...07]

Here, you can select the program used by each timbre by program category and sub-category. All programs are organized into up to eighteen categories and eight sub-categories.

Press this popup button to get the Category/Timbere Program Select menu, then select the desired category and sub-category, and finally select the desired program.

Category/Timbre Program Select menu:

Here you can select the program for each timbre by main category and sub-category. All programs are classified into a maximum of eighteen main categories, and each category is classified into eight sub-categories. You can select programs using these main categories and sub-categories.

• Press Category and use the Category/Timbre Program Select menu to select a program.

For the procedure, please see "Category/Combination Select menu:" above.

Program Select

[A...F: 000...127, GM, g(1)...g(9), g(d): 001...128]

Here, you can select the program used by each timbre. The lower line displays part of the program name.

To switch the program of a timbre

- Choose **Program Select**, use numeric keys 0–9 to input the program number, and press the ENTER button.
- Choose **Program Select** and turn the VALUE dial or use the INC/DEC buttons.
- If the **Program Select** parameter is chosen, the BANK A–F buttons will switch program banks. (If Timbre Program Select is selected, the BANK button LED of the program bank selected for that timbre will light up.) You can use the numeric keys to switch the GM bank (see p.2).
- From the Bank/Program Select menu you can view and select programs arranged by bank.
- From the Category/Program Select menu you can view and select programs by category.
- You can choose a program by transmitting MIDI program changes from a connected external MIDI device.

MIDI The KROME's combinations and timbre programs can be switched from an external MIDI device by using MIDI bank select and MIDI program change messages. By default, the combination bank and number will change when a bank select or program change message that matches the KROME's global MIDI channel is received. (Global MIDI channel; see p.198 Global 1-1a "MIDI Channel (Global MIDI Channel)") However, if the channel of the incoming message is different than the KROME's global MIDI channel, the program bank and number will change only for timbres that match the MIDI channel of the message.

Tip: Even for the global MIDI channel, you can change the setting from the default so that the timbre program rather than the combination will be switched. (see p.201 Global 1-2b MIDI Filter "Combination Change")

Tip: Switching the timbre program in response to MIDI reception can be disabled for specific timbres. (see p.87 MIDI Filter 5-1c/5-2c "Enable Program Change")

MIDI When you switch combinations by operating the KROME, the bank and number of the combination you select are transmitted as bank select and program change messages on the global MIDI channel. At this time, if any of the timbres have the timbre status EXT or EX2, the bank and number of their timbre programs will be transmitted as bank select and program change messages on the timbre channel. (Timbre Status; see p.81 Timbre Param 3-1c/3-2c "Status")

Bank/Timbre Program Select menu:

- Press the popup button located at the left of **Program Select**, and choose a program from the Bank/Program Select menu.

For the procedure, please see "Bank/Program Select menu:" on page 2.

Play/Mute

[Play, Mute]

This setting mutes a timbre.

Play: The timbre will produce sound.

Mute: The timbre will be muted (silent).

Solo On/Off

[On, Off]

Turns the Solo function on/off for each timbre.

The Solo function operates differently depending on the setting of the **Exclusive Solo** menu command.

If **Exclusive Solo** is off, you can turn Solo on for more than one timbre. The setting will alternate each time you press the Solo On/Off button.

If **Exclusive Solo** is on, pressing a Solo button will turn Solo on for only that timbre.

Note: The Solo On/Off status is not preserved when you write the combination.

Exclusive Solo

The menu's **Exclusive Solo** parameter also affects the way that Solo works. When **Exclusive Solo** is Off (unchecked), you can solo multiple Timbres at once.

When **Exclusive Solo** is On (checked), only one Timbre can be soloed at a time. In this mode, pressing a Solo button automatically disables any previous solos.

Tip: You can also toggle **Exclusive Solo** by holding ENTER and pressing 1 on the numeric keypad.

Velocity Meter

This meter shows the note-on velocity value.

- This indicates the note-on velocity values on the MIDI channel of each timbre, produced by the keyboard, MIDI IN, arpeggiator, or drum track. (If multiple note-on messages are received simultaneously, the highest velocity will be displayed.)
- The meter will respond even if Key Zone or Vel Zone settings are set so that the note does not actually sound.
- This meter indicates the note-on velocity value; it does not respond to changes in the Volume knob setting, nor to changes in the level of the audio signal produced by the Filter, Amp, EG, LFO, EQ, or effects.

Timbre 02...08, 09...16 (Timbre Number):

Here you can specify the program, Play/Mute status, and Solo On/Off status for timbres 2–8 and 9–16. These are the same as for timbre 01. For more information, please see "Timbre 01 (Timbre Number):" above.

✓ 0–1(2): Menu Command

- 0: **Write Combination** see p. 101
- 1: **Exclusive Solo** see p. 64
- 2: **Auto Song Setup** see p. 65
- 3: **Copy from Program** see p. 101

For more information, please see "Combination: Menu Command" on page 101.

0-3: Mixer T01-08, 0-4: Mixer T09-16

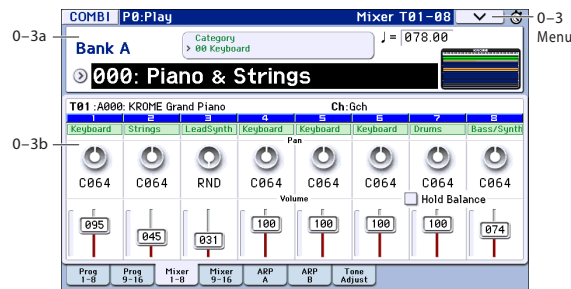

This is the main page for selecting and playing Combinations.

You can also set the pan, and volume for each of the Timbres 1-8 and 9-16. For more information, please see "0-1: Program T01-08, 0-2: Program T09-16" on page 70.

0-3(4)a: Combination Select

For more information, please see "0-1(2)a: Combination Select" on page 70.

0-3(4)b: Pan, Volume

Selected Timbre Info

This area shows information on the timbre selected for editing.

For more information, please see "0-1(2)b: Timbre Program Select" on page 71.

Timbre 01 (Timbre Number):

Category [Category Name]

This indicates the category.

Pan [RND, L001...C064...R127]

This specifies the pan of each timbre.

L001...C064...R127: A setting of L001 is far left and R127 is far right. A setting of C064 will reproduce the pan setting of the Program mode.

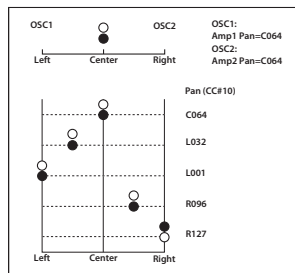
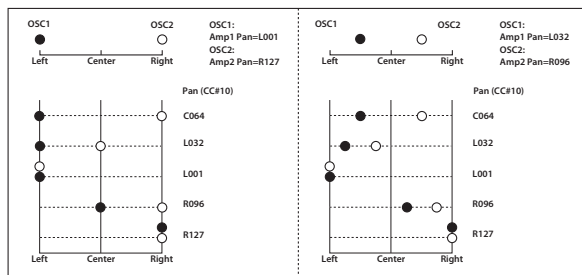

If a mono insert effect is in use, the settings you make here will be ignored. In this case, the **Pan: #8** parameter in P8:

Routing/IFX-Insert FX Setup page will adjust the panning of the sound after the insert effect ("Mixer" on page 243).

RND: The oscillator pan will change randomly at each note-on.

MIDI If **Status** (Combi 3-1(2)c) is set to INT, CC#10 (pan) messages can be received to control the setting. CC#10 values of 0 or 1 will place the sound at far left, 64 at center, and 127 at far right. (exclude RND) Pan can be controlled by messages received on the **MIDI Channel** (Combi 3-1(2)c).

Volume [000...127]

Adjusts the volume of each timbre 1-8.

MIDI The volume of each timbre is determined by multiplying this volume value with the MIDI volume (CC#7) and expression (CC#11).

If **Status** (Combi 3-1(2)c) has been set to INT, incoming MIDI CC#7 or CC#11 messages will control the volume of a timbre. (However these messages will not affect the setting of this parameter.)

If **Status** is EXT or EX2, the value of this parameter will be transmitted as MIDI CC#7 when the combination is changed. However this will not be transmitted by a timbre that is set to the same MIDI channel as the global MIDI channel. This message is transmitted on the **MIDI Channel** (Combi 3-1(2)c) specified for each timbre.

Hold Balance [Off, On]

On (checked): When any one of the volume sliders is moved, the volume of the other timbres will change as well. The volume balance of timbres 1-16 will be maintained. This is useful when you wish to adjust the overall volume.

Timbre 02...08 (Timbre Number):

Here you can specify the program etc. for each Timbre 2 through 8. These are the same as for timbre 01. For more information, please see "Timbre 01 (Timbre Number):" above.

0-3(4): Menu Command

- 0: **Write Combination** see p. 101
- 1: **Exclusive Solo** see p. 64
- 2: **Auto Song Setup** see p. 64
- 3: **Copy from Program** see p. 101

For more information, please see "Combination: Menu Command" on page 101.

0-5: ARPEGGIATOR A, 0-6: ARPEGGIATOR B

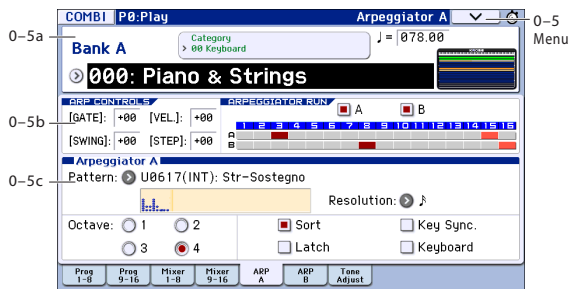

Here, you can make arpeggiator settings for the combination. A combination can run two arpeggiators simultaneously.

Arpeggiator parameters can be edited in P7: ARP/DT, but certain major parameters can be edited in these pages as well. You can edit these parameters in realtime, for example, by changing the arpeggio pattern while playing in Combi P0: Play.

You can also use the TEMPO knob and the arpeggio control (ARP) GATE knob, VELOCITY knob, SWING knob, and STEP knob to control the arpeggiator in realtime.

To save the edits you make, use **Write Combination**.

0-5(6)a: Combination Select, Tempo

Bank, Combination Number & Name

These are the bank, number, and name of the current Combination. Here, you can also select a combination.

For more information, please see "0-1(2)a: Combination Select" on page 70.

♪ (Tempo) [040.00...300.00, EXT]

For more information, please see "♪ (Tempo)" on page 71.

0-5(6)b: ARP Controls

This shows the value of each parameter for the ARP assignments of the REALTIME CONTROLS knobs.

[GATE] [-64...+00...+63]

[VEL. (Velocity)] [-64...+00...+63]

[SWING] [-64...+00...+63]

see p.6, p.54

[STEP] [-64...+00...+63]

see p.6

0-5(6)c: Arpeggiator Run A/B, Timbre assign

Arpeggiator Run A, B

When the ARP button is on, the arpeggiator(s) you checked here will run if they are assigned to a timbre by **Arpeggiator Assign** (7-1(2)c).

When the arpeggiator is on, these check boxes let you turn A and B on/off.

This parameter can also be set from P7: Arpeggiator/Drum Track page **Arpeggiator Run A, B**.

Timbre assign

This indicates the arpeggiator A and B assignment status for each timbre 1-8. These settings are made in **Arpeggiator Assign** (7-1(2)c).

0-5(6)d: Arpeggiator A (B)

Pat (Pattern) [P0...P4, U0000(INT)...U0899(INT), U0900(USER)...U1027(USER)]

Octave [1, 2, 3, 4]

Resolution [♪♩, ♪, ♫, ♪♩, ♪♩♩, ♪♩♩♩]

Sort [Off, On]

Latch [Off, On]

Key Sync. [Off, On]

Keyboard [Off, On]

Set the various parameters of the combination arpeggiator. For more information, please see "COMBI P7: ARP/DT (Arpeggiator/Drum Track)" on page 91.

These parameters can also be set from 7-3(4): Arpeggiator A(B) Setup.

✓ 0-5(6): Menu Command

- 0: **Write Combination** see p. 101
- 1: **Exclusive Solo** see p. 64
- 2: **Auto Song Setup** see p. 65
- 3: **Copy from Program** see p. 101
- 4: **Copy Arpeggiator** see p. 103

For more information, please see "Combination: Menu Command" on page 101.

0-7: Tone Adjust

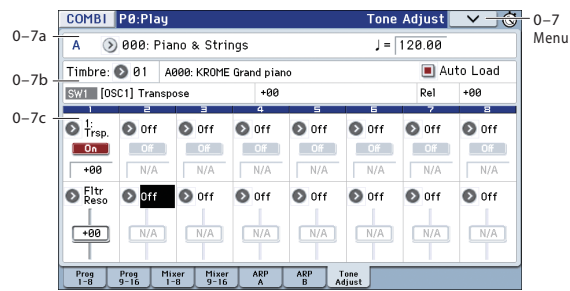

Tone Adjust provides two important features simultaneously:

- You can use the Tone Adjust parameters to edit the most important program parameters.
- It lets you modify Programs for use within a specific Combination including everything from subtle tweaks (like changing LFO speeds) to dramatic changes (such as selecting a different Multisample). Any changes that you make are stored with the Combination, and do not alter the original Program.

Each of the sixteen Timbres has its own set of tone adjust parameters.

For more information, see:

- “Absolute (Abs), Relative (Rel), Meta parameter” on page 7
- “Tone Adjust and MIDI SysEx” on page 7
- “Interaction between Tone Adjust and MIDI CCs” on page 8

Saving Tone Adjust Edits

In Program mode, when you make edits via Tone Adjust and then save the results, the Program data is changed just as if you'd edited the internal parameters directly. For more information, please see “Saving Tone Adjust Edits” on page 7.

In Combination mode, however, all Tone Adjust edits are stored within the Combination; the Program itself is not changed. This lets you alter the way that a Program sounds in one specific Combi without affecting the way that it sounds in Program mode, or in any other Combinations or Songs.

0-7a: Combination Select, Tempo

Bank, Combination Number & Name

These are the bank, number, and name of the current Combination. Here you can also select a combination.

For more information, please see “0-1(2)a: Combination Select” on page 70.

♩ (Tempo) [040.00...300.00, EXT]

For more information, please see “♩ (Tempo)” on page 71.

0-7b: Timbre select, Selected parameter information

Timbre select

Timbre [1...16]

This selects the timbre that will be controlled via the Tone Adjust parameters. You can switch back and forth between

the different timbres as much as you like, without losing your edits.

Auto Load (Auto Load PRG) [Off, On]

When you first load a Program into a Timbre, this parameter determines whether or not the Program's Tone Adjust settings will be loaded as well.

The parameter settings assigned to the sliders and switches in the display and the on/off settings assigned to the Absolute parameters will be loaded.

Once the Program has been loaded, you can change any or all of the Tone Adjust settings as desired, including both assignments and values. All such edits are stored in the Combination, without affecting the original Program.

If **Auto Load PRG** is **On**, Tone Adjust settings will be automatically loaded along with the Program.

If **Auto Load PRG** is **Off**, the Tone Adjust settings of the replacement program will not be loaded; the program settings prior to replacement will remain.

Selected parameter information

This status line shows detailed, read-only information about the currently selected Tone Adjust parameter.

| Control | Assignment | Value | Type | Stored Value |
|---------|------------------|-------|------|--------------|
| SW1 | [OSC1] Transpose | +12 | Rel | +00 |

Control [SW1...8, SL1...8]

This is the switch or slider in the display that is assigned to Tone Adjust parameters.

Assignment [List of Tone Adjust assignments]

This is the full name of the parameter assigned to the switch or slider in the display. You can change this using the “Assign” parameter, below.

Value

This shows the current value of the parameter. The range of values will vary depending on the parameter assigned to the switch or slider.

Type [Rel, Abs, Meta]

This shows the type of the parameter, which relates to how edits to the parameter are saved. For more information, please see “Absolute (Abs), Relative (Rel), Meta parameter” on page 7.

Stored Value

This shows the original value of the parameter, before the effects of Tone Adjust. It applies only to Tone Adjust parameters which control a single Program parameter.

If you un-assign a parameter from a control, it will revert to this value.

0-7c: Tone Adjust

Here, you can assign Tone Adjust parameters to the switches and sliders in the display.

Switches 1...8

Tone Adjust switches act a little differently than switches in the display.

When a switch is assigned to a **Relative** parameter, or an **Absolute** parameter with more than two states:

Switch On = **On Value** (see below)

Switch Off = the Program's stored value

When a switch is assigned to a two-state **Absolute** parameter, such as **Hold**, the switch status directly reflects the parameter value:

Switch On = **On**

Switch Off = **Off**

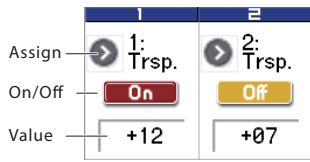

Assign

This assigns Tone Adjust parameters to the switches in the display. For a full list of the available choices, please see “Common Tone Adjust Parameters” on page 9 and “Tone Adjust Parameters” on page 10.

On Value [Depends on parameter]

The parameter is set to this value when the switch is On.

When the switch is assigned to a two-state **Absolute** parameter, such as **Hold**, this will always be the same as the **Switch Status** (see below).

Switch Status [Off, On]

This simply shows whether the switch is On or Off.

Sliders 1–8

Assign

This assigns Tone Adjust parameters to the sliders in the display. For a full list of the available choices, please see “Common Tone Adjust Parameters” on page 9 and “Tone Adjust Parameters” on page 10.

Assignments are exclusive

Per-Oscillator parameters apply to OSC1 and 2 individually, and are marked as such: OSC1 and OSC2.

Each slider can be assigned to only one parameter, and each parameter can be assigned to only one slider.

To swap a parameter from one slider to another, you’ll need to first un-assign it from the old slider, and then assign it to the new slider.

Value

This shows the current value of the parameter. The range of values will vary depending on the parameter assigned to the slider.

✓ **0–7: Menu Command**

- 0: **Write Combination** see p. 101
- 1: **Exclusive Solo** see p. 64
- 2: **Auto Song Setup** see p. 65
- 3: **Copy from Program** see p. 101
- 4: **Copy Tone Adjust** see p. 102
- 5: **Reset Tone Adjust** see p. 103

For more information, please see “Combination: Menu Command” on page 101.

Controls

REALTIME CONTROLS lets you use knobs [1]–[4] to modify the parameters of the combination or the effects. You can also use these knobs to control the arpeggiators. When you use a knob, the display will show the controller’s function and value. Use the SELECT button to change the knob functions.

In TONE, the functions assigned to knobs 1–4 are fixed.

In USER, you can assign a variety of modulation functions to knobs 1–4. To assign functions, use the P1: Controllers Setup page (page 78).

Realtime Controls AMSource

The Realtime Controls TONE knob functions (CUTOFF – EG RELEASE) are fixed. You can assign a variety of functions to Realtime Controls USER knobs 1–4 (USER [1]–USER [4]). MIDI control changes are assigned for each function.

When you move a knob, it sends out the corresponding MIDI CC.

MIDI This will control timbres on the global MIDI channel.

Most of these functions adjust (scale) the parameter settings of the timbre programs. Unless otherwise noted, “scaling” means that the parameters are at their programmed values when the controller is at 64, at their minimum when the controller is at 0, and at their maximum when the controller is at 127. For another look at this, please see the diagram below.

CC parameter scaling

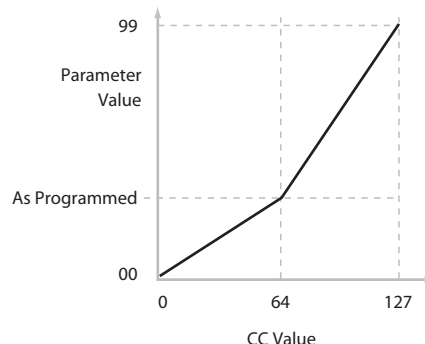

TONE [Cut Off]: Flt Fc (Cutoff) [000...127]

This knob scales the cutoff frequencies of Filters A and B, and transmits and receives MIDI CC #74.

TONE [RESONANCE]: Flt Reso (Resonance)

[000...127]

This knob scales the resonance of Filters A and B, and transmits and receives MIDI CC #71.

TONE [EG INTENSITY]: Flt EG (Filter EG Intensity)

[000...127]

This knob scales the effect of the Filter EG on the cutoff frequencies of Filters A and B. It also transmits and receives MIDI CC#79.

TONE [RELEASE]: EG Rel (EG Release) [000...127]

This knob scales the release time of the Filter and Amp EGs, and transmits and receives MIDI CC#72.

USER [1]...[4]

[000...127]

These are the current values and assigned functions (MIDI CC) for the Realtime Controls USER knobs.

In the P1: Controllers– Controllers Setup page you can assign a variety of modulation functions to Realtime Controls USER knobs 1–4.

Many of the functions scale a particular set of Program parameters. All of the settings also correspond to MIDI messages usually CCs.

Arpeggiator

Arpeggio control lets you use the four knobs to control the two arpeggiators in realtime.

The functions of knobs 1–4 are fixed. The knobs will control the duration of the arpeggiated notes, their velocity, the pitch range, and the length of the arpeggio pattern.

ARP [GATE] [-64...+00...+64]

Adjusts the duration (gate time) of the arpeggiated notes (See “Gate” on page 54).

ARP [VELOCITY] [-64...+00...+64]

Adjusts the velocity of the arpeggiated notes (See “Velocity” on page 54).

ARP [SWINGH] [-64...+00...+64]

Adjusts the degree of shuffle for the arpeggio pattern (See “Swing” on page 54).

ARP [STEP] [-64...+00...+64]

This affects the length and resolution of the arpeggio pattern.

Turning the knob toward the left will shorten the pattern’s length (**Length**) in units of one half. Turning the knob toward the right will shorten the interval between arpeggiated notes (**Resolution**) in units of one half. When the knob is in the center (12 o’clock), the number of steps and the speed will be as specified by the **Length** and **Resolution** (See “Resolution*” on page 54).

COMBI P1: Controllers

1-1: Controllers Setup

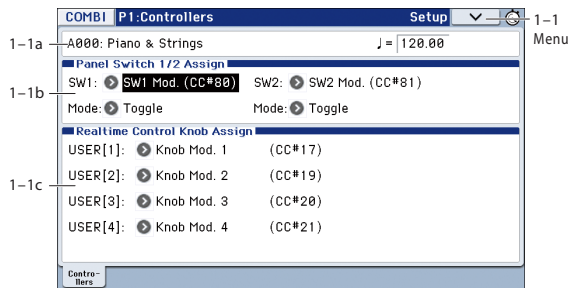

Here, you can assign the functions performed by SW1 and SW2, and by knobs 1-4 when Realtime Controls USER is selected.

Note: The Panel Switch Assign setting of the program assigned to each timbre will have no effect.

1-1a: Combination, Tempo

Bank, Combination Number & Name

These are the bank, number, and name of the current Combination.

For more information, please see "0-1(2)a: Combination Select" on page 70.

J (Tempo) [040.00...300.00, EXT]

For more information, please see "J (Tempo)" on page 71.

1-1b: Panel Switch 1/2 Assign

SW (SW1 Assign) [Off, ..., JS-Y Lock]

This assigns the function of SW1. For more information, please see "List of SW 1/2 assignments" on page 348.

Note: If you change the function setting, the status is reset to off.

Note: If the on/off status of the front panel SW1, SW2 switches is memorized when you save the combination.

Mode (SW1 Mode) [Toggle, Momentary]

This specifies the on/off operation when you press the SW1 switch.

Toggle: The state will alternate between On and Off each time you press the SW1 switch.

Momentary: The state will remain On only while you continue holding down the SW1 switch.

SW2 (SW2 Assign) [Off, ..., JS-Y Lock]

Mode (SW2 Mode) [Toggle, Momentary]

This assigns the function of SW2. The functions that can be assigned to SW2 are the same as for SW1, with the substitution of SW2 Mod. (CC#81) instead of the SW1's SW1 Mod. (CC#80).

1-1c: Realtime Controls Knob Assign

Here you can select the functions (mainly types of control change) that are assigned to knobs 1-4 when the SELECT button has selected USER (See "Realtime Controls Knobs 1-4 Assignments" on page 348)

The functions you assign here are active when you use the SELECT button to select USER, and operate knobs 1-4.

| | |
|-----------------|-------------------------|
| USER [1] | [Off, ..., MIDI CC#119] |
| USER [2] | [Off, ..., MIDI CC#119] |
| USER [3] | [Off, ..., MIDI CC#119] |
| USER [4] | [Off, ..., MIDI CC#119] |

✓ 1-1: Menu Command

- 0: Write Combination see p. 101
- 1: Exclusive Solo see p. 64
- 2: Auto Song Setup see p. 65
- 3: Copy from Program see p. 101

For more information, please see "Combination: Menu Command" on page 101.

COMBI P2: EQ

2-1: EQ Trim T01-08, 2-2: EQ Trim T09-16

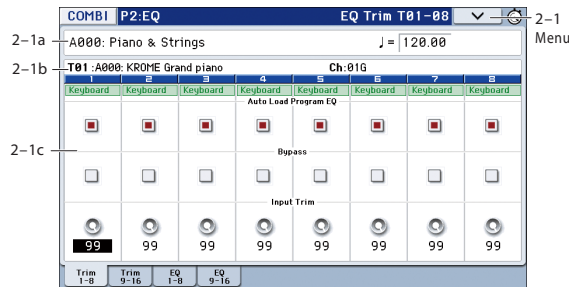

Here, you can set the signal level that enters the EQ of timbres 1-8 and 9-16.

2-1(2)a: Combination Name, Tempo

Bank, Combination Number & Name

These are the bank, number, and name of the current Combination.

For more information, please see “0-1(2)a: Combination Select” on page 70.

♪(Tempo) [040.00...300.00, EXT]

For more information, please see “♪(Tempo)” on page 71.

2-1(2)b: Timbre Info

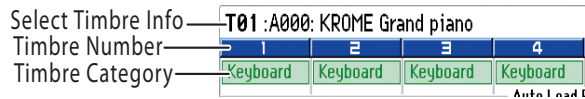

Selected Timbre Info:

This area displays information about the timbre selected for editing – T: timbre number/program bank/number/name, Ch: MIDI channel number.

Timbre Number:

This indicates the timbre number. The various parameters below each timbre number make settings for the corresponding timbre.

Timbre Category:

This shows the abbreviated category name of the Program assigned to the Timbre.

2-1(2)c: Trim

Timbre 01 (Timbre Number):

Auto Load Prog EQ

[Off, On]

When you first load a Program into a Timbre, this parameter determines whether or not the Program’s EQ settings will be loaded as well.

Once the Program has been loaded, you can change any or all of the EQ settings as desired. All such edits are stored in the Combination, without affecting the original Program.

Regardless of this setting, subsequent edits to the Program’s EQ in Program mode will not affect the Combination.

On (checked): When you switch the timbre’s program, the current EQ settings will be cleared, and the 3-band EQ values specified by the program will be loaded automatically. Normally you will leave this checked. The timbre’s program can be switched by using **Program Select** (Combi 0-1(2)b) or by receiving a MIDI program change.

You are free to edit the 3-band EQ settings that have been automatically loaded. Make adjustments for each timbre relative to the settings of the program, and then save the combination.

Off (unchecked): The Program’s EQ settings won’t be loaded. Use this if you’ve set up the EQ in a specific way, and then want it to stay unchanged while you try out different Programs.

Bypass

[On, Off]

If this is **On (checked)**, all of the EQ will be disabled, including **Input Trim**. Bypass is useful for comparing the results of the EQ with the original signal.

Input Trim

[00...99]

This controls the volume level going into the EQ. Note that this parameter uses a linear scale; 50 is equivalent to -6 dB, 25 is the same as -12 dB, and so on.

High settings of the Low, Mid, and High Gain controls can cause substantial increases in the overall level. You can compensate for this by turning down the input trim.

Timbre 02...08, 09...16 (Timbre Number):

Here, you can make settings for timbres 2-8 and 9-16. They are the same as for timbre 1. For more information, please see “Timbre 01 (Timbre Number):” above.

2-1(2): Menu Command

- 0: **Write Combination** see p. 101
- 1: **Exclusive Solo** see p. 64
- 2: **Auto Song Setup** see p. 65
- 3: **Copy from Program** see p. 101

For more information, please see “Combination: Menu Command” on page 101.

2-3: EQ Gain T01-08, 2-4: EQ Gain T09-16

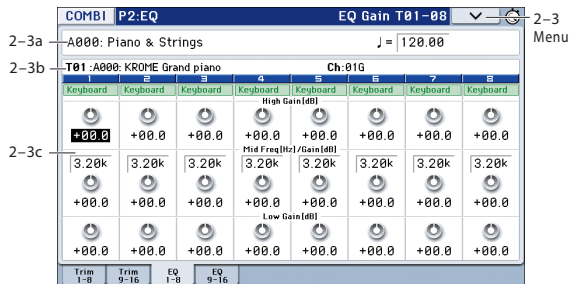

These parameters adjust the three-band EQ (with sweepable mid range) for timbres 1-8 and 9-16.

2-3(4)a: Combination Name, Tempo 2-3(4)b: Timbre Info

For more information, please see “2-1: EQ Trim T01-08, 2-2: EQ Trim T09-16” on page 79.

2-3(4)c: 3 Band Parametric EQ

Timbre 01 (Timbre Number):

High Gain [dB] [-18.0...+00.0...+18.0]

This controls the gain of the 10 kHz High Shelf EQ, in increments of 0.5 dB.

Mid Freq [Hz] (Mid Frequency) [100...10k]

This sets the center frequency for the Mid sweep EQ.

Mid Gain [dB] [-18.0...+00.0...+18.0]

This controls the gain of the Mid Sweep EQ, in increments of 0.5 dB.

Low Gain [dB] [-18.0...+00.0...+18.0]

This controls the gain of the 80 Hz Low Shelf EQ, in increments of 0.5 dB.

Timbre 02...08, 09...16 (Timbre Number):

These parameters adjust the three-band EQ (with sweepable mid range) for timbres 2-8 and 9-16. They are the same as for timbre 1. For more information, please see “Timbre 01 (Timbre Number):” above.

2-3(4): Menu Command

- 0: **Write Combination** see p. 101
- 1: **Exclusive Solo** see p. 64
- 2: **Auto Song Setup** see p. 65
- 3: **Copy from Program** see p. 101

For more information, please see “Combination: Menu Command” on page 101.

COMBI P3: Timbre Param (Timbre Parameters)

3-1: MIDI T01-08, 3-2: MIDI T09-16

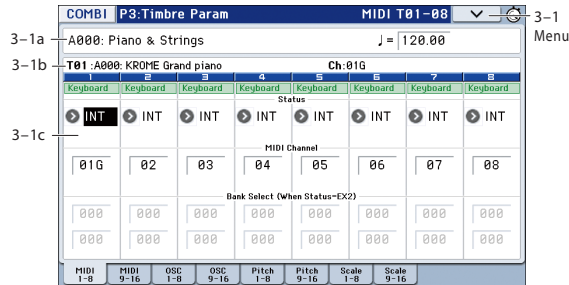

Here, you can make MIDI settings for timbres 1-8 and 9-16.

3-1(2)a: Combination Name, Tempo 3-1(2)b: Timbre Info

For more information, please see “2-1: EQ Trim T01-08, 2-2: EQ Trim T09-16” on page 79.

3-1(2)c: MIDI

Timbre 01 (Timbre Number):

Status [Off, INT, EXT, EX2]

This sets whether the Timbre controls the internal sounds, or external MIDI devices.

When controlling external MIDI devices, you can choose between using the internal Bank Select numbers (as set by the front-panel buttons), or using custom Bank Select settings to match the external device.

Off: Use this to disable the Timbre. With this setting, the Timbre’s Program will not sound, and MIDI data will not be transmitted.

INT: The timbre will sound, and will also sound in response to MIDI messages from an external MIDI device. MIDI data will not be transmitted.

EXT: The timbre will not sound even if it receives messages from a controller, but MIDI data will be transmitted to external devices.

EX2: Use this to play an external MIDI device, with custom-set Bank Select via the Bank Select (When Status=EX2) LSB and MSB parameters, on the MIDI tab of the Timbre Parameters page. In all other ways, this is the same as EXT.

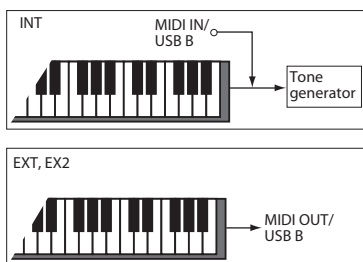

MIDI Channel [01...16, Gch]

Sets the MIDI transmit/receive channel for each timbre.

Gch: The timbre will use the channel that has been selected as the global MIDI Channel (Global 1-1a).

When Status is INT, MIDI messages will be received on the channel you specify here. If this setting is the same as the global MIDI channel, the internal tone generator will sound according to the internal settings. If this is set to EXT or EX2, playing the KROME will transmit MIDI messages on the MIDI channel specified here. (Messages will also be transmitted simultaneously on the global MIDI channel.)

Bank Select (When Status = EX2) MSB [000...127]

Bank Select (When Status = EX2) LSB [000...127]

Specifies the bank number that will be transmitted when Status is set to EX2. The upper line is the MSB, and the lower line is the LSB. This setting has no effect if Status is other than EX2.

Timbre 02...08, 09...16 (Timbre Number):

These are the MIDI-related settings for timbres 2-8 and 9-16. They are the same as for timbre 1. For more information, please see “Timbre 01 (Timbre Number):” above.

3-1(2): Menu Command

- 0: Write Combination see p. 101
- 1: Exclusive Solo see p. 64
- 2: Auto Song Setup see p. 65
- 3: Copy from Program see p. 101

For more information, please see “Combination: Menu Command” on page 101.

3-3: OSC T01-08, 3-4: OSC T09-16

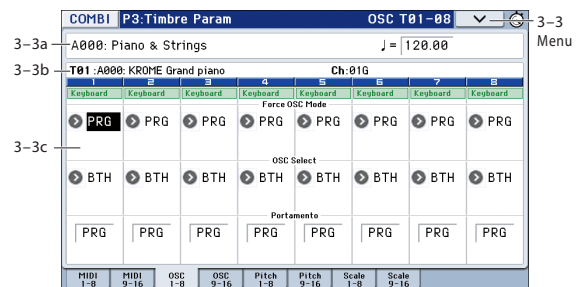

These settings specify how timbres 1-8 and 9-16 will be played.

3-3(4)a: Combination Name, Tempo 3-3(4)b: Timbre Info

For more information, please see “2-1: EQ Trim T01-08, 2-2: EQ Trim T09-16” on page 79.

3-3(4)c: OSC

Timbre 01 (Timbre Number):

Force OSC Mode [PRG, Poly, MN, LGT]

This lets you override the Program's stored Voice Assign Mode settings, if desired.

PRG: The Program's stored Prog P1: Basic/Controllers-Program Basic **Voice Assign Mode** settings will be used.

Poly: The timbre will play polyphonically, regardless of the Program's settings.

MN (Mono): The timbre will play monophonically, regardless of the Program's settings.

LGT (Legato): The timbre will sound monophonically, and will play legato according to the Program's **Mode** setting (Prog 1-1b).

With the MN or LGT settings, the Program's **Priority** setting (Prog 1-1b) will determine the priority of the note that sounds when you play two or more notes.

OSC Select [BTH, OS1, OS2]

Specifies whether the timbre's program will play OSC1, OSC2, or both.

For programs whose **Oscillator Mode** (Prog 1-1a) is Double or Double Drums, this setting lets you specify that only OSC1 or OSC2 will sound.

BTH (Both): OSC1 and 2 will sound as specified by the settings of the program.

OS1: Only OSC1 will sound.

OS2: Only OSC2 will sound. Programs will not sound if **Oscillator Mode** is set to Single or Drums.

Portamento [PRG, Off, 001...127]

Make portamento settings for each timbre.

PRG: Portamento will be applied as specified by the program settings.

Off: Portamento will be off, even if the original program settings specified Portamento to be on.

001...127: Portamento will be applied with the portamento time you specify here, even if it is turned off by the program settings.

MIDI If the **Status** (Combi 3-1(2)c) is set to INT, CC#05 (portamento time) and CC#65 (portamento switch) messages will be received and will control and change these settings. (If the setting is PRG, CC#05, portamento time will not be received.) These messages will be received on the MIDI channel specified for each timbre by **MIDI Channel** (Combi 3-1(2)c).

Timbre 02...08, 09... 16 (Timbre Number):

Here you can make voice assignment settings for timbres 2-8 and 9-16. The settings are the same as for timbre 1. For more information, please see "Timbre 01 (Timbre Number):" above.

✓ 3-3(4): Menu Command

- 0: Write Combination see p. 101
- 1: Exclusive Solo see p. 64
- 2: Auto Song Setup see p. 65
- 3: Copy from Program see p. 101

For more information, please see "Combination: Menu Command" on page 101.

3-5: Pitch T01-08, 3-6: Pitch T09-16

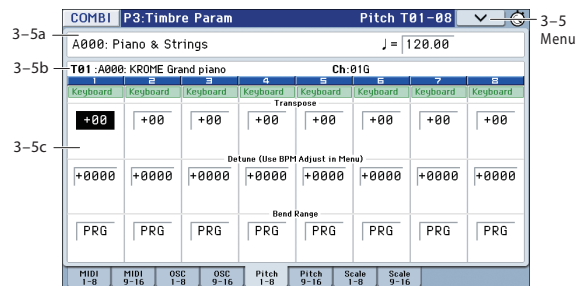

Here, you can make pitch-related settings for timbres 1-8 and 9-16.

3-5(6)a: Combination Name, Tempo

3-5(6)b: Timbre Info

For more information, please see "2-1: EQ Trim T01-08, 2-2: EQ Trim T09-16" on page 79.

3-5(6)c: Pitch

Timbre 01 (Timbre Number):

Transpose [-60...+00...+60]

Adjusts the pitch of each timbre in semitone steps. 12 units equal one octave.

MIDI When **Status** (Combi 3-1(2)c) is INT, this parameter will affect the pitches sounded by the KROME. When **Status** is EXT, this parameter will affect the note numbers of the MIDI note messages that are transmitted.

For example if you make settings of +04 and +07 respectively for two timbres that are set to EXT, playing the C key will transmit a C note number on the global MIDI channel, and at the same time will also transmit E and G note numbers on the MIDI channels of those timbres.

Detune (Use BPM Adjust in Menu) [-1200...+0000...+1200]

Adjusts the pitch of each timbre in one-cent units.

+0000: Normal pitch.

Note: You can also use the **Detune BPM Adjust** menu command to alter a loop's tempo via detuning. Since this will alter the pitch of the loop along with the tempo, it's generally suited only to un-pitched percussive loops.

MIDI **Transpose** and **Detune** can be controlled via MIDI RPN messages. The way that this works depends on whether or not the Timbre uses a Drum Program.

If the Timbre does not use a Drum Program for example, if it uses a Single or Double Program then MIDI RPN Coarse Tune will control **Transpose**, and RPN Fine Tune will control **Detune**.

If the Timbre uses a Drum Program, MIDI RPN Coarse Tune and Fine Tune will be combined to control **Detune**. The overall range is ±1 octave for coarse tune and fine tune together.

Bend Range [PRG, -24...+00...+24]

Specifies the maximum amount of pitch change (in semitones) that will occur when the pitch bender is operated.

PRG: The pitch range specified by the program will be used.

-24...+24: This setting will be used regardless of the setting in the program.

MIDI The MIDI RPN Pitch Bend Change message can be received to control this and change the setting. (However it will not be received if this parameter is set to PRG.) This message is received on the MIDI channel for each timbre set by **MIDI Channel** (Combi 3-1(2)c).

Timbre 02...08, 09...16 (Timbre Number):

These are the pitch-related settings for timbres 2-8 and 9-16. The settings are the same as for timbre 1. For more information, please see "Timbre 01 (Timbre Number):" above.

✓ **3-5(6): Menu Command**

- 0: **Write Combination** see p. 101
- 1: **Exclusive Solo** see p. 64
- 2: **Auto Song Setup** see p. 65
- 3: **Copy from Program** see p. 101
- 4: **Detune BPM Adjust** see p. 103

For more information, please see "Combination: Menu Command" on page 101.

**3-7: Scale T01-08,
3-8: Scale T09-16**

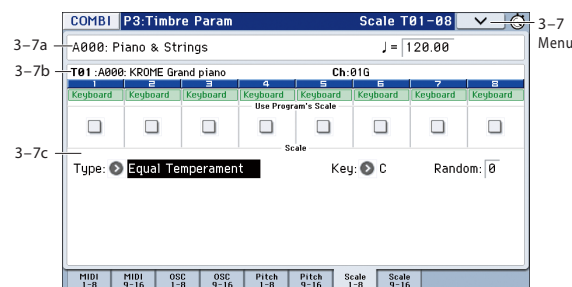

Here, you can make settings for the scale of timbres 1-8 and 9-16.

3-7(8)a: Combination Name, Tempo

3-7(8)b: Timbre Info

For more information, please see "2-1: EQ Trim T01-08, 2-2: EQ Trim T09-16" on page 79.

3-7(8)c: Scale

Timbre 01 (Timbre Number):

Use Program's Scale [Off, On]

Timbre can use the scale that is specified by **Scale** (Prog 1-2b).

On (checked): The scale specified by the program will be used.

Off (unchecked): The scale specified by **Type (Combi's Scale)** (Combi 3-7(8)c) will be used.

Timbre 02...08, 09...16 (Timbre Number):

Here, you can make settings for the scale of each timbre 2-8 and 9-16. The settings are the same as for timbre 1. For more information, please see "Timbre 01 (Timbre Number):" above.

Scale:

This specifies the scale that the combination will use. For more information, please see "1-2d: Scale" on page 15.

Type (Combi's Scale)

[Equal Temperament...User Octave Scale15]

Selects the scale.

Key

[C...B]

Selects the tonic key of the selected scale.

Random

[0...7]

As this value is increased, an increasingly random deviation will be added to the pitch at each note-on.

MIDI If **Status** (Combi 3-1(2)c) is INT, this setting will affect the pitch produced by the KROME. If **Status** is EXT, this setting will affect the note number of the note messages transmitted via MIDI.

✓ **3-7(8): Menu Command**

- 0: **Write Combination** see p. 101
- 1: **Exclusive Solo** see p. 64
- 2: **Auto Song Setup** see p. 65
- 3: **Copy from Program** see p. 101

For more information, please see "Combination: Menu Command" on page 101.

COMBI P4: Zone/Delay

4-1: Key Zone T01-08, 4-2: Key Zone T09-16 (Keyboard Zones T01-08, T09-16)

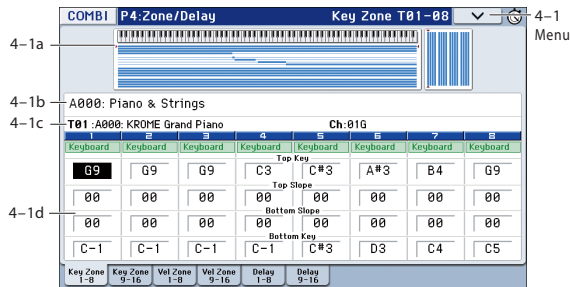

These settings specify the keyboard range in which timbres 1-8 and 9-16 will sound.

The top/bottom key parameters specify the range of notes in which timbres 1-8 and 9-16 will sound, and the top/bottom slope parameters specify the range over which the original volume will be reached.

Key Split: By setting timbres of different sounds to ranges that do not overlap, you can play different sounds in different ranges of the keyboard.

Layer: By setting the ranges to overlap, you can play two or more sounds with a single note.

Positional Cross-fade: If you set the slopes (the grayed portion) to overlap, the sounds will overlap, and the proportion of the overlap will change according to the keyboard location.

4-1(2)a:Zone Map

This area indicates the note and velocity ranges in which each timbre will sound.

The display uses lines to indicate the range of notes and velocities that will sound, and show the slope portion.

4-1(2)b: Combination Name, Tempo 4-1(2)c: Timbre Info

For more information, please see "2-1: EQ Trim T01-08, 2-2: EQ Trim T09-16" on page 79.

Zone Map

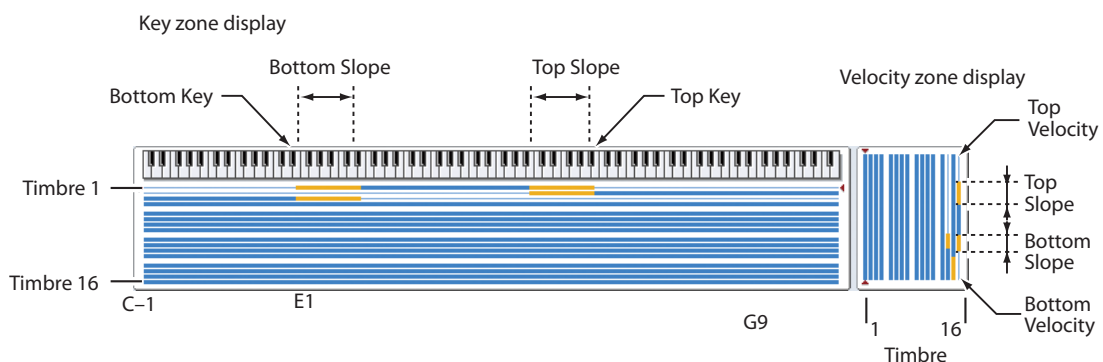

4-1(2)d:Keyboard Zones

Timbre 01 (Timbre Number):

Top Key [C-1...G9]

Specifies the top key (upper limit) of the notes that will sound each timbre.

Top Slope [00, 01, 02, 03, 04, 06, 08, 10, 12, 18, 24, 30, 36, 48, 60, 72]

Specifies the range of keys (12 is one octave) over which the volume will be reached starting from the top key.

0: The volume will be at the original level from the top key.

12: The volume will increase gradually as you play downward, and will reach the original volume one octave below the top key.

72: The volume will increase gradually as you play downward, and will reach the original volume six octaves below the top key.

Bottom Slope [00, 01, 02, 03, 04, 06, 08, 10, 12, 18, 24, 30, 36, 48, 60, 72]

Specifies the range of keys (12 is one octave) over which the volume will be reached starting from the bottom key.

0: The volume will be at the original level from the bottom key.

12: The volume will increase gradually as you play upward, and will reach the original volume one octave above the bottom key.

72: The volume will increase gradually as you play upward, and will reach the original volume six octaves above the bottom key.

Bottom Key [C-1...G9]

Specifies the bottom key (lower limit) of the notes that will sound each timbre.

How volume will change according to keyboard location

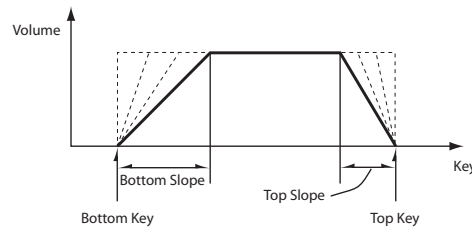

Note: You can also set the note values and velocity values by holding down an edit cell or the ENTER button and playing a key (see OG p.10).

 It is not possible to set the bottom key above the top key of the same timbre. Nor is it possible for the top and bottom slopes to overlap.

Timbre 02...08, 09...16 (Timbre Number):

These are the key zone settings for timbres 2-8 and 9-16. They are the same as for timbre 1. For more information, please see “Timbre 01 (Timbre Number):” above.

✓ **4-1(2): Menu Command**

- 0: **Write Combination** see p. 101
- 1: **Exclusive Solo** see p. 64
- 2: **Auto Song Setup** see p. 65
- 3: **Copy from Program** see p. 101

For more information, please see “Combination: Menu Command” on page 101.

**4-3: Vel Zone T01-08,
4-4: Vel Zone T09-16
(Velocity Zones T01-08, T09-16)**

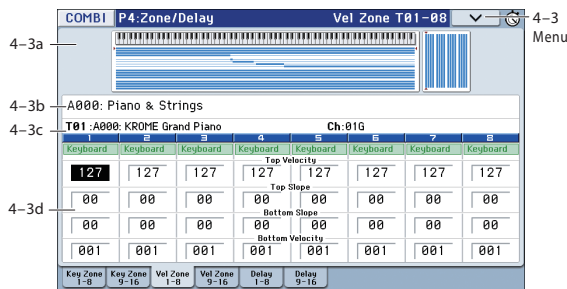

Sets the Top/Bottom Velocity parameters to specify the range of velocities that will sound for each timbre 1-8 and 9-16, and set the Top/Bottom Slope parameters to specify the range over which the volume will change.

Velocity switch: If you set different velocity zones for multiple timbres so that they do not sound together, you can play separate sounds by varying playing dynamics.

Layer: If you set two or more timbres to velocity zones that overlap, the sounds will be heard together.

Velocity Cross-fade: If the slope ranges (gray line) overlap, different sounds will be sounded together, and your playing dynamics will determine the proportion of each sound.

 It is not possible to set the bottom velocity greater than the top velocity for the same timbre, nor can the top slope and the bottom slope overlap.

4-3(4)a: Zone Map

This area indicates the note and velocity ranges in which each timbre will sound.

For more information, please see “4-1(2)a: Zone Map” on page 84.

4-3(4)b: Combination Name, Tempo

4-3(4)c: Timbre Info

For more information, please see “2-1: EQ Trim T01-08, 2-2: EQ Trim T09-16” on page 79.

4-3(4)d: Velocity Zones

Timbre 01 (Timbre Number):

Top Velocity [001...127]

Specifies the maximum velocity value that will sound each timbre.

Top Slope [000...120]

Specifies the number of velocity steps over which the original volume will be reached, starting from the Top Velocity.

0: The volume will be at the original value from the top velocity.

120: The volume will decrease as the velocity approaches the top velocity.

Bottom Slope [000...120]

Specifies the number of velocity steps over which the original volume will be reached, starting from the Bottom Velocity.

0: The volume will be at the original value from the bottom velocity.

120: The volume will decrease as the velocity approaches the bottom velocity.

Bottom Velocity [001...127]

Specifies the minimum velocity value that will sound each timbre.

How volume will change according to keyboard location

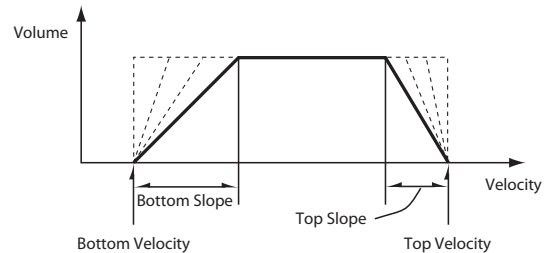

Note: You can also set the note values and velocity values by holding down an edit cell or the ENTER button and playing a key (see OG p.10).

Timbre 02...08, 09...16 (Timbre Number):

These are the velocity zone settings for timbres 2-8 and 9-16. They are the same as for timbre 1. For more information, please see “Timbre 01 (Timbre Number):” above.

✓ **4-3(4): Menu Command**

- 0: **Write Combination** see p. 101
- 1: **Exclusive Solo** see p. 64
- 2: **Auto Song Setup** see p. 65
- 3: **Copy from Program** see p. 101

For more information, please see “Combination: Menu Command” on page 101.

4-5: Delay T01-08, 4-6: Delay T09-16

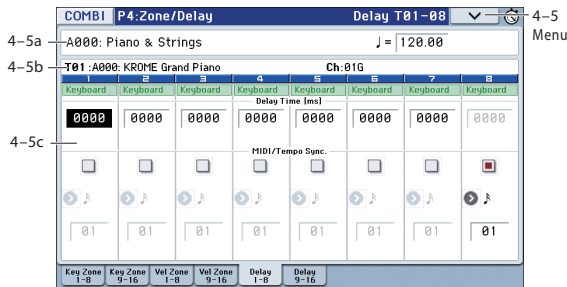

This specifies the time (delay) from when the timbres 1-8 and 9-16 receive a note-on until the sound begins.

4-5(6)a: Combination Name, Tempo 4-5(6)b: Timbre Info

For more information, please see "2-1: EQ Trim T01-08, 2-2: EQ Trim T09-16" on page 79.

4-5(6)c: Delay

Timbre 01 (Timbre Number):

Delay Time [ms] [0000...5000ms, KeyOff]

Specifies the time (delay time) from note-on until the timbre begins to produce sound, in units of ms (1/1000th of a second). This setting is available if **MIDI/Tempo Sync** is set to Off.

KeyOff: The note will begin sounding at note-off. In this case, the sound will not die away if the sustain level of the program's amp EG is other than 0. This setting is used when creating harpsichord sounds.

Normally you will set this to 0000.

MIDI/Tempo Sync. [Off, On]

The time (delay time) from note-on until the timbre produces sound will be specified in note length units relative to the ♩ (**Tempo**).

On (checked): Specify the delay time in terms of a **Base Note** and **Times** relative to the **Tempo**. For example if **Base Note** = ♩, **Times** = 01, and **Tempo** = 60 BPM, the delay time will be equivalent to 1000 ms.

Off (unchecked): The delay time will be set by the **Delay Time** setting.

Base Note [♩, ♪, ♫, ♮, ♯, ♭, ♮, ♯, ♭, ♮, ♯, ♭, ♮] **Times** [01...32]

It specifies the time (delay time) from note-on until the timbre begins to produce sound, in terms of a note value relative to the ♩ (**Tempo**) (Combi 0-1(2)a).

Use **Base Note** to specify the desired note value, and use **Times** to extend that note value by the specified multiple.

For example if you set **Base Note** to a quarter note (♩) and **Times** to 02, that timbre will sound with a delay of a half note (♪). Even if you change ♩ (**Tempo**) (Combi 0-1(2)a), the delay time will always be a half note (♪). If you use these parameters to specify a delay of a half note (♪). In this case, a **Tempo** of 60.00 BPM will produce a 2000 ms delay, and a **Tempo** of 120.00 BPM will produce a 1000 ms delay.

Timbre 02...08, 09...16 (Timbre Number):

These are the delay time settings for timbres 2-8 and 9-16. They are the same as for timbre 1. For more information, please see "Timbre 01 (Timbre Number):" above.

✓ 4-5(6): Menu Command

- 0: **Write Combination** see p. 101
- 1: **Exclusive Solo** see p. 64
- 2: **Auto Song Setup** see p. 65
- 3: **Copy from Program** see p. 101

For more information, please see "Combination: Menu Command" on page 101.

COMBI P5: MIDI Filter

These settings allow you to apply filters to the MIDI data that will be transmitted and received by each timbre 1-16. For example even if two timbres are being played by the same MIDI channel, you can make settings so that the damper pedal will apply to one but not the other.

On (checked): Transmission and reception or reception (After Touch) of MIDI data is enabled.

If **Status** (Combi 3-1(2)c) is INT, the effects of the checked items will be applied to the timbre's program when the controllers of the KROME are operated or when MIDI data is received. (Effect Dynamic Modulation is not affected by these settings.)

In the case of EXT or EX2, operating a controller on the KROME will transmit MIDI data on the channel of that timbre. MIDI transmission/reception settings for the entire KROME can be made in **MIDI Filter** (Global 1-2b).

The MIDI Filter <4> and <5> contain MIDI filters for assignable controllers (whose function can be set by the user), and if these are assigned to MIDI control changes, the filter settings will affect those control changes. In this case, if the same control change has been assigned in MIDI Filter pages <1>-<3>, the settings in MIDI Filter pages <1> through <3> will take priority. Also, if the same control change is assigned to two or more controllers in the MIDI Filter pages <4> and <5>, checking any one of them will enable that control change.

Off (unchecked): Transmission and reception of MIDI data is disabled.

Note: MIDI CC# = MIDI control change message numbers.

Enable Damper [Off, On]

Specifies whether or not MIDI CC#64 hold (damper pedal) messages will be transmitted and received.

Enable Portamento SW [Off, On]

Specifies whether or not MIDI CC#65 portamento on/off messages will be transmitted and received.

Timbre 02...08, 09...16 (Timbre Number):

These are the MIDI Filter1 settings for timbres 2-8 and 9-16. They are the same as for timbre 1. For more information, please see "Timbre 01 (Timbre Number):" above.

✓ 5-1(2): Menu Command

- 0: **Write Combination** see p. 101
- 1: **Exclusive Solo** see p. 64
- 2: **Auto Song Setup** see p. 65
- 3: **Copy from Program** see p. 101

For more information, please see "Combination: Menu Command" on page 101.

5-1: <1> T01-08, 5-2: <1> T09-16

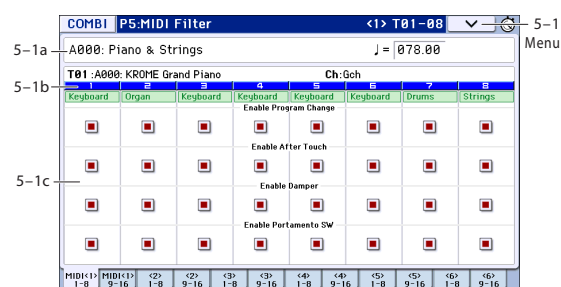

5-1(2)a: Combination Name, Tempo

5-1(2)b: Timbre Info

For more information, please see "2-1: EQ Trim T01-08, 2-2: EQ Trim T09-16" on page 79.

5-1(2)c: MIDI Filter1

Timbre 01 (Timbre Number):

Enable Program Change [Off, On]

Specifies whether or not MIDI program change messages will be transmitted and received.

Enable After Touch [Off, On]

Specifies whether or not MIDI after touch messages will be received.

**5-3: <2> T01-08,
5-4: <2> T09-16**

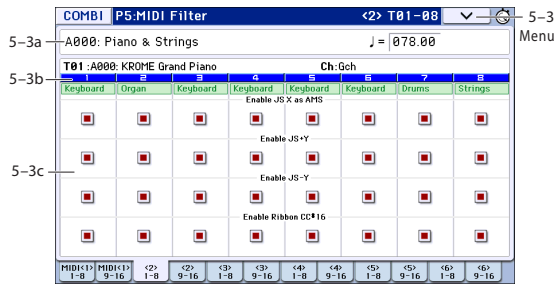

**5-3(4)a: Combination Name, Tempo
5-3(4)b: Timbre Info**

For more information, please see “2-1: EQ Trim T01-08, 2-2: EQ Trim T09-16” on page 79.

5-3(4)c: MIDI Filter2

Timbre 01 (Timbre Number):

Enable JS X as AMS [Off, On]

Specifies whether or not MIDI pitch bend messages (the X axis of the joystick) will be received to control the AMS effect assigned to JS X. (This is not a filter for MIDI pitch bend message reception.) For more information, please see “Alternate Modulation Sources (AMS)” on page 339.

Enable JS+Y [Off, On]

Specifies whether MIDI CC#1 (the +Y axis of the joystick, or a Realtime Controls knob assign setting) will be transmitted and received.

Enable JS-Y [Off, On]

Specifies whether MIDI CC#2 (the -Y axis of the joystick, or a Realtime Controls knob assign setting) will be transmitted and received.

Enable Ribbon CC#16 [Off, On]

Specifies whether or not MIDI CC#16 (specified as the assignment of a Realtime Controls knob) will be transmitted or received.

Timbre 02...08, 09... 16 (Timbre Number):

These are the MIDI Filter2 settings for timbres 2-8 and 9-16. They are the same as for timbre 1. For more information, please see “Timbre 01 (Timbre Number):” above.

✓ **5-3(4): Menu Command**

- 0: Write Combination see p. 101
- 1: Exclusive Solo see p. 64
- 2: Auto Song Setup see p. 65
- 3: Copy from Program see p. 101

For more information, please see “Combination: Menu Command” on page 101.

**5-5: <3> T01-08,
5-6: <3> T09-16**

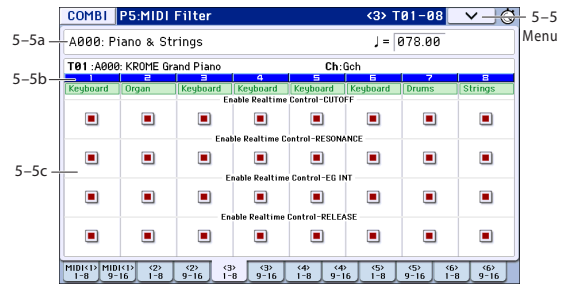

Here, you can specify whether the effect of knobs 1-4 (when the SELECT button selection is Realtime Controls TONE) will be transmitted and received. The MIDI control messages assigned to knobs 1-4 when Realtime Controls TONE is selected are fixed.

**5-5(6)a: Combination Name, Tempo
5-5(6)b: Timbre Info**

For more information, please see “2-1: EQ Trim T01-08, 2-2: EQ Trim T09-16” on page 79.

5-5(6)c: MIDI Filter3

Timbre 01 (Timbre Number):

Enable Realtime Controls-CUTOFF [Off, On]

Enables or disables transmission and reception of MIDI CC#74 (the KR0ME’s filter cutoff frequency). This is assigned to knob 1 when Realtime Controls TONE is selected.

Enable Realtime Controls-RESONANCE [Off, On]

Enables or disables transmission and reception of MIDI CC#71 (the KR0ME’s filter resonance level). This is assigned to knob 2 when Realtime Controls TONE is selected.

Enable Realtime Controls-EG INTENSITY [Off, On]

Enables or disables transmission and reception of MIDI CC#79 (the KR0ME’s filter EG intensity). This is assigned to knob 3 when Realtime Controls TONE is selected.

Enable Realtime Controls-RELEASE [Off, On]

Enables or disables transmission and reception of MIDI CC#72 (the KR0ME’s filter/amp EG release time). This is assigned to knob 4 when Realtime Controls TONE is selected.

Timbre 02...08, 09... 16 (Timbre Number):

These are the MIDI Filter3 settings for timbres 2-8 and 9-16. They are the same as for timbre 1. For more information, please see “Timbre 01 (Timbre Number):” above.

✓ **5-5(6): Menu Command**

- 0: Write Combination see p. 101
- 1: Exclusive Solo see p. 64
- 2: Auto Song Setup see p. 65
- 3: Copy from Program see p. 101

For more information, please see “Combination: Menu Command” on page 101.

5-7: <4> T01-08, 5-8: <4> T09-16

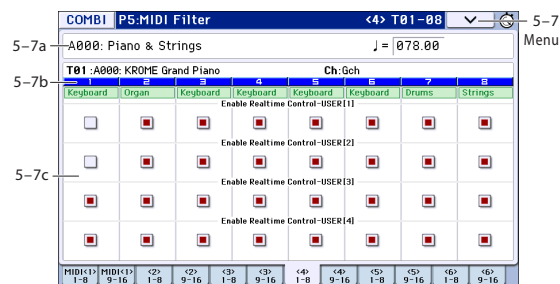

Here, you can enable or disable transmission and reception for the functions of knobs 1-4 when the SELECT button is set to Realtime Controls USER. Use the P1: Controllers-Controllers Setup page to assign the functions that knobs 1-4 will perform when Realtime Controls USER is selected.

5-7(8)a: Combination Name, Tempo 5-7(8)b: Timbre Info

For more information, please see “2-1: EQ Trim T01-08, 2-2: EQ Trim T09-16” on page 79.

5-7(8)c: MIDI Filter4

Timbre 01 (Timbre Number):

| | |
|---------------------------------|-----------|
| Enable Realtime Controls USER 1 | [Off, On] |
| Enable Realtime Controls USER 2 | [Off, On] |
| Enable Realtime Controls USER 3 | [Off, On] |
| Enable Realtime Controls USER 4 | [Off, On] |

These settings enable or disable transmission and reception of the MIDI messages assigned to knobs 1-4 when Realtime Controls USER is selected.

Timbre 02...08, 09...16 (Timbre Number):

These are the MIDI Filter4 settings for timbres 2-8 and 9-16. They are the same as for timbre 1. For more information, please see “Timbre 01 (Timbre Number):” above.

✓ 5-7(8): Menu Command

- 0: Write Combination see p. 101
- 1: Exclusive Solo see p. 64
- 2: Auto Song Setup see p. 65
- 3: Copy from Program see p. 101

For more information, please see “Combination: Menu Command” on page 101.

5-9: <5> T01-08, 5-10: <5> T09-16

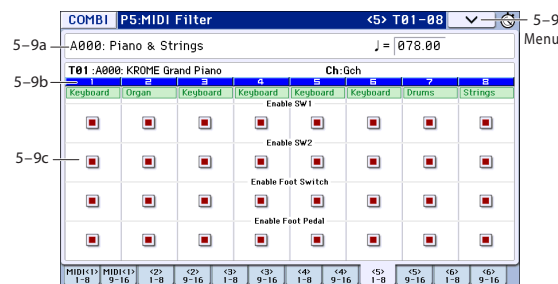

5-9(10)a: Combination Name, Tempo 5-9(10)b: Timbre Info

For more information, please see “2-1: EQ Trim T01-08, 2-2: EQ Trim T09-16” on page 79.

5-9(10)c: MIDI Filter5

Timbre 01 (Timbre Number):

| | |
|------------|-----------|
| Enable SW1 | [Off, On] |
| Enable SW2 | [Off, On] |

These settings specify whether SW1 Mod (CC#80) and SW2 Mod (CC#81) will be transmitted and received if they are assigned to the SW1 and SW2 buttons.

Note: If Portamento SW (CC#65) is assigned to SW1 or SW2, the Enable Portamento SW setting on the MIDI <1> page will take priority.

Note: The functions of SW1 and SW2 are assigned on the P1: Controllers Setup page (see p.78).

Enable Foot Switch [Off, On]

Specifies whether or not the effect of the ASSIGNABLE SWITCH will be transmitted and received. The function is assigned in Global P2: Controllers-Foot Controllers page.

This filter setting is valid when a MIDI control change is assigned.

Enable Foot Pedal [Off, On]

Specifies whether or not the effect of the ASSIGNABLE PEDAL will be transmitted and received. The function is assigned in Global P2: Controllers-Foot Controllers page.

This filter setting is valid when a MIDI control change is assigned.

Timbre 02...08, 09...16 (Timbre Number):

These are the MIDI Filter5 settings for timbres 2-8 and 9-16. They are the same as for timbre 1. For more information, please see “Timbre 01 (Timbre Number):” above.

5-9(10): Menu Command

- 0: Write Combination see p. 101
- 1: Exclusive Solo see p. 101
- 2: Auto Song Setup see p. 65
- 3: Copy from Program see p. 101

For more information, please see “Combination: Menu Command” on page 101.

5-11: <6> T01-08, 5-12: <6> T09-16

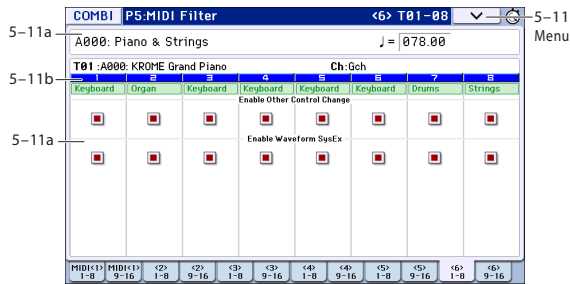

5-11(12)a: Combination Name, Tempo 5-11(12)b: Timbre Info

For more information, please see “2-1: EQ Trim T01-08, 2-2: EQ Trim T09-16” on page 79.

5-11(12)c: MIDI Filter6

Timbre 01 (Timbre Number):

Enable Other Control Change Messages [Off, On]

Specifies whether or not MIDI control messages not covered in the preceding items MIDI Filter will be transmitted and received.

Enable Waveform SysEx [Off, On]

This enables or disables reception of MIDI system exclusive messages that freely switch the multisample used by an oscillator while the program is sounding.

Timbre 02...08, 09...16 (Timbre Number):

These are the MIDI Filter6 settings for timbres 2-8 and 9-16. They are the same as for timbre 1. For more information, please see “Timbre 01 (Timbre Number):” above.

✓ 5-11(12): Menu Command

- 0: Write Combination see p. 101
- 1: Exclusive Solo see p. 101
- 2: Auto Song Setup see p. 65
- 3: Copy from Program see p. 101

For more information, please see “Combination: Menu Command” on page 101.

COMBI P7: ARP/DT (Arpeggiator/Drum Track)

These parameters specify how the arpeggiator will function within the combination. Two arpeggiators can run simultaneously.

This offers a variety of possibilities, such as applying separate arpeggio patterns to two sounds that have been assigned as a keyboard split, or using velocity to switch between two arpeggio patterns.

7-1: Setup T01-08, 7-2: Setup T09-16

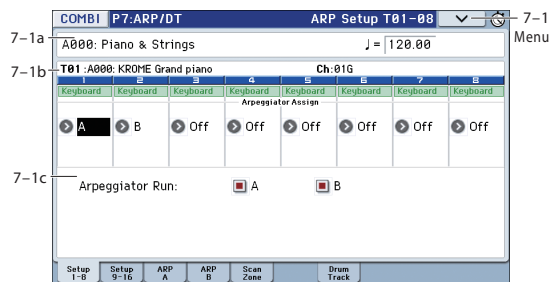

7-1(2)a: Combination Name, Tempo

Combination Name

For more information, please see “2-1(2)a: Combination Name, Tempo” on page 79.

♩ (Tempo) [040.00...300.00, EXT]

For more information, please see “♩ (Tempo)” on page 71.

7-1(2)b: Timbre Info

Selected Timbre Info

For more information, please see “Selected Timbre Info” on page 71.

7-1(2)c: Arpeggiator Assign, Arpeggiator Run

Arpeggiator Assign [Off, A, B]

Assigns arpeggiator A or B to each timbre 1-8 and 9-16. When the ARP button is on, the arpeggiator specified for each timbre will operate according to **Arpeggiator Run A, B** and these settings.

Off: The arpeggiator will not operate.

A: Arpeggiator A will operate. Use the settings in the Arpeggiator A page to select the arpeggio pattern and to set parameters.

B: Arpeggiator B will operate. Use the settings in the Arpeggiator B page to select the arpeggio pattern and to set parameters.

MIDI If the **Status** (Combi 3-1(2)c) of the timbre is **INT**, each timbre 1-16 will be sounded by the note data generated by the assigned arpeggiator, regardless of the **MIDI Channel** (Combi 3-1(2)c) setting of the timbre. If a timbre is set to **EXT** or **EX2**, MIDI note data will be transmitted on the **MIDI Channel** of that timbre.

In this case, arpeggiator A (or B) will be triggered (operated) by all MIDI channels specified for the **MIDI**

Channel parameter of any timbre 1-16 assigned to arpeggiator A or B.

⚡ If **Local Control** (Local Control On, Global P1: 1-1a) is **OFF**, the keyboard will not trigger the arpeggiator. The arpeggiator will be triggered via **MIDI IN**. Turn **Local Control OFF** if you have recorded only the trigger notes on an external sequencer, and wish to playback the external sequencer to trigger the KROME’s arpeggiator.

MIDI If you want to record the note data generated by the arpeggiator to an external sequencer, turn **Local Control ON**, and turn off the echo back function on your external sequencer.

You can control the arpeggiator from an external sequencer, or use an external sequencer to record arpeggio note data. (See page 367)

Example 1)

Set the **MIDI Channel** (Combi 3-1(2)c) of timbres 1 and 2 to **Gch**, and set **Status** (Combi 3-1(2)c) to **INT**. Assign arpeggiator A to timbre 1 and arpeggiator B to timbre 2, and check **Arpeggiator Run A, B** (Combi 0-5(6)a).

- When the **ARP** button is off, timbres 1 and 2 will sound simultaneously (layered) when you play the keyboard.
- When the **ARP** button is turned on, timbre 1 will be played by arpeggiator A, and timbre 2 will be played by arpeggiator B.

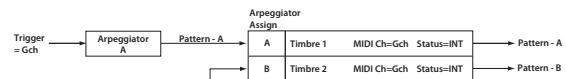

Example 2)

The **MIDI Channel** (Combi 3-1(2)c) of timbres 1, 2, 3, 4, and 5 are set respectively to **Gch, Gch, 02, Gch, and 03**. Their **Status** (Combi 3-1(2)c) is set respectively to **INT, Off, INT, Off, and INT**. Assign arpeggiator A to timbres 2 and 3, assign arpeggiator B to timbres 4 and 5, and check **Arpeggiator Run A, B** (Combi 0-5(6)a).

- When the **ARP** button is off, playing the keyboard will sound only timbre 1. (Timbres 2 and 4 are receiving the **Gch**, but they will not sound since their **Status** is **Off**.)
- When you turn on the **ARP** button, arpeggiator A will play timbres 2 and 3, and arpeggiator B will independently play timbres 4 and 5. (Arpeggiators A and B are triggered by note data received from any MIDI channel of an assigned timbre. However, in this example, they are being triggered from the **Gch**.)

When you play the keyboard, arpeggiator A will play timbres 2 and 3, but only timbre 3, whose **Status** is **INT** will sound from the keyboard. Similarly, arpeggiator B will play timbres 4 and 5, but only timbre 5, whose **Status** is **INT** will sound from the keyboard.

In this way, you can make settings so that a timbre is silent when the arpeggiator is off, and sounds only when the arpeggiator is on.

This type of setting is used in preloaded combinations which sound the drums only when the arpeggiator is on.

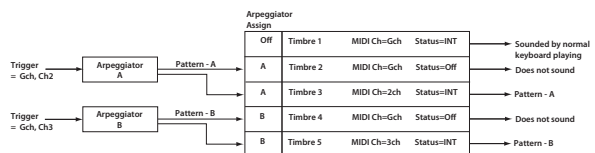

Arpeggiator Run A, B [Off, On]

When the ARP button is on, the arpeggiator(s) checked here will run if they are assigned to a timbre by **Arpeggiator Assign**.

✓ **7-1(2): Menu Command**

- 0: **Write Combination** see p. 101
- 1: **Exclusive Solo** see p. 101
- 2: **Auto Setup Song** see p. 101
- 3: **Copy from Program** see p. 101
- 4: **Copy Arpeggiator** see p. 103

For more information, please see "Combination: Menu Command" on page 101.

**7-3: Arpeggiator A,
7-4: Arpeggiator B**

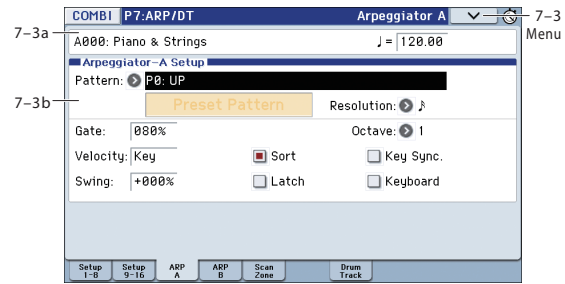

7-3(4)a: Combination Name, Tempo

For more information, please see "2-1: EQ Trim T01-08, 2-2: EQ Trim T09-16" on page 79.

For more information, please see "J (Tempo)" on page 71.

7-3(4)b: Arpeggiator-A(B) Setup

| | |
|--------------------|--|
| Pattern* | [P0...P4, U0000(INT)...U0899(INT), U0900(USER)...U1027(USER)] |
| Octave* | [1, 2, 3, 4] |
| Resolution* | [♪ ₃ , ♪, ♪ ₃ , ♪, ♪ ₃ , ♪, ♪ ₃ , ♪] |
| Gate | [000...100%, Step] |
| Velocity | [001...127, Key, Step] |
| Swing | [-100...+100%] |
| Sort* | [Off, On] |
| Latch* | [Off, On] |
| Key Sync.* | [Off, On] |
| Keyboard* | [Off, On] |

These parameters are the arpeggiator settings for the combination.

For more information, please see "PROG P7: ARP/DT (Arpeggiator/Drum Track)" on page 53.

* These parameters can also be set from "0-5(6)d: Arpeggiator A (B)".

✓ **7-3(4): Menu Command**

- 0: **Write Combination** see p. 101
- 1: **Exclusive Solo** see p. 101
- 2: **Auto Setup Song** see p. 101
- 3: **Copy from Program** see p. 101
- 4: **Copy Arpeggiator** see p. 103

For more information, please see "Combination: Menu Command" on page 101.

7-5: ARP Scan Zone

These settings specify the note and velocity ranges that will trigger arpeggiators A and B.

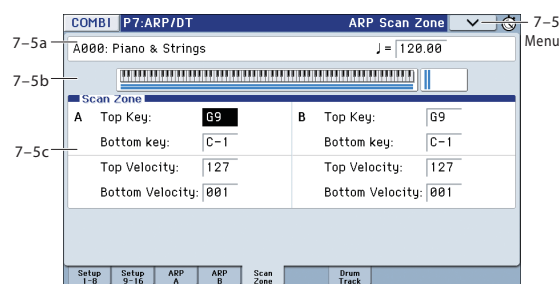

7-5a: Combination Name, Tempo

For more information, please see “Combination Select” on page 70.

For more information, please see “♩ (Tempo)” on page 71.

7-5b: Zone Map

This shows the Scan Zone for each arpeggiator, A and B.

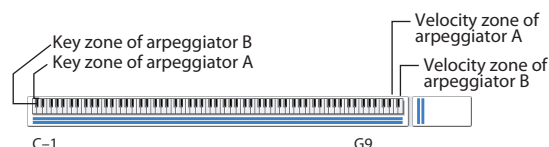

7-5c: Scan Zone A/B

A: , B:

Top Key [C-1...G9]

Bottom Key [C-1...G9]

Specifies the range of notes (keys) that will trigger arpeggiator A/B. **Top Key** specifies the upper limit, and **Bottom Key** specifies the lower limit.

Top Velocity [001...127]

Bottom Velocity [001...127]

Specifies the range of velocities that will trigger arpeggiator A/B. **Top Velocity** specifies the upper limit, and **Bottom Velocity** specifies the lower limit.

Specifies the range of notes (keys) and velocities that will trigger arpeggiator A/B.

Note: You can also set the note values and velocity values by holding down an edit cell or the ENTER button and playing a key (see OG p.10).

✓ 7-5: Menu Command

- 0: **Write Combination** see p. 101
- 1: **Exclusive Solo** see p. 101
- 2: **Auto Setup Song** see p. 101
- 3: **Copy from Program** see p. 101
- 4: **Copy Arpeggiator** see p. 103

For more information, please see “Combination: Menu Command” on page 101.

7-7: Drum Track

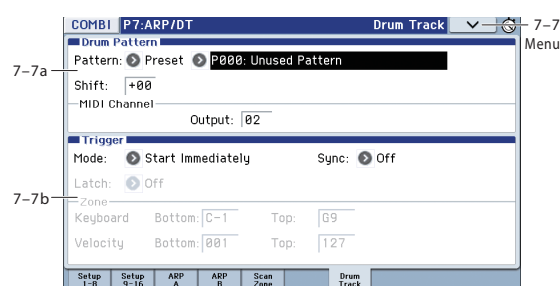

Here, you can select a drum track pattern and specify how it will sound.

Note: In Combination mode (unlike Program mode) there is no dedicated timbre for the drum track. You can assign the drum track program to be any timbre 1-16. The drum track program will be played when the drum track’s MIDI channel Output matches the timbre’s MIDI Channel.

In Combination mode, the drum track patterns are triggered on the Global MIDI channel.

MIDI transmission and reception for the drum track

In Combination mode, the Drum Track function transmits and receives on the following MIDI channels.

Receive: If you’re controlling the triggering by playing the keyboard, the drum track will receive on the global MIDI channel.

Transmit: The drum track will transmit on the MIDI channel specified by the Drum Pattern **Output** setting of each combination.

Set this to match the MIDI channel of the timbre you’ve specified for the drum program.

If the timbre’s **Status** is EXT or EX2, the note data etc. of the Drum Track pattern will be transmitted.

If local control (“Local Control On Global P1:1-1a) is on, playing the KROME’s keyboard will not make the internal sound generator produce sound, nor can the keyboard trigger the arpeggiator or drum track. However, they can be triggered by note-on messages from MIDI IN.

7-7a: Drum Pattern

Pattern [Preset, User]
[(Preset): P000...P605, (User): U000...U999]

This selects the drum pattern.

| Preset/User No. | Contents |
|-----------------|----------------------------------|
| P000 | Off |
| P000...P605 | Preset drum patterns |
| U000...U999 | For user/preloaded drum patterns |

- U000-U999 can be written. Patterns you create in Sequencer mode can be converted into user drum patterns (see page 188).

Shift [-24...+00...+24]

This transposes the drum pattern in semitone steps. This means that the instruments of the drum kit will change.

MIDI Channel

Output [01...16, Gch]

This specifies the MIDI channel that will transmit the MIDI data of the drum pattern. The drum pattern will trigger the program of the timbre that is set to this same MIDI channel.

Gch: The data will be sent to the channel specified by the global MIDI channel **MIDI Channel** setting (Global 1–1a).

Whether the pattern data will be output to an external device will depend on the **Status** setting of the timbre that matches the **Output** MIDI channel.

7–7b: Trigger

Trigger Mode [Start Immediately, Wait KBD Trig]

Start Immediately: When you press the DRUM TRACK button to turn it on (LED lit), the drum pattern will start according to the **Sync** setting. When you turn it off (LED dark), the drum pattern will stop.

Wait KBD Trig: When you press the DRUM TRACK button to turn it on (LED lit), the drum pattern will wait to start. When you play the keyboard, or when a MIDI note-on is received, the drum pattern will start according to the **Sync** setting.

 If you've selected **Start Immediately**, the DRUM TRACK button will always be saved in the OFF state.

Sync [Off, On]

Off: The drum pattern will not synchronize to the currently-running arpeggiator, but will start immediately.

On: The drum pattern will synchronize to the currently-running arpeggiator.

Note: Use P7–3(4)c: Arpeggiator-A(B) Setup **Key Sync** to specify whether the arpeggiator will synchronize to the currently-running drum pattern.

Latch [Off, On]

This specifies whether the drum track will continue playing even after you take your hand off the keyboard.

This is valid if **Trigger Mode** is **Wait KBD Trig**.

Off: If the DRUM TRACK button is on (LED blinking), the pattern will start when you play the keyboard (note-on). The pattern will stop when you release the keyboard (note-off).

On: If the DRUM TRACK button is on (LED blinking), the pattern will start when you play the keyboard (note-on). The pattern will continue when you release the keyboard (note-off). The pattern will stop when you turn the DRUM TRACK button off (LED dark).

Zone:

Keyboard

Bottom [C–1...G9]

Top [C–1...G9]

This is valid if **Trigger Mode** is set to **Wait KBD Trig**.

It specifies the range of keys that will start the drum pattern.

Velocity:

Bottom [001...127]

Top [001...127]

This is valid if **Trigger Mode** is set to **Wait KBD Trig**.

It specifies the range of velocities that will start the drum pattern.

∨ 7–7: Menu Command

- 0: **Write Combination** see p. 101
- 1: **Exclusive Solo** see p. 64
- 2: **Auto Setup Song** see p. 101
- 3: **Copy from Program** see p. 101
- 4: **Copy Drum Track** see p. 65
- 5: **Erase Drum Track Pattern** see p. 66

For more information, please see “Combination: Menu Command” on page 101.

COMBI P8: Routing/IFX (Insert Effect)

You can also specify the bus routing for the program used by each of the timbres, 1-16. For instance, you can:

- Send the output of a timbre to an insert effect
- Route a sound to an insert effect
- Make detailed settings for insert effects
- Make common LFO settings for effects

For more details on the Insert Effects, please see the “Effect Guide” on page 235.

8-1: Routing1 T01-08, 8-2: Routing1 T09-16

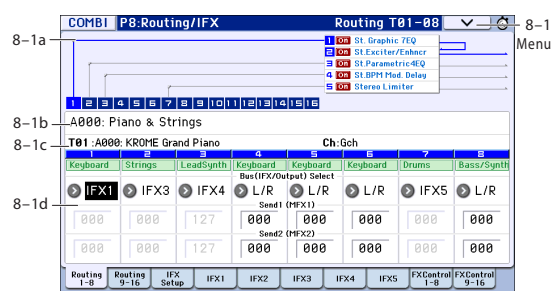

Specifies the bus to which the program oscillator(s) used by timbres 1-8 and 9-16 will be sent. You can also set the send levels to the master effects from this page.

8-1(2)a: Routing Map

This shows the status of the insert effects.

This area shows the insert effect routing (**Bus (IFX/Output) Select**), the name of the assigned effect, the on/off status, chaining, and the output bus that follows the insert effect. The type of insert effect, the on/off status, and the chain settings can be edited in the 8-3: Insert FX Setup page.

8-1(2)b: Combination Name

8-1(2)c: Timbre Info

For more information, please see “2-1: EQ Trim T01-08, 2-2: EQ Trim T09-16” on page 79.

8-1(2)d: Routing

Bus (IFX/Output) Select [DKit, L/R, IFX1...5, Off]

This specifies the output bus for the timbre’s program oscillator.

L/R: Output to the L/R bus.

IFX1...5: Output to the IFX1-5 buses.

Off: The timbre will not be output from the L/R bus, or IFX1-5 buses. Choose the Off setting if you want the program oscillator output of the timbre to be connected in series to a master effect. Use **Send1 (to MFX1)** and **Send2 (to MFX2)** to specify the send levels.

Tip: You can create a wide variety of routings by using each timbre’s **Bus (IFX/Output) Select** and the **Chain to** and **Chain** settings (Combi 8-3b) that follow the insert effect.

Example: Inserting a single IFX into multiple timbre



Example: Inserting a separate IFX into each timbre, and then inserting an IFX at the final stage



Example: Sharing a portion of a timbre’s IFX chain with another timbre



DKit: This can be selected only if the timbre’s program is a drum program (**Oscillator Mode Drums** or **Double Drums**).

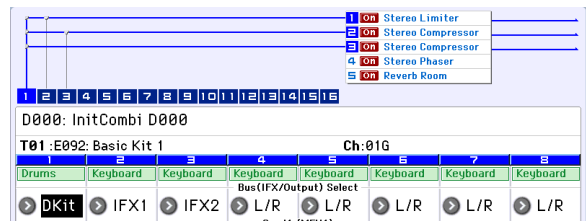

The **Bus (IFX/Output) Select**, **FX Control Bus**, **Send1**, and **Send2** (Global 5-5b) settings for each key of the selected Dkit will be used. Check this setting if you want to apply an individual insert effect to each drum instrument.

Tip: In most preloaded drumkits, the drum instruments have the same **Bus (IFX/Output) Select** settings according to their type, as follows.

Snares → IFX1

Kicks → IFX2

Other → IFX3

If you want to edit these routings, use the **Drum kit IFX Patch** menu command. For more information, please see “DrumKit IFX Patch” on page 104.

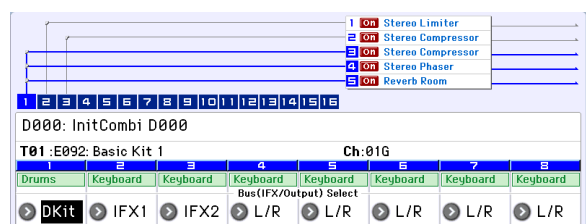
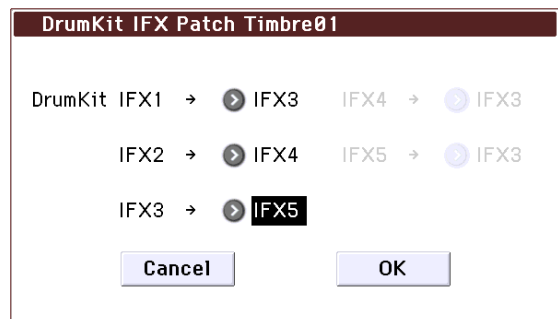

Send1 (MFX1) [000...127]
Send2 (MFX2) [000...127]

For each timbre, these parameters set the send level to master effects 1 and 2. These settings are valid when **Bus (IFX/Output) Select** is set to L/R or Off. When IFX 1–5 are selected, the send levels to master effects 1 and 2 are set by the **Send1** and **Send2** parameters of the Insert FX Setup page, after the sound has passed through IFX1–5.

MIDI Control change CC#93 can be used to control the Send 1 level, and CC#91 to control the Send 2, and modify their respective settings. These messages will be received on the MIDI channel specified for each timbre in the P2: MIDI channel page.

The actual send levels are determined by multiplying this value with the send level **Send1** and **Send2** (Prog 8–1d) for each oscillator of the program selected for the timbre.

✓ **8–1(2): Menu Command**

- 0: Write Combination see p. 101
- 1: Exclusive Solo see p. 101
- 2: Auto Setup Song see p. 101
- 3: Copy Insert Effect see p. 66
- 4: Swap Insert Effect see p. 67
- 5: DrumKit IFX Patch see p. 104

For more information, please see “Combination: Menu Command” on page 101.

8–3: Insert FX Setup

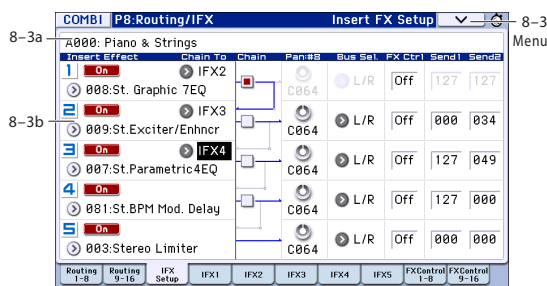

8–3a: Combination Name

For more information, please see “2–1: EQ Trim T01–08, 2–2: EQ Trim T09–16” on page 79.

8–3b: Insert Effect

Here, you can choose the type of each insert effect 1 through 5, its on/off status, chaining, and adjust the post-IFX mixer settings. For insert effects, the direct sound (Dry) is always stereo-in and out. The input/output configuration of the effect sound (Wet) depends on the effect type.

For detailed explanations of the individual effects, please see the “Effect Guide” on page 235.

The following parameters are the same as in Program mode. For more information, please see “8–2: Insert FX Setup” on page 59.

However, unlike in Program mode, you can use a different MIDI channel to modulate each effect, if desired. This includes the post-IFX **Pan: #8**, **Send1**, and **Send2** settings, as well as the effect’s dynamic modulation (Dmod). To set the

MIDI channel, use the **Ch** parameter on the IFX 1–5 page (Combi 8–4a).

Insert Effect:

IFX1...4 [000...193]
IFX5 [000...171]
IFX1...5: IFX On/Off [Off, On]

Chain:

IFX1: Chain to [IFX2...IFX5]
IFX2: Chain to [IFX3...IFX5]
IFX3: Chain to [IFX4...IFX5]
IFX1: Chain [Off, On]
IFX2: Chain [Off, On]
IFX3: Chain [Off, On]
IFX4: Chain [Off, On]

Pan:#8:

Pan: #8 (Post IFX PanCC#8) [L000...C064...R127]

Bus:

Bus (Bus Select) [Off, L/R]
Ctrl (FX Control Bus) [Off, 1, 2]

Send1/2:

Send1 [000...127]
Send2 [000...127]

For more information, please see “8–2: Insert FX Setup” on page 59.

✓ **8–3: Menu Command**

- 0: Write Combination see p. 101
- 1: Exclusive Solo see p. 64
- 2: Auto Setup Song see p. 101
- 3: Copy Insert Effect see p. 66
- 4: Swap Insert Effect see p. 67

For more information, please see “Combination: Menu Command” on page 101.

8-4: IFX1

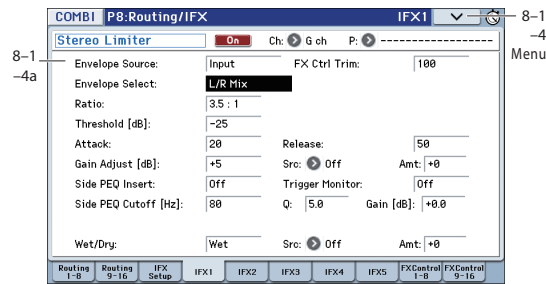

This page lets you edit the detailed parameters of the five insert effects. Use the tabs at left to select IFX1 through IFX5.

To select different effects types, use the Insert FX Setup page. For more information, please see “8-3: Insert FX Setup” on page 96.

8-4a: Insert Effect 1 (IFX1)

IFX1 On/Off [Off, On]

Turns the insert effect on/off. This is linked with the on/off setting in the P8: Routing/IFX- Insert FX Setup page.

Ch (Control Channel) [Ch01...16, G ch, All-R]

This parameter specifies the MIDI channel that will be used to control effect dynamic modulation (Dmod), pan following the insert effect (CC#8), Send 1, and Send 2.

The channel number of the timbre routed through this IFX will be followed by a “*” displayed at the right of Ch01–16. If two or timbres with different MIDI channel settings are routed through the same IFX, this parameter specifies which of these channels will be used to control the effect.

G ch: The global **MIDI Channel** (Global 1–1a) will be used to control the effect. Normally you will set this to G ch.

All-R (All Routed): The channel of any timbre routed through this effect can be used to control the effect. (Channels of each routed timbre will be indicated by “*”).

Drum Kits and the MIDI Control Channel

If a Timbre is using a Drum Kit, and the Timbre’s **Bus (IFX/Output) Select** (Combi 8-1(2)d) is **DKit**, this effects the MIDI Control Channel as well. In this case, the Timbre’s MIDI channel will be used to control any effect whose **Ch** is set to All-R, regardless of the **Bus (IFX/Output) Select** (Global 5-5b) settings or the settings of the **Drum kit IFX Patch** menu command.

P (Effect Preset)

[P00, P01...15, U00...15, -----]

Effect Presets let you easily store and recall all of the settings for an individual effect. You can store up to 16 user presets for each effect type, in addition to 15 re-writable factory presets.

The same presets appear in all of the modes (Program, Combination, Sequencer).

Note that edits to effects parameters are automatically stored with the Combi you don’t need to store them as an Effect Preset. Presets just make it easier to re-use your favorite settings.

For instance, you can save an Effect Preset while working on a particular Combination, and then later use the same Effect Preset in a different Program, Combination, or Song.

P00: Initial Set: These are the default settings that are recalled when you select an effect type in the Insert FX Setup page. You can’t save your own settings here.

P01...P15: Preset data is saved in this area. We recommend that you store your settings in U00–U15.

U00...U15: These are areas in which you can store your own settings.

-----: This shows that no Effect Preset has been selected. You’ll see this if you’ve just selected an effect, written a combination, or selected a new Combination. Selecting this setting from the menu will not have any effect.

Note: Combis save the effects parameter settings, but they don’t save the number of the selected Effect Preset. If you select an Effect Preset, and then save the Combination, the Effect Preset setting will revert to “-----.”

For more information, please see “Using Effect Presets” on page 60.

IFX1 Parameters:

IFX1 Parameters

Here, you can set the effect parameters of the insert effect you chose in the Insert FX Setup page.

For more details, please see “Insert Effects (IFX1–IFX5)” on page 240.

✓ 8-4: Menu Command

- 0: **Write Combination** see p. 101
- 1: **Exclusive Solo** see p. 64
- 2: **Auto Setup Song** see p. 101
- 3: **Copy Insert Effect** see p. 66
- 4: **Swap Insert Effect** see p. 67
- 5: **Write FX Preset** see p. 104

For more information, please see “Combination: Menu Command” on page 101.

8-5: IFX2, 8-6: IFX3, 8-7: IFX4, 8-8: IFX5

Here you can edit the effect parameters for insert effects 2–5 selected in the Insert FX Setup page.

For more information, please see “8-4: IFX1” above.

8-9: FX Control T01-08, 8-10: FX Control T09-16

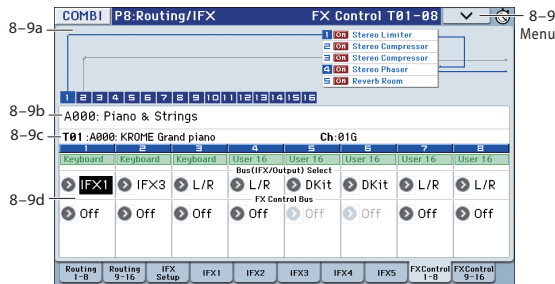

Here you can specify the program oscillator output bus, and effect control bus for timbres 1-8 and 9-16.

8-9(10)a: Routing Map, 8-9(10)b: Combination Name, 8-9(10)c: Timbre Info

For more information, please see “8-1: Routing1 T01-08, 8-2: Routing1 T09-16” on page 95.

8-9(10)d: Routing2

Bus (IFX/Output) Select [DKit, L/R, IFX1...5, Off]

This specifies the output bus for the timbre’s program oscillator. This is the same parameter as in the 8-1: IFX-Routing 1 T01-08 and T09-16 pages.

For more information, please see “Bus (IFX/Output) Select” on page 95.

FX Control Bus [Off, 1, 2]

Sends the output of the timbre to an FX Control bus (two-channel mono FX Ctrl 1 or 2).

Use the FX Control buses when you want a separate sound to control the audio input of an effect. You can use two FX Control buses (each is a two-channel mono bus) to control effects in various ways.

For more information, please see “FX Control Buses” on page 238.

∨ 8-9(10): Menu Command

- 0: Write Combination see p. 101
- 1: Exclusive Solo see p. 64
- 2: Auto Setup Song see p. 101
- 3: Copy Insert Effect see p. 66
- 4: Swap Insert Effect see p. 67
- 5: DrumKit IFX Patch see p. 104

For more information, please see “Combination: Menu Command” on page 101.

COMBI P9: MFX/TFX/LFO (Master/Total Effect/LFO)

Here, you can make settings for the master effects and the total effect. For instance, you can:

- Route a sound to the master effects and the total effect
- Make detailed settings for master effects and total effect

For more information, please see “Effect Guide” on page 235.

9-1: Routing

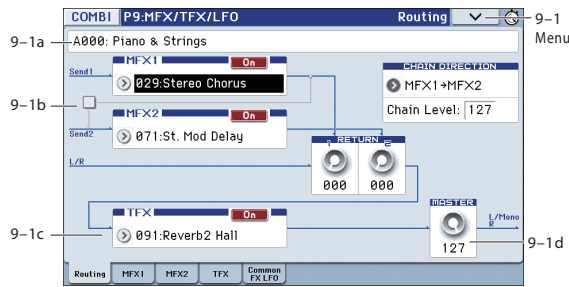

- Here you can specify the type of master effects 1, 2 and total effect, and turn them on/off.
- The master effects are sent to the L/R bus. The total effect is inserted into the L/R bus.

These parameters are the same as in Program mode. For more information, please see “9-1: Routing” on page 61.

9-1a: Combination Name

These are the bank, number, and name of the current Combination. For more information, please see “0-1(2)a: Combination Select” on page 70.

9-1b: MFX1, 2

MFX1:

MFX1 [000...193]

MFX1 On/Off [Off, On]

Return 1 [000...127]

MFX2:

MFX2 [000...171]

MFX2 On/Off [Off, On]

Return 2 [000...127]

Chain:

Chain On/Off [Off, On]

Chain Direction [MFX1→MFX2, MFX2→MFX1]

Chain Level [000...127]

For more information, please see “9-2: MFX1” on page 62.

9-1c: TFX

TFX:

TFX [000...171]

TFX On/Off [Off, On]

For more information, please see “PROG P9: MFX/TFX/LFO (Master/Total Effect/LFO)” on page 61.

9-1d: Master Volume

Master Volume [000...127]

For more information, please see “9-1c: Master Volume” on page 62.

9-1: Menu Command

- 0: Write Combination see p. 101
- 1: Exclusive Solo see p. 64
- 2: Auto Setup Song see p. 101
- 3: Copy MFX/TFX see p. 67
- 4: Swap MFX/TFX see p. 67

For more information, please see “Combination: Menu Command” on page 101.

9-2: MFX1

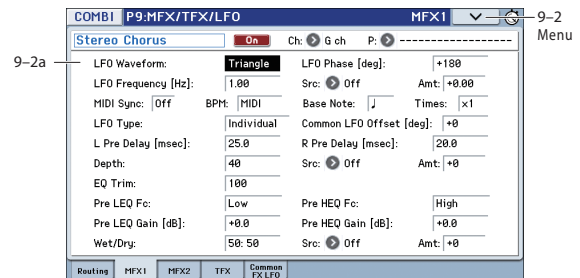

Here, you can edit the parameters of the effect you selected for MFX1 in the P9: MFX/TFX/LFO- Routing page.

9-2a: MFX1

MFX1 On/Off [Off, On]

This turns master effect 1 on/off. This is linked with the on/off setting in the P9: MFX/TFX/LFO- Routing page.

Ch (Control Channel) [Ch01...16, G ch]

Specifies the MIDI channel that will control dynamic modulation (Dmod) for the master effect.

Ch01...Ch16: The specified MIDI channel will be used for control.

G ch: The global MIDI Channel (Global 1-1a) will be used for control. Normally you will use the G ch setting.

P (Effect Preset)

[P00, P01...15, U00...15, -----]

With Effect Presets, you can easily store and recall all of the settings for an individual effect. You can store up to 16 user presets for each effect type, in addition to 15 re-writable factory presets.

The same presets appear in all of the modes (Program, Combination, Sequence).

Note that edits to effects parameters are automatically stored with the Combination you don't need to store them as an Effect Preset. Presets just make it easier to re-use your favorite settings.

For instance, you can save an Effect Preset while working on a particular Combination, and then later use the same Effect Preset in a different Program, Combination, or Song.

P00: Initial Set: These are the default settings that are recalled when you select an effect type in the P9: MFx/TFx/LFO- Routing page. You can't save your own settings here.

P01...P15: Preset data is saved in this area. We recommend that you store your settings in U00-U15.

U00...U15: These are areas in which you can store your own settings.

-----: This shows that no Effect Preset has been selected. You'll see this if you've just selected an effect, written a Combination, or selected a new Combination. Selecting this setting from the menu will not have any effect.

Note: Combinations save the effects parameter settings, but they don't save the number of the selected Effect Preset. If you select an Effect Preset, and then save the Combination, the Effect Preset setting will revert to "-----."

For more details, please see "Using Effect Presets" on page 60.

MFx1 Parameters

Here, you can set the effect parameters of the insert effect you chose in the P9: MFx/TFx/LFO- Routing page.

For details on the master effects, please see the "Effect Guide" on page 235.

9-2: Menu Command

- 0: Write Combination see p. 101
- 1: Exclusive Solo see p. 64
- 2: Auto Setup Song see p. 101
- 3: Copy MFx/TFx see p. 67
- 4: Swap MFx/TFx see p. 67
- 5: Write FX Preset see p. 104

For more information, please see "Combination: Menu Command" on page 101.

9-3: MFx2, 9-4: TFX

These pages let you edit the parameters of Master Effect 2 and the Total Effect. To select different effects types, use the P9: MFx/TFx/LFO- Routing page.

The parameters for MFx2, TFX is the same as for MFx1. For more information, please see "9-2: MFx1" above.

9-5: Common FX LFO

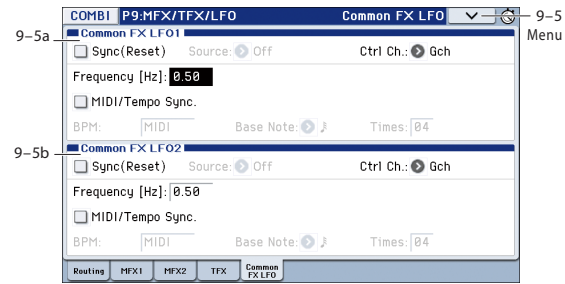

The two Common FX LFOs allow you to synchronize LFO-based modulation for multiple effects, such as phasers, flangers, filters, and so on.

The Common LFOs control only the frequency, MIDI synchronization, and reset options; each individual effect still has its own settings for the LFO waveform and phase.

Within the individual effects, you can choose whether to use one of the Common LFOs, or to use the individual effect's frequency, sync, and/or reset settings instead. This is done via the effect's LFO Type parameter; select **Individual** to use the effect's settings, or **Common 1** or **2** to use the Common LFOs.

9-5a: Common FX LFO1

Ctrl Ch (Control Channel) [Ch01...Ch16, G ch]

Specifies the MIDI channel that will control dynamic modulation (Dmod) for Common LFO 1 and 2.

G ch: The global MIDI channel (Global 1-1a) will be used for control. This is the default.

- Sync (Reset)** [Off, On]
- Source (Dmod Source)** [List of Dmod Sources]
- Frequency** [0.02...20.00 (Hz)]
- MIDI/Tempo Sync** [Off, On]
- BPM** [MIDI, 40.00...300.00]
- Base Note** [Musical notation]
- Times** [01...32]

These parameters are the same as in Program mode. For more information, please see "9-5: Common FX LFO" on page 100.

9-5b: Common FX LFO2

These parameters are the same as for Common FX LFO1.

9-5: Menu Command

- 0: Write Combination see p. 101
- 1: Exclusive Solo see p. 64
- 2: Auto Setup Song see p. 101
- 3: Copy Insert Effect see p. 66
- 4: Swap Insert Effect see p. 67

For more information, please see "Combination: Menu Command" on page 101.

Combination: Menu Command

ENTER + 0–9: shortcuts for menu commands

Each page has a set of menu commands, which provide access to different utilities, commands, and options, depending on the page you're currently on. You can use the menu commands entirely from the touch-screen, by pressing the menu button in the upper right-hand corner of the screen and then selecting an option from the menu that appears.

Even though each page may have its own unique menu commands, the menus are standardized as much as possible. For instance, WRITE is almost always the first menu item in Program, Combination, and Sequencer modes.

You can take advantage of this standardization by using a shortcut to access any of the first ten menu items:

1. **Hold down the ENTER button.**
2. **Press a number (0–9) on the numeric keypad to select the desired menu command, starting with 0.**

For instance, press 0 for the first menu command, 1 for the second, and so on.

If the menu command just toggles an option on and off (such as Exclusive Solo), then you're done. If the command calls up a dialog box, the dialog will appear on the display, and you can proceed just as if you'd selected the command from the touch-screen.

Tip: While this command is open, the ENTER button will operate as the OK button and the EXIT button will operate as the Cancel button.

Procedure for menu commands

1. **Select the menu command.**
2. **Make settings in the dialog box.**

For details on the content of each dialog box, refer to the explanation of each command.

3. **To execute, press the OK button. To cancel without executing, press the Cancel button.**

Write Combination

This command writes an edited Combination into the KROME internal memory. It is available on every page in Combination mode.

This lets you:

- Save your edits
- Rename the Combination
- Assign the Combination to a Category
- Mark the Combination as a Favorite
- Copy the Combination to a different Bank and number

Be sure to **Write** any Combination that you wish to keep. If you turn off the power, or select another Combination before writing an edited Combination, it cannot be recovered.

Note: You can also access and execute this command by pressing the WRITE button.

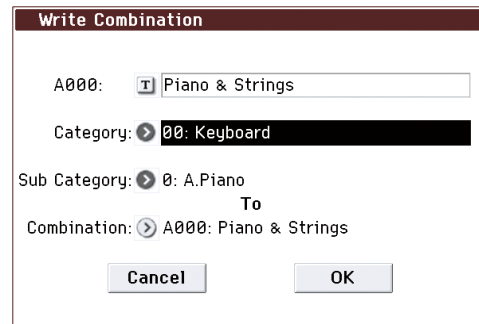

If you use **Category**, or **Sub Category** to specify a category for the combination you are writing, you will be able to select that combination by its category or sub category in Combi P0: Play.

The names of the combination categories can be edited in P4: Category–Combination Main and Combination Sub page.

Exclusive Solo

This command is available on every page in Combination mode. When **Exclusive Solo** is **On**, only one Timbre is soloed at a time; when it is **Off**, multiple Timbres can be soloed together.

For more information, please see “Exclusive Solo” on page 64.

Auto Setup Song

This command automatically copies the settings of the program or combination to a song, and enables the record-standby status (See “Tip: Auto Song Setup” on page 70.).

Copy from Program

This command is available on every page in Combination mode. It copies Effects settings from a selected Program to the current Combination. This lets the Program sound the same as it did in Program mode.

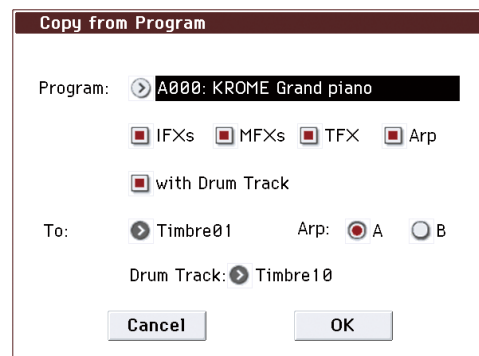

1. **Use Program to select the copy-source program.**
2. **Select the IFXs used, MFXs, and TFX options to specify which, if any, of the Program's effects settings to copy.**

IFXs: The settings of all insert effect settings (the contents of the Insert FX setup page and the IFX1–5 effect parameters) of the copy-source program will be copied.

MFXs: All master effect settings of the copy-source program will be copied.

TFX: All total effect settings of the copy-source program will be copied.

About the Bus (IFX/Output) Select (Combi 8–1(2)d, 8–3b) setting

- Regardless of the **IFXs used**, **MFXs**, and **TFX** settings, will be set to DKit if the copy-source program’s **Use DKit Setting** is checked. In conjunction with this, the **Drum Kit IFX Patch** setting will be reset to the default setting.
 - If **IFXs** is checked, the **Bus (IFX/Output) Select** setting of the copy-source program will be copied. If the copy-destination timbre **Bus (IFX/Output) Select** was set to IFX1–IFX5, it will automatically be set to L/R. If you check **IFX-All used**, the routing will be automatically set to match the copy-source program.
 - If **IFXs used** is unchecked, then the copy-source **Bus (IFX/Output) Select** setting will be ignored. or if the **Bus (IFX/Output) Select** of the copy-source program and copy-destination timbre is set to IFX1–IFX5, it will automatically be set to L/R.
- 3. If you check “Arp,” the Program’s arpeggiator settings will also be copied.**

If this is On (checked), the arpeggiator settings of the copy-source program will be copied to the “Arp” you specify in step 8, and that arpeggiator’s **Arpeggiator Run** setting will be turned on and assigned to the copy-destination timbre (“Arpeggiator Assign”).

- 4. If you check “with Drum Track,” the Drum Track Pattern settings of the copy-source program will also be copied.**

If this is On (checked), the Drum Track Pattern settings of the copy-source program will be copied to the “Drum Track” you specify in step 9.

The MIDI channel specified for the Drum Track copy-destination timbre will be used.

- 5. Use the To field to specify the copy-destination timbre.**

The parameters for each timbre will be initialized. The copy-source program will be assigned to **Program** (see “0–1(2)b: Program Select” on page 72).

- The **MIDI Channel** (Combi 3–1(2)c) setting will not change if “Arp” is checked. If “Arp” is unchecked, **MIDI Channel** will be automatically set to G ch.
 - The **Bank Select (When Status=EX2)** (Combi 3–1(2)c) setting will not change.
 - The **Status** (Combi 3–1(2)c) setting will automatically be set to INT.
 - The P1: Basic/Controllers– Controllers Setup settings of the copy-source program will be copied.
- 6. Use the “Arp” field to select the copy-destination arpeggiator; either A, B, C, or D.**
- 7. Use the “Drum Track” to specify the destination timbre to which the drum track program will be copied.**

Copy Tone Adjust

This command replaces the Tone Adjust settings of the selected Timbre (Combination mode) or Track (Sequencer mode) with those of any other Program, Timbre, or Track.

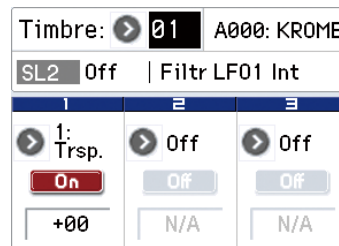

- 1. Select the Timbre (Combination mode) or Track (Sequencer mode) whose Tone Adjust settings you want to replace.**

For a timbre, access the Combi P0: Play– Tone Adjust page, and select the **Timbre**.

For a track, access the Seq P0–2: Play/REC– Tone Adjust page, and select the **Track**.

- 2. Select “Copy Tone Adjust” to open the dialog box.**

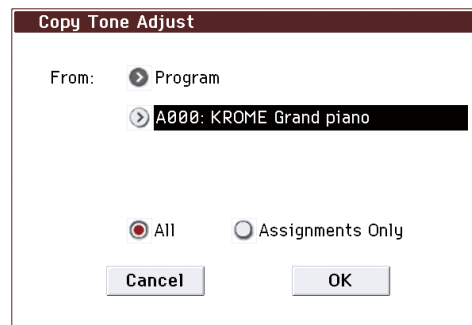

- 3. Use the From field to select the Program, Combination, or Song from which to copy.**

You can also use the front-panel BANK buttons to select the desired bank.

- 4. If you’ve selected a Combination or Song, select a specific Timbre or Track as well.**
- 5. Choose either All or Assignments Only to select the Tone Adjust parameters that you want to copy.**

All: This copies both the Tone Adjust parameter assignments and values.

Assignments Only: This copies only the Tone Adjust parameter assignments, without the values.

Reset Tone Adjust

Reset Tone Adjust is available on the Tone Adjust tab of the play page.

This command affects only the selected Timbre or Track, as opposed to the entire Combination or Song. It resets the Tone Adjust settings for all of the Track/Timbre's, Switches, and Sliders to their default values.

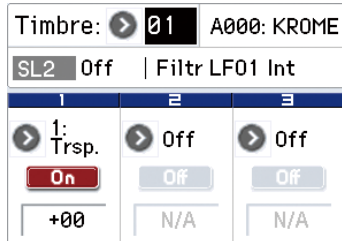

1. Select the **Timbre (Combination mode)** or **Track (Sequencer mode)** to reset.

For a timbre, access the Combi P0: Play– Tone Adjust page, and select the **Timbre**.

For a track, access the Seq P0–2: Play/REC– Tone Adjust page, and select the **Track**.

2. Select **“Reset Tone Adjust”** to open the dialog box.

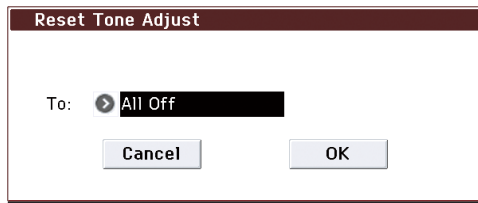

3. Use the **To** field to specify how the **Tone Adjust parameters** will be reset.

All Off: All parameters will be reset to Off.

Default Setting: The parameters will be reset to the default settings for the corresponding program type.

Copy Drum Track

This command copies the drum track settings of the specified Program, Combination, or Song.

For more information, please see **“Copy Drum Track”** on page 65.

Erase Drum Track Pattern

This erases the drum track pattern you specify.

For more information, please see **“Erase Drum Track Pattern”** on page 66.

Copy Arpeggiator

Copy Arpeggiator is available on the ARP Setup T01–08– Scan Zone tabs of the ARP/DT page.

This command can copy arpeggiator settings from another location to the current Combi.

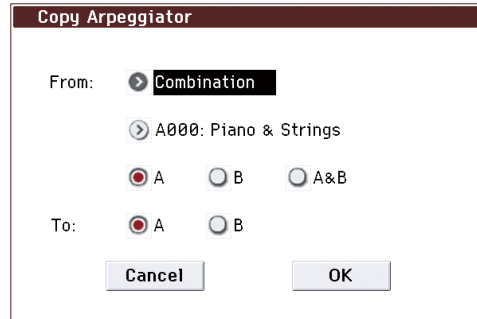

1. In **From**, select the source (mode, bank, number) of the **arpeggiator** you wish to copy.

If you are copying from a Combination or Song, select either **A** or **B**, if you wish to copy settings from only one arpeggiator, or select **A&B** if you wish to copy the settings of both arpeggiators.

2. If you are copying from a Program, or are copying either **A** or **B** from a Combination, or Song, select either **A** or **B** as the **To copy destination**.

Detune BPM Adjust

Detune BPM Adjust is available on the Pitch tab of the Timbre Parameters page.

This command changes a loop's tempo by changing the Timbre's **Detune** parameter. The multisample data itself is not altered. Since this alters the pitch of the loop along with the tempo, it's generally intended for un-pitched percussive loops.

Note: Using **Detune BPM Adjust** will over-write any previous **Detune** settings.

1. Go to the **Pitch** tab of the **Timbre Parameters** page.
2. Select the **Detune** parameter for the desired **Timbre**.

Detune BPM Adjust is available only when the **Detune** parameter has been selected. Otherwise, the menu selection will be grayed out.

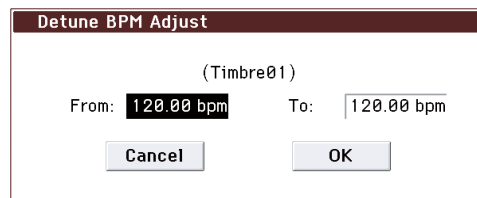

3. In **From**, specify the **loop's original BPM** value.

Ignore any previous changes from using **Detune BPM adjust**.

4. In **To**, specify the **desired BPM** value.

The appropriate **Detune** value will be calculated automatically from these two values.

For example, if you set **From** to 60 bpm and **To** to 120 bpm, **Detune** will be set to +1200 (one octave up).

Note: Since this command does not affect the multisample data itself, and always over-writes the previous **Detune** amount, using it repeatedly has no cumulative effect.

Copy Insert Effect

Copy Insert Effect is available on all of the IFX pages.

This command copies effects settings from Program, Combination, or Song. For more information, please see “Copy Insert Effect” on page 66.

Note: The slot’s MIDI control channel, as specified by the **Ch** parameter on the P8: Routing/IFX– IFX1–5 pages, will not be copied.

Swap Insert Effect

Swap Insert Effect is available on all of the IFX pages.

This command swaps (exchanges) insert effect settings. For more information, please see “Swap Insert Effect” on page 67.

Note: The slot’s MIDI control channel, as specified by the **Ch** parameter on the P8: Routing/IFX– IFX1–5 pages, will not be swapped.

DrumKit IFX Patch

This patches the **Bus (IFX/Output) Select** settings for each key of a drum kit, temporarily changing the insert effect connection destinations.

You can execute this command if the program assigned to the timbre is a drum program and **Bus (IFX/Output) Select** is set to **DKit**. The **Bus (IFX/Output) Select** setting (Global 5–5b) of each key in the drum kit must be set to one of IFX1–5.

1. In the **Routing1** page or **Routing2** page, select the timbre for which you want to make settings. (Select a timbre parameter or Timbre Number.)
2. Select “DrumKit IFX Patch” to open the dialog box.

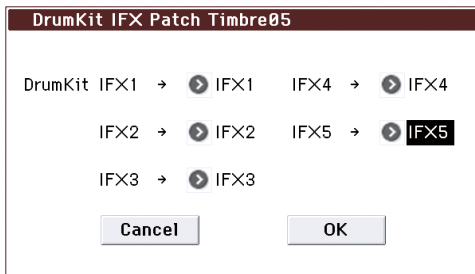

3. In the DrumKit “IFX” popup, select the output bus to which you want to patch the signal: an insert effect or L/R or Off.

Note: To restore the condition of the drum kit, execute IFX1→IFX1, IFX2→IFX2, IFX3→IFX3, IFX4→IFX4, IFX5→IFX5 (see page 95).

Copy MFX/TFX

Copy MFX/TFX is available on all of the MFX/TFX/LFO pages.

This command copies effect settings from Program, Combination, or Song. For more information, please see “Copy MFX/TFX” on page 67.

Note: The slot’s MIDI control channel, as specified by the **Ch** parameter on the P9: MFX/TFX/LFO– MFX1 and TFX page, will not be copied.

Swap MFX/TFX

Swap MFX/TFX is available on all of the MFX/TFX/LFO pages.

This command swaps (exchanges) insert effect settings. For more information, please see “Swap MFX/TFX” on page 67.

Note: The slot’s MIDI control channel, as specified by the **Ch** parameter on the P9: MFX/TFX/LFO– MFX1 and TFX page, will not be copied.

Write FX Preset

Write FX Preset is available on all of the effects parameter editing pages, including IFX 1–5, MFX 1 and 2, and TFX.

This command saves the edited effect into the KROME’s internal memory.

For more information, please see “Write FX Preset” on page 67.

Sequencer mode

An overview of Sequencer mode

Sequencer Mode lets you record and play back MIDI data on sixteen MIDI tracks and one master track (containing tempo data, etc.), using the internal sound generator or external sound modules.

The dual arpeggiator, drum track function, RPPR function; the sophisticated effects, controllers, and the numerous other functions of the KROME can be used together to give you a wide range of possibilities for music production or live performance.

 When you turn off the power, the Sequencer mode settings, the songs you've recorded, the cue list, and the user pattern data will disappear. If you need to keep this data, you must save it to an SD card or a data filer (via MIDI Data Dump) before powering-off.

If you wish to save the programs, track parameters, and effects, settings etc. selected for a song as a template song, use the menu command **Save Template Song**.

When you initially power up the KROME, it will not contain any cue list and song data, so if you wish to playback a song on the sequencer, you must first load data (See "Load Preload/Demo Data" on page 216.).

MIDI sequencer

- The sequencer can record a maximum of 210,000 MIDI events, up to 128 songs, and as many as 999 measures per song.
- Up to **20 cue lists** can be created.
A cue list is an arrangement of up to 99 songs that will be played as a chain. You can specify the number of times that each song will repeat. A cue list can also be converted into a single song.
- Timing resolution is a maximum of $\downarrow/480$.
- There are sixteen tracks for MIDI performance data, and a master track that controls the time signature and tempo.
- The arpeggiator can be used during playback or recording.
- You can perform or record using the Drum Track function.
- The RPPR (Realtime Pattern Play/Recording) function can be used during playback or recording.
- A three-band EQ is provided on each MIDI track.
- For each song, you can use five stereo insert effects, two stereo master effects, and one stereo total effect.
- Sixteen different template songs are built-in, and contain program and effect settings suitable for various musical styles. Up to sixteen original templates that you create can be saved as user template songs.
- A track play loop function lets you loop specified measures independently for each track.
- Preset patterns ideal for drums are built in. In addition, you can create up to 100 user patterns for each song. These patterns can be used as musical data within a song, or can be played by the drum track or the drum track and/or RPPR function.

MIDI recording features

- Various methods of recording are supported, including realtime recording, in which your performance on the keyboard and controllers (including MIDI control events) is recorded as you play, and step recording, in which the

timing, length, and velocity of each note can be specified in the display as you input the pitches from the keyboard.

- The musical data and control events that you recorded can be edited in various ways (including event editing and many other edit commands).
- MIDI System Exclusive (SysEx) messages can be recorded and played back. SysEx messages received from an external MIDI device or parameter changes produced by editing track parameters or effect parameters can be recorded in real-time on any desired track.

Parameter-related features

- When the **Status** of a track is set to INT or BTH, an external sequencer can be used to play the KROME as a multi-timbral tone generator. When the **Status** of a track is set to BTH, EXT, or EX2, the sequencer of KROME can play external tone generators.
- **Tone Adjust** parameters let you make temporary adjustments to the sound of the program used by a track, while leaving the original program unchanged. While creating a song, you can use this capability to make changes in realtime by (for example) softening the tone of the bass sound or sharpening the attack of the strings without having to return to Program mode to edit the program itself.
- KROME's AMS (Alternate Modulation) capability lets you use control changes for Realtime Controls of the parameters of the programs used in a program. Its MIDI Sync abilities let you synchronize the LFO speed to changes in the tempo.
- Dmod (Dynamic Modulation) functionality lets you control effect parameters in realtime. You can also use MIDI Sync to synchronize the LFO speed or delay time to changes in the tempo.
- The MIDI clock master can be set to Internal, External, or Auto, allowing synchronized performance with an external MIDI device.

Editing and operation features

- The Auto Song Setup function lets you instantly set up program or combination settings of Program mode or Combination mode as a song, so that you can start recording simply by pressing the START/STOP (▶/■) button. Since performances using the Drum Track function or Arpeggiator in Program or Combination mode are seamlessly integrated with song production, any inspiration or ideas for phrases and songs that occur to you while playing can be immediately be turned into a song.
- Program and Combination settings can be copied to a song.
- Sequencer data such as a song that you create can be saved in the KROME's native format, or transmitted as a MIDI data dump.
- A song you created can be converted into SMF (Standard MIDI File) data. SMF songs can also be loaded.
- The **Play/Rec/Mute** and **Solo On/Off** buttons let you instantly play/mute any desired track on the fly.
- You can rewind or fast-forward MIDI Tracks while listening to the sound.

- You can assign names not only to the song, but also to each pattern and track.
- The LOCATE button lets you move quickly to a desired location.
- You can convert user pattern data for use in the drum track. The converted pattern can be used as a drum track pattern in each mode. This data will remain even after the power is turned off (unlike user patterns in Sequencer mode).
- You can drag within the display to specify a range of measures, or to move, copy, or delete. This lets you edit in a more intuitive way (Track View editing).
- In the piano roll screen, you can now edit data such as note, velocity, and control change. By selecting an event and dragging it you can modify the pitch or timing, delete it, or add a new event (Piano Roll editing).
- You can edit MIDI system exclusive data.
- Note-on velocity values are shown in realtime using a meter. This is a convenient way to verify the timbre or track that is currently sounding.

Setup parameters & Musical data

Each song consists of MIDI tracks 1–16, a master track, various song parameters such as the song name, settings for the arpeggiator, drum track function, effect settings, RPPR function parameters, and 100 user patterns.

Up to 128 such songs can be created in the KROME.

MIDI tracks 1–16 each consist of “track parameters” that specify the starting state of the track, and “playback data.” The master track consists of tempo and time signature data.

MIDI tracks 1–16

Setup parameters

Bank/Program No.*, Play/Rec/Mute, Pan*, Volume*

Track Play Loop, Loop Start Measure, Loop End Measure, Play Intro, EQ (Bypass, Low Gain, Mid Frequency, Mid Gain, High Gain) Status, MIDI Channel, Bank Select (When Status=EX2), Force OSC Mode, OSC Select, Portamento*, Transpose**, Detune**, Bend Range**, Use Program's Scale, Delay (Mode, Time, Base Note, Times), MIDI Filter, Keyboard Zone, Velocity Zone, Track Name, Bus (IFX/Output) Select, FX Control Bus, Send1(MFX1)*, Send2(MFX2)*, Drum Kit IFX Patch

Musical data

Note On/Off
 Program Change (including Bank Select)
 Pitch Bend
 After Touch
 Control Change
 Pattern No.
 Exclusive Message

Master track

Setup parameters/Musical data

Time signature*, Tempo*

* When you change the setting during realtime-recording, this will be recorded as musical data (Program change and Control change messages). This allows the starting settings to be modified during the playback.

** Musical data (MIDI RPN data) can be used to change the starting settings during playback.

Other parameters: You can adjust parameters during realtime recording and record these changes as MIDI System Exclusive messages. This means that the settings at the start of playback can change as the song progresses.

- For details on Control Change messages and RPN, please see “Control change” on page 361, and “Using RPN (Registered Parameter Numbers)” on page 365.
- For details on MIDI System Exclusive messages, please see “System Exclusive events supported in Sequencer mode” on page 191.

The Global mode “SEQ Mode” setting

In Sequencer mode, you will normally use the internal sequencer as the master that controls the internal sound generator or external MIDI sound modules. However, you can also use the KROME as a multi-timbral sound module that can simultaneously play multiple tracks of performance data from an external MIDI sequencer. (Normally, you'll use Combination mode if you want to use the KROME as a master keyboard.)

You can switch the KROME's setting as appropriate for these two purposes. This setting is made in Global P1: MIDI-MIDI Basic page SEQ Mode **Track MIDI Out**.

“for Master” is the appropriate setting if you want to use the KROME's internal sequencer to control an external sound module, or use the KROME in Sequencer mode as a master keyboard. In this case when you switch songs on the KROME, tracks whose **Status** is set to EXT or BTH can transmit MIDI messages such as program changes to set up your external MIDI sound module.

“for External-Sequencer” is the appropriate setting if you want to use the KROME as a multi-timbral sound module for your external sequencer. When you switch songs on the KROME, MIDI messages such as program changes will not be transmitted (by tracks whose **Status** is EXT or BTH). This ensures that echo-back from your external MIDI sequencer will not cause KROME tracks of the corresponding MIDI channel to switch their program, pan, or volume settings.

Auto Song Setup

The Auto Song Setup function copies the settings of a program or combination to a song, and puts you in record-ready mode. Then you can simply press the START/STOP (▶/■) button to begin recording immediately. This lets you seamlessly move from playing a program or combination to producing a song. For example, if you've been using the drum track or arpeggiator and have come up with a phrase or an idea, this function lets you easily turn your inspiration into a song.

Procedure (example: Combination mode)

1. Enter Combination mode.
 2. In P0: Play page, select the desired combination and edit the Arpeggiator etc. as desired.
- Note:* If you want to save the edited state of the combination, use the **Write Combination** menu commands.
3. Press the REC (●) button. Alternatively, select the page menu command “Auto Song Setup.”

The Setup to Record dialog box will appear.

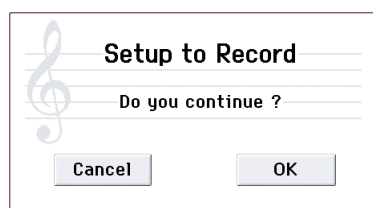

4. To execute the Auto Song Setup function, press the REC (●) button or the OK button. If you decide not to execute, press the Cancel button.

You will automatically move to Sequencer mode, and the settings of the combination will be copied to the song.

The first unused song will be the copy-destination song.

Contents automatically copied from a combination

The copied contents will be the same as when you execute the menu command **Copy From Combi** with the following settings in the dialog box. (see p.166)

- **IFXs, MFXs, TFX** checked
- **Auto Adjust Arp setting for Multi REC** checked

Contents automatically copied from a program

The copied contents will be the same as when you execute the menu command **Copy From Program** with the following settings in the dialog box. (see p.101)

- **IFXs, MFXs, TFX** checked
 - **Arp** checked
 - **To** set to Track 01
 - **Arp** set to A
 - **with Drum Track** checked
 - **To: Drum Track** set to Track 10
 - Check Recording Setup **Multi REC**
 - Set the **Play/Rec/Mute** setting to REC for tracks 01 and 10 (see p.112).
5. **The KROME will automatically enter record-ready mode, and the metronome will sound according to the Metronome setting (Seq 0–8c).**
 6. **Press the START/STOP (▶/■) button to begin real-time recording. To stop recording, press the START/STOP (▶/■) button once again.**

The Compare function

When you perform realtime recording, step recording, or track editing, this function allows you to make before-and-after comparisons.

If you continue editing when the COMPARE button is lit, the switch will go dark. This now becomes the musical data that will be selected when the COMPARE button is dark.

Operations for which Compare is available

In general, track and pattern event data can not be returned to its original state.

Comparing song parameters is possible only during song editing (when executing a menu command).

- Recording to a MIDI track
- Track Edit
 - All commands except for the menu commands **Memory Status**, **Exclusive Solo**, **FF/REW Speed** and **Set Location** of the P6: Track Edit– Track Edit page.
- Recording to a pattern
- Pattern Edit
 - All commands except for the menu commands **Memory Status**, **Exclusive Solo**, **Convert to Drum Trk Pattern**, **Erase Drum Track Pattern**, and **FF/REW Speed** of the P10: Pattern/RPPR– Pattern Edit page.
- Song Edit
 - P0–P5 pages: menu commands **Delete Song** and **Copy From Song**



The program will not be affected by the Compare, and will not return to its prior state.

Operations for which Compare is not available

- Editing song parameters
- Menu commands other than those listed under “Operations for which Compare is available” above.

SEQ Page Select

You can use the following ways to select the pages in Sequencer mode.

1. Press the SEQ button, and then press the MENU button to access "Page Select."

"Page Select" shows an abbreviated name for each page.

The page shown in grey is the page selected just prior to pressing the PAGE button.

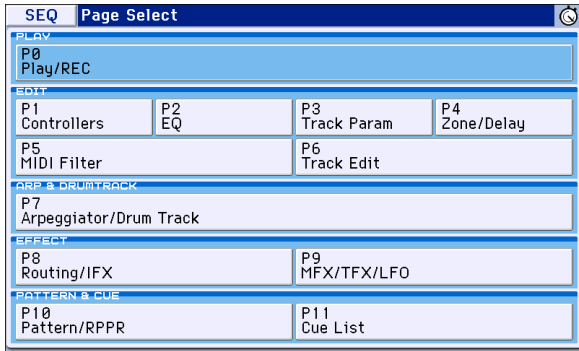

2. Select the desired page in the display.

Other ways to select pages

- Hold down the PAGE button and press one of the numeric keys, 0–9, to specify a page number and to access the corresponding page.
For example, if you want to access the P3: Track Param page, hold down the PAGE button and press numeric key 3.
- Pressing the EXIT button will take you to the P0–1: Play/REC page. If a page other than the Program T01–08 page is selected, pressing the EXIT button will take you to the Program T01–08 page.

| | Page | Main content |
|------------------|----------------------------|--|
| PLAY | P0: Play/REC | Song selection, playback, and recording. (see p.109) Program selection for each track. (see p.111) Pan and volume settings etc. for each track. (see p.113) Simple arpeggiator editing. (see p.114) Tone Adjust editing. (see p.115) Recording method selection. (see p.116) Track playback loop settings. (see p.119) |
| | P1: Controllers | SW1, 2, and knob settings. (see p.122) |
| EDIT | P2: EQ | EQ settings for each track. (see p.141) |
| | P3: Track Param | Various parameter settings for each track (MIDI channel, OSC selection, Pitch setting, etc.) (see p.125) |
| | P4: Zone/Delay | Key split and layer settings. (Key zone and velocity zone) (see p.129) Time delay from note-on to beginning of sound. (see p.131) |
| | P5: MIDI Filter | MIDI transmit/receive filter settings. (see p.133) |
| | P6: Track Edit | Step recording. Piano roll edit. Event recording. Copy, delete, and other track editing. (see p.137) |
| ARP & DRUM TRACK | P7: Arpeggiator/Drum Track | Arpeggiator settings. (see p.143) Drum track settings. (see p.146) |
| EFFECT | P8: Routing/IFX | Oscillator output bus and master effect send level settings. (see p.148) Insert effect routing, selection, and settings. (see p.148) |
| | P9: MFX/TFX/LFO | Master effect routing, selection, and settings. (see p.152) Total effect selection and settings. (see p.152) Common FX LFO settings (see p.154) |
| PATTERN & CUE | P10: Pattern/RPPR | Pattern recording and editing. (see p.155) RPPR settings. (see p.158) Converting a pattern to a drum track pattern. (see p.188) |
| | P11: Cue List | Cue list settings. Consecutive playback of multiple songs. Converting to a song. (see p.160) |

SEQ P0: Play/REC

0-1: Program T01-08, 0-2: Program T09-16

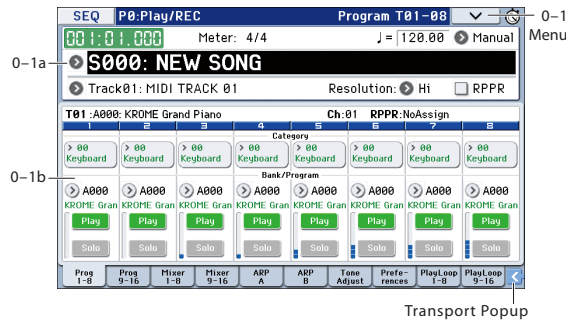

Here, you can make basic settings for MIDI track recording and playback, and can select the program that will be used by each track.

0-1(2)a: Location, Meter, Tempo, Tempo Mode, Song Select, Track Select, Reso, RPPR

Location [001:01.000...999:16.479]

This display shows the current position in the song. From the left, the numbers are the measure (001-999), beat (01-16), and clock (000-479). When you modify these values, the current location will change.

During playback and recording, the number of remaining measures will be displayed when you approach the end of the song (the last 9 measures or fewer).

The song position bar will show the position of the current measure.

MIDI When **MIDI Clock** (Global 1-1a) is set to **Internal** (or **Auto**, if no MIDI clocks are being received), the KROME will transmit Song Position Pointer messages when the **Location** is changed.

Also, if the **MIDI Clock** parameter is set to **External MIDI** (or **Auto**, if MIDI clocks are currently being received), and **Receive Ext. Realtime Commands** (Global 1-1a) is on, the **Location** will change in response to received Song Position Pointer messages.

⚠ The range in which the beat and clock can be modified will depend on the currently specified time signature.

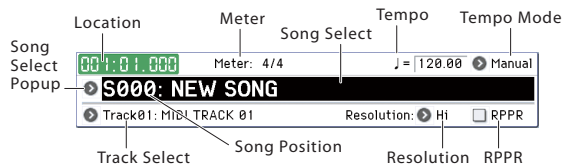

Meter [**/**, 1/4...16/4, 1/8...16/8, 1/16...16/16]

This is the time signature at the current location of the song. The time signature can be changed at each measure.

****/****: This will be displayed when you press the REC (●) button. Specify this when you wish to use the time signature that is already recorded for that measure, and wish to record without changing the time signature.

Set **Track Select** to a Track from 01-16, press the REC (●) button, and specify the time signature here.

When you press the **START/STOP** (▶/■) button to begin recording, the time signature you specify will be recorded on the Master Track and on previously recorded tracks.

Be aware that if you press the **START/STOP** (▶/■) button during the pre-count to stop recording, the time signature will not be recorded.

Normally, you will specify the time signature when you record the first track, and select ****/**** when recording subsequent tracks.

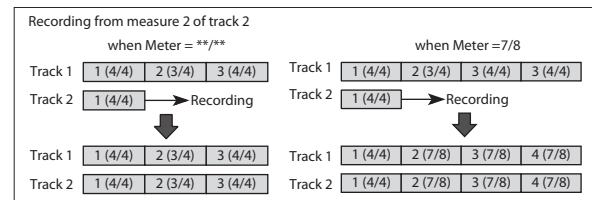

Changing the time signature in the middle of a song

Changing the time signature before data is recorded:

If you know the location at which you wish to change time signatures, use the **Insert Measure** menu command to specify and insert the time signature wherever desired, and then record your musical data.

Changing the time signature after data has been recorded:

If you wish to change the time signature in the middle of a song which already contains musical data, use **Track Select** to specify the Master Track (or any Track 01-16 which contains data), and use the **Event Edit** menu command to modify the time signature of the Bar event.

If the number of beats in a measure increases when you modify the time signature, rests will be inserted in the portion that was added. Conversely if the number of beats decreases, that portion will not be played. However if you return to the original time signature, the data that had been hidden will once again be played. (The data itself will not be erased.)

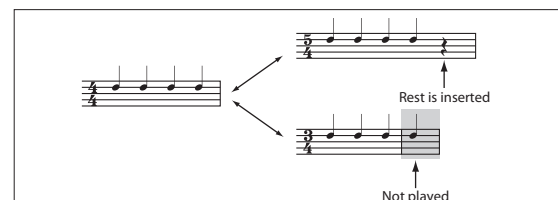

♩ **(Tempo)** [040.00...300.00, EXT]

This specifies the tempo of the song. This tempo applies to song playback, arpeggiator and drum track function, etc.

040.00...300.00: When the **Tempo Mode** is Manu (Manual), this tempo will be used for recording and playback. When **Tempo Mode** is REC, this tempo will be recorded on the master track.

EXT: This will appear when **MIDI Clock** (Global 1–1a) is set to either External MIDI, External USB or Auto. The tempo of the internal sequencer will synchronize with MIDI Clock messages received from an external sequencer or other MIDI device.

If **MIDI Clock** (Global 1–1a) is set to **Internal**, the above tempo setting (040.00–300.00) is used. If you’ve selected Auto, operation will automatically switch from Internal to External if MIDI Clock data is received from an external MIDI device. This indication will appear.

Note: You can also adjust this by turning the TEMPO knob. Alternatively, you can set the tempo by pressing the TAP button at the desired interval.

Note: If Tempo is selected as an alternate modulation source, ♩ = 120.00 will be the base value.

To record tempo changes

First, set **Track Select** to a MIDI Track.

Press the REC (●) button to enter recording-standby mode, you will be able to select REC.

Set **Tempo Mode** to REC, start recording, and change the ♩ **(Tempo)** value either by turning the TEMPO knob, or using numeric keys 0–9 to enter a value and then pressing the ENTER button. You can also vary the tempo by hitting the TAP button at the desired timing.

This cannot be selected when the Preferences page item **Recording Setup** is set to Loop All Tracks.

When you change the ♩ **(Tempo)** value while recording, the tempo changes will be recorded, causing the tempo to change as the song progresses.

Tempo changes can also be created using the **Event Edit** or **Create Control Data** menu commands.

Note: If you wish to record only the tempo changes, set **Recording Setup** (Seq 0–8b) to Overdub, and the tempo will be recorded on the master track without being affected by the musical data of **Track Select**.

Tempo Mode [Auto, Manual, REC]

Auto: The tempo will follow the tempo of the Master Track. The tempo of the master track can be specified by using the **Event Edit** menu command, with the Master Track chosen in **Track Select**, or by the REC operation described below. When Auto is selected, it will not be possible to modify the ♩ **(Tempo)** setting while a song is playing or recording (or during standby).

Manu (Manual): The ♩ **(Tempo)** setting will be used.

REC: Tempo changes will be recorded on the Master Track.

Song Select [000...127]

Select the song that you want to record or play back.

Either select the song name from the popup menu, or use numeric keys 0–9 to specify the song number and then press the ENTER button.

Creating a new song

Choose a number from the popup menu whose song name is blank, or use the numeric keys 0–9 to specify the song number and press the ENTER button to open the dialog box. Then select **Set Length** to specify the number of measures in the song, and press the OK button.

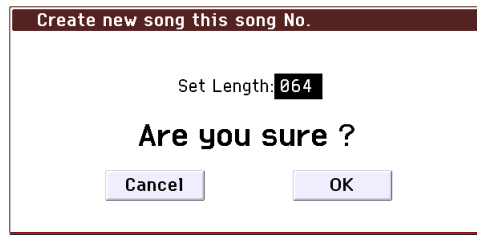

Note: If you want to change the length of a song after creating it, use the menu command **Set Song Length**. When creating a new song, you can specify the length to be somewhat longer than necessary, and after you have finished recording and editing, use **Set Song Length** to specify the correct length.

MIDI A Song Select message is transmitted when you switch songs on the KROME. You can switch songs on the KROME remotely, by sending a Song Select message from an external MIDI device.

If **Track MIDI Out** (Global P1: MIDI– MIDI Basic) is set to “for Master,” and the song is switched, tracks whose track status (**Status** 3–1(2)a) is EXT, EX2, or BOTH will transmit Bank Select, Program Change, Volume, Panpot, Portamento, Send 1/2, Post IFX Pan, and Post IFX Send 1/2 messages on the MIDI channel of that track. These messages will not be transmitted if **Track MIDI Out** is set to “for External Sequencer.”

Track Select [Track01...Track16, Master Track]

Track 01–Track 16: Select the MIDI track that you want to record. This is also where you make your selection when editing a MIDI track in P6: Track Edit.

When **Multi REC** is off, this also selects the record-enabled track.

When **Multi REC** (Seq 0–8b) is on, the **Play/Rec/Mute** buttons (Seq 0–1(2)b) select the record-enabled tracks, regardless of the **Track Select** setting.

Use **Track Name** (Seq 6–2) to give the track a descriptive name.

MIDI If other tracks are set to the same MIDI channel as the selected track, and their **Status** is set to INT or BTH, they’ll be controlled by the keyboard as well. Additionally, other tracks set to the same MIDI channel as the selected track, and their Status set to EXT, EX2, or BTH, will transmit MIDI to external devices. For another look at this, please see the table below.

| MIDI Channel | Status | Keyboard plays Internal Sounds | Keyboard Transmits MIDI Out |
|--|-------------|--------------------------------|-----------------------------|
| Same as the selected MIDI Track | OFF | No | No |
| | INT | Yes | No |
| | EXT | No | Yes |
| | EX2 | No | Yes |
| | BTH | Yes | Yes |
| Different from the selected MIDI Track | Any setting | No | No |

If you’ve selected Master Track, the settings of the most recently selected MIDI track will be used.

Master Track: Select the master track if you want to use the P6: Track Edit menu commands to edit the master track. You cannot perform realtime recording or step recording on the master track by itself.

Program Select [A...F: 000...127 GM, g(1)...g(9), g(d): 001...128]

Selects the program that will be used by each MIDI track.

The lower line displays part of the program name.

The program you select here will be used when the song is played or recorded from the beginning. If the program is changed while recording, the program change will be recorded as MIDI data, and the program will change during playback. You can also change the program manually during playback. However, the program will change at any point where program change data is already recorded.

MIDI If the **Status** (Seq 3–1(2)c) is either INT or BTH, programs can be selected by receiving MIDI program change messages. Also, when the song is changed or when the song returns to the beginning, tracks whose **Status** is EXT, EX2 or BTH will transmit the bank and program numbers via MIDI. Tracks whose **Status** is EX2 will show Bank as “–” and will transmit the bank number that was selected in the **Bank Select** (Seq 3–1(2)c) parameter. (See Global P1: MIDI, SEQ Mode “Track MIDI Out” on page 200)

Various ways to change the program for a track

- Choose **Program Select**, use numeric keys 0–9 to input a program number, and press the ENTER button.
- Choose **Program Select**, and turn the VALUE dial or use the INC/DEC buttons.
- If you’ve chosen **Program Select**, the front-panel BANK A–F buttons will change the program bank for the selected track. The BANK button for the bank containing the selected program will light up. You can use the numeric keys to switch the GM bank (see p.2).
- Use the Bank/Program Select menu to view and select programs by bank.
- Use the Category/Program Select menu to view and select programs by category.
- Transmit MIDI program change messages from a connected external MIDI device (if the track **Status** is INT or BTH).
- You can also use the above methods to **switch programs while a song is playing**. If you switch programs while recording, the program change data will be recorded, and the program will switch at that point in the song during playback. You can also use the menu command **Event Edit** to add program change data to a track.

Play/Rec/Mute [Play, Rec, Mute]

Use this to mute a MIDI track, or to select the recording tracks for multi-track recording.

During playback, or for single-track recording (normal recording), you can only select Play or Mute for tracks— with the exception of the recording track. For multi-track recording, tracks can be set to Play, Rec, or Mute.

Each time you press the Play/Rec/Mute button, it will toggle between those functions.

Play: The track will play.

Rec: For single track recording, the selected track will be set to REC when you press the REC (●) button. REC cannot be manually selected.

For multi-track recording (the Preferences page **Multi REC** is on), select REC for the tracks that you wish to record.

Mute: The track will be muted (silent).

Solo On/Off [On, Off]

Turns the Solo function on/off for each track.

Only tracks with Solo On will sound. Other tracks will be muted.

The setting will alternate on/off each time you press the Solo button.

The operation will depend on the **Exclusive Solo** setting.

Exclusive Solo off: Multiple tracks can be soloed. The solo setting of each track will change each time you press its Solo On/Off button.

Exclusive Solo on: When you press a Solo On/Off button, only that track will be soloed.

MIDI If MIDI tracks whose **Status** (Seq 3–1(2)c) is BTH, EXT, or EX2 are muted by Mute or by the Solo function, note on/off messages will not be transmitted on the MIDI channel selected for those tracks.

 **Solo** settings are not saved with the song.

Exclusive Solo

The menu’s **Exclusive Solo** parameter also affects the way that Solo works. When **Exclusive Solo** is **Off** (unchecked), you can solo multiple Tracks at once. The solo setting of each track will change each time you press its Solo On/Off button.

When **Exclusive Solo** is **On** (checked), only one Track can be soloed at a time. In this mode, pressing a Solo button automatically disables any previous solos.

Tip: On most pages, you can also toggle **Exclusive Solo** on/off by holding down the ENTER button and pressing numeric key 1.

Velocity Meter

This meter shows the note-on velocity value.

- This indicates the note-on velocity values on the MIDI channel of each track, produced by the keyboard, MIDI IN, arpeggiator, drum track, or sequencer. (If multiple note-on messages are received simultaneously, the highest velocity will be displayed.)
- The meter will respond even if Key Zone or Vel Zone settings are set so that the note does not actually sound.
- This meter indicates the note-on velocity value; it does not respond to changes in the Volume knob setting, nor to changes in the level of the audio signal produced by the Filter, Amp, EG, LFO, EQ, or effects.

Track 02...08, 09...16 (Track Number):

Here, you can specify the program, Play/Mute status, and Solo On/Off status for Tracks 2–8 and 9–16. These are the same as for Track 01. For more information, please see “Track 01 (Track Number):” above.

✓ 0–1(2): Menu Command

- 0: **Memory Status** see p. 163
- 1: **Exclusive Solo** see p. 64
- 2: **Rename Song** see p. 163
- 3: **Delete Song** see p. 163
- 4: **Copy From Song** see p. 163
- 5: **Load Template Song** see p. 163
- 6: **Save Template Song (Save as User Template Song)** see p. 164
- 7: **FF/REW Speed** see p. 164
- 8: **Set Location (Set Location for Locate Key)** see p. 164
- 9: **GM Initialize** see p. 165
- 10: **Copy From Combi (Copy from Combination)** see p. 166
- 11: **Copy from Program** see p. 167

For more information, please see “Sequencer: Menu Command” on page 163.

0-3: Mixer T01-08, 0-4: Mixer T09-16



Here, you can set the pan and volume of each MIDI track.

0-3(4)a: Location, Meter, Tempo, Tempo Mode, Song Select, Track Select, Reso, RPPR

For more information, please see “0-1: Program T01-08, 0-2: Program T09-16” on page 109.

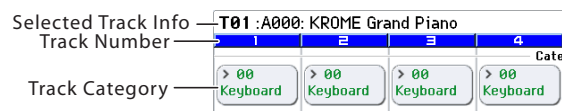

0-3(4)b: Pan, Volume

The pan and volume that you specify here will be used when you play back or record from the beginning of the song. If you change the settings during recording, the changes will be recorded as MIDI data, and pan and volume will change during playback. You can also change the settings during playback. However, when the song reaches a location where pan or volume data was recorded, the settings will change accordingly.

Selected Track Info

This area shows information on the MIDI track selected for editing.

For more information, please see “0-1(2)b: Track Program Select” on page 111.

Track 01 (Track Number):

Category [Category Name]

This indicates the category.

Pan [RND, L001...C064...R127]

Here, you can set the pan of each MIDI track.

L001...C064...R127: A setting of L001 is far left and R127 is far right. A setting of C064 will reproduce the oscillator pan setting of the Program mode.

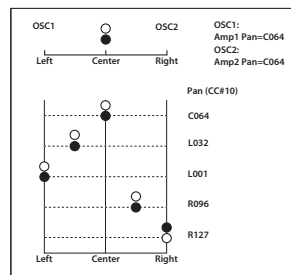
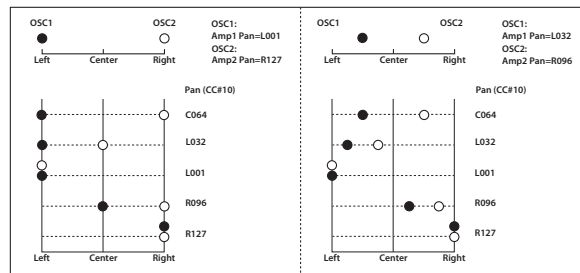

If a mono insert effect is in use, the settings you make here will be ignored. In this case, the **Pan: #8** parameter in P8: Routing/IFX- Insert FX Setup page will adjust the panning of the sound after the Insert Effect. For more information, please see “Mixer” on page 243.

RND: The pan position will change randomly at each note-on.

MIDI If **Status** (Seq 3-1(2)c) is INT or BTH, CC#10 Pan can be received to control the panning. When receiving CC#10, a value of 0 or 1 is far left, 64 is center, and 127 is far right. When you change the song or return to the beginning of the song, tracks whose **Status** is EXT, EX2 or BTH will transmit the pan you specify here as a MIDI message (except for RND). (See Global P1: MIDI, SEQ Mode “Track MIDI Out” on page 200)

Volume [000...127]

Here, you can set the volume of each MIDI track.

MIDI When **Status** (Seq 3-1(2)c) is INT or BTH, CC#7 Volume can be received to control the volume. The volume of a track is determined by multiplying the MIDI Volume (CC#7) and Expression (CC#11) values. When you change the song or return to the beginning of the song, tracks whose **Status** is EXT, EX2 or BTH will transmit the volume you specify here as a MIDI Volume message. (See Global P1: MIDI, SEQ Mode “Track MIDI Out” on page 200)

Track 02...08, 09... 16 (Track Number):

For more information, please see “Track 01 (Track Number):” above.

0-3(4): Menu Command

- 0: **Memory Status** see p. 163
- 1: **Exclusive Solo** see p. 64
- 2: **Rename Song** see p. 163
- 3: **Delete Song** see p. 163
- 4: **Copy From Song** see p. 163
- 5: **Load Template Song** see p. 163
- 6: **Save Template Song (Save as User Template Song)** see p. 164
- 7: **FF/REW Speed** see p. 164
- 8: **Set Location (Set Location for Locate Key)** see p. 164
- 9: **GM Initialize** see p. 165

- 10: Copy From Combi (Copy from Combination) see p. 166
- 11: Copy from Program see p. 167

For more information, please see “Sequencer: Menu Command” on page 163.

0–5: Arpeggiator A,

0–6: Arpeggiator B

Here, you can make arpeggiator settings for the song. A song can run two arpeggiators simultaneously.

Arpeggiator parameters can be edited in P7: Arpeggiator/Drum Track, but certain major parameters can be edited in these pages as well. You can edit these parameters in realtime, for example by changing the arpeggio pattern while playing in Sequencer P0–1: Play/REC.

You can also use the TEMPO knob and the arpeggio control (ARP) GATE knob, VELOCITY knob, SWING knob, and STEP knob to control the arpeggiator in realtime.

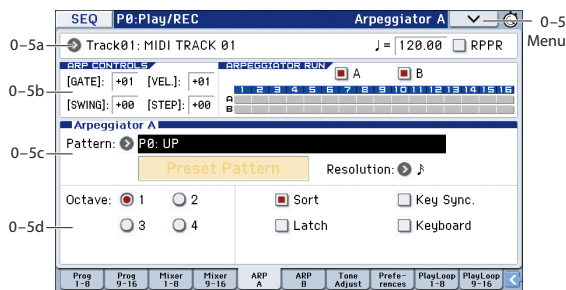

0–5(6)a: Track Select, Tempo, RPPR

Track Select [Track01...16, Master Track]
Tempo [040.00...300.00, EXT]
RPPR [Off, On]

Here, you can select the track, specify the tempo that will control the song or arpeggiator etc., and turn RPPR on/off.

For more information, please see “0–1(2)a: Location, Meter, Tempo, Tempo Mode, Song Select, Track Select, Reso, RPPR” on page 109.

0–5(6)b: Arp Controls

This shows the value of each parameter for the ARP assignments of the REALTIME CONTROL knobs. The arpeggio controls allow you to use the four knobs to control the two arpeggiators in real time.

[GATE]Knob 1: Gate [-64...+00...+63]

[VEL.]Knob 2: Velocity (Velocity) [-64...+00...+63]

[SWING]Knob 3: Length [-64...+00...+63]

see p.6, p.54

[STEP]Knob 4: Octave -64...+00...+63]

see p.6

0–5(6)c: Arpeggiator Run, Track assign

Arpeggiator Run A, B

When the ARP button is on, the arpeggiator(s) you checked here will run if they are assigned to a timbre by **Arpeggiator Assign** (7–1(2)c).

When the arpeggiator is on, these check boxes let you turn A and B on/off.

This parameter can also be set from P7: ARP/DT page **Arpeggiator Run A, B**.

Track assign

This indicates the arpeggiator A and B assignment status for each track 1–8. These settings are made in **Arpeggiator Assign** (Seq 7–1(2)c).

0–5(6)d: Arpeggiator A (B)

Pat (Pattern) [P0...P4, U0000(INT)...U0899(INT), U0900(USER)...U1027(USER)]

Octave [1, 2, 3, 4]

Reso (Resolution) [Musical notation icons]

Sort [Off, On]

Latch [Off, On]

Key Sync. [Off, On]

Keyboard [Off, On]

Arpeggio Pattern Preview

Set the various parameters of the combination arpeggiator. For more information, please see “COMBI P7: ARP/DT (Arpeggiator/Drum Track)” on page 91.

These parameters can also be set from 7–3(4): Arpeggiator A(B) Setup.

✓ 0–5(6): Menu Command

- 0: Memory Status see p. 163
- 1: Exclusive Solo see p. 64
- 2: Rename Song see p. 163
- 3: Delete Song see p. 163
- 4: Copy From Song see p. 163
- 5: Load Template Song see p. 163
- 6: Save Template Song (Save as User Template Song) see p. 164
- 7: FF/REW Speed see p. 164
- 8: Set Location (Set Location for Locate Key) see p. 164
- 9: GM Initialize see p. 165
- 10: Copy From Combi (Copy from Combination) see p. 166
- 11: Copy from Program see p. 167
- 12: Copy Arpeggiator see p. 167

For more information, please see “Sequencer: Menu Command” on page 163.

0-7: Tone Adjust

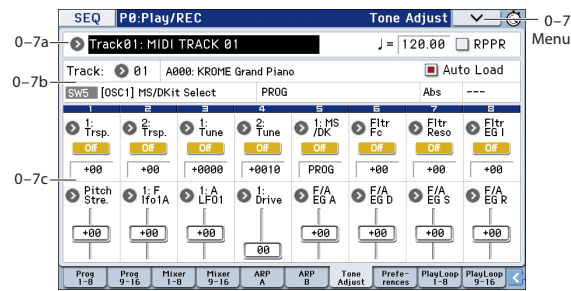

Tone Adjust provides two important features:

- The Tone Adjust parameter lets you edit the principal Program parameters.
- It lets you modify Programs, including everything from subtle tweaks (like changing LFO speeds) to dramatic changes (such as selecting a different Multisample). Any changes that you make are stored with the Song, and do not alter the original Program.

Each of the sixteen tracks has its own set of tone adjust parameters.

For more information, see:

- “Absolute (Abs), Relative (Rel), Meta parameter” on page 7
- “Tone Adjust and MIDI SysEx” on page 7
- “Interaction between Tone Adjust and MIDI CCs” on page 8

Saving Tone Adjust Edits

In Program mode, when you make edits via Tone Adjust and then save the results, the Program data is changed just as if you’d edited the internal parameters directly. For more information, please see “Saving Tone Adjust Edits” on page 7.

In Sequencer mode, however, all Tone Adjust edits are stored within the Song; the Program itself is not changed. This lets you alter the way that a Program sounds in one specific Song without affecting the way that it sounds in Program mode, or in any other Combis or Songs.

0-7a: Track Select, Tempo, RPPR

For more information, please see “0-1: Program T01-08, 0-2: Program T09-16” on page 109.

0-7b: Track Select, Selected parameter information

Track select

Track [1...16]

This selects the track whose Tone Adjust parameters you wish to adjust. You can switch back and forth between the different tracks as much as you like, without losing your edits.

Auto Load (Auto Load PRG) [Off, On]

When you first load a Program into a track, this parameter determines whether or not the Program’s Tone Adjust settings will be loaded as well.

These settings include the parameters assigned to each slider and switch in the display, along with the on/off state assigned to Absolute parameters.

The resulting effect of Tone Adjust settings that were saved in Program mode is saved with the program, regardless of the **Auto Load PCG** setting. The program will sound according to its settings, regardless of whether Tone Adjust settings were saved.

Once the Program has been loaded, you can change any or all of the Tone Adjust settings as desired. All such edits are stored in the Song, without affecting the original Program.

If **Auto Load PRG** is **On**, Tone Adjust settings will be automatically loaded along with the Program.

If **Auto Load PRG** is **Off**, the Tone Adjust settings of the program will not be loaded; the program settings prior to editing the Tone Adjust settings will remain.

Selected parameter information

This status line shows detailed, read-only information about the currently selected Tone Adjust parameter.

| Control | Assignment | Value | Type | Stored Value |
|------------|------------|-------|------|--------------|
| SW1 [OSC1] | Transpose | +12 | Rel | +00 |

Control [SW1...8, SL1...8]

This is the switch or slider in the display that is assigned to Tone Adjust parameters.

Assignment [List of Tone Adjust assignments]

This is the full name of the parameter assigned to the switch or slider in the display. You can change this using the **Assign** parameter, below.

Value

This shows the current value of the parameter. The range of values will vary depending on the parameter assigned to the switch or slider.

Type [Rel, Abs, Meta]

This shows the type of the parameter, which relates to how edits to the parameter are saved. For more information, please see “Absolute (Abs), Relative (Rel), Meta parameter” on page 7.

Stored Value

This shows the original value of the parameter, before the effects of Tone Adjust. It applies only to Tone Adjust parameters which control a single Program parameter.

If you un-assign a parameter from a control, it will revert to this value.

0-7c: Tone Adjust

Here, you can assign Tone Adjust parameters to the switches and sliders in the display.

Switches 1...8

Tone Adjust switches act a little differently than sliders in the display.

When a switch is assigned to a **Relative** parameter, or an **Absolute** parameter with more than two states:

Switch On = **On Value** (see below)

Switch Off = the Program’s stored value

When a switch is assigned to a two-state **Absolute** parameter, such as **Hold**, the switch status directly reflects the parameter value:

Switch On = **On**

Switch Off = **Off**

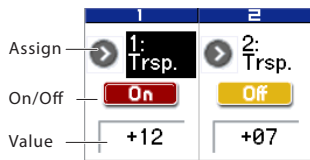

Assign

This assigns Tone Adjust parameters to the switches in the display. For a full list of the available choices, please see “Common Tone Adjust Parameters” on page 9 and “Tone Adjust Parameters” on page 10.

On Value [Depends on parameter]

The parameter is set to this value when the switch is On.

When the switch is assigned to a two-state **Absolute** parameter, such as **Hold**, this will always be the same as the **Switch Status** (see below).

Switch Status [Off, On]

This simply shows whether the switch is On or Off.

Sliders 1–8

Assign

This assigns Tone Adjust parameters to the sliders in the display. For a full list of the available choices, please see “Common Tone Adjust Parameters” on page 9 and “Tone Adjust Parameters” on page 10.

Assignments are exclusive

Per-Oscillator parameters apply to OSC1 and 2 individually, and are marked as such: OSC1 and OSC2.

Each slider can be assigned to only one parameter, and each parameter can be assigned to only one slider.

To swap a parameter from one slider to another, you’ll need to first un-assign it from the old slider, and then assign it to the new slider.

Value

This shows the current value of the parameter. The range of values will vary depending on the parameter assigned to the control.

✓ **0–7: Menu Command**

- 0: **Memory Status** see p. 163
- 1: **Exclusive Solo** see p. 64
- 2: **Rename Song** see p. 163
- 3: **Delete Song** see p. 163
- 4: **Copy From Song** see p. 163
- 5: **Load Template Song** see p. 163
- 6: **Save Template Song (Save as User Template Song)** see p. 164
- 7: **FF/REW Speed** see p. 164
- 8: **Set Location (Set Location for Locate Key)** see p. 164
- 9: **GM Initialize** see p. 165
- 10: **Copy From Combi (Copy from Combination)** see p. 166
- 11: **Copy from Program** see p. 167
- 12: **Copy Tone Adjust** see p. 167
- 13: **Reset Tone Adjust** see p. 167

For more information, please see “Sequencer: Menu Command” on page 163.

0–8: Preferences

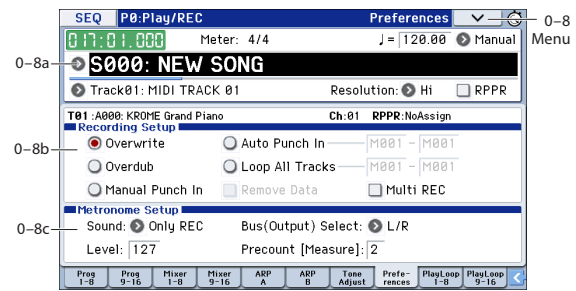

Here, you can specify the realtime recording method, adjust levels and make other settings for audio recording, and adjust the metronome settings.

0–8a: Location, Meter, Tempo, Tempo Mode, Song Select, Track Select, Reso, RPPR

For more information, please see “0–1: Program T01–08, 0–2: Program T09–16” on page 109.

Selected Track Info:

This displays information about the currently selected MIDI track. (See 0–1(2)a)

0–8b: Recording Setup

Selects the method of realtime recording.

Overwrite

When recording for the first time, you will normally select this method.

If you use this method to record on a track on which data has already been recorded, all previous data will be replaced from the measure at which you began recording through all subsequent measures.

With this method, the newly recorded data overwrites musical data previously recorded on that track.

Normally you will use this method to record, and then modify the results by using other types of realtime recording or MIDI event editing.

1. Use **Track Select** to choose the track that you want to record.
2. Set the **Recording Setup** to **Overwrite**.

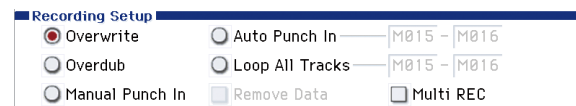







3. In “**Location**,” specify the location at which you wish to begin recording.
4. Press the **REC (●)** button, and then press the **START/STOP (▶/■)** button.

If the **Metronome Setup** is still set to the default settings, the metronome will sound for a two-measure pre-count, and then recording will begin.

Play the keyboard and move the controllers (such as the joystick) to record your performance.

5. When you finish playing, press the **START/STOP (▶/■)** button.

Recording will end, and the location will return to the point at which you begin recording.

If you press the PAUSE () button instead of the START/STOP ( / ) button, recording will pause. When you press the PAUSE () button once again, recording will resume. When you are finished, press the START/STOP ( / ) button to stop recording.

Overdub

Select this method when you wish to add data to a previously-recorded track.

With this method, the newly recorded musical data is added to the existing data.

When you perform overdub recording on a previously-recorded track, the newly recorded data will be added to the previously-recorded data.

It is best to select this mode if you will be recording additional control data, recording a drum pattern, or recording the tempo in the master track. With this mode, data can be added without erasing the existing performance data.

1. Use Track Select to choose the track that you want to record.
2. Set the Recording Setup to Overdub.

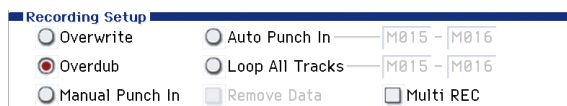

3. For the rest of the procedure, please see steps 3-5 of "Overwrite."



Manual Punch In

Select this method when you wish to use the REC () button or a foot switch to re-record selected portions of a previously-recorded track.

While the song is playing, you can press the REC () button or a connected pedal switch at the desired location to start or stop recording. With this method, the musical data previously on the track is overwritten by the newly recorded data.

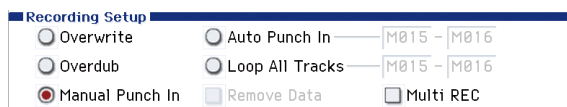
1. Use Track Select to select the track that you want to record.
2. Set the Recording Setup to Manual Punch In.



3. In "Location," specify a location several measures earlier than the point at which you wish to begin recording.
4. Press the START/STOP ( / ) button.

Playback will begin.

5. At the point at which you wish to begin recording, press the REC () button.

Recording will begin. Play the keyboard and operate controllers such as the joystick to record your performance.

6. When you finish recording, press the REC () button.

Recording will end (playback will continue).

Note: Instead of pressing the REC () button in steps 5 and 6, you can use a foot switch connected to the ASSIGNABLE SWITCH jack.

Set the Global P2: Controllers page **Foot Switch Assign** to Song Punch In/Out.

7. Press the START/STOP ( / ) button.

Playback will stop, and you will return to the location that you specified in step 3.

Auto Punch In

Select this method when you wish to automatically re-record selected portions of a previously-recorded track.

Recording will occur only over the specified area, rewriting it with the newly recorded data.

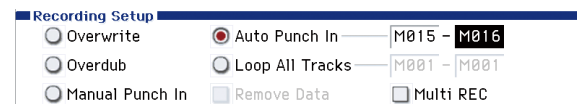

First you must specify the area that will be re-recorded. Then recording will automatically start and end within the specified area. With this method, the musical data previously on the track is overwritten by the newly recorded data.

1. Use Track Select to choose the track that you want to record.
2. Set the Recording Setup to Auto Punch In.



3. In "M (Auto Punch In Start Measure), "M (Auto Punch In End Measure)" specify the area that you wish to record.

For example, if you specify M005-M008, recording will occur only from measure 5 to measure 8.

4. In "Location," specify a location several measures before the point at which you wish to begin recording.
5. Press the REC () button, and then press the START/STOP ( / ) button.

Playback will begin.

When you reach the starting location you specified in step 3, recording will begin. Play the keyboard and operate controllers such as the joystick to record your performance. When you reach the ending location you specified in step 3, recording will end. (Playback will continue.)

6. Press the START/STOP ( / ) button.

Playback will stop, and you will return to the location you specified in step 4.

Auto Punch In Start Measure [M001...M999]

Auto Punch In End Measure [M001...M999]

When Recording Setup is set to Auto Punch In, specify the measures at which recording will start and end.

Loop All Tracks

Select this method when you wish to repeatedly record a specified area of a track, and continue adding data. This is suitable for creating drum patterns, etc.

 If Multi REC is checked, this parameter will not be available.

This method lets you continue recording as you add musical data.

The specified region can be recorded repeatedly. This is ideal when recording drum phrases, etc.

Use Track Select to select the track that you want to record.

1. Set the Recording Setup to Loop All Tracks.
2. If Multi REC is checked, it will not be possible to select Loop All Tracks.

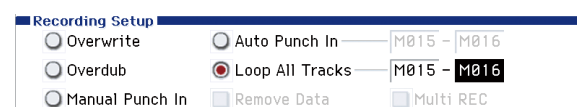

3. In "M (Loop Start Measure), "M (Loop End Measure)" specify the area that you wish to record.

For example, if you specify M004-M008, recording will occur repeatedly (as a loop) from measure 4 to measure 8.

- In "Location," specify a location several measures earlier than the point at which you wish to begin recording.
- Press the REC (●) button, and then press the START/STOP (▶ / ■) button.

Playback will begin. When you reach the starting location you specified in step 3, recording will begin. Play the keyboard and operate controllers such as the joystick to record your performance.

When you reach the ending location you specified in step 3, you will return to the starting location, and continue recording.

- The musical data that is loop-recorded will be added to the previously-recorded data.

You can also erase specific data while you continue loop recording. This is useful if, for example, you need to delete a mistake without interrupting the flow of the recording.

If you press the REC (●) button during loop recording, all musical data will be removed from the currently selected track as long as you continue pressing the switch.

By checking the **Remove Data** check box you can erase only the specified data. During loop recording, press the note that you wish to delete, and only the data of that note number will be deleted from the keyboard as long as you continue pressing that note.

Similarly, bender data will be deleted as long as you tilt the joystick in the X (horizontal) direction, and aftertouch data will be deleted as long as you apply pressure to the keyboard.

When you are once again ready to record musical data, uncheck the **Remove Data** check box.

- Press the START/STOP (▶ / ■) button.

Playback will end, and you will return to the recording start location that you specified in step 4.

If Loop All Tracks is selected, normal playback will be looped as well.

Loop Start Measure [M001...M999]

Loop End Measure [M001...M999]

Specifies the range of measures over which recording will repeat when **Recording Setup** is set to Loop All Tracks.

Remove Data [Off, On]

Use this to delete unwanted MIDI data that you recorded while using Loop All Tracks. This is available when **Recording Setup** is set to Loop All Tracks.

On (checked): You can delete unwanted MIDI data while recording with Loop All Tracks. During recording, press the key (note number) that corresponds to the MIDI note data you wish to delete. All occurrences of that note number will be deleted for the time that you continue holding down the key.

Controller data can also be erased in a similar way. For example while you move and hold the joystick in the X (horizontal) direction, bender data will be erased. This applies to Joystick+Y (CC#01)/-Y (CC#02), Joystick X (Pitch Bend), and Damper (CC#64).

Also, you can press and hold down the REC (●) button to delete all MIDI data for as long as the key is held.

Multi REC [Off, On]

On (checked): Multi-track recording setup is enabled. Select this if you want to record two or more tracks simultaneously.

Use MIDI multi-track recording if you want to simultaneously record multiple MIDI tracks of different channels, such as when recording the output of the drum

track, arpeggiator or RPPR functions, or when recording the output of an external multi-track sequencer.

If the Multi REC box is checked, the **Play/Rec/Mute** status of the track you select in **Track Select** will be set to REC; press the **Play/Rec/Mute** button of the track(s) you want to record so that they indicate REC. (The button indication will change in the order of Play → Rec → Mute.)

Regardless of the **Track Select** (Seq 0–1(2)a) setting, data will be recorded on the MIDI tracks that are set to REC. MIDI data will be routed to the tracks with a corresponding MIDI channel.

For details on how to record from the arpeggiator or an external multi-track sequencer onto multiple tracks of different MIDI channels, please see "Synchronizing the playback of the Arpeggiator, Drum Track function or sequencer" on page 367.

Note: If you're recording data from an external multi-track sequencer, set **MIDI Clock** (Global 1–1a) to External MIDI so that the KROME will synchronize to your external sequencer. Tempo changes cannot be recorded.

Off (unchecked): Single track recording setup will be selected. Recording will occur on the track selected by **Track Select**.

▲ **Multi REC.** cannot be selected if **Recording Setup** is set to Loop All Tracks.

- Make the desired **Recording Setup** settings.

You can record using Overwrite, Overdub, Manual Punch In, or Auto Punch In.

- In "Recording Setup," check "Multi REC."

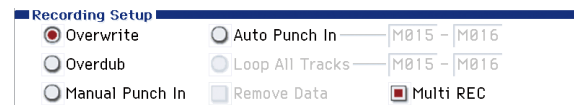

- Use "Location" to specify the measure at which recording will begin.

- Press the REC (●) button.

- For the track you want to record, press Play/Rec/Mute to make it indicate Rec.

- Press the START/STOP (▶ / ■) button.

With the default settings for **Metronome Setup**, the metronome will sound for a two-measure pre-count, and then recording will begin. Now you can perform on the keyboard and controllers, and use the arpeggiator or RPPR functions if desired.

- Press the START/STOP (▶ / ■) button.

Playback will stop, and you will return to the location specified in step 3.

0–8c: Metronome Setup

Here, you can make metronome settings.

Sound [Only REC, REC & Play, Off]

Only REC: The metronome will sound only during recording.

REC & Play: The metronome will sound during recording and playback.

Off: The metronome will not sound during playback or recording. However, the pre-count metronome will sound before recording begins.

Level [000...127]

Sets the volume of the metronome.

Bus (Output) Select [L/R, L, R]

Selects the output destination of the metronome sound.

L/R: Output from AUDIO OUTPUT L/Mono and R.

L: Output from AUDIO OUTPUT L/Mono.

R: Output from AUDIO OUTPUT R.

Precount [Measure] [0...2]

Specifies the pre-count that will occur before recording begins.

With a setting of 0, recording will begin the instant you press the START/STOP (▶/■) button (after first pressing the REC (●) button).

0–8: Menu Command

- 0: **Memory Status** see p. 163
- 1: **Exclusive Solo** see p. 64
- 2: **Rename Song** see p. 163
- 3: **Delete Song** see p. 163
- 4: **Copy From Song** see p. 163
- 5: **Load Template Song** see p. 163
- 6: **Save Template Song (Save as User Template Song)** see p. 164
- 7: **FF/REW Speed** see p. 164
- 8: **Set Location (Set Location for Locate Key)** see p. 164
- 9: **GM Initialize** see p. 165
- 10: **Copy From Combi (Copy from Combination)** see p. 166
- 11: **Copy from Program** see p. 167

For more information, please see “Sequencer: Menu Command” on page 163.

0–9: Play Loop T01–08, 0–10: Play Loop T09–16

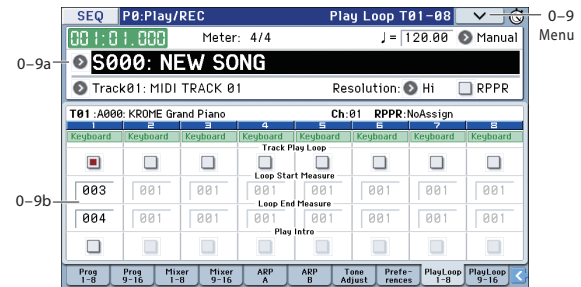

When playing or recording a song, you can independently loop the MIDI tracks.

0–9(10)a: Location, Meter, Tempo, Tempo Mode, Song Select, Track Select, Reso, RPPR

For more information, please see “0–1: Program T01–08, 0–2: Program T09–16” on page 109.

0–9(10)b: Play Loop

Selected Track Info

This displays information about the currently selected MIDI track. For more information, please see “0–1(2)b: Track Program Select” on page 111.

Track 01 (Track Number):

Category [Category Name]

Indicates the category.

Track Play Loop [Off, On]

Specifies looping for a MIDI track.

On (checked): That track will loop between **Loop Start Measure** and **Loop End Measure**.

Loop Start Measure [001...999]

Specifies the first measure of the loop.

Loop End Measure [001...999]

Specifies the last measure of the loop.

Play Intro [Off, On]

On (checked): After the measures before the specified **Loop Start Measure** are played once, the region of **Loop Start Measure** – **Loop End Measure** will be played repeatedly.

For example, you can use this on a drum track to make it play a fill-in and then begin looping.

Off (unchecked): Playback will begin from the **Loop Start Measure**, and will begin looping immediately.

 This will be valid if **Track Play Loop** is checked and **Loop Start Measure** is set to other than 001.

Example)

When “Play Intro” is checked

| T01 :A000: KROME Grand Piano | | | Ch:01 RPPR:NoAssign | | | | |
|-------------------------------------|--------------------------|--------------------------|--------------------------|--------------------------|--------------------------|--------------------------|--------------------------|
| 1 | 2 | 3 | 4 | 5 | 6 | 7 | 8 |
| Keyboard | Keyboard | Keyboard | Keyboard | Keyboard | Keyboard | Keyboard | Keyboard |
| <input checked="" type="checkbox"/> | <input type="checkbox"/> | <input type="checkbox"/> | <input type="checkbox"/> | <input type="checkbox"/> | <input type="checkbox"/> | <input type="checkbox"/> | <input type="checkbox"/> |
| | | | Track Play Loop | | | | |
| | | | Loop Start Measure | | | | |
| 003 | 001 | 001 | 001 | 001 | 001 | 001 | 001 |
| | | | Loop End Measure | | | | |
| 004 | 001 | 001 | 001 | 001 | 001 | 001 | 001 |
| | | | Play Intro | | | | |
| <input checked="" type="checkbox"/> | <input type="checkbox"/> | <input type="checkbox"/> | <input type="checkbox"/> | <input type="checkbox"/> | <input type="checkbox"/> | <input type="checkbox"/> | <input type="checkbox"/> |

Track 1 will loop as follows.

M001 – M002 – M003 – M004 – M003 – M004 – M003 – M004...

When “Play Intro” is not checked

| T01 :A000: KROME Grand Piano | | | Ch:01 RPPR:NoAssign | | | | |
|-------------------------------------|--------------------------|--------------------------|--------------------------|--------------------------|--------------------------|--------------------------|--------------------------|
| 1 | 2 | 3 | 4 | 5 | 6 | 7 | 8 |
| Keyboard | Keyboard | Keyboard | Keyboard | Keyboard | Keyboard | Keyboard | Keyboard |
| <input checked="" type="checkbox"/> | <input type="checkbox"/> | <input type="checkbox"/> | <input type="checkbox"/> | <input type="checkbox"/> | <input type="checkbox"/> | <input type="checkbox"/> | <input type="checkbox"/> |
| | | | Track Play Loop | | | | |
| | | | Loop Start Measure | | | | |
| 003 | 001 | 001 | 001 | 001 | 001 | 001 | 001 |
| | | | Loop End Measure | | | | |
| 004 | 001 | 001 | 001 | 001 | 001 | 001 | 001 |
| | | | Play Intro | | | | |
| <input type="checkbox"/> | <input type="checkbox"/> | <input type="checkbox"/> | <input type="checkbox"/> | <input type="checkbox"/> | <input type="checkbox"/> | <input type="checkbox"/> | <input type="checkbox"/> |

Track 1 will loop as follows.

M003 – M004 – M003 – M004 – M003 – M004 – M003 – M004...

In this way, you can use **Track Play Loop** to make the realtime recording process more efficient.

Track 02...08, 09...16 (Track Number):

For more information, please see “Track 01 (Track Number):” above.

✓ 0–9(10): Menu Command

- 0: Memory Status see p. 163
- 1: Exclusive Solo see p. 164
- 2: Rename Song see p. 163
- 3: Delete Song see p. 163
- 4: Copy From Song see p. 163
- 5: Load Template Song see p. 163
- 6: Save Template Song (Save as User Template Song) see p. 164
- 7: FF/REW Speed see p. 164
- 8: Set Location (Set Location for Locate Key) see p. 164
- 9: GM Initialize see p. 165
- 10: Copy From Combi (Copy from Combination) see p. 166
- 11: Copy from Program see p. 167

For more information, please see “Sequencer: Menu Command” on page 163.

Controls

REALTIME CONTROLS lets you use knobs [1]–[4] to modify the parameters of the track’s program or the effects. You can also use these knobs to control the arpeggiators. When you use a knob, the display will show the controller’s function and value. Use the SELECT button to change the knob functions.

In TONE, the functions assigned to knobs 1–4 are fixed.

In USER, you can assign a variety of modulation functions to knobs 1–4. To assign functions, use the P1: Controllers Setup page (see p.122).

Realtime Controls AMSource

The Realtime Controls TONE knob functions (TONE [CUTOFF]–TONE [RELEASE]) are fixed. You can assign a variety of functions to Realtime Controls USER knobs 1–4 (USER [1]–USER [4]). MIDI control changes are assigned for each function.

When you move a knob, it sends out the corresponding MIDI CC.

When you operate a knob, the corresponding MIDI control change message will be transmitted on the Track Select MIDI channel.

Most of these functions adjust (scale) the parameter settings of the track programs. Unless otherwise noted, “scaling” means that the parameters are at their programmed values when the controller is at 64, at their minimum when the controller is at 0, and at their maximum when the controller is at 127. For another look at this, please see the diagram below.

CC scaling of parameters

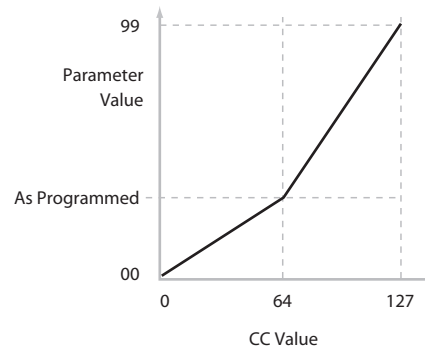

TONE [CUTOFF]: Flt Fc (Cutoff) [000...127]

This slider scales the cutoff frequencies of Filters A and B, and transmits and receives MIDI CC #74.

TONE [RESONANCE]: Flt Reso (Resonance) [000...127]

This slider scales the resonance of Filters A and B, and transmits and receives MIDI CC #71.

TONE [EG INT]: Flt EG (Filter EG Intensity) [000...127]

This slider scales the effect of the Filter EG on the cutoff frequencies of Filters A and B. It also transmits and receives MIDI CC#79.

TONE [RELEASE]: EG Rel (EG Release) [000...127]

This slider scales the release time of the Filter and Amp EGs, and transmits and receives MIDI CC#72.

USER [1]...USER[4] [000...127]

You can set Realtime Controls USER knobs 1–4 to a wide variety of modulation functions, using the P1: Controllers–Controllers Setup page.

Many of the functions scale a particular set of Program parameters. All of the settings also correspond to MIDI messages usually CCs.

Arpeggiator

Arpeggio control lets you use the four knobs to control the two arpeggiators in realtime.

The functions of knobs 1–4 are fixed. The knobs will control the duration of the arpeggiated notes, their velocity, the swing, and the step.

ARP [GATE] [-64...+00...+63]

Adjusts the duration (gate time) of the arpeggiated notes (See “Gate” on page 54).

ARP [VELOCITY] [-64...+00...+63]

Adjusts the velocity of the arpeggiated notes (See “Velocity” on page 54).

ARP [SWING] [-64...+00...+63]

Adjusts the degree of shuffle for the arpeggio pattern (See “Swing” on page 54).

ARP [STEP] [-64...+00...+63]

This affects the length and resolution of the arpeggio pattern.

Turning the knob toward the left will shorten the pattern’s length (**Length**) in units of one half. Turning the knob toward the right will shorten the interval between arpeggiated notes (**Resolution**) in units of one half. When the knob is in the center (12 o’clock), the number of steps and the speed will be as specified by the **Length** and **Resolution** (See “Resolution*” on page 54).

SEQ P1: Controllers

1-1: Setup

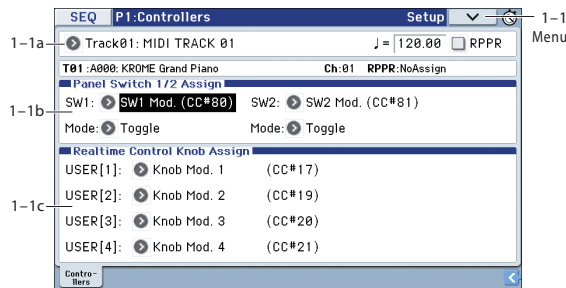

Here, you can assign the functions performed by SW1 and SW2, and by knobs 1-4 when Realtime Controls USER is selected.

When you operate these knobs during recording, the MIDI messages assigned to them will be recorded.

Note: The Panel Switch Assign setting of the program assigned to each track will have no effect.

1-1a: Track Select, Tempo, RPPR, Track Info, Selected Track Info

Track Select [Track01...16, Master Track]

J (Tempo) [040.00...300.00, EXT]

RPPR [Off, On]

Here, you can select the track, specify the tempo that will control the arpeggiator etc., and turn RPPR on/off.

For more information, please see "0-1(2): Location, Meter, Tempo, Tempo Mode, Song Select, Track Select, Reso, RPPR" on page 109.

Selected Track Info

This area shows detailed information about its track assignments.

For more information, please see "Selected Track Info" on page 111.

1-1b: Panel Switch 1/2 Assign

SW (SW1 Assign) [Off, ..., JS-Y Lock]

This assigns the function of SW1. For more information, please see "List of SW 1/2 assignments" on page 348.

Note: If you change the function setting, the status is reset to off.

Note: If the on/off status of the SW1, SW2 switches is memorized when you save it.

Mode (SW1 Mode) [Toggle, Momentary]

This specifies the on/off operation when you press the SW1 switch.

Toggle: The function will alternate between on and off each time you press the SW1 switch.

Momentary: The function will be on only while you continue holding down the SW1 switch.

SW2 (SW2 Assign) [Off, ..., JS-Y Lock]

Mode (SW2 Mode) [Toggle, Momentary]

This assigns the function of SW2. The functions that can be assigned to SW2 are the same as for SW1, with the substitution of SW2 Mod. (CC#81) instead of the SW1's SW1 Mod. (CC#80).

1-1c: Realtime Controls Knob Assign

Here, you can assign the functions (mainly types of control change) that knobs 1-4 will have when RealTime Controls USER. (See "Realtime Controls Knobs 1-4 Assignments" on page 348.)

The functions you assign here are active when you use the SELECT button to select USER, and operate knobs 1-4.

USER [1] [Off, ..., MIDI CC#119]

USER [2] [Off, ..., MIDI CC#119]

USER [3] [Off, ..., MIDI CC#119]

USER [4] [Off, ..., MIDI CC#119]

✓ 1-1: Menu Command

- 0: Memory Status see p. 163
- 1: Exclusive Solo see p. 64
- 2: Rename Song see p. 163
- 3: Delete Song see p. 163
- 4: Copy From Song see p. 163
- 5: Load Template Song see p. 163
- 6: Save Template Song (Save as User Template Song) see p. 164
- 7: FF/REW Speed see p. 164
- 8: Set Location (Set Location for Locate Key) see p. 164
- 9: GM Initialize see p. 165
- 10: Copy From Combi (Copy from Combination) see p. 166
- 11: Copy from Program see p. 167

For more information, please see "Sequencer: Menu Command" on page 163.

SEQ P2: EQ

2-1: Trim T01-08, 2-2: Trim T09-16

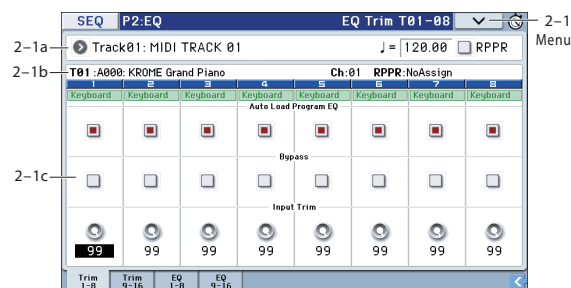

Here, you can set the signal level that enters the EQ of tracks 1-8 and 9-16.

2-1(2)a: Track Select, Tempo, RPPR

Track Select [Track01...16, Master Track]

J (Tempo) [040.00...300.00, EXT]

RPPR [Off, On]

Here, you can select the track, specify the tempo that will control the arpeggiator etc., and turn RPPR on/off.

For more information, please see “0-1(2)a: Location, Meter, Tempo, Tempo Mode, Song Select, Track Select, Reso, RPPR” on page 109.

2-1(2)b: Track Info

For more information, please see “0-1(2)b: Track Program Select” on page 111.

2-1(2)c: Trim

Track 01 (Track Number):

Auto Load Prog EQ [Off, On]

When you first load a Program into a Track, this parameter determines whether or not the Program’s EQ settings will be loaded as well.

Once the Program has been loaded, you can change any or all of the EQ settings as desired. All such edits are stored in the Song, without affecting the original Program.

Regardless of this setting, subsequent edits to the Program’s EQ in Program mode will not affect the Song.

On: the Program’s EQ settings will be loaded automatically along with the Program. This is the default setting.

Off: the Program’s EQ settings won’t be loaded. Use this if you’ve set up the EQ in a specific way, and then want it to stay unchanged while you try out different Programs.

Bypass [Off, On]

If this is **On (checked)**, all of the EQ will be disabled, including **Input Trim**. Bypass can be convenient for comparing the results of the EQ with the original signal.

Input Trim [00...99]

This controls the volume level going into the EQ. Note that this parameter uses a linear scale; 50 is equivalent to -6 dB, 25 is the same as -12 dB, and so on.

High settings of the **Low**, **Mid**, and **High Gain** (Seq 2-3(4)a) controls can cause substantial increases in the overall level. You can compensate for this by turning down the input trim.

Track 02...08, 09...16 (Track Number):

Here, you can set the parameters for MIDI tracks 2-8 and 9-16. They are the same as for track 1. For more information, please see “Track 01 (Track Number):” above.

✓ 2-1(2): Menu Command

- 0: **Memory Status** see p. 163
- 1: **Exclusive Solo** see p. 64
- 2: **Rename Song** see p. 163
- 3: **Delete Song** see p. 163
- 4: **Copy From Song** see p. 163
- 5: **Load Template Song** see p. 163
- 6: **Save Template Song (Save as User Template Song)** see p. 164
- 7: **FF/REW Speed** see p. 164
- 8: **Set Location (Set Location for Locate Key)** see p. 164
- 9: **GM Initialize** see p. 165
- 10: **Copy From Combi (Copy from Combination)** see p. 166
- 11: **Copy from Program** see p. 167

For more information, please see “Sequencer: Menu Command” on page 163.

2-3: EQ T01-08, 2-4: EQ T09-16

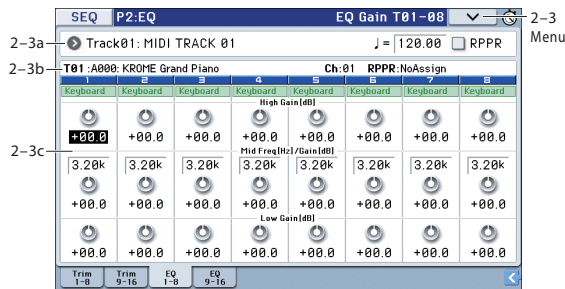

Here, you can adjust the settings for the mid-sweepable three-band EQ for each MIDI track.

2-3(4)a: Track Select, Tempo, RPPR

2-3(4)b: Track Info

For more information, please see “2-1: Trim T01-08, 2-2: Trim T09-16” on page 123.

2-3(4)c: 3 Band Parametric EQ

Track 01 (Track Number):

High Gain [dB] [-18.0...+00.0...+18.0]

This controls the gain of the 10 kHz High Shelf EQ, in increments of 0.5 dB.

Mid Freq [Hz] (Mid Frequency) [100...10k]

This sets the center frequency for the Mid sweep EQ.

Mid Gain [dB] [-18.0...+00.0...+18.0]

This controls the gain of the Mid Sweep EQ, in increments of 0.5 dB.

Low Gain [dB] [-18.0...+00.0...+18.0]

This controls the gain of the 80 Hz Low Shelf EQ, in increments of 0.5 dB.

Track 02...08, 09...16 (Track Number):

These parameters adjust the three-band EQ (with sweepable mid range) for MIDI tracks 2-8 and 9-16. They are the same as for track 1. For more information, please see “Track 01 (Track Number):” above.

✓ 2-3(4): Menu Command

- 0: Memory Status see p. 163
- 1: Exclusive Solo see p. 64
- 2: Rename Song see p. 163
- 3: Delete Song see p. 163
- 4: Copy From Song see p. 163
- 5: Load Template Song see p. 163
- 6: Save Template Song (Save as User Template Song) see p. 164
- 7: FF/REW Speed see p. 164
- 8: Set Location (Set Location for Locate Key) see p. 164
- 9: GM Initialize see p. 165
- 10: Copy From Combi (Copy from Combination) see p. 166
- 11: Copy from Program see p. 167

For more information, please see “Sequencer: Menu Command” on page 163.

SEQ P3: Track Param (Track Parameters)

3-1: MIDI T01-08,

3-2: MIDI T09-16

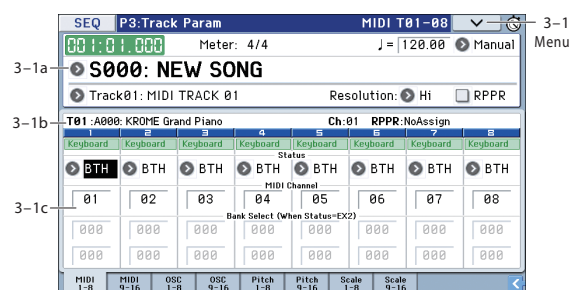

Here, you can make MIDI-related settings for each MIDI track.

3-1(2)a: Location, Meter, Tempo, Tempo Mode, Song Select, Track Select, Reso, RPPR

3-1(2)b: Track Info

For more information, please see “0-1(2)a: Location, Meter, Tempo, Tempo Mode, Song Select, Track Select, Reso, RPPR” on page 109.

For more information, please see “2-1: Trim T01-08, 2-2: Trim T09-16” on page 123.

3-1(2)c: MIDI

Track 01 (Track Number):

Status [Off, INT, BTH, EXT, EX2]

This sets whether the Track controls the internal sounds, external MIDI devices, or both.

When controlling external MIDI devices, it also allows you to choose the internal Bank Select numbers (as set by the front-panel buttons), or use custom Bank Select settings to match the external device.

Off: Use this to disable the Track. With this setting, the Track’s Program will not sound, and MIDI data will not be transmitted.

INT: The track will sound when you play back the performance data recorded on the MIDI track. If you use **Track Select** (Seq 0-1(2)a) to select a MIDI track that is set to INT, the KROME’s sound generator will produce sound when played. MIDI data will not be transmitted to an external device.

BTH: Both INT and EXT are operative. When the musical data recorded in the MIDI track is played back, or when you select a MIDI track that is set to BTH and play the controllers of the KROME, the internal tone generator of the KROME will sound, and MIDI data will also be transmitted to an external device.

EXT: When the musical data recorded in the MIDI track is played back, or when you select a MIDI track that is set to EXT and play the controllers of the KROME, MIDI data will be transmitted to an external device, but the internal tone generator of the KROME will not sound.

When you select another song or return to the beginning of the song, the program change, volume, panpot, portamento, sends 1 and 2, post IFX pan, and post IFX sends 1 and 2 of each MIDI track set to EXT will be transmitted via MIDI.

(See Global P1: MIDI, SEQ Mode “Track MIDI Out” on page 200)

EX2: This enables you to specify a particular MIDI Bank Select message for the Track, instead of automatically using the Bank of the selected KROME Program. Use the parameters below, labeled **Bank Select MSB (When Status=EX2)**, to set the Bank Select message as desired. In other respects this is the same as EXT, described above.

MIDI MIDI data is transmitted and received on the MIDI channel that is specified separately for each MIDI track by the **MIDI Channel**.

| Status | Keyboard, Sequencer, & MIDI In play Internal Sounds | Keyboard & Sequencer Transmit MIDI Out |
|--------|---|---|
| OFF | No | No |
| INT | Yes | No |
| EXT | No | Yes (using the Bank Select message of the track’s Program) |
| EX2 | No | Yes (using the Bank Select message specified on the MIDI tab of the Track Param page) |
| BTH | Yes | Yes |

MIDI Channel

[01...16]

Specifies the MIDI channel that the MIDI track will use to transmit and receive musical data. The MIDI channel you specify here will be the receive channel when **Status** is INT, the transmit channel when it is EXT or EX2, and the receive/transmit channel when it is BTH. Tracks set to INT which have the same MIDI channel will sound and be controlled identically when they receive MIDI data or data from the sequencer tracks.

Bank Select MSB (When Status=EX2) [000...127]

Bank Select LSB (When Status=EX2) [000...127]

When **Status** is set to EX2, this sets the bank number that will be transmitted. When **Status** is other than EX2, this setting has no effect.

Track 02...08, 09...16 (Track Number):

These are the MIDI-related settings for MIDI tracks 2-8 and 9-16. They are the same as for track 1. For more information, please see “Track 01 (Track Number):” above.

✓ 3-1(2): Menu Command

- 0: **Memory Status** see p. 163
- 1: **Exclusive Solo** see p. 64
- 2: **Rename Song** see p. 163
- 3: **Delete Song** see p. 163
- 4: **Copy From Song** see p. 163
- 5: **Load Template Song** see p. 163
- 6: **Save Template Song (Save as User Template Song)** see p. 164
- 7: **FF/REW Speed** see p. 164
- 8: **Set Location (Set Location for Locate Key)** see p. 164
- 9: **GM Initialize** see p. 165
- 10: **Copy From Combi (Copy from Combination)** see p. 166
- 11: **Copy from Program** see p. 167

For more information, please see “Sequencer: Menu Command” on page 163.

3-3: OSC T01-08, 3-4: OSC T09-16

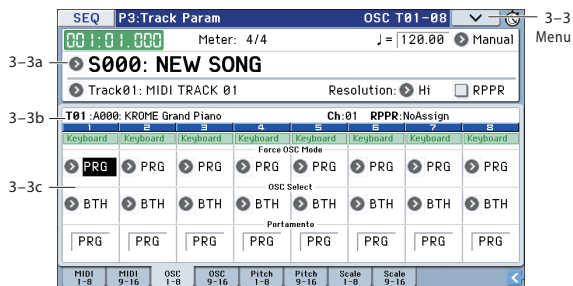

These parameters specify how each MIDI track will be sounded.

3-3(4)a: Location, Meter, Tempo, Tempo Mode, Song Select, Track Select, Reso, RPPR

3-3(4)b: Track Info

For more information, please see “0-1(2)a: Location, Meter, Tempo, Tempo Mode, Song Select, Track Select, Reso, RPPR” on page 109.

For more information, please see “2-1: Trim T01-08, 2-2: Trim T09-16” on page 123.

3-3(4)c: OSC

Track 01 (Track Number):

Force OSC Mode [PRG, Poly, MN, LGT]

This lets you override the Program’s stored Voice Assign Mode settings, if desired.

PRG: The Program’s stored Prog P1: Basic/Controllers–Program Basic **Voice Assign Mode** settings will be used.

Poly: The track will play polyphonically, regardless of the Program’s settings.

MN (Mono): The track will play monophonically, regardless of the Program’s settings.

LGT (Legato): The track program will sound monophonically, and will play legato according to the Program’s **Mode** setting (Prog 1-1b).

With the MN or LGT settings, the Program’s **Priority** setting (Prog 1-1b) will determine the priority of the note that sounds when you play two or more notes.

OSC Select [BTH, OS1, OS2]

Specifies whether the MIDI track’s program will play OSC1, OSC2, or both.

For programs whose **Oscillator Mode** (Prog 1-1a) is Double or **Double Drums**, this setting lets you specify that only OSC1 or OSC2 will sound.

BTH (Both): OSC1 and 2 will sound as specified by the settings of the program.

OS1: Only OSC1 will sound.

OS2: Only OSC2 will sound. PCM programs will not sound if **Oscillator Mode** is set to Single or Drums.

Portamento [PRG, Off, 001...127]

Make portamento settings for each MIDI track.

The portamento setting you make here will be used when the song is played or recorded from the beginning. If you change the setting while recording, it will be recorded as part of the musical data. (However if you set this to PRG, it will not be recorded.) You can change this setting during playback. However if you play back any Portamento On/Off data or Portamento Time data that was previously recorded, the settings will change accordingly.

When the track whose **Status** (Seq 3-1(2)c) is INT or BTH, MIDI control change CC#05 (Portamento Time) and CC#65 (Portamento Switch) can be received to control this and change the setting. (If the setting is PRG, CC#05 Portamento Time will not be received.)

When you switch songs or return to the beginning of the song, tracks whose **Status** is BTH, EXT, or EX2 will transmit this setting via MIDI. If this is Off, CC#65 with a value of 0 will be transmitted. If this is 001-127, a CC#65 of 127 and CC#05 of 1-127 will be transmitted.

If this is set to PRG, nothing will be transmitted.

This data is transmitted and received on the MIDI channel specified for each track by **MIDI Channel** (Seq 3-1(2)c). (See Global P1: MIDI, SEQ Mode “Track MIDI Out” on page 200)

Track 02...08, 09...16 (Track Number):

Here, you can make OSC settings for MIDI tracks 2-8 and 9-16. They are the same as for track 1. For more information, please see “Track 01 (Track Number):” above.

3-3(4): Menu Command

- 0: **Memory Status** see p. 163
- 1: **Exclusive Solo** see p. 64
- 2: **Rename Song** see p. 163
- 3: **Delete Song** see p. 163
- 4: **Copy From Song** see p. 163
- 5: **Load Template Song** see p. 163
- 6: **Save Template Song (Save as User Template Song)** see p. 164
- 7: **FF/REW Speed** see p. 164
- 8: **Set Location (Set Location for Locate Key)** see p. 164
- 9: **GM Initialize** see p. 165
- 10: **Copy From Combi (Copy from Combination)** see p. 166
- 11: **Copy from Program** see p. 167

For more information, please see “Sequencer: Menu Command” on page 163.

3-5: Pitch T01-08, 3-6: Pitch T09-16

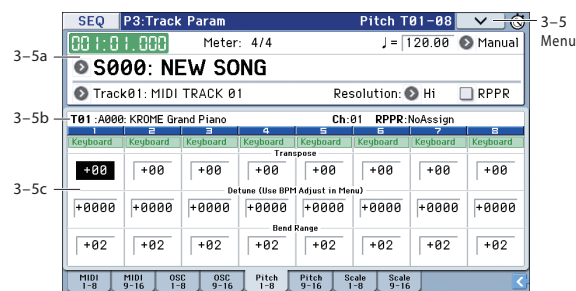

Here, you can make pitch-related settings for each MIDI track.

3-5(6)a: Location, Meter, Tempo, Tempo Mode, Song Select, Track Select, Reso, RPPR

3-5(6)b: Track Info

For more information, please see “0-1(2)a: Location, Meter, Tempo, Tempo Mode, Song Select, Track Select, Reso, RPPR” on page 109.

For more information, please see “2-1: Trim T01-08, 2-2: Trim T09-16” on page 123.

3-5(6)c: Pitch

Track 01 (Track Number):

Transpose [-60...+00...+60]

Adjusts the pitch of each MIDI track in semitone steps. 12 units equal one octave.

Detune (Use BPM Adjust in Menu) [-1200...+0000... +1200]

Adjusts the pitch of each MIDI track in one-cent units. +0000: Normal pitch.

Note: You can also use the **Detune BPM Adjust** menu command (see page 103) to automatically make a detune setting from a calculation in BPM units.

MIDI **Transpose** and **Detune** do not affect the notes transmitted via MIDI Out. **Transpose** and **Detune** can be controlled via MIDI RPN messages received on the Track’s MIDI channel. The way that this works depends on whether or not the Track uses a Drum Program.

If the Track does not use a Drum Program for example, if it uses a Single or Double Program then MIDI RPN Coarse Tune will control **Transpose**, and RPN Fine Tune will control **Detune**.

If the Track uses an Drum Program, MIDI RPN Coarse Tune and Fine Tune will be combined to control **Detune**. The overall range is ±1 octave for coarse tune and fine tune together.

Bend Range [PRG, -24...+00...+24]

Specifies the amount of pitch change that will occur when the pitch bender is operated, in semitone units.

PRG: The pitch range specified by the program will be used. -24...+24: This setting will be used regardless of the setting in the program.

MIDI As long as this set to something other than PRG, you can control the **Bend Range** using MIDI RPN Pitch Bend Change messages.

Track 02...08, 09... 16 (Track Number):

Here, you can make pitch-related settings for MIDI tracks 2-8 and 9-16. They are the same as for track 1. For more information, please see “Track 01 (Track Number):” above.

✓ 3-5(6): Menu Command

- 0: **Memory Status** see p. 163
- 1: **Exclusive Solo** see p. 64
- 2: **Rename Song** see p. 163
- 3: **Delete Song** see p. 163
- 4: **Copy From Song** see p. 163
- 5: **Load Template Song** see p. 163
- 6: **Save Template Song (Save as User Template Song)** see p. 164
- 7: **FF/REW Speed** see p. 164
- 8: **Set Location (Set Location for Locate Key)** see p. 164
- 9: **GM Initialize** see p. 165
- 10: **Copy From Combi (Copy from Combination)** see p. 166
- 11: **Copy from Program** see p. 167
- 12: **Detune BPM Adjust** see p. 103

For more information, please see “Sequencer: Menu Command” on page 163.

3-7: Scale T01-08, 3-8: Scale T09-16

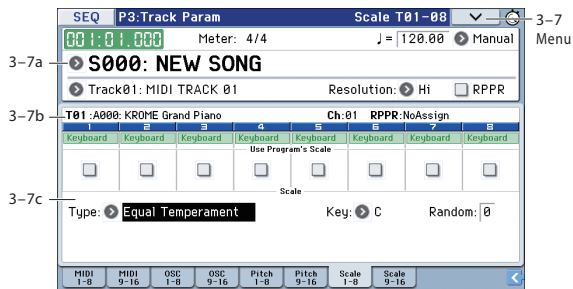

Here, you can adjust the settings for the scale for each MIDI track.

3-7(8)a: Location, Meter, Tempo, Tempo Mode, Song Select, Track Select, Reso, RPPR

3-7(8)b: Track Info

For more information, please see “0-1(2)a: Location, Meter, Tempo, Tempo Mode, Song Select, Track Select, Reso, RPPR” on page 109.

For more information, please see “2-1: Trim T01-08, 2-2: Trim T09-16” on page 123.

3-7(8)c: Scale

Track 01 (Track Number):

Use Program's Scale [Off, On]

MIDI track can use the scale that is specified by Scale (Prog 1-2b).

On (checked): The scale specified by the program will be used.

Off (unchecked): The scale specified by Scale will be used.

Track 02...08, 09...16 (Track Number):

Here, you can set the parameters for the scale of each track 2-8 and 9-16. The settings are the same as for track 1. For more information, please see “Track 01 (Track Number):” above.

Scale:

This specifies the scale that the song will use. For more information, please see “1-2d: Scale” on page 15.

Type (Song's Scale)

[Equal Temperament...User Octave Scale15]

Selects the scale.

Key [C...B]

Random [0...7]

As this value is increased, an increasingly random deviation will be added to the pitch at each note-on.

MIDI If **Status** (Seq 3-1(2)c) is INT, this setting will affect the pitch produced by the KROME. If **Status** is EXT, this setting will affect the note number of the note messages transmitted via MIDI.

✓ 3-7(8): Menu Command

- 0: Memory Status see p. 163
- 1: Exclusive Solo see p. 64
- 2: Rename Song see p. 163
- 3: Delete Song see p. 163
- 4: Copy From Song see p. 163
- 5: Load Template Song see p. 163
- 6: Save Template Song (Save as User Template Song) see p. 164
- 7: FF/REW Speed see p. 164
- 8: Set Location (Set Location for Locate Key) see p. 164
- 9: GM Initialize see p. 165
- 10: Copy From Combi (Copy from Combination) see p. 166
- 11: Copy from Program see p. 167

For more information, please see “Sequencer: Menu Command” on page 163.

SEQ P4: Zones/Delay

4-1: Key Zone T01-08, 4-2: Key Zone T09-16 (Keyboard Zones T01-08, T09-16)

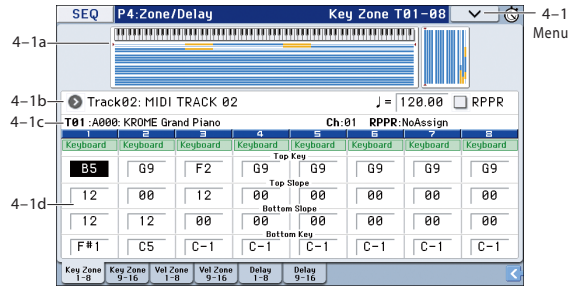

Here, you can specify the key zones in which MIDI tracks 1-8 and 9-16 will sound.

The top/bottom key settings specify the zone in which MIDI tracks 1-8 and 9-16 will sound, and the top/bottom slope settings specify the key range over which the volume will change starting from the top/bottom key.

For more information, please see “4-1: Key Zone T01-08, 4-2: Key Zone T09-16 (Keyboard Zones T01-08, T09-16)” on page 129.

MIDI These settings do not affect MIDI transmission/reception. All note data that is received will be recorded into the internal sequencer, and all note data from the internal sequencer or from the keyboard will be transmitted.

4-1(2)a: Zone Map

This area indicates the note and velocity ranges in which each MIDI track (1-16) will sound.

The display uses lines to indicate the range of notes and velocities that will sound, and show the slope portion in a different color.

4-1(2)b: Track Select, Tempo, RPPR 4-1(2)c: Track Info

For more information, please see “2-1: Trim T01-08, 2-2: Trim T09-16” on page 123.

Zone Map

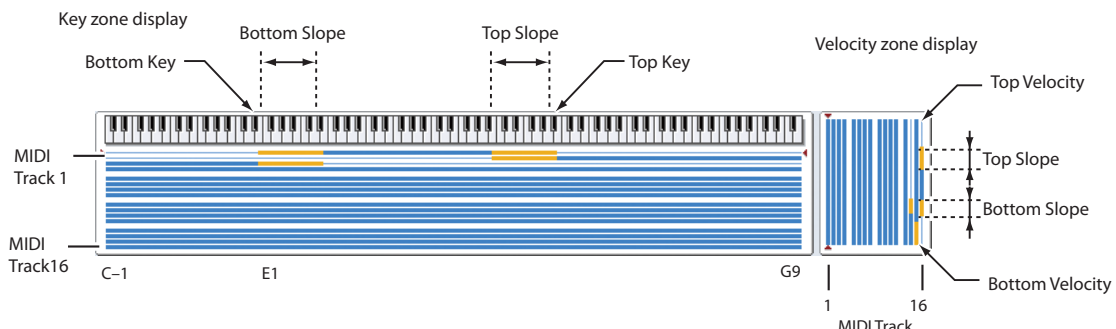

4-1(2)d: Keyboard Zones

Track 01 (Track Number):

Top Key [C-1...G9]

Specifies the top key (upper limit) of the notes that will sound for each MIDI track.

Top Slope [00, 01, 02, 03, 04, 06, 08, 10, 12, 18, 24, 30, 36, 48, 60, 72]

Specifies the range of keys (12 is one octave) over which the volume will be reached starting from the top key.

0: The volume will be at the original level from the top key.

12: The volume will increase gradually as you play downward, and will reach the original volume one octave below the top key.

72: The volume will increase gradually as you play downward, and will reach the original volume six octaves below the top key.

Bottom Slope [00, 01, 02, 03, 04, 06, 08, 10, 12, 18, 24, 30, 36, 48, 60, 72]

Specifies the range of keys (12 is one octave) over which the volume will be reached starting from the bottom key.

0: The volume will be at the original level from the bottom key.

12: The volume will increase gradually as you play upward, and will reach the original volume one octave above the bottom key.

72: The volume will increase gradually as you play upward, and will reach the original volume six octaves above the bottom key.

Bottom Key [C-1...G9]

Specifies the bottom key (lower limit) of the notes that will sound for each MIDI track.

How volume will change according to keyboard location

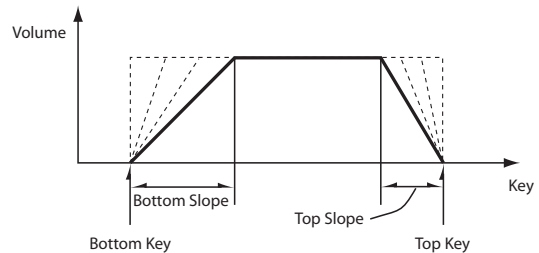

Note: You can also set the note values and velocity values by holding down an edit cell or the ENTER button and playing a key (see OG p.10).

⚠ It is not possible to set the bottom key above the top key of the same track. Nor is it possible for the top and bottom slopes to overlap.

Track 02...08, 09...16 (Track Number):

These are the key zone settings for MIDI tracks 2–8 and 9–16. They are the same as for track 1. For more information, please see “Track 01 (Track Number):” above.

✓ **4-1(2): Menu Command**

- 0: **Memory Status** see p. 163
- 1: **Exclusive Solo** see p. 64
- 2: **Rename Song** see p. 163
- 3: **Delete Song** see p. 163
- 4: **Copy From Song** see p. 163
- 5: **Load Template Song** see p. 163
- 6: **Save Template Song (Save as User Template Song)** see p. 164
- 7: **FF/REW Speed** see p. 164
- 8: **Set Location (Set Location for Locate Key)** see p. 164
- 9: **GM Initialize** see p. 165
- 10: **Copy From Combi (Copy from Combination)** see p. 166
- 11: **Copy from Program** see p. 167

For more information, please see “Sequencer: Menu Command” on page 163.

**4-3: Vel Zone T01-08,
4-4: Vel Zone T09-16
(Velocity Zones T01-08, T09-16)**

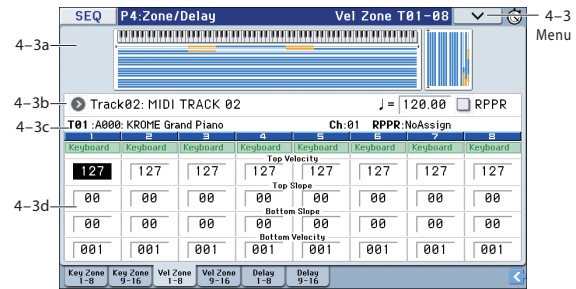

Here, you can set the Top/Bottom Velocity parameters to specify the range of velocities that will be sounded by MIDI tracks 1–8 and 9–16, and Top/Bottom Slope specify the range over which the volume will be adjusted.

For more information, please see “4-3: Vel Zone T01-08, 4-4: Vel Zone T09-16 (Velocity Zones T01-08, T09-16)” on page 130.

MIDI These settings do not affect MIDI transmission/reception. All note data that is received will be recorded into the internal sequencer, and all note data from the internal sequencer or from the keyboard will be transmitted.

⚠ It is not possible to set the bottom velocity greater than the top velocity for the same track. Nor can the top slope and the bottom slope overlap.

4-3(4)a: Zone Map

This area indicates the note and velocity ranges in which each MIDI track will sound.

For more information, please see “4-1(2)a: Zone Map” on page 129.

**4-3(4)b: Track Select, Tempo, RPPR
4-3(4)c: Track Info**

For more information, please see “2-1: Trim T01-08, 2-2: Trim T09-16” on page 123.

4-3(4)d: Velocity Zones

Track 01 (Track Number):

Top Velocity [1...127]

Specifies the maximum velocity value that will sound each track.

Top Slope [0...120]

Specifies the number of velocity steps over which the original volume will be reached, starting from the Top Velocity.

0: The volume will be at the original value from the top velocity.

120: The volume will decrease as the velocity approaches the top velocity.

Bottom Slope [0...120]

Specifies the number of velocity steps over which the original volume will be reached, starting from the Bottom Velocity.

0: The volume will be at the original value from the bottom velocity.

120: The volume will decrease as the velocity approaches the bottom velocity.

Bottom Velocity [1...127]

Specifies the minimum velocity that will be sounded by each MIDI track 1-16.

How volume will change according to keyboard location

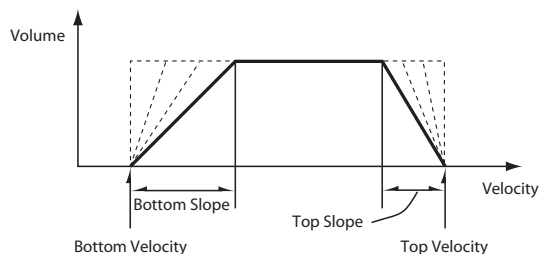

Note: You can also set the note values and velocity values by holding down an edit cell or the ENTER button and playing a key (see OG p.10).

Track 02...08, 09...16 (Track Number):

These are the velocity zone settings for MIDI tracks 2-8 and 9-16. They are the same as for track 1. For more information, please see "Track 01 (Track Number):" above.

4-3(4): Menu Command

- 0: **Memory Status** see p. 163
- 1: **Exclusive Solo** see p. 64
- 2: **Rename Song** see p. 163
- 3: **Delete Song** see p. 163
- 4: **Copy From Song** see p. 163
- 5: **Load Template Song** see p. 163
- 6: **Save Template Song (Save as User Template Song)** see p. 164
- 7: **FF/REW Speed** see p. 164
- 8: **Set Location (Set Location for Locate Key)** see p. 164
- 9: **GM Initialize** see p. 165
- 10: **Copy From Combi (Copy from Combination)** see p. 166
- 11: **Copy from Program** see p. 167

For more information, please see "Sequencer: Menu Command" on page 163.

4-5: Delay T01-08, 4-6: Delay T09-16

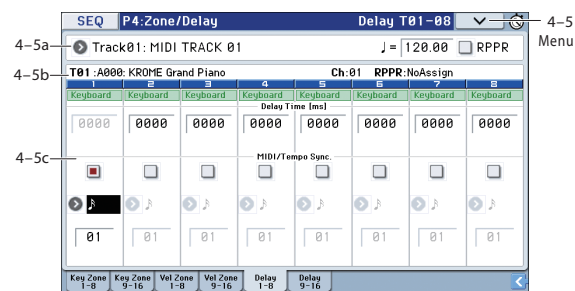

This specifies the time (delay) from when the MIDI tracks 1-8 and 9-16 receive a note-on message until the sound begins.

4-5(6)a: Track Select, Tempo, RPPR

4-5(6)b: Track Info

For more information, please see "2-1: Trim T01-08, 2-2: Trim T09-16" on page 123.

4-5(6)c: Delay

Track 01 (Track Number):

Delay Time [ms] [0000...5000ms, KeyOff]

Specifies the time (delay time) from note-on until the MIDI track begins to produce sound, in units of ms (1/1000th of a second). This setting is available if **MIDI/Tempo Sync.** is set to Off.

KeyOff: The note will begin sounding at note-off. In this case, the sound will not die away if the sustain level of the program's amp EG is other than 0. This setting is used when creating harpsichord sounds.

Normally you will set this to 0000.

MIDI/Tempo Sync. [Off, On]

The time (delay time) from note-on until the track produces sound will be specified in note length units relative to the ♩ (**Tempo**).

On (checked): Specify the delay time in terms of a **Base Note** and **Times** relative to the **Tempo**. For example if **Base Note** = ♩, **Times** = 01, and **Tempo** = 60 BPM, the delay time will be equivalent to 1000 ms.

Off (unchecked): The delay time will be set by the **Delay Time** setting.

Base Note [♩, ♪, ♫, ♮, ♯, ♭, ♮, ♯, ♭, ♮, ♯, ♭, ♮, ♯, ♭, ♮]

Times [01...32]

It specifies the time (delay time) from note-on until the track begins to produce sound, in terms of a note value relative to the ♩ (**Tempo**) (Seq 0-1(2)a).

Use **Base Note** to specify the desired note value, and use **Times** to extend that note value by the specified multiple.

For example if you set **Base Note** to a quarter note (♩) and **Times** to 02, that track will sound with a delay of a half note (♪). Even if you change ♩ (**Tempo**) (Seq 0-1(2)a), the delay time will always be a half note (♪). If you use these parameters to specify a delay of a half note (♪). In this case, a **Tempo** of 60.00 BPM will produce a 2000 ms delay, and a **Tempo** of 120.00 BPM will produce a 1000 ms delay.

Track 02...08, 09...16 (Track Number):

These are the delay time settings for MIDI tracks 2–8 and 9–16. They are the same as for track 1. For more information, please see “Track 01 (Track Number):” above.

∨ 4–5(6): Menu Command

- 0: **Memory Status** see p. 163
- 1: **Exclusive Solo** see p. 64
- 2: **Rename Song** see p. 163
- 3: **Delete Song** see p. 163
- 4: **Copy From Song** see p. 163
- 5: **Load Template Song** see p. 163
- 6: **Save Template Song (Save as User Template Song)**
see p. 164
- 7: **FF/REW Speed** see p. 164
- 8: **Set Location (Set Location for Locate Key)** see p. 164
- 9: **GM Initialize** see p. 165
- 10: **Copy From Combi (Copy from Combination)** see p. 166
- 11: **Copy from Program** see p. 167

For more information, please see “Sequencer: Menu Command” on page 163.

SEQ P5: MIDI Filter

Here, you can select whether or not to apply filtering to the MIDI data received by MIDI tracks 1-16. For example even if two tracks are receiving the same MIDI channel, one can be set to respond to damper pedal activity while the other does not.

MIDI These MIDI filter settings have no effect on the MIDI messages that have already been recorded.

MIDI These settings affect the MIDI messages that are transmitted when you adjust program, pan, volume, portamento and send 1/2 parameters of a track whose **Status** (Seq 3-1(2)c) is set to BTH, EXT, or EX2.

On (checked): Reception of MIDI data is enabled. Tracks whose **Status** (Seq 3-1(2)c) is INT or BTH will receive these types of MIDI messages on their respective channels. The type of effects that are checked will be applied to the program of each track when the KROME's controllers are operated or when MIDI data is received. (The effect dynamic modulation function is not affected by these settings.)

Settings that regulate MIDI transmission/reception of the KROME itself are made in MIDI Filter (Global 1-2b).

If the user-assignable controllers that can be filtered in the MIDI Filter 1-4 and 2-5 pages are set to MIDI control changes, filtering will be performed for these control changes. In this case, any control change filtering that is being performed in the MIDI Filter 1-1 to 1-3 pages will be given priority. Furthermore, if the same control change is assigned to multiple controllers for which there are filter settings in the MIDI Filter 1-4 and 2-5 pages, checking any one of these will enable that control change.

Off (unchecked): Reception of MIDI data is disabled.

Note: MIDI CC# = MIDI control change message numbers.

Enable After Touch [Off, On]
Specifies whether or not MIDI after touch messages will be received.

Enable Damper [Off, On]
Specifies whether or not MIDI CC#64 hold (damper pedal) messages will be received.

Enable Portamento SW [Off, On]
Specifies whether or not MIDI CC#65 portamento on/off messages will be received.

Track 02...08, 09... 16 (Track Number):

These are the MIDI Filter 1 settings for MIDI tracks 2-8 and 9-16. They are the same as for track 1. For more information, please see "Track 01 (Track Number):" above.

✓ 5-1(2): Menu Command

- 0: **Memory Status** see p. 163
- 1: **Exclusive Solo** see p. 64
- 2: **Rename Song** see p. 163
- 3: **Delete Song** see p. 163
- 4: **Copy From Song** see p. 163
- 5: **Load Template Song** see p. 163
- 6: **Save Template Song (Save as User Template Song)** see p. 164
- 7: **FF/REW Speed** see p. 164
- 8: **Set Location (Set Location for Locate Key)** see p. 164
- 9: **GM Initialize** see p. 165
- 10: **Copy From Combi (Copy from Combination)** see p. 166
- 11: **Copy from Program** see p. 167

For more information, please see "Sequencer: Menu Command" on page 163.

5-1: <1> T01-08, 5-2: <1> T09-16

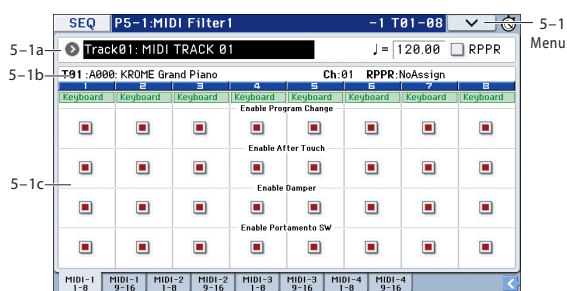

5-1(2)a: Track Select, Tempo, RPPR 5-1(2)b: Track Info

For more information, please see "2-1: Trim T01-08, 2-2: Trim T09-16" on page 123.

5-1(2)c: MIDI Filter 1

Track 01 (Track Number):

Enable Program Change [Off, On]
Specifies whether or not MIDI program change messages will be received.

**5-3: <2> T01-08,
5-4: <2> T09-16**

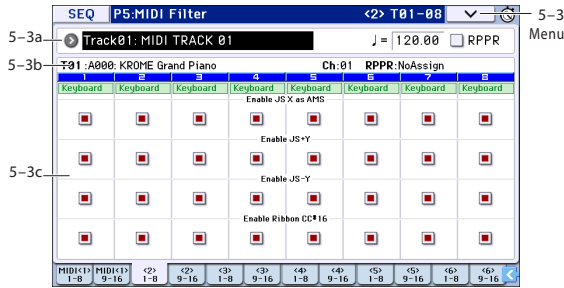

**5-3(4)a: Track Select, Tempo, RPPR
5-3(4)b: Track Info**

For more information, please see “2-1: Trim T01-08, 2-2: Trim T09-16” on page 123.

5-3(4)c: MIDI Filter 2

Track 01 (Track Number):

Enable JS X as AMS [Off, On]

Specifies whether or not MIDI pitch bend messages (the X axis of the joystick) will be received to control the AMS effect assigned to JS X. (This is not a filter for MIDI pitch bend message reception.) For more information, please see “Alternate Modulation Sources (AMS)” on page 339.

Enable JS+Y [Off, On]

Specifies whether or not MIDI CC#1 (the +Y axis of the joystick, or a Realtime Controls knob assign setting) will be received.

Enable JS-Y [Off, On]

Specifies whether or not MIDI CC#2 (the -Y axis of the joystick, or a Realtime Controls knob assign setting) will be received.

Enable Ribbon [Off, On]

Specifies whether or not MIDI CC#16 (specified as the assignment of a Realtime Controls knob) will be transmitted or received.

Track 02...08, 09...16 (Track Number):

These are the MIDI Filter 2 settings for MIDI tracks 2-8 and 9-16. They are the same as for track 1. For more information, please see “Track 01 (Track Number):” above.

5-3(4): Menu Command

- 0: Memory Status see p. 163
- 1: Exclusive Solo see p. 64
- 2: Rename Song see p. 163
- 3: Delete Song see p. 163
- 4: Copy From Song see p. 163
- 5: Load Template Song see p. 163
- 6: Save Template Song (Save as User Template Song) see p. 164
- 7: FF/REW Speed see p. 164
- 8: Set Location (Set Location for Locate Key) see p. 164
- 9: GM Initialize see p. 165
- 10: Copy From Combi (Copy from Combination) see p. 166
- 11: Copy from Program see p. 167

For more information, please see “Sequencer: Menu Command” on page 163.

**5-5: <3> T01-08,
5-6: <3> T09-16**

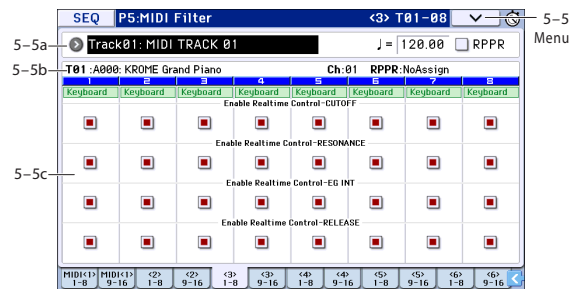

Here, you can specify whether the effect of knobs 1-4 when the SELECT button has selected Realtime Controls TONE will be transmitted and received. The MIDI control messages assigned to knobs 1-4 when Realtime Controls TONE is selected are fixed.

**5-5(6)a: Track Select, Tempo, RPPR
5-5(6)b: Track Info**

For more information, please see “2-1: Trim T01-08, 2-2: Trim T09-16” on page 123.

5-5(6)c: MIDI Filter 3

Track 01 (Track Number):

Enable Realtime Controls-CUTOFF [Off, On]

Enables or disables reception of MIDI CC#74 (the KROME’s filter cutoff frequency), which is assigned to knob 1 when Realtime Controls TONE is selected.

Enable Realtime Controls-RESONANCE [Off, On]

Enables or disables reception of MIDI CC#71 (the KROME’s filter resonance level), which is assigned to knob 2 when Realtime Controls TONE is selected.

Enable Realtime Controls-EG INTENSITY [Off, On]

Enables or disables reception of MIDI CC#79 (the KROME’s filter EG intensity), which is assigned to knob 3 when Realtime Controls TONE is selected.

Enable Realtime Controls-RELEASE [Off, On]

Enables or disables reception of MIDI CC#72 (the KROME's filter/amp EG release time), which is assigned to knob 4 when Realtime Controls TONE is selected.

Track 02...08, 09...16 (Track Number):

These are the MIDI Filter 3 settings for MIDI tracks 2-8 and 9-16. They are the same as for track 1. For more information, please see "Track 01 (Track Number):" above.

✓ **5-5(6): Menu Command**

- 0: **Memory Status** see p. 163
- 1: **Exclusive Solo** see p. 64
- 2: **Rename Song** see p. 163
- 3: **Delete Song** see p. 163
- 4: **Copy From Song** see p. 163
- 5: **Load Template Song** see p. 163
- 6: **Save Template Song (Save as User Template Song)** see p. 164
- 7: **FF/REW Speed** see p. 164
- 8: **Set Location (Set Location for Locate Key)** see p. 164
- 9: **GM Initialize** see p. 165
- 10: **Copy From Combi (Copy from Combination)** see p. 166
- 11: **Copy from Program** see p. 167

For more information, please see "Sequencer: Menu Command" on page 163.

**5-7: <4> T01-08,
5-8: <4> T09-16**

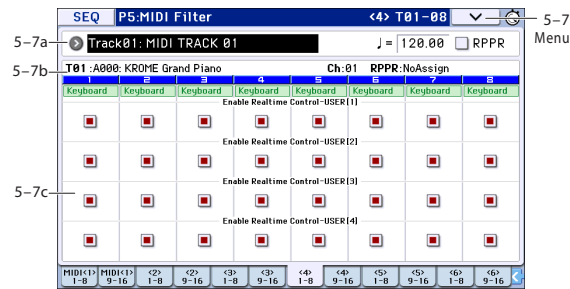

Here, you can enable or disable transmission and reception for the functions of knobs 1-4 when the SELECT button is set to Realtime Controls USER. Use the P1: Controllers-Controllers Setup page to assign the functions that knobs 1-4 will perform when Realtime Controls USER is selected.

5-7(8)a: Track Select, Tempo, RPPR

5-7(8)b: Track Info

For more information, please see "2-1: Trim T01-08, 2-2: Trim T09-16" on page 123.

5-7(8)c: MIDI Filter4

Track 01 (Track Number):

- Enable Realtime Controls-USER [1] [Off, On]**
- Enable Realtime Controls-USER [2] [Off, On]**
- Enable Realtime Controls-USER [3] [Off, On]**
- Enable Realtime Controls-USER [4] [Off, On]**

These settings enable or disable reception of the MIDI messages assigned to knobs 1-4 when Realtime Controls USER is selected.

Track 02...08, 09...16 (Track Number):

These are the MIDI Filter 4 settings for MIDI tracks 2-8 and 9-16. They are the same as for track 1. For more information, please see "Track 01 (Track Number):" above.

✓ **5-7(8): Menu Command**

- 0: **Memory Status** see p. 163
- 1: **Exclusive Solo** see p. 64
- 2: **Rename Song** see p. 163
- 3: **Delete Song** see p. 163
- 4: **Copy From Song** see p. 163
- 5: **Load Template Song** see p. 163
- 6: **Save Template Song (Save as User Template Song)** see p. 164
- 7: **FF/REW Speed** see p. 164
- 8: **Set Location (Set Location for Locate Key)** see p. 164
- 9: **GM Initialize** see p. 165
- 10: **Copy From Combi (Copy from Combination)** see p. 166
- 11: **Copy from Program** see p. 167

For more information, please see "Sequencer: Menu Command" on page 163.

**5-9: <5> T01-08,
5-10: <5> T09-16**

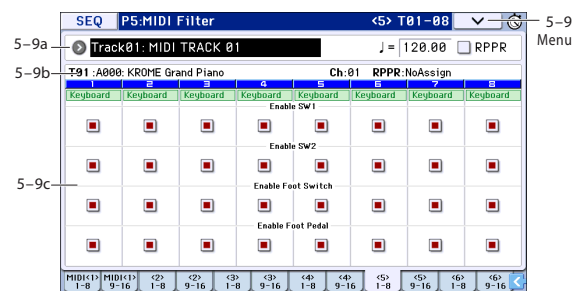

5-9(10)a: Track Select, Tempo, RPPR

5-9(10)b: Track Info

For more information, please see "2-1: Trim T01-08, 2-2: Trim T09-16" on page 123.

5-9(10)c: MIDI Filter

Track 01 (Track Number):

Enable SW1 [Off, On]

Enable SW2 [Off, On]

These settings specify whether SW1 Mod (CC#80) and SW2 Mod (CC#81) will be transmitted and received if they are assigned to the SW1 and SW2 buttons.

Note: If Portamento SW (CC#65) is assigned to SW1 or SW2, the Enable Portamento SW setting on the MIDI <1> page will take priority.

Note: The functions of SW1 and SW2 are assigned on the P1: Controllers Setup page (see p.122).

Enable Foot Switch [Off, On]

Specifies whether or not the effect of the ASSIGNABLE SWITCH will be received. The function is assigned in Global P2: Controllers–Foot Controllers page.

This filter setting is valid when a MIDI control change is assigned.

Enable Foot Pedal [Off, On]

Specifies whether or not the effect of the ASSIGNABLE PEDAL will be received. The function is assigned in Global P2: Controllers–Foot Controllers page.

This filter setting is valid when a MIDI control change is assigned.

Track 02...08, 09...16 (Track Number):

These are the MIDI Filter 5 settings for MIDI tracks 2-8 and 9-16. They are the same as for track 1. For more information, please see "Track 01 (Track Number):" above.

5-9(10): Menu Command

- 0: Memory Status see p. 163
- 1: Exclusive Solo see p. 64
- 2: Rename Song see p. 163
- 3: Delete Song see p. 163
- 4: Copy From Song see p. 163
- 5: Load Template Song see p. 163
- 6: Save Template Song (Save as User Template Song) see p. 164
- 7: FF/REW Speed see p. 164
- 8: Set Location (Set Location for Locate Key) see p. 164
- 9: GM Initialize see p. 165
- 10: Copy From Combi (Copy from Combination) see p. 166
- 11: Copy from Program see p. 167

For more information, please see "Sequencer: Menu Command" on page 163.

5-11: <6> T01-08, 5-12: <6> T09-16

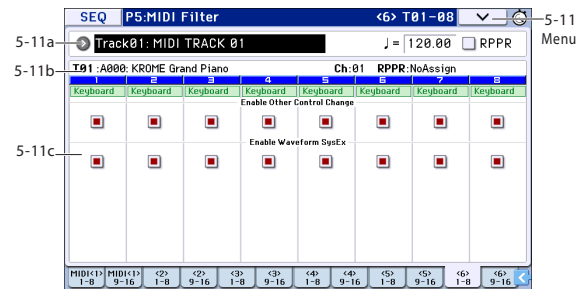

5-11(12)a: Track Select, Tempo, RPPR

5-11(12)b: Track Info

For more information, please see "2-1: Trim T01-08, 2-2: Trim T09-16" on page 123.

5-11(12)c: MIDI Filter3

Track 01 (Track Number):

Enable Other Control Change Messages [Off, On]

Specifies whether or not MIDI control messages not covered in the preceding MIDI Filter items will be received.

Enable Waveform SysEx [Off, On]

This enables or disables reception of MIDI system exclusive messages that freely switch the multisample used by an oscillator while the program is sounding.

Track 02...08, 09...16 (Track Number):

These are the MIDI Filter 6 settings for MIDI tracks 2-8 and 9-16. They are the same as for track 1. For more information, please see "Track 01 (Track Number):" above.

5-11(12): Menu Command

- 0: Memory Status see p. 163
- 1: Exclusive Solo see p. 64
- 2: Rename Song see p. 163
- 3: Delete Song see p. 163
- 4: Copy From Song see p. 163
- 5: Load Template Song see p. 163
- 6: Save Template Song (Save as User Template Song) see p. 164
- 7: FF/REW Speed see p. 164
- 8: Set Location (Set Location for Locate Key) see p. 164
- 9: GM Initialize see p. 165
- 10: Copy From Combi (Copy from Combination) see p. 166
- 11: Copy from Program see p. 167

For more information, please see "Sequencer: Menu Command" on page 163.

SEQ P6: Track Edit

6-1: Track Edit



Here, you can edit MIDI tracks 1–16, and the master track. When editing a MIDI track, you can move, insert, and delete individual note events or control change data, or copy, move, insert, and delete measures or tracks. You can also perform Step Recording in this page.

When editing the master track, you can edit the tempo and the time signature.

Note: To perform track editing (or step editing), use **Track Select** to select the track you want to edit, and use **From Measure** and **To End of Measure** parameters to specify the region that you want to edit. Then choose a command from the menu, and execute the edit. For details on the specific commands, please see “Sequencer: Menu Command” on page 163.

6-1a: Location, Meter, Tempo, Tempo Mode, Song Select, Track Select, Reso, RPPR

6-1b: Track Info

“(0-1(2)a: Location, Meter, Tempo, Tempo Mode, Song Select, Track Select, Reso, RPPR” on page 109)

“(2-3: EQ T01-08, 2-4: EQ T09-16” on page 124)

6-1c: Track data Map, From Measure, To End of Measure

Track data Map

This area shows the presence or absence of performance data, and indicates the edit range, etc. The currently selected Track will be highlighted.

From Measure [001...999]
To End of Measure [001...999]

Specifies the range of measures that you wish to edit (or copy from) or step-record.

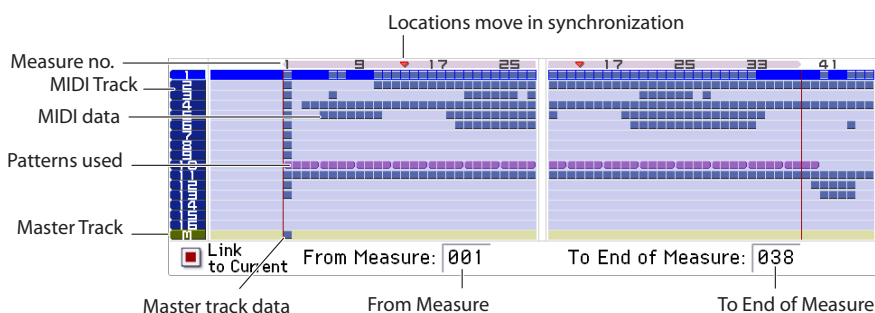

Use **From Measure** to specify the starting measure, and **To End of Measure** to specify the ending measure.

Link From Measure current location [Off, On]

If this check box is selected, the **From Measure** setting will be linked to the current location, and the location of the displayed track will also change. The location will change to follow this even during playback or recording.

6-1: Menu Command

- 0: **Memory Status** see p. 163
- 1: **Exclusive Solo** see p. 64
- 2: **Step Recording** see p. 167
- 3: **Event Edit** see p. 169
- 4: **Piano Roll** see p. 171
- 5: **Set Song Length** see p. 176
- 6: **Erase Track** see p. 176
- 7: **Copy Track** see p. 176
- 8: **Bounce Track** see p. 177
- 9: **Erase Measure** see p. 177
- 10: **Delete Measure** see p. 177
- 11: **Insert Measure** see p. 178
- 12: **Repeat Measure** see p. 178
- 13: **Copy Measure** see p. 179
- 14: **Move Measure** see p. 179
- 15: **Create Control Data** see p. 180
- 16: **Erase Control Data** see p. 181
- 17: **Quantize** see p. 181
- 18: **Shift/Erase Note** see p. 182
- 19: **Modify Velocity** see p. 183
- 20: **FF/REW Speed** see p. 164
- 21: **Set Location (Set Location for Locate Key)** see p. 164
- 22: **Create Exclusive Data** see p. 183
- 23: **Erase Exclusive Data** see p. 184

For more information, please see “Sequencer: Menu Command” on page 163.

6-2: Track View

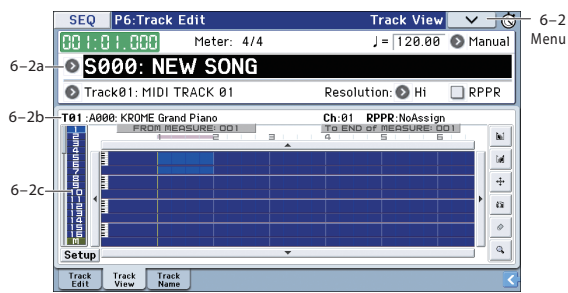

Here you can edit MIDI tracks 1–16 and the master track. This page provides an overall view of each track’s data such as note, velocity, and control change data.

In the track view area you can drag to select track and measure regions, and move, copy, or erase tracks. You can also edit in measure units.

You can also use various menu commands to edit the region you selected by dragging.

6-2a: Location, Meter, Tempo, Tempo Mode, Song Select, Track Select, Reso, RPPR

6-2b: Track Info

(“0-1(2)a: Location, Meter, Tempo, Tempo Mode, Song Select, Track Select, Reso, RPPR” on page 109)

(“2-3: EQ T01-08, 2-4: EQ T09-16” on page 124)

Track Select [Track01...Track16, Master Track]

Here you can select the track to edit. This **Track Select** setting will change when you press the track view area. When the track changes, the display will briefly turn blue. The highlighted portion that shows the selected region of the track view area will also change when you change the track here.

6-2c: Track View Area

Track View Area

This shows event information for each track, such as note, velocity, and control change data. (see illustration below)

The highlighted measures are those that will be edited. The region is indicated by the FROM MEASURE and TO END OF MEASURE fields in the upper part of the screen.

You can move, copy, or delete measures and tracks in units of one measure.

Note: You can’t specify a range of measures unless a tool in the box tool is selected.

Track View Area Select

This shows track information for the track view area. The bar at the left indicates the four tracks shown in the track view area. The highlighted track number is the track that will be edited.

The track display region will change when you touch the track number.

In the Track View Setup dialog box you can change the order of the tracks.

Scroll buttons

- These scroll the tracks or measures shown in the track view area. Press the scroll button in the direction that you want to move. You can also scroll by pressing inside the track view area and dragging toward the outer edge of the button.

Tool box

Start point select tool

Use this to specify the starting measure (FROM MEASURE) of the range of measures you want to edit.

Choose this tool, and then press a measure in a track to specify the starting measure (and the track). Continue holding down the starting measure, drag to the right, and release at the end of the desired selection. While dragging, you can drag across a scroll button to scroll through the measures while maintaining the selection.

If more than one measure is selected even though you actually wanted to select only one measure, simply continue pressing for approximately one second; the single measure you’re pressing will be selected.

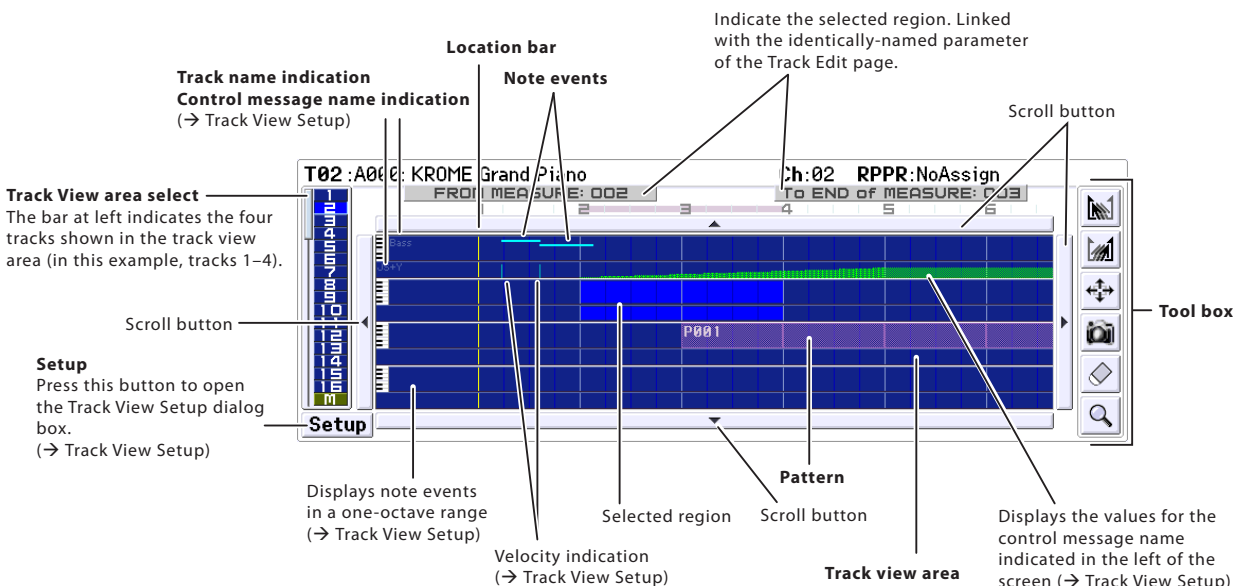

Note: When selecting, the upper line FROM MEASURE or To END of MEASURE will briefly turn blue, and will indicate the selected measure number.

 **End point select tool**

Use this to specify the last measure (To END of MEASURE) of the range of measures that you want to edit.

Choose this tool, and then press a measure in a track to specify the ending measure (and the track). Continue holding down the starting measure, drag to the left, and release at the end of the desired selection. While dragging, you can drag across a scroll button to scroll through the measures while maintaining the selection.

If more than one measure is selected even though you actually wanted to select only one measure, simply continue pressing for approximately one second; the single measure you're pressing will be selected.

Note: When selecting, the upper line FROM MEASURE or To END of MEASURE will briefly turn blue, and will indicate the selected measure number.

Example)
Using the Start Point Select tool to specify a region

1. Press the  tool.
2. Press the desired starting measure for the track in which you want to select a region.

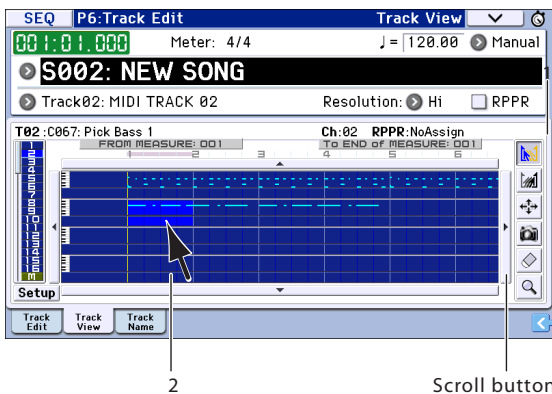

3. While continuing to press, drag to the last measure of the desired range, and release your finger.

You can scroll the measure display by dragging your finger onto or across a scroll bar.

The edit region will be selected and highlighted.

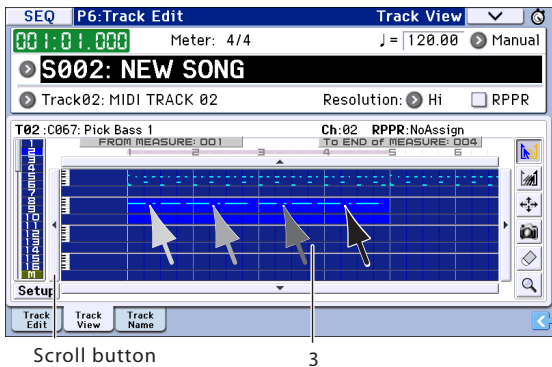

Example)
Using the End Point Select tool to specify a region



1. Press the  tool.
2. Press the desired ending measure for the track in which you want to select a region.
3. While continuing to press, drag to the first measure of the desired range, and release your finger.

You can scroll the measure display by dragging your finger onto or across a scroll bar.

The edit region will be selected and highlighted.

 **Move tool**

Use this to move the measures of the region you've specified.

Use the  or  tool to select the region that you want to move, and then choose this tool. Press the move-destination measure or drag the selected region of measures to move them.

If data exists at the move-destination, the Drag Move dialog box will appear, allowing you to select whether to overwrite or keep the data at the destination.

Note: This operation is equivalent to executing the **Move Measure** menu command with **Mode** set to Stay (see p.179).

Example)
Moving the events of measures 1-2 to measures 5-6

1. Press the  tool.
2. Drag over measures 1-2 to specify the edit region.

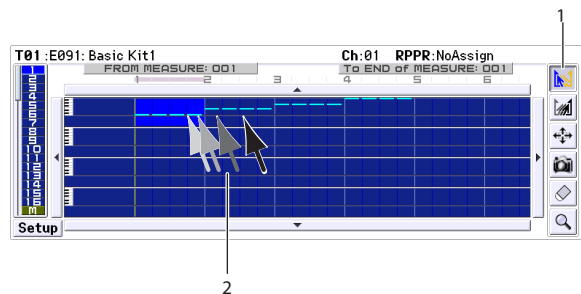

3. Press the  tool.
4. Press measure 5 (the move-destination measure). Alternatively, drag the edit region to measure 5.

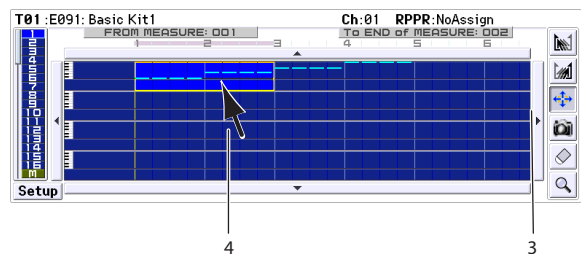

5. In this example, an event exists in the move-destination measure, so the Drag Move dialog box will appear.

Overwrite will overwrite the source data over the destination data (replacing the destination data with the source data).

Merge will combine the source and destination data.

Press the OK button to execute the move.

If there are no events in the move-destination measures, this dialog box will not appear; the move will occur immediately.

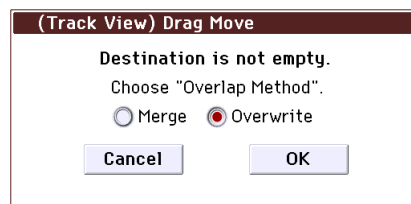

If you choose Overwrite

The destination is overwritten by the source data

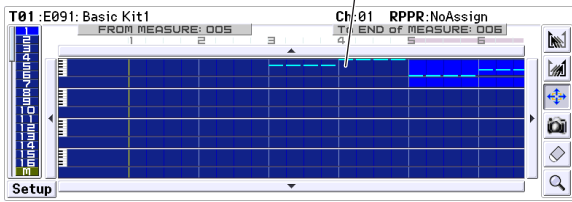

If you choose Merge

The two sets of data are combined

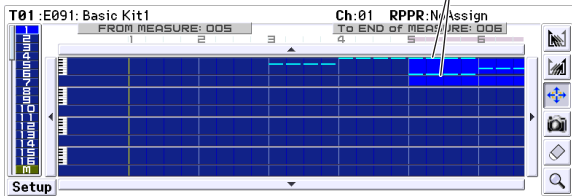

Example)

Moving the data of an entire track

1. Return the location to the beginning.
2. Press the tool.
3. Press the left side of measure 1 in the track you want to move.

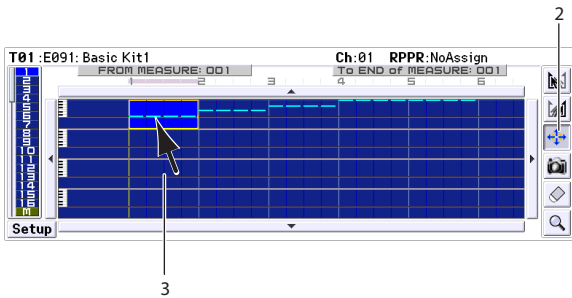

4. While continuing to press, drag to the move-destination track, and release.

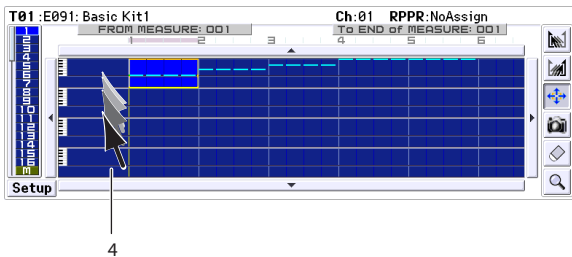

If the move-destination measures contain events, the Drag Move dialog box will appear.

Overwrite will overwrite the source data over the destination data (replacing the destination data with the source data). Merge will combine the source and destination data. Press the OK button to execute the move.

If there are no events in the move-destination measures, this dialog box will not appear; the move will occur immediately.

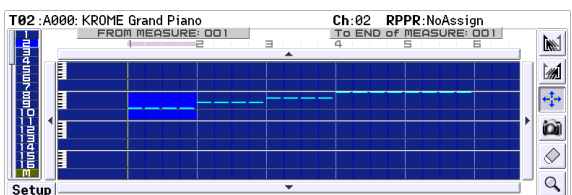

Copy tool

Use this to copy the events of the selected measures.

Use the or tool to select the region that you want to copy, and then choose this tool. Press the copy-destination measure or drag the selected region of measures to the desired copy-destination. The data at the copy-destination will always be overwritten.

Note: This operation is equivalent to executing the Copy Measure menu command (see p.179).

Example)

Copying the events of measures 1–2 to measures 3–4

1. Press the tool.
2. Drag over measures 1–2 to specify the edit region.

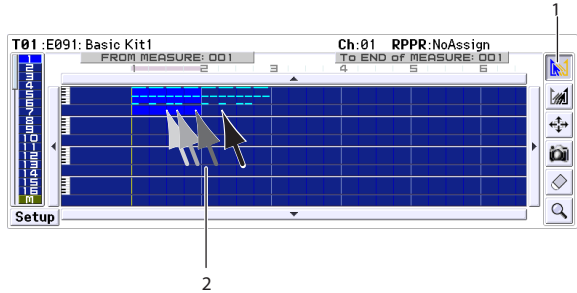

3. Press the tool.

4. Press measure 3 (the copy-destination measure). Alternatively, drag the edit region to measure 3.

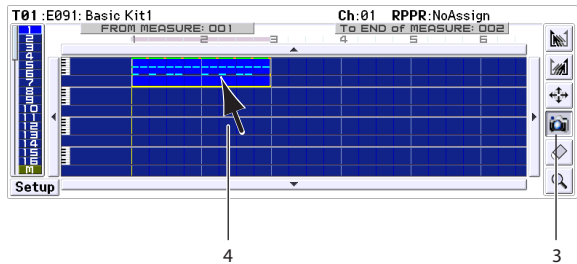

The copy will be executed.

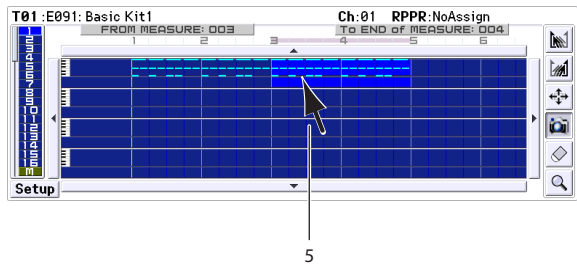

5. If desired, you can press another copy-destination to copy the data repeatedly.

Example) Copying the data of an entire track

You can copy the data of an entire track to another track. Refer to “Example”) Moving the data of an entire track.” In step 2, choose the tool.

Erase tool

Use this to erase the events from the selected measures.

Choose this tool, and press the measures you want to erase. The events of those measures will be erased.

This operation is equivalent to executing the Erase Measure command with Kind set to All (See “Erase Measure” on page 177.).

Example) Erasing events

1. Press the tool.

2. Press the first measure containing the events you want to erase, and drag to the last measure. If desired, you can select measures in adjacent tracks for erasure (See "Track No."). Alternatively, you can press individual measures one at a time and erase them.

Example) Erasing all data from a track

You can erase all data from an entire track.

Press the  tool, and then press the left side of the first measure of the track you want to erase. The data will be erased.

 **Piano Roll jump**

You can jump to Piano Roll editing by pressing this button when a track 1-16 is selected.

Note: This operation is equivalent to selecting the **Piano Roll** menu command (See "Piano Roll" on page 171.).

Note: If you press this button or select the **Piano Roll** menu command to open the Piano Role dialog box for a track that contains no events, a track of the same length as the song (64 measures by default) will be created before the Piano Roll dialog box opens.

If you've selected the master track, this button will take you to event editing.

Scroll buttons

By pressing these buttons you can move to tracks or measures that are not currently displayed. Even without pressing directly on one of these buttons, you can scroll the display by dragging across a scroll button from inside the track view area.

The horizontal direction in which the scroll buttons operate will depend on the **Play Scroll** setting in the Track View Setup dialog box.

Setup button

When you press the Setup button, the Track View Setup dialog box will appear, allowing you to specify how information will be displayed in the track view area.

Track View Setup dialog box

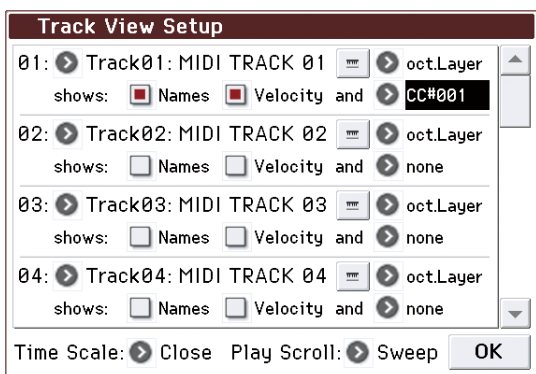

 The settings in this dialog box will be initialized when you turn off the power.

Track No.

This specifies the order of the displayed tracks. Normally, Track01-Track16 are shown for 01-16. You can use this to change the order if the tracks you want to see are far apart.

Note Display

[oct.Layer, All Notes, C-1~...G#8~, Auto]

This specifies how note events will be displayed.

octLayer: Note events of all octaves will be displayed together in a one-octave region. For example, note events

C4, C5, and C6 (different octaves) will be shown on the same dot line (at the C position).

All Notes: One dot line will be shown as one octave. For example, note events C4, E4, and G4 (all in the same octave) will be shown on the same dot line.

C-1~...G#8~: Only the note events of the selected octave will be shown. Each dot line will show one note.

Auto: If most of the displayed note events are within one octave, they will be displayed using one dot line per note. If the notes extend more than one octave, they will be displayed using All Notes.

shows:

Specifies the track information that is shown at the left edge and bottom of each track view area.

Names [Off, On]

If this check box is selected, track names and the type of selected control event will be shown at the left of the track view screen.

Velocity [Off, On]

If this check box is selected, the velocity values of note events will be shown. In the case of a chord, the highest value will be shown.

and [none, PolyAfter, CC#000...CC#119 (*Y), Program, AfterT, Bend, Exclusive]

This selects the information (such as control changes) that will be shown. If you don't want any of these to be shown, choose "none."

Green: Control Change, Poly After, After Touch

The location of an event is indicated by a solid line or solid color, and by a shaded area for the duration that the effect continues. The shaded area is not shown if the location containing the event is not displayed in the track view area.

- Yellow: Pitch bend
-  : System exclusive message
- Red: Program change

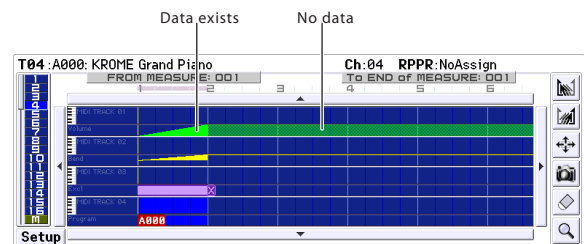

Time Scale [Close, Wide]

This specifies the scale for the time axis of the track view area.

Close: For example, the screen will show 4 or 5 measures of a 4/4 time signature.

Wide: For example, the screen will show 8 or 9 measures of a 4/4 time signature.

Play Scroll [Sweep, Crawl]

This specifies how the track view area will scroll during playback.

Sweep: When the location bar (the vertical yellow line) reaches the end of the track view area, the next measure and the location bar will move to the left.

Crawl: The track view area will move measure by measure. The location bar will stay in a fixed location.

Note: This setting also specifies how movement will occur when you press the display scroll buttons in the left/right direction while editing.

6-2: Menu Command

- 0: **Memory Status** see p. 163
- 1: **Exclusive Solo** see p. 64
- 2: **Step Recording** see p. 167
- 3: **Event Edit** see p. 169
- 4: **Piano Roll** see p. 171
- 5: **Set Song Length** see p. 176
- 6: **Erase Track** see p. 176
- 7: **Copy Track** see p. 176
- 8: **Bounce Track** see p. 177
- 9: **Erase Measure** see p. 177
- 10: **Delete Measure** see p. 177
- 11: **Insert Measure** see p. 178
- 12: **Repeat Measure** see p. 178
- 13: **Copy Measure** see p. 179
- 14: **Move Measure** see p. 179
- 15: **Create Control Data** see p. 180
- 16: **Erase Control Data** see p. 181
- 17: **Quantize** see p. 181
- 18: **Shift/Erase Note** see p. 182
- 19: **Modify Velocity** see p. 183
- 20: **FF/REW Speed** see p. 164
- 21: **Set Location (Set Location for Locate Key)** see p. 164
- 22: **Create Exclusive Data** see p. 183
- 23: **Erase Exclusive Data** see p. 184

For more information, please see "Sequencer: Menu Command" on page 163.

6-3: Track Name

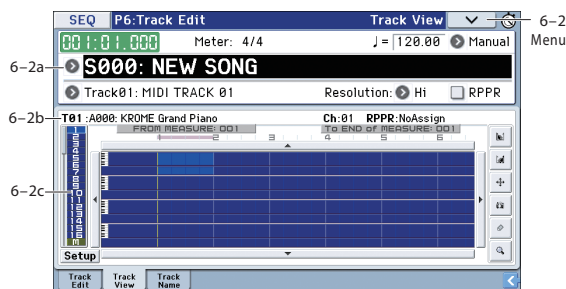

Here, you can assign a name to each track.

6-3a: Location, Meter, Tempo, Tempo Mode, Song Select, Track Select, Reso, RPPR

6-3b: Track Info

For more information, please see "0-1(2)a: Location, Meter, Tempo, Tempo Mode, Song Select, Track Select, Reso, RPPR" on page 109.

6-3c: Track Names

T01...T16 [Track name]

Here, you can rename the MIDI tracks.

Press the text edit button to open the dialog box, and input the desired characters. You can enter up to 24 characters.

For more information, please see "Editing names" on page 91 of the Operation guide.

6-3: Menu Command

- 0: **Memory Status** see p. 163
- 1: **Exclusive Solo** see p. 64
- 2: **Step Recording** see p. 167
- 3: **Event Edit** see p. 169
- 4: **Piano Roll** see p. 171
- 5: **Set Song Length** see p. 176
- 6: **Erase Track** see p. 176
- 7: **Copy Track** see p. 176
- 8: **Bounce Track** see p. 177
- 9: **Erase Measure** see p. 177
- 10: **Delete Measure** see p. 177
- 11: **Insert Measure** see p. 178
- 12: **Repeat Measure** see p. 178
- 13: **Copy Measure** see p. 179
- 14: **Move Measure** see p. 179
- 15: **Create Control Data** see p. 180
- 16: **Erase Control Data** see p. 181
- 17: **Quantize** see p. 181
- 18: **Shift/Erase Note** see p. 182
- 19: **Modify Velocity** see p. 183
- 20: **FF/REW Speed** see p. 164
- 21: **Set Location (Set Location for Locate Key)** see p. 164
- 22: **Create Exclusive Data** see p. 183
- 23: **Erase Exclusive Data** see p. 184

For more information, please see "Sequencer: Menu Command" on page 163.

SEQ P7: ARP/DT (Arpeggiator/DrumTrack)

Here, you can specify how the arpeggiator will operate in Sequencer mode. These settings can be made for each song. In Sequencer mode (as in Combination mode), you can run the two arpeggiators simultaneously.

This allows you to apply different arpeggio patterns to two sounds that have been split across the keyboard, or use velocity to switch between two different arpeggio patterns, etc.

In Sequencer mode, the musical data generated by the arpeggiator during song track or pattern realtime-recording can be recorded.

When doing so, you can modify the arpeggio pattern or parameters while you record, or use the REALTIME CONTROLS SELECT button to select ARP and use the knobs to vary the arpeggio pattern.

 It is not possible to set independent tempos for the arpeggiator and the sequencer.

When **MIDI Clock** (Global P1: 1-1a) is **Internal**, the arpeggiator can be synchronized to the internal sequencer.

- When you turn on the arpeggiator and press the START/STOP (▶/■) button, the arpeggiator will synchronize with the sequencer.
- When you press the START/STOP (▶/■) button, the arpeggiator and sequencer will both stop. If you wish to stop only the arpeggiator, press the ARP button to turn off.

When the arpeggiator **Key Sync** is off, you can turn on the ARP button and play the keyboard to start the arpeggiator during the pre-count before realtime recording begins. That way, the arpeggiator performance will be recorded from the beginning of the pattern when recording starts.

MIDI When **MIDI Clock** is set to External MIDI or External USB, clock messages transmitted from an external MIDI device can perform the same type of control.

Even in this case, you can start/stop using the KROME's START/STOP (▶/■) button.

7-1: ARP Setup T01-08, 7-2: ARP Setup T09-16

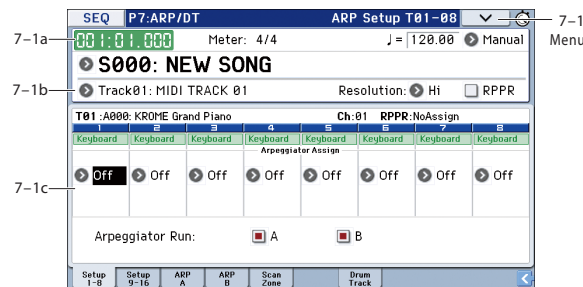

7-1(2)a: Location, Meter, Tempo, Tempo Mode, Song Select, Track Select, Reso, RPPR

7-1(2)b: Track Info

For more information, please see “0-1(2)a: Location, Meter, Tempo, Tempo Mode, Song Select, Track Select, Reso, RPPR” on page 109.

7-1(2)c: Arpeggiator Assign, Arpeggiator Run A, B

Arpeggiator Assign

[Off, A, B]

This individually assigns arpeggiator A or arpeggiator B to each track 1-8, 9-16. When the ARP button is turned on, the arpeggiator specified for each track will run, subject to the **Arpeggiator Run A, B** settings and the settings made here.

Off: Neither arpeggiator will operate.

A: Enables Arpeggiator A. Use the Arpeggiator A page to select the arpeggio pattern and set the parameters.

B: Enables Arpeggiator B. Use the Arpeggiator B page to select the arpeggio pattern and set the parameters.

For tracks that you wish to record in real time, select either arpeggiator A or B. If you specify an arpeggiator for two or more tracks, the arpeggiator will play each of the tracks you specify.

You can set A and B to two different MIDI channels, and control one from the keyboard and the other from an external MIDI device connected to MIDI IN. You can also use multi-track recording (Multi REC) to simultaneously record the note data that is generated from the two arpeggiators.

Example 1)

On tracks 1 and 2, set **MIDI Channel** (Seq 3-1(2)c) to **01** and **Status** (Seq 3-1(2)c) to **INT**. Assign arpeggiator A to track 1 and arpeggiator B to track 2, and check **Arpeggiator Run A, B**. In **Track Select**, choose Track01.

With the ARP button off, play the keyboard and tracks 1 and 2 will sound simultaneously.

When you turn on the ARP button and play the keyboard, arpeggiator A will operate for track 1 and arpeggiator B will operate for track 2.

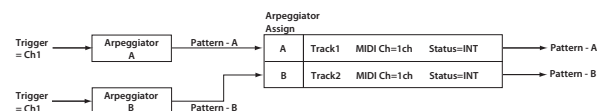

Example 2)

For tracks 1, 2 and 3, set the **MIDI Channel** (Seq 3-1(2)c) to **01, 02, and 03** respectively, and set **Status** (Seq 3-1(2)c) to **INT**. Assign arpeggiator A to tracks 1 and 2, and arpeggiator B to track 3. Check the **Arpeggiator Run A, B** setting.

- In **Track Select**, choose Track01.

Playing the keyboard when the ARP button is **off** will play the sound assigned to track 1.

Playing the keyboard when the ARP button is **on** will cause arpeggiator A to operate for tracks 1 and 2, and produce sound for both tracks.

- In **Track Select**, choose Track02.

Playing the keyboard when the ARP button is off will play the sound assigned to track 2.

Playing the keyboard when the ARP button is on will cause arpeggiator A to operate for tracks 1 and 2, and produce sound for both tracks.

- In **Track Select**, choose Track03.

Playing the keyboard when the ARP button is off will play the sound assigned to track 3.

Playing the keyboard when the ARP button is on will cause arpeggiator B to operate for track 3, and play the sound assigned to track 3.

- Alternatively, you could choose Track01 in **Track Select** to run arpeggiator A for tracks 1 and 2, and use an external MIDI device connected to the KROME's MIDI IN to send note data to MIDI channel 3 to play arpeggiator B.

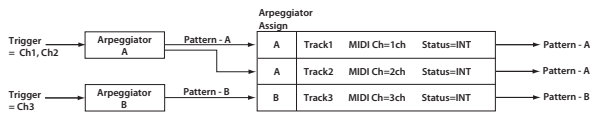

The arpeggiator cannot be triggered by the notes played by the sequencer.

MIDI If the track **Status** (Seq 3-1(2)c) is set to INT or BTH, tracks 1-16 to which arpeggiator A or B are assigned will be sounded by the note data generated by the arpeggiator, regardless of the **MIDI Channel** (Seq 3-1(2)c) setting of that track. If the track **Status** is set to BTH, EXT, or EX2, the track will transmit MIDI note data on the **MIDI Channel** of that track.

In this case, arpeggiator A or B will be triggered by the **MIDI Channel** of any track 1-16 to which the corresponding arpeggiator is assigned.

MIDI If the **Local Control On** (Global P1: 1-1a) is turned OFF, the arpeggiator will not be triggered by note data from the keyboard. It will be triggered by note data received at MIDI IN. If you wish to record just the trigger notes on an external sequencer and run the KROME's arpeggiator in this way, turn Local Control OFF.

If you want the note data generated by the arpeggiator to be recorded on the external sequencer, turn Local Control ON, and turn off the echo back function of the external sequencer. (see p.368)

Arpeggiator Run A, B [Off, On]

When the ARP button is on, the arpeggiator(s) that are checked here will function for the track(s) to which they are assigned by **Arpeggiator Assign**.

When the arpeggiator is on, A and B can be turned on/off independently.

7-1(2): Menu Command

- 0: **Memory Status** see p. 163
- 1: **Exclusive Solo** see p. 64
- 2: **Rename Song** see p. 163
- 3: **Delete Song** see p. 163
- 4: **Copy From Song** see p. 163
- 5: **Load Template Song** see p. 163
- 6: **Save Template Song (Save as User Template Song)** see p. 164
- 7: **FF/REW Speed** see p. 164
- 8: **Set Location (Set Location for Locate Key)** see p. 164
- 9: **GM Initialize** see p. 165
- 10: **Copy From Combi (Copy from Combination)** see p. 166
- 11: **Copy from Program** see p. 101
- 12: **Copy Arpeggiator** see p. 66

For more information, please see "Sequencer: Menu Command" on page 163.

7-3: Arpeggiator-A, 7-4: Arpeggiator-B

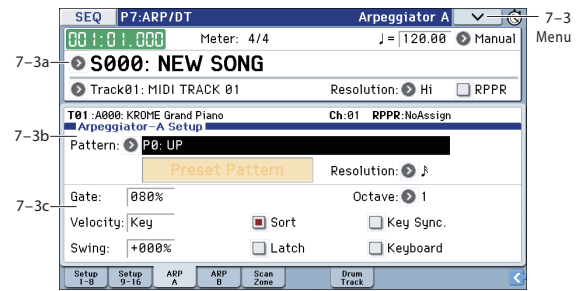

7-3(4)a: Location, Meter, Tempo, Tempo Mode, Song Select, Track Select, Reso, RPPR

7-3(4)b: Track Info

For more information, please see "0-1(2)a: Location, Meter, Tempo, Tempo Mode, Song Select, Track Select, Reso, RPPR" on page 109.

7-3(4)c: Arpeggiator-A(B) Setup

| | |
|--------------------|--|
| Pattern* | [P0...P4, U0000(INT)...U0899(INT), U0900(USER)...U1027(USER)] |
| Octave* | [1, 2, 3, 4] |
| Resolution* | [♪ ₃ , ♪ ₃ , ♪ ₃ , ♪ ₃ , ♪ ₃ , ♪ ₃ , ♪ ₃ , ♪ ₃] |
| Gate | [000...100%, Step] |
| Velocity | [001...127, Key, Step] |
| Swing | [-100...+100%] |
| Sort* | [Off, On] |
| Latch* | [Off, On] |
| Key Sync.* | [Off, On] |
| Keyboard* | [Off, On] |

These are the arpeggiator parameters for the song.

For more information, please see "PROG P7: ARP/DT (Arpeggiator/Drum Track)" on page 53.

* These parameters can also be set from "0-5(6)c: Arpeggiator A (B)".

7-3(4): Menu Command

- 0: **Memory Status** see p. 163
- 1: **Exclusive Solo** see p. 64
- 2: **Rename Song** see p. 163
- 3: **Delete Song** see p. 163
- 4: **Copy From Song** see p. 163
- 5: **Load Template Song** see p. 163
- 6: **Save Template Song (Save as User Template Song)** see p. 164
- 7: **FF/REW Speed** see p. 164
- 8: **Set Location (Set Location for Locate Key)** see p. 164
- 9: **GM Initialize** see p. 165

- 10: Copy From Combi (Copy from Combination) see p. 166
- 11: Copy from Program see p. 101
- 12: Copy Arpeggiator see p. 103

For more information, please see “Sequencer: Menu Command” on page 163.

7-5: ARP Scan Zone

These settings specify the note and velocity ranges that will operate arpeggiators A and B.

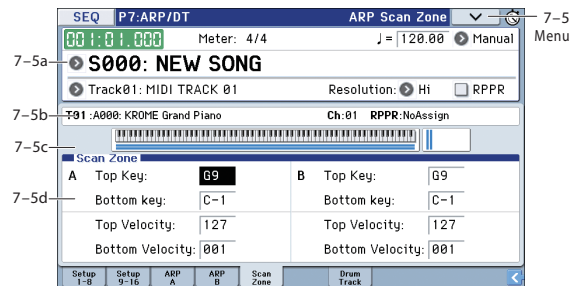

7-5a: Location, Meter, Tempo, Tempo Mode, Song Select, Track Select, Reso, RPPR

7-5b: Track Info

For more information, please see “0-1(2)a: Location, Meter, Tempo, Tempo Mode, Song Select, Track Select, Reso, RPPR” on page 109.

7-5c: Zone Map

This shows the Scan Zone for each arpeggiator, A and B. For more information, please see “7-5b: Zone Map” on page 93.

7-5d: Scan Zone

A; B:

Top Key [C-1...G9]

Bottom Key [C-1...G9]

Specifies the range of notes (keys) that will operate arpeggiator A (B). **Top Key** specifies the upper limit, and **Bottom Key** specifies the lower limit.

Top Velocity [001...127]

Bottom Velocity [001...127]

Specifies the range of velocities that will operate arpeggiator A (B). **Top Velocity** specifies the upper limit, and **Bottom Velocity** specifies the lower limit.

Specifies the range of notes (keys) and velocities that will operate arpeggiator A/B.

Note: You can also set the note and velocity values by holding down an edit cell or the ENTER button and playing a key (see OG p.10).

7-5: Menu Command

- 0: **Memory Status** see p. 163
- 1: **Exclusive Solo** see p. 64
- 2: **Rename Song** see p. 163
- 3: **Delete Song** see p. 163
- 4: **Copy From Song** see p. 163
- 5: **Load Template Song** see p. 163
- 6: **Save Template Song (Save as User Template Song)** see p. 164
- 7: **FF/REW Speed** see p. 164
- 8: **Set Location (Set Location for Locate Key)** see p. 164
- 9: **GM Initialize** see p. 165
- 10: **Copy From Combi (Copy from Combination)** see p. 166
- 11: **Copy from Program** see p. 101
- 12: **Copy Arpeggiator** see p. 66

For more information, please see “Sequencer: Menu Command” on page 163.

7-7: Drum Track

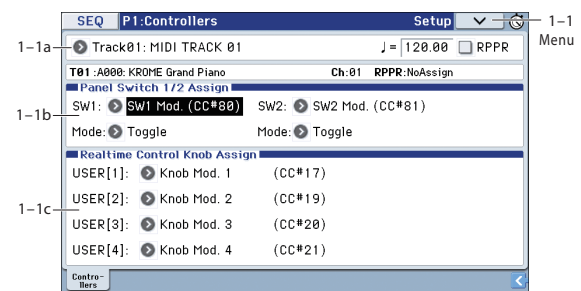

The parameters for the Drum Track function are structured in the same way as in Combination mode. Assign the Drum Track program to the desired track 1-16.

However, while a combination triggers the Drum Track pattern on the global MIDI channel, a song triggers the Drum Track pattern on the MIDI channel specified by Drum Pattern **Input**. Normally you'll set this to Tch. With the Tch setting, the MIDI channel of the track selected by **Track Select** will automatically be used as the trigger channel.

In Sequencer mode you can use the Drum Track function while realtime-recording a song track or pattern.

The note-on/off data transmitted by the Drum Track pattern can be recorded as events in a track or pattern.

 You can't use note data from the internal sequencer as a trigger to start patterns for the Drum Track function.

When you've used the Drum Track function with a program or combination to come up with an idea for a song, you can then use the Auto Song Setup function to immediately start realtime-recording (see p.106).

MIDI transmission and reception for the drum track

In Sequencer mode, the Drum Track function transmits and receives on the following MIDI channels.

Receive: The drum track will receive on the MIDI channel specified by the Drum Pattern **Input** setting of each song. Normally you'll set this to Tch and use the KROME's keyboard to control the triggering.

Transmit: The drum track will transmit on the MIDI channel specified by the Drum Pattern **Output** setting of each song.

Set this to match the MIDI channel of the MIDI track for which you've assigned the drum program.

If the track's **Status** is BTH, EXT, or EX2, note data etc. of the Drum Track pattern will be transmitted.

If local control ("Local Control On Global P1:1-1a) is on, playing the KROME's keyboard will not make the internal sound generator produce sound, nor can the keyboard trigger the arpeggiator or drum track. However, they can be triggered by note-on messages from MIDI IN.

7-7a: Drum Pattern

Pattern [Preset, User]

[(Preset): P000...605, (User): U000...U999]

This selects the drum pattern.

| Preset/User No. | Contents |
|-----------------|----------------------------------|
| P000 | Off |
| P000...605 | Preset drum patterns |
| U000...U999 | For user/preloaded drum patterns |

- U000–U999 can be store user patterns. Patterns you create in Sequencer mode can be converted into user drum patterns. (see p.188)

Shift [-24...+00...+24]

This transposes the drum pattern in semitone steps. This means that the instruments played by the pattern will change.

MIDI Channel

Input [01...16, Tch]

This specifies the MIDI channel that will trigger the drum pattern.

Tch: The MIDI channel that triggers the drum pattern will automatically be set to the MIDI channel (Seq 3-1(2)c) of the track chosen in **Track Select** (Seq 0-1(2)a).

If **Trigger Mode** is Wait KBD Trig, and you set **Track Select** to a track for which the MIDI channel you specify here is selected, the keyboard will trigger the drum pattern. MIDI IN messages of the matching MIDI channel will also trigger the drum track.

Output [01...16, Tch]

This specifies the MIDI channel that will transmit the MIDI data of the drum pattern. The drum pattern will sound using the program of the track that is assigned to this MIDI channel.

Tch: The MIDI channel output will automatically be set to match the MIDI channel (Seq 3-1(2)c) of the track selected by **Track Select** (Seq 0-1(2)a).

Whether the pattern data will be output to an external device will depend on the **Status** setting of the track that matches the **Output** MIDI channel.

7-7b: Trigger

Trigger Mode [Start Immediately, Wait KBD Trig]

Start Immediately: When you press the DRUM TRACK button to turn it on (LED lit), the drum pattern will start according to the **Sync** setting. When you press ON/OFF again, the drum pattern will stop.

Wait KBD Trig: When you press the DRUM TRACK button to turn it on (LED lit), the drum pattern will wait to start. If you set **Track Select** to a track that matches the MIDI Channel **Input** setting, and play the keyboard, or receive a

MIDI note-on on the same MIDI channel, the drum pattern will start according to the **Sync** setting.

 If you've selected **Start Immediately**, the DRUM TRACK button will always be saved in the OFF state.

Sync [Off, On]

Off: The drum pattern will not synchronize to the currently-running arpeggiator, but will start immediately.

On: The drum pattern will synchronize to the currently-running arpeggiator.

Note: Use P7-3(4)c: Arpeggiator-A(B) Setup **Key Sync** to specify whether arpeggiator will synchronize to the currently-running drum pattern.

Latch [Off, On]

This is valid if **Trigger Mode** is **Wait KBD Trig**.

Off: If the DRUM TRACK button is on (LED blinking), the pattern will start when you play the keyboard (note-on). The pattern will stop when you release the keyboard (note-off).

On: If the DRUM TRACK button is on (LED blinking), the pattern will start when you play the keyboard (note-on). The pattern will continue when you release the keyboard (note-off). The pattern will stop when you turn the DRUM TRACK button off (LED dark).

Zone:

Keyboard

Bottom [C-1...G9]

Top [C-1...G9]

This is valid if **Trigger Mode** is set to **Wait KBD Trig**.

It specifies the range of keys that will start the drum pattern.

Velocity:

Bottom [001...127]

Top [001...127]

This is valid if **Trigger Mode** is set to **Wait KBD Trig**.

It specifies the range of velocities that will start the drum pattern.

Note: You can also set the note and velocity values by holding down an edit cell or the ENTER button and playing a key (see OG p.10).

7-7: Menu Command

- 0: **Memory Status** see p. 163
- 1: **Exclusive Solo** see p. 64
- 2: **Rename Song** see p. 163
- 3: **Delete Song** see p. 163
- 4: **Copy From Song** see p. 163
- 5: **Load Template Song** see p. 163
- 6: **Save Template Song (Save as User Template Song)** see p. 164
- 7: **FF/REW Speed** see p. 164
- 8: **Set Location (Set Location for Locate Key)** see p. 164
- 9: **GM Initialize** see p. 165
- 10: **Copy From Combi (Copy from Combination)** see p. 166
- 11: **Copy from Program** see p. 101
- 12: **Copy Drum Track** see p. 65
- 13: **Erase Drum Track Pattern** see p. 66

For more information, please see "Sequencer: Menu Command" on page 163.

Synchronizing the Drum Track function

The Trigger “Sync” parameter

The trigger timing of a drum track will depend on the setting of its Trigger Sync parameter.

On (checked): The trigger timing will be quantized to the nearest beat relative to the base tempo.

Off (unchecked): If **Trigger Mode** is Start Immediately, triggering will occur at the moment you press the DRUM TRACK button. If this is set to Wait KBD Trig, triggering will occur at the moment you play the keyboard.

Synchronizing the drum track with the arpeggiator function, Sequencer mode songs, patterns, and RPPR performance

If you want the Drum Track pattern to play or be recorded in synchronization with the currently-operating arpeggiator function, currently-playing song, pattern, or RPPR performance, turn **Trigger Sync** on.

Trigger Sync Off: If the **Trigger Mode** setting is Start Immediately, the Drum Track pattern will be triggered the moment you press the DRUM TRACK button. If this is set to Wait KBD Trig, the Drum Track pattern will be triggered the moment you play the keyboard. It will not synchronize to the currently-operating arpeggiator function or to the currently-playing song, pattern, or RPPR.

Trigger Sync On: Triggering will synchronize to the currently-playing song, pattern or RPPR performance at the beginning of the next measure. Triggering will synchronize to the currently-operating arpeggiator (in Sequencer mode if the song or pattern is stopped) on the next beat.

Note: If you want to synchronize the arpeggiator to the currently-running Drum Track function, set the **Key Sync** parameter (Prog/Combi/Seq P7).

Note: If you want to synchronize the RPPR pattern performance to the currently-running Drum Track function, set the **Sync** parameter (Seq P10: Pattern/RPPR– RPPR Setup page) to Beat or Measure.

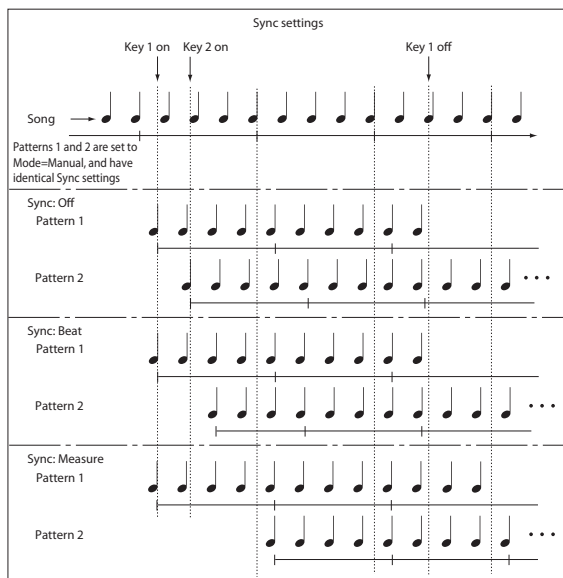

Synchronization with song stop

Synchronization with a song in Sequencer mode

- When you press the START/STOP (▶/■) button, the Drum Track function and the sequencer will stop.

- If you want the Drum Track function to start simultaneously with the beginning of recording, press the DRUM TRACK button during the pre-count before recording (if the **Trigger Mode** is set to Start Immediately) or play the keyboard (if **Trigger Mode** is Wait KBD Trig). The Drum Tracks will not be triggered immediately, but will be triggered in synchronization with the sequencer the moment recording starts.

Slave operation

The KROME's sequencer can be made to run in synchronization with the clock and realtime commands received from an external sequencer. Connect the MIDI OUT of your external MIDI device to the KROME's MIDI IN, or connect the KROME's USB port to your computer's USB port.

Connect the KROME's MIDI IN to your external MIDI device's MIDI OUT, or connect the KROME's USB connector to your computer's USB port.

Set **MIDI Clock** (Global, see p.199) to External MIDI or External USB. The KROME will synchronize to **MIDI Clock** and realtime command messages it receives from the connected MIDI device.

Note: If the KROME is set to **MIDI Clock= Auto**, it will also synchronize to the external MIDI device in the same way if MIDI realtime clock messages are being received from the external device.

Synchronization to MIDI clock

The arpeggiator will synchronize to the tempo coming from an external MIDI clock source.

Synchronization with MIDI realtime commands

In Sequencer mode, the KROME will respond to Song Start, Continue, and Stop messages that it receives just as it does when using the front panel START/STOP (▶/■) button to control song playback and recording. The arpeggiator also will be controlled in the same way. (See "Synchronization with song stop" above)

Master operation

The KROME sequencer's clock data and start/stop operations can be used to synchronize and control an external sequencer.

Connect the KROME's MIDI OUT to your external MIDI device's MIDI IN, or connect the KROME's USB connector to your computer's USB port.

Set **MIDI Clock** (Global 1–1a) to Internal. The connected external MIDI device will synchronize to the KROME's MIDI Clock.

Note: The same applies if **MIDI Clock=Auto** and MIDI Clock messages are being transmitted. For details, please see "MIDI Clock (MIDI Clock Source)" on page 199.

Synchronization via MIDI clock

The connected external MIDI device will synchronize to the MIDI clock of the KROME.

SEQ P8: Routing/IFX (Insert Effect)

You can also specify the bus routing for the program used by each MIDI track 1–16. For instance, you can:

- Send the output of a track to an insert effect
- Route a sound to an insert effect
- Make detailed settings for insert effects
- Make common LFO settings for effects

For details on Insert Effects, please see “Effect Guide” on page 235.

8–1: Routing1 T01–08, 8–2: Routing1 T09–16

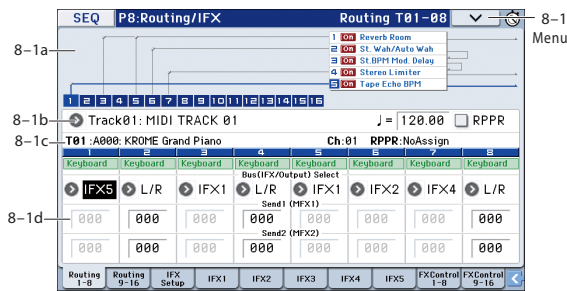

Specifies the bus to which the program oscillator(s) used by MIDI tracks 1–8 and 9–16 will be sent. You can also set the send levels to the master effects from this page.

8–1(2)a: Routing Map

This area shows the insert effect routing (**Bus Select**), the name of the assigned effect, the on/off status, chaining, and the output bus that follows the insert effect. The type of insert effect, the on/off status, and the chain settings can be edited in the 8–3: Insert FX Setup page.

8–1(2)b: Track Select, Tempo, RPPR

8–1(2)c: Track Info

For more information, please see “2–1: Trim T01–08, 2–2: Trim T09–16” on page 123.

8–1(2)d: Routing 1

Bus (IFX/Output) Select [DKit, L/R, IFX1...5, Off]

This specifies the output bus for the track program’s oscillator(s).

L/R: Output to the L/R bus.

IFX1, 2, 3, 4, 5: Output to the IFX1–5 buses.

Off: The track will not be output from the L/R bus, or IFX1–5 buses. Choose the Off setting if you want the program’s oscillator output of the track to be connected in series to a master effect. Use **Send1 (to MFX1)** and **Send2 (to MFX2)** to specify the send levels.

Tip: You can create a wide variety of routings by using each track’s **Bus (IFX/Output) Select** and the **Chain to** and **Chain** settings (Seq 8–3b) that follow the insert effect.

DKit: You can select this only if the specified program is a drum program (**Oscillator Mode** Drums or Double Drums).

The **Bus (IFX/Output) Select**, **FX Control Bus**, **Send1**, and **Send2** settings (Global 5–5b) for each key of the selected drum kit will be used. Check this setting if you want to apply an individual insert effect to each drum instrument.

Tip: In most preloaded drumkits, the drum instruments have the same **Bus (IFX/Output) Select** settings according to their type, as follows.

Snares → IFX1

Kicks → IFX2

Other → IFX3

If you want to edit these routings, use the **DrumKit IFX Patch** menu command. For more information, please see “DrumKit IFX Patch” on page 104.

Send1 (MFX1) [000...127]

Send2 (MFX2) [000...127]

For each track, these parameters set the send level to master effects 1 and 2. These settings are valid when **Bus (IFX/Output) Select** is set to L/R or Off. When IFX 1–5 are selected, the send levels to master effects 1 and 2 are set by the **Send1** and **Send2** parameters of the IFX page, and are applied after the sound has passed through IFX1–5.

The Send 1 and 2 setting you specify here are used during playback or recording from the beginning of the song. If you modify these settings during recording, your changes will be recorded as performance data; the send amounts will change accordingly during playback. You can also modify these settings during playback. However if Send 1 and 2 data has been recorded, the settings will change according to the recorded data.

MIDI If **Status** (Seq 3–1(2)c) is either INT or BTH, CC#93 and CC #91 can control send 1 and 2 respectively and change their settings. When you switch songs or return to the beginning of a song, tracks whose **Status** is EXT, EX2 or BTH will transmit these settings via MIDI. This data will be transmitted on the MIDI channel of each track as set by **MIDI Channel** (Seq 3–1(2)c). The actual send level is determined by multiplying the value of these parameters with the send level settings of the program used by the track (**Send1** and **Send2**, Prog 8–1d). (See Global P1: MIDI, SEQ Mode “Track MIDI Out” on page 200)

8–1(2): Menu Command

- 0: **Memory Status** see p. 163
- 1: **Exclusive Solo** see p. 64
- 2: **Copy Insert Effect** see p. 66
- 3: **Swap Insert Effect** see p. 67
- 4: **DrumKit IFX Patch** see p. 104
- 5: **FF/REW Speed** see p. 164
- 6: **Set Location (Set Location for Locate Key)** see p. 164
- 7: **Put Effect Setting to Track** see p. 184

For more information, please see “Sequencer: Menu Command” on page 163.

8-3: Insert FX Setup

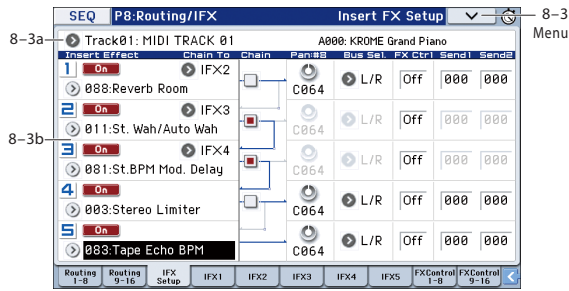

8-3a: Track Select

For more information, please see “2-1: Trim T01-08, 2-2: Trim T09-16” on page 123.

8-3b: Insert Effect

Here you can choose the type of each insert effect 1 through 5, its on/off status, chaining, and adjust the post-IFX mixer settings. For insert effects, the direct sound (Dry) is always stereo-in and out. The input/output configuration of the effect sound (Wet) depends on the effect type. For descriptions of the individual effects, please see “Effect Guide,” beginning on page 235.

The following parameters are the same as in Program mode. For more information, please see “8-2: Insert FX Setup” on page 592.

However, unlike in Program mode, insert effect dynamic modulation (Dmod) and the post-IFX **Pan: #8**, **Send 1**, and **Send 2** are controlled on the MIDI channel specified by **Ch** (Seq 8-4(5)(6)(7)(8)a). The control changes used are the same as in Program mode.

The pan (CC#8), send 1 and 2 settings you make here will be used when the song is played or recorded from the beginning. If you change the settings while recording a MIDI track, the changes will be recorded as part of the musical data, and the settings will change when the data is played back. You can also change these settings during playback. However if pan (CC#8), send 1, or 2 data has been recorded, the settings will change accordingly.

MIDI If **Status** (Seq 3-1(2)c) is either INT or BTH, CC#8, CC#93, and CC#91 can be received to control the pan following the insert effect, send 1, or send 2 respectively, and change their settings. When you switch songs or return to the beginning of the song, tracks whose **Status** is BTH, EXT, or EX2 will transmit these settings via MIDI. This data will be transmitted on the MIDI channels specified in the IFX 1-5 pages (Seq 8-4(5)(6)(7)(8)a). (See Global P1: MIDI, SEQ Mode “Track MIDI Out” on page 200)

Insert Effect:

IFX1...4 [000...193]
IFX5 [000...171]
IFX1...5: IFX On/Off [Off, On]

Chain:

IFX1: Chain to [IFX2...IFX5]
IFX2: Chain to [IFX3...IFX5]
IFX3: Chain to [IFX4...IFX5]

IFX1: Chain [Off, On]
IFX2: Chain [Off, On]
IFX3: Chain [Off, On]
IFX4: Chain [Off, On]

Pan:#8:

Pan: #8 (Post IFX PanCC#8) [L000...C064...R127]

Bus:

Bus (Bus Select) [Off, L/R]
Ctrl (FX Control Bus) [Off, 1, 2]

Send1/2:

Send1 [000...127]
Send2 [000...127]

For more information, please see “8-2: Insert FX Setup” on page 59.

✓ 8-3: Menu Command

- 0: **Memory Status** see p. 163
- 1: **Exclusive Solo** see p. 64
- 2: **Copy Insert Effect** see p. 66
- 3: **Swap Insert Effect** see p. 67
- 4: **FF/REW Speed** see p. 164
- 5: **Set Location (Set Location for Locate Key)** see p. 164
- 6: **Put Effect Setting to Track** see p. 184

For more information, please see “Sequencer: Menu Command” on page 163.

8-4: IFX1

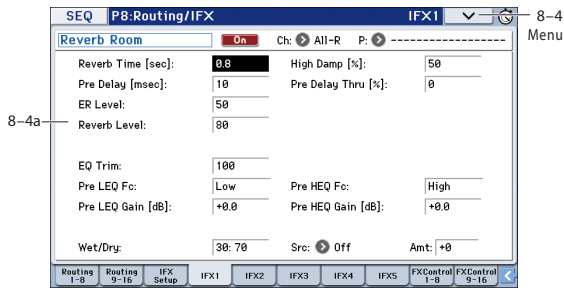

Here, you can edit the parameters of the insert effect 1 you selected in the P8: Routing/IFX– Insert FX Setup page.

8-4a: Insert Effect 1 (IFX1)

IFX On/Off [Off, On]

Turns the insert effect on/off. This is linked with the On/Off setting in the P8: Routing/IFX– Insert FX Setup page.

Ch (Control Channel) [Ch01...16, All-R]

This specifies the MIDI channel that will control dynamic modulation (Dmod) for the insert effect.

Ch01...Ch16: The insert effect will be controlled on the specified MIDI channel.

All-R: The channel of any track routed through this effect can be used to control the effect. (Channels of each routed track will be indicated by “*”).

Drum Kits and the MIDI Control Channel

If a Track is using a Drum Kit, and the Track’s **Bus (IFX/Output) Select** (Seq 8-1(2)d) is **DKit**, this affects the MIDI Control Channel as well. In this case, the Track’s MIDI channel will be used to control any effect whose **Ch** is set to All-R, regardless of the **Bus (IFX/Output) Select** (Global 5-5b) settings or the settings of the **DrumKit IFX Patch** menu command.

P (Effect Preset) [P00, P01...15, U00...15, -----]

Effect Presets let you easily store and recall all of the settings for an individual effect. You can store up to 16 user presets for each effect type, in addition to 15 re-writable factory presets.

The same presets appear in all of the modes (Program, Combination, Sequencer).

Note that edits to effects parameters are automatically stored with the Song—you don’t need to store them as an Effect Preset. Presets just make it easier to re-use your favorite settings.

For instance, you can save an Effect Preset while working on a particular Song, and then later use the same Effect Preset in a different Program, Combination, or Song.

P00: Initial Set: These are the default settings that are recalled when you select an effect type in the Insert FX Setup page. You can’t save your own settings here.

P01...P15: Preset data is saved in this area. We recommend that you store your settings in U00–U15.

U00...U15: These are areas in which you can store your own settings.

-----: This shows that no Effect Preset has been selected. You’ll see this if you’ve just selected an effect or selected a new Song. Selecting this setting from the menu will not have any effect.

Note: Songs save the effects parameter settings, but they don’t save the number of the selected Effect Preset. If you select an Effect Preset, save the Song to media, and then reload the Song, the Effect Preset setting will revert to “-----”.

For more information, please see “Using Effect Presets” on page 60.

IFX1 Parameters:

IFX Parameters

Here, you can set the effect parameters of the insert effect you chose in the P8-3: Insert FX Setup page.

For more information, please see “Insert Effects (IFX1–IFX5)” on page 240.

8-4: Menu Command

- 0: **Memory Status** see p. 163
- 1: **Exclusive Solo** see p. 64
- 2: **Copy Insert Effect** see p. 66
- 3: **Swap Insert Effect** see p. 67
- 4: **Write FX Preset** see p. 184
- 5: **FF/REW Speed** see p. 164
- 6: **Set Location (Set Location for Locate Key)** see p. 164
- 7: **Put Effect Setting to Track** see p. 184

For more information, please see “Sequencer: Menu Command” on page 163.

8-5: IFX2, 8-6: IFX3, 8-7: IFX4, 8-8: IFX5

Here, you can edit the effect parameters for insert effects 2-5 selected in the Insert FX Setup page.

For more information, please see “8-4: IFX1” above.

8-9: FX Control T01-08, 8-10: FX Control T09-16

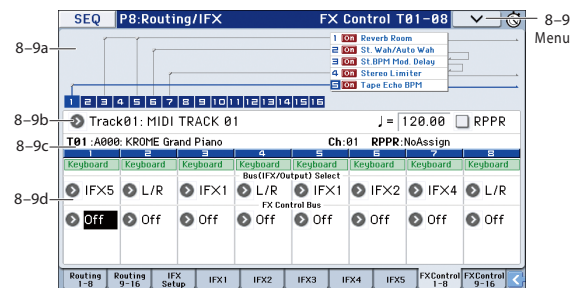

Here, you can specify the buses, and effect control bus, for the outputs of tracks 1-8 and 9-16.

8-9(10)a: Routing Map

8-9(10)b: Track Select, Tempo, RPPR

8-9(10)c: Track Info

For more information, please see “8-1(2)a: Routing Map” on page 148 and “2-1: Trim T01-08, 2-2: Trim T09-16” on page 123.

8-9(10)d: Routing2

Bus (IFX/Output) Select [L/R, IFX1...5, Off]

This specifies the output bus for the oscillator(s). This is the same parameter as in the 8-1: IFX-Routing 1 T01-08 and T09-16 pages.

For more information, please see "Bus (IFX/Output) Select" on page 148.

FX Control Bus [Off, 1, 2]

Sends the output of the track to an FX Control bus (two-channel mono FX Ctrl 1 or 2).

Use the FX Control buses when you want a separate sound to control the audio input of an effect. You can use two FX Control buses (each is a two-channel mono bus) to control effects in various ways.

For more information, please see "FX Control Buses" on page 238.

✓ 8-9(10): Menu Command

- 0: **Memory Status** see p. 163
- 1: **Exclusive Solo** see p. 64
- 2: **Copy Insert Effect** see p. 66
- 3: **Swap Insert Effect** see p. 67
- 4: **DrumKit IFX Patch** see p. 104
- 5: **FF/REW Speed** see p. 164
- 6: **Set Location (Set Location for Locate Key)** see p. 164
- 7: **Put Effect Setting to Track** see p. 184

For more information, please see "Sequencer: Menu Command" on page 163.

SEQ P9: MFX/TFX/LFO (Master/Total Effect/LFO)

Here, you can adjust the settings for the master effects and the total effect. For instance, you can:

- Route a sound to the master effects and the total effect
- Make detailed settings for the master effects and the total effect

For more information, please see “Effect Guide” on page 235.

9–1: Routing

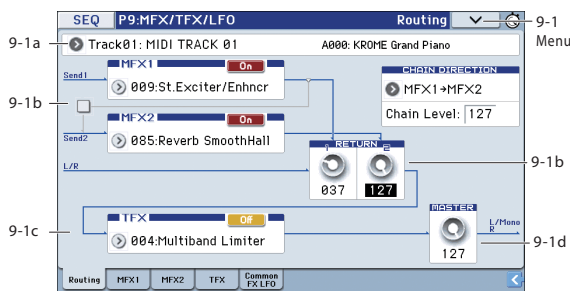

- Here, you can specify the type of master effects and total effect, and turn them On/Off.
- The master effects are sent to the L/R bus. The total effect is inserted into the L/R bus.

These parameters are the same as in Program mode.

For more information, please see “9–1: Routing” on page 61.

9–1a: Track Select

For more information, please see “2–1: Trim T01–08, 2–2: Trim T09–16” on page 123.

9–1b: MFX1, 2

MFX1:

| | |
|--------------------|-------------|
| MFX1 | [000...193] |
| MFX1 On/Off | [Off, On] |
| Return 1 | [000...127] |

MFX2:

| | |
|--------------------|-------------|
| MFX2 | [000...171] |
| MFX2 On/Off | [Off, On] |
| Return 2 | [000...127] |

Chain:

| | |
|------------------------|------------------------|
| Chain On/Off | [Off, On] |
| Chain Direction | [MFX1→MFX2, MFX2→MFX1] |
| Chain Level | [000...127] |

For more information, please see “9–2: MFX1” on page 62.

9–1c: TFX

TFX:

| | |
|-------------------|-------------|
| TFX | [000...171] |
| TFX On/Off | [Off, On] |

For more information, please see “PROG P9: MFX/TFX/LFO (Master/Total Effect/LFO)” on page 61.

9–1d: Master Volume

| | |
|----------------------|-------------|
| Master Volume | [000...127] |
|----------------------|-------------|

For more information, please see “9–1c: Master Volume” on page 62.

9–1: Menu Command

- 0: **Memory Status** see p. 163
- 1: **Exclusive Solo** see p. 64
- 2: **Copy Insert Effect** see p. 66
- 3: **Swap Insert Effect** see p. 67
- 4: **FF/REW Speed** see p. 164
- 5: **Set Location (Set Location for Locate Key)** see p. 164
- 6: **Put Effect Setting to Track** see p. 184

For more information, please see “Sequencer: Menu Command” on page 163.

9-2: MFX1

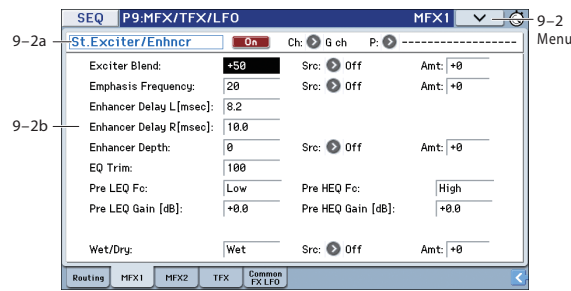

Here, you can edit the parameters of the effect you selected for MFX1 in the P9: MFX/TFX/LFO– MFX1 page.

9-2a: MFX1

MFX1 On/Off [Off, On]

This turns master effect 1 on/off. This is linked with the on/off setting in the P9: MFX/TFX/LFO– Routing page.

Ch (Control Channel) [Ch01...16, G ch]

Specifies the MIDI channel that will control dynamic modulation (Dmod) for the master effect.

Ch01...Ch16: The specified MIDI channel will be used for control.

G ch: The global **MIDI Channel** (Global 1-1a) will be used for control. Normally you will use the G ch setting.

P (Effect Preset)

[P00, P01...15, U00...15, -----]

Effect Presets let you easily store and recall all of the settings for an individual effect. You can store up to 16 user presets for each effect type, in addition to 15 re-writable factory presets.

The same presets appear in all of the modes (Program, Combination, Sequence).

Note that edits to effects parameters are automatically stored with the Combination—you don't need to store them as an Effect Preset. Presets just make it easier to re-use your favorite settings.

For instance, you can save an Effect Preset while working on a particular Combination, and then later use the same Effect Preset in a different Program, Combination, or Song.

P00: Initial Set: These are the default settings that are recalled when you select an effect type in the P9: MFX/TFX/LFO– Routing page. You can't save your own settings here.

P01...P15: Preset data is saved in this area. We recommend that you store your settings in U00–U15.

U00...U15: These are areas in which you can store your own settings.

-----: This shows that no Effect Preset has been selected. You'll see this if you've just selected an effect or selected a new Song. Selecting this setting from the menu will not have any effect.

For more details, please see "Using Effect Presets" on page 60.

MFX1 Parameters

Here, you can set the effect parameters of the effect you chose in the P9: MFX/TFX/LFO– Routing page.

For details on the individual effects, please see the "Effect Guide" on page 235.

▼ 9-2: Menu Command

- 0: **Memory Status** see p. 163
- 1: **Exclusive Solo** see p. 64
- 2: **Copy Insert Effect** see p. 66
- 3: **Swap Insert Effect** see p. 67
- 4: **Write FX Preset** see p. 184
- 5: **FF/REW Speed** see p. 164
- 6: **Set Location (Set Location for Locate Key)** see p. 164
- 7: **Put Effect Setting to Track** see p. 184

For more information, please see "Sequencer: Menu Command" on page 163.

9-3: MFX2, 9-4: TFX

These pages let you edit the parameters of Master Effect 2 and the Total Effect. To select different effects types, use the P9: MFX/TFX/LFO– Routing page.

The parameters of MFX2, TFX are the same as for MFX1. For more information, please see "9-2: MFX1" above.

9–5: Common FX LFO



The two Common FX LFO 1, 2 allow you to synchronize LFO-based modulation for multiple effects, such as phasers, flangers, filters, and so on.

The Common LFOs control only the frequency, MIDI synchronization, and reset options; each individual effect still has its own settings for the LFO waveform and phase.

Within the individual effects, you can choose whether to use one of the Common LFOs, or to use the individual effect's frequency, sync, and/or reset settings instead. This is done via the effect's **LFO Type** parameter; select **Individual** to use the effect's settings, or **Common 1** or **2** to use the Common LFOs.

9–5a: Common FX LFO1

Ctrl Ch (Control Channel) [Ch01...Ch16, Gch]

Specifies the MIDI channel that will control dynamic modulation (Dmod) for Common LFO 1 and 2.

Gch: The global MIDI channel (Global 1–1a) will be used for control. This is the default setting.

Sync (Reset) [Off, On]

Source (Dmod Source) [List of Dmod Sources]

Frequency [0.02...20.00 (Hz)]

MIDI/Tempo Sync [Off, On]

BPM [MIDI, 40.00...300.00]

Base Note [MIDI, 3, 4, 5, 6, 7, 8, 9, 10, 11, 12, 13, 14, 15, 16, 17, 18, 19, 20, 21, 22, 23, 24, 25, 26, 27, 28, 29, 30, 31, 32]

Times [01...32]

These parameters are the same as in Program mode.

For more information, please see "9–5a: Common FX LFO1" on page 63.

9–5b: Common FX LFO2

These parameters are the same as for Common FX LFO1. For more information, please see "9–5a: Common FX LFO1" above.

9–5: Menu Command

- 0: **Memory Status** see p. 163
- 1: **Exclusive Solo** see p. 64
- 2: **Copy Insert Effect** see p. 66
- 3: **Swap Insert Effect** see p. 67
- 4: **FF/REW Speed** see p. 164
- 5: **Set Location (Set Location for Locate Key)** see p. 164
- 6: **Put Effect Setting to Track** see p. 184

For more information, please see "Sequencer: Menu Command" on page 163.

SEQ P10: Pattern/RPPR

Here, you can record and edit patterns, assign patterns to tracks of a song, and make RPPR (Realtime Pattern Play/Recording) settings. You can also convert drum track patterns for use in Program, or other modes.

- You can use preset patterns, and user patterns. Preset patterns provide patterns that are suitable for drum tracks; you can select these patterns from any song. There are one hundred user patterns for each song; you can create and store your own patterns as desired.
- You can create the desired performance data for a track by using the menu commands **Put To Track** or **Copy To Track** to place or copy patterns into a track. For more information, please see “Put To Track” on page 187.
- The RPPR function lets you assign patterns to different keys and then trigger these patterns by pressing notes on the keyboard and record the result onto the track in realtime. For more information, please see “10-3: RPPR Setup” on page 157.
- You can create user drum track patterns. User patterns in Sequencer mode can be converted using the menu command **Convert to Drum Trk Pattern**. For more information, please see “Convert to Drum Trk Pattern” on page 188.

Note: User patterns in Sequencer mode are not saved internally; you must save them on an SD card, and load them each time after powering-on. If you convert user patterns to user drum track patterns, they will be preserved in internal memory even when the power is turned off, meaning that you can manage them along with programs and combinations.

10-1: Pattern Edit

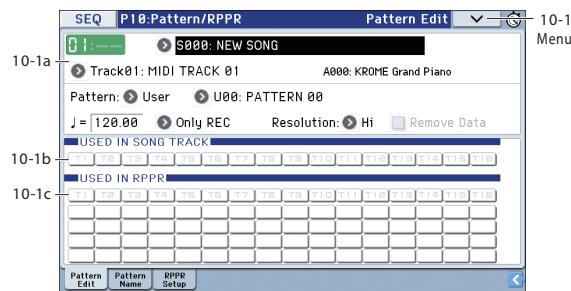

Here, you can record and edit patterns, and assign them to tracks of a song. The following types of pattern operations are available.

- User patterns can be recorded in real-time (as well as recorded from performances generated by the arpeggiator), step-recorded, or created using the Get From MIDI Track command or Copy Pattern command. You can also copy a preset pattern to a user pattern and edit it. (You can't directly edit a preset pattern.)
- Preset patterns and user patterns can be placed in or copied into a track.
- You can convert user patterns to drum track patterns.

10-1a: Location, Song Select, Track Select

Location [01...99]

Displays the current measure location of the selected pattern.

Song Select [000...127: name]

Selects a song.

The user pattern will be created in the song you select.

Track Select [Track01...16, Master Track]

Selects the track that will be used to record/play the pattern data. The pattern data will be recorded/played using the settings of the track you select. The area at the right displays the program bank, number, and name for the selected track.

Settings of the Master Track will be ignored. The most recently selected Track 01-16 will be used.

10-1b: Pattern (Pattern Bank), Pattern Select, Tempo, Metronome, Reso, Remove Data

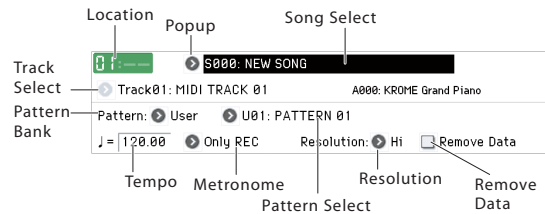

How to record a user pattern

1. Use **Song Select** to select the song in which you want to create a user pattern.
2. Use **Track Select** to choose the sound that you will record.
3. Use **Pattern Bank** and **Pattern Select** to select the User pattern and the desired pattern number.
4. Select the menu command **Pattern Parameter**, and in the dialog box, specify the number of measures and the time signature of the pattern.
5. Check the tempo in “J”.
6. If you want to record in realtime, set **Reso** to specify the resolution, and press the **REC** (●) button and then the **START/STOP** (▶/■) button to begin recording.

When you finish recording to the end of the measures specified by the **Pattern Parameter**, you will return to the first measure, and can continue recording while adding more material. For more information, please see “Loop All Tracks” on page 117.

If you want to perform step recording, select the menu command **Step Recording (Loop Type)** to open the dialog box, and record. For more information on step recording procedure, please see “Step Recording” on page 167 and “Step Recording (Loop Type)” on page 186.

7. After recording, use the menu commands as desired to edit the pattern or the events in the pattern.

Control data in pattern recording

 To record control data in a pattern, you should restore the control data to its normal value within the pattern. If you fail to restore the normal value, unnecessary control data may remain in a “stuck” position when you place the pattern in a song or use the RPPR function to play the pattern. However, the following control data will be automatically reset to the following values when the song or RPPR function finishes playing the pattern, or when playback is halted.

| Controller | Reset value |
|--------------------------------|-------------|
| Modulation 1 (CC#01) | 00 (zero) |
| Modulation 2 (CC#02) | 00 (zero) |
| Expression (CC#11) | 127 (max) |
| Ribbon controller (CC#16) | 64 (center) |
| Damper switch (CC#64) | 00 (zero) |
| Sostenuto switch (CC#66) | 00 (zero) |
| Soft switch (CC#67) | 00 (zero) |
| EG sustain level (CC#70) | 64 (center) |
| Resonance level (CC#71) | 64 (center) |
| EG release time (CC#72) | 64 (center) |
| EG attack time (CC#73) | 64 (center) |
| Low pass filter cutoff (CC#74) | 64 (center) |
| EG decay time (CC#75) | 64 (center) |
| LFO1 speed (CC#76) | 64 (center) |
| LFO1 depth (pitch) (CC#77) | 64 (center) |
| LFO1 delay (CC#78) | 64 (center) |
| Filter EG intensity (CC#79) | 64 (center) |
| SW1 modulation (CC#80) | 00 (zero) |
| SW2 modulation (CC#81) | 00 (zero) |
| Channel aftertouch | 00 (zero) |
| Pitch bender | 00 (zero) |

Pattern (Pattern Bank) [Preset, User]

Selects the type of pattern.

If Preset is selected, it will not be possible to record. You will be able to select and execute the **Copy Pattern**, **Bounce Pattern**, **Put To Track**, and **Copy To Track** menu commands.

Pattern Select [P000...605, U00...U99]

Selects a pattern.

User patterns can be renamed in the P10: Pattern/RPPR–Pattern Name page.

♩ (Tempo) [040.00...300.00, EXT]

Specifies the playback tempo of the pattern. For more information, please see “♩ (Tempo)” on page 110.

Metronome [Only REC, REC & Play, Off]

Specifies whether the metronome will sound during recording or playback. For more information, please see “0–8c: Metronome Setup” on page 119.

Reso (Realtime REC Quantize Resolution) [Hi, ... ♩]

Specifies how the timing of the data being recorded into the pattern will be corrected. For more information, please see “Resolution (Realtime REC Quantize Resolution)” on page 111.

Remove Data [Off, On]

On (checked): Unwanted performance data can be removed during pattern recording. The procedure is the same as explained in **Remove Data** of Loop All Tracks. For more information, please see “Remove Data” on page 118.

10–1c: USED IN SONG TRACK, USED IN RPPR

USED IN SONG TRACK

This area indicates the pattern usage status for the patterns selected for the track.

USED IN RPPR

This area indicates the RPPR in which the selected pattern is used. The assigned key and the specified track are shown.

✓ 10–1: Menu Command

- 0: **Memory Status** see p. 163
- 1: **Exclusive Solo** see p. 64
- 2: **Step Recording (Loop Type)** see p. 186
- 3: **Event Edit** see p. 169
- 4: **Piano Roll** see p. 186
- 5: **Pattern Parameter** see p. 186
- 6: **Erase Pattern** see p. 186
- 7: **Copy Pattern** see p. 186
- 8: **Bounce Pattern** see p. 187
- 10: **Put To Track** see p. 187
- 11: **Copy To Track** see p. 188
- 12: **Convert to Drum Trk Pattern** see p. 188
- 13: **Load Drum Track Pattern** see p. 188
- 14: **Erase Drum Track Pattern** see p. 189
- 15: **FF/REW Speed** see p. 164

For more information, please see “Sequencer: Menu Command” on page 163.

10-2: Pattern Name

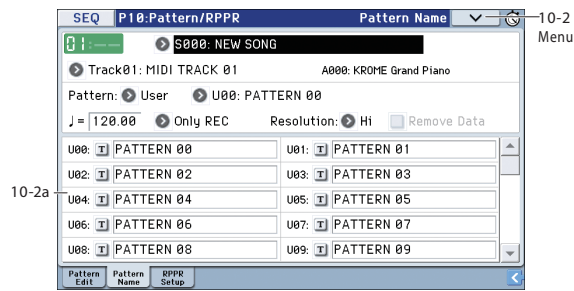

10-2a: Location, Song Select, Track Select

10-2b: Pattern, Pattern Select, Tempo, Metronome, Reso, Remove Data

For more information, please see “10-1a: Location, Song Select, Track Select, Track Select” on page 155 and “10-1b: Pattern (Pattern Bank), Pattern Select, Tempo, Metronome, Reso, Remove Data” on page 155.

10-2c: User Pattern Names

Pattern name [U00...U99]

Here, you can rename the pattern. Press the text edit button to open the dialog box, and input the name. You can enter up to 24 characters. See “Editing names” on page 117 of the Operation guide.

✓ 10-2: Menu Command

- 0: Memory Status see p. 163
- 1: Exclusive Solo see p. 64
- 2: Step Recording (Loop Type) see p. 186
- 3: Event Edit see p. 169
- 4: Piano Roll see p. 186
- 5: Pattern Parameter see p. 186
- 6: Erase Pattern see p. 186
- 7: Copy Pattern see p. 186
- 8: Bounce Pattern see p. 187
- 9: Get From Track see p. 187
- 10: Put To Track see p. 187
- 11: Copy To Track see p. 188
- 12: Convert to Drum Trk Pattern see p. 188
- 13: Load Drum Track Pattern see p. 188
- 14: Erase Drum Track Pattern see p. 189
- 15: FF/REW Speed see p. 164

For more information, please see “Sequencer: Menu Command” on page 163.

10-3: RPPR Setup

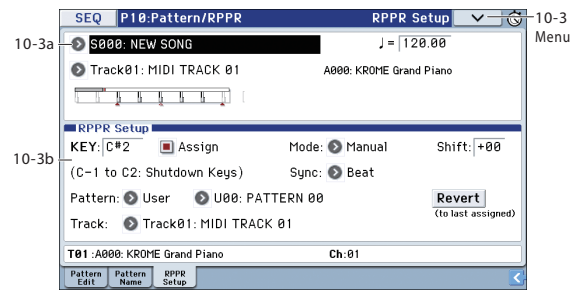

Here, you can adjust the settings for the RPPR (Realtime Pattern Play/Recording) function. RPPR lets you assign patterns to individual keys, and then play back patterns simply by pressing individual notes on the keyboard. This performance can be recorded in real-time.

For each song, you can assign either a preset pattern or a user pattern to each of the 72 keys in the range C#2–C8. For each key, you can specify the pattern, track number, and how the pattern will be played.

 Keys used to play patterns via RPPR cannot be used for the arpeggiator. If RPPR is on, keys to which a pattern is not assigned will play the program of the track that's selected in **Track Select**. In this case, the arpeggiator will operate if Arpeggiator A, or B is active, and assigned to the track. Notes generated by the arpeggiator will not trigger the RPPR function.

 When Local Control is OFF (**Local Control On** Global 1-1a), the keyboard will not trigger RPPR pattern playback, except via notes received at the MIDI IN that match the currently selected track's channel. If you have recorded only the trigger notes on an external sequencer and wish to use the playback from the external sequencer to trigger RPPR patterns on KROME, set Local Control OFF.

If you want the note data generated by RPPR to be recorded by the external sequencer, set Local Control ON, and turn off the echo back function of the external sequencer. See “Local Control On settings” on page 359.

 In the RPPR Setup page, RPPR is turned on automatically. This will be the same result as when the RPPR check box (Seq 0-1(2)a) in each page is checked.

10-3a: Song Select, Track Select, Tempo

Song Select [000...127: name]

Selects the desired song. The RPPR settings will be assigned to the song you select here.

J (Tempo) [040.00...300.00, EXT]

Specifies the playback tempo of the patterns. (Seq 0-1(2)a)

Track Select [Track01...16, Master Track]

When you play a key that is not assigned to RPPR, it will sound using the settings of the track that's selected in **Track Select**. Use this to select the track that you want to play together with RPPR, or to audition a pattern before you assign it. The program bank, number, and name of the selected track is shown at the right.

Each RPPR pattern will begin playing when you press the assigned key, regardless of the **Track Select** setting. It will sound using the settings of the track selected in **Track Name**.

 The Master Track setting is ignored. The last-selected Track 01-16 will be used.

Keyboard & Assigned Graphics

This shows the selected key, and the keys to which a pattern has been assigned by the RPPR function. See diagram below.

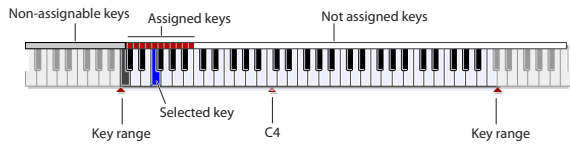

10-3b: RPPR Setup

KEY (Key Select) [C#2...C8]

Specifies the key to which you want to assign an RPPR pattern.

The following parameters will apply to the key that you select here.

Note: You can also set the note and velocity values by holding down an edit cell or the ENTER button and playing a key (see OG p.10).

Assign [Off, On]

On (checked): When you play the key specified by **KEY**, the pattern selected in **Pattern** will be triggered.

Off (unchecked): That key will sound the currently selected track at the corresponding pitch, just as in normal Sequencer mode.

Mode [Once, Manual, Endless]

Specifies the way in which the pattern assigned to the specified **KEY** will be played.

Once: When you press the key, the complete pattern will play once to the end and then stop.

Manual: The pattern will continue repeating as long as you continue holding the key, and will stop as soon as you release the key.

Endless: The pattern will continue repeating even after you release the key. To stop the pattern playback, press any note below C2, or press the same key once again.

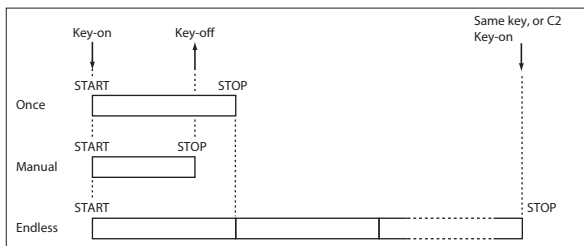

Shift [-12...+12]

Adjusts the playback pitch of the pattern for the specified **KEY** in semitone steps over a range of ± 1 octave.

With a setting of 0, the pattern will be played at its original pitch.

Sync [Off, Beat, Measure, SEQ]

Specifies the way in which the pattern playback will be synchronized when you press the specified **KEY**.

Off: The pattern will begin playing at the moment you press the note.

Beat: The pattern will synchronize to the beat of the other patterns that are already in play. This setting is suitable when you wish to play phrase patterns in unison.

Measure: The pattern will synchronize to the measures of the pattern that was started by the first key. This setting is suitable for rhythm, bass or drum patterns.

SEQ: The pattern will synchronize to the measures of the sequencer song.

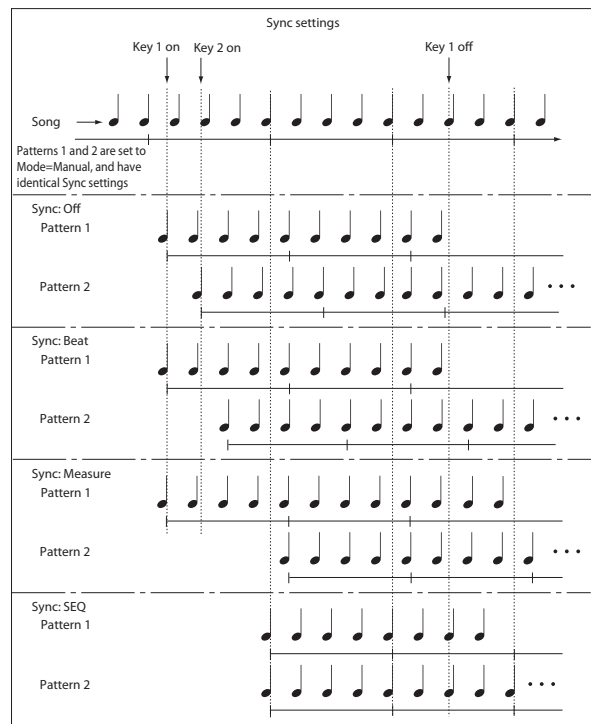

- When Beat or Measure are selected, pattern playback will begin when you press the first key. The second and subsequent patterns that are triggered from the keyboard will synchronize to the pattern that was started by the first key; with a setting of Beat they will synchronize in steps of a beat, and with a setting of Measure they will synchronize in steps of a measure.
- When SEQ is selected, the pattern will play back in synchronization with the measures of the sequencer song. The pattern will synchronize with the currently-playing song, so you must start the song before you play notes on the keyboard.
- Beat, Measure, and SEQ will cause the pattern to start immediately if you play the key within a thirty-second note of the timing of the respective beat or measure, but if you play the key later than this, the start of the pattern will be delayed by a beat.
- Set this to SEQ if you want pattern playback by RPPR to be synchronized to the currently-running arpeggiator.

Note: If you want the arpeggiator performance to synchronize to the currently-running RPPR playback, turn Off the arpeggiator's **Key Sync**. The arpeggiator will synchronize to the beat based on the RPPR playback timing.

Note: If you want the drum track pattern performance to synchronize to the currently-running RPPR playback, turn On the drum track function's **Sync** (in each mode, the Drum Track page Trigger). The drum track will be triggered at intervals of one measure at the RPPR playback timing.

Stopping RPPR pattern playback

You can stop all currently-running RPPR pattern playback by pressing C2 or any lower key.

Pattern playback will stop immediately for keys whose **Sync** parameter is set to Off, but pattern playback for other keys will stop at the beginning of the beat or measure. You can immediately stop pattern playback for keys whose **Sync** is On by pressing C2 or a lower key twice in rapid succession.

Pattern Bank [Preset, User]**Pattern** [P000...605, U00...99]

Selects the RPPR pattern for the key selected in **KEY**. If the selected user pattern contains no musical data, there will be no sound when you press that key.

Track [Track 01...16]

Selects the track that will be used for the RPPR pattern selected for the **KEY**. When you play the key, the pattern will be played according to the settings of the track you select here. You can make track settings in the P0: Play/REC-P5: MIDI Filter pages.

When you record in real time with the RPPN function turned on, the data will be recorded on the track you select here. For more information, please see "Recording an RPPR performance".

Information shows the bank, name, and number of the program that's selected for **Track**.

Information

This area shows the bank, name, and number of the program that's selected for the track.

Revert

When you press this button, the **Pattern (Pattern Bank)**, **Pattern Select**, and **Track** settings of the last-edited **KEY** for which **Assign** was **checked** will be copied to these parameters of the currently selected **KEY**.

✓ 10-3: Menu Command

- 0: **Memory Status** see p. 163
- 1: **Exclusive Solo** see p. 64

For more information, please see "Sequencer: Menu Command" on page 163.

SEQ P11: Cue List

The cue list allows playback of multiple songs in succession. You can specify a number of repetitions for each song.

The KROME allows you to create twenty cue lists. A single cue list can hold up to 99 songs.

Each unit in a cue list is called a “step,” and you can specify a song number and a repeat (number of repetitions) for each step.

For example you could create each part of a song (intro, melody A, melody B, break, solo backing, ending etc.) as an individual song, and use a cue list to play the intro twice, melody A four times, melody B four times, the break twice, melody A four times ... etc. to produce the entire song. In cases when you wish to change the structure of the song, this Cue List function can help you work more efficiently.

The menu command **Convert to Song** lets you transform the songs in a cue list into a single song.

For example, you can use a cue list to create the backing, convert the cue list to a song, and then add solo phrases on unused tracks.

Tempo Mode

[Auto, Manu]

Auto: Playback will follow the tempo specified by each song in the cue list. It will not be possible to change the ♩ (Tempo) setting during playback.

Manu (Manual): Tempo specified in the song will be ignored, and playback will use the tempo specified above for ♩ (Tempo).

Cue List Select

[C00...C19: name]

Selects the cue list that you wish to play.

When using a cue list to play songs, you must first load the necessary data into internal memory, either from media, or by a MIDI data dump from an external sequencer.

MIDI Selecting a cue list in this page will cause a Song Select message (corresponding to the cue list number) and Song Position Pointer message to be transmitted. When a Song Select message is received from the specified source, the cue list will be switched.

Track Select

[Track01...Track16: name]

Selects the track that you wish to play manually from the keyboard along with the playback of the cue list.

While a cue list is playing, you can play along using the track settings and musical data of the song selected by the current Step (Seq 11-1b).

The track selected here can be specified independently for each song in the cue list.

When you are playing back different songs in succession, and want to play along using the same program on the keyboard, set **Track Select** (Seq 0-1(2)a) to the same track and program for each step.

At the right you can view the program bank, program number, and name of the program selected for **Track Select**.

11-1: Cue List



11-1a: Location, Meter, ♩, Tempo Mode, Cue List Select, Track Select

Location [0001:01.000...9999:16.191]

This displays the current location within the selected cue list.

From the left, the numbers indicate the measure, beat, and clock. Each can be set separately, and this will change the current location within the cue list.

The range of the beat and clock will depend on the time signature of the corresponding song.

MIDI When MIDI Clock (Global 1-1a) is **Internal**, a Song Position Pointer message will be transmitted each time you change the location within the cue list. If MIDI Clock is set to **External MIDI** or **External USB**, Song Position Pointer messages from the specified source will cause the location to change.

Meter (Time Signature) [1/4...16/16]

This displays the time signature of the currently-playing song.

♩ (Tempo) [040.00...300.00]

Specifies the tempo at which the song in the cue list will be played). For more information, please see “♩ (Tempo)” on page 110.

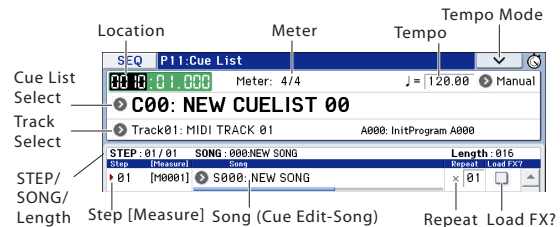

11-1b: Cue List

Selected Step Information

This shows information on the currently selected or playing Step.

Step [01...99/01...99]

The selected step number is shown at the left, and the total number of steps (not including the last step) is shown at the right.

Song [000...127]

This shows the number and name of the song for the currently selected step.

Length [000...999]

This shows the number of measures in the song for the currently selected step.

Step, Song, Repeat, Load FX?

Step [Measure] [01...100 (M0001...M9999)]

This displays the step number and its starting measure.

Step indicates each step number. The **Step** indicated by the symbol is the currently-selected or currently-playing step. This can be directly selected by **Song** (Seq 11-1b) or **Current Step** (Seq 11-1c). When stopped, pressing the START/STOP (▶/■) button will cause playback to begin from this step.

Measure indicates the starting measure of each step. This cannot be edited.

Song (Cue Edit-Song)

[S000...S127: name/End, Continue to Step01]

S000...S127: Specifies a song for each step. This cannot be edited during playback.

End and **Continue to Step01** can be specified only for the last step of the cue list.

End: Playback will stop at the last step of the cue list.

Continue to Step01: At the last step of the cue list, playback will return to **Step 01** and the cue list will continue playing endlessly. To stop, press the START/STOP (▶/■) button.

The song position bar at the bottom indicates the location of the current measure within the song of this step.

Repeat [01...64, FS]

Specifies the number of times that the song of this step will be repeated.

FS: A foot switch connected to the rear panel can be used to specify the point at which the song will stop repeating. When you press the foot switch, the current repetition of the song will finish playing. Playback will then advance to the next step. Set **Foot Switch Assign** (Global 2-1a) to **Cue Repeat Control**.

Load FX? (Cue Edit-Load Fx) [Off, On]

Specifies whether the effects specified by the song assigned to each step will be used.

On (checked): The effect settings of the song specified for the current step will be used. When playback moves to the next step, the effect settings will also change.

Off (unchecked): The effect settings will not change.



Depending on the effect settings, a certain amount of time may be required to switch effects. In this case, playback will not be smooth from song to song.

If you want to transition smoothly from song to song inside of a cue list, check **Load FX?** in **Step 01**. For the remaining steps, do not check **Load FX?**

With these settings, the effects will be set before playback begins, so there will be no time lag to interrupt the smooth transition between songs.

Although it is not possible to change the effect types in the middle of a cue list, you can use the dynamic modulation function or MIDI control changes (effect control) to apply reverb more deeply to certain songs, or raise the LFO speed for other songs, etc.

When using a cue list to construct a song, we recommend this method. When you execute the **Convert to Song** menu command, the effect settings of the **Step 01** song will be specified at the beginning of the song that is created by the conversion.

Even when **Load FX?** is not checked, there may be a time lag in the transition from one song to the next, depending on the musical data in the song. There may also be cases in which the musical data at the transition between songs does not play at the correct timing. To fix this, you can edit the musical data of the song, or convert the cue list to a single song. If you use **Convert to Song** to convert the cue list to a song, there will be no time lag at the transition, and the musical data will play at the correct timing.

11-1c: Insert, Cut, Copy, Current Step

Insert

When you press the **Insert button**, the step data that was temporarily saved in the buffer by the **Copy button** or **Cut button** will be inserted at the **Current Step**. (If copy or cut has not been executed, default data will be inserted.)

Cut

When you press the **Cut button**, the **Current Step** will be cut, and its data will be saved temporarily in the buffer. If you **Insert** immediately after you cut, the data will return the state in which it was before you cut.

Copy

When you press the **Copy button**, the data of the **Current Step** will be saved temporarily in the buffer.

Press the **Insert button** to insert the copied step into the **Current Step**.

Current Step [01...100]

Selects the step that will be inserted, cut or copied.

If you wish to play back from a step in the middle of the cue list, select the desired step here, and press the START/STOP (▶/■) button.

See “Creating and playing a Cue List” on page 74 of the Operation guide.

What to do when playing back a cue list and the songs do not transition smoothly

Different effect settings from song to song, and dense amounts of playback data within the song, may cause a time lag between songs or create timing problems during transitions in cue-list playback. In such cases, use **Convert to Song** to transform the cue list into a single song. When you play back this song, there will be no time lag at the transition, and the data will play at the correct timing.

If the effect settings differ between songs, and you want to smooth the transition between songs, check **FX** for **Step 01**. This way, the effect settings will be made before playback begins, and there will be no time lag when cue list playback is started or when switching from song to song. Although it will not be possible to change effect types within the cue list, you can use dynamic modulation or MIDI control changes such as **Effect Control** to control the effects within the cue list, for example applying reverb more deeply on certain songs, or raising the LFO speed for a specific song. We recommend this method if you will be using a cue list to construct the song.

When you execute the menu command **Convert to Song**, the effect settings of the **Step 01** song will be specified for the song that results from the conversion.

Even if **FX** is not checked, there may be cases in which a time lag in the transition between songs, depending on the musical data of the song. Also, there may be cases in which the musical data is not played at the correct timing at song transitions. If this occurs, you can edit the musical data of the song, or convert the cue list to a song for playback. If you use **Convert to Song** to convert the cue list to a song, there will be no time lag during playback at the transitions, and the musical data will be played at the correct timing.



When you complete a cue list and convert it into a song, the track settings (e.g., program, pan, volume) of each song will be converted into performance data so that they will be reproduced correctly. However, it may not be possible for the playback result of a cue list to be

converted to a song if settings such as the MIDI channel do not match.

Using a foot switch to switch the Step

You can use a foot switch to switch the Step.

If you set **Repeat** to **FS**, a foot switch connected to the **ASSIGNABLE SWITCH** jack will control the timing at which the song stops repeating. Set **Foot Switch Assign** (Global P2: Controllers page) to **Cue Repeat Control**.

Converting a cue list into a song

Although it is not possible to record additional material onto tracks in a cue list, you can convert a cue list to a song, and then record solos etc. on vacant tracks. You will also need to convert a cue list to a song if you wish to save it to external media as SMF data.

1. Select the menu command "Convert to Song".

A dialog box will appear.

2. In "To Song," specify the destination song number for the converted data.

The cue list name will automatically be assigned as the song name of the converted data. (For details and cautions regarding **Convert to Song**, please see "Convert to Song (Convert Cue List to Song)" on page 189.)

In the dialog box that appears, it is not necessary to specify **Set Length** when selecting a new song as the conversion destination. The number of measures in the converted song will be used. Press the **OK** button, and the **Convert Cue List** dialog box will appear.



3. Press the OK button.

The cue list will be converted into a song. Access the **P0-1: Play/REC** page, select the song number that you specified as the conversion destination, and check the results.

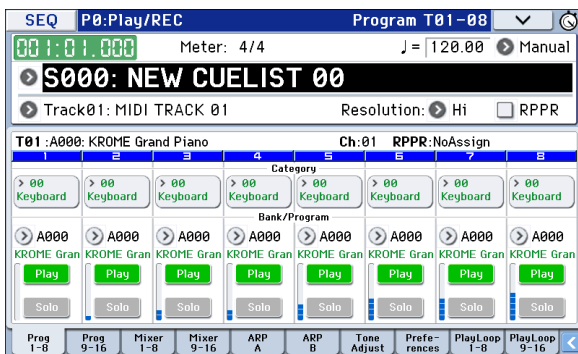

✓ 11-1: Menu Command

- 0: **Memory Status** see p. 163
- 1: **Exclusive Solo** see p. 64
- 2: **Rename Cue List** see p. 189
- 3: **Delete Cue List** see p. 189
- 4: **Copy Cue List** see p. 189
- 5: **Convert to Song (Convert Cue List to Song)** see p. 189
- 6: **Copy Song** see p. 190
- 7: **FF/REW Speed** see p. 164
- 8: **Set Location (Set Location for Locate Key)** see p. 164

For more information, please see "Sequencer: Menu Command" on page 163.

Sequencer: Menu Command

Tip: While this command is active, the ENTER button will operate as the OK button and the EXIT button will operate as the Cancel button.

Procedure for menu commands

1. Select the menu command.

2. Make settings in the dialog box.

For details on the content of each dialog box, refer to the explanation of each command.

3. To execute, press the OK button. To exit without executing, press the Cancel button.

Memory Status

This displays the remaining amount of sequencer memory. It is available on every page in Sequencer mode.

Exclusive Solo

This specifies how the Solo function will operate. Each time you select **Exclusive Solo**, the setting will alternate between multiple solo and exclusive solo. For more information, please see “Exclusive Solo” on page 64.

It is available on every page in Sequencer mode.

Rename Song

Rename Song is available on all of the tabs under the Play/REC, Play/REC Control, Controllers, EQ, Track Param, Zone/Delay, MIDI Filter 1, MIDI Filter2, and Drum Track pages.

Here, you can rename the selected song. A name of up to 24 characters can be input.

For more information, please see “Editing names” on page 91 of the Owner’s manual.

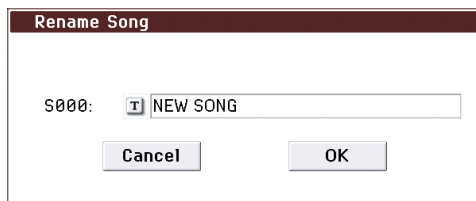

Delete Song

Delete Song is available on all of the tabs under the Play/REC, Play/REC Control, Controllers, EQ, Track Param, Zone/Delay, MIDI Filter 1, MIDI Filter2, and Drum Track pages.

This command deletes the currently selected song.

When you execute this command, the musical data, setting data, and patterns etc. of the currently selected song will be erased, and the memory area allocated to that song will be freed.

Copy From Song

Copy From Song is available on all of the tabs under the Play/REC, Play/REC Control, Controllers, EQ, Track Param, Zone/Delay, MIDI Filter 1, MIDI Filter2, and Drum Track pages.

This command copies all of the setting data and musical data from the specified song to the currently selected song.

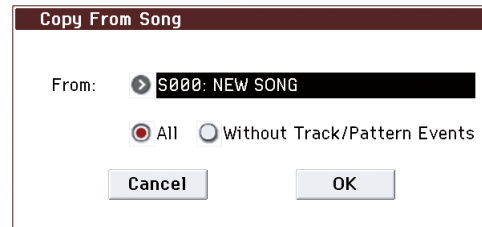

1. In **From**, specify the copy source song number.

2. Select the data that you wish to copy.

All: will copy all setting data and musical data (track events and patterns, etc.).

Without Track/Pattern Events: will copy only the setting data of songs, except for Play Loop and RPPR data.

Be aware that if you execute **All**, all setting data and musical data of the currently selected song will be erased and rewritten by the data from the copy source song. If you execute **Without Track/Pattern Events**, song setting data (but not Play Loop and RPPR) will be rewritten.

Load Template Song

Load Template Song is available on all of the tabs under the Play/REC, Play/REC Control, Controllers, EQ, Track Param, Zone/Delay, MIDI Filter 1, MIDI Filter2, and Drum Track pages.

This command loads a template song.

The built-in sequencer contains sixteen different **preset template songs** (P00–15) that contain settings for programs and effects appropriate for various musical styles. You are also free to create your own favorite settings for programs, track parameters, and effects, and save them as one of sixteen **user template songs** (U00–15). For more information, please see “Save Template Song (Save as User Template Song)” on page 164.

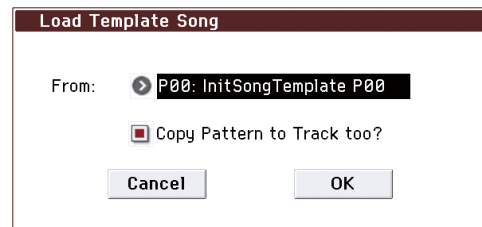

1. In **From**, specify the template song that you wish to load.

2. If you check **Copy Pattern to Track too?**, the **Copy Pattern To Track** dialog box will appear automatically after **Load Template Song** has been executed.

If you execute **without checking** this, only the template song you specified in step 2 will be loaded.

When you execute, song settings other than Play Loop and RPPR will be copied.

If in step 2 you checked **Copy Pattern to Track too?** and pressed the OK button, the **Copy Pattern To Track** dialog box will appear.

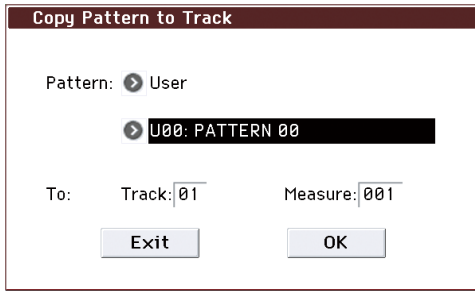

This dialog box is the same as in the menu command **Copy To Track**.

3. In To Track, select the copy destination track.

In **Measure**, specify the beginning measure of the copy destination.

Note: Track 1 of all sixteen preset template contains a drum category program. (In preset template songs P02, P04, P08, and P15 drum category programs are specified for multiple tracks.)

The pattern names of the preset patterns indicate the musical genre and part of the optimal drum category program.

By loading the drum track for these preset template songs and the corresponding preset patterns, you can efficiently set up a drum track that is suited to each preset template song.

When you execute, **Measure** will count up automatically. You may then copy patterns as well. To exit the command, press the **Exit** button.

For details on how to copy preset patterns to a song along with the preset template song, please see “Using template songs” on page 58 of the Operation guide.

Save Template Song (Save as User Template Song)

Save Template Song is available on all of the tabs under the Play/REC, Play/REC Control, Controllers, EQ, Track Param, Zone/Delay, MIDI Filter 1, MIDI Filter2, and Drum Track pages.

This command saves the program selections, track parameters, and effect settings etc. of the current song as a user template song U00–15. The settings you save here can also be loaded in Song Play mode.

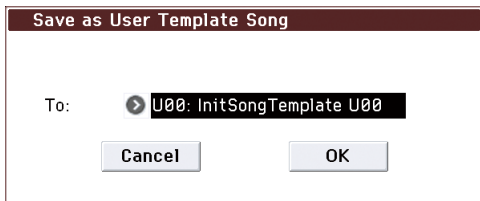

1. In To, specify the user template song (U00–15) in which the data will be saved.

Be aware that when you execute this command, all settings of the destination Template will be erased and rewritten with the current settings.

Note: The Play Loop and RPPR settings are not saved. If you want to save these settings and the user patterns, execute **Save SEQ** in Media mode and save them to an SD card.

FF/REW Speed

FF/REW Speed is available on every pages, except for the Pattern/RPPR page RPPR Setup tab.

This allows you to set the speed at which fast-forward or rewind will occur when you press the FF button or REW button.

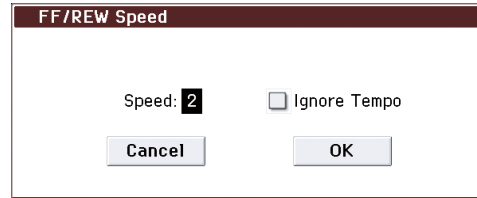

1. In Speed, specify the speed (relative to the playback tempo) at which fast-forward and rewind will occur.

The Speed setting is in multiples of the playback tempo. A setting of 1 is the same speed as the playback tempo. Settings of 2–4 respectively correspond to double, triple, or quadruple speed of the playback tempo.

Note: Fast-forward and rewind speeds may be slower in regions with dense performance data. Fast-forward and rewind speeds will differ between regions where the performance data is dense or sparse.

2. If Ignore Tempo is checked, the playback tempo and note length will be ignored, and fast-forward and rewind occurs.

If this item is **unchecked**, fast-forward and rewind will be performed at the speed you specify for **Speed**.

Set Location (Set Location for Locate Key)

Set Location is available on every pages, except for the Pattern RPPR page.

When you press the LOCATE button, you will move to the location specified here.

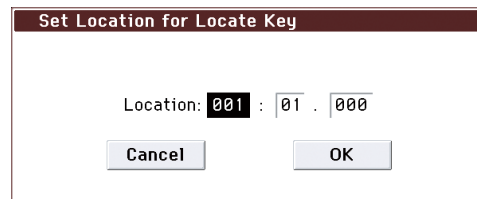

1. In Location, specify the location to which you will move when you press the LOCATE button.

From the left, the values are Measure (001–999), Beat (01–16), and Tick (000–479).

If you specify **001:01.000**, you will move to the beginning of the song when you press the LOCATE button.

Note: When this dialog box is not open, you can hold down the ENTER button and press the LOCATE button to set the current location as the **Set Location** value.

GM Initialize

GM Initialize is available on all of the tabs under the Play/REC, Play/REC Control, Controllers, EQ, Track Param, Zone/Delay, MIDI Filter 1, MIDI Filter2, and Drum Track pages.

This command transmits a GM System On message to the Sequencer mode, resetting all tracks to the GM settings. For more information, please see “GM Initialize” on page 165.

MIDI In Sequencer mode, when a GM System On message is received from an external device, or if a GM System On message is recorded in the sequence data, the KROME will be reset to settings appropriate for GM just as if you had executed this command. However, in these cases, the various P9: MFX/TFX/LFO parameters will not be reset.

GM Initialize List

| | Page | Parameter | Track 1-9, 11-16 | Track 10 | |
|-------------------------|-------------------------|-------------------------|-----------------------|---------------------------|---------------------------|
| P0 | Program T01-08, T09-16 | Program Select | G001 | g(d)001 | |
| | | Play/Mute, Solo | - | - | Setting remains unchanged |
| | Mixer T01-08, 09-16 | Pan | C064 | C064 | |
| | | Volume | 100 | 100 | |
| P2 | EQ Trim T01-08, T09-16 | Auto Load Prog EQ | On | On | |
| | | Bypass | Off | Off | |
| | | Input Trim | 99 | 99 | |
| | EQ Gain T01-08, T09-16 | High Gain [dB] | +00.0 | +00.0 | |
| | | Mid Frequency [Hz] | 3.20k | 3.20k | |
| P3 | MIDI T01-08, T09-16 | Status | - | - | Setting remains unchanged |
| | | MIDI Channel | - | - | Setting remains unchanged |
| | | Bank Select MSB/LSB | 000 | 000 | |
| | OSC T01-08, T09-16 | Force OSC Mode | - | - | Setting remains unchanged |
| | | OSC Select | - | - | Setting remains unchanged |
| | | Portamento | Off | Off | |
| | Pitch T01-08, T09-16 | Transpose | +00 | +00 | |
| | | Detune | +0000 | +0000 | |
| | | Bend Range | +02 | +02 | |
| | Scale T01-08, T09-16 | Use Program's Scale | - | - | Setting remains unchanged |
| P4 | Key Zone T01-08, T09-16 | | C-1...G9 (Slope=000) | C-1...G9 | |
| | Vel Zone T01-08, T09-16 | | 001...127 (Slope=000) | 001...127 | |
| | Delay T01-08, T09-16 | MIDI Tempo Sync. | Off | Off | |
| Time | | 0000 | 0000 | | |
| P5 | MIDI Filter1, 2 | | On | On | |
| P7 | Arpeggiator | Various parameters | | - | Setting remains unchanged |
| | Drum Track | Various parameters | | - | Setting remains unchanged |
| P8 | Routing1 T01-08, T09-16 | Bus (IFX/Output) Select | L/R | L/R | |
| | | Send1 (MFX1) | 0 | 0 | |
| | | Send2 (MFX2) | 40 | 40 | |
| | Insert FX Setup | IFX1...5 | - | - | Setting remains unchanged |
| | | Pan: #8 | - | - | Setting remains unchanged |
| | | FX Control Bus | - | - | Setting remains unchanged |
| | | Send1/2 | - | - | Setting remains unchanged |
| | Other parameter | - | - | Setting remains unchanged | |
| Routing2 T01-08, T09-16 | FX Control Bus | Off | Off | | |
| Common FX LFO | Other parameters | - | - | Setting remains unchanged | |
| P9 | Routing | MFX1 | - | - | Stereo Chorus |
| | | MFX2 | - | - | Reverb Smooth Hall |
| | | Chain | - | - | Off |
| | | Chain Direction | - | - | 1→2 |
| | | Level | - | - | 127 |
| | | Return1 | - | - | 127 |
| | | Return 2 | - | - | 50 |
| | Other MFX parameters | - | - | - | Setting remains unchanged |
| | TFX | - | - | - | Setting remains unchanged |
| | Master Level | - | - | - | Setting remains unchanged |

Copy From Combi (Copy from Combination)

Copy From Combi is available on all of the tabs under the Play/REC, Play/REC Control, Controllers, EQ, Track Param, Zone/Delay, MIDI Filter 1, MIDI Filter2, and Drum Track pages.

This command copies the parameters of the specified combination to the setting data of the currently selected song.

Note: Only the timbres used by the combination will be copied. Timbres in the combination whose Status is Off will not be copied. If any timbres are set to Mute, the corresponding tracks of the song will be set to a **Status** of Off.

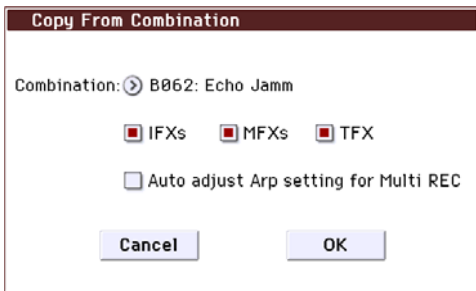

1. In **Combination**, select the copy source destination.
2. Use the **IFXs**, **MFXs** and **TFX** check boxes to specify whether you want the effect settings of the combination to be copied as well.

IFXs: All insert effect settings of the copy-source combination (the contents of the Insert FX Setup page and the IFX1–5 effect parameters) will be copied.

MFXs: All master effect settings of the copy-source combination will be copied.

TFX: All total effect settings of the copy-source combination will be copied.

3. Specify the desired **Auto adjust Arp setting for Multi REC** setting.

You have the option of checking the **Auto adjust Arp setting for Multi REC**. As necessary, this function will adjust the MIDI channel etc. of any tracks that need to be changed, and/or add new tracks, in order to ensure that when you perform multi-recording with the arpeggiator on, the same sound will be reproduced during recording as during playback.

Note: This function makes adjustments depending on the ARP state of the combination. When you copy a combination that was written with the arpeggiator turned off, it is assumed that you will leave the arpeggiator off in the song. If you want to use the arpeggiator in the song, you should write the combination with the arpeggiator turned on, and then copy it to the song.

If this is **checked**, the MIDI channels etc. of the tracks will be corrected. **Multi REC** (Seq 0–8b) and **PLAY/MUTE/REC** (Seq 0–1(2)a) will also be set automatically.

In addition, **Recording Setup, Overwrite** (Seq 0–8b) will be selected. (Note that the automatically-set **Multi REC** and **PLAY/MUTE/REC** will be reset when you re-select the song.)

Note: For details on the data that will be adjusted, see below. The content described here will be corrected automatically. Depending on the settings of the combination, it may be necessary to make additional changes to the track settings in addition to the settings here.

If the recorded performance is not reproduced correctly during playback

If you use the menu command **Copy From Combi** to copy the settings of a combination, and then perform multi-track recording with the arpeggiator turned on, there may be cases in which the performance during recording is not reproduced correctly during playback.

Multiple tracks that are set to the same MIDI channel are combined into a single stream of performance data during recording. If there is a track with the same MIDI channel as the track being played by the arpeggiator, the data played by the arpeggiator will be combined with the performance data that was played manually, and all of this data will be sounded by each track of the same channel (if **Status** is INT).

In such cases, you can solve the problem by creating a track that will drive the arpeggiator on a different MIDI Channel.

If the recorded performance is not reproduced by the playback, check the following conditions.

These settings can be executed automatically if you check **Auto adjust Arp setting for Multi REC** in the menu command **Copy From Combi**. Normally, you will check this to execute the settings. In this case, these adjustments will not be necessary, but you can verify here that the automatic adjustments have been made.

- SEQ P7: ARP/DT– ARP Setup T01–08 and T09–16 page

Arpeggiator Run A, B, and Arpeggiator Assign settings

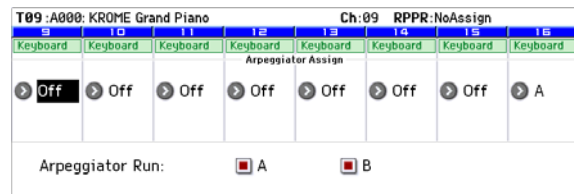
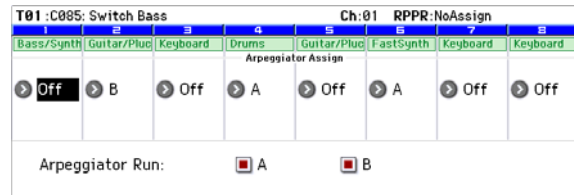

- SEQ P3: Track Param– MIDI Ch T01–08 and T09–16 page

MIDI Channel settings

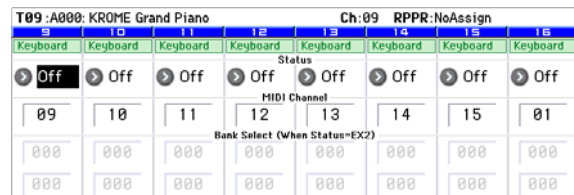
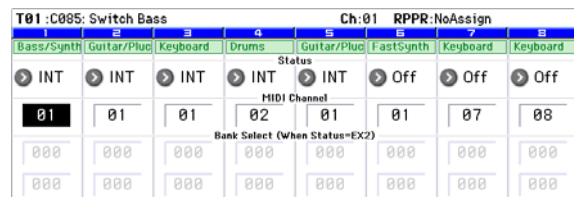

If **Arpeggiator Run A** and **B** are checked, and the arpeggiator is assigned to a track, make sure that **MIDI Channel** (Global P1: MIDI) is set to other than 01. Make sure that the global MIDI channel (Global P1: MIDI, **MIDI Channel**) is set to 01.

| Arpeggiator Run | MIDI Channel ^a | Correction |
|----------------------------------|---------------------------|------------------------|
| If either "A" or "B" are checked | 01 only | Correction required |
| | 01 02, 01 03, etc. | No correction required |

| | | |
|---------------------------------|--------------------|---|
| If both "A" and "B" are checked | 01 only | Correction required |
| | 01 02, 01 03, etc. | Correction required for only one |
| | 01 02 03, etc. | No correction required/Correction required ^b |

- a. If the **MIDI Channel** of multiple tracks operated by the arpeggiator is set only to 01, refer to the lines for "01 only." If the **MIDI Channel** settings are 01 and one other channel, such as 01 and 02, then refer to the lines for "01 02, etc." If the **MIDI Channel** settings are 01 and multiple other MIDI channels, such as 01 and 02 and 03, then refer to the line for "01 02 03, etc."
- b. Correction is necessary only if the tracks operated by a single arpeggiator are using only **MIDI Channel** 01. In some cases, correction may also be necessary if the two arpeggiators use the same MIDI channel.

 Depending on the combination settings, it may also be necessary to change the track settings as well.

The preceding illustration shows the example of copying the combination "B109: Echo Jamm" with **Auto adjust Arp setting for Multi REC** un-checked in **Copy From Combi**. Select a new song, and execute the copy to see the result. (For more about the arpeggiator settings in this combination, see page 91.)

Using these settings as an example, determine whether correction is necessary, and if so, what needs to be corrected.

Arpeggiator Run A and B are checked, and **MIDI Channel** 01 and 02 are selected. Correction is necessary for one of the arpeggiators. If you perform multi-track recording with these settings, the MIDI channels of T01, 02, and 03 are the same, so the high-register guitar/piano/pad (T02, T03, and T05), the low-register bass (T01), and the guitar riff played by arpeggiator B (T02) will have their performance data combined into one stream, and the performance will not be reproduced at playback. (T16 is a dummy track used to trigger arpeggiator A.)

1. So that the bass played by arpeggiator B can be recorded separately, change the **MIDI channel** of T02.

Select the SEQ P3: Track Param– MIDI T01–08 page, and change the T02 **MIDI Channel** to 03.

2. Add settings for triggering arpeggiator B.

Select the SEQ P3: Track Param– MIDI T09–16 page, and for track 8 (or any unused track), turn **Status** Off, and set the **MIDI Channel** to 01. (T08 will be a dummy track used to trigger arpeggiator A.)

3. Select the SEQ P7: ARP/DT– ARP Setup T09–16 page. Set the track 8 Assign to B.

This will produce the following settings.

| Track | T01 | T02 | T03 | T04 | T05 | T06 | T07 | T08 | T16 |
|----------|-----|-----|-----|-----|-----|-----|-----|-----|-----|
| Assign | Off | B | Off | A | Off | Off | Off | B | A |
| Status | INT | INT | INT | INT | INT | INT | Off | Off | Off |
| MIDI Ch. | 01 | 03 | 01 | 02 | 01 | 01 | 10 | 01 | 01 |

This completes the corrections. In the Sequencer P0: Play/REC– Preference page, set **Track Select** to any track whose MIDI channel is 01. Check the **Multi REC** check box and perform multi-track recording.

Copy from Program

Copy from Program is available on all of the tabs under the Play/REC, Play/REC Control, Controllers, EQ, Track Param, Zone/Delay, MIDI Filter 1, MIDI Filter2, and Drum Track pages.

This command copies settings from the program you specify to the currently selected song.

This is the same function as in Combination mode; for details, please see "Copy from Program" on page 101.

This command in Sequencer mode differs from its behavior in Combination mode in that the channels assigned to the tracks of the song will be preserved regardless of the **with Arp** setting of the copy-destination track's **MIDI Channel**. (See step 4.)

Copy Tone Adjust

Tone Adjust tab of the play/REC page.

For more information, please see "Copy Tone Adjust" on page 65.

Reset Tone Adjust

Tone Adjust tab of the PLAY/REC page.

For more information, please see "Reset Tone Adjust" on page 65.

Copy Drum Track

Copy Drum Track is available on the Drum Track tab of the ARP/DT page.

This command copies the drum track settings of the specified Program, Combination, or Song.

For more information, please see "Copy Drum Track" on page 65.

Erase Drum Track Pattern

Erase Drum Track is available on the Drum Track tab of the ARP/DT page.

This erases the drum track pattern you specify.

For more information, please see "Erase Drum Track Pattern" on page 66.

Detune BPM Adjust

Detune BPM Adjust is available on the Pitch tab of Track Pram page.

When the program selected for a track uses a phrase, or rhythm loop multisample, you can use this command to change the BPM of the phrase or rhythm. The BPM can be adjusted by modifying the pitch. This command is available when the **Detune** setting of that track is selected. When you execute this command, the selected **Detune** value will be adjusted.

For more information, please see "Detune BPM Adjust" on page 103.

Copy Arpeggiator

Copy Arpeggiator is available on the Arp A tab and Arp B tab of Play/REC Control page or Setup tab, Arp A tab, Arp B tab, Scan Zone tab of the ARP/DT page.

This command can be used to copy arpeggio settings from another location to the current program.

For more information, please see "Copy Arpeggiator" on page 66.

Step Recording

Step Recording is available on all of the tabs of the Track Edit page.

Step recording allows you to specify the length and velocity of each note numerically, and to input the pitches from the keyboard. You can use the **Rest button** and **Tie button** to input a rest or tie.

 If you use step recording to input data into a track that already contains sequence data, all data will be erased from the **From Measure** and subsequent measures. If after inputting, you decide to revert to the prior data, use the Compare function.

To input data with a continuously-changing value such as pitch bend, it is best to use **Create Control Data**. To input individual data events such as program changes, use **Event Edit**.

1. Use **Track Select** to select the track into which you wish to input data, and use **From Measure (Seq 6-1c)** to specify the measure at which you wish to begin input.
2. Select **"Step Recording"** to open the dialog box.

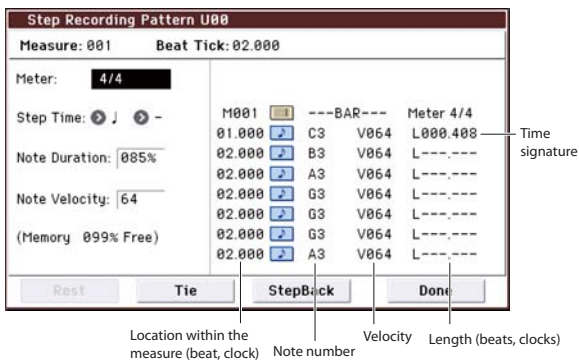

Location within the measure (beat, clock) Note number Velocity Length (beats, clocks)

3. In Meter, set the time signature.

This will show the time signature that has already been set for the measure.



















If you change the time signature setting, the time signature data of the measures you record will change, and all tracks will change to the time signature you specified.

4. In Step Time, specify the length (in terms of a note value) of the basic interval at which you will input data.

From the popup menu at the left, select the note length in a range of ♩ (whole note) through 32nd note.

If you want the selected note value to be a dotted note or a triplet, use the popup menu at the right to select a dot **“(Dot)”** or triplet **“3 (Triplet)”**. To use the unmodified value of the selected note, choose **“- (Normal)”**.

The following table shows the number of clocks represented by each **Step Time** selection.

| | | | | | |
|---|---|---|---|---|---|
|  |  |  |  |  |  |
| (0:060) | (0:120) | (0:240) | (1:000) | (2:000) | (4:000) |
|  |  |  |  |  |  |
| (0:090) | (0:180) | (0:360) | (1:240) | (3:000) | (6:000) |
|  |  |  |  |  |  |
| (0:040) | (0:080) | (0:160) | (0:320) | (1:160) | (2:320) |

5. In Note Duration, specify the length that the note will actually be held, relative to the Step Time.

In general, 100% will be tenuto, 85% will be normal, and 50% will be staccato.

6. Use Note Velocity to specify the velocity value (keyboard playing strength) of the note data.

With the **PAUSE (|||)** button pressed, you can hold down the **ENTER** button and play a note on the keyboard to specify the velocity value. If you set Note Velocity to **Key**,

the actual velocity at which you played the key will be input.

7. Input the note events described below by playing notes on the keyboard or by pressing the buttons in the lower part of the dialog box.

• Inputting notes

When you press a key on the keyboard, that note number will be input as a note of the length specified in step 4.

When you press a chord on the keyboard, those note numbers will be input as chords of the length specified in step 4. Since each of the note numbers you press before releasing all of the keys will be input at the same location, the notes will be input as a chord even if they are actually played at different times.

Each time you press and release the keyboard, the location will advance by the length specified in step 4.

• Inputting rests

Press the **Rest button** to input a rest of the length specified in step 4.

• Inputting a tie

If you press the **Tie button** without pressing the keyboard, the previously-input note will be tied, and lengthened by the amount specified in step 4.

If you press the **Tie button** while holding down a note, the note you are playing will be tied, and lengthened by the amount specified in step 4.

You can even input notes as shown in the following diagram.

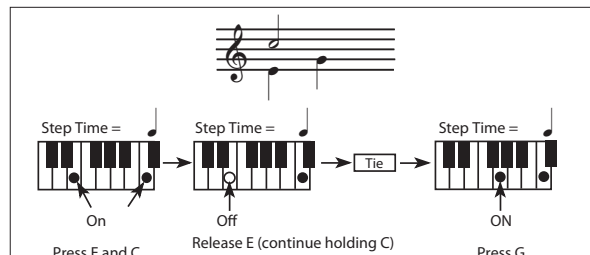

• Deleting a note or rest

To delete a note or rest, press the **StepBack button**. The location will move backward by the amount specified in step 4, and the data in that interval will be deleted.

• Auditioning the next note before input

If you wish to make sure of the next note before you actually input it, press the **PAUSE (|||)** button (the LED will light up). Now when you press a key, you will hear sound but the note will not be input. Press the **PAUSE (|||)** button once again (the LED will go dark) to cancel the pause mode and resume input.

8. When you are finished with step recording, press the Done button.

If you press the **COMPARE** button, you will return to the condition of before you began step recording.

Event Edit

Event Edit is available on all of the tabs of the Track Edit page.

Here, you can edit individual events of MIDI data that were input.

1. Use **Track Select** to select the track that you wish to edit, and use **From Measure (Seq 6-1c)** field to specify the measure at which you wish to begin editing.

If you selected **Track 01-16** in **Event Edit**, selecting this command will open the **Set Event Filters** dialog box.

If you selected **Master Track** in **Track Select**, this dialog box will not appear.

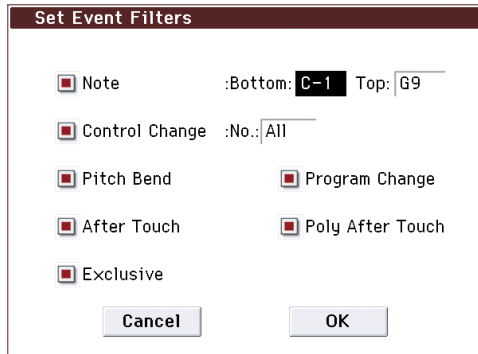

In the **Set Event Filters** dialog box you can select the types of events (musical data) that will appear and can be edited in the event edit window.

For **Note** you can set **Bottom** and **Top** to specify the range of notes available for editing. Normally you will leave these set at **C-1** and **G9**.

Control Change lets you specify the control change number. Normally you will leave this set at **All**.

You can also check various other events (**Pitch Bend**, **Program Change**, **After Touch**, **Poly After Touch**, and **Exclusive**).

2. Press the **OK** button to open the **Event Edit** dialog box.

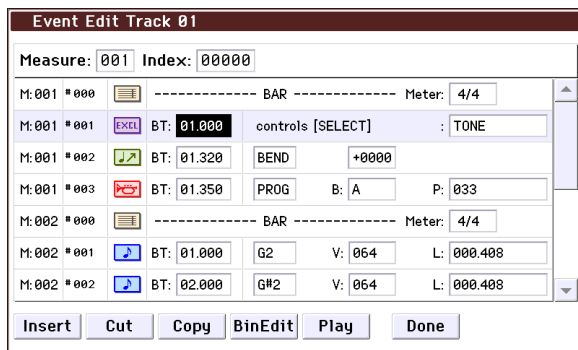

3. In the upper part of the dialog box, **Measure** and **Index** show the measure that you are editing and the events of the index numbers within the measure.

You can touch the scroll bar located at the right to move to the event that you wish to edit.

4. Select the event that you wish to edit, and use the **VALUE controller etc. to modify its value(s)**.

- By modifying the value of the **Beat Tick** location within the measure, you can move the event within the measure.
- You can edit each event by modifying its data value(s). When you select a note event, it will sound.

5. You can press the buttons located at the bottom of the dialog box to edit events as follows.

• Inserting an event

Select the location **Beat Tick** at which you wish to insert an event, and press the **Insert** button to insert an event.

• Deleting an event

Select the event that you wish to delete, and press the **Cut** button to delete the event.

• Moving an event

You can use the **Cut** button and **Insert** button to move an event (as in “cut and paste”).

Use the **Cut** button to delete the event that you wish to move, then use the **Insert** button to insert it at the desired location.

You can also move an event by modifying its **Beat Tick** value.

• Copying an event

Select the event that you wish to copy, and press the **Copy** button. Then select the copy destination and press the **Insert** button to insert the event at that location.

• Playing back an event

When you press the **Play** button, a dialog box will open and the song will begin playing. Use this to audition the edits you’ve made in **Event Edit**.

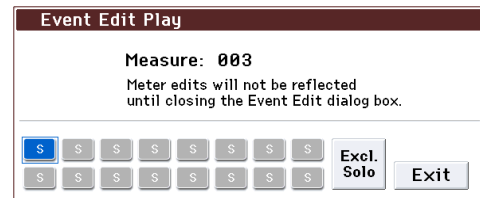

- Playback will begin from the measure specified by **Measure**.

- Playback will occur according to the settings of the song. (The song will play back in the same way as in the P01-1: Play/REC page, etc.)

If you want to play back only the track you’re editing, exit “Event Edit” and solo the desired track. Alternatively, mute the other tracks. The track being edited is indicated by a blue rectangle.

- If you press the **Excl. Solo** button, the exclusive solo function will turn on.

Off: Multiple solo operation

The solo on/off state will change each time you press a solo button. You can turn solo on for multiple tracks.

On: Exclusive solo operation

Solo will be on for only one of the sixteen tracks.

This setting is linked with the “Exclusive Solo” menu command.

If the menu command **Panel-SW Solo Mode On** is checked, switches 1-8 will control solo on/off if you’ve selected **Control Assign MIXER T1-8** or **T9-16**, even while using **Event Edit Play**.

- If you’ve edited the **Meter**, the change will not be reflected in the playback until you exit **Event Edit**.
- When you press the **Exit** button, playback will stop and you will return to the **Event Edit** dialog box.
- **Editing system exclusive messages**

You can edit **KROME** parameter change messages and universal system exclusive messages.

For the applicable parameters, refer to the table on p.634. *Dump/Ext* is shown in the following cases.

- Exclusive dump data
- Parameter change messages not supported by the **KROME**, such as messages from an external MIDI device

- Parameter change messages of other than Sequencer mode

Unavailable is shown in the following cases.

- KROME parameter change messages that cannot be realtime-recorded by the KROME, such as MIDI Channel, Status, or Key/Vel Zone. (This corresponds to parameters not in the table on page 191. Such cases may arise when the parameter cannot be realtime-recorded by operating a parameter on the KROME, but can be recorded when received via MIDI.)
- KROME parameter change messages for which there is no supported parameter, due to an input mistake or some other reason

Note:

- IFX1, 2, 3, 4, 5, MFX1, MFX2, and TFX effect parameters
- Tone adjust

These parameter names and displayed values are the parameter names and values for the corresponding effect. (Effect parameters consisting of "Parameter" and a "numeral" (e.g., Parameter71) are parameters not used by the currently selected effect.)

If you're recording parameter change messages to switch the effect type, the parameter names will not be the corresponding parameter names for the effect that is originally selected at song playback; rather, the display will show the parameters for the currently selected effect. Be aware of this when switching effects, and when controlling their parameters.

The BinEdit button will be available when an exclusive message is selected. Pressing this button will open the Binary Editor dialog box.

Here, a system exclusive message starting with F0 can be edited in hexadecimal form. Use this when you want to enter and edit a system exclusive message for an external device.

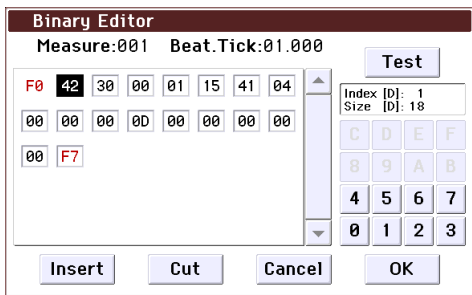

The KROME's system exclusive messages have the following format.

F0: Exclusive status

42: Korg ID

3n: n=0...F Global MIDI channel

00: Model ID byte 1

01: Model ID bytes 2

15: Model ID bytes 3

ff: function ID

([41][04]: Sequencer mode parameter change)

...

F7: End of exclusive

- When you press the Test button, the currently-edited system exclusive message will be transmitted from the MIDI OUT connector, USB MIDI connector, and EX-FW connector (if optionally installed). Use this when you want to check the operation of an external device.
- Index [D] in the information box indicates the position of the selected data within the message as a number of bytes

from the beginning of the message. Taking the starting F0 as zero, this is shown as 1, 2, 3, ... etc. (a decimal value). Size [D] is a decimal value indicating the number of bytes in the currently edited system exclusive. 16[D] indicates that the message is sixteen bytes.

- Press the OK button to apply the settings.
 - Use the data entry buttons to enter data as hexadecimal values. The values 8, 9, A, B, C, D, E, and F are valid only when entering the lower digit, where these values are permitted.
 - You can use the Insert button and Cut button to insert or delete byte data.
 - Press the OK button to apply the settings and return to the event edit page.
- 6. When you are finished event editing, press the Done button. If you press the COMPARE button you will return the data to the condition in which it was before you began event editing.**

The following table shows the types of musical data that can be edited by **Event Edit** and the range of their values.

| BAR (displayed only) (Measure line) | | Meter: 1/4...16/16 *1 (Time signature) |
|--|--|---|
| C-1...G9 *2 (Note data) | V: 1...127 *2 (Velocity) | L: 000.000...15984.000 (Length: beats, clocks) |
| PAFT (Polyphonic after touch) | C-1...G9 (Note number) | 0...127 (Value) |
| CTRL (Control change) | C: 0...119 (Control change number) | 0...127 (Value) |
| PROG (Program change) | Bank:A...E 000...127, GM, g(1)..g(9) g(d), — -, (Program bank) | P: 0...127, 1...128 (GM, g(1)...g(d)) (Program number) |
| AFTT (After Touch) | 0...127 (value) | |
| BEND (Pitch bend) | -8192...+8191 (value) | |
| EXCL *3 (Exclusive) | | |

*1: Be aware that because the time signature is recorded in the master track, modifying it within any track will affect all tracks at the same measure, causing them all to play back with the modified time signature.

Note: *2: You can also enter the note data and velocity values by holding down the ENTER button and playing a key.

*3: You cannot change Exclusive events into a different type of event (e.g., a Note or Control Change event). Nor can you change any other type of event into an Exclusive event.

Pattern numbers will be displayed in locations in which a pattern has been "put" (placed). At the end of the track there will be an indication of **Track End**.

Piano Roll

The Piano Roll dialog box provides a detailed graphic view of event data such as notes, velocities, and control changes. Here you can also modify, delete, or create these events.

1. Use "Track Select" to select the track that you want to edit, and use "From Measure" (Seq 6-1c) to specify the starting measure that you want to edit. Alternatively, use the Track View page (Seq 6-2) to specify the track and measures for editing.
2. From the menu commands, choose "Piano Roll" or choose the  tool in the Track View page; the Piano Roll window will appear. (See illustration below.)
3. The note view area in the upper part of the dialog box and the control view area in the lower part will show the events that can be edited.

The events are shown in one of the following ways. For details, refer to the explanation of each item.

- Press note view area select, and use the VALUE controllers to operate it.
 - Choose the  tool and drag.
 - Enter Meas and # in the event list.
 - Use the Zoom buttons to zoom the display in/out.
4. Choose the desired editing tool from the tool box, and edit the data. For details, refer to "Editing notes" or "Editing control data."

Note: If you decide to cancel an editing operation, press the Undo button. This takes you back to the state prior to the most recent operation. The Redo operation cancels the Undo operation. If you want to return to the state prior to entering the piano roll dialog box, press the Done button to stop editing, and then press the COMPARE button.

5. To play back the events, press the Play button. A dialog box will open, and the song will begin playing. Use this to hear the results of your editing.
6. Press the Done button when you're finished editing.

Note view area

Here you can edit, delete, or add note events.

The vertical axis of the grid indicates pitch, and the horizontal axis is the location (of the measures). The grid interval for the horizontal axis is specified by the Piano Roll Setup **Grid Resolution** parameter.

For note events, the vertical axis indicates the pitch, and the length of the bar indicates the duration of the note. The left edge of the bar is the beginning of the event.

Measures in which a pattern has been put are shaded in purple.

Note view area select

Here you can change the range of pitches that are displayed. Press this object and operate the VALUE controllers (VALUE dial, IND/DEC buttons, etc.) change the range of displayed pitches. You can also move the bar by dragging it up or down.

This will be released when you select an event list item or the control view select section.

Control view area

This shows velocity or control data, and allows you to edit, delete, or add this data.

Control view area select

This selects the data shown in the control view area. Choose from the following.

- Vel: Velocity
- PAft: Polyphonic aftertouch
- CC#000...119: Control change 000-119
- Aft: Aftertouch
- Bnd: Pitch bend

If you select a note in the note view area, velocity will be shown automatically.

* Program changes and exclusive events are not shown.

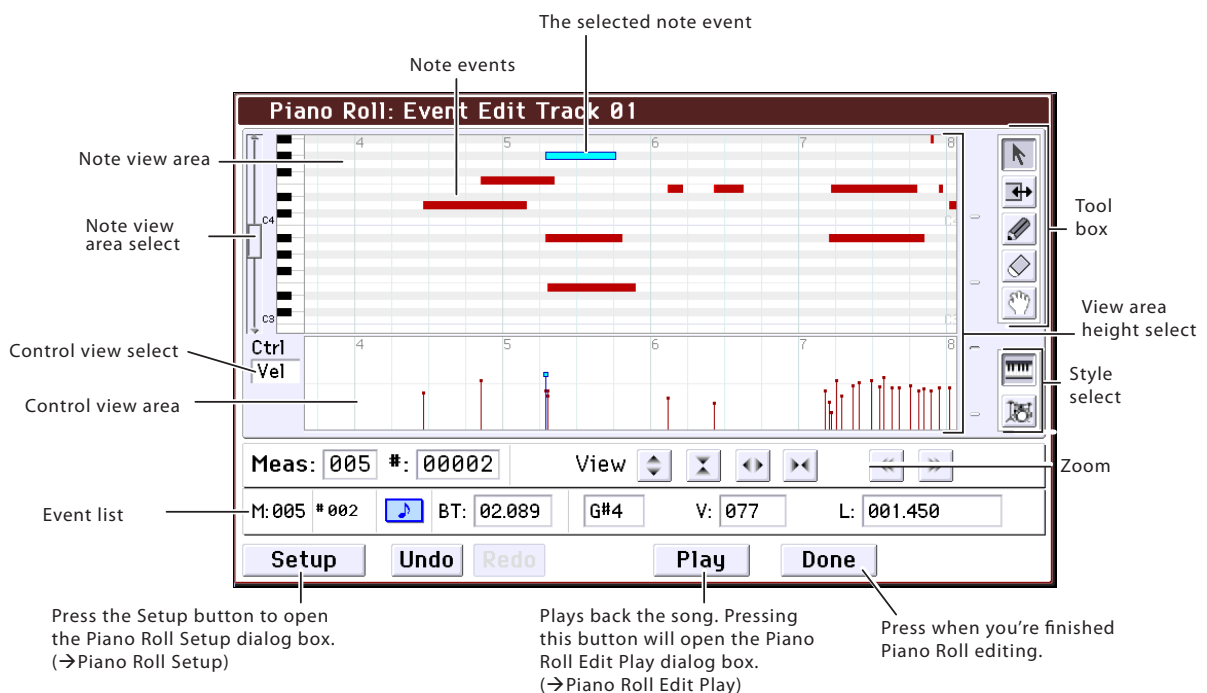

Toolbox



Select Event tool

Use this to select an event in the note view area or control view area. You can move an event by dragging it.



Length Edit tool: Only for Note view

Use this tool to modify the length of a note; press the event and drag it.



Put Event tool

Use this to create an event.

If you press inside the note view area, a note will be added. The **Grid Resolution** setting in Piano Roll Setup specifies the length of the inserted note. The note will be inserted with a velocity of 100.

If you press inside the control view area, a control event specified by the control view select **Ctrl** setting will be created. You can create continuous data by dragging. However, PAft (polyphonic aftertouch events) cannot be created.

You can't create events in a measure where a pattern has already been placed.



Erase Event tool

Use this to erase an event.

If you press inside the note view area, the note will be erased.

If you press control data in the control view area, that data will be erased. If velocity is displayed, the note event will be deleted at the same time.

Limited to Erase, you can erase multiple events in a single operation. Drag to enclose the events you want to erase (they will light blue), and then release; the events in the specified region will be erased. However, PAft (polyphonic aftertouch events) cannot be erased.



Grab tool

You can move the displayed region by dragging over the note view area or control view area.



Style Select tool

Use this to switch the note event display between the conventional type and a type suitable for a drum kit.

View control



Zoom

Use these buttons to zoom in/out the data shown in the note view area or control view area.

From the left, these buttons zoom-in (magnify) the vertical axis, zoom-out (shrink) the vertical axis, zoom-in (magnify) the horizontal axis, and zoom-out (shrink) the horizontal axis.

Vertical zoom-in/out will zoom centered on the selected event.

Horizontal zoom-in/out will zoom based on the measure shown at the far left.



Scroll

Use these buttons to scroll the note view area.

View area height select

Pressing these buttons will change the displayed size of the note view area and the control view area.

Editing notes

Note: If you decide to cancel a change, press the Done button to finish editing, and then press the COMPARE button. You will return to the state prior to opening the Piano Roll dialog box.

Moving a note

1. Press the  tool.
2. Press the note event that you want to move.

The note will light blue. Continue pressing, and event information will be displayed in the upper left (or upper right).

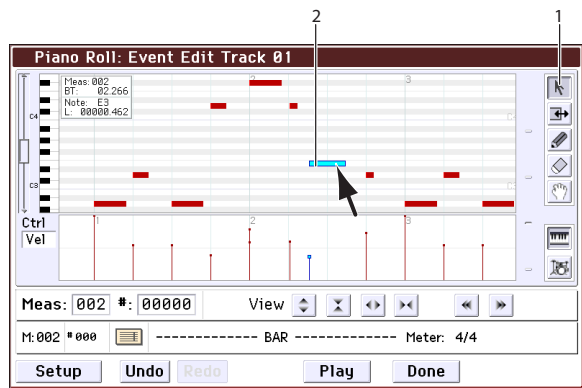

3. Continuing to press the note, drag it up/down/left/right.

Dragging vertically will change the note's pitch, and dragging horizontally will change its location.

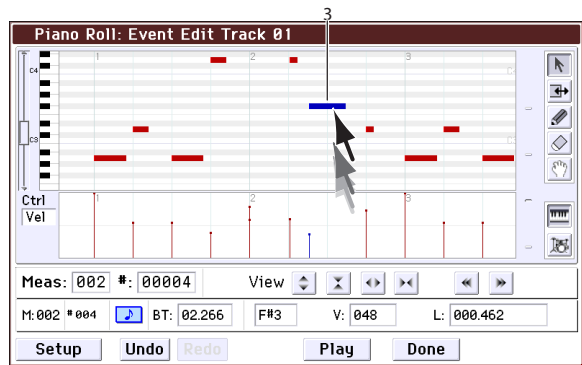
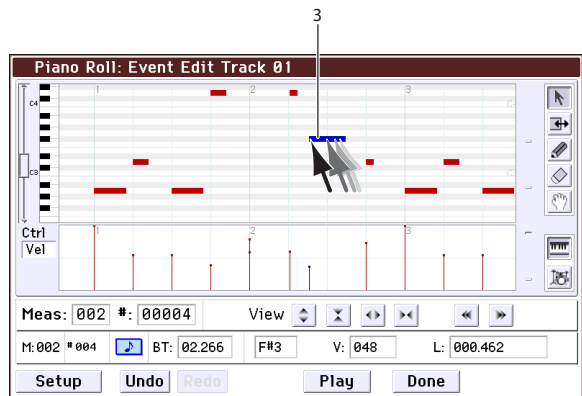

Moving a note to a precise location

- You can use the Piano Roll Setup **Snap to Grid** or **Move Note Resolution** settings to easily specify a precise location. For example if you want to move a note to a precise timing interval such as ♪♪♪, use **Grid Resolution** to specify the unit and turn **Snap to Grid** on. When you drag a note event, it will snap to the grid. (See "Piano Roll Setup dialog box" on page 175.)

Editing a value in the event list

- Choose the  tool, and then press the note event that you want to move. In the event list below, use the VALUE controllers to enter the desired value.

Note data and velocity values can also be entered by holding down the ENTER button and playing a note on the keyboard.

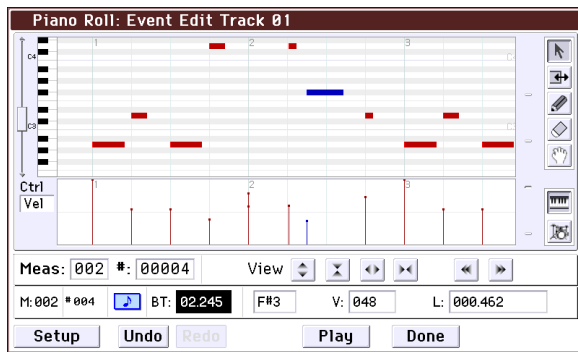

Changing the length of a note

1. Press the  tool.
2. Press near the right end of the note event whose length you want to change.

The note will be highlighted. Continue pressing, and event information will be displayed in the upper left (or upper right).

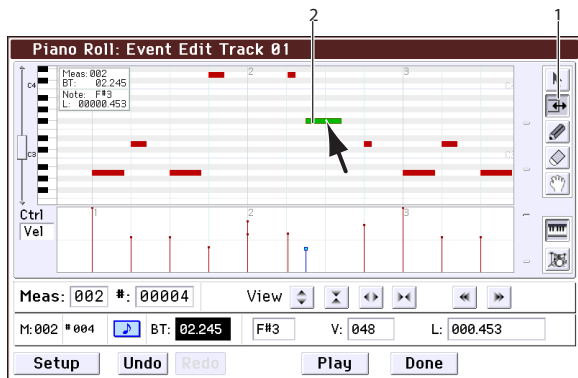

Note: If you select a note event and it turns light blue, a square will be shown at the right end. The note will turn green if you press this square.



3. Continuing to press the note, drag it left/right.

The note length will change.

If the Piano Roll Setup **Snap to Grid** setting is on, the length will change in increments of the **Grid Resolution** when you drag it.

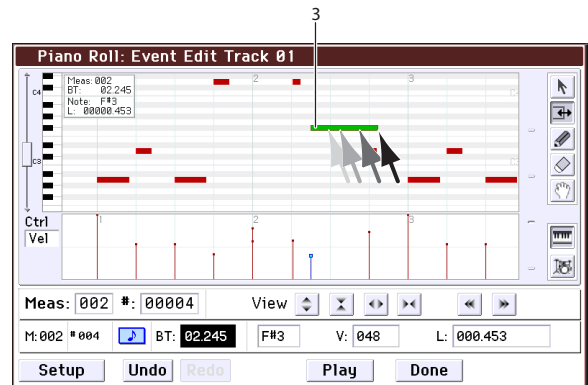

Entering a note

1. Press the  tool.
2. Press the location at which you want to enter the note.

- A note will be entered. Continue pressing, and event information will be displayed in the upper left; you can drag the note to the desired location. The note will be entered with a velocity of 100.
- To specify the length of the notes that are entered, set the desired **Grid Resolution** in the Piano Roll Setup dialog box.
- To align the note to a precise location, set the desired **Grid Resolution** in the Piano Roll Setup dialog box, and turn **Snap to Grid** on.

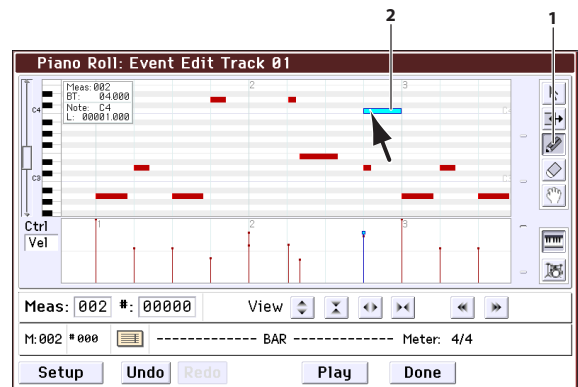

Erasing a single note

1. Press the  tool.
2. Press the note that you want to erase. The data will be erased.

Erasing multiple notes

Limited to the Erase operation, you can select multiple events and erase them in a single operation.

1. Press the  tool.
2. Drag to enclose the region of notes that you want to erase. The notes to be erased will be highlighted.

When you release, the data will be erased.

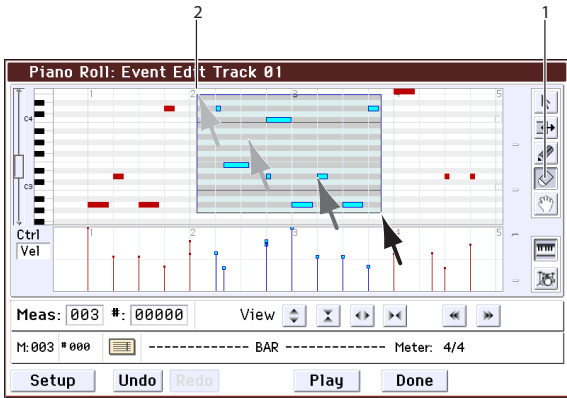

Editing control data

Editing a data value

1. Press the  tool.
2. Choose the data that will be shown in the control view area. If you've selected note events, this area will show velocity data.

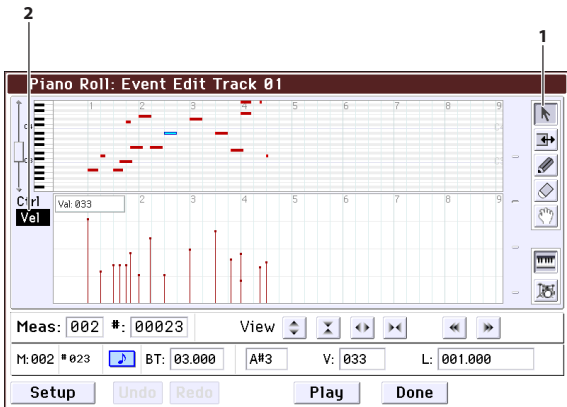

3. Press the square at the top of the data that you want to edit.

The indication will be highlighted. Continue pressing, and event information will be displayed in the upper left.

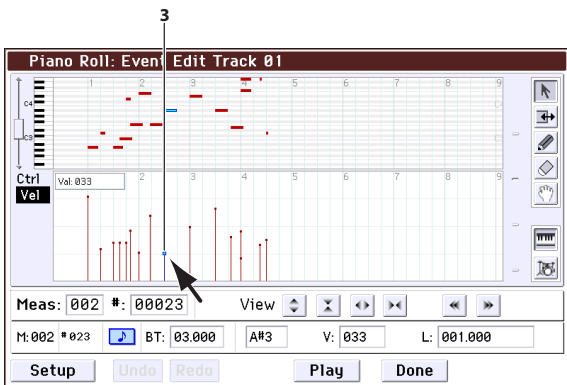

4. Drag up/down to change the value.

Alternatively, you can enter the desired value in the event list.

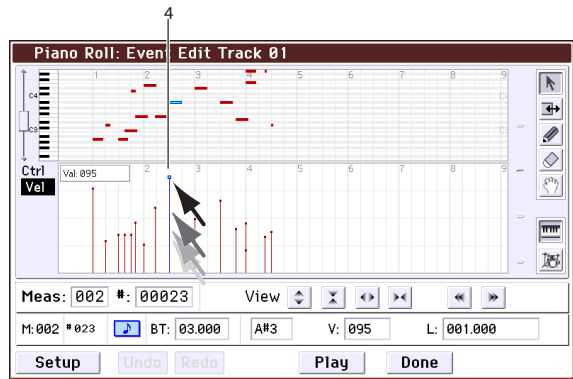

Creating continuously changing data values

1. Press the  tool.
2. Choose the data that will be shown in the control view area.
3. Drag over the region whose values you want to change. The path on which you drag is shown by a line. When you release, the values will change to fit that line.

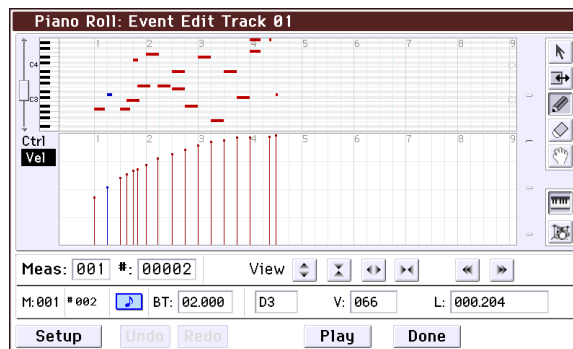
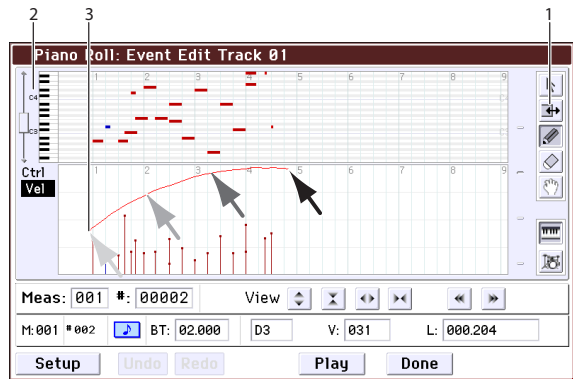

Entering data

1. Press the  tool.
2. Choose the data that will be shown in the control view area.
3. Drag over the region in which you want to enter data. The path on which you drag is shown by a line. When you release, values will be entered to fit that line.

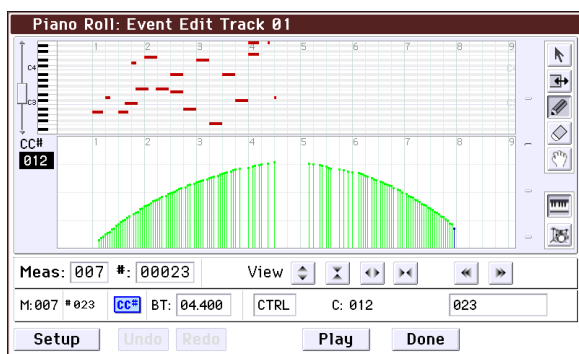
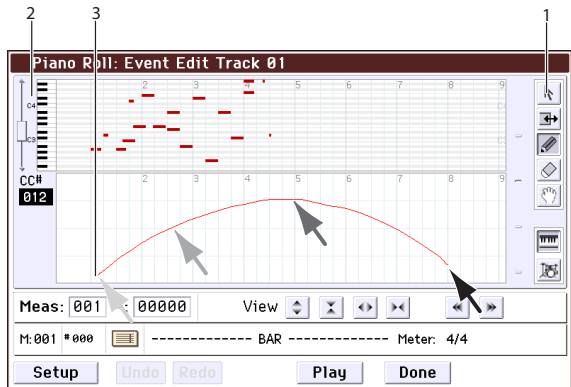

Erasing data

1. Press the  tool.
2. Choose that data that will be shown in the control view area.
3. Press on the data that you want to erase, or drag across the region that you want to erase. When you release, the data will be erased.

Event list

Use **Meas** (Measure) and **#** (Index) to display the measure that you want to edit and the desired index number within that measure.

If you change **#** to choose control data such as AFTT or CC#01 in the lower area, the control view select value will also change, and those values will be shown in the control view area.

When you select an event in the note/control view area, the event will turn light blue and that value will be shown in the event list. If you use “#” to select a different event, the selected event will be shown in dark blue, and the light blue event will turn red.

Select the event that you want to edit, and use the **VALUE** controllers to enter the desired values.

- By editing the **BT** (Beat Tick) location within the measure, you can move an event within that measure.
- You can edit each type of event data. When you select a note event, it will sound.

The following table shows the types of data and the available values that you can edit in “Piano Roll: Event Edit.”

| BAR (displayed only) (Measure line) | | Meter: 1/4...16/16 (Time signature) |
|--|---------------------------------------|---|
| C-1...G9 * (Note data) | V: 1...127 * (Velocity) | L: 000.000...15984.000 (Length: beats, clocks) |
| PAFT (Polyphonic after touch) | C-1...G9 (Note number) | 0...127 (Value) |
| CTRL (Control change) | C: 0...119 (Control change number) | 0...127 (Value) |
| AFTT (After Touch) | 0...127 (value) | |
| BEND (Pitch bend) | -8192...+8191 (value) | |

* Note data and velocity values can also be entered by holding down the ENTER button and playing a note on the keyboard.

Undo, Redo button

You can press the Undo button to cancel the most recent edit. The Redo button returns to the edited state. These buttons allow you to return only to the state prior to the single most recent operation.

Setup button

Press the Setup button to access the Piano Roll Setup dialog box, where you can make settings such as the resolution when editing in the note view area.

Piano Roll Setup dialog box

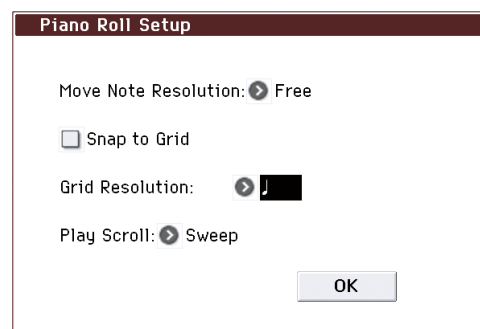

Move Note Resolution [Free, , , , , , , , , ,

When you drag a note event horizontally, it will move in units of the resolution you specify here. For example if you set this to , dragging an event at location BT:1.001 toward the right will successively move it to locations 2.01, 3.001, 4.001, etc. This adjustment will not occur if you choose the Free setting.

This setting is valid if **Snap to Grid** is Off.

Snap to Grid [Off, On]

On: When you drag a note event horizontally, it will snap to the resolution specified by **Grid Resolution**. For example if **Grid Resolution** is set to , dragging an event at location BT:1.001 toward the right will move it to locations 2.000, 3.000, 4.001, etc. The locations to which you can move a note will be limited to precise quarter-note intervals.

A dotted grid is displayed in the note/control view area according to the **Grid Resolution** setting.

Off: Notes will not snap to the grid. They will move at the resolution specified by **Move Note Resolution**.

Grid Resolution



This specifies the resolution of the grid. If **Snap to Grid** is On, notes will snap to the resolution you specify here.

Note events created by the Put Event tool will also have the resolution and length specified here.

Play Scroll

[Sweep, Crawl]

This specifies how the note/control view area will scroll during playback.

Sweep: When the location bar reaches the end of the view area, the next measure and the location bar will move to the left edge.

Crawl: The view area will scroll measure by measure. The location bar will not move.

Play button

When you press the Play button, a dialog box will open, and the song will begin playing back.

Playback will start from the beginning of the measure shown in the note/control view area.

Piano Roll Edit Play

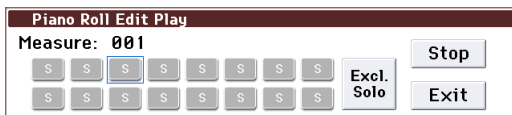

Solo buttons

Each track will play back according to the Play/Mute and Solo settings in P0 Program T01–08 and T09–16. The solo track(s) can also be switched using the sixteen Solo buttons in the Piano Roll Edit Play dialog box. The upper row controls tracks 1–8 and the lower row controls tracks 9–16. The track being edited is enclosed in a frame.

Excl.Solo button

This turns Exclusive Solo on.

Off: Multiple Solo operation

Each time you press a solo button, the Solo setting of that track will turn on or off. You can turn Solo on for multiple tracks.

On: Exclusive Solo operation

Solo can be turned on for only one of the 16 tracks at a time.

This setting is linked with the **Exclusive Solo** menu command.

Play button

When you press the Stop button, playback will stop and Piano Roll Edit Play will close. The note/control view area will show the beginning of the measure at which you stopped.

Exit button

When you press the Exit button, playback will stop and Piano Roll Edit Play will close. You will return to the measure in the note/control view area where you started playback.

Set Song Length

Set Song Length is available on all of the tabs of the Track Edit page.

This command changes the length of the specified song. When it is executed, the length of the master track will change, and the number of measures played will change.

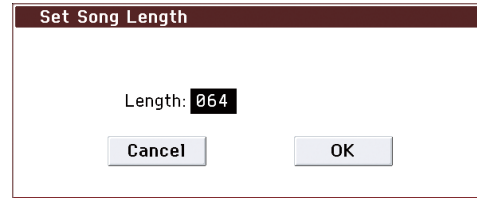

1. In **Length**, specify the length of the song.

⚠ All data following the measure specified by **Length** will be deleted.

Erase Track

Erase Track is available on all of the tabs of the Track Edit page.

This command erases the data from the specified track. However, it is not possible to erase the master track by itself.

1. In **Track Select**, select the track that you wish to erase.
2. Select **"Erase Track"** to open the dialog box.

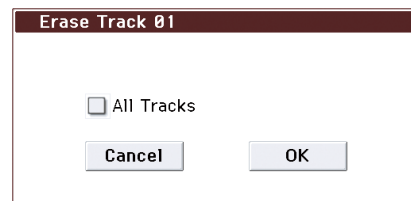

3. Select the track whose data you want to erase.

If you don't check **All Tracks**, the data will be erased only from the tracks you specify in **Track Select**.

If you check **All Tracks**, the musical data of all tracks will be erased.

Copy Track

Copy Track is available on all of the tabs of the Track Edit page.

This command copies musical data from the copy source track to the specified track.

Be aware that the track data of the copy-destination will be erased when you execute the Copy Track operation.

1. Use **Track Select** to select the MIDI track (Track 01–16) that you want to copy.
2. Select **"Copy Track"** to open the dialog box.

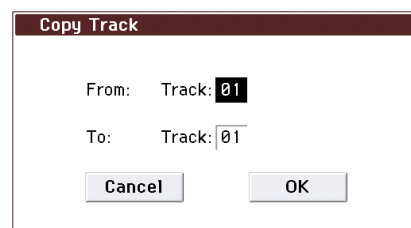

3. Use the **From** field to select the copy-source track, and **To** to select the copy-destination.

(By default, the track you choose in **Track Select** will be specified for **From**.)

Bounce Track

Bounce Track is available on all of the tabs of the Track Edit page.

This command combines the musical data of the source and destination tracks, and places the combined data in the bounce destination. All musical data in the source track will be erased.

If MIDI control data exists in both the source track and destination track, unexpected results may occur during playback after the bounce command is executed. To prevent this from happening, use **Event Edit** or **Erase Control Data** to edit the MIDI control data of the two tracks before you use **Bounce Track**.

1. Use **Track Select** to select the MIDI track (Track 01–16) that you want to bounce.
2. Select “**Bounce Track**” to open the dialog box.

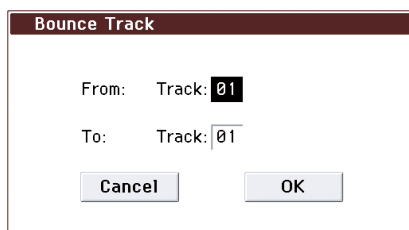

3. Use the **From** field to select the source track, and **To** to select the destination track.

(By default, the track you choose in **Track Select** will be specified for **From**.)

In the case of **Bounce Track**, the source track data will be set to “zero”.

Erase Measure

Erase Measure is available on all of the tabs of the Track Edit page.

This command erases the specified type(s) of musical data from the specified range of measures.

The **Erase Measure** command can also be used to remove only a specific type of data. Unlike the **Delete Measure** command, executing the **Erase Measure** command does not cause the subsequent measures of musical data to be moved forward.

1. Use **Track Select** to select the MIDI track (Track 01–16), master track that contains the measures of data you want to erase.
2. Select “**Erase Measure**” to open the dialog box.

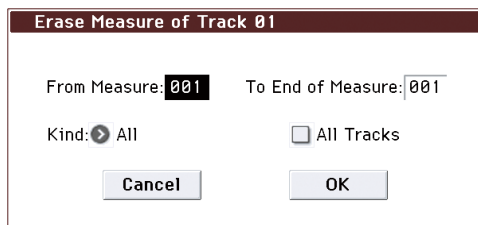

3. In **From Measure** select the first measure to be erased, and in **To End of Measure** select the last measure to be erased.

(By default, **From Measure** and **To End of Measure** will be set to the range that you specified in the Track Edit page.)

4. If you are erasing MIDI data, use **Kind** to specify the type of data that will be erased.

All will erase all types of data in that track, **Note** will erase note data, **Control Change** will erase control change data,

After Touch will erase both channel pressure and poly key pressure data, **Pitch Bend** will erase pitch bend data, **Program Change** will erase program change data, and **Exclusive** will erase exclusive data.

5. Specify the track(s) on which you want to execute the command.

If you execute with **All Tracks** unchecked, the command will be executed only on the data of the track you selected in **Track Select**

If you check **All Tracks**, the command will be executed on the data of all tracks.

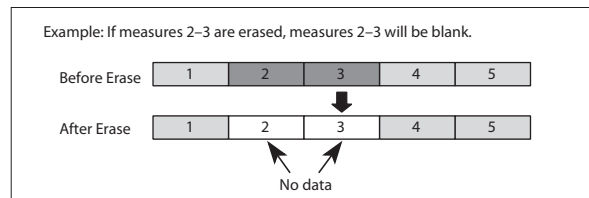

⚠ If control data extends across measures that were erased and measures that were not erased, only the data within the specified range will be removed.

⚠ However if note data extends across two or more measures, deleting any of the intervening measures will delete that note data from the following measures as well.

Note: Note data can also be erased using **Shift/Erase Note**. Use this command when you wish to erase a specific range of notes, or to erase notes from a specific **Beat.Tick**.

Note: Control Change data can also be erased using **Erase Control Data**. Use this when you wish to erase a specific type of control change, or to erase control change data from a specific **Beat.Tick** range.

Delete Measure

Delete Measure is available on all of the tabs of the Track Edit page.

This command deletes the specified measures.

When the **Delete Measure** command is executed, the musical data following the deleted measures will be moved towards the beginning of the sequence.

1. Use **Track Select** to select the MIDI track (Track 01–16) that contains the measures you want to delete.
2. Select “**Delete Measure**” to open the dialog box.

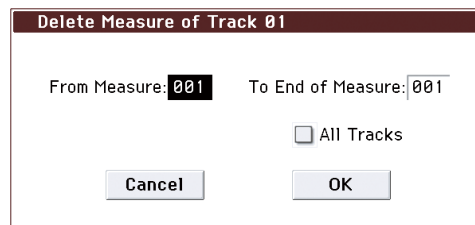

3. In **From Measure**, select the first measure that you wish to delete, and in **To End of Measure**, select the last measure that you wish to delete.

(By default, **From Measure** and **To End of Measure** will be the range that you specified in the Track Edit page.)

4. Specify the track(s) on which you want to execute the command.

If you execute with **All Tracks** unchecked, the command will be executed only on the data of the track you selected in **Track Select**.

If you check **All Tracks**, the command will be executed on the data of all tracks.

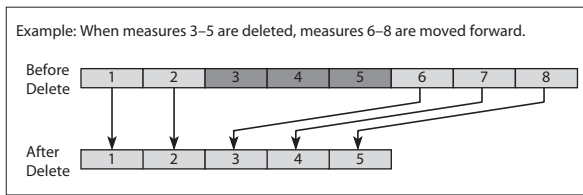

If in step 4 you uncheck **All Tracks** and execute this operation, the measures will not be deleted from the master track. Time signature and tempo data will remain unchanged, and the time signature and tempo of the measures that were moved forward as a result of the Delete operation will change.

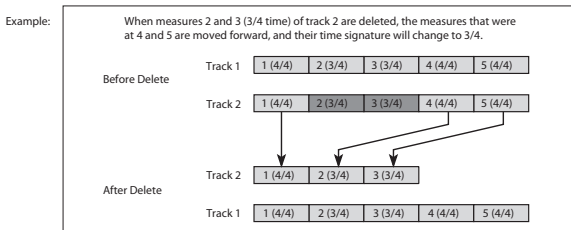

If in step 4 you check **All Tracks** and execute this operation, the specified measures of musical data will be deleted from all tracks including the master track, and the time signature and tempo will also move forward by the number of measures that were deleted.

If control data extends across a line between measures that were deleted and measures that were not deleted, only the data within the range being deleted will be erased.

Insert Measure

Insert Measure is available on all of the tabs of the Track Edit page.

This command inserts the specified number of measures into the specified track.

When you execute the Insert Measure command, the musical data following the insert location will be moved backward.

If you insert measures between note events that are connected by a tie, a note-off will be created immediately before the inserted measure, and the subsequent portion will be deleted.

1. Use **Track Select** to select the MIDI track (Track 01–16) in which you want to insert data.
2. Select “**Insert Measure**” to open the dialog box.

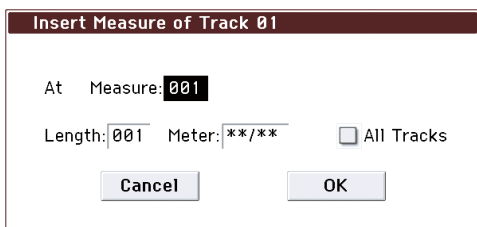

3. In **At Measure**, specify the measure location at which the data will be inserted.

(The measure you specified in Track Edit page **From Measure** will be set as a default.)

4. In **Length**, specify the number of measures that will be inserted.
5. In **Meter**, specify the time signature of the measures that will be inserted.

If you want the inserted measures to match the existing time signature, specify ****/****. With any setting other than ****/****, the

time signature of the inserted measures will change, and the specified time signature will apply to all tracks for those measures.

6. Specify the track(s) for which you want to execute the command.

If you execute with **All Tracks** unchecked, the measures will be inserted into the track that’s selected in **Track Select**. Be aware that at this time, the playback data that follows the insert location will move toward the end of the song according to the number of inserted measures, but the time signature and tempo will not move.

If you check **All Tracks**, the measures will be inserted into all tracks including the Master Track. The playback data in subsequent measures will play just as it did before this command was executed.

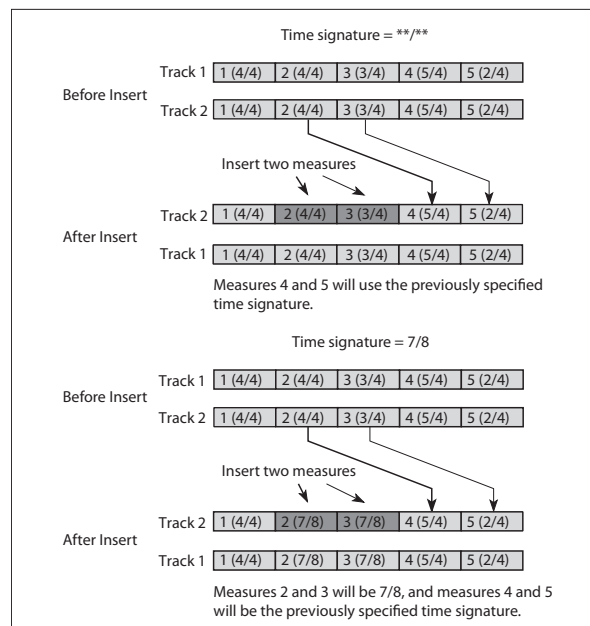

Repeat Measure

Repeat Measure is available on all of the tabs of the Track Edit page.

This command repeatedly inserts the specified measures for the specified number of times.

When you execute the Repeat Measure command, the measures will be inserted following the measure specified by **To End of Measure**, and musical data following the inserted data will be moved backward. It is convenient to use this command when you have a song that you play back with **Track Play Loop** (Seq P0–9(10)b) turned on, and wish to expand it into musical data.

1. Use **Track Select** to choose the MIDI track (Track 01–16) that you want to insert data into.
2. Select “**Repeat Measure**” to open the dialog box.

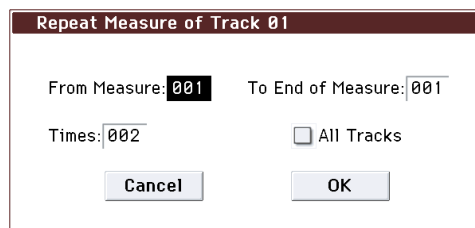

3. In **From Measure** and **To End of Measure**, specify the range of measures that will be repeated.

(By default, **From Measure** and **To End of Measure** will be set to the range you specified in the Track Edit page.)

4. In Times, specify the number of repetitions.

For example if you set **From Measure** to 001, **To End of Measure** to 004, and **Times** to 2, the musical data of measures 1–4 will be inserted into measures 5–8. The result will be that measures 1–4 will be played twice.

5. Specify the track(s) on which you want to execute the command.

If you execute with **All Tracks** unchecked, the performance data will be inserted into the track you specified in **Track Select**. Be aware that in this case, the performance data following the insert position will move backward (i.e., toward the end of the song) by the number of inserted measures, but the time signature and tempo will not move.

If you execute with **All Tracks** checked, the performance data will be inserted into all tracks, including the master track. The performance data following the inserted measures will play back in the same way as it did before.

Copy Measure

Copy Measure is available on all of the tabs of the Track Edit page.

This command copies the measures of musical data specified as the **From** source to the beginning of the measure specified as the **To** location.

When you execute the Copy Measure command, the existing track data at the copy destination will be rewritten.

1. Select the copy source song.
2. Select “Copy Measure” to open the dialog box.

3. In From: Track select the copy source track.

(By default, this will be the track you selected in **Track Select**.)

If you execute with **All Tracks** unchecked, only the selected track will be copied. Note that the time signature and tempo will not be copied.

If you check **All Tracks**, the musical data of all tracks including the master track will be copied.

4. In From Measure and To End of Measure, specify the range of copy source measures.

(By default, **From Measure** and **To End of Measure** will be the range that you specified in the Track Edit page.)

5. Use **To: “Song”** to specify the copy-destination song, **“Track”** (if **All Tracks** is unchecked) to specify the copy-destination track, and **Measure** to specify the starting measure at which the copied data will be inserted.

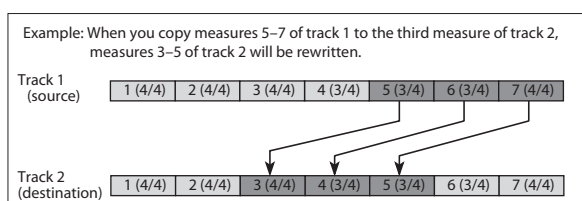

Move Measure

This command moves the specified measures of performance data to another measure.

1. Select “Move Measure” to open the dialog box.

2. In From: Track select the move source track.

(By default, this will be the track you selected in **Track Select**.)

If **All Tracks** unchecked, only data from the selected track will be moved.

If you check **All Tracks**, musical data of all tracks including the master track will be moved.

3. In From Measure and To End of Measure, specify the range of measures that will be moved.

(By default, **From Measure** and **To End of Measure** will be the range that you specified in the Track Edit page.)

4. In **To: Track** (if **All Tracks** is unchecked) to specify the move-destination track, and **Measure** to specify the measure at which the data will be inserted.

If you execute this with **Mode Stay**, playback data located after the move-source measures and playback data located after the move-destination measures will not move; it will stay where it is.

If you execute this with **Mode Shift**, playback data located after the move-source measures will move toward the beginning of the song by the number of measures that were moved. Playback data located after the move-destination measures will move toward the end of the song by the number of measures that were moved.

5. Set **“Overlap”** to specify what will happen if there is data in the move-destination measures and you’ve specified **“Mode” Stay**. If you choose **Merge**, the move-source data and move-destination data will be combined. If you choose **Overwrite**, the move-source data will overwrite (replace) the move-destination data.

Be aware that time signature and tempo data will not be moved.

6. To execute the Move Measure command, press the **OK** button. To cancel, press the **Cancel** button.

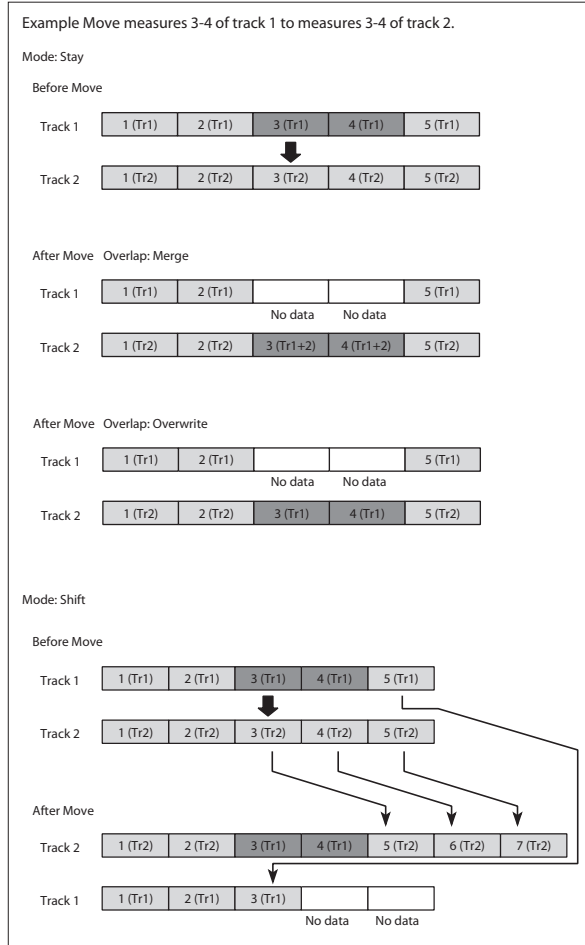

Create Control Data

Create Control Data is available on all of the tabs of the Track Edit page.

This command creates the specified type of data (control change, aftertouch, pitch bend, or tempo) in the selected region of a track.

1. In Track Select, select the MIDI track on which you wish to perform the Create Control Data command.

If you wish to modify tempo data, select **Master Track** as the track. In this case, the step 4 item **Kind** will be set to **Tempo**.

2. Select "Create Ctrl Data" to open the dialog box.

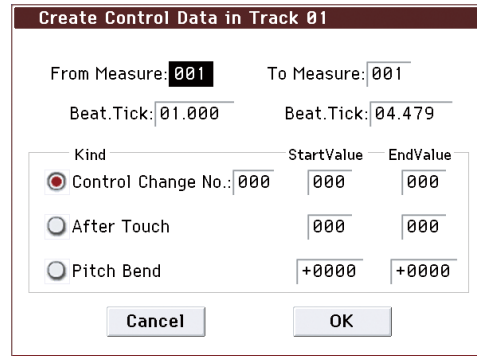

3. Specify the range into which the control data will be inserted.

In **From Measure** and **To End of Measure**, specify the measures, and in **Beat.Tick**, specify the beat and clock. (By default, **From Measure** and **To End of Measure** will be set to the range you specified in the Track Edit page.)

4. Set "Kind" to the type of musical data (event) that you wish to create.

Control change: Control change data will be inserted. In this case, use # to specify the control change number.

After Touch: Aftertouch data will be inserted.

Pitch Bend: Pitch bend data will be inserted.

Tempo: Tempo data will be inserted (if you've selected the master track).

5. In **Start Value**, select the starting value of the control data. In **End Value**, select the ending value of the control data.

By default, the **Start Value** will be set to the value of the existing data at the start location. If you wish to create control data that changes smoothly from the starting location, you can leave the **Start Value** unchanged, and set only the **End Value**.

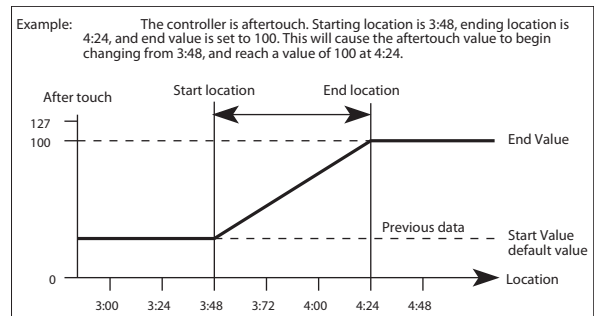

⚠ When you execute Create Control Data, a large amount of sequencer memory will be consumed. For this reason it may not be possible to execute this command if there is a limited amount of memory remaining. In such cases, first use **Quantize** to quantize the data and remove unnecessary control data. Alternatively, you could quantize the data that was inserted by the Create Control Data command.

Erase Control Data

Erase Control Data is available on all of the tabs of the Track Edit page.

This command erases data such as control changes, after touch, pitch bend, or tempo in the specified range.

1. In **Track Select**, select the track from which you wish to erase control data.

If you wish to erase tempo data, select **Master Track**. In this case, the **Kind** item in step 4 will be **Tempo**.

2. Select "Erase Ctrl Data" to open the dialog box.

3. Specify the range from which you wish to erase control data.

In **From Measure** to **To End of Measure** specify the measures, and in **Beat.Tick** specify the beat and clock. (By default, **From Measure** and **To End of Measure** will be the range that was specified in the Track Edit page.)

4. Set "Kind" to the type of musical data (event) that you wish to erase.

Control change: Control change data will be erased. In this case, use # to specify the control change number.

After Touch: Aftertouch data will be erased.

Pitch Bend: Pitch bend data will be erased.

Tempo: Tempo data will be erased. (If you've selected the master track)

Note: If you wish to erase all control change data from specified measures, you can also use **Erase Measure** and set **Kind** to **Control Change**. However, this **Erase Control Data** command allows you to specify the range using **Beat.Tick**, and also to erase only specific types of control change data.

Quantize

Quantize is available on all of the tabs of the Track Edit page.

This command corrects the timing of MIDI data of the type you specify (note data, control change, aftertouch, pitch bend, program change, etc.) in the track.

When you execute the Quantize operation, the musical data will be affected as follows:

- When you execute Quantize on note data, the timing of the note-on will be corrected, but the length (duration of the note) will not be affected.
- If the Quantize resolution is set to **Hi**, the timing will be adjusted to units of the base resolution ($\frac{1}{480}$), so note data will not be affected. However, continuous controller data such as joystick or after touch which occupies a large amount of memory will be processed so that two or more data events of an identical type existing at a single interval of the timing resolution will be combined into a single event, thus conserving memory.

Similarly, two or more identical data events existing at the exact same time will be combined into one, also conserving memory.

1. In **Track Select**, specify the track.
2. Select "Quantize" to open the dialog box.

3. Specify the range that will be quantized.

In **From Measure** and **To End of Measure**, specify the measures. In **Beat.Tick** specify the beat and clock. (By default, **From Measure** and **To End of Measure** will be the range that you specified in the Track Edit page.)

4. In **Kind**, select the type of musical data (events) that you wish to quantize.

All: Quantization will be applied to all performance MIDI data.

Note: Quantization will be applied only to note data. Use **Bottom** and **Top** to specify the range of notes. **Bottom** specifies the lowest note that will be affected, and **Top** specifies the highest note. You can use this when you want to quantize only a specific note or notes (for example, just the snare sounds of a drum track). If you want to quantize all notes, set these parameters **C-1** and **G9** respectively.

Control Change: Quantization will be applied to control changes. If you want to quantize only a specific control change, specify the number (**No.**). If you want to quantize all control changes, select **All**.

After Touch: Quantize both Channel Pressure and Polyphonic Key Pressure messages.

Pitch Bend: Pitch bend data will be quantized.

Program Change: Program change data will be quantized.

5. In **Resolution**, specify the timing resolution to which the data will be corrected.

By setting a lower resolution you can save more memory, but the timing of the playback may not be acceptable.

6. In **Offset**, specify the number of clock ticks by which the data will be moved forward or backward relative to the standard timing.

A setting of 240 will be ♩, and 120 will be ♪. Positive (+) settings will adjust the data forward, and negative (-) settings will adjust the data backward. This allows you to simulate “pushing” or “dragging” the beat.

7. In **Intensity**, specify the degree of sensitivity to which the timing will be corrected; i.e., how close to the locations specified by steps 5 and 6 the data will be moved.

With a setting of 0, no correction will take place. With a setting of 100, the data will be moved all the way to the timing intervals specified by steps 5 and 6.

8. Use **Swing** to add a sense of swing to the rhythm. For example, this provides an easy way to give a slight shuffle groove to a “square” 16-beat rhythm.

Settings other than 0% will add a sense of swing by adjusting the position of the notes at even-numbered beats relative to the specified **Resolution**. With a setting of +100%, these notes will be moved one third of the way toward intervals of the specified **Resolution**. With a setting of +300%, notes of even-numbered beats will be moved all the way to the next even-numbered beat.

* By varying the **Offset** and **Intensity** settings you can create quantize effects such as the following.

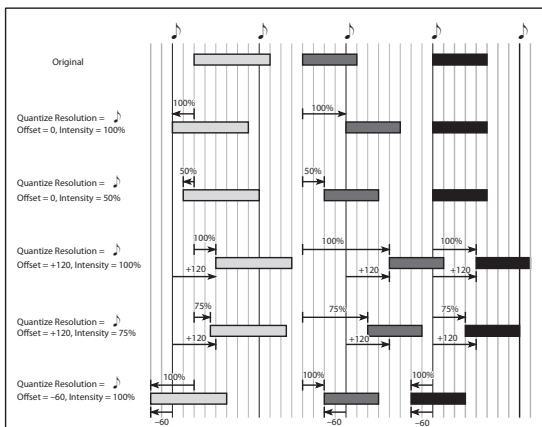

* By varying the **Swing** settings you can create effects such as the following.

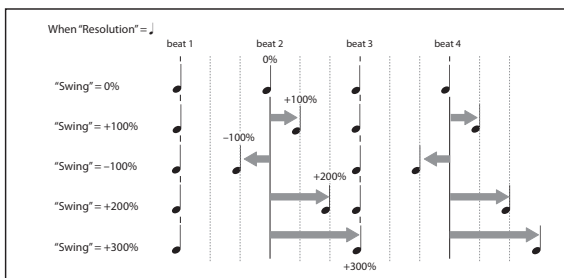

Shift/Erase Note

Shift/Erase Note is available on all of the tabs of the Track Edit page.

This command shifts (moves) or erases specified note numbers in a selected track and over a range of measures.

1. In **Track Select**, choose the MIDI track on which you wish to execute the **Shift/Erase Note** command.
2. Select “**Shift/Erase Note**” to open the dialog box.

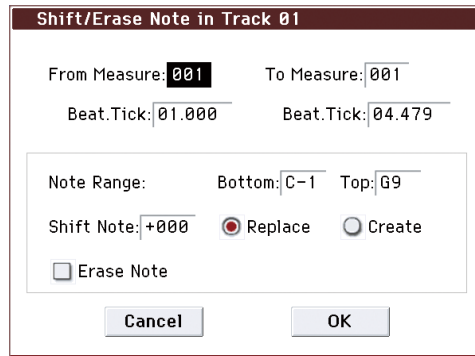

3. Specify the range in which you wish to shift or erase note numbers.

In **From Measure** and **To End of Measure**, specify the measures. In **Beat.Tick**, specify the beat and clock. (By default, **From Measure** and **To End of Measure** will be the range that you specified in the Track Edit page.)

4. Specify the range of notes that you wish to shift or erase.

Note Range: Bottom specifies the lower limit, and **Top** specifies the upper limit. If you wish to edit all notes, set **Bottom** to C-1 and **Top** to G9.

• Shifting notes

5. In **Shift Note**, specify the amount by which you wish to move the note.

The amount of shift is set in semitone steps over a range of -127 to +127. +1 will shift the note a semitone upward.

6. Select either **Replace** to move the note numbers, or **Create** to generate additional notes.

For example if you are editing a track that uses a drum program, you can use **Replace** to exchange the current snare sound for a different snare sound assigned to a different key, or use **Create** to add a sound effect at a different note # to the snare sound. Alternatively, you can use **Create** to add an octave doubling to an existing guitar phrase, etc.

7. To execute the **Shift Note** command, press the **OK** button. To cancel, press the **Cancel** button.

• Erasing notes

8. Check **Erase Note**.

If you wish to erase all note data in the specified range of measures, you can also use the **Erase Measure** command and set **Kind** to **Note**. However, this **Shift/Erase Note** command lets you specify the **Beat.Tick** range, and to erase only specific ranges of note data.

Modify Velocity

Modify Velocity is available on all of the tabs of the Track Edit page.

This command modifies the velocity values of notes in the specified area so that they will change over time according to a selected curve.

1. In **Track Select**, specify the track whose velocity will be modified.
2. Select **"Modify Velocity"** to open the dialog box.

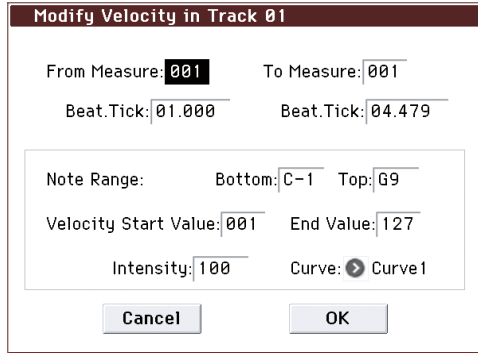

3. Specify the range in which note velocity will be modified.

From Measure and **To End of Measure** specify the measure, and **Beat.Tick** specify the beat and clock. (By default, **From Measure** and **To End of Measure** will be set to the range that you specified in the Track Edit page.)

4. Specify the range of notes that will be affected by the **Modify Velocity** command.

Note Range: **Bottom** is the lower limit, and **Top** is the upper limit. If you wish to edit all notes, set **Bottom** to C-1 and **Top** to G9.

5. In **Velocity Start Value**, specify the value at which the velocity data will start, and in **End Value**, specify the final velocity value.
6. In **Intensity**, specify the degree to which the velocity data will be adjusted toward the curve you specify in step 7.

With a setting of 0 [%], the velocity will not change. With a setting of 100 [%], the velocity will be exactly as described by the curve.

7. **Curve** lets you select from six types of curve to specify how the velocity will change over time.

* The six curves are as follows.

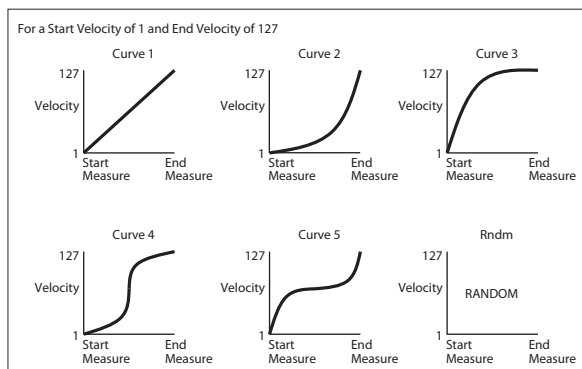

Create Exclusive Data

This command creates universal system exclusive messages or KROME parameter change messages in the specified region of a MIDI track.

1. Use **Track Select** to specify the MIDI track in which you want to create exclusive data.
2. Choose **Create Excl Data** to open the dialog box.

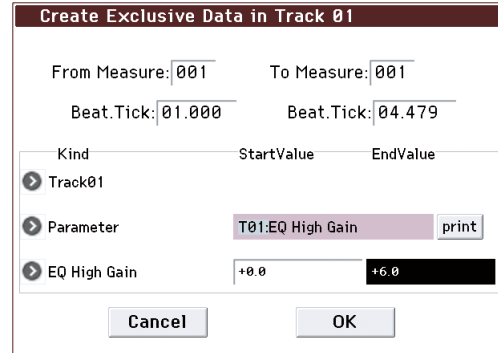

3. Specify the region into which you want to insert universal system exclusive messages or KROME parameter change messages.

Use **From Measure** and **To Measure** to specify the measures, and **Beat.Tick** to specify the beat and clock. (By default, **From Measure** and **To Measure** will be set to the region you specified in the Track Edit page.)

4. Use **Kind** to specify the type of universal system exclusive message or KROME parameter change message that you want to create.

For more information, please see "Universal system exclusive" on page 365.

5. Use **Start Value** to specify the starting value of the universal system exclusive message or KROME parameter change message, and **End Value** to specify the ending value.
6. Press the **OK** button to execute the **Create Exclusive Data** operation. If you decide not to execute, press the **Cancel** button.

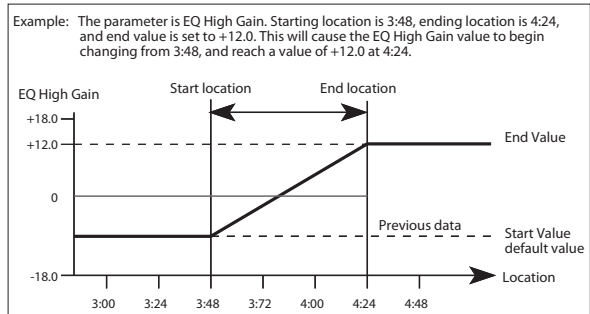

Erase Exclusive Data

This command erases (deletes) universal system exclusive messages or KROME parameter change messages from the specified region.

1. Use **Track Select** to specify the MIDI track from which you want to erase exclusive data.
2. Choose **Erase Excl Data** to open the dialog box.

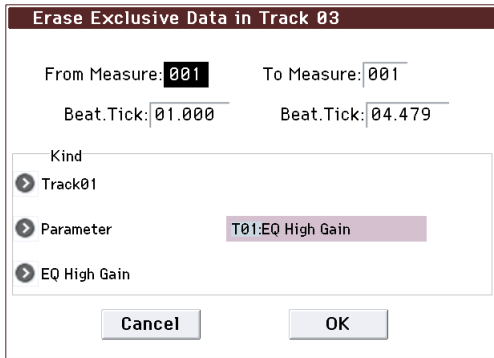

3. Specify the region from which you want to erase universal system exclusive messages or KROME parameter change messages.

Note: Use **From Measure** and **To Measure** to specify the measures, and **Beat.Tick** to specify the beat and clock. (By default, **From Measure** and **To Measure** will be set to the region you specified in the Track Edit page.)

4. Use **Kind** to specify the type of universal system exclusive message or KROME parameter change message that you want to erase.

For more information, please see "Universal system exclusive" on page 365.

5. Press the **OK** button to execute the **Erase Exclusive Data** operation. If you decide not to execute, press the **Cancel** button.

If you want to erase all universal system exclusive messages or KROME parameter change messages from specified measures in a single operation, you can use **Erase Measure** with **Kind** set to **Exclusive**; however in that case, you won't be able to use **Beat.Tick** when specifying the range for erasure.

Copy Insert Effect

Copy Insert Effect is available on all of the IFX pages.

For more information, please see "Copy Insert Effect" on page 66.

However, the MIDI control channel specified in **Ctrl Ch** of the IFX 1–5 page will not be copied.

Swap Insert Effect

Swap Insert Effect is available on all of the IFX pages.

For more information, please see "Swap Insert Effect" on page 67.

However, the MIDI control channel specified in **Ctrl Ch** of the IFX 1–5 page will not be swapped.

DrumKit IFX Patch

For more information, please see "DrumKit IFX Patch" on page 104.

Copy MFX/TFX

Copy MFX/TFX is available on all of the MFX/TFX/LFO pages.

For more information, please see "Copy MFX/TFX" on page 67.

However, the MIDI control channel specified in **Ctrl Ch** of the MFX 1–TFX page will not be copied.

Swap MFX/TFX

Swap MFX/TFX is available on all of the MFX/TFX/LFO pages.

For more information, please see "Swap MFX/TFX" on page 67.

However, the MIDI control channel specified in **Ctrl Ch** of the MFX 1–TFX page will not be swapped.

Write FX Preset

Write FX Preset is available on all of the effects parameter editing pages, including IFX 1–5, MFX 1 and 2, and TFX.

For more information, please see "Write FX Preset" on page 67.

Put Effect Setting to Track

Put Effect Setting to Track is available on all of the IFX and MFX/TFX/LFO pages.

This command inserts effect settings into a track as exclusive events. You can use this to make the effect settings change during a song.

⚠ When you use System Exclusive messages to change effect settings, a certain amount of time will be required for the effect to switch. Also, if a note is playing, the sound may not change smoothly. You should take into account the timing of the musical data when choosing where to insert System Exclusive messages.

Note: If you switch effects during a song, you should also use this command to insert an effect change at the beginning of the track (**Measure 001**, **Beat.Tick 01.000**) to select the effect that will be used from the beginning.

1. Use **P8: Routing/IFX** or **P9: MFX/TFX/LFO** to edit the effect settings that you want to insert (IFX1–IFX5, MFX1, MFX2, TFX), and determine the song, track, measure, beat, and clock at which you will insert the exclusive event.

The illustration below shows the example of switching IFX4 (used by track 2) at the beginning of measure 9.

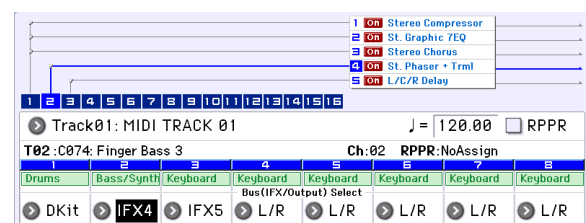

2. Select "Put Effect Setting to Track" to open the dialog box. (The values in the dialog box are settings for the example described in step 1.)

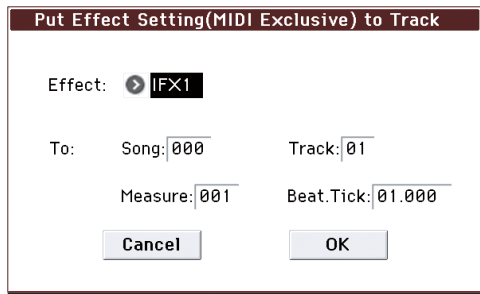

3. Use Effect to select the desired effect.
4. Use To: Song to specify the song into which the settings will be inserted, Track to specify the insert-destination track, Measure to specify the measure and Beat.Tick to specify the beat and clock at which the settings will be inserted.

 The inserted events are only the effect type and effect parameters. Settings such as effect on/off and bypass must be recorded in real time.

Note: Turn back the Location, and play the song to verify that the effect is switched as you intend.

You can also use the P6: Track Edit menu command **Event Edit** to verify that a parameter change System Exclusive message (Exclusive) has been inserted.

Note: If a pattern had been inserted at the same location (where you inserted the exclusive data), that pattern will be expanded to note data.

Using “Put Effect Setting to Track” to switch effects

The **Put Effect Setting to Track** menu command inserts effect settings into a track as exclusive event data. We'll explain this using two methods as examples.

1) Inserting effect settings at the beginning and in the middle of a song

We'll set things so that MIDI track 2 uses the insert effect (IFX3) 035: Stereo Phaser from measures 1 through 8, and switches to 032: Stereo Flanger from measure 9.

Use the menu command **Put Effect Setting to Track** to insert a MIDI parameter change System Exclusive message.

1. In P0-1: Play/REC- Program T01-08, select the desired program for MIDI track 2.

If you set **Track Select** to Track 02, you'll be able to monitor it.

2. In P8: Routing/IFX- Routing T01-08, send MIDI track 2 to IFX3.

3. Specify the effect that you want to use from measure 1.

In P8: Routing/IFX- Insert FX Setup, select 035: Stereo Phaser for IFX3. Press the On/Off button to turn on the IFX3.

In P8:Routing/ IFX- IFX3, set the parameters as desired.



4. Make sure that you've selected Track 02 in Track Select, and record as desired.

5. In the P8: Routing/IFX page, select the menu command **Put Effect Setting to Track** to access the dialog box.
6. Specify the location at which the exclusive message for the effect will be inserted.

Effect: IFX3
 To: Song: 000
 Track: 03
 Measure: 001
 Beat.Tick: 01.000

7. Press the OK button.
8. Specify the effect that you want to use for measure 9 and following.

Go to the P8: Routing/IFX- Insert FX setup, and choose 032: Stereo Flanger for IFX3.

In the P8: Routing/IFX- IFX3, set the parameters as desired.

9. In the P8: Routing/IFX, choose the **Put Effect Setting to Track** menu command to open the dialog box.
10. Specify the location at which the exclusive message for the effect will be inserted.

Effect: IFX3
 To: Song: 000
 Track: 03
 Measure: 009
 Beat.Tick: 01.000

11. Press the OK button.
12. When you play back after executing these commands, the effect on track 3 will change to 032: Stereo Flanger at measure 9.
13. If you press the COMPARE button (it will light up) and play back, the playback will occur as it did before you executed **Put Effect Setting to Track**.
14. In the P6: Track Edit- Track Edit page, set **Track Select to Track 03**, and choose the **Event Edit** menu command to access the event edit screen. (In the Set Event Filters dialog box, check Exclusive.)

Notice that a MIDI parameter change System Exclusive message is inserted at the beginning and at measure 9 of track 3.

2) Using the song's own effect settings from the beginning of the song, and inserting effect settings from elsewhere into the middle of the song

In this example, we'll apply an insert effect (IFX3) to MIDI track 3, and set our parameters so that it uses 035: Stereo Phaser from the beginning of the song. At measure 9, we'll insert a MIDI parameter change System Exclusive message to make IFX3 switch to the 032: Stereo Flanger effect settings that were created for a different song.

1. Select a desired program for MIDI track 3, and send it to IFX3.

Make the following settings for MIDI track 3.

Track Select: Track 03 (P0)
Bus (IFX/Output) Select: IFX3 (P8)

In the P0-1: Play/REC- Program T01-08 page, assign a program to track 3. Then use the P8: Insert Effect page to route track 3 to the effect, and make effect settings.

2. Make sure that you've selected Track 03 in Track Select, and record on it.
3. On a separate song you copied, make the effect settings that you want start using at measure 9.

- 1) Create song S001.

2) Use the **Copy From Song** menu command to copy from S000.

In song 001, make the effect settings that you want to use from measure 9. Go to the P8: Routing/IFX– Insert FX Setup, and choose 032: Stereo Flanger for IFX3.

In the P8: Routing/IFX– IFX3, set the parameters as desired.

4. **Select “Put Effect Setting to Track” to open the dialog box.**

5. **Insert the effect settings you created in song 001 into song 000.**

Effect: IFX3
 To: Song: 000
 Track: 03
 Measure: 009
 Beat.Tick: 01.000

6. Press the OK button to execute the command.

7. **After execution, select song 000 and play it back. The effect for track 3 will change to 032: Stereo Flanger at measure 9.**

8. **In song 000, you can press the COMPARE button (it will light up) and play back to hear the song as it was before you executed Put Effect Setting to Track.**

You can use the COMPARE button to compare the state of the track before and after execution.

Note: In the P6: Track Edit– Track Edit page of song 000, set **Track Select** to Track 03 and choose the **Event Edit** menu command to access the Event Edit screen. (In the Set Event Filters dialog box, check **Exclusive**.)

Notice that a MIDI parameter change System Exclusive message is inserted at measure 9 of track 3.

Step Recording (Loop Type)

Here, you can perform step recording into a pattern.

This is available when a user pattern is selected.

1. **In Pattern (Pattern Bank) and Pattern Select, specify the pattern.**

By default, the pattern length is one measure. If you wish to change the number of measures in the pattern, set the **Pattern Parameter**.

2. **Select “Step Recording (Loop Type)” to open the dialog box.**

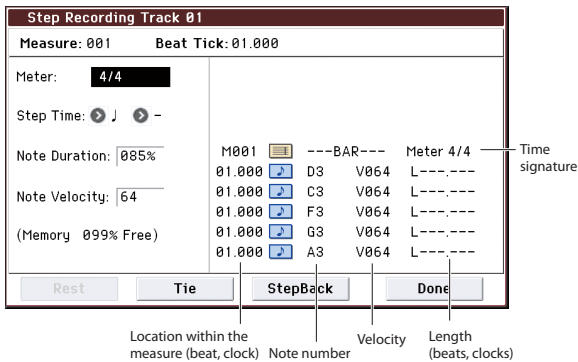

3. **The remaining steps are the same as when step recording on a track.**

Refer to steps 3 and following in **Step Recording** (see “Step Recording” on page 167). However, step recording a pattern differs from step recording a track in that when you reach the end of the pattern, you will return to the beginning and continue recording, in this way continuing to add more data.

Event Edit

Here, you can edit individual events of the musical data in a pattern.

Use **Pattern** and **Pattern Select** to specify the pattern, and then select this command.

The remaining steps are the same as when Event Editing a track. For more information, please see “Event Edit” on page 169.

Piano Roll

This is the piano roll dialog box for entering a pattern. The Piano Roll dialog box provides a detailed graphic view of event data such as notes, velocities, and control changes. Here you can also modify, delete, or create these events.

Pattern Parameter

This command specifies the number of measures and the time signature of the selected pattern.

1. Use **Pattern** and **Pattern Select** to specify the pattern.
2. Select “Pattern Parameter” to open the dialog box.

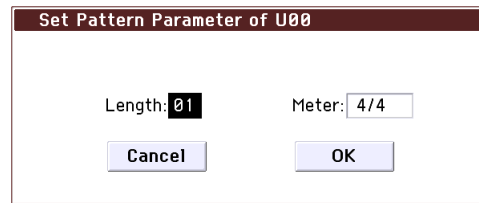

3. **In Length, specify the number of measures in the pattern.**

4. **In Meter, specify the time signature of the pattern.**

However, this time signature is only temporary, and when you “put” or “copy” the pattern in a track of a song, the pattern will play according to the time signature of that measure.

Erase Pattern

This command erases the data from the selected pattern.

1. Use **Pattern** and **Pattern Select** to specify the pattern.
2. Select “Erase Pattern” to open the dialog box.

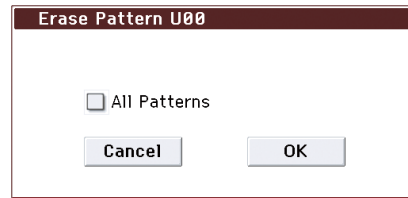

3. **If you check All Patterns, all user patterns in the song will be erased.**

If **All Patterns** is **not** checked, only the pattern specified in step 1 will be erased.

Copy Pattern

This command copies the settings and musical data of the selected pattern to another pattern.

User patterns belong to a particular song, but you can use the Copy Pattern command to use the same pattern in another song.

Although preset patterns cannot be edited, you can copy a preset pattern to a user pattern. There, you can edit and save

it as a user pattern. Be aware that when you execute the Copy Pattern operation, the pattern settings and musical data of the copy destination will be erased.

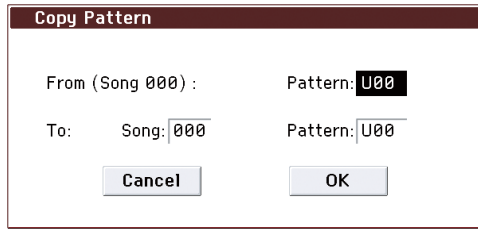

1. In **From (Song***)**: **Pattern**, specify the copy source pattern. (By default, this will be the song and pattern that was selected in the Pattern Edit page.)
2. In **To**: **Song** and **Pattern**, specify the copy destination song and pattern.

For **Pattern**, only user patterns U00–U99 can be specified.

Bounce Pattern

This command combines the musical data of a source pattern and a destination pattern, and places the combined musical data in the destination. The time signature and length of the pattern following execution will be according to the settings of the destination pattern. Unlike the Track Bounce operation, the musical data of the bounce source will not be erased.

If MIDI control data exists in the selected pattern and in the bounce destination pattern, the resulting playback following the bounce operation may produce unexpected results. We recommend that you use **Event Edit** to prepare the MIDI control data of the two patterns before executing the Bounce Pattern command.

1. **Pattern** and **Pattern Select** to specify the bounce source pattern.
2. Select **"Bounce Pattern"** to open the dialog box.

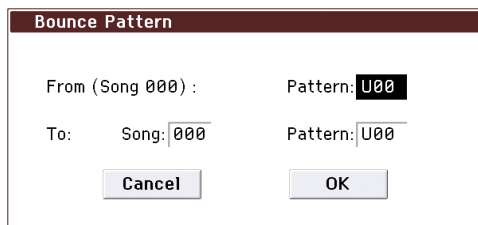

3. In **From (Song***)** **Pattern**, select the bounce source pattern. (By default, the song and pattern that are selected in the Pattern Edit page will be chosen.)
4. In **To**: **Song** and **Pattern**, select the bounce destination song and pattern. For **Pattern**, only user patterns U00–U99 can be specified.

Get From Track

This command takes musical data from a track and loads it into the specified pattern.

1. Use **Pattern** and **Pattern Select** to specify the pattern.
2. In **Pattern Parameter**, specify the pattern length of the "get" destination.
3. Select **"Get From Track"** to open the dialog box.

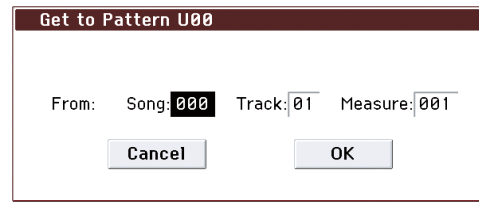

4. In **Song**, select the "get" source song.
5. In **Track**, select the "get" source track.
6. In **Measure**, specify the first measure of the "get" source.

Put To Track

This command places a pattern into a track.

Unlike the **Copy to Track**, this command only places the pattern number in the song, so that when playback reaches that point, the pattern will be recalled. The musical data of the pattern will not actually exist in the track.

By creating patterns that contain frequently-used phrases or drum patterns, and then placing them on the tracks, you can conserve memory.

Be aware that when you edit a pattern, all locations in the song where that pattern has been placed will be affected.

When you execute the Put to Track command, the musical data will be affected as follows.

- Musical data previously existing at the "put" destination will be erased.
- The pattern that you "put" will playback according to the time signature that is specified by the measures of the "put" destination.
- Control data such as pitch bend etc. previously existing in the track will be reset immediately before the measure at which the pattern was "put." If you wish to use control data such as pitch bend in the measures in which a pattern is "put," you must first write the control data into the pattern (see "Control data in pattern recording" on page 156).

To delete a pattern that has been placed in a track you can use **Erase Measure**, specifying the area in which the pattern was "put," and setting **Kind** to **All**.

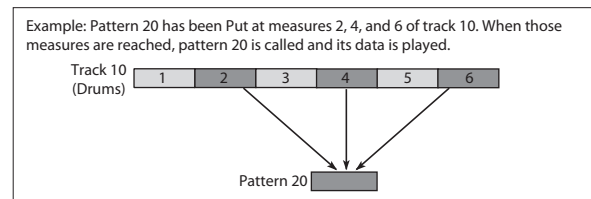

1. Select **"Put To Track"** to open the dialog box.

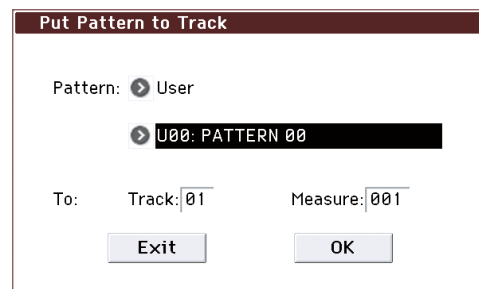

2. In **Pattern** and **Pattern Select**, select the "put" source pattern. (By default, this will be the pattern selected in the Pattern Edit page)
3. In **To**: **Track**, select the "put" destination track.

4. In Measure, specify the first measure of the “put” destination.

When you execute the command, **Measure** will automatically update. If you wish to, you can continue “putting” the pattern. To exit the command, press the **Exit** button.

Copy To Track

This command copies the specified area of musical data from the specified pattern to a track as musical data.

Unlike the Put To Track command, this command actually writes the musical data of the pattern into the track, so that you can edit the copied data in the track. Even if you later edit the copy source pattern, the musical data of the song will not be affected.

When you execute the Copy to Track command, the musical data will be affected as follows.

- Musical data previously existing in the copy destination measures will be erased.
- The musical data that is copied will play back according to the time signature specified at the copy destination measures.

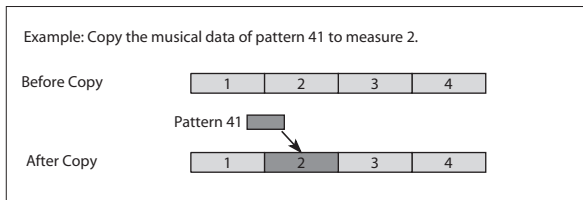

The procedure is the same as for the Put to Track command. For more information, please see “Put To Track” on page 1879.

Convert to Drum Trk Pattern

This command converts a user pattern into a user drum track pattern. This conversion lets you use a user pattern in the drum track of the various modes. The drum track pattern you convert here will be preserved in the KROME's memory even when the power is turned off, so you can manage it together with the programs and combinations.

Preparing a user pattern

You'll first need to prepare the user pattern that you want to convert to a Drum Track pattern.

To create a user pattern, you can realtime-record it in the Seq P10: Pattern/RPPR– Pattern Edit page, or step-record it (see OG p.71, and page 198).

Alternatively, performance data from a track can be imported into a pattern, meaning that performance data you've created in a track or SMF data you've loaded in Media mode can be used as a user pattern. To do this, execute the **Get From Track** menu command in the Seq P10: Pattern/RPPR– Pattern Edit page (see p.155).

Converting to a Drum Track pattern

1. Press the **SEQ** button to enter Sequencer mode.
2. Access the Seq P10: **Patern/RPPR– Pattern Edit** page.
3. Use **Pattern** and **Pattern Select** to select the conversion-source pattern.
4. Select “**Convert to Drum Trk Pattern**” to open the dialog box.

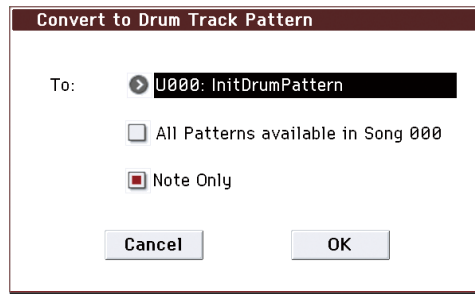

5. Use the **To Drum Track Pattern Select** field to specify the destination user drum track pattern number. When you execute this command, the data will be overwritten onto the copy-destination number.
6. If you check the **All Patterns available in Song ***** item, all patterns in the song that contain note events will be copied, starting at the number you specified in step 3.
7. If you execute with **Note Only** checked, only the note events will be copied.

Press the OK button or the ENTER button to execute. If you decide not to execute, press the Cancel button or the EXIT button.

As described in “Drum Track function settings in Program mode” on page 100 of the Operation guide, set the Drum Track **Pattern Bank** to User, and set **Pattern No.** to the user Drum Track pattern you converted. Then play the Drum Track pattern.

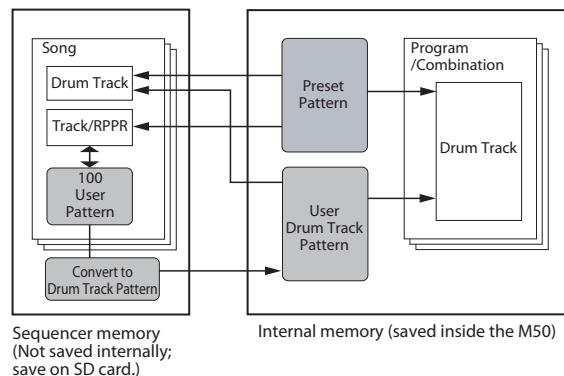

⚠ If there is insufficient drum pattern memory or insufficient pattern locations, an error message of “Not enough Drum Track pattern memory” or “Not enough Drum Track pattern locations available” will appear, and the command cannot be executed.

Tip: It's a good idea to convert drum patterns that you use frequently. Use **Load Drum Track Pattern** to load them.

Load Drum Track Pattern

This command loads a user drum track pattern into a user pattern.

If you want to edit a user drum track pattern, you must first load it into a pattern in the song, and then edit it. After editing, you can use **Convert to Drum Trk Pattern** to save it as a user drum track pattern.

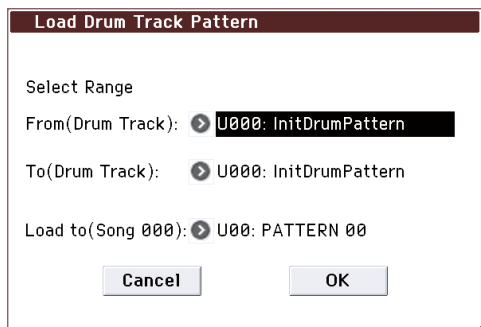

1. Use **Select Range From (Drum Track) and To (Drum Track)** to specify the copy-source user drum track pattern.

The user drum track patterns between **From** and **To** will be loaded. If you want to load only one pattern, set **From** and **To** to the same pattern number.

When you execute this command, the data will be overwritten onto the copy-destination number.

2. Use **Load to (Song ***)** to specify the load-destination user pattern number.

Erase Drum Track Pattern

This erases the drum track pattern you specify.

For more information, please see "Erase Drum Track Pattern" on page 66.

Rename Cue List

This command renames the selected cue list. A name of up to 24 characters can be input. For more information, please see "Editing names" on page 91 of the Owner's manual.

Delete Cue List

This command deletes the currently selected cue list.

When you execute this command, the data of the currently selected cue list will be deleted.

Copy Cue List

This command copies the settings of another cue list to the currently selected cue list.

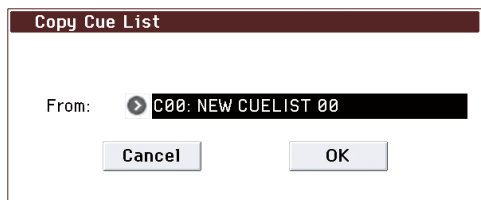

1. In **From**, specify the copy source cue list.

When you execute, the setting data of the selected cue list will be deleted, and replaced by the copy-source data.

Convert to Song (Convert Cue List to Song)

This command converts a cue list consisting of multiple songs to a single song. Although it is not possible to record additional tracks into a cue list, you can convert the cue list to a song, and then record solos etc. onto open tracks.

You will need to convert a cue list to a song if you wish to write it to an SD card as SMF data. During the conversion,

the track and effect settings of the song specified for **Step 01** will be copied to the beginning of the resulting song, and all track and effect settings of subsequent songs will use the settings of the song for **Step 01**.

Settings of the Tone Adjust function will not be reflected in this conversion.

1. Select the cue list (C00–C19) that you want to convert to a song.
2. Select "Convert to Song" to open the dialog box.

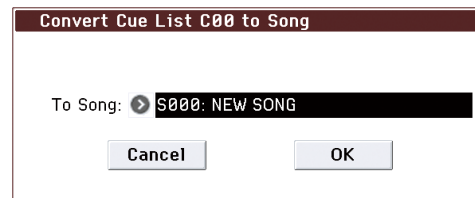

3. In **To Song**, specify the conversion destination song number.

If you select a new song, a confirmation dialog box will appear.

Press the OK button to create a new song, into which the cue list will be converted.

If you selected a song that already contains settings and performance data, executing this command will erase the data of that song and replace it with the data that was converted from the cue list. Use this command with caution.

After executing this command, you can press the COMPARE button to return to the state prior to execution.

The **Convert to Song** command converts a cue list to a song as described below.

- **Song/Track parameter settings for Step 01**

Song/Track parameters will use the settings of the **Step 01** song.

The MIDI channel of each track will be assigned according to the settings of the **Step 01** song. If **Step 02** and following songs have different settings, it may not be possible to achieve an acceptable playback result after conversion. As far as possible, try to keep the MIDI channel assignments consistent between songs you intend to use in a play list that will be converted into a song.

The following track parameters will not be reflected in the conversion. As with the MIDI channels, we recommend that you keep these settings consistent between all songs in the cue list.

SOLO ON/OFF, Status, MIDI Channel, Bank Select (When Status=EX2), Force OSC Mode, OSC Select, Use Program's Scale, MIDI Filter, Key Zone, Velocity Zone, Delay, and the track EQ settings

- **Converting Song/Track parameters into track events**

Second and subsequent repeats of the **Step 01** song, and the settings of **Step 02** and following songs will all be converted into track events (musical data).

The following data will be converted.

| | |
|--------------|---|
| Track1–16 | Program Select, Pan, Volume, Portamento, Detune, Bend Range |
| Master Track | Tempo, Meter |

If **Pan** (Seq 0–3(4)b) is **RDN**, it will be converted to **C064**. If **Portamento** (Seq 3–3(4)c) is **PRG**, or if **Bend Range** (Seq 3–5(6)c) is **PRG** or a **negative value**, these will not be reflected in the conversion.

In the case of a drum program, **Detune** (3–5(6)c) will be divided into RPN Fine Tuning and Coarse Tuning, and

converted to these events. For example, if the **Detune** setting of +600, Fine Tuning will be 00 and Coarse Tuning will be 6. Fine Tuning will modify the playback pitch (Detune). Coarse Tuning will change the notes that are played back (Transpose). In cases other than a drum program, the pitch setting will be applied by shifting the note numbers in the track and adding an RPN Fine Tuning event.

- **PLAY/MUTE (P0-1(2): Program T01-08, T09-16 Play/Rec/Mute)**

The **Play/Mute** track parameters will be reflected in the song. **Solo On/Off** will not be reflected.

- **Track Play Loop (P0-9(10): Ply Loop T01-08, T09-16 page)**

If **Track Play Loop** is on, the area from **Loop Start** to **Loop End** will be expanded as far as the last measure in the master track.

(Example)

If **Track Play Loop** is M005-M008, and the master track contains 10 measures, the data will be expanded from the beginning of the track as M005, 6, 7, 8, M005, 6, 7, 8, M005, 6.

- **Play Intro (P0-9(10): Ply Loop T01-08, T09-16 page)**

If **Track Play Loop** is on, the data will be developed according to the Play Loop setting until the last measure of the master track.

If **Play Intro** is checked, the data from the beginning of the track until **Loop End** will be developed, and then the data from **Loop Start** until **Loop End** will be developed until the last measure of the master track.

For example if **Track Play Loop** is M005-M008 and the master track ends at measure 10, checking **Play Intro** will cause the data to be developed from the beginning of the track as M001, 2, 3, 4, 5, 6, 7, 8, M005, 6, 7, 8, M005, 6.

If **Play Intro** is not checked, please see the example in **Track Play Loop**.

- **Patterns**

Patterns in the **Step 01** song will be copied as patterns of the converted song.

If there is a second or subsequent repeat for **Step 01**, or if the tracks of **Step 02** and subsequent songs contain patterns, they will be expanded into track events (musical data).

- **Transpose**

If the **Transpose** (Seq 3-5(6)c) of the tracks in **Step 02** and subsequent songs differ from the settings of the **Step 01** song, the note numbers of the note data will be shifted.

(Example)

If **Step 01, Transpose = +1** and **Step 02, Transpose -1**, the actual note numbers of the **Step 02** track note data will be shifted downward by 2.

- **Repeat FS (Foot Switch) → "Repeat" 1**

If **Repeat** is set to **FS (Foot Switch)**, it will be converted as **Repeat 1**.

When you execute **Convert to Song** to convert a cue list to a song, the repeat settings within the cue list and the pattern and track play loop settings of the songs used by the cue list will all be converted into events such as note data. For this reason, the amount of data will increase significantly, and in some cases there may not be enough internal memory to perform the conversion. In particular if the cue list uses long songs, or if numerous repeats have been specified, or if many patterns are used by the songs, you should try executing the **Convert to Song** command from time to time as you create the cue list, in

order to verify the amount of memory that will be required for the conversion.

A cue list that is longer than 999 measures cannot be converted into a song.

Copy Song

This command copies a portion (a number of measures) of the song specified by **Step**, and makes it into a song. This is convenient when you want to modify the structure or development of the songs in a cue list.

For example if you have an eight-measure song and want to repeat measures 5-8, you can use this command to create a four-measure song out of that portion. Then you can assign the resulting song to a step in a cue list, and repeat it.

1. In **Current Step**, or **Song** select the desired step.
2. Select "**Copy Song**" to open the dialog box.

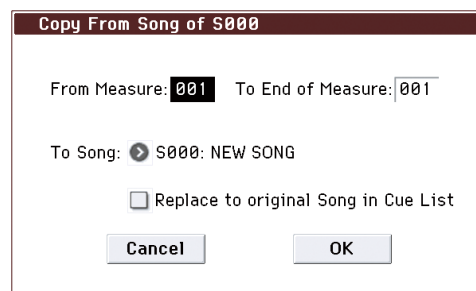

3. In **From Measure**, specify the first measure in the copy source song. In **To End of Measure**, specify the last measure.
4. In **To Song**, specify the song into which the data will be converted.

If you select a new song, a dialog box will ask you for confirmation. Press the OK button to create a new song and copy the data to that song.

If you select an existing song that already contains settings and/or musical data, executing this command will erase the data of that song and rewrite it with the data from the copy source. Before you execute, be sure that you will not be losing important data.

5. If you check **Replace to original Song in Cue List** and execute this command, the **Current Step** song will be replaced by the newly created song.

If you execute **without checking** this box, the newly created song can be selected later for the desired step of the cue list.

System Exclusive events supported in Sequencer mode

You can record and play back System Exclusive events, and edit tracks that contain System Exclusive events.

SysEx messages that can be recorded in real-time

The following exclusive messages can be recorded in real-time:

- Exclusive messages received from an external MIDI device
- Parameter changes in Sequencer mode (see table below)
- Master Volume universal exclusive messages assigned to the foot pedal or a Realtime Controls knob

Parameter change messages that you can realtime-record in Sequencer mode

| Front panel/Page | Parameter | |
|-----------------------|-------------------|---|
| Front panel | ARP | ARP button, SELECT button, REALTIME CONTROLS 1–4 knobs (GATE, VELOCITY, SWING, STEP) |
| | Drum Track | DRUM TRACK button |
| | Realtime Controls | SELECT button, REALTIME CONTROLS 1–4 knobs (TONE [CUTOFF], [RESONANCE], [SWING], [STEP], USER [1], [2], [3], [4]) |
| P0: Play/REC, Arp A/B | Program, Mixer | Program Select, Pan, Volume, PLAY/MUTE, Solo On/Off *1 |
| | Tone Adjust | All "Tone Adjust" parameters |
| P1: Controllers | Controllers Setup | All "Panel Switch Assign," "Realtime Controls knob Assign" parameters |
| P2: EQ | EQ Trim | Auto Load Prog EQ, Bypass, Input Trim, High Gain, Mid Frequency, Mid Gain, Low Gain |
| P3: Track Param | OSC | Force OSC Mode, OSC Select, Portamento |
| | Pitch | Transpose, Detune, Bend Range |
| | Scale | Use Program's scale, Type, key, Random |
| P4: Zone/Delay | Delay | Delay Time [ms], MIDI/Tempo Sync., Base Note, Times |
| P7: ARP/DT | ARP Setup | All parameters |
| | Arpeggiator A/B | All parameters |
| | ARP Scan Zone | All parameters |
| | Drum Track | All "Drum Track" parameters |
| P8: Routing/IFX | Routing1/2 | Bus (IFX/Output) Select, Send1, Send2, Fx Control Bus |
| | Insert FX Setup | IFX, IFX On/Off, Chain to, Chain, Pan, Bus Sel, FX Control Bus, Send1, Send2 |
| | IFX 1–5 | All effect parameters |
| | Common FX LFO | All "Common FX LFO 1, 2" parameters |
| P9: MFX/TFX/ LFO | Routing | MFx, MFx On/Off, Chain, Chain Direction, Chain Level, Return 1, Return 2, TFX, TFX On/Off, Master Volume |
| | MFX 1/2 | All effect parameters |
| | TFX | All effect parameters |

*1: **Solo On/Off** is always controlled by events in the track, regardless of the play/mute status of that track.



The maximum amount of exclusive data that can be recorded at once is approximately 320 Kbytes. This size will decrease if other events exist within the same measure.



You cannot simultaneously record exclusive messages received from an external MIDI device and parameter changes produced by editing.



The events that will be recorded are controlled by the Global P1: MIDI– MIDI Basic settings SEQ Mode **Param. MIDI Out**. For Control Change, only control change messages will be recorded. For SysEX-Param Change, only parameter changes and exclusive messages will be recorded (see "Param. MIDI Out" on page 200).



Realtime recording will not record parameter edits that you perform by executing menu commands in the various pages, nor changes you make by using the Effect Preset function to recall effect parameters.

KROME sequencer file formats

The KROME sequencer supports both the proprietary KROME Song format, and Standard MIDI Files.

If you like, you can convert data between the two formats, simply by loading the data in one format and then saving it in the other.

For details, please see “22) Load Standard MIDI File” on page 230, and “Save SEQ” on page 232.

KROME Song format

This is the native KROME sequencer format, which is required to ensure that all KROME-specific data is saved correctly.

Standard MIDI Files

You can also load and save Standard MIDI Files (SMF), for compatibility with other sequencers. Note that some KROME-specific data may not be maintained when in SMF files.

GM, XG, and GS System Exclusive Data

The KROME sequencer can record System Exclusive messages, including XG or GS data. For details, please see “System Exclusive events supported in Sequencer mode” on page 191.



Note that GM, XG, and GS exclusive messages do not affect the KROME when they are played back.

Global mode

In Global mode, you can make settings that affect the entire instrument, such as master tuning, MIDI, and memory protect.

You can also edit user scales, drum kits, and user arpeggio pattern setups.

 If you want the settings you make in Global mode to be backed up when the power is turned off, you must write them into memory. From P5: Drum Kit, you'll be able to select the menu command **Write Drum Kits**. From P6: Arpeggio Pattern, you'll be able to select **Write Arpeggio Patterns**. From the other pages of Global mode, you'll be able to select **Write Global Setting**.

These commands can also be selected by pressing the WRITE button.

Global Page Select

- Press the GLOBAL button to access Global mode.

You can use the following ways to select the pages in Global mode.

1. Press the PAGE button to access "Page Select."

The page accessed prior to pressing the PAGE button is shown in grey.

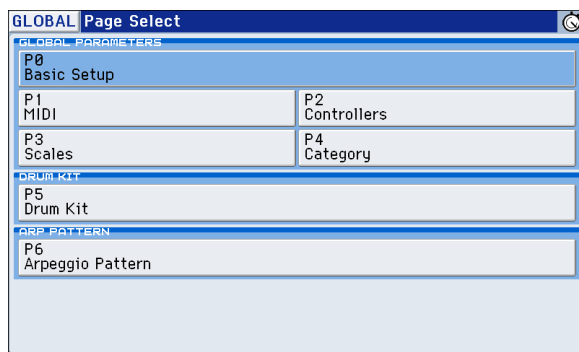

2. Select the desired page in the display.

Other ways to select pages

- Hold down the PAGE button and press numeric keys 0–6 to specify a page number; you will access the corresponding page.
For example, if you want to access the P3: Scales page, hold down the PAGE button and press numeric key 3.
- Press the EXIT button to return to the P0: Basic Setup page. If something other than the Basic page is selected, press the [EXIT] button to access the Basic page.

| | Page | Main content |
|-------------------|----------------------|--|
| GLOBAL PARAMETERS | P0: Basic Setup | Basic overall settings. (see p.194) |
| | P1: MIDI | MIDI settings for KROME. (see p.198) |
| | P2: Controllers | Controller settings such as the pedals connected to the rear panel. (see p.202) CC# assignments for Arpeggio controllers. (see p.202) |
| | P3: Scales | Scale settings created by the user. You can specify 16 types of octave scale, and one full-range scale. (see p.203) |
| DRUM KIT | P4: Category | Edit category names for programs and combinations. (see p.204) |
| | P5: Drum Kit | Edit drum kits. (see p.205) |
| ARP PATTERN | P6: Arpeggio Pattern | Creating Arpeggio pattern. (see p.211) |

Global P0: Basic Setup

0-1: Basic

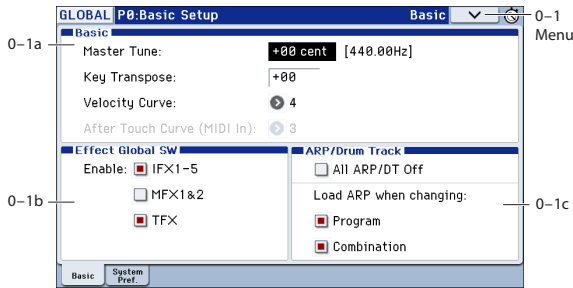

Here, you can make master tune settings, turn all effects on/off, and make on/off settings for the arpeggiator and drum track.

0-1a: Basic

Master Tune

[-50cent (427.47Hz)...+50cent (452.89Hz)]

This adjusts the overall tuning of the entire KROME in one-cent units (semitone = 100 cents), over a range of ±50 cents. With a setting of 0, the frequency of A4 will be 440 Hz.

The A4 pitch given here is when Equal Temperament is selected as the scale. If a different scale is selected, A4 may not be 440 Hz.

Key Transpose

[-12...+00...+12]

This adjusts the pitch in semitone steps over a ±1 octave range.

This setting is applied at the location (PreMIDI or PostMIDI) specified by **Convert Position** (Global 1-1a).

MIDI note number transmitted by the KROME

| Keys\Transpose | -12 | 0 | +12 |
|----------------|----------------------|-----------------------|-----------------------|
| 61 keys | 24...84 (C1...C6) | 36...96 (C2...C7) | 48...108 (C3...C8) |
| 73 keys | 12...84 (C0...C6) | 24...96 (C1...C7) | 36...108 (C2...C8) |
| 88 keys | 9...96 (A-1...C7) | 21...108 (A0...C8) | 33...120 (A1...C9) |

Note: If **Convert Position** is set to PreMIDI, the MIDI note numbers transmitted from the KROME will be affected by **Key Transpose** setting.

Master Tune can be controlled by the MIDI universal System Exclusive message Master Fine Tuning (F0, 7F, nn, 04, 03, vv, mm, F7: nn=MIDI channel, vv/mm=value).

Key Transpose can be controlled by the MIDI universal System Exclusive message Master Coarse Tuning (F0, 7F, nn, 04, 04, vv, mm, F7: nn=MIDI channel, vv/mm=value).

These messages are received on the global MIDI channel specified by **MIDI Channel** (Global 1-1a).

In Program, Combination, and Sequencer modes, MIDI RPN messages can be received to control the tuning and transposition of the program or timbre (Combination mode) or track (Sequencer mode). Incoming MIDI RPN Fine Tune messages will make relative adjustments to the tuning specified by the **Master Tune** setting.

MIDI RPN Coarse Tune messages will make relative adjustments to the pitch specified by the **Key Transpose** setting. In Program mode, these messages will be received on the global MIDI channel specified by **MIDI Channel** (Global 1-1a), and in other modes they will be received on the MIDI channel specified for each timbre or track. (**Transpose**, **Detune**, Combi 3-5(6)c, Seq 3-5(6)c)

Velocity Curve

[1...9]

This specifies the way in which the volume and/or tone will change in response to variations in keyboard playing dynamics (velocity).

The curves you can select will depend on the **Convert Position** (Global 1-1a) setting. If the setting is PreMIDI, the curve is applied immediately after the keyboard. If the setting is PostMIDI, the curve is applied immediately before the sound generator.

In the case of PreMIDI, your keyboard playing dynamics are modified as shown by transmission curves 1-9 (lower left diagram), and reception is fixed at curve 4 linear (diagram at lower right).

In the case of PostMIDI, your keyboard playing dynamics are transmitted according to transmission curve 4 linear (lower left diagram), and will be interpreted according to reception curve 1-9 (lower right diagram).

If you're using the KROME as a MIDI sound module, and want to adjust the overall brightness of the sound, set **Convert Position** (Global 1-1a) to PostMIDI and select the appropriate velocity curve.

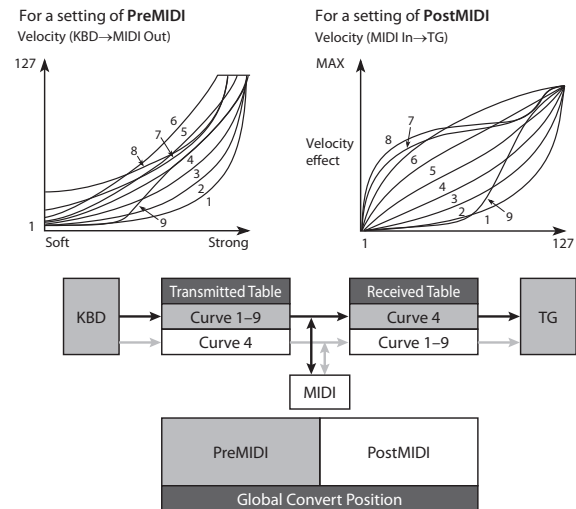

1, 2, 3: Strongly played notes will be affected.

4 (Normal): The normal curve

5, 6: Produces an effect even if you do not play very strongly.

7: This curve produces a relatively consistent effect for softly played notes.

8: This curve produces an even more consistent effect.

Each curve has its own characteristics, so you should select the curve that best suits your own playing style and the results you want to obtain.

9: Compared with the standard curve #4, this curve softens the response of gently-played notes. This allows velocity control with broader dynamics for sounds such as acoustic piano. This setting is particularly recommended for the KROME-88.

Aftertouch Curve (MIDI IN) [1...8]

This specifies the way in which incoming aftertouch data will affect the volume or tone when **Convert Position** (Global 1-1a) is set to PostMIDI.

 This setting has no effect when **Convert Position** (Global 1-1a) is set to PreMIDI.

This curve is applied immediately before the tone generator. The **aftertouch Curve** setting selects the curve that is applied to the incoming aftertouch.

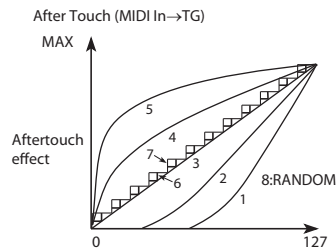

1, 2: This curve produces change when strong aftertouch pressure is applied.

3 (Normal): The normal curve.

4, 5: This curve produces change even when light pressure is applied.

6, 7: These curves produce change in 24 or 12 steps. Curve number 7 allows change over twelve steps, so when using aftertouch to modify the pitch, you can set the range of modification to one octave, and use aftertouch to vary the pitch in semitone steps.

8: This is a random curve. Use this when you wish to create special effects, or to use aftertouch to apply unpredictable modulation.

 With a setting of aftertouch, the setting you make here will be applied immediately before the KROME's internal tone generator, meaning that it will affect the data received via MIDI, but will not affect the transmitted data.

0-1b: Effect Global SW**Enable IFX 1-5 [Off, On]**

Off (unchecked): All insert effects IFX1-5 will be off.

On (checked): The P8: Insert Effect settings for each **IFX On/Off** in Program, Combination, and Sequencer modes will be valid.

Enable MFX1&2 [Off, On]

Off (unchecked): Master Effect1 and 2 (MFX1, 2) will be off.

On (checked): The P9: MFX/TFX/LFO setting **MFX1 On/Off**, and **MFX2 On/Off**, in Program, Combination, and Sequencer modes will be valid.

This on/off setting is linked with the front panel MASTER FX button.

Enable TFX [Off, On]

Off (unchecked): Total effect (TFX) will be off.

On (checked): The P9: MFX/TFX/LFO setting **TFX On/Off**, in Program, Combination, and Sequencer modes will be valid.

This on/off setting is linked with the front panel TOTAL FX button.

 These settings will always be turned on when you power-on the KROME.

 When **Enable IFX**, **Enable MFX1&2**, or **Enable TFX** settings are switched, control change messages CC#92 (effect control 2), CC#94 (effect control 4), and CC#95

(effect control 5) will be transmitted respectively. The transmitted data will be 0 for off, and 127 for on.

0-1c: ARP/Drum Track**All ARP/DT Off [Off, On]**

On (checked): All arpeggiator and Drum Track functions will be off. The arpeggiator will not operate even if the ARP button is on. The Drum Track function will not operate even if the DRUM TRACK button is on.

Off (unchecked): The arpeggiator settings and ARP button settings in Program, Combination, and Sequencer modes will be used. The Drum Track function will operate according to the settings in each mode and the state of the DRUM TRACK button.

Load ARP when changing:**Program [Off, On]**

On (checked): When you switch programs, the arpeggiator settings stored in that program will be used. Normally you will use the On setting.

Off (unchecked): The arpeggiator settings will not change even if you switch programs. Use this setting if you want to switch Program sounds without changing the phrases from the arpeggiator.

Combination [Off, On]

On (checked): When you switch combinations, the arpeggiator settings stored in that combination will be used. Normally you will use the On setting.

Off (unchecked): The arpeggiator settings will not change even if you switch combinations. Use this setting if you want only to switch combination sounds without changing the phrases from the arpeggiator.

Mode, Stop Watch

See "a: Mode button" on page 4 of the Operation guide.

See "l: Stopwatch button" on page 5 of the Operation guide.

∨ 0-1: Menu Command

- 0: **Write Global Setting** see p. 216
- 1: **Load Preload/Demo Data** see p. 216
- 2: **Change all bank references** see p. 216
- 3: **Display Setup** see p. 216
- 4: **Touch Panel Calibration** see p. 217
- 5: **Half Damper Calibration** see p. 217
- 6: **Update System Software** see p. 218

For more information, please see "Global: Menu Command" on page 216.

0-2: System Preference

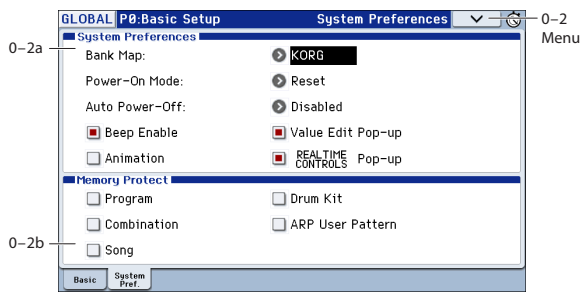

Here, you can make overall settings for the entire system such as bank map, and memory protect.

0-2a: System Preference

Bank Map [KORG, GM(2)]

This specifies the mapping of programs and combinations relative to Bank Select control change messages (CC#0 upper byte and CC#32 lower byte).

The bank select messages shown in the table below will be received (R) and transmitted (T) for Program banks A-F, GM, g(1)...g(9), g(d) and Combination banks A-D.

| Bank | Bank Map: KORG | Map: GM(2) |
|-------------|-----------------------|---------------------------------|
| A | 00. 00 R/T | 63. 00 R/T |
| B | 00. 01 R/T | 63. 01 R/T |
| C | 00. 02 R/T | 63. 02 R/T |
| D | 00. 03 R/T | 63. 03 R/T |
| E | 00. 04 R/T | 63. 04 R/T |
| F | 00. 05 R/T | 63. 05 R/T |
| GM, | 121. 00 R/T, 56. 00 R | 121. 00 R/T, 56. 00 R, 00. 00 R |
| g(1)...g(9) | 121. 01...09 R/T | 121. 01...09 R/T |
| g(d) | 120. 00 R/T, 62. 00 R | 120. 00 R/T, 62. 00 R |

Power-On Mode [Reset, Memorize]

Specifies the condition at power-on.

Reset: The KROME will be in Program mode P0: Play, and Program A000 will be selected.

Memorize: The location (mode and page) which you most recently accessed when you last powered-off the KROME will be recalled. If you were in Program or Combination mode, the program or combination bank/number at power-off will be recalled.

⚠ Before turning off the power, be sure to write your data or save it in Media mode. This function does not memorize the contents of any parameters that were edited.

Auto Power-Off [30 minutes, an hour, 4 hours, Disabled]

The KROME will automatically turn off its own power a certain length of time after its keyboard, display, buttons, or knobs were last used. (With the factory settings, the power will turn off in approximately four hours.)

* Moving the VOLUME knob is not considered usage for this purpose. Even if you use these knobs, the power will still turn off when the specified time has elapsed if no other user input has been performed.

Even when songs or demo songs are being played back consecutively, the power will automatically turn off if the specified time elapses without any sound at all being produced.

Here you can specify the time when auto power-off will occur. You can also prevent the power from turning off.

⚠ When the power turns off, the settings you had been editing will be lost. You should save any settings that you want to keep.

30 minutes, an hour, 4 hours: The power will automatically turn off if the specified time elapses without any user input being performed on the KROME's keyboard or buttons. The available settings are 30 minutes, 1 hour, and 4 hours.

If you've chosen one of these settings, a dialog box will appear when the system starts up, informing you of the length of time after which auto power-off will occur.

If you want to change the auto power-off setting, press the Change Setting button in this dialog box and change the setting as desired.

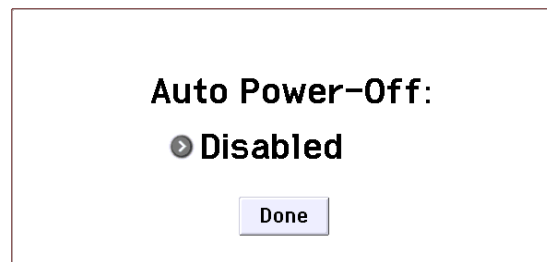
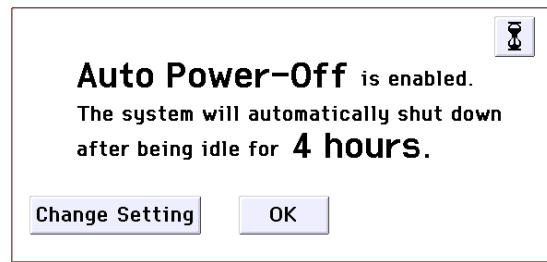

Several minutes before the power turns off, a dialog box will appear with a count-down indicating the time until the power turns off. If you don't want the power to turn off, press the KROME's display or keyboard, or use a button or knob. Auto power-off will be reset, and the same message will appear once again if no user input is performed for the specified length of time.

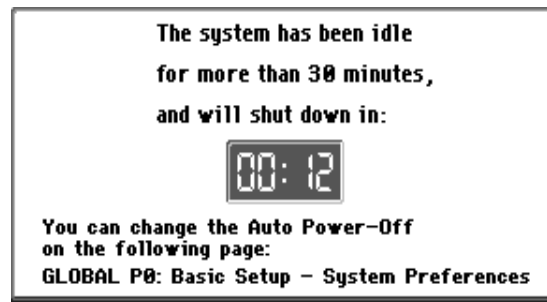

Disable: Auto power-off will be disabled. The power will not turn off automatically.

⚠ Changes you make to this setting are always saved. There is no need to execute **Write Global Setting**.

Beep Enable [Off, On]

On (checked): A beep will be heard when you press an object in the display.

Off (unchecked): No beep will be heard.

Animation [Off, On]

On (checked): Enables an animation effect when displaying menus, pads, or dialog boxes.

Off (unchecked): Disables the animation effect.

 In some cases, the animation will be disabled automatically when large amounts of performance data is being processed by the drum track or sequencer.

Value Entry Pop-up [Off, On]

On (checked): A popup will appear when you hold down or press twice on an edit cell, knob, or slider.

Off (unchecked): A popup will not appear.

REALTIME CONTROLS Pop-up [Off, On]

On (checked): A popup will appear when you operate the front panel REALTIME CONTROLS knob.

Off (unchecked): A popup will not appear.

 In some cases, popup display will be disabled automatically when large amounts of performance data is being processed by the drum track or sequencer.

0–2b: Memory Protect

Program [Off, On]

This setting protects the internal program memory.

On (checked): Internal program memory will be protected, and the following write operations cannot be performed.

- Writing a program
- Loading preloaded program data
- Loading program data from media
- Receiving program data via MIDI data dump

Off (unchecked): Data can be written to internal program memory.

Combination [Off, On]

This setting protects the internal combination memory.

On (checked): Internal combination memory will be protected, and the following write operations cannot be performed.

- Writing a combination
- Loading preloaded combination data
- Loading combination data from media
- Receiving combination data via MIDI data dump

Off (unchecked): Data can be written to internal combination memory.

Song [Off, On]

This setting protects the internal song memory.

However, when the power is turned off, the song data in song memory will be lost regardless of this setting.

On (checked): Internal song memory will be protected, and the following write operations cannot be performed.

- Recording to the sequencer
- Loading preloaded song data
- Loading song data from media
- Receiving song data via MIDI data dump

Off (unchecked): Data can be written to internal song memory.

Drum Kit [Off, On]

This setting protects the internal drum kit memory.

On (checked): Internal drum kit memory will be protected, and the following write operations cannot be performed.

- Writing a drum kit
- Loading preloaded drum kit data
- Loading drum kit data from media
- Receiving drum kit data via MIDI data dump

Off (unchecked): Data can be written to internal drum kit memory.

Arpeggio User Pattern [Off, On]

This setting protects the internal user arpeggio pattern memory.

On (checked): Internal user arpeggio pattern memory will be protected, and the following write operations cannot be performed.

- Writing a user arpeggio pattern
- Loading preload arpeggio pattern data
- Loading user arpeggio pattern data from media
- Receiving user arpeggio pattern data via MIDI data dump

Off (unchecked): Data can be written to internal user arpeggio pattern memory.

✓ 0–2: Menu Command

- 0: **Write Global Setting** see p. 216
- 1: **Load Preload/Demo Data** see p. 216
- 2: **Change all bank references** see p. 216
- 3: **Display Setup** see p. 216
- 4: **Touch Panel Calibration** see p. 217
- 5: **Half Damper Calibration** see p. 217
- 6: **Update System Software** see p. 218

For more information, please see “Global: Menu Command” on page 216.

Global P1: MIDI

1-1: MIDI Basic

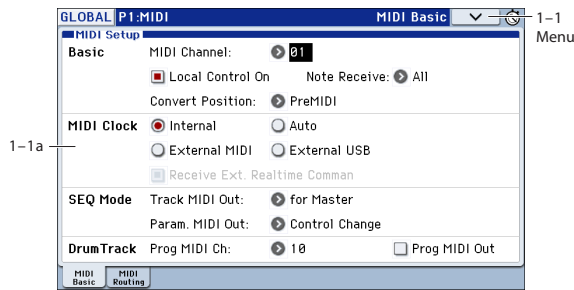

Here, you can make MIDI-related settings that affect the entire KROME.

Note: To transmit MIDI exclusive dump data, you'll use the menu commands of this P1: MIDI page.

1-1a: MIDI Setup

Basic:

MIDI Channel (Global MIDI Channel) [1...16]

Sets the global MIDI channel.

The global MIDI channel is used in the following cases.

- When transmitting and receiving performance data in Program mode (Prog P0: Play).
- When selecting combinations via MIDI in Combination mode (Combi P0: Play).
- When triggering the drum track (with **Trigger Mode** set to Wait KBD Trig) in Program or Combination mode.
- When controlling timbres or effects that have been set to Gch in various modes
- When transmitting and receiving System Exclusive messages

MIDI received

In Program mode (P0: Play), MIDI data is received on the global MIDI channel, but in Combination mode (P0: Play) or Sequencer mode, MIDI data is received on the MIDI channel specified for each timbre or track.

In Combination mode (P0: Play), program changes received on the global MIDI channel will switch the combination (Global 1-2b: MIDI Filter).

Use the global MIDI channel to switch IFX 1-5 (CC#92), MFX1&2 (CC#94) and TFX (CC#95) on/off.

To control the pan following IFX, sends 1/2, MFX 1/2 and TFX, use the global MIDI channel when in the Program mode; while in the Combination, or Sequencer modes, use the channel specified separately by **Ctrl Ch** for IFX1-5, MFX1&2, and TFX. By setting **Ctrl Ch** to Gch, you can control these parameters from the global MIDI channel.

MIDI output when playing the KROME

In Program mode, this data will be transmitted on the global MIDI channel. In Combination mode, data will be transmitted simultaneously on the global MIDI channel and on the MIDI channels of timbres whose **Status** (Combi 3-1(2)c) is set to EXT or EX2.

In Sequencer mode, musical data will be transmitted on the channel specified for the currently selected track (Seq 3-1(2)c) (whose **Status** is BTH, EXT, or EX2).

Note Receive (Note Receive Filter) [All, Even, Odd]

This setting specifies whether even-numbered, odd-numbered, or all note numbers will be sounded when note data is received from the KROME's keyboard or from an external MIDI device. By connecting the KROME to another KROME and setting one instrument to Even and the other to Odd, you can effectively double the polyphony by dividing the notes between the two instruments.

All: All note numbers will be received. Normally you will leave this set to All.

Even: Even-numbered notes (C, D, E, F#, G#, A#) will sound.

Odd: Odd-numbered notes (C#, D#, F, G, A, B) will sound.

MIDI This setting has no effect on the MIDI data that is received.

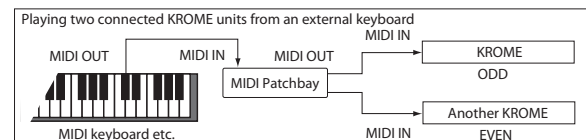
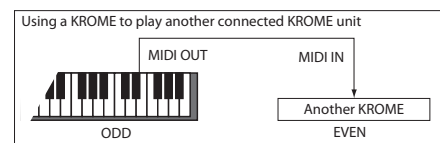

Local Control On

[Off, On]

Local Control On (checked): The KROME's knobs, and the keyboard, joystick, SW1, and SW2 will control the KROME's sound generator. Leave this setting checked if you're playing the KROME by itself.

Local Control Off (unchecked): The KROME's knobs, the keyboard, joystick, SW1, and SW2 will be disconnected from the KROME's sound generator.

This means that operating the KROME (playing its keyboard and using the joystick, or playing back the sequencer) will not sound its internal tone generator.

Turn **Local Control** Off if loop-back from an external sequencer causes duplicate notes.

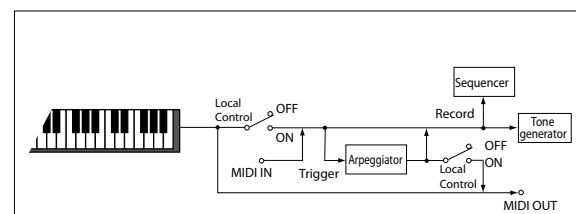

MIDI If **Local Control** is Off, MIDI transmission/reception will occur normally. Playing the keyboard will cause the corresponding note data to be transmitted, and received note data will play the KROME's internal sounds.

Note: Even if Local Control is On, notes played back by the internal sequencer will not trigger the arpeggiator.

Convert Position

[PreMIDI, PostMIDI]

This setting specifies the location at which the Transpose and Velocity Curve settings will be applied. This setting will affect the MIDI data that is transmitted and received, and the data that is recorded on the internal sequencer.

When using the KROME's keyboard to play the internal tone generator, the Transpose, Velocity Curve, and aftertouch

Curve settings will always take effect regardless of this setting.

PreMIDI: Velocity Curve, and Transpose will be applied to the data that is transmitted from the KROME's keyboard.

This means that the Velocity Curve, and Transpose settings will affect the data that is transmitted from MIDI OUT when the KROME's keyboard is played, and the data that is recorded on the internal sequencer.

MIDI data received from MIDI IN or the data played back by the internal sequencer will not be affected.

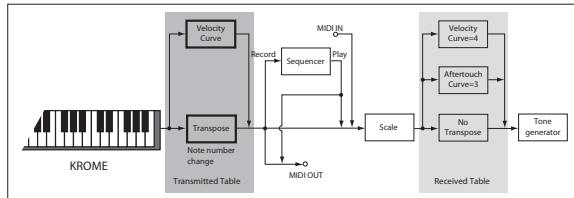

PostMIDI: Velocity Curve, aftertouch Curve, and Transpose will be applied to data before it enters the tone generator.

This means that the Velocity Curve, aftertouch Curve, and Transpose settings will affect the data that is sent to the internal tone generator when you play the KROME's keyboard, when the internal sequencer is played back, or when data is received from MIDI IN.

This setting will not affect the data that is transmitted from MIDI OUT or recorded on the internal sequencer when you play the KROME's keyboard or play back the sequence.

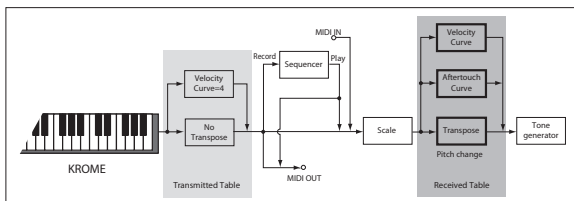

MIDI Clock:

MIDI Clock (MIDI Clock Source)

[Internal, External MIDI, External USB, Auto]

Use this setting to synchronize the KROME's arpeggiator and internal sequencer with an external MIDI device (e.g., sequencer or rhythm machine) and computer.

Internal: The arpeggiator and the internal sequencer will operate according to the internal clock.

Select the Internal setting when using the KROME by itself, or when you want the KROME to be the master (controlling device) so that connected external MIDI devices will synchronize to the KROME MIDI Clock.

External MIDI: The arpeggiator and internal sequencer will operate in synchronization to the MIDI Clock input from an external MIDI device.

External USB: The arpeggiator and internal sequencer will operate in synchronization with the MIDI Clock from a computer (for example a sequencer or DAW application), connected to the USB connector.

Auto: Normally the operation will be the same as the Internal setting. If external MIDI Clock messages are received from the MIDI IN or USB connector, the KROME will automatically switch to External MIDI and External USB.

Note: If you select Auto when an external MIDI sequencer and computer is connected, the KROME will automatically switch to Internal operation if the external sequencer is not transmitting MIDI Clock messages, allowing the arpeggiator to operate and parameters for which MIDI/Tempo Sync is turned on to function.

Note: If after receiving a MIDI Clock, Start, or Continue message from the MIDI IN or USB connector, no new MIDI Clock message is received within an interval of 500 ms, or if you start the KROME's sequencer from the front panel without having received a MIDI Clock, Start, or Continue message from the MIDI IN and USB connector, the KROME will automatically switch to Internal operation.

Receive Ext. Realtime Commands [Off, On]

Off (unchecked): Even if MIDI Clock is set to External MIDI, or if set to Auto and the KROME is synchronized to external MIDI Clock messages, MIDI Common messages and Realtime messages (Song Position Pointer, Start, Continue, Stop) will not be received. (Song Select messages will be received.)

Note: Use this setting if the above messages from an external MIDI sequencer are inadvertently resetting the KROME's song settings.

On (checked): The above Common messages (including Song Select) and Realtime messages will be received.



This parameter cannot be set if MIDI Clock is Internal.

SEQ Mode:**Track MIDI Out****[for Master, for External Sequencer]**

This setting specifies what will be transmitted via MIDI when you switch songs in Sequencer mode.

for Master: Normally in Sequencer mode, the internal sequencer can record or play back a performance on the KROME's keyboard. In this case, tracks that are set to EXT or BTH will control external MIDI sound modules. You can make settings in a song so that when you select that song on the KROME, tracks that are set to EXT or BTH will transmit program changes or other MIDI messages* to set up your external MIDI sound modules.

for External Sequencer: Choose this setting if you want to use the KROME in Sequencer mode as a multi-timbral sound module driven by an external sequencer. With this setting, even the tracks that are set to EXT or BTH will not transmit program changes or other MIDI messages* when you switch songs on the KROME. In this case, echo-back from the external MIDI sequencer will not switch programs or other parameters to the identical settings on each track that is set to the same MIDI channel.

*** Applicable parameters**

- Program Select: CC#00 bank select (LSB), CC#32 bank select (MSB), program change
- Pan: CC#10 pan
- Volume: CC#7 volume
- Portamento: CC#65 portamento On/Off, CC#5 portamento time
- Send 1/2: CC#93 send 1 level, CC#91 send 2 level
- (Post FX) Pan: CC#8 post insert effect pan

Param. MIDI Out**[Control Change, SysEx-Param Change]**

This setting specifies whether control changes or System Exclusive messages will be transmitted when you edit a parameter in Sequencer mode.

Control Change: Data for the edited parameter will be transmitted as a control change.

SysEx-Param Change: Data for the edited parameter will be transmitted as a parameter change.

Note: For these to operate, **Enable Control Change** or **Enable Exclusive** (Global P1: MIDI- MIDI Routing) must be checked respectively.

*** Applicable parameters**

- Pan: CC#10 pan
- Volume: CC#7 volume
- Send 1/2: CC#93 send 1 level, CC#91 send 2 level

Drum Track:

Drum track programs in Program mode will be triggered on the global MIDI channel if **Trigger Mode** is set to Wait KBD Trig. The MIDI transmit channel is specified by the Drum Track **Prog MIDI Ch**. Use the Drum Track **Prog MIDI Out** to specify whether the MIDI note data of the pattern will be transmitted.

Drum track programs do not transmit or receive MIDI program changes.

Prog MIDI Ch**[01...16]**

This specifies the MIDI channel for drum track transmission and reception in Program mode. If **Prog MIDI Out** is checked, drum pattern note data will be transmitted on this MIDI channel. The default setting is channel 10.

Prog MIDI Out**[Off, On]**

On (checked): The note data of the drum track pattern will be transmitted on the channel specified by **Prog MIDI Ch**.

Off (unchecked): The note data of the drum track pattern will not be transmitted.

✓ 1-1: Menu Command

- 0: **Write Global Setting** see p. 216
- 1: **Dump Program** see p. 218
- 2: **Dump Combination** see p. 218
- 3: **Dump Drum Kit** see p. 218
- 4: **Dump Arpeggio Pattern** see p. 218
- 5: **Dump Global Setting** see p. 218
- 6: **Dump Sequencer** see p. 218
- 7: **Dump Drum Track Pattern** see p. 218

For more information, please see "Global: Menu Command" on page 216.

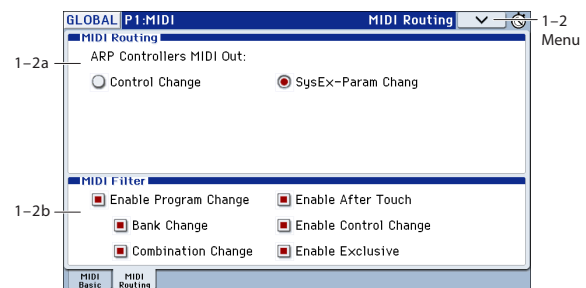
1-2: MIDI Routing

Here, you can make MIDI Routing and MIDI Filter settings for the entire KROME.

Note: To transmit MIDI exclusive dump data, you'll use the menu commands of the P1: MIDI page.

1-2a: MIDI Routing**ARP Controllers MIDI Out****[Control Change, SysEx-Param Change]**

This specifies the MIDI messages that will be transmitted when you operate the ARP button or when you operate knobs 1-4 with ARP selected by SELECT switch.

Control Change: Operating the ARP button or knobs 1-4 will transmit the MIDI control change messages that are assigned in Global P2-2: Controllers (SW) - ARP ON/OFF and (ARP CONTROL) GATE - (ARP CONTROL) STEP.

SysEx-Param Change: Operating the ARP button or knobs 1-4 will transmit MIDI System Exclusive parameter change messages for the parameters (arpeggiator on/off, **Gate**, **Velocity**, **Swing**, **Step**) assigned to the button and knobs.

1-2b: MIDI Filter**Enable Program Change****[Off, On]**

On (checked): Program changes will be transmitted and received.

In Program mode (P0: Play), the program will be switched when a program change message is received on the global MIDI channel specified by **MIDI Channel** (Global 1-1a). When you switch programs, a program change message will be transmitted on the global MIDI channel.

In Combination mode (P0: Play), the combination will be switched when a program change message is received on the global MIDI channel. However, it is possible to set the **Enable Combination Change** parameter so that the combination is not switched. When a program change is received on the channel specified for each timbre by **MIDI Channel** (Combi 3-1(2)c), the program of that timbre will be switched. However, the program changes for each timbre will be affected by the setting of the **Enable Program Change** parameter (Combi 5-1(2)c).

When you switch combinations, a program change message will be transmitted on the global MIDI channel, and also transmitted simultaneously on the channel of timbres whose **Status** (Combi 3-1(2)c) is set to EXT or EX2.

In Sequencer mode, incoming program change messages on a channel that corresponds to a track whose **Status** (Seq 3-1(2)c) is set to INT or BTH will switch programs on that track.

When you select a song or play back sequencer data, program changes will be transmitted on the channels of tracks whose **Status** is set to BTH, EXT, or EX2.

Off (unchecked): Program changes will not be transmitted or received.

Bank Change [Off, On]

On (checked): The Bank Select control change message will be transmitted together with program change messages. This is valid when **Enable Program Change** is checked.

Off (unchecked): Bank Select messages will not be transmitted or received.

When recording on the internal sequencer, bank select messages will be recorded regardless of this setting. However for playback, this setting will apply.

Combination Change [Off, On]

On (checked): When in Combi P0: Play, an incoming program change message on the global MIDI channel set by **MIDI Channel** (Global 1-1a) will switch combinations.

This is valid when **Enable Program Change** is checked.

An incoming program change on a channel other than the global MIDI channel will switch the program of any timbre that matches that MIDI channel.

Off (unchecked): An incoming program change message on the global MIDI channel will switch the program of any timbre whose **MIDI Channel** (Combi 3-1(2)c) matches the global MIDI channel. The combination will not be switched.

The program changes for each timbre will be affected by the setting of the **Enable Program Change** parameter (Combi 5-1(2)c).

Enable After Touch [Off, On]

On (checked): MIDI aftertouch messages will be transmitted and received.

Off (unchecked): MIDI aftertouch messages will neither be transmitted nor received.

This setting has no effect when you use the internal sequencer to playback sequence data that was recorded with aftertouch data; i.e., aftertouch will be transmitted via MIDI.

Performing on the KROME's keyboard will transmit neither channel aftertouch nor polyphonic aftertouch. However, since the KROME does support aftertouch as an Alternate Modulation Source (AMS), it can receive aftertouch to control.

Enable Control Change [Off, On]

On (checked): Control change messages will be transmitted and received.

Off (unchecked): Control change messages will neither be transmitted nor received.

This setting has no effect when you use the internal sequencer to play back sequence data that was recorded with control change data; i.e., the control changes previously recorded into the sequencer will be transmitted via MIDI.

Enable Exclusive [Off, On]

On (checked): System Exclusive data will be transmitted and received.

Check this if you want to edit the KROME from a connected computer, or if you want to allow bi-directional editing.

Off (unchecked): System Exclusive data will not be transmitted. Normally you will leave this unchecked.

However, System Exclusive data will be transmitted and received while the menu commands (**Dump Program-Dump Drum Track Pattern**) of this page are displayed.

✓ 1-2: Menu Command

- 0: **Write Global Setting** see p. 216
- 1: **Dump Program** see p. 218
- 2: **Dump Combination** see p. 218
- 3: **Dump Drum Kit** see p. 218
- 4: **Dump Arpeggio Pattern** see p. 218
- 5: **Dump Global Setting** see p. 218
- 6: **Dump Sequencer** see p. 218
- 7: **Dump Drum Track Pattern** see p. 218

For more information, please see "Global: Menu Command" on page 216.

Global P2: Controllers

2-1: Foot Controllers

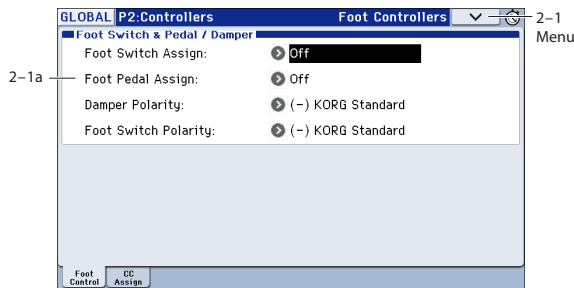

2-1a: Foot Switch & Pedal/Damper

Foot Switch Assign [List of Foot Switch Assign]

Selects the function that will be controlled by a pedal switch (such as the optional Korg PS-1 or PS-3) connected to the ASSIGNABLE SWITCH jack.

For a complete list of possible assignments, please see “Foot Switch Assignments” on page 349.

Foot Pedal Assign [List of Foot Pedal Assign]

Selects the function that will be controlled by a foot volume pedal (XVP-10 or EXP-2 option [sold separately]) connected to the ASSIGNABLE PEDAL jack.

For a complete list of possible assignments, please see “Foot Pedal Assignments” on page 350.

Damper Polarity [(-) KORG Standard, (+)]

Set this to match the polarity of the damper pedal connected to the DAMPER jack. If the polarity does not match, operating the damper pedal will not produce the correct result. If no damper pedal is connected, set this to (-) KORG Standard.

(-) **KORG Standard:** Use this setting for “open-type” damper pedals, such as the optional Korg DS-1H.

(+): Use this setting for “closed-type” pedals.

Foot Switch Polarity [(-) KORG Standard, (+)]

Set this to match the polarity of the footswitch connected to the ASSIGNABLE SWITCH jack. If the polarity does not match, operating the damper pedal will not produce the correct result. If no damper pedal is connected, set this to (-) KORG Standard.

(-) **KORG Standard:** Use this setting for “open-type” footswitches, such as the optional Korg PS-1 or PS-3.

(+): Use this setting for “closed-type” pedals.

2-1: Menu Command

- 0: **Write Global Setting** see p. 216

For more information, please see “Global: Menu Command” on page 216.

2-2: MIDI CC# Assign

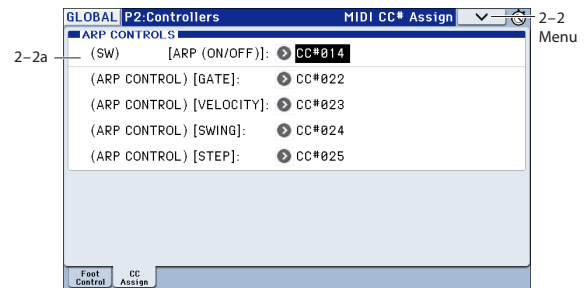

2-2a: ARP Controllers

This specifies the MIDI messages that will be transmitted when you operate the ARP button or when you operate knobs 1-4 with ARP selected by SELECT button.

Here, you can assign control change messages to the arpeggiator switches and knobs 1-4 when ARP is selected by the SELECT button.

When you operate a switch or knobs 1-4 when ARP is selected by the SELECT button, the assigned control change message will be transmitted from the MIDI OUT connector.

The assigned control change messages can also be received from an external MIDI device connected to the MIDI IN connector, and used to control the corresponding arpeggiator.

The default settings of each parameter are as shown in the display above.

(SW) – ARP (ON/OFF) [Off, 000...119]

Assigns a control change message sent by the ARP button. The default setting is CC#14.

(ARP CONTROL) GATE [Off, 000...119]

Assigns the control change message sent by knob 1 when ARP is selected by the SELECT switch. The default setting is CC#22.

(ARP CONTROL) VELOCITY [Off, 000...119]

Assigns the control change message sent by knob 2 when ARP is selected by the SELECT switch. The default setting is CC#23.

(ARP CONTROL) SWING [Off, 000...119]

Assigns the control change message sent by knob 3 when ARP is selected by the SELECT switch. The default setting is CC#24.

(ARP CONTROL) STEP [Off, 000...119]

Assigns the control change message sent by knob 4 when ARP is selected by the SELECT switch. The default setting is CC#25.

2-2: Menu Command

- 0: **Write Global Setting** see p. 216
- 1: **Reset Controller MIDI Assign** see p. 220

For more information, please see “Global: Menu Command” on page 216.

Global P3: Scales

3-1: Scales

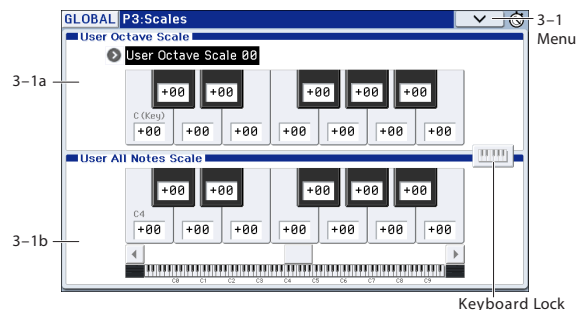

Here, you can make settings for sixteen different User Octave Scales and one User All Notes Scale.

The user scales you create here can be selected from the following pages.

- Prog P1: Basic/Controllers– Note-on/Scale
- Combi P3: Timbre Param– Scale T01–08/T09–16
- Seq P3: Track Param– Scale T01–08/T09–16

Note: To edit a scale, use the Program mode page listed above to select the scale that you want to edit, and then move to this page.

Note: The key can also be selected by holding down the ENTER button and playing a note. Alternatively, you can press the Keyboard Lock button and play a note to select the key. Select the scale that you want to edit.

Note: By executing the **Copy Scale** menu command, you can copy the settings of a preset scale (other than Stretch) or of another user scale, and then edit the settings of the copied scale.

 If you wish to keep an edited user scale after the power is turned off, be sure to write (save) your settings. Press the page menu or the WRITE button to access the **Write Global Setting** menu command and save your settings.

3-1a: User Octave Scale

User Octave Scale [User Octave Scale 00...15]

Selects the User Octave Scale that you want to edit.

Tune [-99...+99]

Makes pitch settings for each note in the octave.

When you adjust the pitch of each note in the octave (C–B) in one-cent steps, your settings will be applied to all octaves. This adjustment is relative to equal temperament.

A setting of **-99** lowers the pitch approximately a semitone below normal pitch.

A setting of **+99** raises the pitch approximately a semitone above normal pitch.

By executing the menu command **Copy Scale**, you can copy settings from a preset scale (other than Stretch) or from another user scale.

3-1b: User All Notes Scale

Tune [-99...+99]

Makes independent pitch settings for each of the 128 notes. Adjust the pitch of each of the 128 notes (C–1 – G9) in one-cent steps. This adjustment is relative to equal temperament. A setting of **-99** lowers the pitch approximately a semitone below normal pitch.

A setting of **+99** raises the pitch approximately a semitone above normal pitch.

Use the horizontal scroll bar to move to the key range that you want to set, and select the key that you want to specify.

By executing the menu command **Copy Scale**, you can copy settings from a preset scale (including Stretch) or another user scale.

Keys Lock [Off, On]

If this is On, you can use the KROME's keyboard to select keys of the scale. Select the key for User Octave Scale or User All Notes Scale, and then use the keyboard to make your selection.

✓ 3-1: Menu Command

- 0: **Write Global Setting** see p. 216
- 1: **Copy Scale** see p. 220

For more information, please see "Global: Menu Command" on page 216.

Global P4: Category

Programs, and Combinations are organized into categories and sub-categories.

Categories make it easy to find a particular type of instrument, such as keyboard, bass, or drums, or a specific type of sound, such as arpeggios or gated patterns.

Each main category also has up to 8 sub-categories, for finer degrees of organization. For instance, the Program keyboard category has sub-categories for acoustic pianos, real electric pianos, synth electric pianos, and clavs and harpsichords.

Wherever you can select Programs or Combinations by bank and number, you can also select them from the category pop-up.

When shipped from the factory, there are 16 preset Program and Combination categories, with 2 more left open for your use (initially named User16 and User17).

On these pages, you can:

- Change the names of any of the categories and sub-categories, including both the factory and user categories
- Add sub-categories to the factory categories (up to the limit of 8 Per category).

You can assign a Program or Combination to a category and sub-category during the Write process. For more information, please see “Write Program” on page 64, and “Write Combination” on page 101.

 To save changes to category names, you’ll need to write the Global settings.

Press the page menu or the WRITE button to access the **Write Global Setting** menu command and save your settings.

Note: Drum track programs in Program mode are selected from programs assigned here to program main category “15” (default setting Drums).

4–1: Program Main

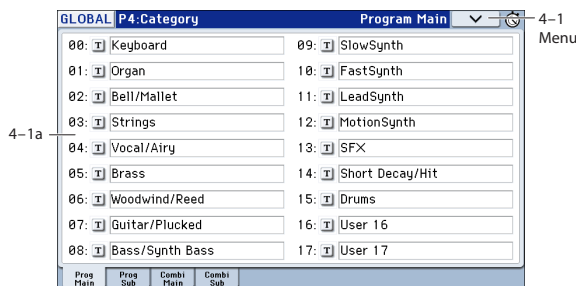

4–1a: Program Main

00...17:

Main Category Edit [Text Editor]

Here, you can edit the main category names for programs.

Press the text edit button to open the text edit dialog box, and enter a name. You can enter up to 24 characters. (See OG p.117)

You can name each of the eighteen categories.

✓ 4–1: Menu Command

- 0: Write Global Setting see p. 216

For more information, please see “Global: Menu Command” on page 216.

4–2: Program Sub

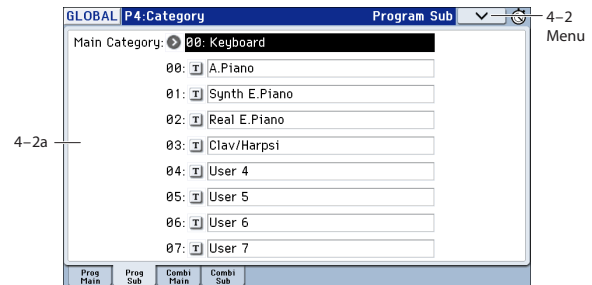

4–2a: Program Sub

Main Category [00...17]

Here, you can select the main category for which you will edit sub-category names.

00...07:

Sub Category Edit [Text Editor]

Here, you can edit the sub-category names for programs.

First, select **Main Category** to access the category that includes the sub-category name that you want to edit. After choosing the main category, press the text edit button adjacent to the sub category name that you want to edit. The text edit dialog box will open, and you can enter a name. You can enter up to 24 characters. (See OG p.117)

You can name each of the eight categories.

✓ 4–2: Menu Command

- 0: Write Global Setting see p. 216

For more information, please see “Global: Menu Command” on page 216.

4–3: Combination Main, 4–4: Combination Sub

This page lets you assign the main category and sub-category names to Combinations. For more information, please see “4–1: Program Main,” “4–2: Program Sub” above.

✓ 4–3, 4: Menu Command

- 0: Write Global Setting see p. 216

For more information, please see “Global: Menu Command” on page 216.

Global P5: Drum Kit

Here, you can create drum kits by assigning a drum instrument (drum sample) to each key.

A drum kit you edit here can be used in the same way as a multisample oscillator (when **Oscillator Mode** is Single or Double) and processed through the filter, amp, and effects etc. To do this, set the **Oscillator Mode** to Drums or Double Drums in the Program mode P1: Basic/Controllers– Program Basic page, and selecting the drum kit as an oscillator in the P2: OSC/Pitch– OSC1 Setup page and OSC2 Setup page.

Getting ready to edit

- Make sure that in the Global P0: Basic Setup - System Preference page, Memory Protect **Drum Kit** is off (unchecked). If this is checked, you won't be able to save.
- When you wish to edit a drum kit, enter Program mode, select a program that uses a drum kit (i.e., whose **Oscillator Mode** is Drums or Double Drums), and then move to this page. A program that uses a drum kit will already have filter, amp, and effect settings etc. suitable for drum sounds.
- You must set **Octave** (Prog 2-1a) to +0[8']. With any setting other than +0[8'], the key locations and drum sounds will not correspond correctly.

Moving to the Global P5: Drum Kit page

- In the Program mode P2: OSC/Pitch OSC1 Setup or OSC2 Setup page, press the Jump to Drum Kit Edit button.

You will jump to Global P5: Drum Kit. The drum kit selected in **Drum Kit Select** of OSC1 or 2 will be selected.

If **Oscillator Mode** is set to Double Drums, only the selected drum kit will produce sound. If a GM drum kit is selected, the last-selected drum kit will be selected. Use "Copy Drum kit" to copy the GM drum kit to the USER bank as necessary.

-  If you want to edit a drum kit that is assigned to OSC2 of Double Drums, use the Jump to Drum Kit Edit button of OSC2 to select this page.
- If you moved from another program or mode, the OSC1 drum kit that was selected most recently for the program will be recalled.
- Even if a program with an **Oscillator Mode** of Single or Double is selected in Program mode, the program will sound using its own filter and amp settings etc.
- Effects will sound according to the settings of the program you selected.

Editing a Drum Kit

For detailed step-by-step instructions on creating drum kits, please see "Editing a Drum Kit" on page 106 of the Operation guide.

-  If **Enable Exclusive** (Global 1-2b) is checked, the drum kit can be edited using exclusive data.

Saving Drum Kits

Press the page menu or the WRITE button to access the **Write Drum Kits** dialog box, and execute the save operation; all drum kits will be saved.

-  Unlike when editing a program or combination, your edited content will temporarily remain even if you select a different drum kit, but will be lost when you turn off the power. If you want to keep the settings of an edited drum kit even after power-off, you must execute **Write Drum Kits**.

-  Editing a drum kit will affect all programs that use the edited drum kit. When editing a preloaded drum kit, it's a good idea to copy the drum kit to an empty area in the user bank before editing it.

5-1: Sample Setup

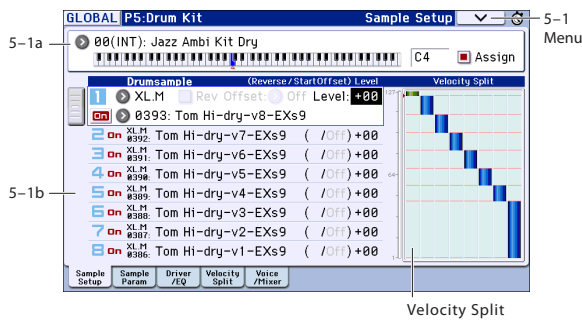

Here, you can select a drum kit and specify Drumsample 1-8 as the drum samples assigned to each key. Here, you can also edit drum sample parameters for each Drumsample.

5-1a: Drum Kit, Key Select, Assign

Drum Kit Select [00(INT)...47(USER)]

Selects the drum kit that you wish to edit.

| No. (Bank) | Contents |
|---------------------|---------------------------|
| 00(INT)...31(INT) | KROME preloaded drum kits |
| 32(USER)...47(USER) | User drum kits |

KEY [C-1...G9]

Selects the key to which the drum sample (and its settings) will be assigned.

If you check **Assign** for the key you select here, the Drumsample 1-8, Voice Assign Mode, and Mixer parameters (see below) will be used.

Assign [Off, On]

On (checked): The drum samples you assigned for Drumsample 1-8 will sound. Normally you will check this parameter.

Off (unchecked): The selected drum samples will be invalid, and the drum samples of the key to the right will sound. At this time, the pitch will be a semitone lower than the pitch of the key to the right. Uncheck this parameter when you wish to play a drum sample at differing pitches.

Drum Kit, Key Select, Assign

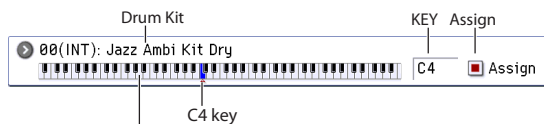

KEY: The selected key is shown in blue. You can select a key by holding down the ENTER switch and playing the desired note.

5-1b: Drumsample

You can specify up to eight drum samples.

By dragging the slider at the left, you can select the velocity zone to be edited. You can also make this selection by directly pressing the desired zone.

1: (Drumsample 1)

These are the settings for the first (High) velocity zone.

If you want to create a simple setup using only one drum sample, make the appropriate settings in Drumsample 1, and then set **Threshold Velocity** to 1 and **Xfd** to Off.

Drumsample 1 On/Off [Off, On]

On (checked): Check this if you want to use Drumsample 1. The selected drum sample will sound.

Off (unchecked): Drumsample 1 will not be used. The drum sample will not sound.

Note: Normally, you will start by using Drumsample 1 (before using Drumsample 1-8). If you don't want to switch drum samples by velocity, turn on only Drumsample 1. If you're using multiple velocity-switched drum samples, make settings as follows.

One velocity zone

Drumsample 1: On, Drumsample 2-8: Off

Two velocity zones

Drumsample 1, 2: On, Drumsample 3-8: Off

Eight velocity zones

Drumsample 1-8: On

Bank [Mono, Stereo, XL.M, XL.St]

Drumsample Select [List of installed Drumsample]

Specify the Drumsample 1 drum sample by bank and drum sample number.

Bank selects either Mono or Stereo drum samples. However, stereo drum samples will use twice as many voices as mono drumsamples.

Mono, Stereo: Conventional monaural or stereo drum samples.

XL.M (eXtra Large Mono), XL.St (eXtra Large Stereo), VM.M (Virtual Memory Mono), VM.St (Virtual Memory Stereo): High-capacity monaural or stereo drum samples.

When you press the **Drumsample Select** popup button a drum sample list will appear, allowing you to choose drum samples from the list.

Use the tabs to choose a category, and then choose a drum sample from within the category. Press the OK button to execute, or press the Cancel button to cancel.

It is not possible to edit the category names of drum samples, or to re-assign the category.

If you choose "Bank" Mono:

Mono drum samples will be displayed. The L-channel or R-channel of the stereo drum samples selectable via Bank: Stereo can also be selected as mono drum samples. In these cases, -L or -R is shown following the drum sample of the same name.

If you choose "Bank" Stereo:

Only stereo drum samples will be displayed.

Rev (Reverse) [Off, On]

This lets you play the selected drum sample backwards, without looping. However, some preset drum samples cannot be reverse-played, and consequently, they cannot be selected.

On (checked): The drum sample will play back in reverse.

The location at which reverse playback starts and ends is already specified for each drum sample.

For unselected velocity zones (shown as a single line), Rev On is indicated as [R].

Off (unchecked): The drum sample will play back normally.

Start Offset [Off, 1st...8th]

In addition to simply starting playback from the beginning, drum samples can have up to 8 different pre-programmed alternate starting points. However, you can't select drum samples for which start and offset are not specified.

With drum samples, the Start Offset specifies whether to use the normal start point (**Off**), or to use one of the alternate start points (**1st–8th**).

Some drum samples may have fewer than 8 pre-programmed points, in which case only the available points can be selected.

L (Amp Level) [-99...+99]

Specifies the volume.

Keys for which a value of +99 is specified will sound at a volume twice as high as the amp level of the program which uses that drum kit. Keys for which a value of 0 is specified will sound at the volume of the amp level of the program which uses that drum kit. Keys for which a value of -99 is specified will not sound.

2...8: (Drumsample2...8)

These are the settings for the Drumsample 2–8 velocity zones.

The parameters for Drumsample 8 are exactly the same as those for Drumsample 1, as described above.

The parameters for Drumsample 8 are also similar to those for Drumsample 1, except that Drumsample 8 has no settings for **Threshold Vel.** (which is always fixed at 1), **Xfd**, or **Curve**.

Velocity Split

This indicates the velocity zones of the oscillator's eight multisamples.

The meter on the left indicates the note-on velocity values. This lets you verify the multisamples(s) that will be sounded by each velocity (See "0-1e: Velocity Meter" on page 5.).

5-1c: Return to OSC

This button will be shown if you jumped to Global P5: Drum Kit by pressing the Program mode Jump to Drum Kit Edit button. You can press this button to jump back to the original page.

✓ 5-1: Menu Command

- 0: Write Drum Kits see p. 220
- 1: Rename Drum Kit see p. 220
- 2: Copy Drum Kit see p. 220
- 3: Copy Key Setup see p. 220
- 4: Swap Key Setup see p. 220

For more information, please see "Global: Menu Command" on page 216.

5-2: Sample Parameters

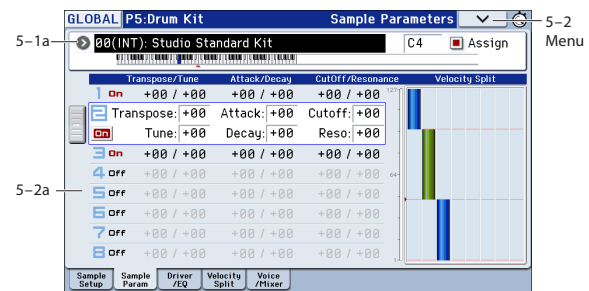

Here, you can adjust the transpose, tune, attack, decay, filter cutoff, and resonance settings for each drum sample. These are offsets that are added to the settings of the program.

5-2a: Parameters (Drumsample Parameters)

1: (Drumsample 1)

Drumsample 1 On/Off [Off, On]

This parameter is linked with "5-1b: Drumsample" Drumsample 1.

On (checked): Check this if you want to use Drumsample 1. The selected drum sample will sound.

Off (unchecked): Drumsample 1 will not be used. The drum sample will not sound.

Transpose [-64...+63]

Adjusts the pitch in semitone steps.

+12 is one octave up, and -12 is one octave down.

Tune [-99...+99]

This adjusts the pitch in cents, over a range of ±1 octave. A cent is 1/100 of a semitone.

Attack (Amp EG Attack) [-64...+63]

Adjusts the attack time of the volume (Amplifier). The attack time for each key is determined by adding this value to the amp EG Attack Time of the program that uses this drum kit.

Decay (Amp EG Decay) [-64...+63]

Adjusts the decay time of the volume (Amplifier). The decay time for each key is determined by adding this value to the amp EG Decay Time of the program that uses this drum kit.

Cutoff (Filter Cutoff) [-64...+63]

Adjust the cutoff frequency of the filter. The cutoff frequency for each key and drum sample is determined by adding this value to the filter **Frequency** (Prog 3-1b) of the program that uses this drum kit.

Reso (Filter Resonance) [-64...+63]

This adjusts the filter resonance. This offset value for each key and drum sample is applied to the filter **Resonance** (Prog 3-1b) of the programs that use this drum kit.

2...8: (Drumsample2...8)

Here, you can edit the sample parameters for Drumsample 2–8. For more information, please see "1: (Drumsample 1)" above.

✓ 5-2: Menu Command

- 0: Write Drum Kits see p. 220

- 1: **Rename Drum Kit** see p. 220
- 2: **Copy Drum Kit** see p. 220
- 3: **Copy Key Setup** see p. 220
- 4: **Swap Key Setup** see p. 220

For more information, please see “Global: Menu Command” on page 216.

5–3: Driver/EQ

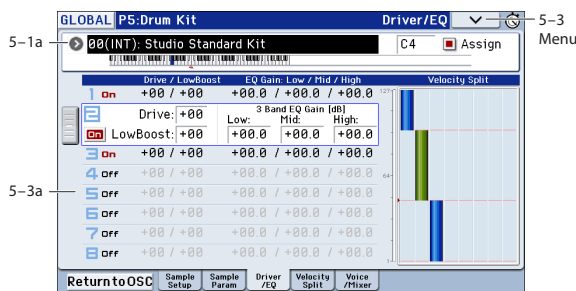

Here, you can adjust the drive and the gain of the three-band EQ for each drum sample. These are offsets that are added to the settings of the program.

5–3a: Driver/EG

1: (Drumsample 1)

Drumsample 1 On/Off [Off, On]

This parameter is linked with “5–1b: Drumsample” Drumsample 1.

On (checked): Check this if you want to use Drumsample 1. The selected drum sample will sound.

Off (unchecked): Drumsample 1 will not be used. The drum sample will not sound.

Drive [–99...+99]

This adjusts the drive level. This offset value for each key and drum sample is applied to the driver **Drive** (Prog 4–1a) setting of the programs that use this drum kit.

Low Boost (Driver Low Boost) [–99...+99]

This adjusts the low boost level of the driver. This low boost setting for each key and drum sample is applied to the driver **Low Boost** (Prog 4–1a) setting of the programs that use this drum kit.

3 Band Parametric EQ [dB]

Low [–36.0...+36.0]

Mid [–36.0...+36.0]

High [–36.0...+36.0]

These parameters adjust the gain for each band of the three-band parametric EQ. The gain settings for each key and drum sample are applied to the **LowGain**, **MidGain**, and **HighGain** (Prog 4–8a) settings of the programs that use this drum kit.

2...8: (Drumsample2...8)

Here, you can edit the sample parameters for Drumsample 2–8. For more information, please see “1: (Drumsample 1)” above.

✓ 5–3: Menu Command

- 0: **Write Drum Kits** see p. 220
- 1: **Rename Drum Kit** see p. 220
- 2: **Copy Drum Kit** see p. 220
- 3: **Copy Key Setup** see p. 220
- 4: **Swap Key Setup** see p. 220

For more information, please see “Global: Menu Command” on page 216.

5-4: Velocity Split

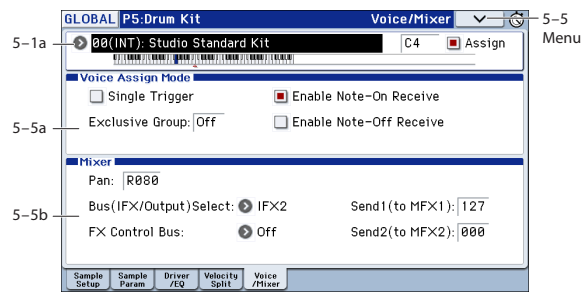

Use **Threshold Vel.** and **Crossfade** to specify the velocity zones sounded by Drumsample 1-8.

5-4a: Velocity Split

1: (Drumsample1)

Drumsample 1 On/Off [Off, On]

This parameter is linked with "5-1b: Drumsample" Drumsample 1.

On (checked): Check this if you want to use Drumsample 1. The selected drum sample will sound.

Off (unchecked): Drumsample 1 will not be used. The drum sample will not sound.

Threshold Vel. (Threshold Velocity) [1...127]

This sets the lowest velocity at which the drum sample will sound. Drumsample 1's **Threshold Vel.** can be equal to, but not lower than, than that of Drumsample 2.

You can change the **Threshold Vel.** value by touching the graphic at the right and dragging it (See "EG, Velocity Split" on page 6 of the Operation guide. ").

Crossfade (Crossfade Range) [Off, 1...127]

This specifies the velocity range starting at **Threshold Vel.** over which Drumsample 1 will fade-out and Drumsample 2 will fade-in.

For instance, if the **Threshold Vel.** is set to 64, and the **Crossfade** is set to 20, Drumsample 2 will start to fade in at velocities of 84 and below.

When velocities are within the **Crossfade**, the Oscillator will use twice as much polyphony as it would normally.

Note: You can only fade between two zones at once.

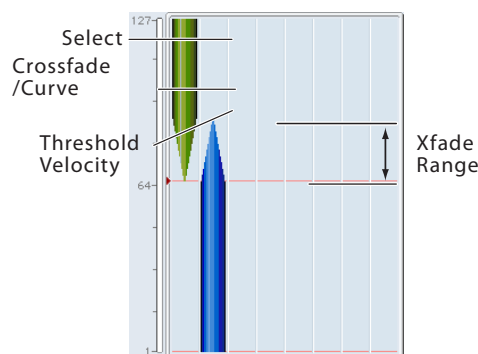

Curve (Crossfade Curve) [Linear, Power, Layer]

This controls the volume curve of the crossfade. **Linear** and **Power** (short for Equal Power) let you fine-tune the way that the two drum samples mix together; one or the other may be more appropriate for a given pair of drum samples. **Layer**, true to its name, lets you layer the two drum samples together without any crossfading.

Linear means that the two samples will each be at 50% of their full volume in the middle of the crossfade. Sometimes, this may create a dip in the volume level; if so, try using **Power** instead.

Power, short for Equal Power, means that the two samples will each be at around 70% of their full volume in the middle of the crossfade. Sometimes, this may create a bump in the volume level, in which case you might try selecting **Linear** instead.

Layer means that the two drum samples will be layered together, both at full volume, for the entire range of the crossfade.

Crossfade Curves

Linear

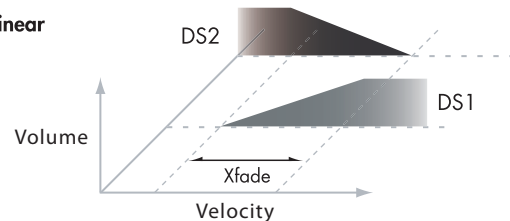

Power

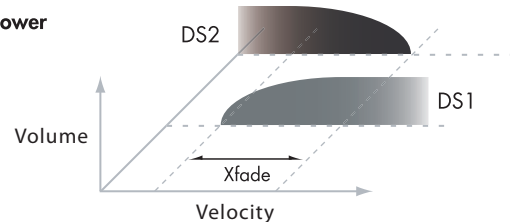

Layer

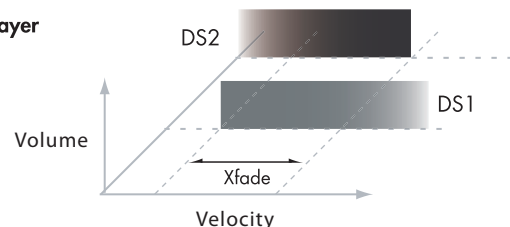

2...8: (Drumsample2...8)

Here, you can edit the sample parameters for Drumsample 2-8. For more information, please see "1: (Drumsample1)" above.

The parameters for Drumsample 8 are also similar to those for Drumsample 1, except that Drumsample 8 has no settings for Threshold (which is always fixed at 1), Crossfade, or Curve.

5-4: Menu Command

- 0: Write Drum Kits see p. 220
- 1: Rename Drum Kit see p. 220
- 2: Copy Drum Kit see p. 220
- 3: Copy Key Setup see p. 220
- 4: Swap Key Setup see p. 220

For more information, please see "Global: Menu Command" on page 216.

5-5: Voice/Mixer

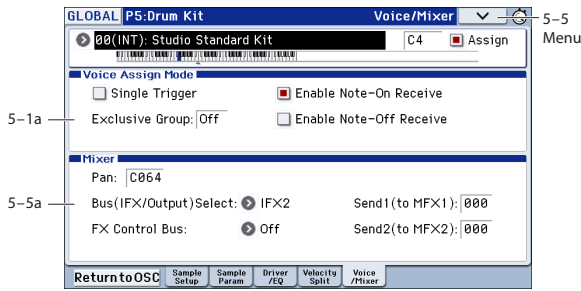

Specify the voice assign, pan, and effect routing etc. for each key of the drum kit.

5-5a: Voice Assign Mode

Single Trigger [Off, On]

On (checked): Even when the same key (note) is played repeatedly, the previous note will be halted before the new note is begun, so that the notes will not overlap. Normally you will leave this unchecked.

Exclusive Group (Exclusive Assign) [Off, 001...127]

001-127: This allows you to assign keys to any of 127 groups. Keys assigned to the same group will be treated as a single group, and will be played monophonically with last-note priority. For example you might assign closed and open hi-hat sounds to the same group so that two or more hi-hat sounds can not sound simultaneously.

Off: Keys will not be grouped. This is the default setting.

Enable Note On Receive [Off, On]

On (checked): Note-on messages will be received. Normally you will check this, but you can uncheck it if you do not want specific notes to sound.

Enable Note Off Receive [Off, On]

On (checked): Note-off messages will be received. Normally you will uncheck this. This parameter is valid when **Hold** (Prog 1-2a) is checked (Hold On). In the case of a drum program, you will normally select Hold On. In this case if **Enable Note Off Receive** is checked, note-off messages will be received, and the sound will stop (the release segment of the EG will begin) when the key is released.

5-5b: Mixer

In Program mode, Drum kits will sound using the settings of the selected program. **Pan** is valid if **Use DKit Setting** (Prog 4-1c) is checked. **Bus (IFX/Output) Select**, **FX Control Bus**, and **Send 1/2** are valid if **Use DKit Setting** (Prog 8-1c) is checked. Be aware that while editing a drum kit, the edited results will not be reflected unless these settings have been made.

Pan [Random, L001...C064...R127]

Specifies the panning for each key.

L001 places the sound at far left, and **R127** places the signal at far right. With a setting of **Random**, the drum sample will be panned randomly at each note-on.

Bus (IFX/Output) Select [L/R, IFX 1...5, Off]

For each key, specify the bus to which the sound will be sent. For example, you might send Snare sounds to IFX1 and Kick sounds to IFX2 to apply separate insert effects, and send the remaining sounds to L/R without applying insert effects.

Tip: In most of the preloaded drum kits, the following types of drum instrument have the same **Bus (IFX/Output) Select** settings.

- Snares → IFX1
- Kicks → IFX2
- Other → IFX3

FX Control Bus [Off, 1, 2]

For each key, you can select whether the signal will be sent to FX Control bus (stereo two-channel) FX Ctrl1 or 2.

Normally you will leave this off, but you can use this setting if you want to control an effect by playing a specific key.

You can use this with the following effects:

Vocoders:

174: Vocoder

Compressor and gate-type effects:

003: Stereo Limiter

006: Stereo Gate

Example: Gated Reverb

This is an example of applying a gated reverb to a specific snare sound. When using a gate effect on reverb, you may not be able to control the gating timing correctly if you use the extended reverberant sound to control the gate. Normally, you will control the gate using sound from before reverb is applied.

For the key for which you've selected the snare sample, set **Bus (IFX/Output) Select** to IFX4. Also use **FX Control Bus** to send the signal to FX Control Bus 1. In IFX5: Stereo Gate, choose FX Control 1 as the Envelope Source. Now you can use a signal other than the input (reverberant sound) to control the gate.

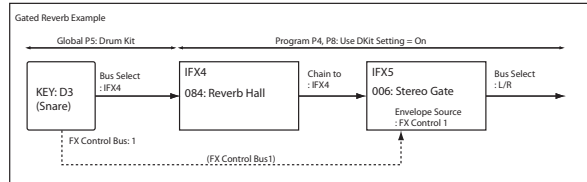

Send1 (to MFX1) [000...127]

Send2 (to MFX2) [000...127]

For each key, specify the send levels to master effects 1 and 2.

These settings are valid when **Bus (IFX/Output) Select** is set to L/R or Off. If **Bus (IFX/Output) Select** is set to IFX1-5, the send level to master effects 1 and 2 will be determined by the Program, Combination, or Sequencer mode P8: Routing/IFX-Insert FX Setup page parameters **Send1** and **Send2** which are located after the sound passes through IFX1-5.

✓ 5-5: Menu Command

- 0: **Write Drum Kits** see p. 220
- 1: **Rename Drum Kit** see p. 220
- 2: **Copy Drum Kit** see p. 220
- 3: **Copy Key Setup** see p. 220
- 4: **Swap Key Setup** see p. 220

For more information, please see "Global: Menu Command" on page 216.

Global P6: Arpeggio Pattern

Here, you can create user arpeggio patterns.

In this page, the KROME will continue to sound as it did before entering Global mode.

If you entered Global mode from Program mode: Your editing will apply to the arpeggio pattern that is selected by the program. Even if the previously selected program's arpeggiator is turned off, it can be turned on by the ARP button.

If you entered Global mode from Combination mode: Your editing will apply to the arpeggio pattern that is selected by the combination. Even if the previously selected combination's arpeggiator is turned off, it can be turned on by the ARP button.

However, it is not possible to turn on an arpeggiator for which the **Arpeggiator Run** (Combi P0: 0-5(6)a, P7: 7-1(2)c) parameter A or B is not checked. Additionally, the arpeggiator will not operate if it has not been assigned to a timbre in **Arpeggiator Assign** (Combi P7: 7-1(2)c).

If you entered Global mode from Sequencer mode: Your editing will apply to the arpeggio pattern specified for the selected song. Even if you entered Global mode from settings in which the arpeggiator was turned off, you can use the ARP button to turn it on.

However, it is not possible to turn on an arpeggiator for which the **Arpeggiator Run** (Seq P7: 7-1(2)c) parameter A or B is not checked. Additionally, the arpeggiator will not operate if it has not been assigned to a track in **Arpeggiator Assign** (Seq P7: 7-1(2)c).

In each of the above cases, you can modify the settings of the arpeggio pattern even if the arpeggiator is not turned on. When editing a pattern, it is a good idea to turn on the arpeggiator and make sure that it is the pattern that you wish to edit.

 If you want the edited user arpeggio pattern settings to be backed up even when the power is turned off, you must write them into memory. Select the **Write Arpeggio Pattern** menu command to access the Write Arpeggio Pattern dialog box. Alternatively, press the WRITE button to access the **Update Arpeggio Patterns** dialog box. Then press the OK button to write the edited data.

 When you edit a user arpeggio pattern, your edits will affect all programs and combinations that use the edited pattern. If you want to edit one of the preload arpeggio patterns, it's a good idea to copy that arpeggio pattern to an unused area in the user bank before you edit it.

For details on creating an arpeggio pattern, see OG p.91.

6-1: Pattern Setup

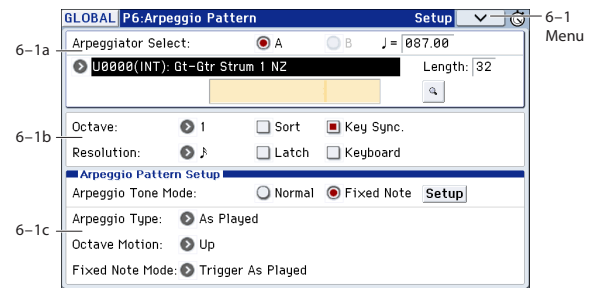

6-1a: Arpeggio Select, , Pattern, Length

Arpeggio Select

[A, B]

If the KROME was previously in Combination or Sequencer mode and you want to edit an arpeggio pattern, you must select either arpeggiator A or B as the pattern to edit. Your editing will apply only to the selected one. B will not be displayed if the previous mode was Program mode.

(Tempo)

[040.00...300.00, EXT]

Specifies the tempo.

This can also be adjusted by the TEMPO knob. You can also use the [TEMPO] knob to adjust the tempo. If MIDI Clock (Global 1-1a) is set to Auto and MIDI clock data is being received from an external device, or if External MIDI or External USB is selected, this parameter's value is shown as EXT, and the arpeggiator will synchronize to the incoming MIDI clock data from the external MIDI device.

Pattern

[P0: UP...P4: RANDOM, U0000(INT)...U1027(USER)]

Selects the pattern that you want to edit.

| | |
|---------------------------|-----------------------------|
| P0: UP...P4: RANDOM | Preset arpeggio patterns |
| U0000(INT)...U0899(INT) | Preloaded arpeggio patterns |
| U0900(USER)...U1027(USER) | User arpeggio patterns |

Note: If you want to edit an arpeggio pattern (such as a preloaded arpeggio pattern) that is also used by another program, it is a good idea to use the menu command **Copy Arpeggio Pattern** to copy the arpeggio pattern to an unused number U0900(USER)...U1027(USER), and then to edit the copy.

Note: If you want to edit the arpeggio pattern name, execute the menu command **Rename Arpeggio Pattern**.

Length (Pattern Length)

[01...48]

Specifies the length of the arpeggio pattern. The arpeggio pattern will play the number of steps you specify here at the note value interval specified by **Resolution**, and will then begin again. This is not valid for preset arpeggio patterns P0-P4.

Arpeggio Pattern Preview

This shows a graphic representation of the steps in the user arpeggio pattern.

If Arpeggio Tone Mode is set to Fixed Note, the step graphics are shown as hollow circles.

(Arpeggio Pattern Edit Jump)

This opens the Arpeggio Pattern Edit dialog box.

6-1b: Octave, Resolution, Sort, Latch, Key Sync., Keyboard

| | |
|-------------------|---|
| Octave | [1, 2, 3, 4] |
| Resolution | [ |
| Sort | [Off, On] |
| Latch | [Off, On] |
| Key Sync. | [Off, On] |
| Keyboard | [Off, On] |

For more information, please see “7-1: ARP Setup” on page 53.

 **Pattern, ↓(Tempo), Octave, Resolution, Sort, Latch, Key Sync., and Keyboard** are parameters that can be set in Program, Combination, Song, and Song Play modes, but you can also set them here.

If you move here from Program or Combination mode and set these parameters, you must return to the original mode and write them. These parameters cannot be written by the **Write Arpeggio Patterns** command in this page.

6-1c: Arpeggio Pattern Setup

 These parameters are not valid for preset patterns P0-P4.

Arpeggio Tone Mode [Normal, Fixed Note]

This selects the **Tone** type of the arpeggio pattern.

Normal: This is the conventional arpeggiator type. Each Tone in the arpeggio will play based on the note number of the keys that you are pressing on the keyboard.

Fixed Note: The note number of each tone is fixed. The note numbers played on the keyboard will be ignored, and the arpeggio will sound using specified pitches. Note numbers from the keyboard will only control the trigger timing of the arpeggiator. Fixed Note mode is ideal for arpeggio patterns that you are using as drum patterns.

In the P6: User Arpeggio, Pattern Edit page, the Tone indicators will be “●” when Normal is selected here, or “○” when Fixed Note is selected.

Arpeggio Type [As Played...Up&Down]

Specifies the relationship between the arpeggio notes specified from the keyboard and the Tone at each step.

As Played: If there are more Tones in a step than arpeggio notes specified (notes played on the keyboard), those steps will not sound.

As Played (Fill): If there are more Tones in a step than arpeggio notes specified (notes played on the keyboard), the last-played note (**Sort** is Off), or the highest note (**Sort** is On) will sound for those steps.

Running Up: If there are more Tones in a step than arpeggio notes specified (notes played on the keyboard), the arpeggio will return to the first note (if **Sort** is Off), or the lowest note (if **Sort** is On) and sound it.

Up&Down: If there are more Tones in a step than arpeggio notes specified (notes played on the keyboard), the arpeggio will return in reverse direction from the last arpeggio note back toward the first.

Example)

If you set **Length** to 04, **Step No.** 01 to Tone0, **Step No.** 02 to Tone1, **Step No.** 03 to Tone2, **Step No.** 04 to Tone3, and simultaneously play three notes to produce an arpeggio, the following results will be produced depending on the **Arpeggio Type**.

As Played: 0 → 1 → 2 → rest → 0 → 1 → 2 → rest → 0 ...

As Played (Fill): 0 → 1 → 2 → 2 → 0 → 1 → 2 → 2 → 0 ...

Running Up: 0 → 1 → 2 → 0 → 0 → 1 → 2 → 0 → 0 ...

Up&Down: 0 → 1 → 2 → 1 → 0 → 1 → 2 → 1 → 0 ...

Octave Motion [Up, Down, Both, Parallel]

Specifies the operation when **Octave** is set to 2-4 octaves.

Up: Notes will repeatedly ascend within the specified range of octaves.

Down: Notes will repeatedly descend within the specified number of octaves.

Both: Notes will repeatedly ascend and descend within the specified number of octaves.

Parallel: The notes of the specified octaves will sound simultaneously.

Fixed Note Mode

[Trigger As Played, Trigger All Tones]

When the **Arpeggio Tone Mode** is Fixed Note, specifies the condition that will trigger the Tones.

Trigger As Played: The **Tones** will be triggered according to the number of keys pressed.

Trigger All Tones: Pressing a single key will trigger all **Tones**.

Example)

We will use an **Arpeggio Tone Mode** Fixed Note pattern on drums. Tone 0 is assigned a note number that will sound a kick, Tone 1 a snare, and Tone 2 a hi-hat.

With a setting of **Trigger As Played** and **ArpeggioType** is **As Played**, pressing one key will sound only Tone 0 (kick). Pressing two keys will sound Tone 0 (kick) and Tone 1 (snare). Pressing three keys will sound all three Tones 0-2 (kick, snare, hi-hat). If the **Velocity** of each Tone is set to **Key**, each Tone will be sounded at the velocity with which each key was played.

With a setting of **Trigger All Tones**, playing one key is sufficient to sound all three; Tone 0 (kick), Tone 1 (snare), and Tone 2 (hi-hat). If the **Velocity** of each Tone is set to **Key**, the Tones will be sounded at the corresponding velocity each time a key is pressed.

(Fixed Notes) Setup

This opens the Fixed Notes dialog box. Here you can specify the notes that will be used when **Arpeggio Tone Mode** is set to Fixed Note.

| Fixed Notes | |
|-------------|-----|
| 11: | C1 |
| 10: | C#1 |
| 9: | D1 |
| 8: | D#1 |
| 7: | E1 |
| 6: | F1 |
| 5: | F#1 |
| 4: | G1 |
| 3: | G#1 |
| 2: | A1 |
| 1: | A#1 |
| 0: | B1 |

Done

Arpeggio Pattern Edit

Here you can input Tones 0–11 for each Step 01–48. There can be up to 48 **steps**, and the **tones** represent the notes of the scale (a maximum of 12 notes) that you can press simultaneously at each step. If the **Sort** check box (Global 6-1a) is selected, the notes you press simultaneously will be sorted from low to high, and assigned to 0, 1, ... 11. If the **Sort** check box is not selected, the notes will be assigned to 0, 1, ...11 in the order in which you press them.

 These parameters are not valid for preset patterns P0–P4.

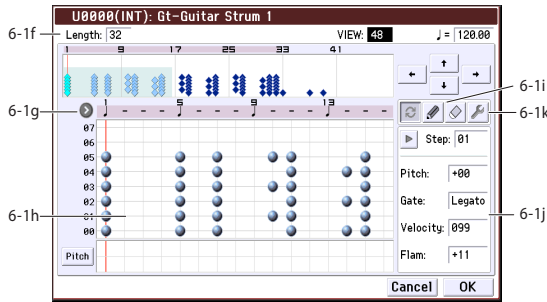

6-1f: Tempo, Length, Zoom Scroll, VIEW, Overview

(See “6-1a: Arpeggio Select, ↓, Pattern, Length” on page 211.)

Length (Pattern Length) [01...48]

(See “Length (Pattern Length)” on page 213.)

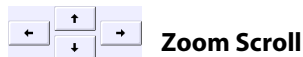

Zoom Scroll

Use these to move the zoomed area horizontally (Steps) or vertically (Tones), in increments of half the area. To make approximate movements, touch and drag the overview. To make fine adjustments, use the zoom scroll buttons.

VIEW [32, 26, 42, 48]

This specifies an approximate limit for the area of the overview display. If you set this appropriately for the selected **Length** and **Resolution**, it may be easier to select the zoom area.

Overview

The arpeggio pattern is shown as  symbols. The region that is zoomed in the touch grid is highlighted. To select this, use the zoom scroll buttons located above, or touch and drag the overview.

6-1g: Resolution

See “Resolution*” on page 54.

6-1h: Touch Grid

Tone Panel

You can insert or delete Tones by pressing the tone panel grid in the upper part of this area. Use the Tone Input Mode (6-1i) buttons to select the input method.

On the left, tone numbers are shown if **Arpeggio Tone Mode** is Normal, or note names are shown if the **Arpeggio Tone Mode** is Fixed Note.

Parameter Panel

The parameter panel in the lower part of this area shows a graphic representation of the selected step parameter (6-1j). You can touch and drag to edit this.

You can select a step by pressing the panel.

Step Parameters Select button

This button selects the specific step parameter that will be shown in the parameter panel below.

Each time you press the button, the displayed step parameter will cycle through the following choices: Pitch (Pitch Offset) → Gate → Vel. (Velocity) → Flam → Pitch ...

6-1i: Tone Input Mode

Use these buttons to select the mode you'll use to enter notes in the tone panel.

Alternate mode

Tones will be inserted or deleted.

Pen mode

Tones will be inserted.

Eraser mode

Tones will be deleted.

Tool mode

Opens the Tool Tablet, allowing you to specify a region and delete, insert, or copy data.

6-1j: Step Parameters

Step (Step Number) [01...48]

Use this to select the step that you want to edit.

If **Step** is selected, you can also enter tones by pressing the numeric keys. [0]–[9] correspond to tones 0–9, [-] corresponds to tone 10, and [.] corresponds to tone 11. The numeric keys will enter tones as prescribed by the tone input mode you selected.

If the “” button at the left is on, this field will be synchronized with the step of the arpeggiator when it is running.

Pitch Offset [–48...+48]

For each step, the pitch corresponding to the **Tone** can be raised or lowered in semitone steps. This lets you make settings for the same tone in each step to create a melody, or to make settings for two or more tones in each step to play parallel chords.

Gate [Off, 001...100%, Legato]

Off: Even if a tone has been entered, it will not sound at that step. You can also use this to stop a legato tone that was previously sounding.

Legato: The tone will continue sounding until the same tone is played again (including Gate: Off) or the pattern returns to its beginning.

The Legato setting is valid if the **Gate** parameter (Prog P7: 7-1b, Combi P7:7-3(4)c, Seq P7:7-3(4)c) of each program, combination, or song is set to Step. If you specify Legato, make sure that the **Gate** of the previous mode is set to Step.

Velocity**[001...127, Key]**

Key: The Tone of the step will sound with the velocity at which the key was played.

001–127: The specified velocity value will always be used.

This setting is valid when the Program, Combination, or Song parameter **Velocity** (Program P7: 7–1b, Combination P7: 7–3(4)c, Sequencer P7: 7–3(4)c) is set to **Step**.

When making this setting, make sure that **Velocity** is set to **Step** in the previous mode before entering this page.

Flam**[–99...+99]**

Specifies how the note timing will be skewed when two or more **Tones** are specified in the same step.

00: All **Tones** will sound simultaneously.

+01–+99: The timing of the notes will be skewed in the order of the Tone number. (When **Sort** is ON, from low note to high note. When **Sort** is OFF, in the order in which keys were pressed.)

–01– –99: The timing of the notes will be skewed in the opposite direction as “+.”

To simulate chords strummed on a guitar, try setting “+” values for odd-numbered steps and “–” values for even-numbered steps.

This is not valid for preset patterns P0–P4.

6-1k: Fixed Note Setup

This button opens the Fixed Notes dialog box. Here you can select the notes used when **Arpeggio Tone Mode** is set to Fixed Note.

Tool Tablet

To open the tool tablet, press the tool mode button in the tone input mode area. This tablet contains an Area Tools tab and a Copy Tools tab.

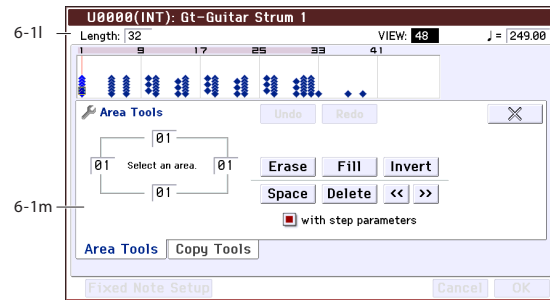
**6-1l: Tempo, Length, VIEW, Overview**

(See “6-1f: Tempo, Length, Zoom Scroll, VIEW, Overview” on page 213.)

6-1m: Area Tools/Copy Tools**Select an area****[01...48, 00...11]**

Use **Select an area** to specify the area where you want to execute a command. The parameters to the left and right specify the range of steps, and the parameters above and below specify the range of tones.

You can also select an area by touching and dragging in the overview.

Undo, Redo

These buttons undo or redo a command you executed. Undo will cancel the result of the command that you previously executed. Redo will once again execute the command that was cancelled by Undo. These actions also affect tone input in Arpeggio Pattern Edit.

Close

Press the Close button to close the tool tablet.

Area Tools**Erase**

Erases all tones in the selected area. (The various step parameter values will be preserved.)

Fill

Inserts all tones in the selected area. (The various step parameter values will be preserved.)

Invert

Inverts the inserted/deleted state of the tones in the selected area. (The various step parameter values will be preserved.)

Unlike the commands listed above, executing the following commands will cause tones to move. Normally you'll execute the following commands on a specified region of tones 00--11.

Space

Inserts blank space in the selected area. Step parameters will be set to their default values.

When the blank space is inserted, tones following that location will move to the right.

If the **with step parameters** option is selected, the step parameter values will also move.

Delete

Deletes the selected region.

Data to the right of the selected region will move toward the left to fill the gap.

If the **with step parameters** option is selected, the step parameter values will also move.

<<, >>

Cycles the tones within the selected region.

If the **with step parameters** option is selected, the step parameter values will also be cycled.

with step parameters

If this option is selected, the step parameters will also be affected when you execute the **Space**, **Delete**, <<, or >> commands.

Copy Tools

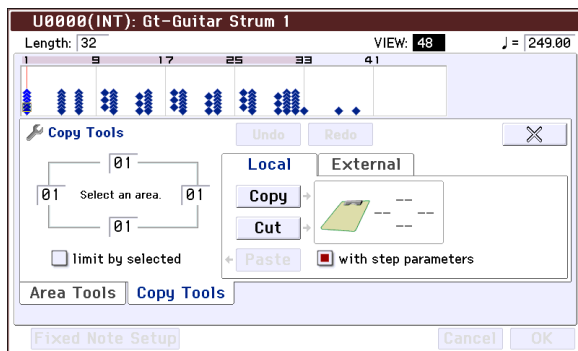

Local:

Copy

Copies the selected region to the copy buffer.

Cut

Copies the selected region to the copy buffer, and then deletes it.

Paste

This command is available if there is data in the copy buffer. Specify a region, and then paste (overwrite) the data from the copy buffer.

If the **w/ step param** (with step parameter) option is selected, the step parameter values will also be pasted.

The data from the copy buffer will be pasted so that the lower left point of the region specified when copying will be at the lower left point of the region you specify before executing the Paste command.

w/step parameters (with step parameters)

If this option is selected, the step parameters will also be copied when you execute the **Paste** command.

limit by selected

If this option is selected, the data from the copy buffer will be pasted only to the extent of the region you specify before executing the Paste command.

If this option is cleared, all of the data from the copy buffer will be pasted.

Example) Moving the tones of the first and second beats

1. In "Select an area," specify the area as 11/00 (vertical) – 01/16 (horizontal), and then press the Cut button.
2. Specify the area as 11/01 (vertical) – 01/16 (horizontal), and then press the Paste button.

The first half will move upward.

External:

Here you can copy the settings of a different user arpeggio pattern.

By using **limit by selected**, you can create patchwork edits that are more sophisticated than simply using **Copy Arpeggio Pattern**.

(Copy From)

Selects the copy-source arpeggio pattern.

* This function is not available if the copy-source arpeggio pattern is the same as the currently-edited pattern.

limit by selected

If this option is selected, only the specified region of the copy-source arpeggio pattern will be copied.

If this option is cleared, the entire pattern will be copied just as when using **Copy Arpeggio Pattern**.

Print

Inserts the selected arpeggio pattern.

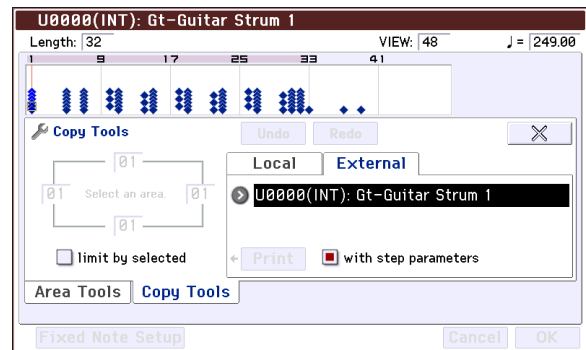

✓ 6-1: Menu Command

- 0: **Write Arpeggio Patterns** see p. 221
- 1: **Rename Arpeggio Pattern** see p. 221
- 2: **Copy Arpeggio Pattern** see p. 221

For more information, please see "Global: Menu Command" on page 216.

Global: Menu Command

Tip: In each page, you can access (or switch on/off) up to the first ten menu commands by holding down the ENTER button and pressing the corresponding numeric key, 0–9.

Tip: While this command is open, the ENTER button will operate as the OK button and the EXIT button will operate as the Cancel button.

Procedure for menu commands

1. Select the menu command.

2. Make settings in the dialog box.

For details on the content of each dialog box, refer to the following explanations of each command.

3. To execute, press the OK button. To cancel without executing, press the Cancel button.

Write Global Setting

Write Global Setting is available on all of the tabs under the Basic Setup, MIDI, Controllers, Scales, and Category pages.

This command writes Global mode settings (except for Drum Kits and Arpeggio Patterns).

Note: You can also access and execute this command by pressing the WRITE button.

Note: To save the drum kit, execute the P5 menu command. (“Write Drum Kits”)

Note: To save the arpeggio pattern, execute the P6 menu command. (“Write Arpeggio Patterns”)

 The Effect Global SW setting will not be saved.

Load Preload/Demo Data

Load Preload/Demo Data is available on the Basic Setup page.

This command loads the preloaded data and demo song data into the KROME.

 Before you can load this data, you must navigate to **Memory Protect** (Global 0–1b) and un-check the protect setting for the type of data you want to load. If you execute this operation with the protect setting checked, the display will indicate “Memory Protected,” and the data will not be loaded.

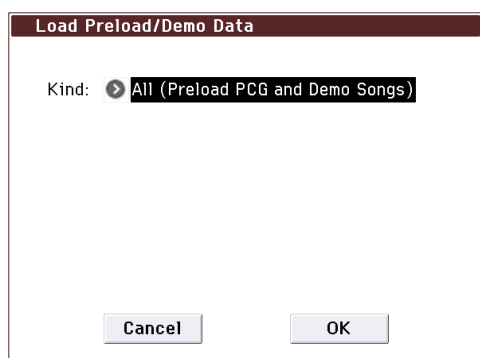

1. Use Kind to select the type of data you want to load.

| Kind | Content |
|----------------------------------|---|
| All (Preload PCG and Demo Songs) | All PCG (Program, Combination, Global settings, drum kit, , arpeggio pattern), and demo song data |
| All Preload PCG | All PCG data |
| All Demo Songs | All demo song data |
| Program | Program data |
| Combination | Combination data |
| Drum Kit | Drum kit data |
| Arpeggio Pattern | Arpeggio pattern data |
| Global Setting | Global setting data |

2. If you selected **Program, Combination, Drum Kit, or Arpeggio Pattern** as the Kind, specify the range of data that you want to load.

All: load all data

Bank: load an individual bank

Single: load one item of data

3. If you’re loading **Bank or Single**, use **To** to specify the loading-destination.

Change all bank references

Change all bank references is available on the Basic Setup page.

This command changes all program banks specified for timbres in combinations or tracks of songs.

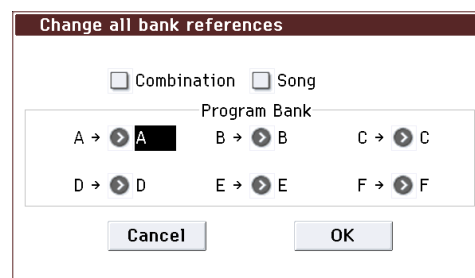

1. If you wish to change bank references for combinations, check **Combination**.

If you wish to change bank references for songs, check **Song**.

2. In **Program Bank**, specify the replacement for each bank.

 If you change two or more different banks to the same bank, it will not be possible to use this function to change them back to different banks. Be careful that the change destination banks do not overlap.

Display Setup

This lets you adjust the brightness of the display.

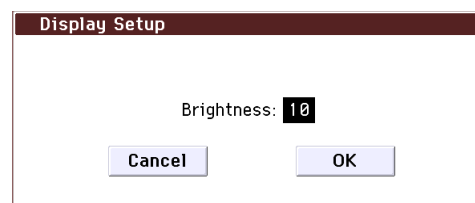

1. Choose **Display Setup** to open the dialog box.

2. Adjust the **Brightness** as desired.

Brightness: 0...10 (10 is the default)

Touch Panel Calibration

If your input in the display is not detected as you expect, or if the edit cell moves to a location in the display other than where you pressed, you should calibrate the display as follows.

To ensure optimal calibration, touch the center of each symbol (calibration target) shown in the corners of the display as accurately as you can.

1. Choose "Touch Panel Calibration" to access the dialog box.

If you're unable to choose this command from the page menu, you can access it by holding down the ENTER button in P0 and pressing the 3 button.

2. Lightly press the center of the target that appears in the upper left of the screen.

If you decide to cancel the operation, press the EXIT button.

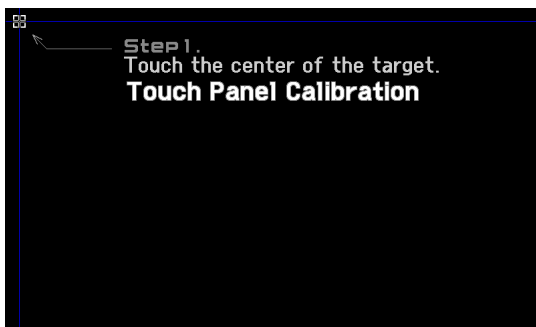

When your touch on the target has been detected, the target will move.

3. Lightly press the center of the target that appears in the lower right of the screen.

If you decide to cancel the operation, press the EXIT button.

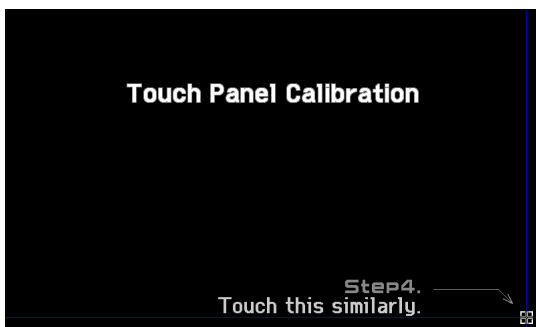

When your touch on the target has been detected, the touchscreen will be calibrated, and the screen will ask you to verify the result.

4. Touch the three targets to verify that calibration was successful.



When you touch a target, a ball-shaped symbol will appear.



The closer the center of the ball is to the center of the target, the more accurately calibration was performed. You can press the target again as many times as you like.

5. If desired, you can press the Redo button to return to step 2 and perform the calibration again.
6. If you are satisfied with the touch response, press the OK button (or the ENTER button) to end the procedure.
7. Press the EXIT button, and you will return to the state prior to executing the calibration function.



If in steps 2 or 3 you pressed a screen location that was significantly distant from the center of the "+" target, the detection points for the Redo button and OK button will also be skewed. If you're unable to press these buttons successfully, try pressing the area around them. Alternatively, press the EXIT button to exit the procedure, and then perform the Touch Panel Calibration operation once again.

Half Damper Calibration

Half Damper Calibration is available on the Basic Setup page.

If a damper pedal that supports half damper (the DS-1H option) is connected to the DAMPER jack, here's how you can adjust the sensitivity if the damper effect is not applied appropriately.



Since the half-damper pedal is highly sensitive, please use the optional DS-1H. Other pedals may not produce the appropriate effect, or may be impossible to calibrate correctly.

1. Connect a half-damper pedal to the DAMPER jack.
2. Select "Half Damper Calibration" to open the dialog box.
3. Press the half-damper pedal, and then release your foot from the pedal.
4. Press the Done button.

If the adjustment could not be performed correctly, an error message will be displayed. Please perform the procedure once again.

Update System Software

Update System Software is available on the Basic Setup page.

Here, you can update the KROME system.

You can download the latest system file onto your computer from the Korg website (<http://www.korg.com/>). For details, please see the Korg website.

 Before you begin the system update, you should back up your important data on an SD card.

1. Insert the SD card containing the system file into the SD card slot of the KROME.

Note: For details on how to copy the system file to your SD card, please see the explanation on the download page of the Korg website.

2. Access the **Global P0: Basic Setup** page.
3. Select “Update System Software” to open the dialog box.

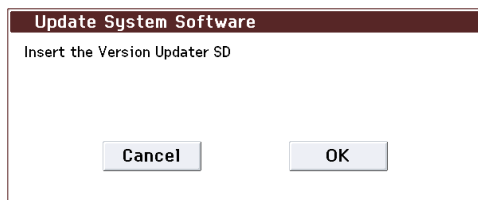

4. Press the OK button to execute the update.

A dialog box will ask you for confirmation. Press the OK button to begin updating the system software.

Note: If an error message of “File/path not found” appears, press the OK button and proceed again from step 1.

 While the system is being updated, do not touch the KROME’s switches, and never turn off the power. If the power is accidentally turned off while the system is being loaded, the KROME may become inoperable. If this occurs, please contact your local Korg distributor.

5. When the update has been completed, a dialog box with the following message will appear.

The system update has now been installed. To complete the process, you must now restart the KROME. Please turn the power off, and then on again.

Completed. Please turn the power off, and then on again.

6. Power-off the KROME. Wait for several seconds, and then turn the power on again.

 After you turn the power off, wait for several seconds before you restart the KROME.

The system version number is shown in the lower center of the opening screen. Verify that it matches the new system software version.

Dump:

Dump Program

Dump Combination

Dump Drum Kit

Dump Arpeggio Pattern

Dump Global Setting

Dump Sequencer

Dump Drum Track Pattern

These commands are available on the MIDI page.

These commands allow the KROME internal data to be transmitted to another KROME, MIDI data filer, or computer in the form of MIDI System Exclusive data.

Select the desired command (please see the following table), and a dialog box will appear.

Then, select the bank or timbre etc. of the data to be dumped, and press the OK button.

| | |
|-------------------------|---|
| Dump Program | Programs of all banks, programs of one bank, one program |
| Dump Combination | Combinations of all banks, combinations of one bank, one combination |
| Dump Drum Kit | All drum kits, one drum kit |
| Dump Arpeggio Pattern | All arpeggio patterns, one arpeggio pattern |
| Dump Global setting | Global settings (except for the Drum Kits and Arpeggio Patterns of Global mode) |
| Dump Sequencer | All song data and cue list data |
| Dump Drum Track Pattern | All drum track user pattern, one drum track user pattern |

Sending SysEx data dumps

 Do not touch the KROME’s switches or turn off the power while SysEx data is being transmitted.

Sending a data dump

1. Connect the KROME to the device that will receive the data dump.

If you want to transmit the data to a computer that is able to receive SysEx messages, connect the KROME’s USB connector to your computer’s USB connector.

If you want to transmit the data to another KROME or to a MIDI data filer, connect the KROME’s MIDI OUT connector to the MIDI IN connector of the receiving device.

2. Select **Global P1: MIDI** page.
3. The following illustration shows the dialog box that will appear when **Dump Program** is selected.

If to dump one bank select **Bank**, or to dump one program select **Single**.

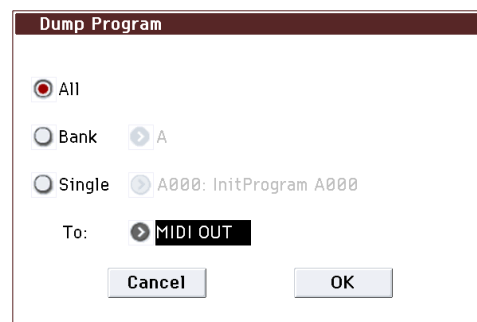

4. Use the To field to select the output connector that will transmit the data.

MIDI OUT: MIDI OUT connector

USB: USB connector

5. Press the OK button to transmit the data.

While the data is being transmitted, the display will indicate "Now Transmitting MIDI Data."

The size of the data and the time required for transmission will depend on the type of data.

The following table shows the size of each data dump, and the time required (MIDI).



| Type of data to be dumped | Data size (Bytes) | Time required MIDI (Sec.) | Time required USB-MIDI (Sec.) ^{*1} |
|---------------------------|---------------------|---------------------------|---|
| Program All | 1307910 | 418.5 | 13.6 |
| Program Bank | 261582 | 83.7 | 2.7 |
| Program Single | 2067 | 0.7 | 0.02 |
| Combination All | 1537848 | 492.1 | 16 |
| Combination Bank | 384462 | 123 | 4 |
| Combination Single | 3027 | 1 | 0.04 |
| Drum Kit All | 704122 | 225.3 | 7.3 |
| Drum Kit Single | 14679 | 4.7 | 0.4 |
| Arpeggio Pattern All | 498163 | 159.4 | 5 |
| Arpeggio Pattern Single | 508 | 0.2 | 0.005 |
| Global Setting | 19835 | 6.4 | 0.3 |
| Sequencer | 23409... 1966831 | 7.5...629.4 | 0.3...20.5 |
| Drum Track Pattern All | 50060... 795060 | 16.0...254.4 | 1...9 |
| Drum Track Pattern Single | 60...740080 | 0.02...236.8 | 0.001...8.4 |

*1: The USB-MIDI dump times listed here are for when the KROME is connected to a computer with a USB 1.1 port. The time required will change depending on the computer system you're using.

Note: More time will be required if the song data contains System Exclusive events, since these must be converted.

 When performing a data dump from the KROME onto a MIDI data filer, do not transmit multiple data dumps together. If multiple data is saved together, then when the data is re-transmitted from the data filer, the KROME will have less than the required time to write the data into memory, and will be unable to receive all of the data correctly.

Receiving SysEx data dumps

-  Do not touch the KROME's switches or turn off the power while SysEx data is being received.
-  Before receiving MIDI data, we recommend that you close any open dialog box or menu, with the exception of the Media mode menu command **Save Exclusive (Receive and Save MIDI System Exclusive Data)** dialog box. Also, data dumps cannot be received while in the Sequencer mode P6: Track Edit- Track View page. Please move to another page, such as P0, before receiving a data dump.
-  After a data dump is received, the KROME will require approximately one second to process the data and write it into memory. During this time, the display will show the message, "Now writing into internal memory." While this message is shown, you must under no circumstances turn off the power of the KROME. If the power is turned off during this time, the KROME may fail to operate correctly when the power is turned on again.

In this case, hold down the EXIT button together with PAGE button, and turn on the power. However, this will initialize the contents of memory.

Transmission and reception of any other MIDI data is also impossible during this time. When receiving multiple data dumps in succession, you must allow enough time between each data dump for the message to disappear from the screen. (see table below)

Processing time (MIDI) for writing into memory

| Type of data dumped | Processing time for writing into memory |
|----------------------|---|
| All Programs | Approximately 1 second (each bank received) |
| All Combinations | Approximately 1 second (each bank received) |
| All Drum Kits | Approximately 1 second |
| All Arpeggio Pattern | Approximately 1 second |
| Global Setting | Approximately 1 second |
| Sequencer | Approximately 1 second |
| Drum Track Pattern | Approximately 1 second |

 MIDI cannot be transmitted or received while data is being written into internal memory. Also, transmission of Active Sensing (FEh) from the MIDI OUT connector and USB connector will be halted.

Receiving a data dump

1. Connect the KROME with the device that will transmit the data dump.

If you're transmitting data from a computer, connect the KROME's USB connector to your computer's USB connector.

If you're transmitting data from another KROME or from a MIDI data filer, connect the target KROME's MIDI IN connector to the MIDI OUT connector of the transmitting device.

2. Set the MIDI channel of the transmitting device to match the KROME's global MIDI channel MIDI Channel (Global 1-1a).

If you want the KROME to receive data that was previously transmitted to a MIDI device, you must set the global MIDI channel of the KROME to the same global MIDI channel that was used when the data was transmitted.

To set the MIDI channel of the transmitting device, please see the owner's manual for that device.

3. Either check **Enable Exclusive (Global 1-2b)**, or display one of the menu commands of this page.

When one of these menu commands is displayed, data dumps can be received regardless of the **Enable Exclusive** setting.

4. Transmit the data from the other device. For the procedure, please see the owner's manual for the device you are using.

While the data is being received, the display will indicate "Now receiving MIDI data."

Reset Controller MIDI Assign

Reset Controller MIDI Assign is available on the MIDI CC# Assign tab of the Controllers page.

This automatically assigns the MIDI control change messages for each controller of the P2: Controllers– MIDI CC# Assign page.

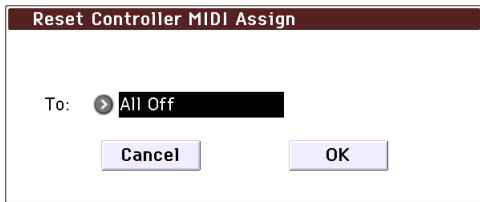

1. Set the To field to the desired reset method.

All Off: All settings will be Off.

Default Setting: The controllers will all be set to Off; the X–Y control will be set to its default CCs.

CC Default: The parameters will be reset to the typical settings, including the standard settings for the controllers.

If you want to use the controllers with an external MIDI device, we recommend using this setting.

(You are also free to assign different MIDI control change messages to the controllers, if you wish.)

The default values are shown in the table below.

Reset Controller MIDI Assign Default

| Controllers \ to | | Default Setting | CC Default |
|------------------|--------|-----------------|------------|
| ARP Controllers | On/Off | CC#14 | (CC#14) |
| | Knob 1 | CC#22 | (CC#22) |
| | Knob 2 | CC#23 | (CC#23) |
| | Knob 3 | CC#24 | (CC#24) |
| | Knob 4 | CC#25 | (CC#25) |

Copy Scale

Copy Scale is available on the Scales page.

This command copies data from a preset scale to a user scale or copies a user scale to another user scale location. For details on the preset scales, please see **Type** (Prog 1–2d).

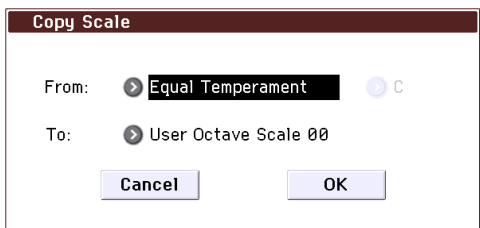

1. Use the From field to select the copy-source scale.

If you select Pure Major or Pure Minor, specify the **Key** (located at the right) as well.

Stretch cannot be selected if **To** is User All Notes Scale.

2. In **To**, selects the copy destination scale.

Write Drum Kits

Write Drum Kits is available on the Drum Kit page.

This saves all drum kits 00 (INT)–47 (USER).

You must write an edited drum kit if you want to keep it. Edited drum kits cannot be recovered if you turn off the power before saving them.

Note: You can also access and execute this command by pressing the WRITE button.

Rename Drum Kit

Rename Drum Kits is available on the Drum Kit page.

This renames a drum kit.

For more information, please see “Editing names” on page 117 of the Operation guide.

Copy Drum Kit

Copy Drum Kits is available on the Drum Kit page.

This command copies the settings of another drum kit to the currently-edited drum kit.

Note: Drum kits 48 (GM)–56 (GM) cannot be edited, but you may copy them to another drum kit and then edit them.

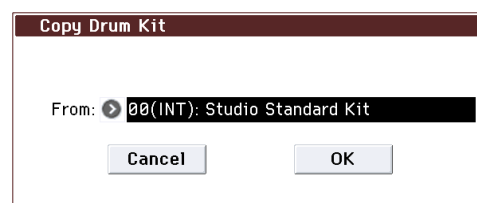

Select the copy source drum kit (**From**).

⚠ When you execute **Copy Drum Kit**, the settings of the currently selected drum kit will be overwritten.

Copy Key Setup

Copy Key Setup is available on the Drum Kit page.

This command copies the settings of an individual key to another key. You can also copy settings from two or more contiguous keys at once.

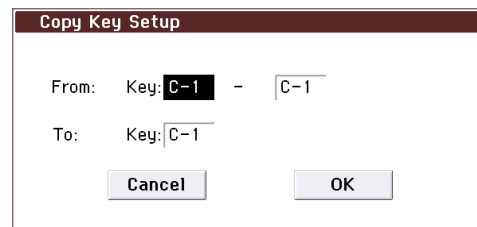

1. In the From Key fields, select the range of keys that you wish to copy.

2. In the To Key field, select the copy destination key. If you selected two or more keys in the From Key field, their settings will be copied to the keys starting at the To Key and continuing upward.

Swap Key Setup

Swap Key Setup is available on the Drum Kit page.

This command exchanges (swaps) the settings of one key with the settings of another key.

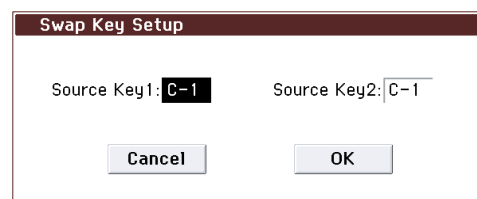

Use Source Key 1 and Source Key 2 to specify the keys whose settings you want to swap.

Write Arpeggio Patterns

Write Arpeggio Patterns is available on the Arpeggio page.

This command writes user arpeggio patterns U0000(INT)–U1027(USER).

Note: You can also access and execute this command by pressing the WRITE button.

 **Pattern**, **Tempo**, **Octave**, **Resolution**, **Sort**, **Latch**, **Key Sync**, and **Keyboard** are parameters that are set in Program, Combination, and Song. The Write operation executed here does not save these parameters.

If you move here from Program or Combination mode and set these parameters, you must return to the original mode and write them.

Rename Arpeggio Pattern

Rename Arpeggio Pattern is available on the Arpeggio page.

This command renames the selected user arpeggio pattern.

Preset patterns P0–P4 cannot be renamed.

For more information, please see “Editing names” on page 117 of the Operation guide.

Copy Arpeggio Pattern

Copy Arpeggio Pattern is available on the Arpeggio page.

This command copies the settings of another user arpeggio pattern to the currently selected arpeggio pattern.

It is not possible to copy from a preset arpeggio pattern P0–P4.

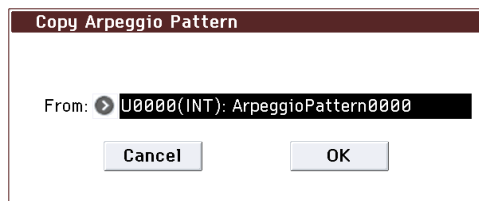

Select the copy source arpeggio pattern **From**.

 Be aware that when you execute **Copy Arpeggio Pattern**, all settings of the currently selected arpeggio pattern will be overwritten.

Media mode

In this mode, you can save internal memory data to an inserted SD card, or load data from media into internal memory. You can also copy or delete files, or format media.

The following media can be used.

SD cards

SD and SDHC memory cards supporting MS-DOS format FAT16 or FAT32 are supported.

SDXC memory cards are not supported.

For more information about handling the SD card, please see the “Inserting/removing a card in the SD card slot” section on page 118 of the Operation Guide.

Files, directories, and icons

The KROME manages data on media in a hierarchical manner, using files and directories. The contents of a file (whether it is a file or a directory) are indicated not only by the name, but also graphically, by an icon. Files and directories have differently shaped icons.

The KROME collectively refers to files and directories recognizable by MS-DOS (readable by an MS-DOS computer), as “DOS files” and “DOS directories.” Different types of DOS file are distinguished by the extension added to their filename.

In the case of a DOS file with an extension other than listed below, selecting **Load selected** to access the dialog box will cause the file to be considered to be a Standard MIDI File (SMF). However, you can't load files that are not in SMF format 0/1.

| Extension | Type |
|-----------|---|
| .PCG | Programs, combinations, drum kits, global settings, arpeggio patterns, drum track patterns (dedicated KROME format) |
| .SNG | Song, cue list (dedicated KROME format) |
| .MID | Standard MIDI File (SMF format 0/1) |
| .EXL | MIDI Exclusive data |

When KROME data is saved, one of these filename extensions will be added automatically, according to the type of data. If these filename extensions are modified on a computer, the file will be treated as an undefined file when it is reloaded back into the KROME, and will be handled as a Standard MIDI File.

Files handled by the KROME have the shown in the structure (see next page). Since .PCG and .SNG files can be opened to divide their contents, they are displayed as directory icons.

Files that can be loaded

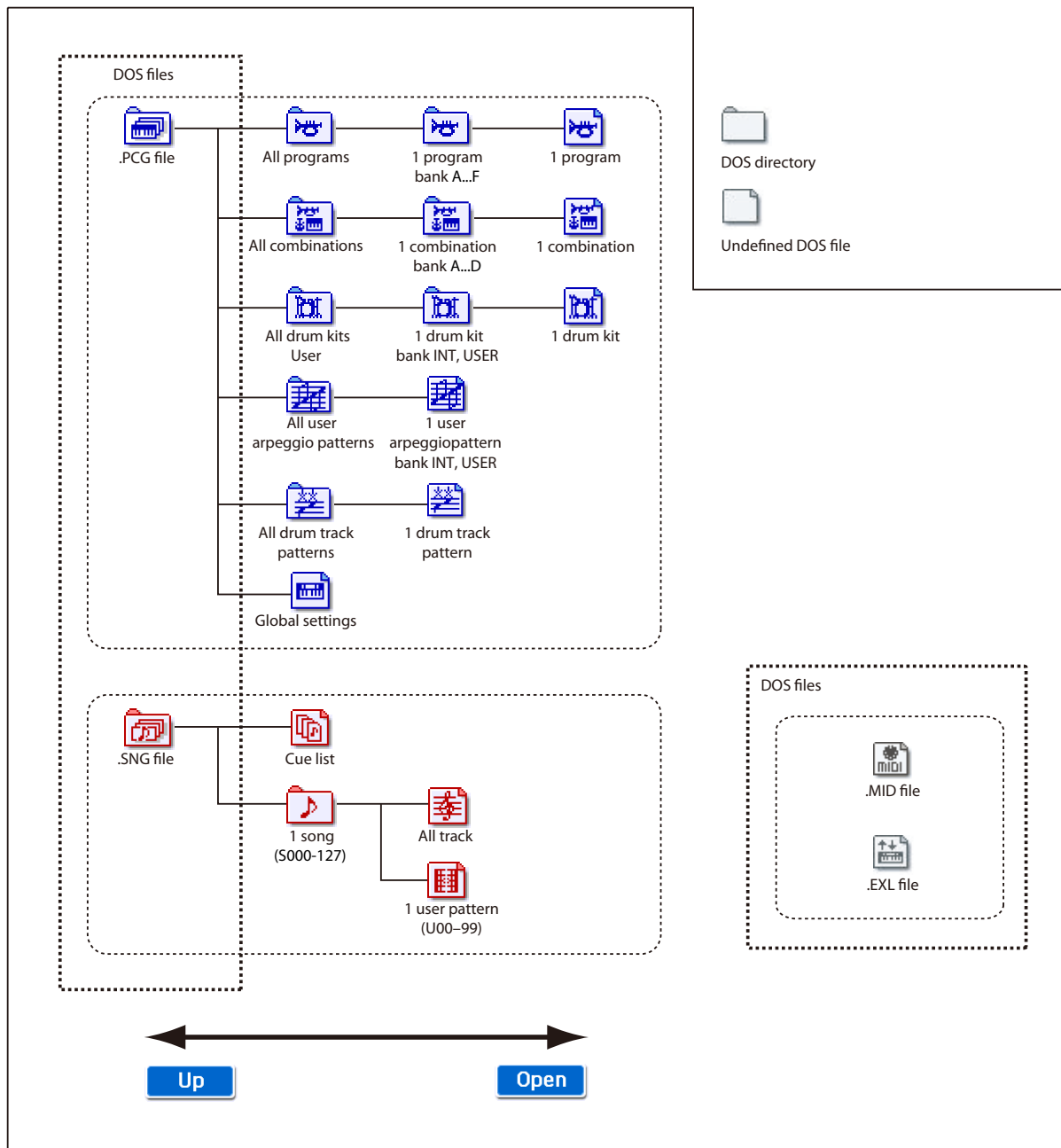

Media: File

0-1: Load



Here, you can load the selected file or directory into internal memory. Use the **Open** button and **Up** buttons to select the desired file or directory, and press the **Load** button to load it. You can also load data by using the **Load selected** menu command.

0-1a: Media Select, Command buttons

SD Card

This shows the type and volume label of the inserted device.

Volume label:

No Label: Media that has no volume label

Unformatted: Media that has not been formatted

No Media: Media is not inserted in the card slot.

The volume label display will depend on the inserted media and the page.

Open

When you press the **Open** button, the directory will open, and the current directory will move one level downward.

This can be used when a directory has been selected in the directory window.

Up

When you press the **Up** button, the directory will move one level upward.

Load

This command loads the file or directory that was selected in the "Directory Window" (Media 0-1c) into the internal memory.

When you press the **Load** button, a dialog box will appear. The specific contents of the dialog box will depend on the file you are loading. This is the same function as the **Load selected** menu command.

For more information, please see "Load selected" on page 227.

PCG Preview

If you selected just a single program, combination, or drum kit from within a .PCG file (i.e., from an opened bank), you can listen to the sound directly from the media without having to load the file. If you've selected a combination, the timbres in the combination will use the KROME's internal programs. In the case of a user drum kit, the sound parameters of the program that was selected before entering Media mode will be used.

0-1b: Current Directory



Current Directory

The directory currently selected for processing is referred to as the "current directory."

The display will show the full path name of the directory. A slash "/" character is used as the delimiter between directory levels. To change the current directory, use the **Open** button and **Up** button (Media 0-1a).

0-1c: Directory Window

This shows file information for the current directory. You can select a file or directory in this window.

| Type | File | Size | Date |
|---|-------------|------|---------------------|
|  | NEWFILE.PCG | 4.2M | 01/02/2012 00:00:00 |
|  | NEWFILE.SNG | 14K | 01/02/2012 00:00:00 |

Type

The icon indicates the type of file.

For details on how the icons correspond to the different file types, please see the diagram "Files that can be loaded" on page 224.

Lock

[Lock, Unlock]

Files and directories with this symbol are locked, and cannot be overwritten, copied, or deleted. Use the **Lock/Unlock selected** menu command to lock or unlock a file or directory.

Note: If the write protect switch of the media itself is enabled, the Lock symbol will be shown for all files and directories.

File

This is the low-level DOS file name.

Size

This is the size of the file, in bytes.

Date

This is the date and time at which the file was saved. From the left, this is shown as day, month, year, hours and minutes.

However since the KROME does not contain an internal calendar or clock, you must use Utility menu command **Set Date/Time** to set the date and time before saving the file.

Mode, Stop Watch

See "a: Mode button" on page 4 of the Operation guide.

See "1: Stopwatch button" on page 5 of the Operation guide.

✓ 0-1: Menu Command

- 0: **Hide unknown files** see p. 227
- 1: **Lock/Unlock selected** see p. 227
- 2: **Sort** see p. 227
- 3: **Load selected** see p. 227

For more information, please see "Media: Menu Command" on page 227.

0-2: Save



Here, you can save various data types from internal memory to media.

Use the **Open** button and **Up** button to move to the desired directory (i.e., change the current directory), and then select the desired menu command.

When you execute a Save operation, the data will be saved in the same level of the hierarchy as the files that are displayed.

 The KROME does not contain an internal calendar or clock, you must use Utility menu command **Set Date/Time** to set the date and time before saving the file.

✓ 0-2: Menu Command

- 0: **Hide unknown files** see p. 227
- 1: **Lock/Unlock selected** see p. 227
- 2: **Sort** see p. 227
- 3: **Save All (PCG & SEQ)** see p. 231
- 4: **Save PCG** see p. 232
- 5: **Save SEQ** see p. 232
- 6: **Save to Standard MIDI File** see p. 232
- 7: **Save Exclusive** see p. 232

For more information, please see “Media: Menu Command” on page 227.

0-3: Utility

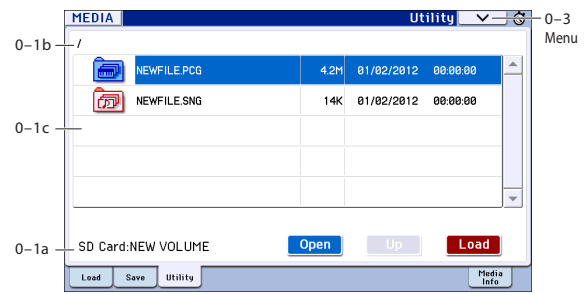

Here, you can rename, copy, or delete the selected media or file, create a new directory, format, and set the date and time.

After selecting media or a file, select the desired menu command.

✓ 0-3: Menu Command

- 0: **Hide unknown files** see p. 227
- 1: **Lock/Unlock selected** see p. 227
- 2: **Sort** see p. 227
- 3: **Rename** see p. 233
- 4: **Copy** see p. 233
- 5: **Delete** see p. 234
- 6: **Create Directory** see p. 234
- 7: **Set Date/Time** see p. 234
- 8: **Format** see p. 234

For more information, please see “Media: Menu Command” on page 227.

0-8: Media Information

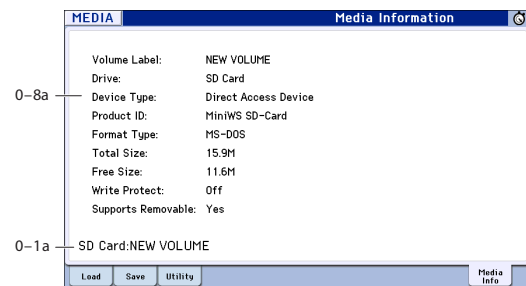

The MEDIA screen shows information about the media.

0-8a: Media Information

Volume Label: The volume label of the media.

Format Type: The type of format. If not formatted, this will indicate “Unformatted.”

Total Size: The capacity of the media (in bytes).

Free Size: The free capacity of the media (in bytes).

Write Protect: The write protect status of the media. This will indicate “On” if protected, or “Off” if not protected.

Media: Menu Command

Tip: In each page, you can access (or switch on/off) up to the first ten menu commands by holding down the ENTER button and pressing the corresponding numeric key 0–9.

Tip: While this command is open, the ENTER button will operate as the OK button and the EXIT button will operate as the Cancel button.

Procedure for menu commands

1. Select the menu command.

2. Make settings in the dialog box.

For details on the content of each dialog box, refer to the explanation of each command.

3. To execute, press the OK button. To cancel without executing, press the Cancel button.

0–1: Load Menu Command

Hide unknown files

Hide unknown files is available on the Load tab, Save tab, and Utility tab.

If you select **Hide unknown files**, a check mark will appear at the left of “Hide unknown files.” In this state, undefined files will not be shown in the directory window. However, this is valid only if there are DOS files in the current directory.

Lock/Unlock selected

Lock/Unlock selected is available on the Load tab, Save tab, and Utility tab.

This locks/unlocks the file or directory that’s selected in the directory window (Media 0–1c). If you lock the file or directory, the lock icon (“**Lock**”) will appear, and overwriting, copying, or deleting will not be possible.

1. In the directory window (Media 0–1c), select the file or directory that you want to lock or unlock.
2. Select **Lock/Unlock selected**; the selected file or directory will alternately be locked or unlocked.

Sort

Sort is available on the Load tab, Save tab, and Utility tab.

This function sorts the files in the current directory.



Use Type to select how the files will be sorted, and use Order to specify the direction.

| Type | Order | |
|------------------------|---------|--|
| No order | --- | Unsorted |
| Name (Directory First) | Ascent | Sort in alphabetical order, first directories and then files |
| | Descent | Sort in reverse alphabetical order, first directories and then files |
| Name | Ascent | Sort alphabetically |
| | Descent | Sort in reverse alphabetical |

| Type | Order | |
|------|---------|----------------------------------|
| Size | Ascent | Sort in ascending order of size |
| | Descent | Sort in descending order of size |
| Date | Ascent | Sort in ascending order of date |
| | Descent | Sort in descending order of date |

Load selected

Load selected is available on the Load tab.

This loads the file or directory selected in the directory window (Media 0–1c) into internal memory.

1. In the directory window (Media 0–1c), select the file or directory that you want to load.

2. Select **Load selected**.

A dialog box will appear. The dialog box that appears will depend on the file you are loading. For more information, please see page 228.

Specify the various items as necessary.

Note: You can also access the same dialog box by pressing the Load button instead of **Load selected**.

If a file to be loaded cannot be found

If a necessary file cannot be found in the current directory or in a lower directory when loading .PCG, or .SNG files, a dialog box like the following (Where is a ...) will appear.

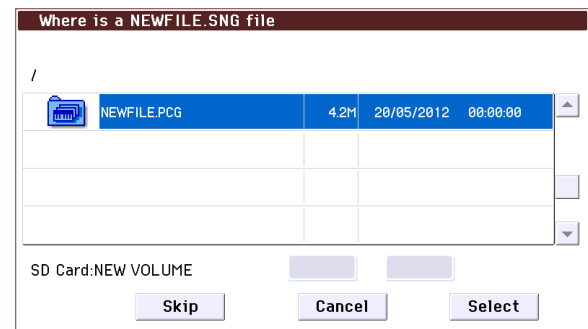

This dialog box will appear in the following cases.

- When loading a .PCG file that was split across two or more volumes of media, when the first volume has been loaded and the second media volume is now required.
- When loading a .PCG file simultaneously with a .SNG file, if the identically-named .SNG file is not found in the current directory after loading the .PCG file.

If this dialog box appears, take the following action.

1. Select the directory that contains the file indicated by “Where is a...”

If the specified file is located on another media volume, exchange media. Then press the directory window in the display to make the KROME recognize the media, and select the appropriate directory.

It is not possible to open .PCG, or .SNG files in the “Where is a...” dialog box. The Open button cannot be used for .PCG, or .SNG files.

2. Press the **Select** button to resume loading.

Loading will be aborted if you press the Cancel button. If you want to abort the loading process, press the OK button. If you press the Skip button, the indicated file will be skipped, and the next file will be loaded.

Except for special situations such as when the media containing the indicated file has been damaged or cannot be found, you should use the Select button to continue the loading process.

1) Load .PCG

Data in the .PCG file will be loaded.

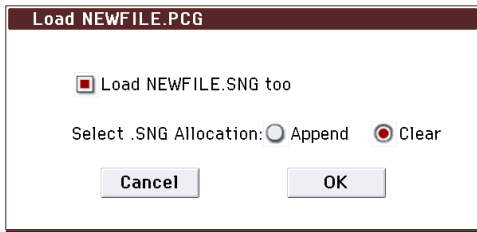

1. If a SNG file of the same filename exists in the .PCG, you can select the "Load ***** .SNG too" check box.

If this file does not exist in the current directory, load it as described in the above procedure "If a file to be loaded cannot be found" on page 227.

2. If "Load ***** .SNG too" is checked, you can use "Select .SNG Allocation" to specify how song data within the .SNG file will be loaded.

Append: The multi data will be loaded starting at the number that follows the last song data in memory. The song data within the .SNG file that is being loaded will be packed into the available locations. (See diagram below)

Select this method when you wish to load song data from media without erasing the song data that is already in memory. Cue list data will not be loaded.

Clear: Erases all cue list data and song data from internal memory, and load the cue list data together with the state of the song data as it was when saved (See diagram below).

Select this when you want to reproduce the saved state immediately after power-on, etc.

.SNG Allocation

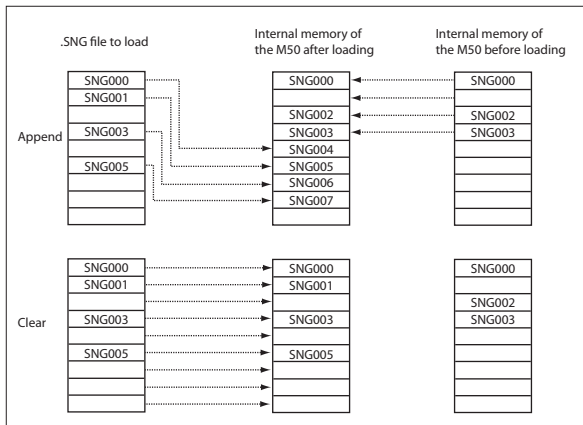

2) Load Programs

All program data from a .PCG file will be loaded.

3) Load Program Bank [Bank A...F]

All program data of the selected bank will be loaded into the bank you specify.

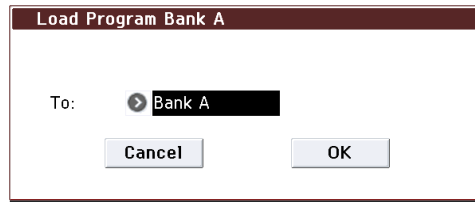

In To, select the loading destination bank.

4) Load a Program

Data for the selected program will be loaded into the program number you specify.

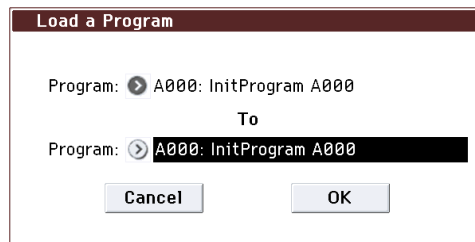

1. If you wish to load a program other than the one already selected, use the source Program (upper field) to select the program that you wish to load.

Note: The selected program can be played from the keyboard even before you load it. This is convenient when you want to audition the program before loading. For more information, please see "PCG Preview" on page 225.

2. In To Program, (lower field) select the bank and program into which the data will be loaded. When you press the popup button, the Bank/Program Select window will appear.

5) Load Combinations

All combinations in the .PCG file will be loaded.

6) Load Combination Bank [Bank A...D]

All combinations in the selected bank will be loaded into the bank you specify.

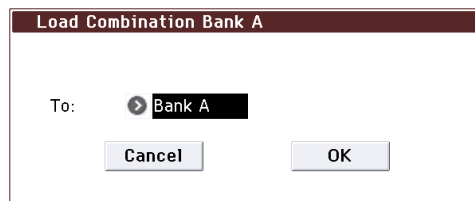

In To, select the loading destination bank.

7) Load a Combination

This loads the selected Combination into a specified Bank and number in internal memory.

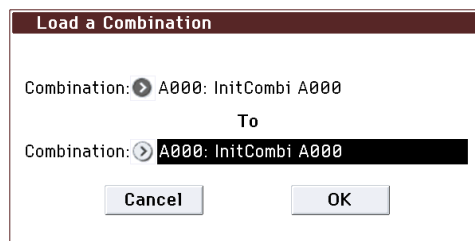

1. If you wish to load a combination other than the one already selected, use **Combination** (upper field) to select the combination that you wish to load.

Note: The selected combination can be played from the keyboard even before you load it. This is convenient when you want to audition the combination before loading it. For more information, please see “PCG Preview” on page 225.

2. In “**To Combination**” (lower field), select the bank and combination into which the data will be loaded.

When you press the popup button, the **Bank/Combination Select** window will appear.

8) Load Drum Kits

All drum kits in the .PCG file will be loaded.

9) Load Drum Kit

[000–031(INT), 032–047(USER)]

This command loads all drum kit data from the selected drum kit bank into the drum kit bank that you specify as the load-destination.

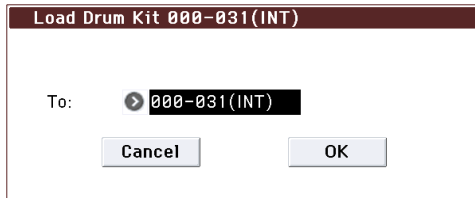

In **To**, select the loading destination bank.

- ⚠ If you've selected (USER) as the load-destination for the selected drum kit bank (INT), 000–015 will be loaded. If you've selected (INT) as the load-destination for (USER), the data will be loaded into 000–015.

10) Load a Drum Kit

The selected drum kit will be loaded into the drum kit number you specify as the loading destination.

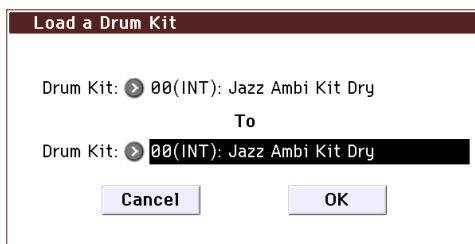

1. If you wish to load a drum kit other than the one already selected, use **Drum Kit** (upper field) to re-select the drum kit you wish to load.

Note: The selected drum kit can be played from the keyboard even before you load it. This is convenient when you want to audition drum kits before loading. For more information, please see “PCG Preview” on page 225.

2. In **To Drum Kit** (lower field), select the loading destination drum kit.

11) Load Arpeggio Patterns

All user arpeggio pattern data in the .PCG file will be loaded.

12) Load Arpeggio Pattern

[U0000–0899(INT), U0900–1027(USER)]:

All user arpeggio pattern data in the selected user arpeggio pattern bank will be loaded into the user arpeggio pattern bank you specify as the loading destination.

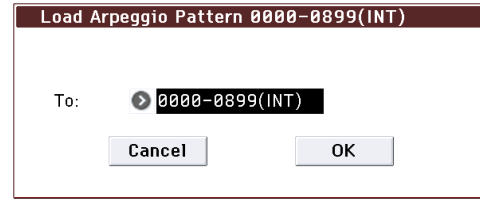

In **To**, select the loading destination user arpeggio pattern bank.

If you execute this command with U0900–1027(USER) specified as the loading destination for the selected user arpeggio pattern bank 0000–0899(INT), user arpeggio patterns 0000–0127 will be loaded. If you select 0000–0899(INT) as the loading destination for U0900–1027(USER), the data will be loaded into user arpeggio patterns 0000–0127.

13) Load an Arpeggio Pattern

The selected user arpeggio pattern data will be loaded into the user arpeggio pattern number that you specify as the loading destination.

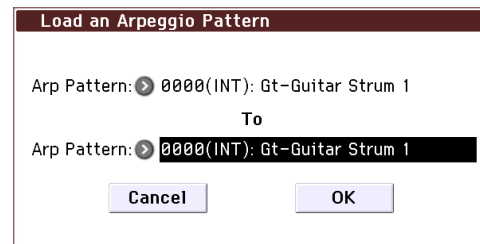

1. If you wish to load a user arpeggio pattern other than the currently selected one, use “**Arp Pattern**” (upper field) to re-select the user arpeggio pattern that you wish to load.

The selected user arpeggio pattern can be played from the keyboard even before you load it. This is convenient when you want to audition the user arpeggio pattern you wish to load.

2. In “**To Arp Pattern**” (lower field) specify the loading destination user arpeggio pattern.

14) Load Drum Track Patterns

This command loads all drum track user patterns from the .PCG file.

15) Load a Drum Track Pattern

This command loads the selected single drum track user pattern data into the drum track user pattern location that you specify as the load-destination.

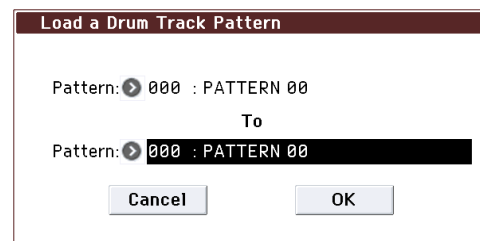

1. If you want to load a pattern other than the selected pattern, use "Pattern" (the upper field) to re-select the pattern that you want to load.
2. Use the "To Pattern" field (the lower field) to specify the load-destination pattern.

16) Load Global Setting

Global setting data in the .PCG file will be loaded.

This includes Global mode parameters other than drum kits and arpeggio patterns.

-  Memory protect and Effect Global SW settings will not be loaded.

17) Load .SNG

All data in the .SNG file will be loaded.

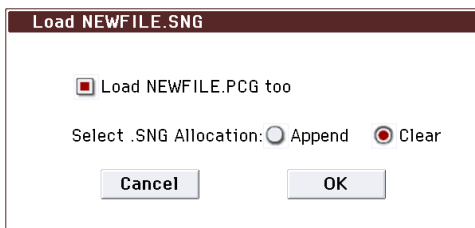

1. Use Select .SNG Allocation to specify how the song data from the .SNG file will be loaded.

Append: The song will be loaded after the last song data that already exists in internal memory. At this time, the song data in the .SNG file being loaded will be packed forward. (See diagram in ".SNG Allocation" on page 228)

Select this when you want to add song data from media without erasing the song data that currently exists in internal memory. Cue list data will not be loaded.

Clear: All cue list data and song data currently existing in internal memory will be erased, and the cue list and song data will be loaded in the state in which it was saved (See diagram in ".SNG Allocation" on page 228).

Select this when you want to reproduce the saved state immediately after power-on, etc.

2. If a .PCG file of the same filename exists in the current directory, you can select the "Load *****.PCG too" check box.

See step 1 of the "1) Load .PCG" on page 228.

18) Load Cue Lists

The cue list data in the .SNG file will be loaded.

19) Load a Song

Data for the selected song will be loaded into the song number you specified as the load destination.

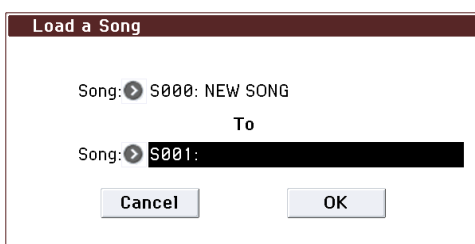

1. If you wish to load a song other than the selected song, use Song (upper field) to re-select the song to be loaded.
2. In To Song (lower field), select the loading destination song.

20) Load Tracks

The event data of all tracks in the selected song will be loaded into the song you specify as the loading destination. However, it is not possible to specify an uncreated song as the loading destination.

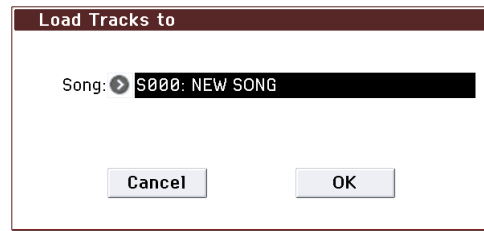

In Song, specify the loading destination song.

21) Load Pattern Data

The selected user pattern will be loaded into a user pattern of the selected loading destination song. However, it is not possible to specify an uncreated song as the loading destination.

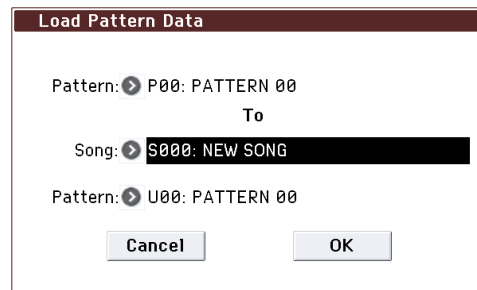

1. If you wish to load a user pattern other than the one already selected, use "Pattern" (upper field) to re-select the user pattern that you wish to load.
2. In "To Song" and "Pattern" (lower field), select the loading destination song and user pattern.

22) Load Standard MIDI File

The selected Standard MIDI File will be loaded into the song number you select as the loading destination.

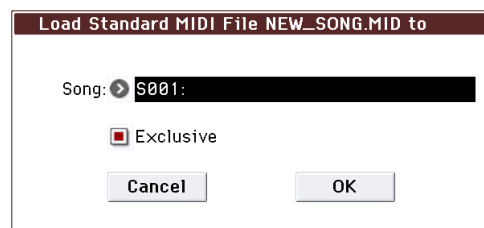

1. In Song, select the loading destination song.
2. If you turn "Exclusive" Off (unchecked), any System Exclusive messages or Universal Exclusive messages included in the SMF data will not be loaded.

If this is On (checked), System Exclusive messages and Universal Exclusive messages included in the SMF data will be loaded as System Exclusive events.

-  The GS/XG sound maps and messages are not supported. Depending on the content of the data, it may not play back correctly, but the data itself will be maintained if Exclusive is checked.

-  If you select an undefined file and choose Load selected, the file will be assumed to be a Standard MIDI File, and the Load Standard MIDI File dialog box will appear. When you execute loading, the file will be loaded into the song that was specified as the loading

destination. However if the file format is inappropriate, the operation will be invalid and an error message will be displayed.

- The program bank and program numbers loaded into the song will follow the **Bank Map** (Global 0-2a) setting. If **Bank Map** is KORGE, bank A will be selected for bank select 00.00 (MSB. LSB). If **Bank Map** is GM(2), bank G will be selected.

23) Load and Transmit MIDI Exclusive Data



All data in the .EXL file will be loaded, and transmitted from MIDI OUT or the USB connector.

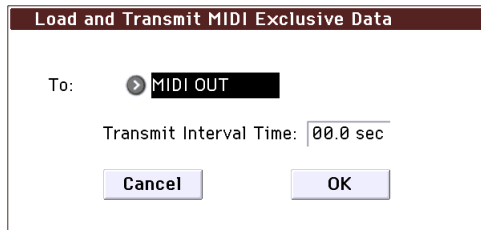

If the .EXL file contains two or more Exclusive data items, use Transmit Interval Time to specify the time interval that will be inserted between each item of Exclusive data.

If you are transmitting the data to another KROME, the required time interval will depend on the type of data. After transmitting all program data, you must allow an interval of approximately 1 second. For details please see the Global mode section on **Dump Program–Dump Drum Track Pattern** (see p.218). For other MIDI devices, please see their owner's manual.

0-2: Save Menu Command

Cautions regarding Save

- When saving combinations with **Save All (PCG & SEQ)**, **Save PCG**, or **Save SEQ**, you should also try to save the programs used by each timbre or track (and the drum kits used by the program), user arpeggio patterns, and drum track user patterns at the same time. Similarly, when saving programs, you should also save the drum kits, user arpeggio patterns, and drum track user patterns used by the program at the same time.

If the data being saved does not fit on one volume of media

When saving a .PCG, or .SNG file, and the data does not fit on one volume of media, the display will read "No space available on media".



Either delete unneeded files to create free space on the media before saving, or save the data to other media.

Save All (PCG & SEQ)

Save All (PCG & SEQ) is available on the Save tab.

This command saves all programs, combinations, drum kits, global settings, user arpeggio pattern, and drum track user patterns from internal memory to media as a .PCG file. Songs and cue lists are saved to media as a .SNG file.

This command is valid only when the current directory is a DOS directory.

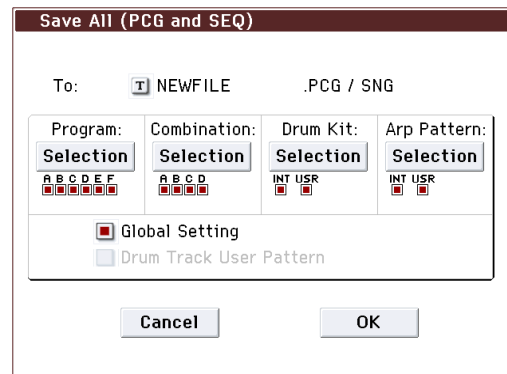

1. Use the text edit button to move to the text input dialog box, and specify the filename. (See OG page 117)

For example, if you specify NEWFILE and execute the save command, files named NEWFILE.PCG, and NEWFILE.SNG will be saved to the media.

2. Select the bank(s) that you want to save.

Programs, combinations, drum kits, and user arpeggio patterns can be saved in units of banks. Information on the bank to be saved is displayed below each Selection button. Banks that are checked will be saved.

If you want to modify the selections, press the Selection button to open the dialog box, and check the check boxes for the data you want to save.

Example: when the Selection button for Program is pressed

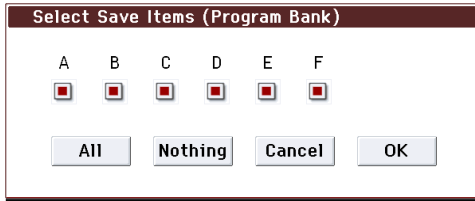

If you press the All button, all banks will be checked.

If you press the Nothing button, all banks will be unchecked.

Press the OK button to change the selections as specified, or press the Cancel button to discard your changes.

To specify whether “Global Settings,” and “Drum Track User Pattern” will be saved, use the check box in step 1.

If “No space available on medium” dialog box will appear. Either delete unneeded files to create free space on the media before saving, or save the data to other media.

When you save, files will be created in the current directory.

Save PCG

Save PCG is available on the Save tab.

This command saves all programs, combinations, drum kits, global settings, user arpeggio pattern, and drum track user patterns from internal memory to media as a .PCG file.

This command is valid only when the current directory is a DOS directory.

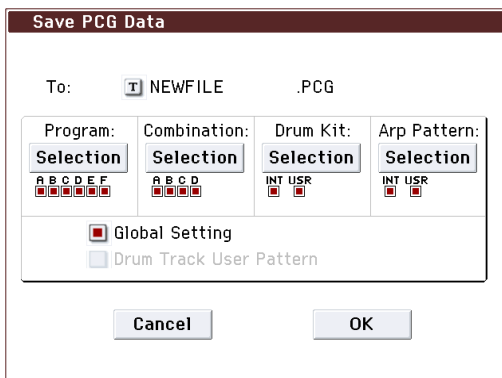

1. Use the text edit button to move to the text input dialog box, and specify the filename. (See OG page 117)

For example if you specify NEWFILE and execute the save command, files named NEWFILE.PCG and NEWFILE.SNG will be saved to the media.

2. Select the bank(s) that you want to save.

For the procedure, please see “0–2: Save All” step 3.

Save SEQ

Save SEQ is available on the Save tab.

This command saves all songs and cue lists from internal memory as a .SNG file.

This command is valid only when the current directory is a DOS directory.

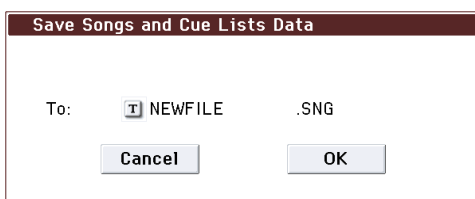

Use the text edit button to move to the text input dialog box, and specify the filename. (See OG page 117)

For example, if you specify NEWFILE and execute the save command, a file named NEWFILE.SNG will be saved to the media.

Save to Standard MIDI File

Save to Standard MIDI File is available on the Save tab.

This command saves the selected song from internal memory to storage media as a .MID file (Standard MIDI File).

This command is valid only when the current directory is a DOS directory.

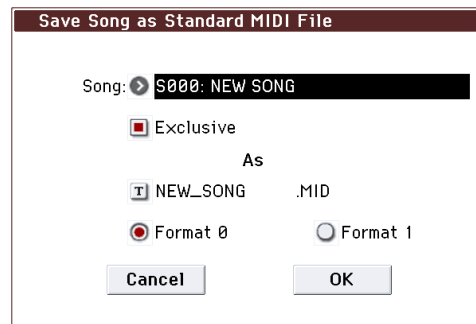

1. In Song, choose the song that you wish to save.
2. If Exclusive is On (checked), System Exclusive events and Universal Exclusive events included in the song data will be saved as Exclusive messages.

If this is Off (unchecked), System Exclusive events and Universal Exclusive events included in the song data will not be saved.

3. Use the text edit button to move to the text input dialog box, and specify the filename.

By default, the first eight characters (uppercase) of the song name will be assigned automatically.

4. Use the radio buttons to specify the format.

Format 0 will save sixteen channels of MIDI data together in a single track.

Format 1 will save each MIDI channel to a separate track.

The song data you save here can be played back on a device that supports Standard MIDI Files. However if you intend to play back the data on the KROME, we recommend that you use “Save SEQ” to save the data, since this will be more easily recreated.

Save Exclusive

Save Exclusive is available on the Save tab.

Accumulates the received Exclusive data in internal memory, and then saves the data to media as an .EXL file.

This command is valid only when the current directory is a DOS directory.

1. When you select Save Exclusive, the KROME will wait for Exclusive data to be received. The following dialog box will appear.

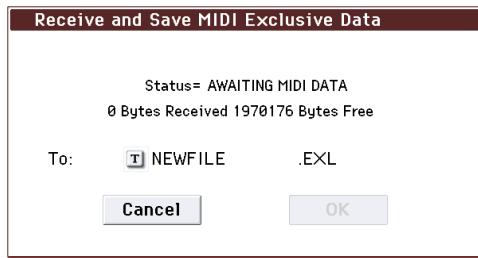

2. Transmit the Exclusive data that you wish to save to the KROME.

While the data is being received, the display will indicate "Status=RECEIVING MIDI DATA."

When reception ends, the size of the received data and the size of the remaining free area will be rewritten. The display will change to "Status=AWAITING MIDI DATA," and you can continue transmitting Exclusive data to the KROME. During reception, the Cancel button and the OK button cannot be pressed.

3. Use the text edit button to move to the text input dialog box, and specify the filename. (See OG page 117)

0-3: Utility Menu Command

Rename

Rename is available on the Utility tab.

This command renames the selected file or directory.

This command is valid only when a DOS file or a DOS directory is selected.

1. Select the file or directory whose name you want to edit.
2. Select "Rename" to open the dialog box.

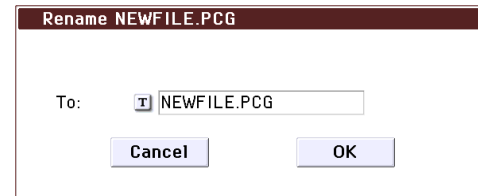

3. Press the text edit button to access the text input dialog box, and modify the name (See OG page 117).

Copy

Copy is available on the Utility tab.

This command copies the selected file or directory.

This command is valid only when a DOS file or a DOS directory is selected.

1. Select the file or directory that you want to copy.
2. Select "Copy" to open the dialog box.

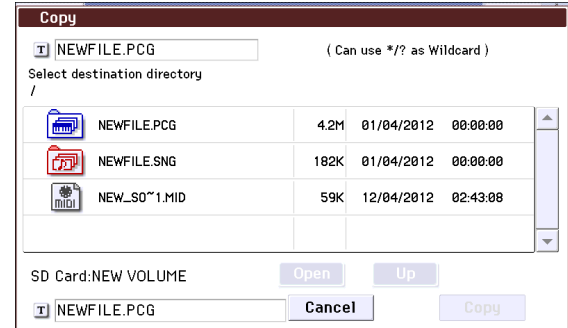

3. Copy will show the name of the selected file or directory.

If you wish to change the file or directory that will be copied, use the text edit button to move to the text input dialog box, and specify the filename that you wish to copy. (See OG page 117)

Using [*/?] as a Wildcard: When you use the text edit button to access the text input dialog box and specify the name of the file or directory to be copied, you can use "*" and "?" characters as wildcards. For example, if in the above example you specify **PRELOAD1.*** (instead of **PRELOAD1.PCG**), all filenames of PRELOAD1. with any filename extension will be copied at the same time: i.e., PRELOAD1.PCG, PRELOAD1.SNG, ...

Example)

PRELOAD1.* : PRELOAD1.PCG, PRELOAD1.SNG, ...

PRELOAD?.PCG : PRELOAD1.PCG, PRELOAD2.PCG, PRELOAD3.PCG, ...

 When wildcards are used, only files will be subject to copying. Directories will not be copied.

4. Use the Open button and Up button to select the copy destination directory.

- If you wish to copy the file or directory with a different name, use the text edit button (in the lower field) to access the text input dialog box, and specify the new name for the file or directory to be copied.

If you're using wildcards to copy multiple files simultaneously, you won't be able to change file names.

Note: If you decide not to copy, press the **Abort** button.

Delete

Delete is available on the Utility tab.

This command deletes the selected file or directory.

This command is valid only if a DOS file or directory is selected.

- Select the file or directory that you want to delete.
- Select "Delete" to open the dialog box.



- Delete will indicate the name of the selected file or directory.

If you wish to change the file or directory that is to be deleted, use the text edit button to access the text input dialog box, and specify the name of the file or directory that you wish to delete. (See **OG page 117**)

Using [*/?] as a Wildcard: When you use the text edit button to access the text input dialog box and specify the name of the file to be deleted, you can use the "*" or "?" characters as wildcards. This allows you to simultaneously delete multiple files with identical filenames and different extensions, or files whose names are partially identical (see "Copy" on page 233).

 When wildcards are used, only files will be subject to deletion. Directories will not be deleted.

Create Directory

Create Directory is available on the Utility tab.

This command creates a new directory within the current directory.



Use the text edit button to access the text input dialog box, and specify the name of the new directory (See **OG page 117**).

Set Date/Time

Set Date/Time is available on the Utility tab.

This is the date and time at which the file was saved.

 The KROME does not contain an internal calendar or clock, you must use Utility menu command **Set Date/Time** to set the date and time before saving the file.

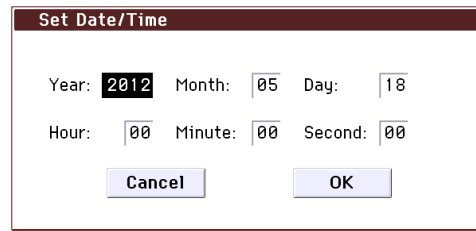

| | |
|--------|-----------|
| Year | 1980–2079 |
| Month | 1–12 |
| Day | 1–31 |
| Hour | 0–23 |
| Minute | 0–59 |
| Second | 0–59 |

Format

Format is available on the Utility tab.

This command formats the media that's inserted in the KROME. The volume label (a name for the entire media) you specify will be assigned to the media. The volume label you assign here will be displayed in the **SD Card (Media 0–1a)**. The volume label can be a maximum of eleven characters.

 After formatting, it is not possible to press the **COMPARE** button to undo formatting.

- Make sure that the media you want to format is inserted.
- Select "Format" to open the dialog box.

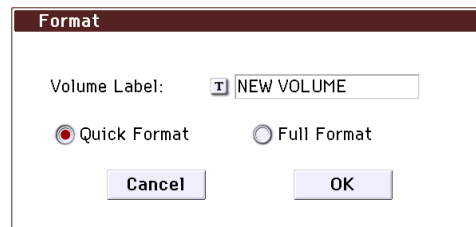

- In **Volume Label**, use the text edit button to access the text input dialog box, and specify the volume label (See **OG page 117**).

The previously-specified volume label will be displayed. If no volume label had been specified for the media, or if a non-DOS media was inserted, this will indicate **NEW VOLUME**.

- Specify the initialization format.

Quick Format: Normally you should use Quick Format to initialize the media.

Full Format: All blocks in the media will be erased. Normally there is no need for you to execute Full Format. You should execute Quick Format instead.

Effect Guide

Overview

The KROME provides five insert effects, two master effects, and a total effect, together with a mixer section that controls the routing of these effects.

For each of these effect processors, you can choose from 193 different types of effects, grouped into the following categories:

Classification of 193 effects

| Effect type | Contents |
|---|---|
| Dynamics: 000...006 | Effects which control volume, such as compressors, limiter, and gates |
| EQ/Filter: 007...019 | Effects which control frequency content, such as EQ, multi-mode filter, exciter, and wah |
| Overdrive/ Amp/Mic: 020...028 | Overdrive and amp modeling effects such as guitar/bass amps and mics |
| Chorus/ Flanger/ Phaser: 029...048 | Pitch and phase modulation effects such as chorus and flanger |
| Modulation/ Pitch Shift: 049...067 | Other modulation effects such as tremolo and rotary speaker, and pitch shifters |
| Delay: 038...083 | Delays |
| Reverb/ER: 084...094 | Reverb and early reflections |
| Mono-Mono Serial: 095...126 | Mono & Mono chain effects that internally connect two mono effects in series |
| Mono//Mono Parallel: 127...171 | Mono & Mono parallel effects that allow two mono effects to be applied to L and R independently |
| Double Size: 172...193 | Double size effects |

Effect Preset

Effect Presets let you easily store and recall all of the settings for an individual effect. You can store up to 16 user presets for each effect type, in addition to 15 re-writable factory presets.

The same presets appear in all of the modes (Program, Combination, and Sequencer).

Note that edits to effects parameters are automatically stored with the Program—you don't need to store them as an Effect Preset. Presets just make it easier to re-use your favorite settings.

For instance, you can save an Effect Preset while working on a particular Program, and then later use the same Effect Preset in a different Program, Combination, or Song.

Program mode

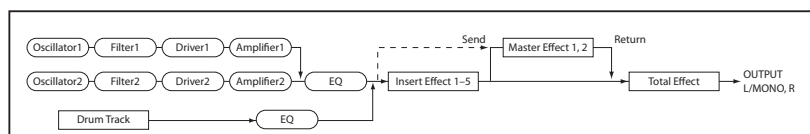

Combination mode, Sequencer mode

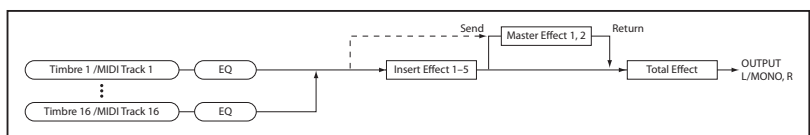

P00: Initial Set: These are the default settings that are recalled when you select an effect type in the Insert FX Setup page. You can't save your own settings here.

P01...P15: Preset data is saved in this area.

We recommend that you store your settings in U00–U15.

U00...U15: These are areas in which you can store your own settings.

-----: This shows that no Effect Preset has been selected. You'll see this if you've just selected an effect, written a Program, or selected a new Program. Selecting this setting from the menu will not have any effect.

Note: Programs save the effects parameter settings, but they don't save the number of the selected Effect Preset. If you select an Effect Preset, and then save the Program, the Effect Preset setting will revert to "-----."

For more information, please see "Using Effect Presets" on page 60.

Effects in each mode

Program mode

With Programs, you can use insert effects to process the final sound in the same way that you use the Filter, Driver, Amplifier, and EQ (equalizer) to process the sound from the oscillators (OSC 1 & 2). Then the master effects are used to create overall ambience such as reverb, and use the total effect to make final adjustments. All of these settings can be made independently for each program.

Combination, Sequencer mode

In Combination and Sequencer modes, you can use the track EQ and insert effects to process the program sound of each timbre/track. You can then use the master effects to create overall ambience, and use the total effect to make final adjustments.

In Combination mode you can make these settings for each combination, and in Sequencer mode you can make them for each song.

In Sequencer mode, you can switch between effects or modify the effect parameters and record these changes, so that effects will switch automatically or effect parameters will be modified automatically as the song plays back.

Dynamic modulation (Dmod) and Tempo Synchronization

Dynamic modulation (Dmod)

Dynamic modulation lets you control certain effects parameters in real-time, using either the built-in controllers or MIDI. These effect parameters are marked with the logo .

For more information, please see “Dynamic Modulation Sources (Dmod)” on page 346.

Tempo Synchronization

You can synchronize some effects parameters, such as LFO speeds and delay times, to the system tempo. This lets you sync the effects to Program LFOs, Drum Track, Arpeggiator, the internal sequencer, or an external MIDI clock.

These effects parameters are marked with the logo .

Synchronizing LFOs

Most effects with LFOs, such as 011: Stereo Wah/Auto Wah, can be synchronized to tempo. This applies to the individual effects LFOs, and also the Common FX LFO.

To set up LFOs to synchronize to tempo:

1. Set MIDI Sync to On.
2. Set the BPM as desired.

To synchronize to the system clock, set **BPM** to MIDI.

To set the LFO to a specific tempo, separate from the system clock, set **BPM** to the desired tempo (between 40.00 and 300.00 BPM).

3. Use the Base Note and Times (x) parameters to set the rhythmic value of the LFO.

For instance, if you set **Base Note** to 1/8 and **Times (x)** to 2, each cycle of the LFO will last for a quarter-note (two eighth-notes).

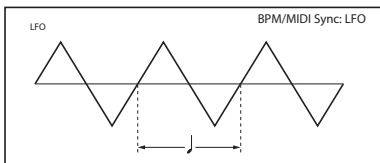

Synchronizing Delay Times

Delays with **BPM** in their title will sync to tempo.

For instance, you might set up effect 078: Stereo BPM Delay as follows:

1. Set L Delay Base Note to 1/8, and Times (x) to 1
2. Set R Delay Base Note to 1/16, and Times (x) to 3

This means that the left channel will be delayed by an eighth-note, and the right channel will be delayed by a dotted eighth-note (three sixteenth-notes).

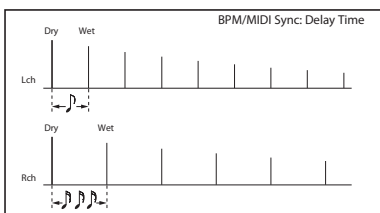

3. Set the BPM as desired.

To synchronize to the system clock, set **BPM** to MIDI.

To set the delays to a specific tempo, separate from the system clock, set **BPM** to the desired tempo (between 40.00 and 300.00 BPM).

If the combination of the tempo, **Base Note**, and **Times (x)** settings in conjunction would exceed the maximum delay time, a warning such as “Time Over? >OVER!” will appear in the display. If this happens, just reduce the delay time. Note that the maximum delay time depends on which delay effect you’re using. For instance, the maximum delay time for 079: Stereo BPM Delay is 2,730msec, while the maximum delay time for 192: St. BPM Long Dly is 5,460msec.

Dynamic modulation to control an effect parameter in realtime

As an example, let’s set up dynamic modulation to control an effect parameter in realtime.

1. As described in the procedure for “Program Effects settings” on page 79 of the Operatin guide, set IFX1 to 078: L/C/R BPM Delay. Verify that you’re hearing a delay effect.

2. Access the Prog P8: Routing/IFX– IFX1 page.

Now, we can set the Dmod to change the delay level via the Joystick

3. Set Input Level Dmod to +100.

4. Set Source to JS+Y: #01.

The delay sound will disappear.

The input level to the effect can be controlled by the joystick. As you move the joystick away from yourself, the delay sound will gradually increase.

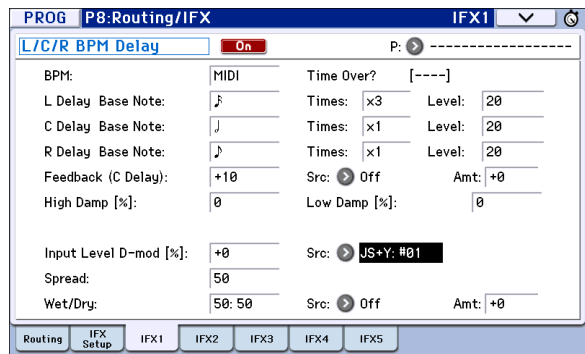

In addition, we can use Dmod to change the feedback level via SW1

5. In the P1: Basic/Controllers– Controllers Setup page, set the SW1 function to SW1 Mod.CC#80, and the Mode to Toggle.

Choose P8: Routing/IFX page. Set the Feedback Src to SW1: #80, and set Amt to +30.

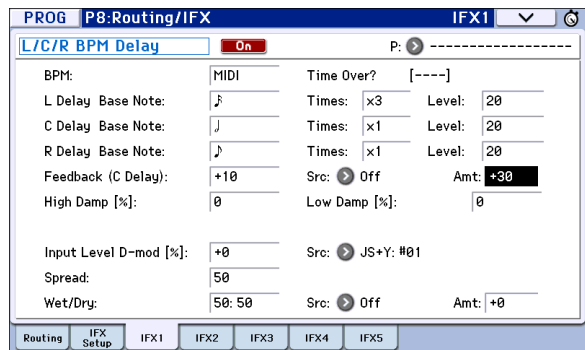

When you move the joystick away from yourself and press the SW1 switch, the feedback level will increase, and the

delay sound will continue for a longer time. The **Amt** setting specifies the feedback level that will be in effect when the SW1 switch is pressed. If **Amt** is set to -10, pressing the SW1 switch will reduce the feedback level to 0.

Finally, we can use the MIDI/Tempo Sync function to synchronize the delay time to the arpeggiator tempo.

6. Set BPM to MIDI.
7. For L, C, and R, set the Delay Base Note and Times as desired.

For this example, set **Delay Base Note** to D_4 and **Times** to x1 so that the effect will be easily understandable. The delay time will repeat at an interval of a 8th note.

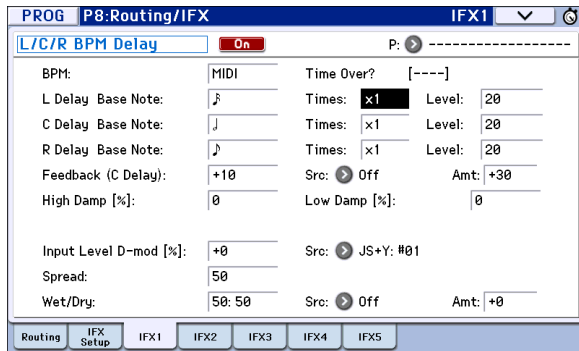



8. Rotate the TEMPO knob, and the delay time will change.

When you (push the joystick away from yourself and) press the SW1 switch, the feedback level will rise, and the delays will become longer.

9. When you turn on the ARP button, arpeggiator will begin playing.

Select any desired arpeggiator. When you rotate the TEMPO knob, the delay time will change in synchronization with the changing tempo of the arpeggiator.

 Depending on the specific delay effect, you may hear some unexpected noise if you change the tempo while the delay is sounding. This is because the delay sound becomes discontinuous, and is not a malfunction.

 For some effects, you can synchronize the LFO frequency to the tempo. Set the effect parameters **MIDI Sync** to On, and **BPM** to MIDI. For details, please see “Tempo Synchronization” on page 236.

Common FX LFOs

Normally, LFO-based effects—such as choruses, flangers, phasers, filters, and auto-pan—each have their own independent LFO. The KROME effects support this standard mechanism, but add a new one: Common FX LFOs.

The two Common FX LFOs allow you to synchronize multiple LFO-based effects together. They’re available in most LFO-based effects, in addition to the individual LFOs, providing:

- Master sources of frequency and phase for all LFO-based effects
- LFO speed set by either frequency or tempo
- Reset from Dmod sources, for either realtime performance or synchronizing to a down-beat in a sequence

When using the Common FX LFOs, you can still control the LFO phase individually for each effect, and often change the waveform individually as well.

You can edit the Common FX LFO parameters on the P8—Common FX LFO pages of Program, Combination, Sequencer modes.

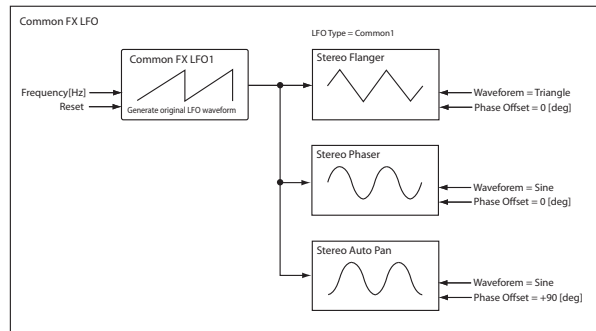

FX Control Buses

The FX Control Buses lets you create effects “sidechains.” Sidechains let you control an effect with one audio signal (the sidechain), while the effect processes a completely different audio signal.

This is convenient for use with vocoders and limiters, gates, etc. You can use a voice-type timbre to modulate a synth-type input, or use a drum track etc. to create rhythmic vocoder effects. Limiter or gate-type effects are often used to control an input using a different sound.

KROME includes two true- stereo FX Control Buses, which can be used with the following effects:

Vocoder

174: Vocoder

Limiter, and gate effects

003: Stereo Limiter

006: Stereo Gate

Example: Gated Reverb (Program mode)

If you process reverberant sound through a gate effect, the gating may not occur as desired since the reverb extends the duration of the sound. Normally, you will use the un-reverberated sound to control the gate, as shown in the diagram. Use **Bus (IFX/Output) Select** to send OSC1 and 2 to IFX1 and also via **FX Control Bus** to 1. Set the IFX2: Stereo Gate **Envelope Source** to FX Control 1. This lets you control the gate using a different signal than the input (in this example, the reverberated sound).

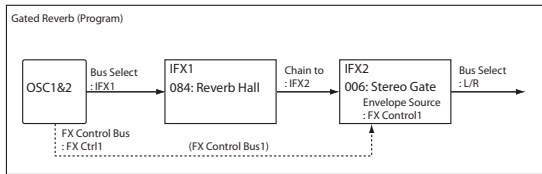

Example: Limiter (Combination)

Compressor-type effects use the level of the audio input to control the level gain of the audio output.

For these effects, the envelope detection source can be either the audio input itself (the usual method) or FX Control Bus 1 or 2.

The example shown in the diagram is of a split combination in which the level of timbre 1 (Pad, played from the low key range) is being controlled by timbre 2 (Guitar, with IFX2 OD/Hi-Gain Wah inserted, played from the high key range). You can make settings so that when you play the guitar sound, the volume of the pad will decrease automatically. Send the post-IFX2 signal via **FX Control Bus** to FX Ctrl1, and set the IFX1: Stereo Limiter **Envelope Source** parameter to FX Control 1.

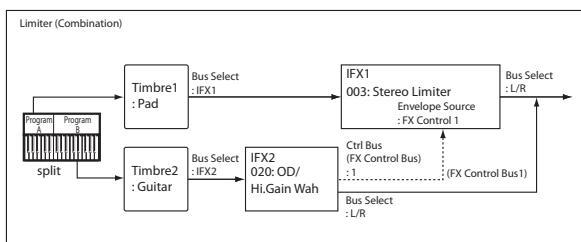

Example: Vocoder (Combination)

Vocoder effects produce their distinctive sound by using an audio signal (the modulator) to modulate a different audio signal (the carrier).

As shown in the illustration, using the output of timbre 1 as the carrier and the voice-type output of timbre 2 as the modulator allows you to create distinctive “talking” effects.

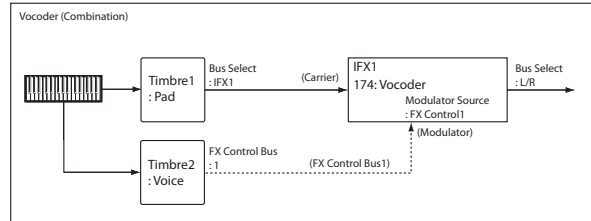

Example: Rhythmic Vocoder (Program)

Vocoder effects produce their distinctive sound by using one audio signal (the modulator) to modulate a different audio signal (the carrier).

You can also use a drum pattern or similar signal as the modulator, producing a rhythm vocoder effect.

In the example shown in the diagram, a drum pattern generated by Arpeggiator and Drum Track function is sent to the FX Control bus and used as the modulator for the vocoder.

For oscillator 1 (the carrier), set **Bus (IFX/Output) Select** to IFX1, sending the signal to IFX1: Vocoder. For drum track we’re using as the modulator), set **FX Control Bus** to 1, sending the signal to FX Ctrl1 bus. For IFX1: Vocoder, set “Modulator Source” to FX Control 1 so that the drum track signal will be the modulator for the vocoder.

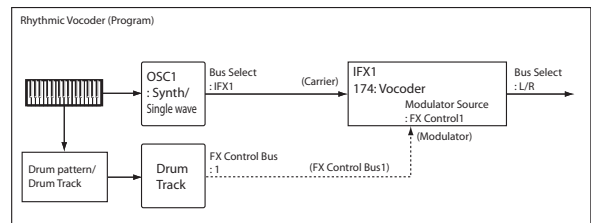

Effect I/O

To achieve the best tonal quality, signals sent to the effects should be at the maximum level below clipping. Also, use the **Wet/Dry** parameter for the Insert Effects, Total Effect and the **Wet/Dry** or **Return 1, 2** parameter for the Master Effects to adjust the effect output level.

 If the input level is too low, the SN ratio may decrease. On the other hand, if the input level is too high, clipping may occur.

The following table shows the parameters related to the level settings:

Program mode

| | |
|--------|--|
| Input | OSC 1/2 Volume, Drum Track Volume (P0) |
| | OSC1/2 MS1, 2, 3, 4, 5, 6, 7, 8 Level (P2) |
| | Filter1/2 Trim (P3) |
| | Filter1/2 Output (P3) |
| | Driver1/2 Drive (P4) |
| | Amp1/2 Amp Level (P4) |
| | EQ Input Trim (P4) |
| | Send1/2 (P8) |
| | Effect Trim parameter *1 (P8, P9) |
| Output | Effect Wet/Dry parameter (P8, P9) |
| | Return1, 2 (P9) |
| | Master Volume (P9) |

Combination mode/Sequencer mode

| | |
|--------|-----------------------------------|
| Input | Volume (P0) |
| | Timbre/Track EQ Input Trim (P2) |
| | Send1/2 (P8) |
| | Effect Trim parameter *1 (P8, P9) |
| Output | Effect Wet/Dry parameter (P8, P9) |
| | Return1, 2 (P9) |
| | Master Volume (P9) |

*1 Some effects may not have these parameters.

Insert Effects (IFX1–IFX5)

In/Out

Insert Effects (IFX 1–5) have a stereo input and a stereo output. If you set the **Wet/Dry** parameter to Dry (no effect), the input signal will be passed through, in stereo, without being processed by the effect. If you select Wet (effect applied), the processed signal will be output in one of the following ways:

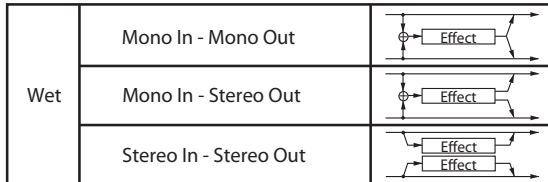

Mono–Mono Parallel Effects

127: P4EQ // P4EQ —171: BPM DI // BPM DI

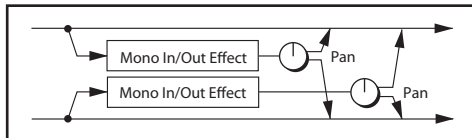

These effects are typically stereo-in/stereo-out, but they have a special structure. The L channel and R channel of the stereo input each have their own independent mono effect. Each mono output can then be panned to the desired position in the stereo field.

- Track1: Piano, **Pan**=L001, **Bus (IFX/Output) Select**=IFX1
- Track2: E.Piano, **Pan**=R127, **Bus (IFX/Output) Select**=IFX1

So that you don't mix the sound of the two tracks that are being input, set the P0: Play/REC **Pan** parameter to L001 and R127 respectively.

Example: IFX1: 134: P4EQ // Phaser

Track 1: Piano is sent to the L channel P4EQ, and Track 2: E.Piano is sent to the R channel Phaser. Use the P8: Routing/IFX– IFX1 page **Pan** parameter to set the output position of each sound. In this example, both are set to C064. See the diagram below.

IFX1: 134: P4EQ // Phaser

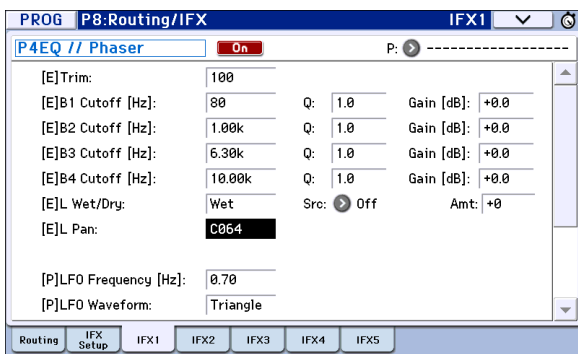

Input/output variations for each effect are shown in upper left of the block diagrams starting on page 320.

If you select **000: No Effect**, stereo input signals are output in stereo without being processed.

Pressing the On/Off button of IFX1–IFX5 in the P8: Routing/IFX– Insert FX Setup pages in each mode will toggle between On and Off. When Off is selected, the effect will be

bypassed, and the stereo input signal will be output in stereo without being processed.

MIDI The KROME can also turn IFX1–IFX5 off separately from the setting of the On/Off button by receiving MIDI control change message CC#92. Value 0 will turn them off, and value 1–127 will turn them on.

You can also use “Effect Global SW” (Global 0–1b) to turn IFX1–5 on and off. This MIDI control is performed on the global **MIDI channel** (Global 1–1a).

Double-size effects

Double-size effects (172: St.Mltband Limiter – 193: Early Reflections) use twice as much space as other effects.

You can use double-size effects for insert effects IFX1–IFX4 and master effect MFX1. However, the effect of the number that follows it will be unavailable. For example if you've selected a double-size effect for IFX1, you won't be able to use IFX2. If you've selected a double-size effect for MFX1, you won't be able to use MFX2.

An example of when a double-size effect is selected for IFX1 and IFX4

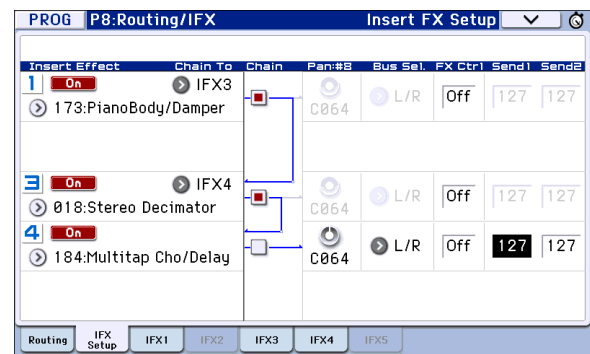

Routing

You can use up to five channels (IFX 1–5) for the Insert Effects in any mode.

Program mode

Use **Bus (IFX/Output) Select** (Prog 8–1b) to set the destination bus of the oscillator output.

L/R: Send the output to the L/R bus. Instead, it is sent to **AUDIO OUTPUT L/MONO** and **R** after the TFX.

IFX1...5: The signal is sent to Insert Effects IFX 1–5.

Off: The output will not be sent to the L/R bus, or IFX1–5 buses. Choose the Off setting if you want to connect the oscillator output to a master effect in series. Use **Send1 (to MFX1)** and **Send2 (to MFX2)** to adjust the send level.

Use **Send1 (to MFX1)** and **Send2 (to MFX2)** (Prog 8–1d) to specify the send level for the Master Effects. This setting is effective if **Bus (IFX/Output) Select** (Prog 8–1b) is set to L/R or Off.

If **Bus (IFX/Output) Select** is set to IFX1–5, use **Send1** and **Send2** (Prog 8–2a) to specify the send level of the post-IFX signal.

MIDI Send1 responds to CC#93, and Send2 responds to CC#91. At this time, the actual send level uses the value of the Send 1 and 2 settings for Oscillators 1 and 2, multiplied by the Send 1 and 2 values received via MIDI.

In the example shown in the next diagram, Oscillators 1 and 2 outputs being sent to IFX1.

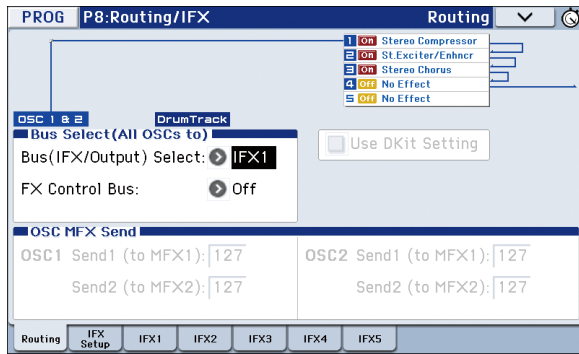

If you are connecting the Insert Effects in series, check the **Chain** box (Prog 8–2a). Use **Chain to** (Prog 8–2a) to specify the destination to which the signal will be chained.

If you check the IFX1 checkbox, the output of IFX1 will be sent to the input of the IFX you specify in **Chain to**. Effects can be chained only in ascending order of their number; for example IFX1 can be chained to IFX2 through IFX5, and IFX2 can be chained to IFX3 through IFX5. You can create a chain of up to five insert effects in series, IFX1 through IFX5.

When the Insert Effects are connected in series, the values of the **Pan: CC#8**, **Bus**, **Send1**, and **Send2** parameters for the post-IFX signal will be used.

In the example shown in the next diagram, the **Chain** check box is checked, and each **Chain to** parameter is set to the subsequent effect, creating a series connection of IFX1 → IFX2 → IFX3 → IFX4 → IFX5. The post-IFX5 settings for **Pan: CC#8**, **Bus**, **Send1**, and **Send2** will be used.

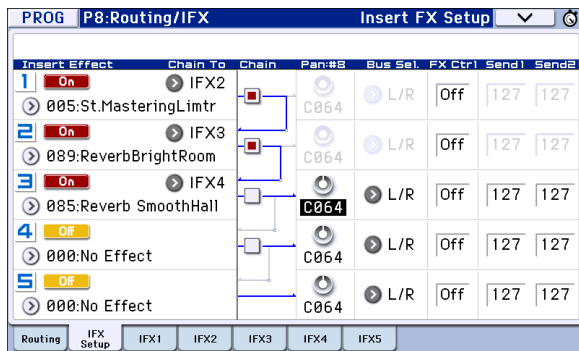

Settings for drum programs

If you have selected “Drums” for **Oscillator Mode** (Prog 1–1a) of a Program, the **Use DKit Setting** box (Prog 8–1c) becomes available. For more information, please see next diagram.

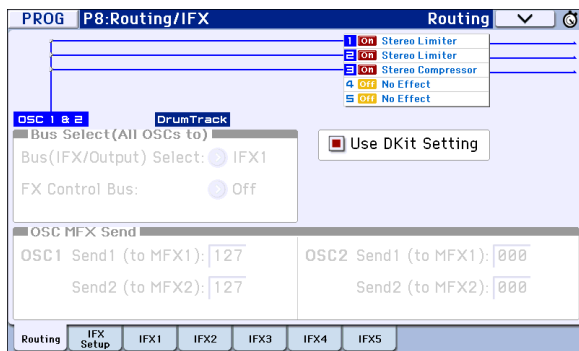

If you check this box, **Bus (IFX/Output) Select**, **FX Control Bus**, **Send1**, and **Send2** (Global 5–5b) for each key of the selected Drum kit becomes effective. For example, you can send a snare sound to IFX1 to apply the Gate effect, a kick

sound to IFX2 to apply EQ, and other sounds to AUDIO OUTPUT L/MONO and R without applying any Insert Effects.

Tip: In most of the preloaded drum kits, the following types of drum instrument have the same **Bus (IFX/Output) Select** settings.

- Snares → IFX1
- Kicks → IFX2
- Other → IFX3

If you de-select the box, all drum instrument outputs are sent to the bus specified by **Bus (IFX/Output) Select** (Prog 8–1b). You may apply any Insert Effects to all drum instruments, regardless of the Drum kit settings.

Combination and Sequencer modes

Use **Bus (IFX/Output) Select** (Combi/Seq 8–1(2)d) for timbres (Combination) and tracks (Sequencer) to select an Insert Effect to apply to the corresponding timbres and tracks. You can route multiple timbres and tracks to a single Insert Effect.

Tip: You can use each timbre/track’s **Bus (IFX/Output) Select**, post-IFX **Chain to** and **Chain** parameters (Combi/Seq 8–3b) to create a variety of routings.

Example: Inserting one IFX into two or more timbres



Example: Inserting a separate IFX into each timbre, and inserting another IFX later

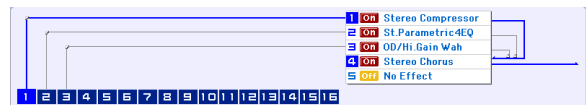

Example: Sharing part of a timbre’s IFX chain with another timbre



As with Program mode, select L/R, IFX1–5, or Off for each timbre and track.

Send1 (to MFX1) and **Send2 (to MFX2)** become available if **Bus (IFX/Output) Select** has been set to L/R or Off. If you’ve set **Bus (IFX/Output) Select** to IFX1–5, use **Send1** and **Send2** (Combi/Seq 8–3b) following the insert effect to adjust the send levels.

MIDI Send1 responds to CC#93, and Send2 responds to CC#91. At this time, the actual send level uses the value of the Send 1 and 2 settings for Oscillators 1 and 2 of the Programs (selected for the timbres and tracks), multiplied by the Send 1 and 2 values received via MIDI.

The following diagram shows an example of Combination mode. The Timbre 1 output is sent to IFX1 and the Timbre 2 output is sent to IFX2 according to the **Bus (IFX/Output) Select** setting. Other timbres are sent to L/R. The output signal passes through the TFX, then goes to AUDIO OUTPUT L/MONO and R.

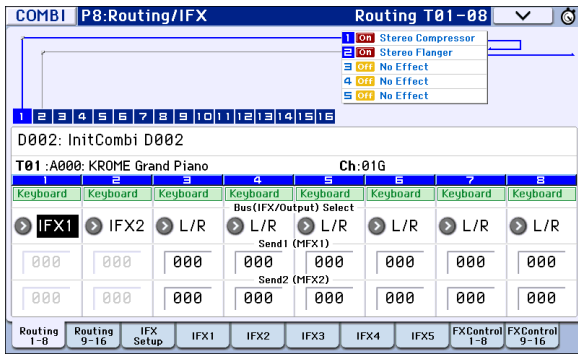

In the next diagram, IFX1's Chain check box is checked and Chain to set to IFX2, sending the output of IFX1 to IFX2. Timbre 1 is being processed by IFX1: Stereo Compressor and IFX2: 038: Stereo Flanger effects. Timbre 2 is being processed by the IFX2: 038: Stereo Flanger effect. The Routing Map area of the next diagram shows these settings. (With these settings, IFX3–5 are not being used.)

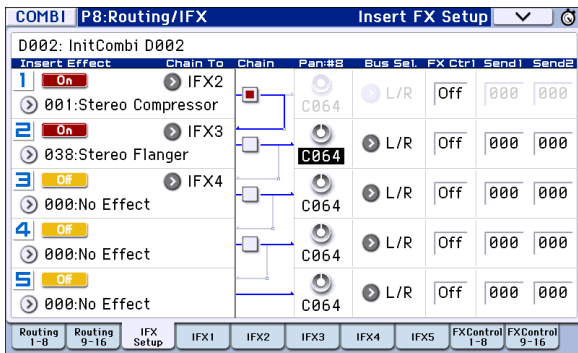

Drum Programs in Combination and Sequencer modes

If you've selected a drum program (Oscillator Mode=Drums or Double Drums) for a timbre (in Combination mode) or track (in Sequencer mode), the DKit setting will be available as a choice for Bus (IFX/Output) Select (see the following diagram).

If Bus (IFX/Output) Select is set to DKit, of each key in the drum kit, letting you specify the bus to which each drum instrument will be sent. For example you can send snare sounds to IFX1, kick sounds to IFX2, and other drum sounds to L/MONO and R.

If this check box is unchecked, all drum instruments will be output according to the Bus (IFX/Output) Select setting of each timbre/track (Combi/Seq 8–1(2)d). This lets you apply an insert effect to all of the drum instruments in that drum kit.

Drum Kit IFX Patch

If Bus (IFX/Output) Select is set to DKit, you'll be able to select the menu command DrumKit IFX Patch.

This option allows you to change the routing of the Insert Effects temporarily by changing Bus (IFX/Output) Select for each key.

For example, assume that the Drum kit key assignment is set so that a snare sound is routed to IFX1 and a kick sound is routed to IFX2 etc., IFX1–3. In this case, if you wish to assign IFX 1 and 2 to the Programs used by other timbres and tracks, you can view the routing so that these Drum kit sounds are routed to IFX3 and IFX5 respectively.

Patching is possible only if the Bus (IFX/Output) Select (Global 5–5b) setting of each key in the drum kit is assigned to an insert effect. The state of these settings is also shown in the Routing Map. Make the desired settings for DrumKit IFX Patch, and press the OK button to execute.

If you want to revert to the original settings of the drum kit, execute Drum Kit IFX Patch with the settings IFX1 → IFX1, IFX2 → IFX2, IFX3 → IFX3, IFX4 → IFX4, and IFX5 → IFX5.

In the following diagram, Drum Program is assigned to Timbre 1, and normal Programs are assigned to Timbres 2 and 3. Bus (IFX/Output) Select is set to DKit for Timbre 1, IFX1 for Timbre 2, and IFX2 for Timbre 3. With Timbre 1, the Bus (IFX/Output) Select (Global 5–5b) for Drum kit setting becomes effective.

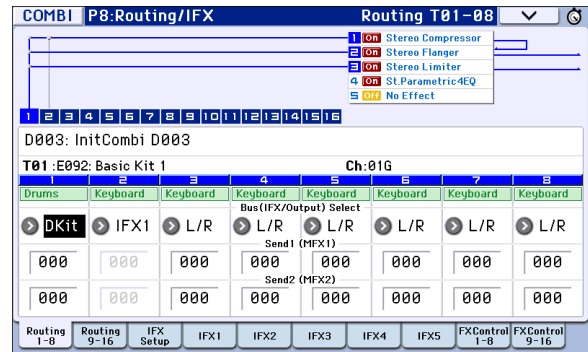

DrumKit IFX Patch dialog

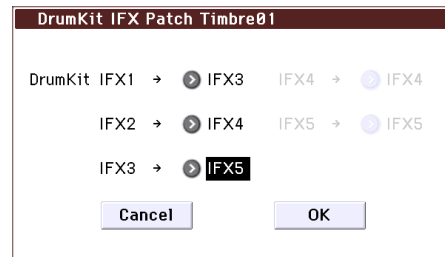

Use the DrumKit IFX Patch menu command if you want the drum program to use effects other than timbres 2 and 3. Choose DrumKit IFX Patch from the page menu, and temporarily send the drum kit IFX1 to IFX3, IFX2 to IFX4, and IFX3 to IFX5. Executing with these settings will temporarily change the effects to which the drum kit is being sent (see the following diagram).

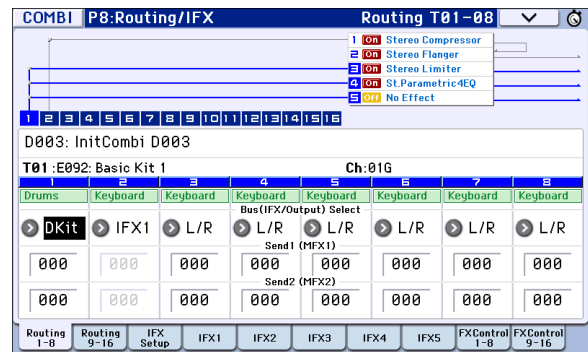

Mixer

In Program, Combination, and Sequencer modes, the P8–Insert FX Setup page lets you set the **Pan: CC#8** (post-IFX panning), **Bus Sel.** (Bus Select), **Ctrl Bus** (FX control bus), and the **Send1** and **Send2** levels to the master effects.

If you have checked the **Chain** to connect the Insert Effects in series, these parameters **Pan: CC#8 – Send2** for the post-IFX (last Insert Effect in the chain) signal become effective.

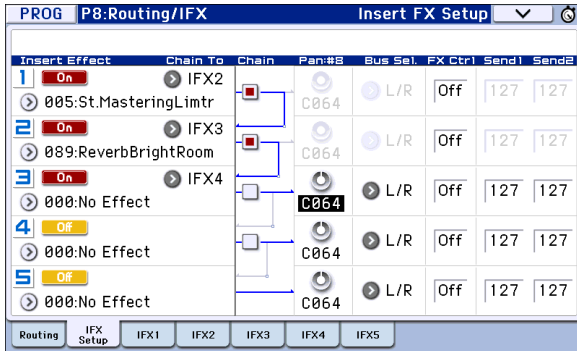

Pan: CC#8

This parameter enables you to set the pan of the post-IFX signal.

If you are using the stereo-in/stereo-out Insert Effects, set this parameter to “C064” to enable the **Pan** settings for the oscillators (Prog 4–1c, 4–5), timbres (Combi 0–3(4)b), tracks (Seq 0–3(4)b).

If you are using mono-in/stereo-out or mono-in/mono-out Insert Effects, the **Pan** settings for the oscillators, timbres, and tracks are ignored, and they are set to Center. Use the **Pan: CC#8** parameter (Prog 8–2a, Combi/Seq 8–3b) to set the pan. “L000” is hard left, and “R127” is hard right.

- For more about effect types such as stereo-in/stereo-out, see “In/Out” on page 240.

MIDI You can control these parameters via CC#8.

Bus Sel. (Bus Select)

This parameter enables you to specify the destination bus for the post-IFX signals.

L/R is a common setting to send signals to the Total Effect (TFX) before they are routed to the AUDIO OUTPUT L/ MONO and R outputs.

If set to **Off**, the signal will not be sent to the L/R bus. Choose this setting if you want to use the **Send1** or **Send2** levels to route the signal through a master effect in series (i.e., not as a send effect).

FX Ctrl (FX Control Bus)

This specifies the FX Control bus that follows the insert effect. The FX Control buses (FX Control 1, 2) are mono two-channel buses.

The KROME provides two (mono two-channel) effect control buses, giving you a wide range of ways to control effects.

FX Control buses can be used with vocoder, limiter, and gate-type effects.

For details on the effects that be used with FX Control buses, see “FX Control Buses” on page 238.

As an example, here’s how you can use the FX Control bus following an insert effect.

Example: Gated Reverb

When using a gate effect with a reverberant sound, using the reverberant sound to control the gate may not produce the desired results because the reverb extends the duration of the sound. Normally, you will use the un-reverberated sound to control the gate, as shown in the diagram below.

In this example, we send the sound from the OSC etc. to IFX1 and process it through an equalizer. IFX1 is sent via **Chain** to IFX2 and also sent via **Ctrl Bus** (FX Control Bus) to 1. The Envelope **Source** of IFX3: Stereo Gate is set to FX Control 1. This allows the gat to be triggered by a signal other than its input (the reverberant sound).

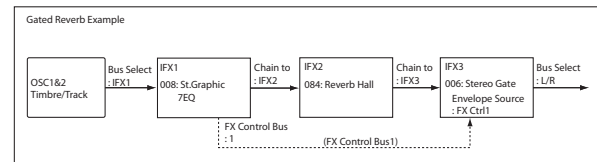

Send1, Send2

These parameters enable you to set the send level of the signals routed to Master Effects MFX1 and MFX2. The signal is sent in stereo to master effects MFX1 and MFX2. This is valid when **Bus (Bus Select)** is L/R or Off.

If you are not using any Insert Effects, use **Send1** and **Send2** of the P8: Routing/IFX– Routing page in Program, Combination, Sequencer, and Song play modes to set the Master Effect send level.

MIDI **Send1** responds to CC#93 and **Send2** responds to CC#91.

Insert Effect = Stereo In – Stereo Out

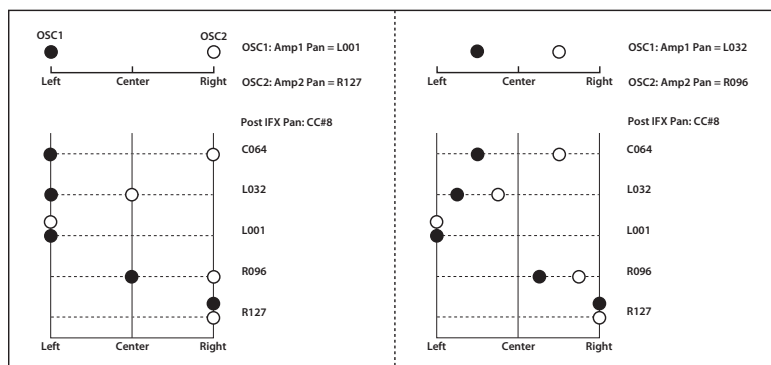

Insert Effect = Mono In - Stereo Out
Mono In - Mono Out

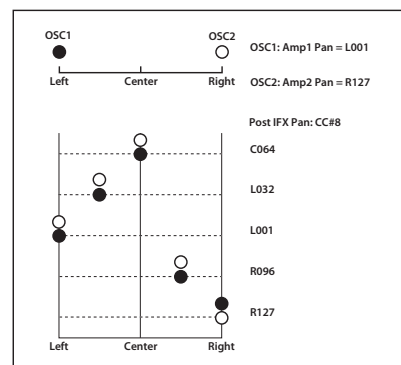

Controlling the Insert Effects via MIDI

Using the Dynamic Modulation (Dmod) function enables you to control all effect parameters in real-time during performance from the controllers of the KROME or a connected MIDI sequencer. You can also control the **Pan**, **CC#8**, **Send1**, and **Send2** parameters in the same way.

Program mode

You can control the parameters on the global **MIDI channel** (Global 1–1a).

Combination mode

The P8: Routing/IFX– IFX1–5 page lets you specify the control channel **Ch** (Control Channel) for IFX1–5. You can choose from CH01–16, Gch, or All-R (All Routed).

Ch01–16: Select this when you want to control each insert effect from a different channel. An “*” symbol will be displayed at the right of the MIDI channel Ch01–16 of the timbre that is routed to each insert effect. If the routed timbres have different MIDI channel settings, this parameter is used to specify the channel that will control the insert effect.

Gch: Select this option if you wish to control the parameters on the global **MIDI channel** (Global 1–1a). This is a common setting.

All-R: Select this option to control the parameters on all the channels (channels 1–16 that have a “*” mark) that are routed to the corresponding Insert Effects.

 If you've selected a drum program for a Combination mode timbre or a Sequencer mode track, and set its **Bus (IFX/Output) Select** to **DKit** (8–1(2)d), the MIDI channel of that timbre/track will be valid if any one of IFX1–5 is set to All-R, regardless of the drum kit's **Bus (IFX/Output) Select** (Global 5–5b) setting or the menu command **DrumKit IFX Patch** setting.

Sequencer mode

Use **Ch** parameters of the P8: Routing/IFX– IFX1 – IFX5 pages to set up the control channels for IFX1–5. Select an appropriate option from Ch01–16 and All Routed.

Ch01–16: Select this when you want to control each insert effect from a different channel. An “*” symbol will be displayed at the right of the MIDI channel Ch01–16 of the track that is routed to each insert effect. If two or more tracks with differing MIDI channels Ch01–16 are being sent to a single insert effect, this parameter is used to specify the one track that will control the insert effect.

All R: Select this option to control the parameters on all the channels (channels 1–16 that have a “*” mark) that are routed to the corresponding Insert Effects. **All R** is a typical option. If you wish to control the parameters on a single channel, you may select it from Ch01–16.

Note: Since Sequencer mode lets you record and play exclusive messages and edit tracks that include System Exclusive events, you can use them to switch effects or modify effect parameter values during song playback.

Master Effects (MFX1, 2)

In/Out

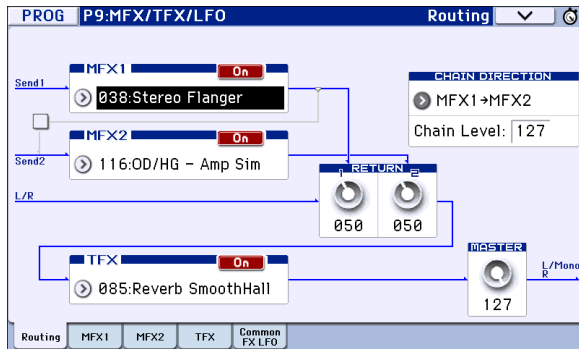

The I/Os of Master Effects MFX1 and MFX2 are stereo-in/ stereo-out. **Send1** and **Send2** determine the send level to the Master Effects. (For Send1 and 2, see “Routing” and “Mixer.”)

Master effects will not output the Dry (unprocessed) signal specified in **Wet/Dry** (P9: MFX/TFX/LFO– MFX1, 2 page). Only the Wet (processed) signal will be output. The output signals from the Master Effects are routed to the L/R bus with the output level specified by **Return1** and **Return2**. These output signals are mixed with the output signals from the bus specified by **Bus** (P8: Routing/IFX– Routing page in each mode) L/R, or with the output signals from the bus specified by **Bus (IFX/Output) Select** (“Insert FX Setup” page in each mode) L/R, then routed to the Master EQ.

Selecting “000: No Effect” will mute the output. The processed signal will be output in one of the following ways, according to the type of effects 001–193.

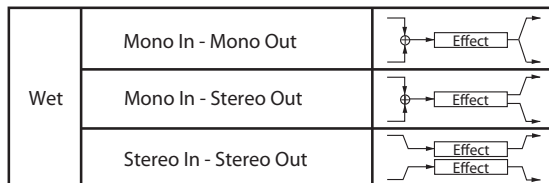

Mono–Mono Parallel

127: P4EQ//P4EQ–171: BPM DI//BPM DI

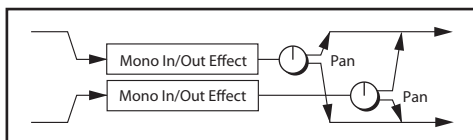

These effects are typically stereo-in/stereo-out, but they have a special structure. The L channel and R channel of the stereo input each have their own independent mono effect. Each mono output can then be panned to the desired position in the stereo field. Normally, you will use these as insert effects, but you can also use them as master effects. For details, see “Mono–Mono Parallel Effects” on page 240.

Input/output variations for each effect are shown in upper left of the block diagrams starting on page 320.

Pressing the On/Off button for MFX1 and 2 of the P9: MFX/TFX/LFO–Routing page in each mode will toggle between On and Off. When Off is selected, the output signals will be muted.

MIDI Separately from the setting of this On/Off button, MFX1 and MFX2 can be switched off by receiving a MIDI control change CC#94. Value 0 will turn them off, and value 1–127 will turn them on. You can also use the front panel MFX button or **Effect Global SW** (Global 0–1b) to turn MFX1 and 2 on and off. This MIDI control is performed on the global **MIDI channel** (Global 1–1a).

Double-size effects

Double-size effects (172: St.Mltband Limiter – 193: Early Reflections) use twice as much space as other effects.

You can use a double-size effect for master effect MFX1. If you’ve selected a double-size effect, MFX2 won’t be available for use.

Routing

If you are not using any Insert Effects in any mode, the Master Effects send levels are determined by the **Send1 (to MFX1)** and **Send2 (to MFX2)** parameters specified independently for the oscillators (Program mode), timbres (Combination mode), tracks (Sequencer mode).

For example, since you can adjust the master effect send levels for each timbre/track, you can make settings so that reverb is applied deeply to the piano, lightly to the strings, and not at all to the bass.

If you’re using insert effects, use the post-IFX **Send1** and **Send2** to adjust the send amounts.

Program mode

Use the **Send1 (to MFX1)** and **Send2 (to MFX2)** parameters of the P8: Routing/IFX– Routing page, or the **Send1** and **Send2** parameters of the P8: Routing/IFX– Insert FX Setup page for the post-IFX1–5 signals, to set the Master Effect send level.

If you have set **Bus (IFX/Output) Select** to L/R or Off, **Send1 (to MFX1)** and **Send2 (to MFX2)** of the “Routing” page are effective. These parameters can be set for oscillators 1 and 2 individually.

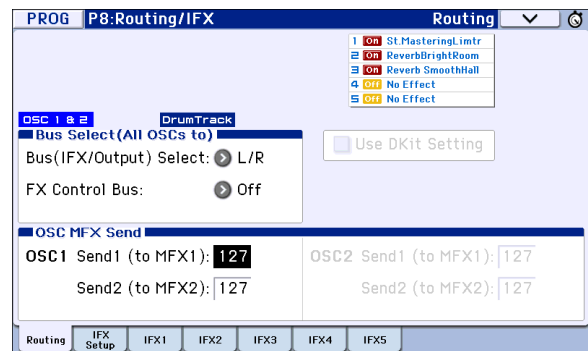

If you have set **Bus (IFX/Output) Select** to IFX1–5, **Send1** and **Send2** of the “Insert FX” page for the post-P8: Routing/IFX– IFX1–5 signals are effective. If you are using the Insert Effects in chain (series), the **Send1** and **Send2** parameters for the post-IFX (last IFX) are effective.

MIDI Send1 responds to CC#93 and Send2 responds to CC#91 on the global **MIDI channel** (Global 1–1a). At this time, the actual send level uses the value of the Send 1 and 2 settings for Oscillators 1 and 2, multiplied by the Send 1 and 2 values received via MIDI.

If you have selected “Drums” for **Oscillator Mode** (Prog 1–1a) of a Program, the **Use DKit Setting** box (Prog 8–1b)

becomes available. If you check this box, Send1 and Send2 levels for each key of the selected Drum kit become effective. If **Bus (IFX/Output) Select** (Global 5–5b) is set to L/R or Off for a drum instrument key, **Send1 (to MFX1)** and **Send2(toMFX2)** (Global 5–5b) become effective.

If **Bus (IFX/Output) Select** is set to IFX1–5, the post-IFX1–5 **Send1** and **Send2** (Prog 8–5a) become effective.

If this is unchecked, **Send1 (to MFX1)** and **Send2 (to MFX2)** (Prog 8–1d), and the post IFX1–5 **Send1** and **Send2** (Prog 8–2a) will be valid for all drum instruments, in the same way as when **Oscillator Mode** is Single or Double.

Combination and Sequencer modes

Use **Send1 (to MFX1)** and **Send2 (to MFX2)** (P8: “Routing” page) for timbres (Combination) and tracks (Sequencer) to set the Send1 and 2 levels for each timbre and track. As with Program mode, if **Bus (IFX/Output) Select** is set to L/R or Off, **Send1 (to MFX1)** and **Send2 (to MFX2)** become effective.

The actual levels use these Send1 and 2 level values, multiplied by the send level values of oscillators 1 and 2 of the Prog P8: Routing/IFX – Routing page.

Send level

For example if you set the program’s OSC1 **Send1 (to MFX1)** to 127, **Send2 (to MFX2)** to 064, OSC2 **Send1 (to MFX1)** to 064, **Send2 (to MFX2)** to 127, and the combination’s **Send1 (to MFX1)** to 064 and **Send2 (to MFX2)** to 127, the actual send levels of the combination will be as follows.

- OSC1 Send1=127 (100%) *064 (50%)=064 (50%)
- OSC1 Send2=064 (50%) *127 (100%)=064 (50%)
- OSC2 Send1=064 (50%) *064 (50%)=032 (25%)
- OSC2 Send2=127 (100%) *127 (100%)=127 (100%)

If IFX1–5 is selected for **Bus (IFX/Output) Select**, use the **Send1** and **Send2** parameters for the post-IFX signals.

MIDI Send1 responds to CC#93, and Send2 responds to CC#91. If **Send1 (to MFX1)** and **Send2 (to MFX2)** for each timbre/track are effective, the parameter will be controlled on the MIDI channels set for the corresponding timbres and tracks. If the **Send1** and **Send2** parameters for the post-IFX1–5 signals are effective, they can be controlled on the MIDI channels assigned to IFX1–5.

An example for Combination mode is given below. In the following diagram, **Bus (IFX/Output) Select** is set so that Timbre 1 is routed to IFX1, Timbre 2 to IFX2, Timbres 3 and 4 to IFX3, Timbres 5–16 to L/R.

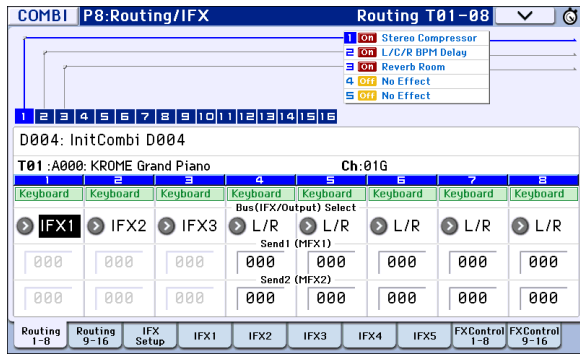

In this case, use **Send1** and **Send2** for the post-IFX1 (001: Stereo Compressor) signal to set the send level of the Timbre 1 routed to the Master Effect. (In this example they are set to 032 and 127.) In the same way, use **Send1** and **Send2** for the post-IFX2 signal to set the send levels of Timbres 2, and use the **Send1** and **Send2** parameters for the post-IFX3 signal to set the send levels of Timbres 3 and 4. For Timbres 5–8, the settings of **Send1 (to MFX1)** and **Send2 (to MFX2)** will be effective (for Timbres 9–16, use the Routing 1 T09–16 page).

(At this time, the actual send levels use these Send 1 and 2 values multiplied by the Send1 and 2 settings for Program oscillators 1 and 2.)

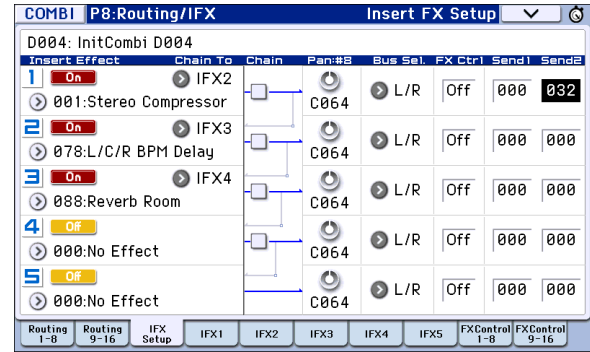

Bus Select “DKit” is valid if you’ve selected a drum track for a Timbre (Combination) or Track (Sequencer).

If you select **DKit**, the **Bus (IFX/Output) Select** (Global 5–5b) settings for each key become effective, and each drum instrument sound will be routed to the corresponding buses. At this time, the actual send levels use these Send 1 and 2 values, multiplied by the Send1 and 2 settings for each Drum kit key.

If a drum kit’s **Bus (IFX/Output) Select** is set to L/R or Off, the levels will be these Send 1 and 2 settings multiplied by the send levels you specify in Prog P8: Routing/IFX – Routing page for OSC1 **Send1 (to MFX1)** and **Send2 (to MFX2)** (Prog 8–1d), just as in other cases (**Oscillator Mode** Single or Double).

If **Bus (IFX/Output) Select** is set to IFX1–5, use **Send1** and **Send2** for the post-IFX signal.

Media mode In Media mode, effects will use the settings of the mode in which you previously were.

Mixer

The input levels to the master effects are determined by the send levels. In the P9: MFX/TFX/LFO– Routing page of each mode, you can specify the output level and chaining (series connection) between the two master effects.

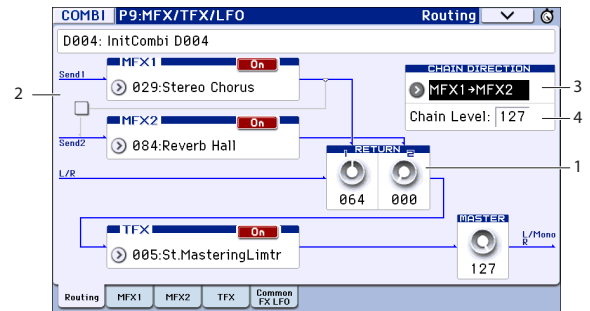

1. Return1, Return2

These adjust the amount of signal that is returned from the master effects MFX1 and MFX2 outputs to the L/R bus.

The left-side value of the **Wet/Dry** parameter for the MFX1 or 2 effect is the output level of that master effect. (In other words if **Wet/Dry** is 25:75, the output level is 75%. It is 100% if **Wet**, and 0% if **Dry**.) The **Wet/Dry** value multiplied by the **Return1** or **Return2** value is sent to the L/R bus and mixed with the P8 : Routing/IFX – Routing page **Bus (IFX/Output) Select** L/R or Insert FX Setup page **Bus** L/R output.

For example, with MFX1 **Wet/Dry** set to 50:50 (50%) and **Return1** set to 64 (50%), the resultant effect level will be 25%.

The effect level is maximum (100%) when **Wet/Dry** is set to "Wet" and **Return1** is set to 127.

2. Chain check box

Press this box to chain MFX1 and MFX2 to each other.

In the example shown in the preceding page, the output of MFX1:029: Stereo Chorus is added to the input of MFX2:084: Reverb Hall.

3. Chain Direction

If you have checked the **Chain** box, you can set the direction of the connection here. You can also visually confirm the direction on the display.

4. Chain Level

This parameter determines the level of signals routed from one MFX to the other MFX in a chain connection.

Controlling the Master Effects via MIDI

In the same way as for insert effects, parameters of the master effects can also be controlled in realtime via Dynamic Modulation (Dmod) from the KROME's controllers or an external MIDI device during performance or from the sequencer.

Program mode

Effect parameters are controlled on the global **MIDI channel** (Global 1–1a).

Combination and Sequencer modes

In Combination and Sequencer modes, the control channel for MFX1 and MFX2 are specified by the **Ch** (Control Channel) setting in the MFX1 and 2 pages. You can choose Ch01–16 or Gch.

Ch01–16: Select this option if you wish to control the parameters for each Master Effect on different channels.

Gch: Select this option if you wish to control the parameters on the global **MIDI channel** (Global 1–1a). This is the normal setting.

Note: Since Sequencer mode lets you record and play exclusive messages and edit tracks that include System Exclusive events, you can use them to switch effects or modify effect parameter values during song playback.

Total Effect (TFX)

In/Out

The total effect TFX is stereo-in and stereo-out. The Dry (unprocessed) side of the **Wet/Dry** parameter sends the stereo input sound directly to the stereo output. The way in which the Wet (processed) side is output depends on the type of effect, as follows.

| | | |
|-----|------------------------|--|
| Wet | Mono In - Mono Out | |
| | Mono In - Stereo Out | |
| | Stereo In - Stereo Out | |

Mono-Mono Parallel

127: P4EQ // P4EQ —171: BPM DI // BPM DI

For more information, please see “Mono-Mono Parallel Effects” on page 240.

If you select 000:No Effect, the stereo input will be passed to the stereo output without any processing.

Input/output variations for each effect are shown in upper left of the block diagrams starting on page 320.

You can switch the effects on/off using the MFX1 or 2 ON/OFF buttons or the P9:MFX/TFX/LFO- Routing settings in each mode. When off, the effect will be bypassed. The stereo input will be passed to the stereo output without any processing, just as if 000:No Effect is selected.

MIDI Separately from this On/Off button, MIDI control change CC#95 can be received to turn TFX off. A control change value of 0 turns them off, and a value of 1-127 restores them to the prior setting. You can also use the front panel TFX button or **Effect Global SW** (Global 0-1b) to turn off TFX in the same way. This is controlled on the global **MIDI channel** (Global 1-1a).

Double-size effects

Double-size effects (172: St.Mltband Limiter - 193: Early Reflections) can't be used for the total effect.

Routing

The total effect TFX is placed immediately before the AUDIO OUTPUT L/MONO and R outputs. Effect (TFX) is available in all modes.

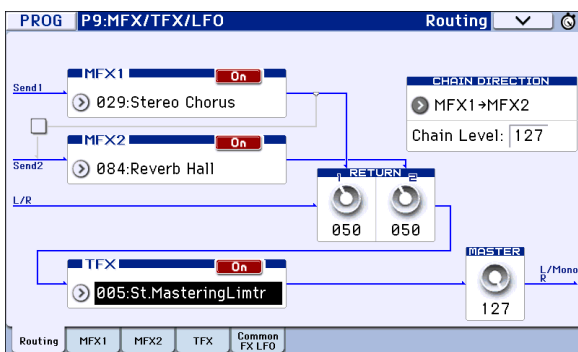

If the **Bus (IFX/Output) Select** setting for an oscillator (Program mode), timbre (Combination mode), track (Sequencer mode), or the post-insert **Bus (IFX/Output)**

Select is set to L/R, the signal will be output from the AUDIO OUTPUT L/MONO and R jacks.

The sound from MFX1 and 2 is routed through TFX, and then output to AUDIO OUTPUT L/MONO and R.

Mixer

MASTER (Master Volume)

This sets the level of the final output after passing through the total effect.

Using MIDI to control the Total Effect

In the same way as for Insert and Master Effects, the Total Effect can be controlled in realtime via Dynamic Modulation (Dmod). You can use either the built-in KROME's controllers or an external MIDI device, during live performance or from a sequencer.

Program mode

Effect parameters are controlled on the global **MIDI channel** (Global 1-1a).

Combination and Sequencer modes

In Combination and Sequencer modes, the control channel for TFX is specified by the **Ch** (Control Channel) setting in the TFX page. You can choose Ch01-16 or Gch.

Ch01-16: Choose from these settings if you want to control each total effect on a separate channel.

Gch: Choose this setting if you want to control the total effect on the global **MIDI channel** (Global 1-1a).

Note: In Sequencer mode, you can record and play back exclusive messages, and edit tracks that include System Exclusive events. This lets you switch effects or vary the value of effect parameters while a song plays.

Outputs

Main Outputs

The main L/MONO and R outputs of the KROME are output from the AUDIO OUTPUT L/MONO, R jacks, and the headphone jack.

Effect/Mixer Block Diagrams

Program mode

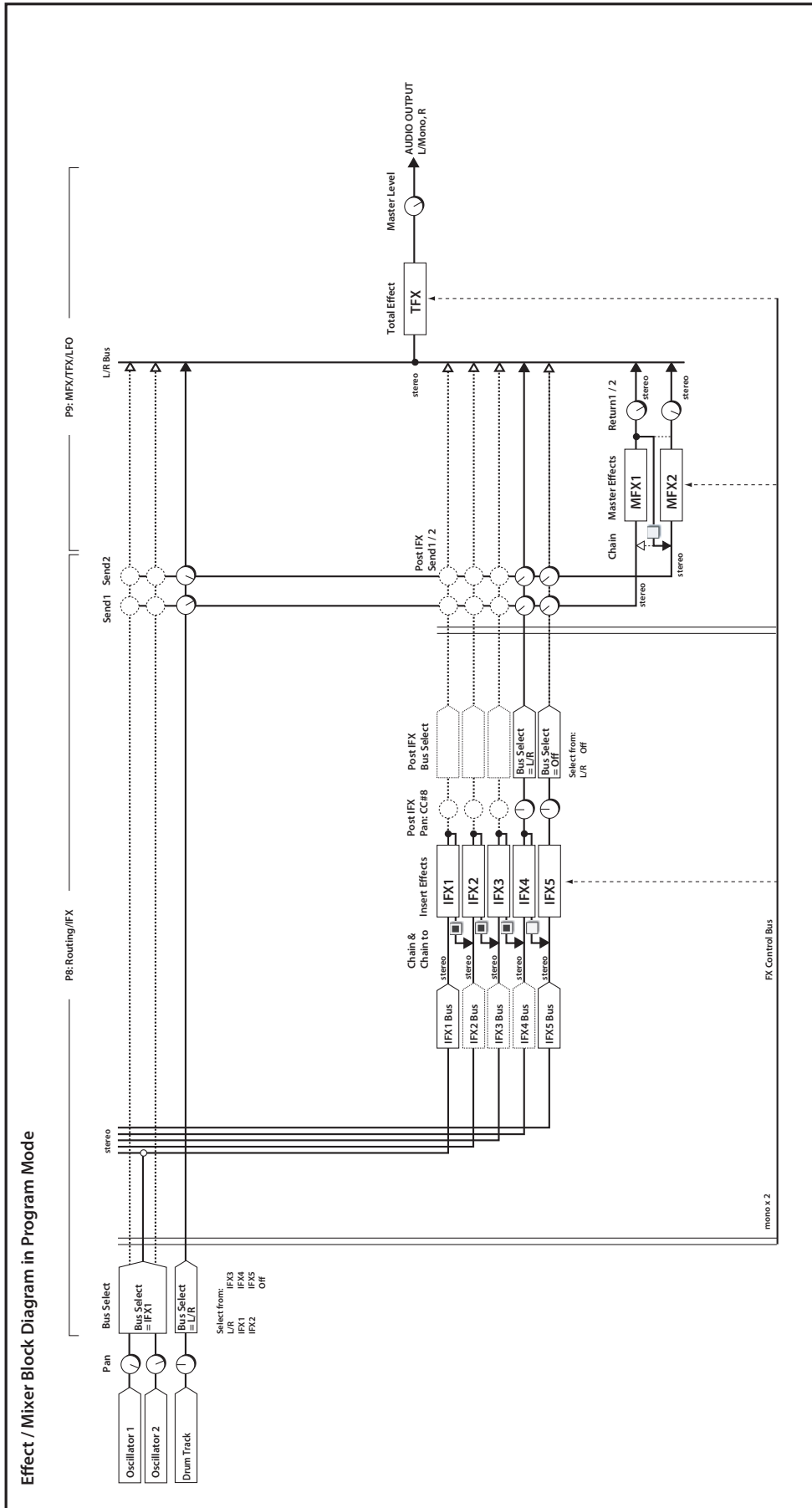

Combination mode, Sequencer mode

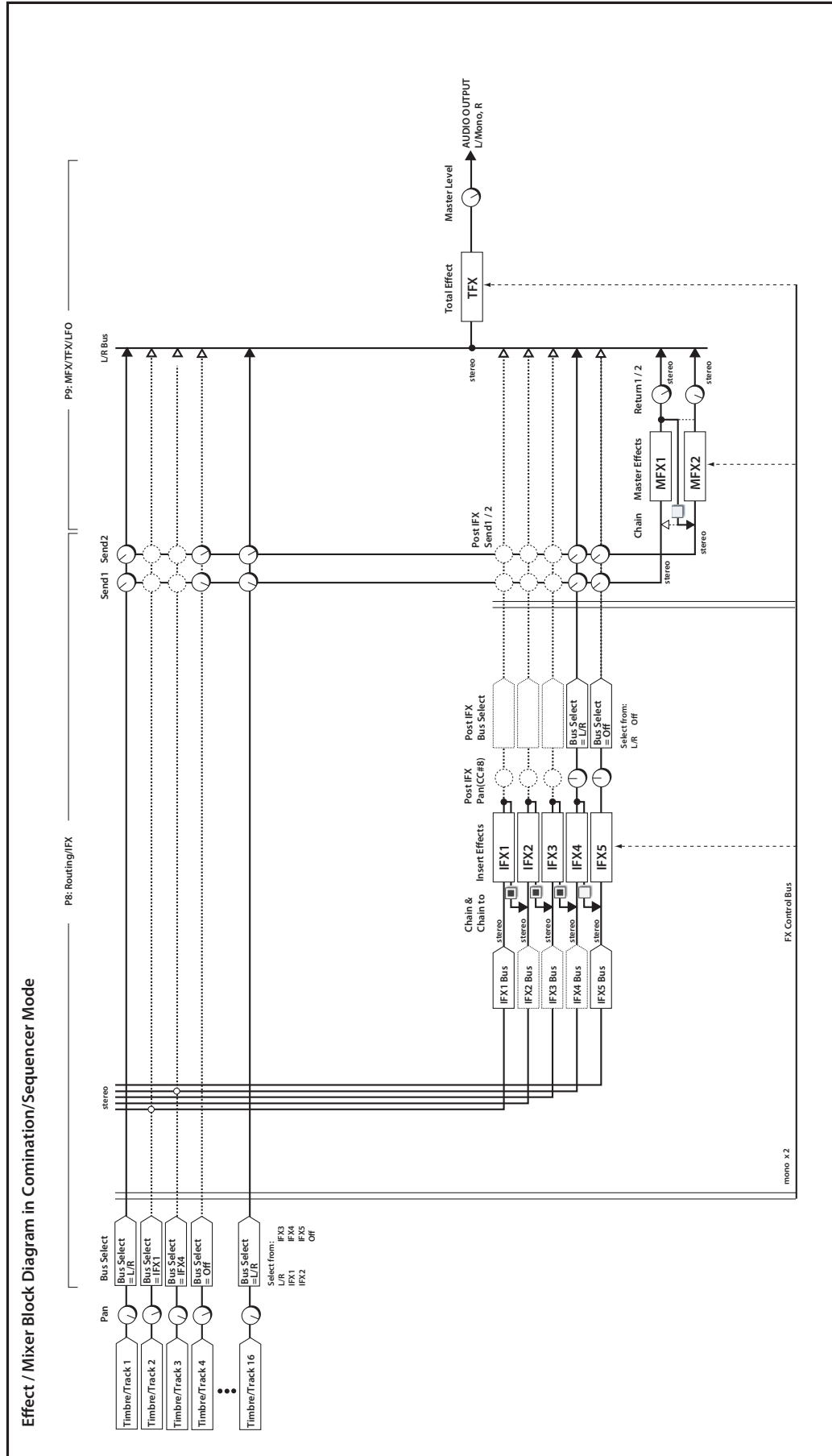

Dynamics (Dynamic)

000: No Effect

Select this option when you do not use any effects. The Insert Effect/Total Effect section outputs unprocessed signals and the Master Effect section mutes the output.

001: Stereo Compressor

This effect compresses the input signal to regulate the level and give a “punchy” effect. It is useful for guitar, piano, and drum sounds. This is a stereo compressor. You can link left and right channels, or use each channel separately.

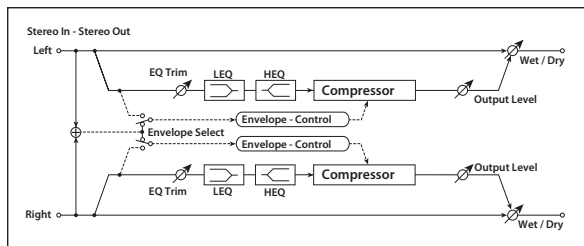

| | | | | |
|---|-------------------|----------------------------|--|-------|
| a | Envelope Select | L/R Mix, L/R Individually | Determines whether the left and right channels are linked or used separately | |
| b | Sensitivity | 1...100 | Sets the sensitivity | |
| c | Attack | 1...100 | Sets the attack level | |
| d | EQ Trim | 0...100 | Sets the EQ input level | |
| e | Pre LEQ Fc | Low, Mid-Low | Selects the cutoff frequency (low or mid-low) of the low-range equalizer | |
| | Pre HEQ Fc | High, Mid-High | Selects the cutoff frequency (high or mid-high) of the high-range equalizer | |
| f | Pre LEQ Gain [dB] | -15.0...+15.0 | Sets the gain of the Low EQ | |
| | Pre HEQ Gain [dB] | -15.0...+15.0 | Sets the gain of the High EQ | |
| g | Output Level | 0...100 | Sets the output level of the compressor | D-mod |
| | Src | Off...Tempo | Selects the modulation source for the compressor output level | |
| | Amt | -100...+100 | Sets the modulation amount for the compressor output level | |
| h | Wet/Dry | Dry, 1 : 99... 99 : 1, Wet | Sets the balance between the effect and the dry input | D-mod |
| | Src | Off...Tempo | Selects a modulation source for Wet/Dry | |
| | Amt | -100...+100 | Sets the modulation amount for Wet/Dry | |

a: Envelope Select

This parameter selects whether the left and right channels are linked to control both signals simultaneously, or whether each channel is controlled independently.

b: Sensitivity

g: Output Level (Level)

The **Sensitivity** parameter sets the sensitivity of the compressor. If this parameter is set to a higher value, lower level sounds will be boosted. With a higher Sensitivity, the overall volume level is higher. To adjust the final volume level, use the **Output Level** parameter.

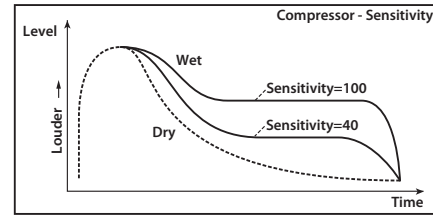

c: Attack

This parameter controls the attack level.

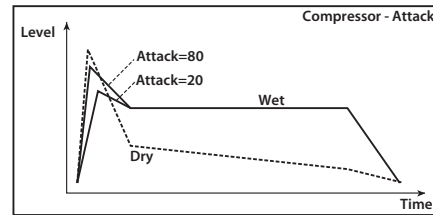

002: Red Comp

When playing chords on an electric piano or similar instrument, it's helpful to use a compressor to keep each note smooth and well-balanced. In addition to a distinctive percussive accent, it will also provide a long sustain. This effect models a popular compressor with a clean sound that's perfect for pop and funk music.

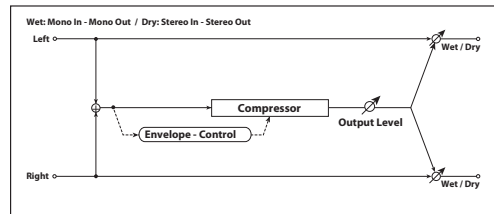

| | | | | |
|---|-------------|----------------------------|---|-------------|
| a | Sensitivity | 1...100 | Sets the sensitivity | p.251 |
| b | Attack | 1...100 | Sets the attack level | p.251 |
| c | Level | 0...100 | Sets the output level of the compressor | p.251 D-mod |
| | Src | Off...Tempo | Selects the modulation source for Level | |
| | Amt | -100...+100 | Sets the modulation amount for Level | |
| d | Wet/Dry | Dry, 1 : 99... 99 : 1, Wet | Sets the balance between the effect and the dry input | D-mod |
| | Src | Off...Tempo | Selects the modulation source for Wet/Dry | |
| | Amt | -100...+100 | Sets the modulation amount for Wet/Dry | |

003: Stereo Limiter

The Limiter regulates the input signal level. It is similar to the Compressor, except that the Limiter compresses only signals that exceed the specified level to lower unnecessary peak signals. The Limiter applies a peaking-type EQ to the trigger signal (which controls the degree of the Limiter effect), allowing you to set any band width to be covered. This effect is a stereo limiter. You can link left and right channels, or use each channel individually.

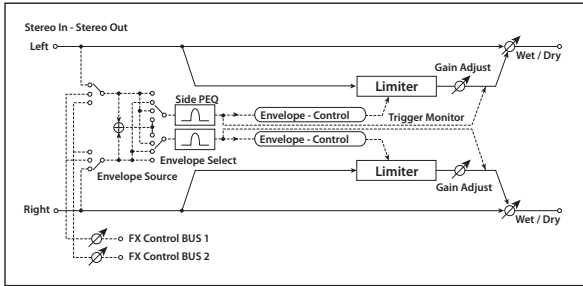

| | | | | |
|---|----------------------|---|---|--|
| a | Envelope Source | Input, FX Control 1, FX Control 2 | Selects the trigger source to use: the input signal, FX Control Bus 1, or FX Control Bus 2 p.252 | |
| | FX Ctrl Trim | 0...100 | Sets the trigger input level from FX Control Bus 1/2 | |
| b | Envelope Select | L/R Mix, L Only, R Only, L/R Individually | Selects from linking both channels, controlling only from left channel, only from the right channel, or controlling each channel individually p.252 | |
| c | Ratio | 1.0 : 1 ... 50.0 : 1, Inf : 1 | Sets the signal compression ratio p.252 | |
| d | Threshold [dB] | -40...0 | Sets the level above which the compressor is applied p.252 | |
| e | Attack | 1...100 | Sets the attack time p.252 | |
| | Release | 1...100 | Sets the release time p.252 | |
| f | Gain Adjust [dB] | -Inf, -38...+24 | Sets the output gain p.252 | |
| | Src | Off...Tempo | Selects the modulation source for the output gain | |
| g | Amt | -63...+63 | Sets the modulation amount of the output gain | |
| | Side PEQ Insert | Off, On | Toggles between on/off of the trigger signal's EQ p.252 | |
| h | Trigger Monitor | Off, On | Switches between effect output monitor and trigger signal monitor p.252 | |
| | Side PEQ Cutoff [Hz] | 20...12.00k | Sets the EQ center frequency for the trigger signal p.252 | |
| | Q | 0.5...10.0 | Sets the EQ bandwidth for the trigger signal p.252 | |
| i | Gain [dB] | -18.0...+18.0 | Sets the EQ gain for the trigger signal p.252 | |
| | Wet/Dry | Dry, 1 : 99... 99 : 1, Wet | Sets the balance between the effect and the dry input | |
| | Src | Off...Tempo | Selects a modulation source for Wet/Dry | |
| | Amt | -100...+100 | Sets the modulation amount for Wet/Dry | |

a: Envelope Source

By selecting FX Control 1 or FX Control 2 you can use the signal of FX Control Bus 1 or 2 as the trigger signal.

For instance, you might use a different, unprocessed sound as the trigger, or apply a limiter triggered by a different timbre (Combination) or track (Sequence). For more information, please see "FX Control Buses" on page 238.

b: Envelope Select

When L/R Mix is selected for this parameter, the left and right channels are linked to control the Limiter using the mixed signal. If L Only (or R Only) is selected, the left and right channels are linked, and the Limiter is controlled via only the left (or right) channel.

With L/R individually, the left and right channels control the Limiter individually.

c: Ratio

d: Threshold [dB]

f: Gain Adjust [dB]

This parameter sets the signal compression Ratio. Compression is applied only when the signal level exceeds the Threshold value.

Adjust the output level using the Gain Adjust parameter, since compression causes the entire level to be reduced.

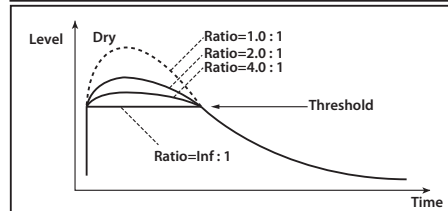
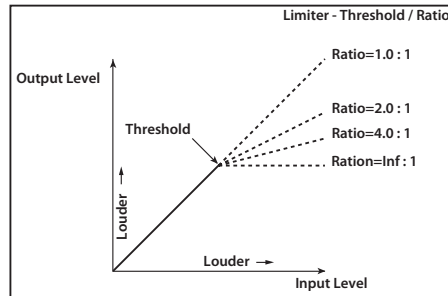

e: Attack

e: Release

These parameters set the attack time and release time. A higher attack time will cause the compression to be applied more slowly.

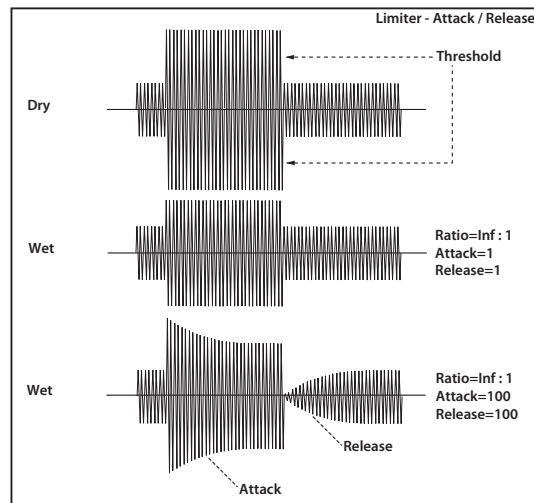

g: Trigger Monitor

Setting this parameter On will cause the trigger signal to be output, instead of the effect sound. Use this parameter to check the trigger signal with EQ applied. Usually, set this to Off.

g: Side PEQ Insert

h: Side PEQ Cutoff [Hz]

h: Q

h: Gain [dB]

These parameters are used to set the EQ applied to the trigger signal.

The Limiter determines whether the compression is applied or not, based on the post-EQ trigger signal. Setting the

equalizer allows you to set the Limiter to respond to any frequency band.

004: Multiband Limiter

This effect applies the Limiter to the low range, mid range, and high range of the input signal. You can control dynamics for each range to adjust the sound pressure of the low range, mid range, and high range in a different way from the EQ.

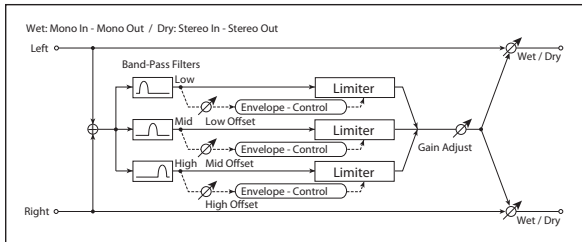

| | | | | |
|---|------------------|-----------------------------|--|-------|
| a | Ratio | 1.0 : 1...50.0 : 1, Inf : 1 | Sets the signal compression ratio p.252 | |
| b | Threshold [dB] | -40...0 | Sets the level above which the compressor is applied p.252 | |
| c | Attack | 1...100 | Sets the attack time p.252 | |
| d | Release | 1...100 | Sets the release time p.252 | |
| e | Low Offset [dB] | -40...0 | Gain of the low-range trigger signal p.253 | |
| f | Mid Offset [dB] | -40...0 | Gain of the mid-range trigger signal p.253 | |
| g | High Offset [dB] | -40...0 | Gain of the high-range trigger signal p.253 | |
| h | Gain Adjust [dB] | -Inf, -38...+24 | Sets the output gain p.252 | D-mod |
| | Src | Off...Tempo | Selects the modulation source for the output gain | |
| i | Amt | -63...+63 | Sets the modulation amount of the output gain | |
| | Wet/Dry | Dry, 1 : 99... 99 : 1, Wet | Sets the balance between the effect and the dry input | D-mod |
| i | Src | Off...Tempo | Selects a modulation source for Wet/Dry | |
| | Amt | -100...+100 | Sets the modulation amount for Wet/Dry | |

e: Low Offset [dB]

f: Mid Offset [dB]

g: High Offset [dB]

These parameters set the gain of the trigger signal.

For example, if you do not want to apply compression to the high range, reduce the **High Offset** value down below the **Threshold** level. In this way, the high range limiter will not respond, and compression will not be applied.

005: St.MasteringLimtr (Stereo Mastering Limiter)

This is a stereo limiter that is optimized for mastering songs.

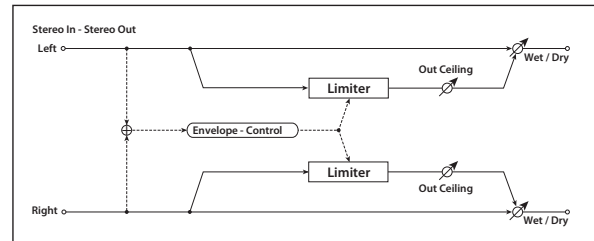

| | | | | |
|---|------------------|----------------------------|--|-------|
| a | Threshold [dB] | -30.0...0.0 | Sets the level above which the compressor is applied p.252 | |
| b | Out Ceiling [dB] | -30.0...0.0 | Sets the output gain | |
| c | Release [msec] | 0.50...1000.0 | Sets the release time p.252 | |
| d | Wet/Dry | Dry, 1 : 99... 99 : 1, Wet | Sets the balance between the effect and the dry input | D-mod |
| | Src | Off...Tempo | Selects a modulation source for Wet/Dry | |
| | Amt | -100...+100 | Sets the modulation amount for Wet/Dry | |

006: Stereo Gate

This effect mutes the input signal when it falls below a specified level. You can also invert the on/off status of the gate, or use note-on/off messages to turn the gate on/off directly.

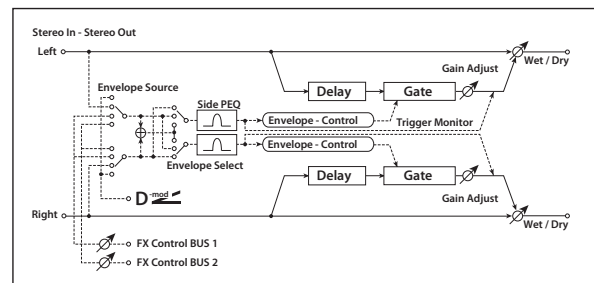

| | | | | |
|---|-------------------|--|--|-------|
| a | Envelope Source | D-mod, Input, FX Control 1, FX Control 2 | Selects the source to control the gate: D-mod control, or use the input signal or FX Control Bus 1 or 2 as a trigger p.252 | |
| | Fx Ctrl Trim | 0...100 | Sets the trigger input level from FX Control Bus 1/2 | |
| b | Envelope Select | L/R Mix, L Only, R Only | Selects the control signal: left and right linked, left only, or right only p.252 | |
| | Src | Off...Tempo | Selects the source that will control the gate when Envelope Src = D-mod | D-mod |
| c | Threshold | 0...100 | Sets the level at which gating is applied p.254 | |
| | Polarity | +, - | Switches the polarity of gating p.254 | |
| d | Attack | 1...100 | Sets the attack time p.254 | |
| | Release | 1...100 | Sets the release time p.254 | |
| e | Delay Time [msec] | 0...100 | Sets the delay time for the gate input p.254 | |
| f | Side PEQ Insert | Off, On | Switches the trigger signal equalizer on/off p.252 | |
| | Trigger Monitor | Off, On | Switches between monitoring the effect output and the trigger signal p.252 | |

| | | | | |
|---|----------------------|-------------------------------|--|---|
| g | Side PEQ Cutoff [Hz] | 20...12.00k | Sets the center frequency of the equalizer for the trigger signal p.252 | |
| | Q | 0.5...10.0 | Sets the bandwidth of the equalizer for the trigger signal p.252 | |
| | Gain [dB] | -18.0...+18.0 | Sets the gain of the equalizer for the trigger signal p.252 | |
| h | Wet/Dry | Dry, 1 : 99... 99 : 1, Wet | Sets the balance between the effect and the dry input |  |
| | Src | Off...Tempo | Selects a modulation source for Wet/Dry | |
| | Amt | -100...+100 | Sets the modulation amount for Wet/Dry | |

c: Threshold

d: Attack

d: Release

Threshold specifies the level at which gating occurs when **Envelope Select** is set to L/R Mix, L Only, or R Only.

Attack and **Release** specify the attack time and release time of the gate.

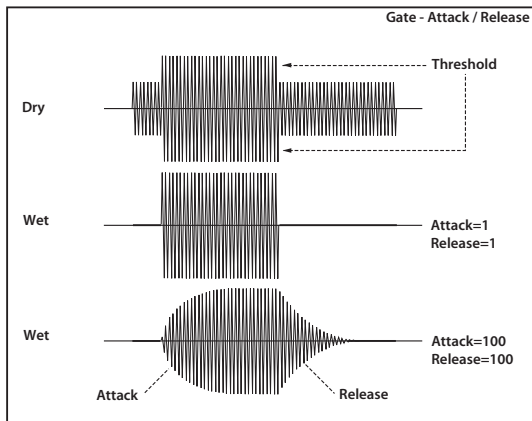
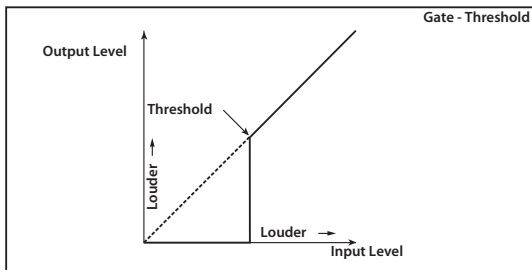

c: Polarity

This inverts the polarity of the gate on/off operation. With the “-” setting, the gate will close when the input signal exceeds the specified level. The direction in which the modulation source opens or closes the gate will also be reversed.

e: Delay Time [msec]

This sets the delay time for the input to the gate. When using shorter Attack Time settings, you can lengthen the Delay Time so that the sound is input after the gate opens.

EQ and Filters (EQ/Filter)

007: St.Parametric4EQ (Stereo Parametric 4-Band EQ)

This is a stereo 4-band parametric equalizer. You can select peaking type or shelving type for Band 1 and 4. The gain of Band 2 can be controlled by dynamic modulation.

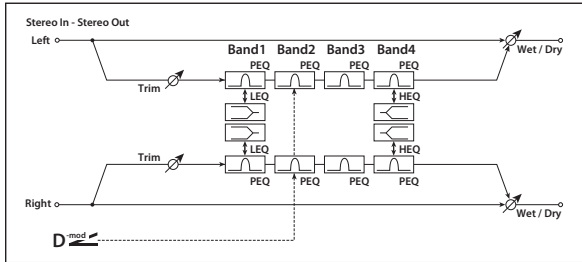

| | | | | |
|---|------------------------|----------------------------|---|-------|
| a | Trim | 0...100 | Sets the input level | |
| b | Band1 Type | Peaking, Shelving-Low | Selects the type of Band 1 | p.255 |
| c | Band4 Type | Peaking, Shelving-High | Selects the type of Band 4 | p.255 |
| d | Band2 Dynamic Gain Src | Off...Tempo | Selects the modulation source of the Band 2 gain | p.255 |
| | Amt [dB] | -18.0...+18.0 | Sets the modulation amount of Band 2 gain | p.255 |
| e | Band1 Cutoff [Hz] | 20...1.00k | Sets the center frequency of Band 1 | |
| | Q | 0.5...10.0 | Sets the bandwidth of Band 1 | p.255 |
| | Gain [dB] | -18.0...+18.0 | Sets the gain of Band 1 | |
| f | Band2 Cutoff [Hz] | 50...10.00k | Sets the center frequency of Band 2 | |
| | Q | 0.5...10.0 | Sets the bandwidth of Band 2 | p.255 |
| | Gain [dB] | -18.0...+18.0 | Sets the gain of Band 2 | D-mod |
| g | Band3 Cutoff [Hz] | 300...10.00k | Sets the center frequency of Band 3 | |
| | Q | 0.5...10.0 | Sets the bandwidth of Band 3 | p.255 |
| | Gain [dB] | -18.0...+18.0 | Sets the gain of Band 3 | |
| h | Band4 Cutoff [Hz] | 500...20.00k | Sets the center frequency of Band 4 | |
| | Q | 0.5...10.0 | Sets the bandwidth of Band 4 | p.255 |
| | Gain [dB] | -18.0...+18.0 | Sets the gain of Band 4 | |
| i | Wet/Dry | Dry, 1 : 99... 99 : 1, Wet | Sets the balance between the effect and the dry input | D-mod |
| | Src | Off...Tempo | Selects a modulation source for Wet/Dry | |
| | Amt | -100...+100 | Sets the modulation amount for Wet/Dry | |

b: Band1 Type

c: Band4 Type

Selects a filter type for Band 1 and 4.

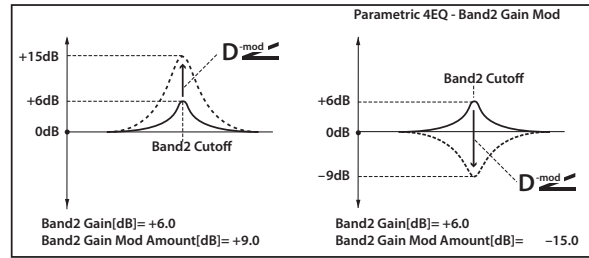
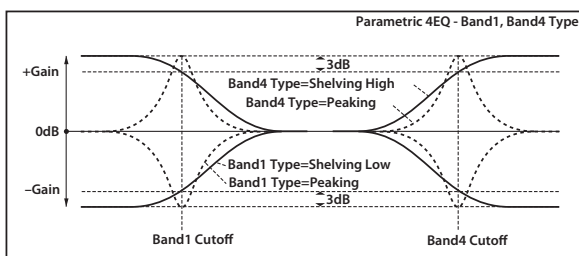

e, f, g, h: Q

These parameters set the bandwidth of each equalizer. The higher the value, the narrower the band becomes.

d: Band2 Dynamic Gain Src

d: Amt [dB]

You can control the gain of Band 2 using the modulation source.

008: St. Graphic 7EQ (Stereo Graphic 7-Band EQ)

This is a stereo 7-band graphic equalizer. The bar graph of the gain setting for each band gives you a clear, visual idea of frequency responses. You can select a center frequency setting for each band from twelve types, according to the sound.

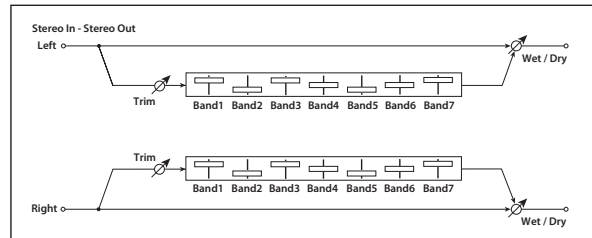

| | | | | |
|---|------------|---|---|-------|
| a | Type | 1:Wide 1, 2:Wide 2, 3:Wide 3, 4:Half Wide 1, 5:Half Wide 2, 6:Half Wide 3, 7:Low, 8:Wide Low, 9:Mid, 10:Wide Mid, 11:High, 12:Wide High | Selects a combination of center frequencies for each band | p.255 |
| b | Trim | 0...100 | Sets the input level | |
| c | Band1 [dB] | -18.0...+18.0 | Sets the gain of Band 1 | |
| d | Band2 [dB] | -18.0...+18.0 | Sets the gain of Band 2 | |
| e | Band3 [dB] | -18.0...+18.0 | Sets the gain of Band 3 | |
| f | Band4 [dB] | -18.0...+18.0 | Sets the gain of Band 4 | |
| g | Band5 [dB] | -18.0...+18.0 | Sets the gain of Band 5 | |
| h | Band6 [dB] | -18.0...+18.0 | Sets the gain of Band 6 | |
| i | Band7 [dB] | -18.0...+18.0 | Sets the gain of Band 7 | |
| j | Wet/Dry | Dry, 1 : 99... 99 : 1, Wet | Sets the balance between the effect and the dry input | D-mod |
| | Src | Off...Tempo | Selects a modulation source for Wet/Dry | |
| | Amt | -100...+100 | Sets the modulation amount for Wet/Dry | |

a: Type

This parameter selects a combination of center frequencies for each band. The center frequency of each band is shown in the right of the screen.

You can configure a 21-Band Graphic EQ ranging from 80 Hz to 18 kHz if you route three Graphic 7-Band EQ effects in series, with a setting of 7:Low, 9:Mid, and 11:High for each EQ.

009: St.Exciter/Enhncr (Stereo Exciter/Enhancer)

This effect is a combination of the Exciter, which adds a punch to the sound and the Enhancer, which adds spread and presence.

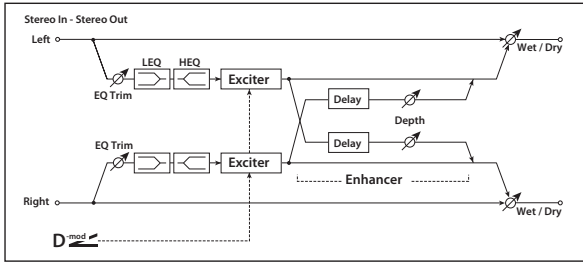

| | | | | |
|---|-------------------------|----------------------------|---|--|
| a | Exciter Blend | -100...+100 | Sets the intensity (depth) of the Exciter effect p.256 | |
| | Src | Off...Tempo | Selects the modulation source of the Exciter intensity | |
| | Amt | -100...+100 | Sets the modulation amount of the Exciter intensity | |
| b | Emphasis Frequency | 0...70 | Sets the frequency to be emphasized p.256 | |
| | Src | Off...Tempo | Selects the modulation source of the frequency to be emphasized | |
| | Amt | -70...+70 | Sets the amount of modulation of the frequency to be emphasized | |
| c | Enhancer Delay L [msec] | 0.0...50.0 | Sets the delay time for the Enhancer left channel p.256 | |
| d | Enhancer Delay R [msec] | 0.0...50.0 | Sets the delay time for the Enhancer right channel p.256 | |
| e | Enhancer Depth | 0...100 | Sets the determines to what degree the Enhancer effect is applied | |
| | Src | Off...Tempo | Selects the modulation source of the Enhancer width | |
| | Amt | -100...+100 | Sets the modulation amount of the Enhancer width | |
| f | EQ Trim | 0...100 | Sets the 2-band EQ input level | |
| g | Pre LEQ Fc | Low, Mid-Low | Selects the cutoff frequency (low or mid-low) of the low-range equalizer | |
| | Pre HEQ Fc | High, Mid-High | Selects the cutoff frequency (high or mid-high) of the high-range equalizer | |
| h | Pre LEQ Gain [dB] | -15.0...+15.0 | Sets the gain of the Low EQ | |
| | Pre HEQ Gain [dB] | -15.0...+15.0 | Sets the gain of the High EQ | |
| i | Wet/Dry | Dry, 1 : 99... 99 : 1, Wet | Sets the balance between the effect and the dry input | |
| | Src | Off...Tempo | Selects a modulation source for Wet/Dry | |
| | Amt | -100...+100 | Sets the modulation amount for Wet/Dry | |

a: Exciter Blend

This parameter sets the depth (intensity) of the Exciter effect. Positive values give a frequency pattern (to be emphasized) different from negative values.

b: Emphasis Frequency

This parameter sets the frequency to be emphasized. Higher values will emphasize lower frequencies.

c: Enhancer Delay L [msec]

d: Enhancer Delay R [msec]

These parameters set the delay time for the Enhancer left and right channel. Specifying a slightly different delay time for the left and right channel will add a stereo image, depth, and width to the sound.

010: Stereo Isolator

This is a stereo effect that separates the input signal into low, mid, and high-frequency bands, and controls the volume of each band independently. For example you can separately boost or cut the kick, snare, and hi-hat sounds from a drum signal in realtime.

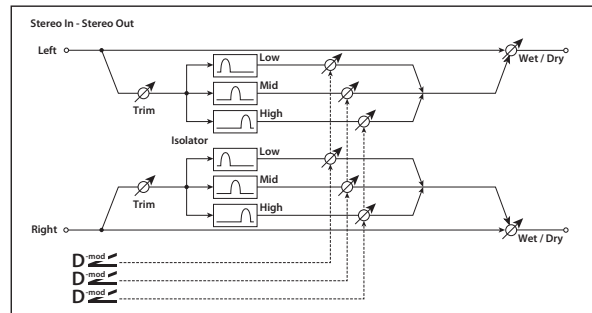

| | | | | |
|---|----------------|----------------------------|--|--|
| a | Trim | 0...100 | Sets the input level | |
| b | Low/Mid [Hz] | 100...500 | Sets the frequency at which the low and mid bands are divided | |
| c | Mid/High [Hz] | 2000...6000 | Sets the frequency at which the mid and high bands are divided | |
| d | Low Gain [dB] | -Inf, -59...+12 | Sets the low-frequency gain | |
| | Src | Off...Tempo | Selects the source that will modulate low-frequency gain | |
| | Amt | -72...+72 | Sets the amount by which the low-frequency gain will be modulated | |
| e | Mid Gain [dB] | -Inf, -59...+12 | Sets the mid-frequency gain | |
| | Src | Off...Tempo | Selects the modulation source for mid-frequency gain | |
| | Amt | -72...+72 | Sets the amount by which the mid-frequency gain will be modulated | |
| f | High Gain [dB] | -Inf, -59...+12 | Sets the high-frequency gain | |
| | Src | Off...Tempo | Selects the modulation source for high-frequency gain | |
| | Amt | -72...+72 | Sets the amount by which the high-frequency gain will be modulated | |
| g | Wet/Dry | Dry, 1 : 99... 99 : 1, Wet | Sets the balance between the effect and the dry input | |
| | Src | Off...Tempo | Selects a modulation source for Wet/Dry | |
| | Amt | -100...+100 | Sets the modulation amount for Wet/Dry | |

011: St. Wah/Auto Wah (Stereo Wah/Auto Wah)

This stereo wah effect allows you to create sounds from vintage wah pedal simulation to auto-wah simulation, and much broader range settings.

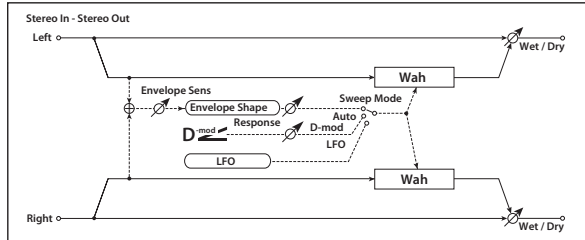

| | | | | |
|---|-------------------------|------------------------------|---|-----------|
| a | Frequency Bottom | 0...100 | Sets the lower limit of the wah center frequency p.257 | |
| | Frequency Top | 0...100 | Sets the upper limit of the wah center frequency p.257 | |
| b | Sweep Mode | Auto, D-mod, LFO | Selects the control from auto-wah, modulation source, and LFO p.257 | |
| | Src | Off...Tempo | Selects the modulation source for the wah when Sweep Mode=D-mod | D-mod |
| | Response | 0...100 | Sets the response speed when Sweep Mode = Auto or D-mod | |
| c | Envelope Sens | 0...100 | Sets the sensitivity of auto-wah p.257 | |
| | Envelope Shape | -100...+100 | Sets the sweep curve of auto-wah p.257 | |
| d | LFO Frequency [Hz] | 0.02...20.00 | Sets the speed of the LFO p.257 | D-mod |
| | Src | Off...Tempo | Selects a modulation source for LFO speed | |
| | Amt | -20.00...+20.00 | Sets the modulation amount of LFO speed | |
| e | MIDI Sync | Off, On | When this is on, the LFO speed is set by BPM, Base Note, and Times, instead of Frequency p.257 | MIDI Sync |
| | BPM | MIDI, 40.00...300.00 | MIDI syncs to the system tempo; 40-300 sets the tempo manually for this individual effect p.257 | |
| | Base Note | | Selects the type of notes that specify the LFO speed p.257 | |
| | Times | x1...x32 | Sets the number of notes that specify the LFO speed p.257 | |
| f | LFO Type | Individual, Common1, Common2 | Selects either (individual) LFO, Common FX LFO1, or Common LFO2 p.257 | |
| | Common LFO Offset [deg] | -180...+180 | Sets the phase offset when Type = Common 1 or Common 2 p.257 | Common |
| g | Resonance | 0...100 | Sets the resonance amount | |
| | Low Pass Filter | Off, On | Switches the wah low pass filter on and off | |
| h | Output Level | 0...100 | Sets the output level of the effect sound | D-mod |
| | Src | Off...Tempo | Selects the modulation source that will control the effect output level | |
| | Amt | -100...+100 | Sets the modulation amount of the effect output level | |
| i | Wet/Dry | Dry, 1 : 99...99 : 1, Wet | Sets the balance between the effect and the dry input | D-mod |
| | Src | Off...Tempo | Selects a modulation source for Wet/Dry | |
| | Amt | -100...+100 | Sets the modulation amount for Wet/Dry | |

a: Frequency Bottom

a: Frequency Top

The sweep width and direction of the wah filter are determined by the **Frequency Top** and **Frequency Bottom** settings.

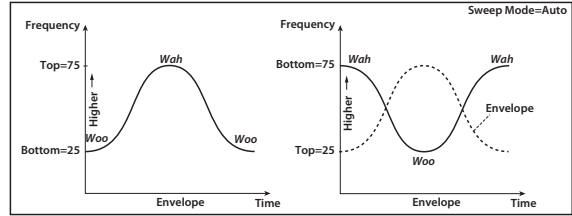
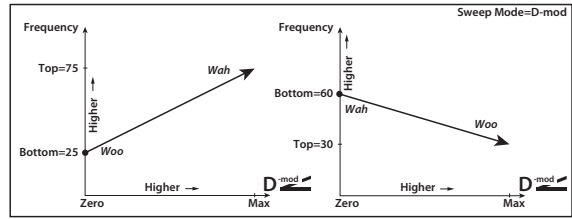

b: Sweep Mode

This parameter changes the wah control mode. Setting **Sweep Mode** to Auto will select an auto-wah that sweeps according to envelope changes in the input signal level. Auto-wah is frequently used for funk guitar parts and clav sounds.

When **Sweep Mode** is set to D-mod, you can control the filter directly via the modulation source in the same way as a wah pedal.

When **Sweep Mode** is set to LFO, the effect uses LFO to sweep in cycle.

c: Envelope Sens

This parameter sets the sensitivity of auto-wah. Increase the value if the input signal is too low to sweep. Reduce the value if the input signal is so high that the filter is stopped temporarily.

c: Envelope Shape

This parameter determines the sweep curve for auto-wah.

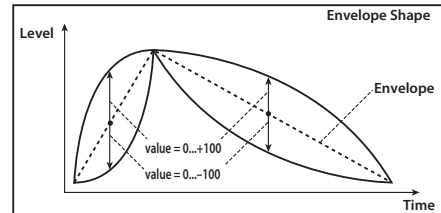

d: LFO Frequency [Hz]

e: MIDI Sync

When **MIDI Sync=Off**, the LFO speed uses the LFO Frequency parameter setting. When **MIDI Sync=On**, the LFO speed follows the **BPM**, **Base Note**, and **Times** settings.

e: BPM

e: Base Note

e: Times

One cycle of LFO sweep is obtained by multiplying the length of a note () (selected for **Base Note**, in relation to the tempo specified in **BPM**, or the MIDI Clock tempo if **BPM** is set to MIDI) by the number specified in the **Times** parameter.

f: LFO Type

f: Common LFO Offset [deg]

If **Type** is set to Common 1 or Common 2, modulation will be applied using the Common FX LFO rather than the LFO within the effect itself. Since this lets you use the same LFO for multiple effects, it's useful when you want to apply various types of modulation in synchronization.

Common LFO Offset specifies the phase difference relative to the Common FX LFO. For more information, please see “Common FX LFOs” on page 237.

012: St. Vintage Wah (Stereo Vintage/Custom Wah)

This effect simulates the tonal character of a vintage wah pedal. You can customize the tone and range settings.

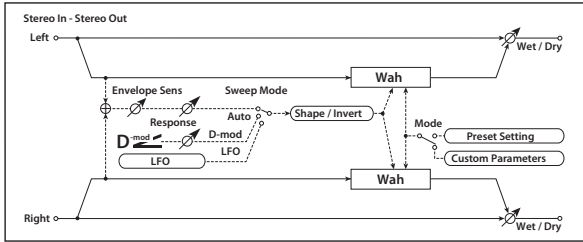

| | | | | |
|---|-------------------------|------------------------------|---|--|
| a | Mode | Preset, Custom | Selects either preset or custom settings p.258 | |
| | Shape | -100...+100 | Sets the curve of the sweep p.258 | |
| | Invert | Off, On | Inverts the polarity of the sweep | |
| b | Frequency Bottom | 0...100 | Sets the lower limit of the wah center frequency when Mode = Custom p.258 | |
| | Frequency Top | 0...100 | Sets the upper limit of the wah center frequency when Mode = Custom p.258 | |
| c | Resonance Bottom | 0...100 | Sets the lower limit of resonance amount when Mode=Custom p.258 | |
| | Resonance Top | 0...100 | Sets the upper limit of resonance amount when Mode=Custom p.258 | |
| d | Sweep Mode | Auto, D-mod, LFO | Selects the control from auto-wah, modulation source, and LFO p.257 | |
| | Src | Off...Tempo | Selects the modulation source for the wah when Sweep Mode=D-mod | |
| | Manual | 0...100 | Sets the center frequency when Sweep Mode=D-mod and Source=Off | |
| e | Envelope Sens | 0...100 | Sets the auto-wah sensitivity | |
| | Response | 0...100 | Sets the speed of response when Sweep Mode=Auto or D-mod | |
| f | LFO Frequency [Hz] | 0.02...20.00 | Sets the speed of the LFO p.257 | |
| | Src | Off...Tempo | Selects a modulation source for LFO speed | |
| | Amt | -20.00...+20.00 | Sets the modulation amount of LFO speed | |
| g | MIDI Sync | Off, On | When this is on, the LFO speed is set by BPM, Base Note, and Times, instead of Frequency p.257 | |
| | BPM | MIDI, 40.00...300.00 | MIDI syncs to the system tempo; 40-300 sets the tempo manually for this individual effect p.257 | |
| | Base Note | | Selects the type of notes that specify the LFO speed p.257 | |
| | Times | x1...x32 | Sets the number of notes that specify the LFO speed p.257 | |
| h | LFO Type | Individual, Common1, Common2 | Selects either (individual) LFO, Common FX LFO1, or Common LFO2 p.257 | |
| | Common LFO Offset [deg] | -180...+180 | Sets the phase offset when Type = Common 1 or Common 2 p.257 | |

| | | | | |
|---|--------------|----------------------------|---|--|
| i | Output Level | 0...100 | Sets the output level of the effect sound | |
| | Src | Off...Tempo | Selects the modulation source that will control the effect output level | |
| | Amt | -100...+100 | Sets the modulation amount of the effect output level | |
| j | Wet/Dry | Dry, 1 : 99... 99 : 1, Wet | Sets the balance between the effect and the dry input | |
| | Src | Off...Tempo | Selects a modulation source for Wet/Dry | |
| | Amt | -100...+100 | Sets the modulation amount for Wet/Dry | |

a: Shape

This parameter specifies the sweep curve of the wah. It applies to all control via auto-wah, modulation source, and LFO, and lets you adjust subtle nuances of the wah effect.

a: Mode

b: Frequency Bottom

b: Frequency Top

c: Resonance Bottom

c: Resonance Top

If Mode=Preset, this simulates a vintage wah pedal. In this case, internally fixed values are used for Frequency Bottom/Top and Resonance Bottom/Top, and these settings will be ignored. The settings for Frequency Bottom/Top and Resonance Bottom/Top are valid if Mode=Custom.

013: VOX Wah

This models the legendary VOX V847 and V848 Clyde McCoy wah pedals. Its distinctive tone, sounding as though it were wrung from the throat, made this pedal a favorite of many pro musicians.

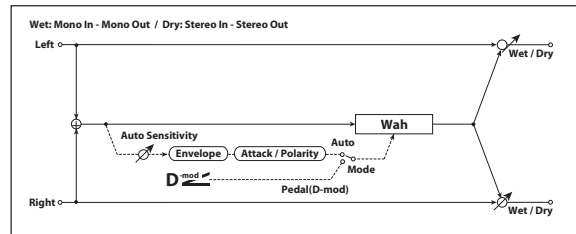

| | | | | |
|---|------------------|----------------------------|---|--|
| a | Type | V847, V848 | Selects the type of wah | |
| b | Open | 1...100 | Sets the lower limit of the wah center frequency p.257 | |
| c | Close | 1...100 | Sets the upper limit of the wah center frequency p.257 | |
| d | Mode | Pedal, Auto | Switches between pedal wah and auto-wah | |
| e | Pedal Source | 0...100 | Specifies the modulation source that will use the pedal wah | |
| f | Pedal Manual | 0...100 | Sets the center frequency for the pedal wah when the modulation source is not moved | |
| g | Auto Sensitivity | 0...100 | Sets the auto-wah sensitivity | |
| h | Auto Polarity | Up, Down | Specifies whether the auto-wah sweep is normal or inverted | |
| i | Auto Attack | 0...10 | Sets the auto-wah's attack speed | |
| j | Wet/Dry | Dry, 1 : 99... 99 : 1, Wet | Sets the balance between the effect and the dry input | |
| | Src | Off...Tempo | Selects a modulation source for Wet/Dry | |
| | Amt | -100...+100 | Sets the modulation amount for Wet/Dry | |

014: St. Random Filter (Stereo Random Filter)

This stereo band pass filter uses a step-shape waveform and random LFO for modulation. You can create a special effect from filter oscillation.

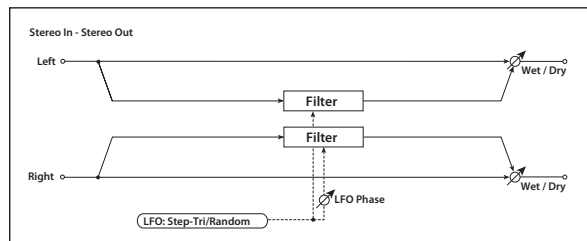

| | | | | |
|---|-------------------------|-----------------------------------|---|--------|
| a | LFO Waveform | Step-Tri, Random | Selects the LFO Waveform p.259 | |
| | LFO Phase [degree] | -180...+180 | Sets the LFO phase difference between the left and right p.259 | |
| b | LFO Frequency [Hz] | 0.02...20.00 | Sets the speed of the LFO p.259 | D-mod |
| | Src | Off...Tempo | Selects the modulation source used for both LFO speed and step speed | |
| | Amt | -20.00...+20.00 | Sets the modulation amount of LFO speed | |
| c | LFO Step Frequency [Hz] | 0.05...50.00 | Sets the LFO step speed (speed that changes in steps) p.259 | D-mod |
| | Amt | -50.00...+50.00 | Sets the modulation amount of LFO step speed | |
| d | MIDI Sync | Off, On | When this is on, the LFO speed is set by BPM, Base Note, and Times, instead of Frequency p.257 | ASync |
| | BPM | MIDI, 40.00...300.00 | MIDI syncs to the system tempo; 40-300 sets the tempo manually for this individual effect p.259 | |
| | Base Note | | Selects the type of notes that specify the LFO speed p.259 | |
| | Times | x1...x32 | Sets the number of notes that specify the LFO speed p.259 | |
| e | Step Base Note | | Selects the type of notes to specify the LFO step speed p.259 | ASync |
| | Times | x1...x32 | Sets the number of notes to specify the LFO step speed p.259 | |
| f | LFO Type (Step) | Individual, Common1, Common2 | Selects either (individual) LFO, Common FX LFO1, or Common LFO2 to control the LFO step speed p.257 | Common |
| | Common LFO Offset [deg] | -180...+180 | Sets the phase offset when Type = Common 1 or Common 2 p.257 | |
| g | Manual | 0...100 | Sets the filter center frequency | |
| | Src | Off...Tempo | Selects the modulation source for the filter center frequency | |
| | Amt | -100...+100 | Sets the modulation amount for the filter center frequency | |
| h | Depth | 0...100 | Sets the modulation depth of filter center frequency | D-mod |
| | Src | Off...Tempo | Selects the modulation source of filter modulation | |
| | Amt | -100...+100 | Sets the modulation amount of filter modulation | |
| i | Resonance | 0...100 | Sets the resonance amount | |
| j | Wet/Dry | -Wet...-1 : 99, Dry, 1 : 99...Wet | Sets the balance between the effect and the dry input p.259 | D-mod |
| | Src | Off...Tempo | Selects a modulation source for Wet/Dry | |
| | Amt | -100...+100 | Sets the modulation amount for Wet/Dry | |

a: LFO Phase [degree]

Offsetting the left and right phases alters how modulation is applied to the left and right channels, creating a swelling affect.

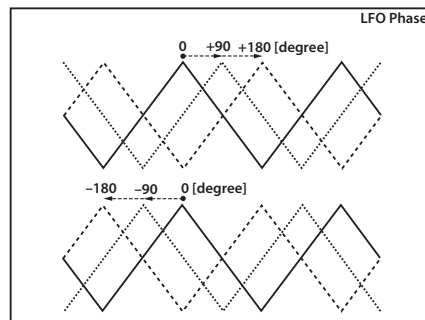

a: LFO Waveform

b: LFO Frequency [Hz]

c: LFO Step Frequency [Hz]

When **LFO Waveform** is set to Step-Tri, LFO is a step-shape, triangle waveform. The **LFO Frequency** parameter sets the original triangle waveform speed. Changing the **LFO Step Frequency** parameter enables you to adjust the width of the steps.

When **LFO Waveform** is set to Random, the **LFO Step Frequency** parameter uses a random LFO cycle.

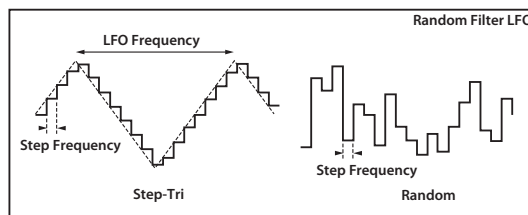

d: BPM

e: Step Base Note

e: Times

The width of an LFO step, or a cycle of random LFO, is obtained by multiplying the length of a note (...) (selected for **Step Base Note**, in relation to the tempo specified in **BPM**, or the MIDI Clock tempo if **BPM** is set to MIDI) by the number specified in the **Times** parameter.

i: Wet/Dry

The effect sound's phase will be reversed when you set this parameter in the range of values from -Wet to -1:99.

015: Multi Mode Filter (Stereo Multi Mode Filter)

This is a multi-mode filter with four types; low pass, high pass, band pass, and band reject. You can use LFO or dynamic modulation to vary the cutoff frequency or resonance.

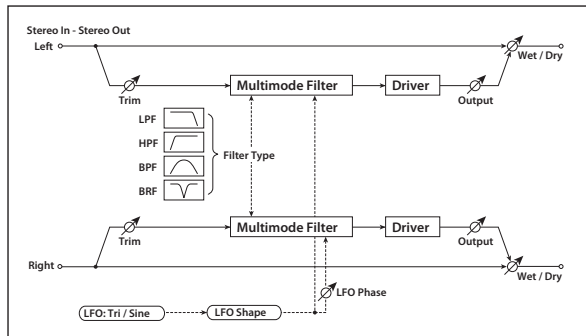

| | | | | |
|---|-------------------------|------------------------------|---|-------|
| a | Type | LPF, HPF, BPF, BRF | Selects the type of filter | |
| | Trim | 0...100 | Sets the input level | |
| b | Cutoff | 0...100 | Sets the cutoff frequency (center frequency) | |
| | Src | Off...Tempo | Selects the modulation source of the cutoff | |
| | Amt | -100...+100 | Sets the modulation amount of the cutoff | |
| c | Resonance | 0...100 | Sets the resonance amount | |
| | Src | Off...Tempo | Selects the source that will modulate the amount of resonance | |
| | Amt | -100...+100 | Sets the amount by which the resonance will be modulated | |
| d | LFO Waveform | Triangle, Sine | Selects the LFO Waveform | |
| | Phase [deg] | -180...+180 | Sets the LFO phase difference between the left and right | p.259 |
| | Depth | 0...100 | Sets the depth to which the LFO will modulate the cutoff frequency | |
| e | LFO Frequency [Hz] | 0.02...20.00 | Sets the speed of the LFO | p.259 |
| | Src | Off...Tempo | Selects a modulation source for LFO speed | |
| | Amt | -20.00...+20.00 | Sets the modulation amount of LFO speed | |
| f | MIDI Sync | Off, On | When this is on, the LFO speed is set by BPM, Base Note, and Times, instead of Frequency | |
| | BPM | MIDI, 40.00...300.00 | MIDI syncs to the system tempo; 40-300 sets the tempo manually for this individual effect | p.257 |
| | Base Note | | Selects the type of notes that specify the LFO speed | p.257 |
| | Times | x1...x32 | Sets the number of notes that specify the LFO speed | p.257 |
| g | LFO Type | Individual, Common1, Common2 | Selects either (individual) LFO, Common FX LFO1, or Common LFO2 | |
| | Common LFO Offset [deg] | -180...+180 | Sets the phase offset when Type = Common 1 or Common 2 | p.257 |
| h | Drive SW | Off, On | Switches distortion on/off within the filter | |
| | Output Level | 0...100 | Sets the output level | |
| i | Drive Gain | 0...100 | Sets the distortion amount | |
| | Low Boost | 0...100 | Sets the amount of low-range boost | |

| | | | | |
|---|---------|----------------------------|---|--|
| j | Wet/Dry | Dry, 1 : 99... 99 : 1, Wet | Sets the balance between the effect and the dry input | |
| | Src | Off...Tempo | Selects a modulation source for Wet/Dry | |
| | Amt | -100...+100 | Sets the modulation amount for Wet/Dry | |

016: St. Sub Oscillator (Stereo Sub Oscillator)

This effect adds very low frequencies to the input signal. It is very useful when simulating a roaring drum sound or emphasizing powerful low range. This effect is different from the equalizer in that you can add very low range harmonics. You can also adjust the oscillator frequency to match a particular note number, for use as an octaver.

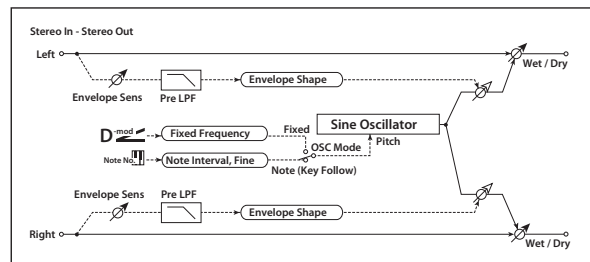

| | | | | |
|---|----------------------|----------------------------|--|-------|
| a | OSC Mode | Note (Key Follow), Fixed | Determines whether the oscillator frequency follows the note number or whether it is fixed | p.260 |
| b | Note Interval | -48...0 | Sets the pitch difference from the note number when OSC Mode=Note (Key Follow) | p.260 |
| | Note Fine | -100...+100 | Fine adjustment of the oscillator frequency | p.260 |
| c | Fixed Frequency [Hz] | 10.0...80.0 | Sets the oscillator frequency when OSC Mode=Fixed | |
| | Src | Off...Tempo | Selects the modulation source for the oscillator frequency when OSC Mode=Fixed | |
| | Amt | -80...+80 | Sets the oscillator frequency modulation amount when OSC Mode=Fixed | |
| d | Envelope Pre LPF | 1...100 | Sets the upper limit of the frequency range for which very low harmonics are added | p.260 |
| e | Envelope Sens | 0...100 | Sets the sensitivity with which very low harmonics are added | |
| | Envelope Shape | -100...+100 | Sets the oscillator's volume envelope curve | |
| f | Wet/Dry | Dry, 1 : 99... 99 : 1, Wet | Sets the balance between the effect and the dry input | |
| | Src | Off...Tempo | Selects a modulation source for Wet/Dry | |
| | Amt | -100...+100 | Sets the modulation amount for Wet/Dry | |

a: OSC Mode

b: Note Interval

b: Note Fine

The **OSC Mode** parameter selects the oscillator operation mode. When **Note (Key Follow)** is selected, the oscillator's frequency is determined based on the note number, allowing you to use it as an octaver. The **Note Interval** parameter sets the pitch offset from the original note number by semitone steps. The **Note Fine** parameter allows you to fine-tune in steps of cents.

d: Envelope Pre LPF

This parameter sets the upper limit of the frequency range to which very low harmonics are added. Adjust this parameter

if you do not want to add lower harmonics to the higher range.

017: Talking Modulator

This effect adds an unusual character, like a human voice, to the input signal. Modulating the tone via dynamic modulation, you can create an interesting effect that sounds as if the guitar or synthesizer is talking.

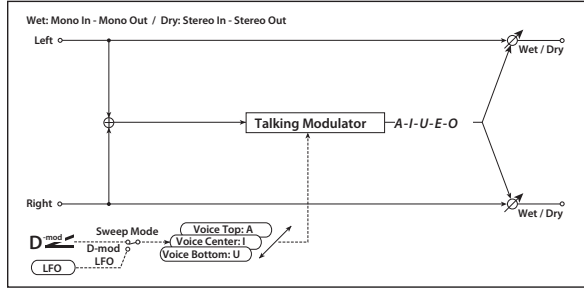

| | | | | |
|---|-------------------------|--------------------------------------|---|-----------|
| a | Sweep Mode | D-mod, LFO | Switches between modulation source control and LFO control | |
| b | Manual Voice Control | Bottom, 1...49, Center, 51...99, Top | Voice pattern control | |
| | Src | Off...Tempo | Selects the modulation source that controls the voice pattern | D-mod |
| c | Voice Top | A, I, U, E, O | Selects a vowel sound at the top end of control p.261 | |
| d | Voice Center | A, I, U, E, O | Selects a vowel sound in the center of control p.261 | |
| e | Voice Bottom | A, I, U, E, O | Selects a vowel sound at the bottom end of control p.261 | |
| f | Formant Shift | -100...+100 | Sets the frequency to which the effect is applied p.261 | |
| | Resonance | 0...100 | Sets the Level of resonance of the voice pattern p.261 | |
| g | LFO Frequency [Hz] | 0.02...20.00 | Sets the speed of the LFO p.257 | D-mod |
| | Src | Off...Tempo | Selects a modulation source for LFO speed | |
| h | MIDI Sync | Off, On | When this is on, the LFO speed is set by BPM, Base Note, and Times, instead of Frequency p.257 | AESync |
| | BPM | MIDI, 40.00...300.00 | MIDI syncs to the system tempo; 40-300 sets the tempo manually for this individual effect p.257 | |
| i | Base Note | | Selects the type of notes that specify the LFO speed p.257 | |
| | Times | x1...x32 | Selects the number of notes that specify the LFO speed p.257 | |
| j | LFO Type | Individual, Common1, Common2 | Selects either (individual) LFO, Common FX LFO1, or Common LFO2 p.257 | AESCommon |
| | Common LFO Offset [deg] | -180...+180 | Sets the phase offset when Type = Common 1 or Common 2 p.257 | |
| k | Wet/Dry | Dry, 1 : 99... 99 : 1, Wet | Sets the balance between the effect and the dry input | D-mod |
| | Src | Off...Tempo | Selects a modulation source for Wet/Dry | |
| l | Amt | -100...+100 | Sets the modulation amount for Wet/Dry | |

- c: Voice Top**
- d: Voice Center**
- e: Voice Bottom**

These parameters assign vowels to the top, center, and bottom position of the controller.

E.g.: When "Voice Top"=A, "Voice Center"=I, and "Voice Bottom"=U:

If **Sweep Mode** is set to D-mod is selected as the modulation source, moving your finger from the right to left of will change the sound from "a" to "i," then "u."

If Sweep Mode is set to LFO, the sound will change cyclically from "a" to "i," "u," "i," then "a."

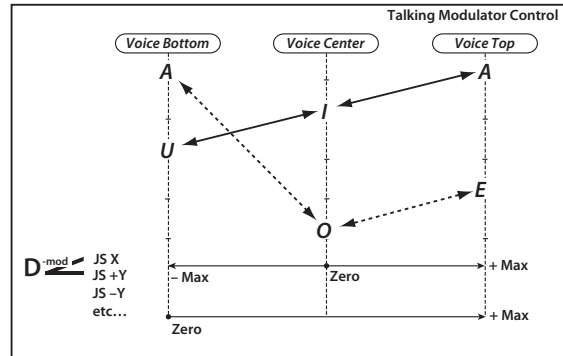

f: Formant Shift

This parameter adjusts the frequency level to which the effect is applied. If you wish to apply the effect to a higher-range sound, set this parameter to a higher value; to apply the effect to a lower-range sound, set this to a lower value.

f: Resonance

This parameter sets the intensity of resonance for the voice pattern. A larger value will add more character to the sound.

018: Stereo Decimator

This effect creates a rough sound like a cheap sampler by lowering the sampling frequency and data bit length. You can also simulate noise unique to a sampler (aliasing).

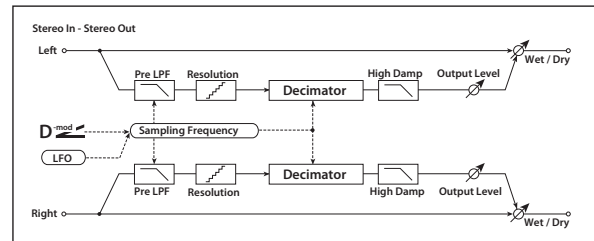

| | | | | |
|---|-------------------------|----------------------|---|--------|
| a | Pre LPF | Off, On | Selects whether the harmonic noise caused by a decrease in sampling frequency is generated or not p.262 | |
| | High Damp [%] | 0...100 | Sets the ratio of cut of the high range | |
| b | Sampling Frequency [Hz] | 1.00k...48.00k | Sets the sampling frequency | D-mod |
| | Src | Off...Tempo | Selects the modulation source of the sampling frequency | |
| c | Amt | -48.00k...+48.00k | Sets the modulation amount of the sampling frequency | |
| | LFO Frequency [Hz] | 0.02...20.00 | Sets the speed of the LFO | D-mod |
| d | Src | Off...Tempo | Selects a modulation source for LFO speed | |
| | Amt | -20.00...+20.00 | Sets the modulation amount of LFO speed | |
| e | MIDI Sync | Off, On | When this is on, the LFO speed is set by BPM, Base Note, and Times, instead of Frequency | AESync |
| | BPM | MIDI, 40.00...300.00 | MIDI syncs to the system tempo; 40-300 sets the tempo manually for this individual effect | |
| | Base Note | | Selects the type of notes that specify the LFO speed | |
| f | Times | x1...x32 | Selects the number of notes that specify the LFO speed | |

| | | | | |
|---|-------------------------|------------------------------|---|--|
| e | LFO Type | Individual, Common1, Common2 | Selects either (individual) LFO, Common FX LFO1, or Common LFO2 p.257 | |
| | Common LFO Offset [deg] | -180...+180 | Sets the phase offset when Type = Common 1 or Common 2 p.257 | |
| f | Depth | 0...100 | Sets the depth of the sampling frequency LFO modulation | |
| | Src | Off...Tempo | Selects the LFO modulation source of the sampling frequency | |
| | Amt | -100...+100 | Sets the LFO modulation amount of the sampling frequency | |
| g | Resolution | 4...24 | Sets the data bit length p.262 | |
| h | Output Level | 0...100 | Sets the output level p.262 | |
| | Src | Off...Tempo | Selects the modulation source for the output level | |
| | Amt | -100...+100 | Sets the modulation amount of the output level | |
| i | Wet/Dry | Dry, 1 : 99... 99 : 1, Wet | Sets the balance between the effect and the dry input | |
| | Src | Off...Tempo | Selects a modulation source for Wet/Dry | |
| | Amt | -100...+100 | Sets the modulation amount for Wet/Dry | |

a: Pre LPF

If a sampler with a very low sampling frequency receives very high-pitched sound that could not be heard during playback, it could generate pitch noise that is unrelated to the original sound. Set **Pre LPF** to On to prevent this noise from being generated.

If you set the **Sampling Frequency** to about 3 kHz and set **Pre LPF** to Off, you can create a sound like a ring modulator.

g: Resolution

h: Output Level

If you set a smaller value for the **Resolution** parameter, the sound may be distorted. The volume level may also be changed. Use **Output Level** to adjust the level.

019: St. Analog Record (Stereo Analog Record)

This effect simulates the noise caused by scratches and dust on analog records. It also reproduces some of the modulation caused by a warped turntable.

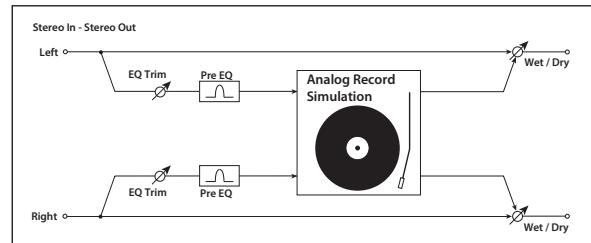

| | | | | |
|---|--------------------|----------------------------|---|--|
| a | Speed [RPM] | 33 1/3, 45, 78 | Sets the r.p.m. of a record | |
| b | Flutter | 0...100 | Sets the modulation depth p.262 | |
| c | Noise Density | 0...100 | Sets the noise density | |
| | Noise Tone | 0...100 | Sets the noise tone | |
| d | Noise Level | 0...100 | Sets the noise level | |
| | Src | Off...Tempo | Selects the modulation source for the noise level | |
| | Amt | -100...+100 | Sets the modulation amount of the noise level | |
| e | Click Level | 0...100 | Sets the click noise level p.262 | |
| | Src | Off...Tempo | Selects the modulation source for the click noise level | |
| | Amt | -100...+100 | Sets the modulation amount of the click noise level | |
| f | EQ Trim | 0...100 | Sets the EQ input level | |
| g | Pre EQ Cutoff [Hz] | 300...10.00k | Sets the EQ center frequency | |
| | Q | 0.5...10.0 | Sets the EQ band width | |
| | Gain [dB] | -18.0...+18.0 | Sets the EQ gain | |
| h | Wet/Dry | Dry, 1 : 99... 99 : 1, Wet | Sets the balance between the effect and the dry input | |
| | Src | Off...Tempo | Selects a modulation source for Wet/Dry | |
| | Amt | -100...+100 | Sets the modulation amount for Wet/Dry | |

b: Flutter

This parameter enables you to set the depth of the modulation caused by a warped turntable.

e: Click Level

This parameter enables you to set the level of the click noise that occurs once every rotation of the turntable. This simulation reproduces record noise, and the noise generated after the music on a vinyl record finishes.

Overdrive, Amp models, and Mic models (OD Amp Mic)

020: OD/Hi.Gain Wah (Overdrive/Hi.Gain Wah)

This distortion effect utilizes an Overdrive mode and a Hi-Gain mode. Controlling the wah effect, the 3-band EQ, and the amp simulation will allow you to create versatile distortion sounds. This effect is suitable for guitar and organ sounds.

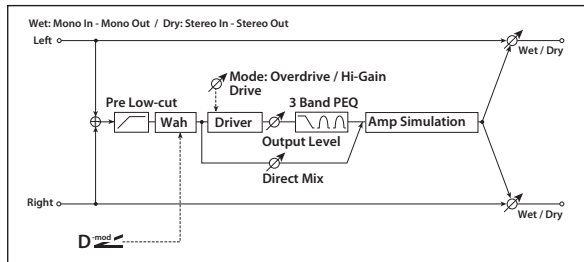

| | | | | |
|---|--------------------|----------------------------|---|--|
| a | Wah | Off, On | Switches Wah on/off p.263 | |
| | Src | Off...Tempo | Selects the modulation source that switches the Wah on and off | |
| b | Sw | Toggle, Moment | Selects the switching mode for the modulation source that switches the Wah on and off p.263 | |
| | Wah Sweep Range | -10...+10 | Sets the range of Wah p.263 | |
| c | Wah Sweep Src | Off...Tempo | Selects the modulation source that controls the Wah p.263 | |
| | Drive Mode | Overdrive, Hi-Gain | Switches between overdrive and hi-gain distortion | |
| d | Drive | 1...100 | Sets the degree of distortion p.263 | |
| | Pre Low-cut | 0...10 | Sets the low range cut amount of the distortion input p.263 | |
| e | Output Level | 0...50 | Sets the output level p.263 | |
| | Src | Off...Tempo | Selects the modulation source for the output level | |
| | Amt | -50...+50 | Sets the modulation amount of the output level | |
| f | Low Cutoff [Hz] | 20...1.00k | Sets the center frequency for Low EQ (shelving type) | |
| | Gain [dB] | -18...+18 | Sets the gain of Low EQ | |
| g | Mid1 Cutoff [Hz] | 300...10.00k | Sets the center frequency for Mid/High EQ 1 (peaking type) | |
| | Q | 0.5...10.0 | Sets the band width of Mid/High EQ 1 p.255 | |
| | Gain [dB] | -18...+18 | Sets the gain of Mid/High EQ 1 | |
| h | Mid2 Cutoff [Hz] | 500...20.00k | Sets the center frequency for Mid/High EQ 2 (peaking type) | |
| | Q | 0.5...10.0 | Sets the band width of Mid/High EQ 2 p.255 | |
| | Gain [dB] | -18...+18 | Sets the gain of Mid/High EQ 2 | |
| i | Direct Mix | 0...50 | Sets the amount of the dry sound mixed to the distortion | |
| | Speaker Simulation | Off, On | Switches the speaker simulation on/off | |
| j | Wet/Dry | Dry, 1 : 99... 99 : 1, Wet | Sets the balance between the effect and the dry input | |
| | Src | Off...Tempo | Selects a modulation source for Wet/Dry | |
| | Amt | -100...+100 | Sets the modulation amount for Wet/Dry | |

a: Wah

The Wah parameter switches the wah effect on/off.

a: Sw

This parameter sets how the wah effect is switched on and off via the modulation source.

When **Sw** = Moment, the wah effect is usually turned off. It is turned on only when you press the pedal or operate the joystick.

When a value for the modulation source is less than 64, “off” speed is selected, and when the value is 64 or higher, “on” is selected.

When **Sw** = Toggle, the wah effect is switched between on and off each time you press the pedal or operate the joystick.

The switch will be turned on/off each time the value of the modulation source exceeds 64.

b: Wah Sweep Range

b: Wah Sweep Src

This parameter sets the sweep range of the wah center frequency. A negative value will reverse the direction of sweep. The wah center frequency can be controlled by the modulation source specified in the **Wah Sweep Src** parameter.

d: Pre Low-cut

Cutting the signal in the low range before it is input to the Distortion will create a sharp distortion.

d: Drive

e: Output Level (Level)

The degree of distortion is determined by the level of input signal and the setting of **Drive**. Raising the **Drive** setting will cause the entire volume level to increase. Use the **Output Level** parameter to adjust the volume level. The **Output Level** parameter uses the signal level input to the 3-Band EQ. If clipping occurs at the 3-Band EQ, adjust the **Output Level** parameter.

021: St. Guitar Cabinet (Stereo Guitar Cabinet)

This simulates the acoustical character of a guitar amp's speaker cabinet.

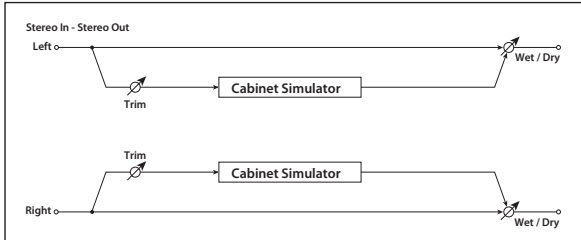

| a | Trim | 0...100 | Sets the input level | |
|---------------|--|-------------------------------|--|--|
| b | Type | | Selects the type of the cabinet | |
| | | TWEED - 1x12 | Open-back cabinet with one 12" speaker, typically used for blues | |
| | | TWEED - 4x10 | Open-back cabinet with four 10" speakers | |
| | | BLACK - 2x10 | Open-back cabinet with two 10" speakers | |
| | | BLACK - 2x12 | American open-back cabinet with two 12" speakers | |
| | | VOX AC15 - 1x12 | Vox AC15 open-back cabinet with one 12" "Blue" speaker | |
| | | VOX AC30 - 2x12 | Vox AC30 open-back cabinet with two 12" "Blue" speakers | |
| | | VOX AD412 - 4x12 | VOX AD412 closed-back cabinet with four 12" speakers | |
| | | UK H30 - 4x12 | Closed-back classic cabinet with four 30W 12" speakers | |
| | | UK T75 - 4x12 | Closed-back cabinet with four 75W 12" speakers | |
| US V30 - 4x12 | Closed-back cabinet with four 30W 12" speakers | | | |
| c | Air | 0...100 | Sets the mic position | |
| d | Wet/Dry | Dry, 1 : 99... 99 : 1, Wet | Sets the balance between the effect and the dry input | |
| | Src | Off...Tempo | Selects a modulation source for Wet/Dry | |
| | Amt | -100...+100 | Sets the modulation amount for Wet/Dry | |

022: St. Bass Cabinet (Stereo Bass Cabinet)

This simulates the acoustical character of a bass amp's speaker cabinet.

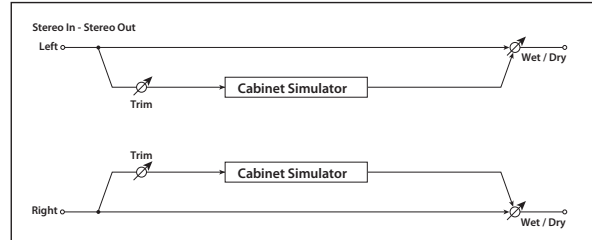

| a | Trim | 0...100 | Sets the input level | | | |
|-----|--------------|---------------------|--|-------------------------------|---|--|
| b | Cabinet Type | | Selects the cabinet type | | | |
| | | LA - 4x10 | Four 10" speakers / LA sound cabinet | | | |
| | | MODERN - 4x10 | Four 10" aluminum-cone speakers / modern cabinet | | | |
| | | METAL - 4x10 | Four 10" aluminum-cone speakers / modern cabinet | | | |
| | | CLASSIC - 8x10 | Eight 10" speakers / classic cabinet | | | |
| | | UK - 4x12 | Four 12" speakers / UK-manufactured cabinet | | | |
| | | STUDIO - 1x15 | One 15" speaker / studio combo cabinet | | | |
| | | JAZZ - 1x15 | One 15" speaker / jazz combo cabinet | | | |
| | | VOX AC100 - 2x15 | Two 15" speakers / cabinet for Vox AC100 | | | |
| | | US - 2x15 | Two 15" speakers / US-manufactured cabinet | | | |
| | | UK - 4x15 | Four 15" speakers / UK-manufactured cabinet | | | |
| | | LA - 1x18 | One 18" speaker / LA sound cabinet | | | |
| | | COMBI - 1x12 & 1x18 | One 12" and one 18" speaker combination cabinet | | | |
| | | c | Wet/Dry | Dry, 1 : 99... 99 : 1, Wet | Sets the balance between the effect and the dry input | |
| | | d | Src | Off...Tempo | Selects a modulation source for Wet/Dry | |
| Amt | -100...+100 | | Sets the modulation amount for Wet/Dry | | | |

023: Bass Amp Model

This simulates a bass amp.

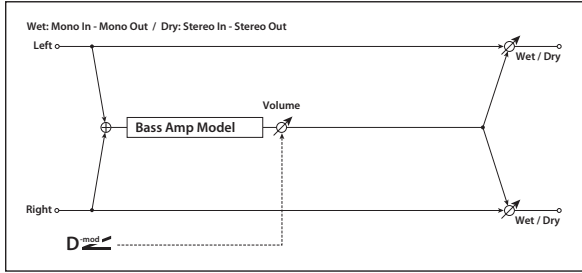

| | | | | |
|---|----------------|-------------------------------|--|-------|
| a | Amplifier Type | LA STUDIO | Selects the amplifier type An amp that is typical of the LA sound. | D-mod |
| | | JAZZ COMBO | A combo amp favored by jazz bassists. | |
| | | GOLD PANEL | An amp distinctive for its eye-catching gold panel and clean sound. | |
| | | SCOOPED | An amp typical of 80's sounds. | |
| | | VALVE2 | A tube amp suitable for rock. | |
| | | VALVE | A tube amp with the ULTRA LO switch turned ON. | |
| | | CLASSIC | A tube amp whose basic character changes according to the setting of the value dial. | |
| b | Volume | 0...100 | Sets the output level | D-mod |
| | Src | Off...Tempo | Selects the modulation source for the output level | |
| | Amt | -100...+100 | Sets the modulation amount of the output level | |
| c | Bass | 0...100 | Sets the bass (low range) level | |
| d | Middle | 0...100 | Sets the middle (mid range) level | |
| | Mid Range | 0...4 | Sets the mid-frequency range | |
| e | Treble | 0...100 | Sets the treble (high range) level | |
| f | Presence | 0...100 | Sets the presence (high-frequency tone) | |
| g | Wet/Dry | Dry, 1 : 99... 99 : 1, Wet | Sets the balance between the effect and the dry input | D-mod |
| | Src | Off...Tempo | Selects a modulation source for Wet/Dry | |
| | Amt | -100...+100 | Sets the modulation amount for Wet/Dry | |

024: Bass Amp+Cabinet (Bass Amp Model+Cabinet)

This simulates a bass amp and speaker cabinet.

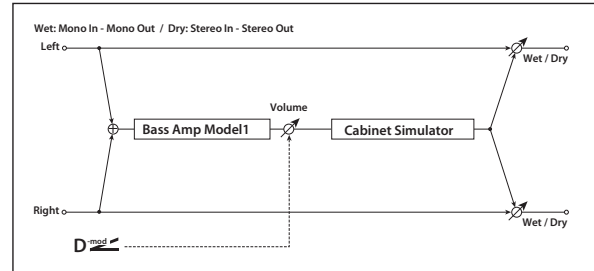

| | | | | | |
|---|-------------------|---|--|---|-------|
| a | Amplifier Type | LA STUDIO, JAZZ COMBO, GOLD PANEL, SCOOPED, VALVE2, VALVE, CLASSIC | Selects the type of the amplifier p.265 | | |
| b | Volume | 0...100 | Sets the output level | D-mod | |
| | Src | Off...Tempo | Selects the modulation source for the output level | | |
| | Amt | -100...+100 | Sets the modulation amount of the output level | | |
| c | Bass | 0...100 | Sets the bass (low range) level | | |
| d | Middle | 0...100 | Sets the middle (mid range) level | | |
| | Mid Range | 0...4 | Sets the mid-frequency range | | |
| e | Treble | 0...100 | Sets the treble (high range) level | | |
| f | Presence | 0...100 | Sets the presence (high-frequency tone) | | |
| g | Cabinet Simulator | Off, On | Switches the cabinet simulator on/off | | |
| h | Cabinet Type | LA - 4x10, MODERN - 4x10, METAL - 4x10, CLASSIC - 8x10, UK - 4x12, STUDIO - 1x15, JAZZ - 1x15, VOX AC100 - 2x15, US - 2x15, UK - 4x15, LA - 1x18, COMBI - 1x12 & 1x18 | Selects the cabinet type p.264 | | |
| | | Wet/Dry | Dry, 1 : 99... 99 : 1, Wet | Sets the balance between the effect and the dry input | D-mod |
| | | Src | Off...Tempo | Selects a modulation source for Wet/Dry | |
| | Amt | -100...+100 | Sets the modulation amount for Wet/Dry | | |

a: Amplifier Type

h: Cabinet Type

Recommended Combinations of Bass Amp Models and Cabinets:

| Amplifier Type | Cabinet Type |
|----------------|----------------------|
| LA STUDIO | LA - 4x10, LA - 1x18 |
| JAZZ COMBO | JAZZ - 1x15 |
| GOLD PANEL | MODERN - 4x10 |
| SCOOPED | METAL - 4x10 |
| VALVE2 | CLASSIC - 8x10 |
| VALVE | CLASSIC - 8x10 |
| CLASSIC | COMBI - 1x12 & 1x18 |

Note: It is convenient to use the Effect Preset function to preset your favorite pairings of amp model and cabinet. (see p.60)

025: TrebleBST (Treble Booster)

This effect models a famous boost/overdrive effect that was developed in order to produce a “guitar orchestra” effect, and designed for use with the VOX AC30. You can use this to add clear boost to the signal, or apply it to an organ sound to add an overdrive that generates rich overtones. Three controls allow a broad range of settings, letting you create a wide variety of overdrive sounds.

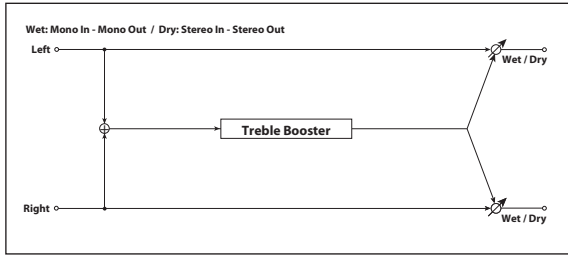

| | | | | |
|---|---------|-------------------------|---|--|
| a | Drive | 1...100 | Sets the gain for overdrive p.263 | |
| b | Level | 0...100 | Sets the output level p.263 | |
| c | Tone | 1...100 | Sets the tone for overdrive | |
| b | Wet/Dry | Dry, 1:99 ... 99:1, Wet | Sets the balance between the effect and the dry input | |
| | Src | Off...Tempo | Selects a modulation source for Wet/Dry | |
| | Amt | -100...+100 | Sets the modulation amount for Wet/Dry | |

026: Tube PreAmp Model (Tube PreAmp Modeling)

This effect simulates a two-stage vacuum tube preamp. You can make individual settings for two vacuum tubes connected in series. This lets you create the warm sound typical of vacuum tubes.

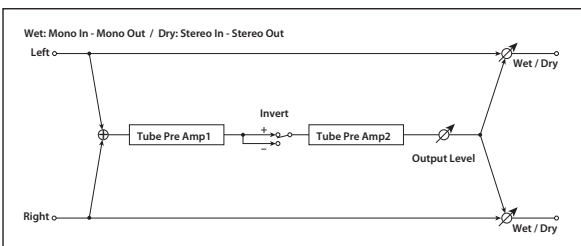

| | | | | |
|---|--------------------|--------------------|--|--|
| a | Tube1 Low Cut [Hz] | Thru, 21...8.00k | Sets the cutoff frequency for the low cut filter of stage 1 | |
| | High Cut [Hz] | 53...20.00k, Thru | Sets the cutoff frequency for the high cut filter of stage 1 | |
| b | Tube1 Gain [dB] | -24.0...+24.0 | Sets the input gain for stage 1 | |
| | Saturation [%] | 0...100 | Sets the input/output response for stage 1 p.266 | |
| c | Tube1 Bias | 0...100 | Sets the bias voltage for stage 1 p.266 | |
| d | Tube1 Phase | Normal, Wet Invert | Turns phase reversal on/off p.266 | |
| e | Tube2 Low Cut [Hz] | Thru, 21...8.00k | Sets the cutoff frequency for the low cut filter of stage 2 | |
| | High Cut [Hz] | 53...20.00k, Thru | Sets the cutoff frequency for the high cut filter of stage 2 | |
| f | Tube2 Gain [dB] | -24.0...+24.0 | Sets the input gain for stage 2 | |
| | Saturation [%] | 0...100 | Sets the input/output response for stage 2 p.266 | |

| | | | | |
|---|-------------------------|----------------------------|---|--|
| g | Tube2 Bias | 0...100 | Sets the bias voltage for stage 2 p.266 | |
| h | Tube2 Output Level [dB] | -48.0...+0.0 | Sets the output level | |
| i | Wet/Dry | Dry, 1 : 99... 99 : 1, Wet | Sets the balance between the effect and the dry input | |
| | Src | Off...Tempo | Selects a modulation source for Wet/Dry | |
| | Amt | -100...+100 | Sets the modulation amount for Wet/Dry | |

b, f: Saturation [%]

With higher settings of this value, the waveform will change at high gain levels, tending to cause distortion. Lower settings of this value will produce linear response.

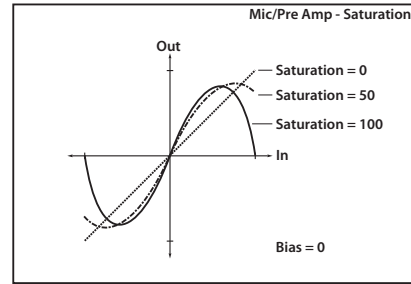

c: Tube1 Bias

This expresses the effect that changes in vacuum tube bias have on the distortion of the waveform. Higher settings of this value will produce distortion even at low gain levels. Since this will also change the overtone structure, you can use it to control the tonal character.

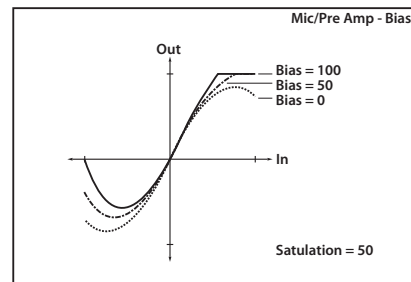

d: Tube1 Phase

With the Wet Invert setting, the phase of the signal will be inverted between stage 1 and stage 2. Since “Bias” is applied to the inverted signal in stage 2, this will change the tonal character.

027: St. Tube PreAmp (Stereo Tube PreAmp Modeling)

This is a stereo vacuum tube preamp simulator (See “026: Tube PreAmp Model (Tube PreAmp Modeling)” on page 266.).

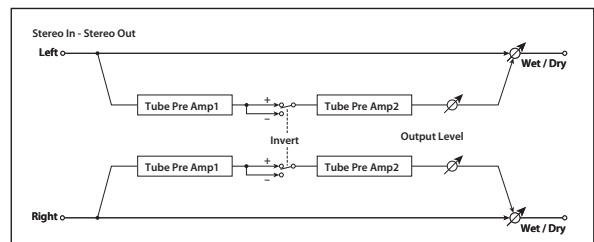

028: Mic Model+PreAmp (Mic Modeling + PreAmp)

This effect simulates a mic and vacuum tube preamp. You can choose from various types of mic and positions to create differing sonic characters.

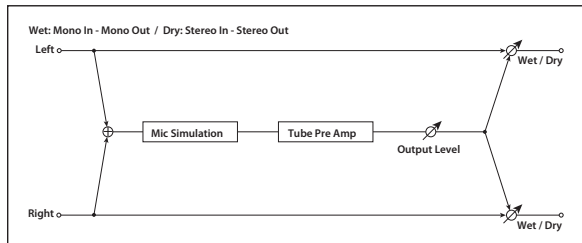

| | | | | |
|---|------------------------|--|---|--|
| a | Mic Type | Vintage Dynamic, Multi Condenser, Percussion Condenser, Drums Dynamic, Vocal Dynamic, Multi Dynamic, Vocal Condenser, Vocal Tube, Kick Dynamic | Selects the type of mic | |
| b | Mic Position | Close, On, Off, Far | Sets the mic placement distance p.267 | |
| c | Tube Low Cut [Hz] | Thru, 21...8.00k | Sets the frequency of the low cut filter | |
| | High Cut [Hz] | 53...20.00k, Thru | Sets the frequency of the high cut filter | |
| d | Tube Gain [dB] | -24.0...+24.0 | Sets the input gain to the vacuum tube preamp | |
| | Saturation [%] | 0...100 | Sets the input/output response of the preamp p.266 | |
| e | Tube Bias | 0...100 | Sets the bias level of the preamp p.266 | |
| f | Tube Output Level [dB] | -48.0...+0.0 | Sets the output level of the preamp | |
| g | Wet/Dry | Dry, 1 : 99... 99 : 1, Wet | Sets the balance between the effect and the dry input | |
| | Src | Off...Tempo | Selects a modulation source for Wet/Dry | |
| | Amt | -100...+100 | Sets the modulation amount for Wet/Dry | |

b: Mic Position

This expresses the effect that the mic position has on the sound. The Close setting is the closest mic position, and the Far setting is the farthest.

Chorus, Flanger, and Phaser (Cho/Fln Phaser)

029: Stereo Chorus

This effect adds thickness and warmth to the sound by modulating the delay time of the input signal. You can add spread to the sound by offsetting the phase of the left and right LFOs from each other.

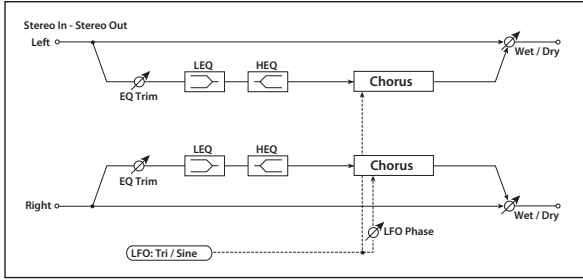

| | | | | |
|---|-------------------------|-----------------------------------|---|-------|
| a | LFO Waveform | Triangle, Sine | Selects the LFO Waveform | |
| | LFO Phase [degree] | -180...+180 | Sets the LFO phase difference between the left and right | p.259 |
| b | LFO Frequency [Hz] | 0.02...20.00 | Sets the speed of the LFO | p.259 |
| | Src | Off...Tempo | Selects a modulation source for LFO speed | |
| c | Amt | -20.00...+20.00 | Sets the modulation amount of LFO speed | |
| | MIDI Sync | Off, On | When this is on, the LFO speed is set by BPM, Base Note, and Times, instead of Frequency | p.257 |
| | BPM | MIDI, 40.00...300.00 | MIDI syncs to the system tempo; 40-300 sets the tempo manually for this individual effect | p.257 |
| | Base Note | | Selects the type of notes that specify the LFO speed | p.257 |
| d | Times | x1...x32 | Sets the number of notes that specify the LFO speed | p.257 |
| | LFO Type | Individual, Common1, Common2 | Selects either (individual) LFO, Common FX LFO1, or Common LFO2 | p.257 |
| e | Common LFO Offset [deg] | -180...+180 | Sets the phase offset when Type = Common 1 or Common 2 | p.257 |
| | L Pre Delay [msec] | 0.0...50.0 | Sets the delay time for the left channel | p.268 |
| f | R Pre Delay [msec] | 0.0...50.0 | Sets the delay time for the right channel | p.268 |
| | Depth | 0...100 | Sets the depth of LFO modulation | |
| g | Src | Off...Tempo | Selects the modulation source for the LFO modulation depth | |
| | Amt | -100...+100 | Sets the modulation amount of the LFO modulation depth | |
| h | EQ Trim | 0...100 | Sets the EQ input level | |
| | Pre LEQ Fc | Low, Mid-Low | Selects the cutoff frequency (low or mid-low) of the low-range equalizer | |
| i | Pre HEQ Fc | High, Mid-High | Selects the cutoff frequency (high or mid-high) of the high-range equalizer | |
| | Pre LEQ Gain [dB] | -15.0...+15.0 | Sets the gain of the Low EQ | |
| j | Pre HEQ Gain [dB] | -15.0...+15.0 | Sets the gain of the High EQ | |
| | Wet/Dry | -Wet...-1 : 99, Dry, 1 : 99...Wet | Sets the balance between the effect and the dry input | p.259 |
| | Src | Off...Tempo | Selects a modulation source for Wet/Dry | |
| k | Amt | -100...+100 | Sets the modulation amount for Wet/Dry | |

e: L Pre Delay [msec]

e: R Pre Delay [msec]

Setting the left and right delay time individually allows you to control the stereo image.

030: Vintage Chorus

This models a famous chorus unit that was built into a guitar amp. Although it does not provide a chorus and vibrato select switch, you can use the **Wet/Dry** setting to produce their effect. The **Speed**, **Depth**, and **Manual** parameters allow an even wider range of sounds than the original unit.

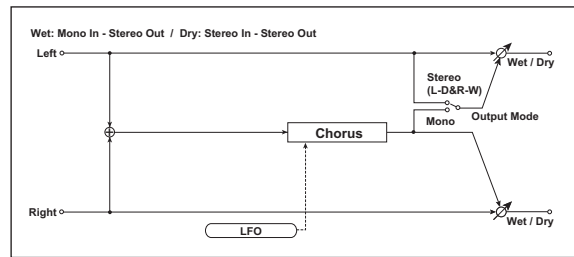

| | | | | |
|---|-------------|--------------------------|---|--|
| a | Speed [Hz] | 0.10...10.0 | Sets the speed of LFO | |
| | Src | Off...Tempo | Selects a modulation source for Speed [Hz] | |
| | Amt | -100...+100 | Sets the modulation amount for Speed [Hz] | |
| b | Depth | 0...100 | Sets the modulation depth | |
| | Src | Off...Tempo | Selects a modulation source for Depth | |
| | Amt | -100...+100 | Sets the modulation amount for Depth | |
| c | Manual | 1...100 | Sets the sweep frequency | |
| d | Output Mode | 0: Mono, 1: ST (L-D&R-W) | Sets the output mode | |
| e | Wet/Dry | Dry, 1:99 ... 99:1, Wet | Sets the balance between the effect and the dry input | |
| | Src | Off...Tempo | Selects a modulation source for Wet/Dry | |
| | Amt | -100 ... +100 | Sets the modulation amount for Wet/Dry | |

e: Wet/Dry

d: Output Mode

For the master effects, **Wet/Dry** adjusts the output level of the effect sound.

When **Output Mode** is Mono, L and R will output the same vibrato effect. Normally, you'll use the **Wet/Dry** setting to mix the direct sound and processed sound so that a chorus effect is produced. If you set this to Wet so that none of the direct sound is included, you'll obtain a vibrato effect.

If **Output Mode** is ST (L-D&R-W), the direct sound will be panned to L, and the effect sound will be panned to R for output. Normally, you'll use the **Wet/Dry** setting to mix the direct sound and processed sound, producing a chorus effect on only the R-channel, and creating a spacious stereo effect that extends to the left and right. If you set this to Wet, and pan the direct and processed sounds to left and right, and then output them to stereo speakers, the direct sound and processed sound will be mixed in the air, producing a chorus effect with spacious clarity.

031: Black Chorus

This models a Danish-made stereo chorus + pitch modulator & flanger. Although this effect was originally intended for guitar, it was also used by numerous keyboard players. Used with electric piano, it produces a distinctive tone.

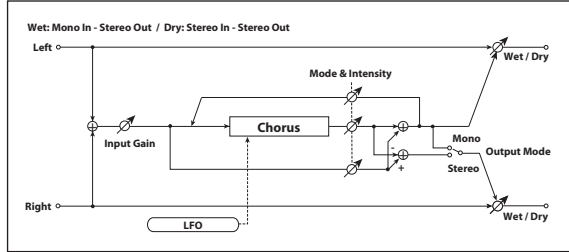

| | | | | |
|---|-------------|-------------------------|---|--|
| a | Speed [Hz] | 0.10...10.0 | Sets the LFO speed | |
| | Src | Off...Tempo | Selects a modulation source for Speed [Hz] | |
| | Amt | -100...+100 | Sets the modulation amount for Speed [Hz] | |
| b | Intensity | 1...100 | Sets the intensity of LFO modulation | |
| c | Mode | 0, 1, 2 | Select a mode 0: Chorus 1: Pitch Modulation 2: Flanger | |
| d | Width | 0...100 | Sets the LFO modulation depth | |
| e | Input Gain | 1...100 | Sets the input gain | |
| f | Output Mode | 0, 1 | Select a output mode 0: Mono 1: Stereo | |
| g | Wet/Dry | Dry, 1:99 ... 99:1, Wet | Sets the balance between the effect and the dry input | |
| | Src | Off...Tempo | Selects a modulation source for Wet/Dry | |
| | Amt | -100 ... +100 | Sets the modulation amount for Wet/Dry | |

c: Mode

b: Intensity

Increasing the **Intensity** value will strengthen the modulation effect. This controls the effect, direct, and feedback values. The values that are controlled will depend on the **Mode** setting.

032: EP Chorus

This is inspired by a rare chorus built into an early version of a famous modified tine piano.

| | | | | |
|---|------------|-------------------------|---|-------|
| a | Speed [Hz] | 0.10...10.0 | Sets the LFO speed | p.259 |
| | Src | Off...Tempo | Selects a modulation source for Speed [Hz] | |
| | Amt | -100...+100 | Sets the modulation amount for Speed [Hz] | |
| b | Depth | 0...100 | Sets the depth of LFO modulation | |
| | Src | Off...Tempo | Selects the modulation source of the LFO modulation depth | |
| | Amt | -100...+100 | Sets the modulation amount of the LFO modulation depth | |
| c | Wet/Dry | Dry, 1:99 ... 99:1, Wet | Sets the balance between the effect and the dry input | |
| | Src | Off...Tempo | Selects a modulation source for Wet/Dry | |
| | Amt | -100...+100 | Sets the modulation amount for Wet/Dry | |

033: St.HarmonicChorus (Stereo Harmonic Chorus)

This effect applies chorus only to higher frequencies. This can be used to apply a chorus effect to a bass sound without making the sound thinner. You can also use this chorus block with feedback as a flanger.

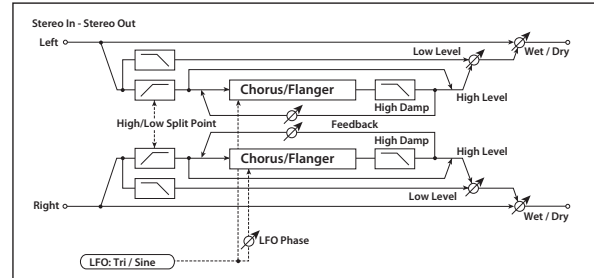

| | | | | |
|---|-------------------------|------------------------------|---|-------|
| a | LFO Waveform | Triangle, Sine | Selects the LFO Waveform | |
| | LFO Phase [degree] | -180...+180 | Sets the LFO phase difference between the left and right | p.259 |
| b | LFO Frequency [Hz] | 0.02...20.00 | Sets the speed of the LFO | p.259 |
| | Src | Off...Tempo | Selects a modulation source for LFO speed | |
| | Amt | -20.00... +20.00 | Sets the modulation amount of LFO speed | |
| c | MIDI Sync | Off, On | When this is on, the LFO speed is set by BPM, Base Note, and Times, instead of Frequency | p.257 |
| | BPM | MIDI, 40.00... 300.00 | MIDI syncs to the system tempo; 40-300 sets the tempo manually for this individual effect | p.257 |
| | Base Note | | Selects the type of notes that specify the LFO speed | p.257 |
| | Times | x1...x32 | Sets the number of notes that specify the LFO speed | p.257 |
| d | LFO Type | Individual, Common1, Common2 | Selects either (individual) LFO, Common FX LFO1, or Common LFO2 | p.257 |
| | Common LFO Offset [deg] | -180...+180 | Sets the phase offset when Type = Common 1 or Common 2 | p.257 |
| e | Pre Delay [msec] | 0.0...50.0 | Sets the delay time from the original sound | |
| f | Depth | 0...100 | Sets the depth of LFO modulation | |
| | Src | Off...Tempo | Selects the modulation source of the LFO modulation depth | |
| g | Amt | -100...+100 | Sets the modulation amount of the LFO modulation depth | |
| | High/Low Split Point | 1...100 | Sets the frequency split point between the low and high range | p.269 |
| h | Feedback | -100...+100 | Sets the feed back amount of the chorus block | p.270 |
| | High Damp [%] | 0...100 | Sets the high range damping amount of the chorus block | |
| i | Low Level | 0...100 | Sets the low range output level | |
| | High Level | 0...100 | Sets the high range (chorus) output level | |
| j | Wet/Dry | Dry, 1 : 99... 99 : 1, Wet | Sets the balance between the effect and the dry input | |
| | Src | Off...Tempo | Selects a modulation source for Wet/Dry | |
| | Amt | -100...+100 | Sets the modulation amount for Wet/Dry | |

g: High/Low Split Point

This parameter sets the frequency that splits the high and low range. Only the high range will be sent to the chorus block.

h: Feedback

Sets the feedback amount of the chorus block. Increasing the feedback will allow you to use the effect as a flanger.

034: St. Biphase Mod. (Stereo Biphase Modulation)

This stereo chorus effect adds two different LFOs together. You can set the Frequency and Depth parameters for each LFO individually. Depending on the setting of these LFOs, very complex waveforms will create an analog-type, unstable modulated sound.

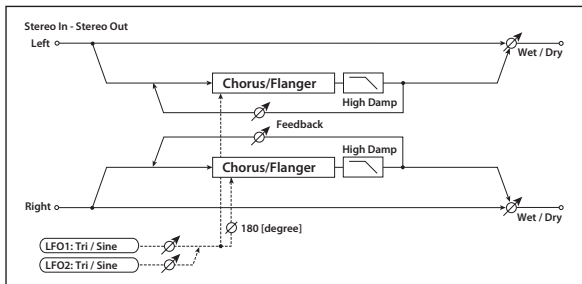

| | | | | |
|---|-------------------------|------------------------------|---|-------|
| a | LFO1 Waveform | Triangle, Sine | Selects LFO1 waveform | |
| | LFO2 Waveform | Triangle, Sine | Selects LFO2 waveform | |
| | Phase Sw | 0 deg, 180 deg | Switches the LFO phase difference between left and right | |
| b | LFO1 Frequency [Hz] | 0.02...30.00 | Sets the LFO1 speed | |
| | Src | Off...Tempo | Selects the modulation source of LFO1&2 speed | |
| | LFO1 Amt | -30.00...+30.00 | Sets the modulation amount of LFO1 speed | |
| c | LFO2 Frequency [Hz] | 0.02...30.00 | Sets the LFO2 speed | |
| | Amt | -30.00...+30.00 | Sets the modulation amount of LFO2 speed | |
| d | LFO1 Type | Individual, Common1, Common2 | Selects either (individual) LFO, Common FX LFO1, or Common LFO2 | |
| | Common LFO Offset [deg] | -180...+180 | Sets the phase offset when LFO1 Type = Common 1 or Common 2 | p.257 |
| e | LFO2 Type | Individual, Common1, Common2 | Selects either (individual) LFO, Common FX LFO1, or Common LFO2 | |
| | Common LFO Offset [deg] | -180...+180 | Sets the phase offset when LFO2 Type = Common 1 or Common 2 | p.257 |
| f | Depth1 | 0...100 | Sets the depth of LFO1 modulation | |
| | Src | Off...Tempo | Selects the modulation source of LFO1&2 modulation depth | |
| | Amt | -100...+100 | Sets the modulation amount of LFO1 modulation depth | |
| g | Depth2 | 0...100 | Sets the depth of LFO2 modulation | |
| | Amt | -100...+100 | Sets the modulation amount of LFO2 modulation depth | |
| h | L Pre Delay [msec] | 0.0...50.0 | Sets the delay time for the left channel | p.268 |
| | R Pre Delay [msec] | 0.0...50.0 | Sets the delay time for the right channel | p.268 |
| i | Feedback | -100...+100 | Sets the feedback amount | p.270 |
| | High Damp [%] | 0...100 | Sets the damping amount in the high range | |

| | | | | |
|---|---------|-----------------------------------|---|-------|
| j | Wet/Dry | -Wet...-1 : 99, Dry, 1 : 99...Wet | Sets the balance between the effect and the dry input | p.259 |
| | Src | Off...Tempo | Selects a modulation source for Wet/Dry | |
| | Amt | -100...+100 | Sets the modulation amount for Wet/Dry | |

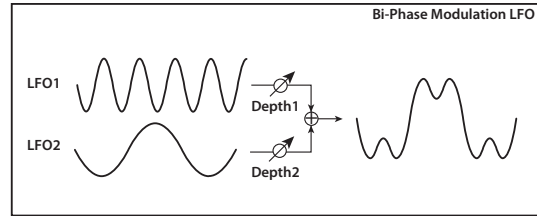

035: Multitap Cho/Delay (Multitap Chorus/Delay)

This effect has four chorus blocks with a different LFO phase. You can create a complex stereo image by setting each block's delay time, depth, output level, and pan individually. You can also fix some of the chorus blocks to combine the chorus and delay effects.

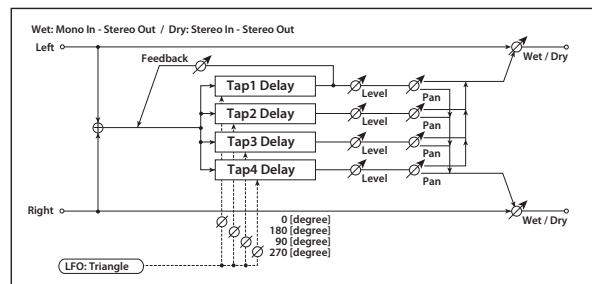

| | | | | |
|---|-------------------------|------------------------------|---|-------|
| a | LFO Frequency [Hz] | 0.02...13.00 | Sets the speed of the LFO | |
| b | LFO Type | Individual, Common1, Common2 | Selects either (individual) LFO, Common FX LFO1, or Common LFO2 | p.257 |
| | Common LFO Offset [deg] | -180...+180 | Sets the phase offset when Type = Common 1 or Common 2 | p.257 |
| c | Tap1 (000) [msec] | 0...1000 | Sets the Tap1 (LFO phase=0 degrees) delay time | |
| | Depth | 0...30 | Sets the Tap1 chorus depth | |
| | Level | 0...30 | Sets the Tap1 output level | |
| d | Pan | L6...L1, C, R1...R6 | Sets the Tap1 stereo image | |
| | Tap2 (180) [msec] | 0...1000 | Sets the Tap2 (LFO phase=180 degrees) delay time | |
| | Depth | 0...30 | Sets the Tap2 chorus depth | |
| e | Level | 0...30 | Sets the Tap2 output level | |
| | Pan | L6...L1, C, R1...R6 | Sets the Tap2 stereo image | |
| | Tap3 (090) [msec] | 0...1000 | Sets the Tap3 (LFO phase=90 degrees) delay time | |
| f | Depth | 0...30 | Sets the Tap3 chorus depth | |
| | Level | 0...30 | Sets the Tap3 output level | |
| | Pan | L6...L1, C, R1...R6 | Sets the Tap3 stereo image | |
| g | Tap4 (270) [msec] | 0...1000 | Sets the Tap4 (LFO phase=270 degrees) delay time | |
| | Depth | 0...30 | Sets the Tap4 chorus depth | |
| | Level | 0...30 | Sets the Tap4 output level | |
| h | Pan | L6...L1, C, R1...R6 | Sets the Tap4 stereo image | |

| | | | | |
|---|---------------|-------------------------------|--|-------|
| g | Tap1 Feedback | -100...+100 | Sets the Tap1 feedback amount | D-mod |
| | Src | Off...Tempo | Selects the modulation source of Tap1 feedback amount and effect balance | |
| | Amt | -100...+100 | Sets the Tap1 feedback amount and modulation amount | |
| j | Wet/Dry | Dry, 1 : 99... 99 : 1, Wet | Sets the balance between the effect and the dry input | D-mod |
| | Src | Off...Tempo | Selects a modulation source for Wet/Dry | |
| | Amt | -100...+100 | Sets the modulation amount for Wet/Dry | |

036: Ensemble

This Ensemble effect has three chorus blocks that use LFO to create subtle shimmering, and gives three dimensional depth and spread to the sound, because the signal is output from the left, right, and center.

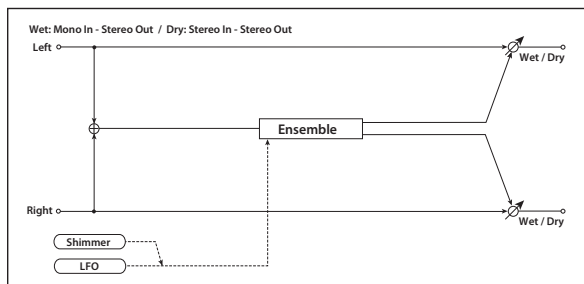

| | | | | |
|---|---------|-------------------------------|---|-------|
| a | Speed | 1...100 | Sets the speed of the LFO | D-mod |
| | Src | Off...Tempo | Selects a modulation source for LFO speed | |
| | Amt | -100...+100 | Sets the modulation amount of LFO speed | |
| b | Depth | 0...100 | Sets the depth of LFO modulation | D-mod |
| | Src | Off...Tempo | Selects the modulation source of the LFO modulation depth | |
| | Amt | -100...+100 | Sets the modulation amount of the LFO modulation depth | |
| c | Shimmer | 0...100 | Sets the amount of shimmering of the LFO waveform p.271 | |
| d | Wet/Dry | Dry, 1 : 99... 99 : 1, Wet | Sets the balance between the effect and the dry input | D-mod |
| | Src | Off...Tempo | Selects a modulation source for Wet/Dry | |
| | Amt | -100...+100 | Sets the modulation amount for Wet/Dry | |

c: Shimmer

This parameter sets the amount of shimmering of the LFO waveform. Increasing this value adds more shimmering, making the chorus effect more complex and richer.

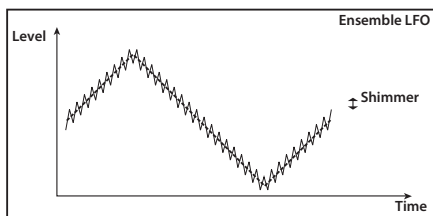

037: Polysix Ensemble

This models the ensemble effect built into the classic Korg PolySix programmable polyphonic synthesizer.

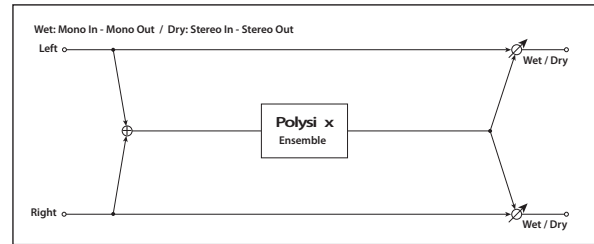

| | | | | |
|---|---------|-------------------------------|--|-------|
| a | Depth | 0...100 | Sets the depth of the effect | D-mod |
| | Src | Off...Tempo | Selects the modulation source that will control the effect depth | |
| | Amt | -100...+100 | Sets the amount by which the effect depth will be modulated | |
| b | Wet/Dry | Dry, 1 : 99... 99 : 1, Wet | Sets the balance between the effect and the dry input | D-mod |
| | Src | Off...Tempo | Selects a modulation source for Wet/Dry | |
| | Amt | -100...+100 | Sets the modulation amount for Wet/Dry | |

038: Stereo Flanger

This effect gives a significant swell and movement of pitch to the sound. It is more effective when applied to a sound with a lot of harmonics. This is a stereo flanger. You can add spread to the sound by offsetting the phase of the left and right LFOs from each other.

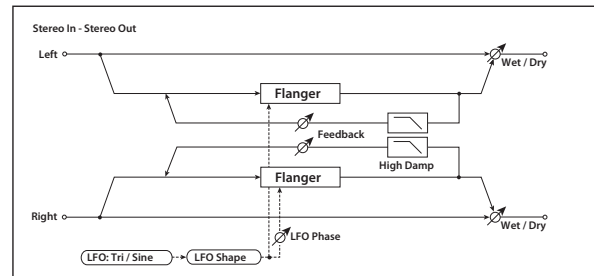

| | | | | |
|---|--------------------|-----------------------------|---|-------|
| a | Delay Time [msec] | 0.0...50.0 | Sets the delay time from the original sound | |
| b | LFO Waveform | Triangle, Sine | Selects the LFO Waveform | |
| | LFO Shape | -100...+100 | Changes the curvature of the LFO Waveform p.258 | |
| c | LFO Phase [degree] | -180...+180 | Sets the LFO phase difference between the left and right p.259 | |
| d | LFO Frequency [Hz] | 0.02...20.00 | Sets the speed of the LFO p.259 | D-mod |
| | Src | Off...Tempo | Selects a modulation source for LFO speed | |
| | Amt | -20.00... +20.00 | Sets the modulation amount of LFO speed | |
| e | MIDI Sync | Off, On | When this is on, the LFO speed is set by BPM, Base Note, and Times, instead of Frequency p.257 | MIDI |
| | BPM | MIDI, 40.00... 300.00 | MIDI syncs to the system tempo; 40-300 sets the tempo manually for this individual effect p.257 | |
| | Base Note | | Selects the type of notes that specify the LFO speed p.257 | |
| | Times | x1...x32 | Sets the number of notes that specify the LFO speed p.257 | |

| | | | | |
|---|-------------------------|-----------------------------------|---|--|
| f | LFO Type | Individual, Common1, Common2 | Selects either (individual) LFO, Common FX LFO1, or Common LFO2 p.257 | |
| | Common LFO Offset [deg] | -180...+180 | Sets the phase offset when Type = Common 1 or Common 2 p.257 | |
| g | Depth | 0...100 | Sets the depth of LFO modulation | |
| h | Feedback | -100...+100 | Sets the feedback amount p.272 | |
| | High Damp [%] | 0...100 | Sets the feedback damping amount in the high range p.272 | |
| i | Wet/Dry | -Wet...-1 : 99, Dry, 1 : 99...Wet | Sets the balance between the effect and the dry input p.259, p.272 | |
| | Src | Off...Tempo | Selects a modulation source for Wet/Dry | |
| | Amt | -100...+100 | Sets the modulation amount for Wet/Dry | |

h: Feedback

i: Wet/Dry

The peak shape of the positive and negative **Feedback** value is different. The harmonics will be emphasized when the effect sound is mixed with the dry sound if you set a positive value for both **Feedback** and **Wet/Dry**, and if you set a negative value for both **Feedback** and **Wet/Dry**.

h: High Damp [%]

This parameter sets the amount of damping of the feedback in the high range. Increasing the value will cut high-range harmonics.

039: Vintage Flanger

This models a classic analog flanger. It is highly effective for chording on clavi-type keyboards or electric piano.

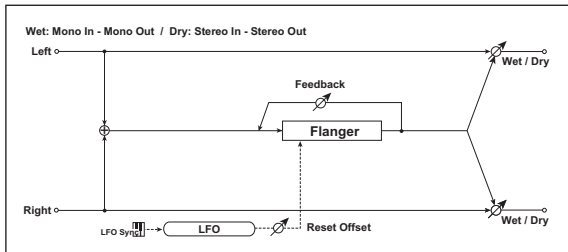

| | | | | |
|---|------------------|-----------------------------------|---|--|
| a | Speed [Hz] | 0.10...10.0 | Sets the speed of LFO | |
| | Src | Off...Tempo | Selects a modulation source for Speed [Hz] | |
| | Amt | -100...+100 | Sets the modulation amount for Speed [Hz] | |
| b | Depth | 0...100 | Sets the depth of LFO modulation | |
| | Src | Off...Tempo | Selects a modulation source for Depth | |
| | Amt | -100...+100 | Sets the modulation amount for Depth | |
| c | Resonance | 0...100 | Sets the resonance amount | |
| d | Manual | 1...100 | Sets the sweep frequency | |
| e | LFO Reset Source | Off...Tempo | Selects a modulation source for LFO reset | |
| f | Reset Offset | 0...100 | Sets the offset | |
| g | Wet/Dry | -Wet...-1 : 99, Dry, 1 : 99...Wet | Sets the balance between the effect and the dry input | |
| | Src | Off...Tempo | Selects a modulation source for Wet/Dry | |
| | Amt | -100...+100 | Sets the modulation amount for Wet/Dry | |

040: St. Random Flanger (Stereo Random Flanger)

The stereo effect uses a step-shape waveform and random LFO for modulation, creating a unique flanging effect.

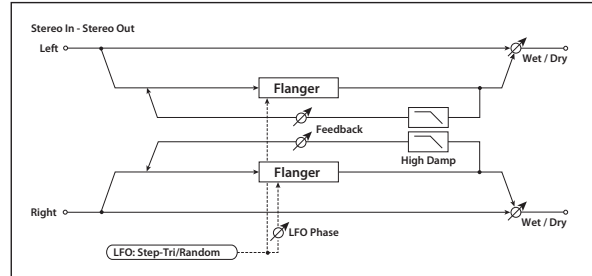

| | | | | |
|---|-------------------------|-----------------------------------|---|--|
| a | Delay Time [msec] | 0.0...50.0 | Sets the delay time from the original sound | |
| b | LFO Waveform | Step-Tri, Random | Selects the LFO Waveform p.259 | |
| | LFO Phase [degree] | -180...+180 | Sets the LFO phase difference between the left and right p.259 | |
| c | LFO Frequency [Hz] | 0.02...20.00 | Sets the speed of the LFO p.259 | |
| | Src | Off...Tempo | Selects the modulation source used for both LFO speed and step speed | |
| | Amt | -20.00...+20.00 | Sets the modulation amount of LFO speed | |
| d | LFO Step Frequency [Hz] | 0.05...50.00 | Sets the LFO step speed (speed that changes in steps) | |
| | Step Amt | -50.00...+50.00 | Sets the modulation amount of LFO step speed | |
| e | MIDI Sync | Off, On | When this is on, the LFO speed is set by BPM, Base Note, and Times, instead of Frequency p.257 | |
| | BPM | MIDI, 40.00...300.00 | MIDI syncs to the system tempo; 40-300 sets the tempo manually for this individual effect p.257 | |
| | Base Note | | Selects the type of notes that specify the LFO speed p.257 | |
| | Times | x1...x32 | Sets the number of notes that specify the LFO speed p.257 | |
| f | Step Base Note | | Selects the type of notes to specify the LFO step speed p.259 | |
| | Times | x1...x32 | Sets the number of notes to specify the LFO step speed p.259 | |
| g | LFO Type (Step) | Individual, Common1, Common2 | Selects either (individual) LFO, Common FX LFO1, or Common LFO2 p.257 | |
| | Common LFO Offset [deg] | -180...+180 | Sets the phase offset when Type = Common 1 or Common 2 p.257 | |
| h | Depth | 0...100 | Sets the depth of LFO modulation | |
| i | Feedback | -100...+100 | Sets the feedback amount p.272 | |
| | High Damp [%] | 0...100 | Sets the feedback damping amount in the high range p.272 | |
| j | Wet/Dry | -Wet...-1 : 99, Dry, 1 : 99...Wet | Sets the balance between the effect and the dry input p.259, p.272 | |
| | Src | Off...Tempo | Selects a modulation source for Wet/Dry | |
| | Amt | -100...+100 | Sets the modulation amount for Wet/Dry | |

041: St. Env. Flanger (Stereo Envelope Flanger)

This Flanger uses an envelope generator for modulation. You will obtain the same pattern of flanging each time you play. You can also control the Flanger directly using the modulation source.

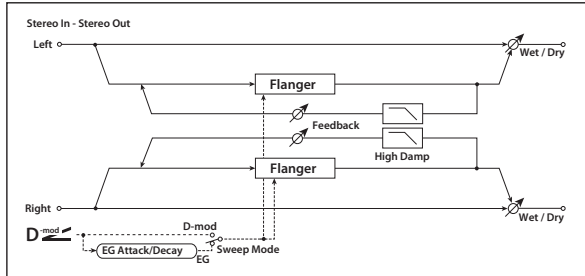

| | | | | |
|---|-----------------------|-----------------------------------|--|-------|
| a | L Delay Bottom [msec] | 0.0...50.0 | Sets the lower limit of the left-channel delay time | |
| | L Delay Top [msec] | 0.0...50.0 | Sets the upper limit of the left-channel delay time | |
| b | R Delay Bottom [msec] | 0.0...50.0 | Sets the lower limit of the right-channel delay time | |
| | R Delay Top [msec] | 0.0...50.0 | Sets the upper limit of the right-channel delay time | |
| c | Sweep Mode | EG, D-mod | Determines whether the flanger is controlled by the envelope generator or by the modulation source p.273 | |
| | Src | Off...Tempo | Selects the modulation source that triggers the EG (when Sweep Mode = EG), or the modulation source that causes the flanger to sweep (when Sweep Mode = D-mod) p.273 | D-mod |
| d | EG Attack | 1...100 | Sets the EG attack speed p.273 | |
| | EG Decay | 1...100 | Sets the EG decay speed p.273 | |
| e | Feedback | -100...+100 | Sets the feedback amount p.272 | |
| f | High Damp [%] | 0...100 | Sets the feedback damping amount in the high range p.272 | |
| g | Wet/Dry | -Wet...-1 : 99, Dry, 1 : 99...Wet | Sets the balance between the effect and the dry input p.259, p.272 | D-mod |
| | Src | Off...Tempo | Selects a modulation source for Wet/Dry | |
| | Amt | -100...+100 | Sets the modulation amount for Wet/Dry | |

c: Sweep Mode

c: Src

This parameter switches the flanger control mode. With **Sweep Mode** = EG, the flanger will sweep using the envelope generator. This envelope generator is included in the envelope flanger, and not related to the Pitch EG, Filter EG, or Amp EG.

The **Src** parameter selects the source that starts the envelope generator. If you select, for example, Gate, the envelope generator will start when the note-on message is received.

When **Sweep Mode** = D-mod, the modulation source can control the flanger directly. Select the modulation source using the **Src** parameter.

MIDI The effect is off when a value for the modulation source specified for the **Src** parameter is smaller than 64, and the effect is on when the value is 64 or higher. The Envelope Generator is triggered when the value changes from 63 or smaller to 64 or higher.

d: EG Attack

d: EG Decay

Attack and Decay speed are the only adjustable parameters on this EG.

042: Stereo Phaser

This effect creates a swell by shifting the phase. It is very effective on electric piano sounds. You can add spread to the sound by offsetting the phase of the left and right LFOs from each other.

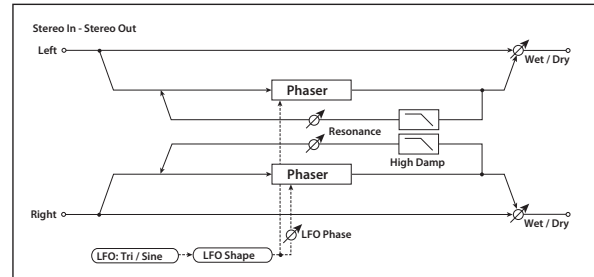

| | | | | |
|---|-------------------------|-----------------------------------|---|-----------|
| a | LFO Waveform | Triangle, Sine | Selects the LFO Waveform | |
| | LFO Shape | -100...+100 | Changes the curvature of the LFO Waveform p.258 | |
| b | LFO Phase [degree] | -180...+180 | Sets the LFO phase difference between the left and right p.259 | |
| c | LFO Frequency [Hz] | 0.02...20.00 | Sets the speed of the LFO p.257 | D-mod |
| | Src | Off...Tempo | Selects a modulation source for LFO speed | |
| d | Amt | -20.00...+20.00 | Sets the modulation amount of LFO speed | |
| | MIDI Sync | Off, On | When this is on, the LFO speed is set by BPM, Base Note, and Times, instead of Frequency p.257 | FX Sync |
| | BPM | MIDI, 40.00...300.00 | MIDI syncs to the system tempo; 40-300 sets the tempo manually for this individual effect p.257 | |
| | Base Note | | Selects the type of notes that specify the LFO speed p.257 | |
| | Times | x1...x32 | Sets the number of notes that specify the LFO speed p.257 | |
| e | LFO Type | Individual, Common1, Common2 | Selects either (individual) LFO, Common FX LFO1, or Common LFO2 p.257 | FX Common |
| | Common LFO Offset [deg] | -180...+180 | Sets the phase offset when Type = Common 1 or Common 2 p.257 | |
| f | Manual | 0...100 | Sets the frequency to which the effect is applied | D-mod |
| | Src | Off...Tempo | Selects the modulation source for the LFO modulation | |
| | Amt | -100...+100 | Sets the modulation amount of the LFO modulation | |
| j | Depth | 0...100 | Sets the depth of LFO modulation | D-mod |
| | Src | Off...Tempo | Selects the modulation source for the LFO modulation depth | |
| h | Amt | -100...+100 | Sets the modulation amount of the LFO modulation depth | |
| | Resonance | -100...+100 | Sets the resonance amount p.274 | |
| i | High Damp [%] | 0...100 | Sets the resonance damping amount in the high range p.274 | |
| | Wet/Dry | -Wet...-1 : 99, Dry, 1 : 99...Wet | Sets the balance between the effect and the dry input p.259, p.274 | D-mod |
| | Src | Off...Tempo | Selects a modulation source for Wet/Dry | |
| | Amt | -100...+100 | Sets the modulation amount for Wet/Dry | |

h: Resonance

i: Wet/Dry

The peak shape of the positive and negative Feedback value is different. The harmonics will be emphasized when the effect sound is mixed with the dry sound, if you set a

positive value for both **Resonance** and **Wet/Dry**, and if you set a negative value for both **Resonance** and **Wet/Dry**.

h: High Damp [%]

This parameter sets the amount of damping of the resonance in the high range. Increasing the value will cut high-range harmonics.

043: Small Phaser

This models a classic phaser that was born in New York during the 1970s. With a warm, rich tone, it is also loved by many electric piano players.

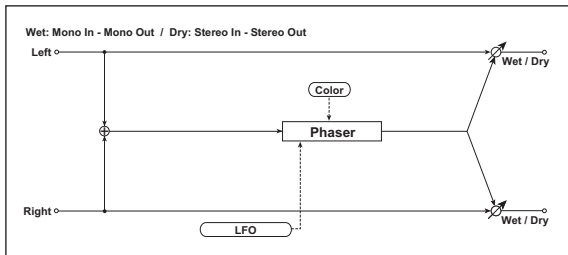

| | | | | |
|---|------------|--|---|--|
| a | Speed [Hz] | 0.10...10.0 | Sets the speed of the LFO | |
| | Src | Off...Tempo | Selects a modulation source for Speed [Hz] | |
| | Amt | -100...+100 | Sets the modulation amount for Speed [Hz] | |
| b | Color | Off, On | Switches the tone of the phaser sound p.274 | |
| c | Wet/Dry | -Wet... -1 : 99, Dry, 1 : 99...Wet | Sets the balance between the effect and the dry input p.259, p.274 | |
| | Src | Off...Tempo | Selects a modulation source for Wet/Dry | |
| | Amt | -100...+100 | Sets the modulation amount for Wet/Dry | |

b: Color

This lets you choose between two types of phaser sound. Turning this On produces a deeper phase shift effect with a distinctive modulation.

044: Orange Phaser

This models a standard model of analog phaser that achieved great popularity. It gives a sense of movement to electric piano sounds, adding a rich-sounding phase shift effect.

045: Black Phaser

This models a Danish-made four-stage phaser that featured a wide range.

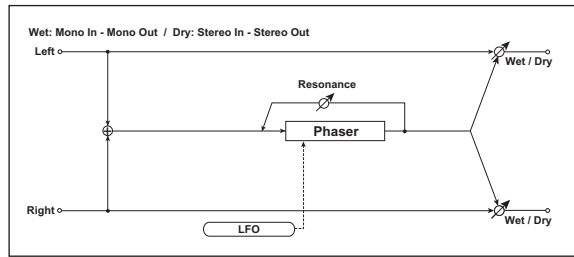

| | | | | |
|---|------------|--|---|--|
| a | Speed [Hz] | 0.10...10.0 | Sets the speed of the LFO | |
| | Src | Off...Tempo | Selects a modulation source for Speed [Hz] | |
| | Amt | -100...+100 | Sets the modulation amount for Speed [Hz] | |
| b | Depth | 0...100 | Sets the depth of LFO modulation | |
| | Src | Off...Tempo | Selects a modulation source for Depth | |
| | Amt | -100...+100 | Sets the modulation amount for Depth | |
| c | Resonance | 0...100 | Sets the resonance amount | |
| d | Manual | 1...100 | Sets the frequency where the effect is applied | |
| e | Wet/Dry | -Wet... -1 : 99, Dry, 1 : 99...Wet | Sets the balance between the effect and the dry input | |
| | Src | Off...Tempo | Selects a modulation source for Wet/Dry | |
| | Amt | -100...+100 | Sets the modulation amount for Wet/Dry | |

046: U-VIBE

This models a famous chorus/vibrato pedal effect. Simulating a rotary speaker, this effect produced a fascinatingly lush tone.

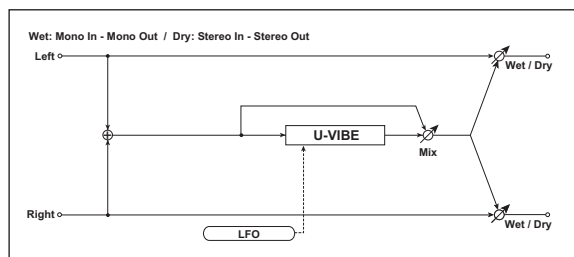

| | | | | |
|---|------------|-------------|--|--|
| a | Speed [Hz] | 0.10...10.0 | Sets the speed of the vibration | |
| | Src | Off...Tempo | Selects a modulation source for Speed [Hz] | |
| | Amt | -100...+100 | Sets the modulation amount for Speed [Hz] | |
| b | Depth | 0...100 | Sets the depth of vibration | |
| | Src | Off...Tempo | Selects a modulation source for Depth | |
| | Amt | -100...+100 | Sets the modulation amount for Depth | |
| c | Mix | 0...100 | Sets the effect mix level | |
| | Src | Off...Tempo | Selects a modulation source for Mix | |
| | Amt | -100...+100 | Sets the modulation amount for Mix | |

| | | | | |
|---|---------|--|---|--|
| d | Wet/Dry | –Wet... –1 : 99, Dry, 1 : 99...Wet | Sets the balance between the effect and the dry input p.275 | |
| | Src | Off...Tempo | Selects a modulation source for Wet/Dry | |
| | Amt | –100...+100 | Sets the modulation amount for Wet/Dry | |

c: Mix

d: Wet/Dry

The **Mix** parameter specifies the amount of effect sound relative to the direct sound. A setting of 0 produces the direct sound, a setting of about 50 produces chorus, and a setting of 100 produces a vibrato effect. If you set the **Wet/Dry** parameter to Wet, the sound will be output with the mix balance specified by **Mix**.

| | | | | |
|---|---------------|--|--|--|
| g | Manual | 0...100 | Sets the frequency to which the effect is applied | |
| | Src | Off...Tempo | Selects the modulation source for the LFO modulation | |
| | Amt | –100...+100 | Sets the modulation amount of the LFO modulation | |
| h | Depth | 0...100 | Sets the depth of LFO modulation | |
| i | Resonance | –100...+100 | Sets the resonance amount p.274 | |
| | High Damp [%] | 0...100 | Sets the resonance damping amount in the high range p.274 | |
| j | Wet/Dry | –Wet... –1 : 99, Dry, 1 : 99...Wet | Sets the balance between the effect and the dry input p.259, p.274 | |
| | Src | Off...Tempo | Selects a modulation source for Wet/Dry | |
| | Amt | –100...+100 | Sets the modulation amount for Wet/Dry | |

047: St. Random Phaser (Stereo Random Phaser)

This is a stereo phaser. The effect uses a step-shape waveform and random LFO for modulation, creating a unique phasing effect.

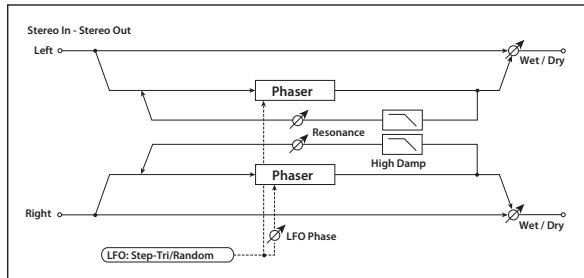

| | | | | |
|---|-------------------------|------------------------------|---|--|
| a | LFO Waveform | Step-Tri, Step-Sin, Random | Selects the LFO Waveform p.259 | |
| | LFO Phase [degree] | –180...+180 | Sets the LFO phase difference between the left and right p.259 | |
| b | LFO Frequency [Hz] | 0.02...20.00 | Sets the speed of the LFO p.257 | |
| | Src | Off...Tempo | Selects the modulation source commonly used for LFO speed and step speed | |
| | Amt | –20.00... +20.00 | Sets the modulation amount of LFO speed | |
| c | LFO Step Frequency [Hz] | 0.05...50.00 | Sets the LFO step speed p.259 | |
| | Amt | –50.00... +50.00 | Sets the modulation amount of LFO step speed | |
| d | MIDI Sync | Off, On | When this is on, the LFO speed is set by BPM, Base Note, and Times, instead of Frequency p.257 | |
| | BPM | MIDI, 40.00... 300.00 | MIDI syncs to the system tempo; 40–300 sets the tempo manually for this individual effect p.257 | |
| | Base Note | | Selects the type of notes that specify the LFO speed p.257 | |
| | Times | x1...x32 | Sets the number of notes that specify the LFO speed p.257 | |
| e | Step Base Note | | Selects the type of notes to specify the LFO step speed p.257 | |
| | Times | x1...x32 | Sets the number of notes to specify the LFO step speed p.257 | |
| f | LFO Type (Step) | Individual, Common1, Common2 | Selects either (individual) LFO, Common FX LFO1, or Common LFO2 p.257 | |
| | Common LFO Offset [deg] | –180...+180 | Sets the phase offset when Type = Common 1 or Common 2 p.257 | |

048: St. Env. Phaser (Stereo Envelope Phaser)

This stereo phaser uses an envelope generator for modulation. You will obtain the same pattern of phasing each time you play. You can also control the Phaser directly using the modulation source.

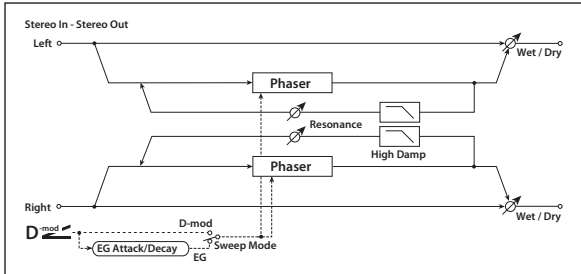

| | | | | |
|---|-----------------|--|---|--|
| a | L Manual Bottom | 0..100 | Sets the lower limit of the frequency range for the effect on the left channel | |
| | L Manual Top | 0..100 | Sets the upper limit of the frequency range for the effect on the left channel | |
| b | R Manual Bottom | 0..100 | Sets the lower limit of the frequency range for the effect on the right channel | |
| | R Manual Top | 0..100 | Sets the upper limit of the frequency range for the effect on the right channel | |
| c | Sweep Mode | EG, D-mod | Determines whether the flanger is controlled by the envelope generator or by the modulation source p.273 | |
| | Src | Off...Tempo | Selects the modulation source that triggers the EG (when EG is selected for Sweep Mode), or modulation source that causes the flanger to sweep (when D-mod is selected for Sweep Mode) p.273 | |
| d | EG Attack | 1..100 | Sets the EG attack speed p.273 | |
| | EG Decay | 1..100 | Sets the EG decay speed p.273 | |
| e | Resonance | -100...+100 | Sets the resonance amount p.274 | |
| f | High Damp [%] | 0..100 | Sets the resonance damping amount in the high range p.274 | |
| g | Wet/Dry | -Wet... -1 : 99, Dry, 1 : 99...Wet | Sets the balance between the effect and the dry input p.259, p.274 | |
| | Src | Off...Tempo | Selects a modulation source for Wet/Dry | |
| | Amt | -100...+100 | Sets the modulation amount for Wet/Dry | |

Modulation and Pitch Shift (Mod./P.Shift)

049: Stereo Vibrato

This effect causes the pitch of the input signal to shimmer. Using the AutoFade allows you to increase or decrease the shimmering speed.

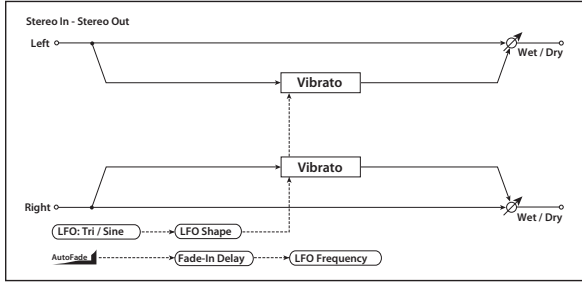

| | | | | |
|---|-------------------------|------------------------------|---|-------------------|
| a | AUTOFADE Src | Off...Tempo | Selects the modulation source that starts AutoFade p.277 | D ^{mod} |
| b | Fade-In Delay [msec] | 00...2000 | Sets the fade-in delay time p.277 | |
| | Fade-In Rate | 1...100 | Sets the rate of fade-in p.277 | |
| c | LFO Waveform | Triangle, Sine | Selects the LFO Waveform | |
| | LFO Shape | -100...+100 | Changes the curvature of the LFO Waveform p.259 | |
| d | LFO Frequency Mod | D-mod, AUTOFADE | Switches between D-mod and AUTOFADE for the LFO frequency modulation p.277 | |
| e | LFO Frequency [Hz] | 0.02...20.00 | Sets the speed of the LFO | D ^{mod} |
| | Src | Off...Tempo | Selects a modulation source for LFO speed | |
| | Amt | -20.00...+20.00 | Sets the modulation amount of LFO speed | |
| f | MIDI Sync | Off, On | When this is on, the LFO speed is set by BPM, Base Note, and Times, instead of Frequency p.257 | A ^{sync} |
| | BPM | MIDI, 40.00...300.00 | MIDI syncs to the system tempo; 40-300 sets the tempo manually for this individual effect p.257 | |
| | Base Note | | Selects the type of notes that specify the LFO speed p.257 | |
| | Times | x1...x32 | Sets the number of notes that specify the LFO speed p.257 | |
| g | LFO Type | Individual, Common1, Common2 | Selects either (individual) LFO, Common FX LFO1, or Common LFO2 p.257 | Common |
| | Common LFO Offset [deg] | -180...+180 | Sets the phase offset when Type = Common 1 or Common 2 p.257 | |
| h | Depth | 0...100 | Sets the depth of LFO modulation | D ^{mod} |
| | Src | Off...Tempo | Selects the modulation source of the LFO modulation depth | |
| i | Wet/Dry | Dry, 1 : 99...99 : 1, Wet | Sets the balance between the effect and the dry input | D ^{mod} |
| | Src | Off...Tempo | Selects a modulation source for Wet/Dry | |
| | Amt | -100...+100 | Sets the modulation amount for Wet/Dry | |

- a: AUTOFADE Src**
- b: Fade-In Delay [msec]**
- b: Fade-In Rate**
- d: LFO Frequency Mod**

When LFO Frequency Mod is set to AUTOFADE, you can use the modulation source selected in AUTOFADE Src as a

trigger to automatically fade in the modulation amount. When MIDI Sync is set to On, you cannot use this.

The Fade-In Rate parameter specifies the rate of fade-in. The Fade-In Delay parameter determines the time from AutoFade modulation source On until the fade-in starts.

The following is an example of fade-in where the LFO speed is increased from "1.0Hz" to "4.0Hz" when a note-on message is received.

AUTOFADE Src=Gate1, LFO Frequency Mod=AUTOFADE, LFO Frequency [Hz]=1.0, Amt=3.0

MIDI The effect is off when a value for the dynamic modulation source specified for the AUTOFADE Src parameter is smaller than 64, and the effect is on when the value is 64 or higher. The AutoFade function is triggered when the value changes from 63 or smaller to 64 or higher.

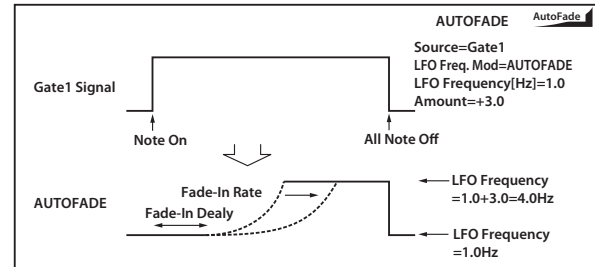

050: St. Auto Fade Mod. (Stereo Auto Fade Modulation)

This stereo chorus/flanger effect enables you to control the LFO speed and effect balance using auto fade, and you can spread the sound by offsetting the phase of the left and right LFOs from each other.

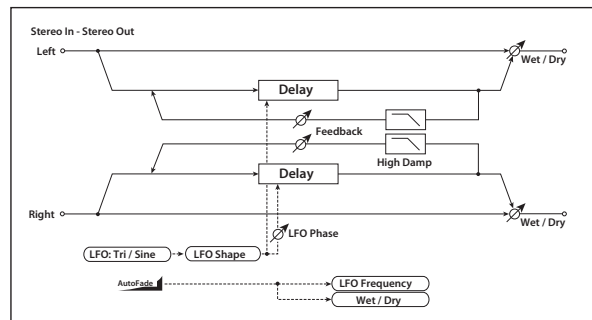

| | | | | |
|---|----------------------|-----------------|---|------------------|
| a | AUTOFADE Src | Off...Tempo | Selects the modulation source that starts AutoFade p.277 | D ^{mod} |
| | Fade-In Delay [msec] | 00...2000 | Sets the fade-in delay time p.277 | |
| | Rate | 1...100 | Sets the rate of fade-in p.277 | |
| b | LFO Frequency Mod | D-mod, AUTOFADE | Switches between D-mod and AUTOFADE for the LFO frequency modulation p.277 | |
| | Wet/Dry Mod | D-mod, AUTOFADE | Switches between D-mod and AUTOFADE for the effect balance modulation p.277 | |
| c | LFO Waveform | Triangle, Sine | Selects the LFO Waveform | |
| | LFO Shape | -100...+100 | Changes the curvature of the LFO Waveform p.258 | |

| | | | | |
|---|-------------------------|-----------------------------------|--|--|
| d | LFO Phase [degree] | -180...+180 | Sets the LFO phase difference between the left and right p.259 | |
| e | LFO Frequency [Hz] | 0.02...20.00 | Sets the speed of the LFO | |
| | Src | Off...Tempo | Selects a modulation source for LFO speed | |
| | Amt | -20.00...+20.00 | Sets the modulation amount of LFO speed | |
| f | LFO Type | Individual, Common1, Common2 | Selects either (individual) LFO, Common FX LFO1, or Common LFO2 p.257 | |
| | Common LFO Offset [deg] | -180...+180 | Sets the phase offset when Type = Common 1 or Common 2 p.257 | |
| g | L Delay Time [msec] | 0.0...500.0 | Sets the left channel delay time | |
| | R Delay Time [msec] | 0.0...500.0 | Sets the right channel delay time | |
| h | Depth | 0...200 | Sets the depth of LFO modulation | |
| i | Feedback | -100...+100 | Sets the feedback amount p.272 | |
| | High Damp [%] | 0...100 | Sets the feedback damping amount in the high range p.272 | |
| j | Wet/Dry | -Wet...-1 : 99, Dry, 1 : 99...Wet | Sets the balance between the effect and the dry input p.259, p.272 | |
| | Src | Off...Tempo | Selects a modulation source for Wet/Dry | |
| | Amt | -100...+100 | Sets the modulation amount for Wet/Dry | |

051: 2Voice Resonator

This effect resonates the input signal at a specified pitch. You can set the pitch, output level, and pan settings for two resonators individually. You can control the resonance intensity via an LFO.

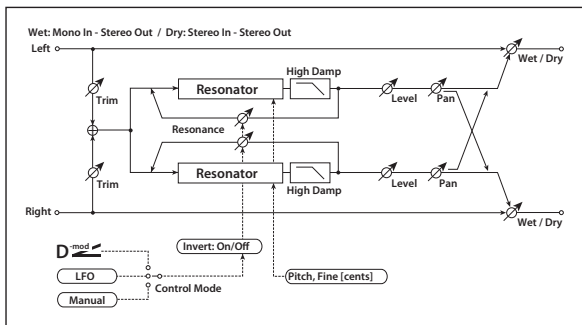

| | | | | |
|---|--------------------|----------------------|--|--|
| a | Control Mode | Manual, LFO, D-mod | Switches the controls of resonance intensity p.278 | |
| | LFO/D-mod Invert | Off, On | Reverses the Voice 1 and 2 control when LFO/D-mod is selected p.278 | |
| b | LFO Frequency [Hz] | 0.02...20.00 | Sets the speed of the LFO | |
| | D-mod Src | Off...Tempo | Selects the modulation source that controls resonance intensity | |
| c | MIDI Sync | Off, On | When this is on, the LFO speed is set by BPM, Base Note, and Times, instead of Frequency p.257 | |
| | BPM | MIDI, 40.00...300.00 | MIDI syncs to the system tempo; 40-300 sets the tempo manually for this individual effect p.257 | |
| | Base Note | | Selects the type of notes that specify the LFO speed p.257 | |
| | Times | x1...x32 | Sets the number of notes that specify the LFO speed p.257 | |

| | | | | |
|---|-------------------------|------------------------------|--|--|
| d | LFO Type | Individual, Common1, Common2 | Selects either (individual) LFO, Common FX LFO1, or Common LFO2 p.257 | |
| | Common LFO Offset [deg] | -180...+180 | Sets the phase offset when Type = Common 1 or Common 2 p.257 | |
| e | Mod. Depth | -100...+100 | Sets the amount of resonance intensity control via LFO/D-mod | |
| | Trim | 0...100 | Sets the input level at the resonator | |
| f | Voice1: Pitch | C0...B8 | Sets the voice1 Pitch for resonance p.278 | |
| | Fine [cent] | -50...+50 | Fine-adjusts the voice 1 pitch for resonance p.278 | |
| | Level | 0...100 | Sets the Voice1 output level | |
| g | Voice1: Resonance | -100...+100 | Sets the intensity of resonance when Control Mode = Manual p.278 | |
| | High Damp [%] | 0...100 | Sets the damping amount of resonant sound in the high range p.279 | |
| | Pan | L6...L1, C, R1...R6 | Sets the Voice1 stereo image | |
| h | Voice2: Pitch | C0...B8 | Sets the voice 2 Pitch for resonance p.278 | |
| | Fine [cent] | -50...+50 | Fine-adjusts the voice 2 pitch for resonance p.278 | |
| | Level | 0...100 | Sets the Voice2 output level | |
| i | Voice2: Resonance | -100...+100 | Sets the intensity of resonance when Control Mode = Manual p.278 | |
| | High Damp [%] | 0...100 | Sets the damping amount of resonant sound in the high range p.279 | |
| | Pan | L6...L1, C, R1...R6 | Sets the Voice2 stereo image | |
| j | Wet/Dry | Dry, 1 : 99... 99 : 1, Wet | Sets the balance between the effect and the dry input p.259, p.272 | |
| | Src | Off...Tempo | Selects a modulation source for Wet/Dry | |
| | Amt | -100...+100 | Sets the modulation amount for Wet/Dry | |

a: Control Mode

g: Voice 1: Resonance

i: Voice 2: Resonance

This parameter determines the resonance intensity.

When **Control Mode** = Manual, the **Resonance** parameter sets the intensity of resonance. If the **Resonance** parameter has a negative value, harmonics will be changed, and resonance will occur at a pitch one octave lower.

When **Control Mode** = LFO, the intensity of resonance varies according to the LFO. The LFO sways between positive and negative values, causing resonance to occur between specified pitches an octave apart in turn.

When **Control Mode** = D-mod, the resonance is controlled by the dynamic modulation source. If JS X is assigned as the modulation source, the pitch an octave higher and lower can be controlled, similar to when LFO is selected for Control Mode.

a: LFO/D-mod Invert

When **Control Mode** = LFO or D-mod, the controlled phase of either Voice 1 or 2 will be reversed. When the resonance pitch is set for Voice 1 (Resonance has a positive value), Voice 2 will resonate at a pitch an octave below (Resonance has a negative value).

f: Voice 1: Pitch

f: Fine [cent]

h: Voice 2: Pitch

h: Fine [cent]

The Pitch parameter specifies the pitch of resonance by note name. The **Fine** parameter allows for fine adjustment in steps of cents.

g: High Damp [%]

i: High Damp [%]

This sets the amount of damping amount for the high frequencies of the resonant sound. Lower values create a metallic sound with a higher range of harmonics.

052: Doppler

This effect simulates the “Doppler effect” of a moving sound with a changing pitch, similar to the siren of an ambulance. Mixing the effect sound with the dry sound will create a unique chorus effect.

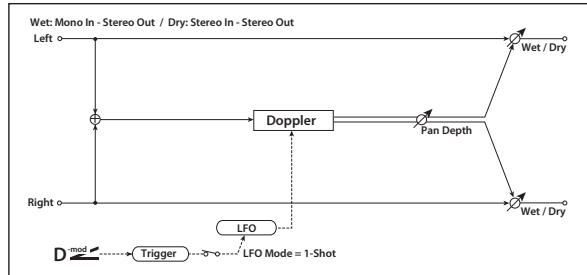

| | | | | |
|---|-------------------------|------------------------------|---|-----------|
| a | LFO Mode | Loop, 1-Shot | Switches LFO operation mode p.279 | |
| | Src | Off...Tempo | Selects the modulation source of LFO reset p.279 | D-mod |
| b | LFO Sync | Off, On | Switches between LFO reset on and off when LFO Mode is set to Loop p.279 | |
| c | LFO Frequency [Hz] | 0.02...20.00 | Sets the speed of the LFO p.259 | D-mod |
| | Src | Off...Tempo | Selects a modulation source for LFO speed | |
| | Amt | -20.00...+20.00 | Sets the modulation amount of LFO speed | |
| d | MIDI Sync | Off, On | When this is on, the LFO speed is set by BPM, Base Note, and Times, instead of Frequency p.257 | MIDI |
| | BPM | MIDI, 40.00...300.00 | MIDI syncs to the system tempo; 40-300 sets the tempo manually for this individual effect p.257 | |
| | Base Note | | Selects the type of notes that specify the LFO speed p.257 | |
| | Times | x1...x32 | Sets the number of notes that specify the LFO speed p.257 | |
| e | LFO Type | Individual, Common1, Common2 | Selects either (individual) LFO, Common FX LFO1, or Common LFO2 p.257 | FX Common |
| | Common LFO Offset [deg] | -180...+180 | Sets the phase offset when Type = Common 1 or Common 2 p.257 | |
| f | Pitch Depth | 0...100 | Sets the pitch variation of the moving sound p.279 | D-mod |
| | Src | Off...Tempo | Selects the modulation source of pitch variation | |
| | Amt | -100...+100 | Sets the modulation amount of pitch variation | |
| g | Pan Depth | -100...+100 | Sets the panning of the moving sound p.279 | D-mod |
| | Src | Off...Tempo | Selects the modulation source of panning | |
| | Amt | -100...+100 | Sets the modulation amount of panning | |
| h | Wet/Dry | Dry, 1 : 99...99 : 1, Wet | Sets the balance between the effect and the dry input | D-mod |
| | Src | Off...Tempo | Selects a modulation source for Wet/Dry | |
| | Amt | -100...+100 | Sets the modulation amount for Wet/Dry | |

a: LFO Mode

a: Src

b: LFO Sync

The **LFO Mode** parameter switches LFO operation mode. When **Loop** is selected, the Doppler effect will be created repeatedly. If **LFO Sync** is set to **On**, the LFO will be reset when the modulation source specified with the **Src** parameter is turned on.

When **LFO Mode** is set to **1-Shot**, the Doppler effect is created only once when the modulation source specified in the **Src** field is turned on. At this time if you do not set the **Src** parameter, the Doppler effect will not be created, and no effect sound will be output.

MIDI The effect is off when a value for the modulation source specified for the **Src** parameter is smaller than 64, and the effect is on when the value is 64 or higher. The Doppler effect is triggered when the value changes from 63 or smaller to 64 or higher.

f: Pitch Depth

With the Doppler effect, the pitch is raised when the sound approaches, and the pitch is lowered when the sound goes away. This parameter sets this pitch variation.

g: Pan Depth

This parameter sets the width of the stereo image of the effect sound. With larger values, the sound seems to come and go from much further away. With positive values, the sound moves from left to right; with negative values, the sound moves from right to left.

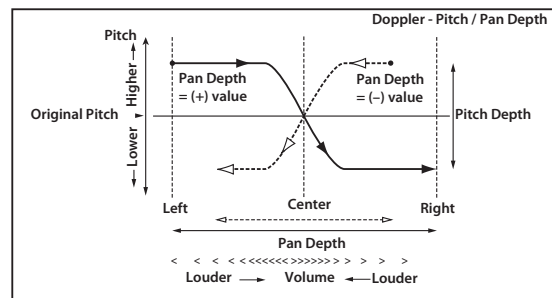

053: Scratch

This effect is applied by recording the input signal and moving the modulation source. It simulates the sound of scratches you can make using a turntable.

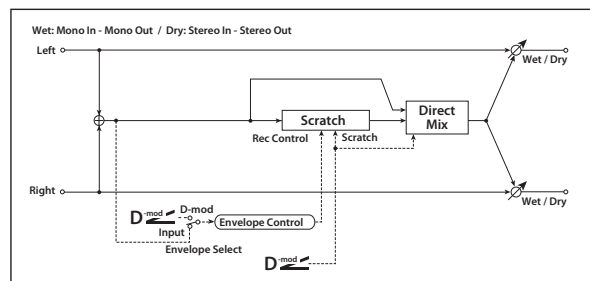

| | | | | |
|---|-----------------|--------------|--|-------|
| a | Scratch Source | Off...Tempo | Selects the modulation source for simulation control p.280 | D-mod |
| | Response | 0...100 | Sets the speed of the response to the Scratch Src p.280 | |
| c | Envelope Select | D-mod, Input | Selects whether the start and end of recording is controlled via the modulation source or the input signal level p.280 | |
| | Src | Off...Tempo | Selects the modulation source that controls recording when Envelope Select is set to D-mod p.280 | D-mod |

| | | | | |
|---|------------|-----------------------------------|---|--|
| d | Threshold | 0..100 | Sets the recording start level when Envelope Select is set to Input p.280 | |
| e | Response | 0..100 | Sets the speed of the response to the end of recording p.280 | |
| f | Direct Mix | Always On, Always Off, Cross Fade | Selects how a dry sound is mixed p.280 | |
| g | Wet/Dry | Dry, 1 : 99... 99 : 1, Wet | Sets the balance between the effect and the dry input | |
| | Src | Off...Tempo | Selects a modulation source for Wet/Dry | |
| | Amt | -100...+100 | Sets the modulation amount for Wet/Dry | |

a: Scratch Source

b: Response

The Scratch Source parameter enables you to select the modulation source that controls simulation. The value of the modulation source corresponds to the playback position. The Response parameter enables you to set the speed of the response to the modulation source.

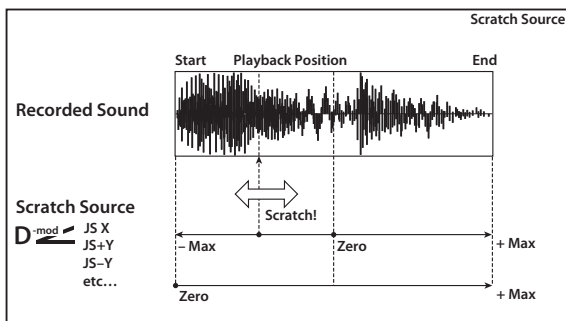

c: Envelope Select

c: Src

d: Threshold

When **Envelope Select** is set to D-mod, the input signal will be recorded only when the modulation source value is 64 or higher.

When **Envelope Select** is set to Input, the input signal will be recorded only when its level is over the Threshold value.

The maximum recording time is 2,730msec. If this is exceeded, the recorded data will start being erased from the top.

e: Response

This parameter enables you to set the speed of the response to the end of recording. Set a smaller value when you are recording a phrase or rhythm pattern, and set a higher value if you are recording only one note.

f: Direct Mix

With Always On, a dry sound is usually output. With Always Off, dry sounds are not output. With Cross Fade, a dry sound is usually output, and it is muted only when scratching.

Set Wet/Dry to Wet to use this parameter effectively.

054: Grain Shifter

This effect cuts extremely short samples (“grains”) from the input signal waveform and plays them repeatedly, giving a mechanical character to the sound.

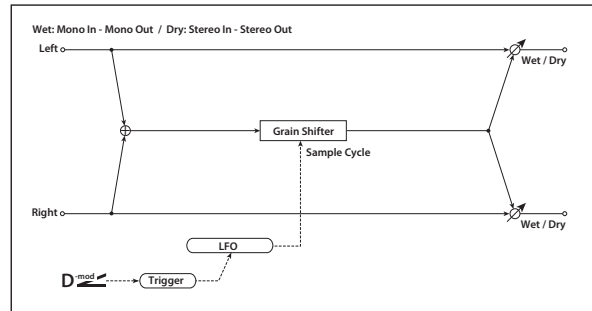

| | | | | |
|---|-------------------------|------------------------------|---|--|
| a | Duration | 0..100 | Sets the duration of the grain p.280 | |
| | Src | Off...Tempo | Selects the source that will modulate the duration of the grain | |
| | Amt | -100...+100 | Sets the amount by which the grain duration will be modulated | |
| b | LFO Sync Src | Off...Tempo | Selects the modulation source that will reset the LFO | |
| c | LFO Sample Cycle [Hz] | 0.02...20.00 | Sets the frequency at which the grain will be switched p.280 | |
| | Src | Off...Tempo | Selects a modulation source for LFO speed | |
| d | Amt | -20.00... +20.00 | Sets the modulation amount of LFO speed | |
| | MIDI Sync | Off, On | When this is on, the LFO speed is set by BPM, Base Note, and Times, instead of Frequency p.257 | |
| | BPM | MIDI, 40.00... 300.00 | MIDI syncs to the system tempo; 40-300 sets the tempo manually for this individual effect p.257 | |
| | Base Note | | Selects the type of notes that specify the LFO speed p.257 | |
| e | Times | x1...x32 | Sets the number of notes that specify the LFO speed p.257 | |
| | LFO Type | Individual, Common1, Common2 | Selects either (individual) LFO, Common FX LFO1, or Common LFO2 p.257 | |
| | Common LFO Offset [deg] | -180...+180 | Sets the phase offset when Type = Common 1 or Common 2 p.257 | |
| f | Wet/Dry | Dry, 1 : 99... 99 : 1, Wet | Sets the balance between the effect and the dry input | |
| | Src | Off...Tempo | Selects a modulation source for Wet/Dry | |
| | Amt | -100...+100 | Sets the modulation amount for Wet/Dry | |

a: Duration

c: LFO Sample Cycle [Hz]

Duration sets the length of the sampled grain, and the **LFO Sample Cycle** controls how often a new grain is sampled. In between Sample Cycles, the current grain is repeated continuously.

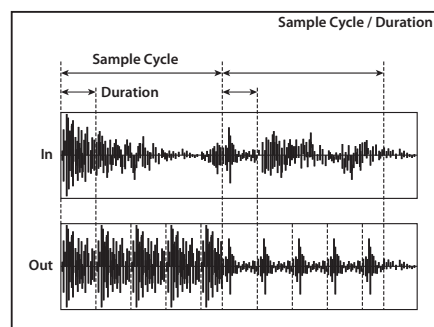

055: Stereo Tremolo

This effect modulates the volume level of the input signal. The effect is stereo, and offsetting the LFO of the left and right phases from each other produces a tremolo effect between left and right.

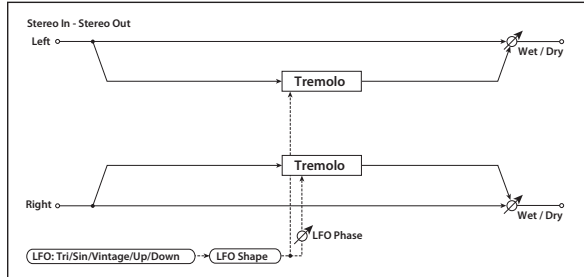

| | | | | | |
|---|-------------------------|-----------------------------------|---|-------|--|
| a | LFO Waveform | Triangle, Sine, Vintage, Up, Down | Selects the LFO Waveform | p.281 | |
| | LFO Shape | -100...+100 | Changes the curvature of the LFO Waveform | p.258 | |
| b | LFO Phase [degree] | -180...+180 | Sets the LFO phase difference between the left and right | p.281 | |
| | LFO Frequency [Hz] | 0.02...20.00 | Sets the speed of the LFO | p.259 | |
| c | Src | Off...Tempo | Selects a modulation source for LFO speed | | |
| | Amt | -20.00...+20.00 | Sets the modulation amount of LFO speed | | |
| d | MIDI Sync | Off, On | When this is on, the LFO speed is set by BPM, Base Note, and Times, instead of Frequency | p.257 | |
| | BPM | MIDI, 40.00...300.00 | MIDI syncs to the system tempo; 40-300 sets the tempo manually for this individual effect | p.257 | |
| | Base Note | | Selects the type of notes that specify the LFO speed | p.257 | |
| | Times | x1...x32 | Sets the number of notes that specify the LFO speed | p.257 | |
| e | LFO Type | Individual, Common1, Common2 | Selects either (individual) LFO, Common FX LFO1, or Common LFO2 | p.257 | |
| | Common LFO Offset [deg] | -180...+180 | Sets the phase offset when Type = Common 1 or Common 2 | p.257 | |
| f | Depth | 0...100 | Sets the depth of LFO modulation | | |
| | Src | Off...Tempo | Selects the modulation source of the depth of modulation | | |
| | Amt | -100...+100 | Sets the modulation amount of the depth of modulation | | |
| g | Wet/Dry | Dry, 1 : 99...99 : 1, Wet | Sets the balance between the effect and the dry input | | |
| | Src | Off...Tempo | Selects a modulation source for Wet/Dry | | |
| | Amt | -100...+100 | Sets the modulation amount for Wet/Dry | | |

a: LFO Waveform

This parameter sets the basic shape of the LFO. The **Vintage** waveform models classic guitar-amp tremolo.

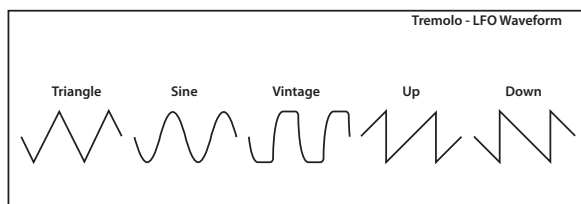

b: LFO Phase [degree]

This parameter determines the difference between the left and right LFO phases. A higher value will simulate the auto-

pan effect in which the sound is panned between left and right.

056: TEX Trem (TEX Tremolo)

This models the highly-acclaimed tremolo circuit that was built into a US-made combo amp. The Spread setting lets you create a pan effect that wavers between left and right.

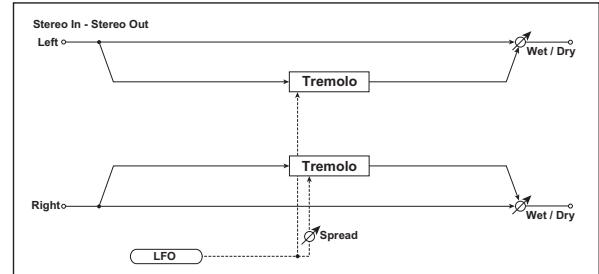

| | | | | | |
|---|--------------|-----------------------------------|--|--|--|
| a | Speed [Hz] | 0.10...10.0 | Sets the tremolo speed | | |
| | Src | Off...Tempo | Selects a modulation source for Speed [Hz] | | |
| b | Amt | -100...+100 | Sets the modulation amount for Speed [Hz] | | |
| | Depth | 0...100 | Select the tremolo depth | | |
| c | Src | Off...Tempo | Selects a modulation source for Depth | | |
| | Amt | -100...+100 | Sets the modulation amount for Depth | | |
| d | Spread | 0...100 | Sets the width of the stereo image of the effect sound | | |
| e | Level Adjust | 1...100 | Sets the output level | | |
| | Wet/Dry | -Wet...-1 : 99, Dry, 1 : 99...Wet | Sets the balance between the effect and the dry input | | |
| | Src | Off...Tempo | Selects a modulation source for Wet/Dry | | |
| f | Amt | -100...+100 | Sets the modulation amount for Wet/Dry | | |

057: St. Env. Tremolo (Stereo Envelope Tremolo)

This effect uses the input signal level to modulate a stereo tremolo (LFO volume modulation). For instance, you can create a tremolo effect that becomes deeper and faster as the input gets more quiet.

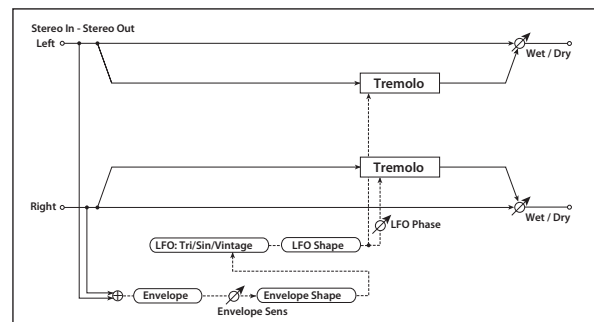

| | | | | | |
|---|----------------|-------------------------|---|-------|--|
| a | Envelope Sens | 0...100 | Sets the envelope's sensitivity to the input signal | | |
| | Envelope Shape | -100...+100 | Sets the envelope's curvature | | |
| b | LFO Waveform | Triangle, Sine, Vintage | Selects the LFO Waveform | | |
| | LFO Shape | -100...+100 | Changes the curvature of the LFO Waveform | p.258 | |

| | | | | |
|---|----------------------|----------------------------|---|-------------------|
| c | LFO Phase [degree] | -180...+180 | Sets the LFO phase difference between the left and right p.281 | |
| d | LFO Frequency [Hz] | 0.02...20.00 | Sets the speed of the LFO p.282 | |
| | Envelope Amount [Hz] | -20.00...+20.00 | Sets the amount added to or subtracted from the Frequency when the envelope is at maximum p.282 | |
| e | Depth | 0...100 | Sets the initial amount of tremolo p.282 | |
| | Envelope Amount | -100...+100 | Sets the amount added to or subtracted from the Depth when the envelope is at maximum p.282 | |
| f | Wet/Dry | Dry, 1 : 99... 99 : 1, Wet | Sets the balance between the effect and the dry input | D ² ad |
| | Src | Off...Tempo | Selects a modulation source for Wet/Dry | |
| | Amt | -100...+100 | Sets the modulation amount for Wet/Dry | |

d: LFO Frequency [Hz]

d: Envelope Amount [Hz]

e: Depth

e: Envelope Amount

The graphic below shows an example of tremolo modulation with negative modulation of both **Depth** and **Frequency**. At the start of the note, the input is at maximum volume. This slows down the LFO **Frequency** to **1.0Hz**, but also modulates the **Depth** to **0**—so the tremolo doesn't have any effect.

As the input volume dies down, the **Frequency** speeds up; the **Depth** also increases, making the tremolo effect increasingly audible. When the input volume approaches silence, the **Depth** is at its maximum (**100**) and **Frequency** is at **8Hz**.

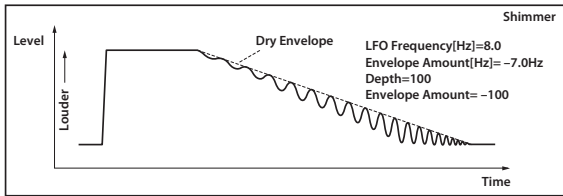

058: Stereo Auto Pan

This is a stereo-in, stereo-out auto-panner. The Phase and Shape parameters lets you create various panning effects, such as making the left and right inputs seem to chase each other around the stereo field.

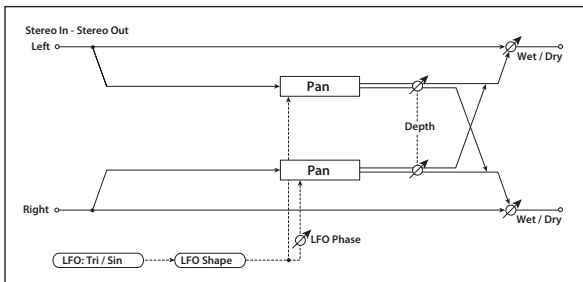

| | | | | |
|---|--------------------|----------------|--|--|
| a | LFO Waveform | Triangle, Sine | Selects the LFO Waveform | |
| | LFO Shape | -100...+100 | Changes the curvature of the LFO Waveform p.282 | |
| b | LFO Phase [degree] | -180...+180 | Sets the LFO phase difference between the left and right p.282 | |

| | | | | |
|---|-------------------------|--------------------------------|---|-------------------|
| c | LFO Frequency [Hz] | 0.02...20.00 | Sets the speed of the LFO p.259 | D ² ad |
| | Src | Off...Tempo | Selects a modulation source for LFO speed | |
| | Amt | -20.00...+20.00 | Sets the modulation amount of LFO speed | |
| | MIDI Sync | Off, On | When this is on, the LFO speed is set by BPM, Base Note, and Times, instead of Frequency p.257 | ojs |
| d | BPM | MIDI, 40.00... 300.00 | MIDI syncs to the system tempo; 40–300 sets the tempo manually for this individual effect p.257 | |
| | Base Note | | Selects the type of notes that specify the LFO speed p.257 | |
| | Times | x1...x32 | Sets the number of notes that specify the LFO speed p.257 | |
| e | LFO Type | Individual, Common 1, Common 2 | Selects either (individual) LFO, Common FX LFO1, or Common LFO2 p.257 | ojs Common |
| | Common LFO Offset [deg] | -180...+180 | Sets the phase offset when Type = Common 1 or Common 2 p.257 | |
| f | Depth | 0...100 | Sets the depth of LFO modulation | D ² ad |
| | Src | Off...Tempo | Selects the modulation source of the depth of modulation | |
| | Amt | -100...+100 | Sets the modulation amount of the depth of modulation | |
| g | Wet/Dry | Dry, 1 : 99... 99 : 1, Wet | Sets the balance between the effect and the dry input | D ² ad |
| | Src | Off...Tempo | Selects a modulation source for Wet/Dry | |
| | Amt | -100...+100 | Sets the modulation amount for Wet/Dry | |

a: LFO Shape

You can change the panning curve by modifying the LFO's **Shape**.

b: LFO Phase [degree]

This determines the phase difference between the left and right LFOs. When you gradually change the value away from 0, the sounds from the left and right channels will seem to chase each other around. If you set the parameter to **+180** or **-180**, the sounds from each channel will cross over each other.

You'll only hear the effect of this parameter if the input is true stereo, with different signals in the left and right channels.

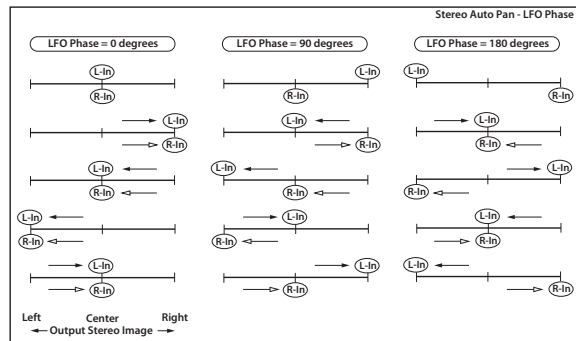

059: St. Phaser + Trml (Stereo Phaser + Tremolo)

This effect combines a stereo phaser and tremolo, with linked LFOs. Swelling phaser modulation and tremolo effects synchronize with each other, creating a soothing modulation effect particularly suitable for electric piano.

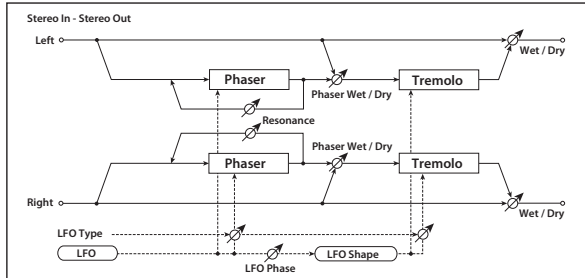

| | | | | |
|---|-------------------------|---|---|--|
| a | Type | Phaser - Tremolo, ... Phaser LR - Tremolo LR | Selects the type of the tremolo and phaser LFOs and phaser LFOs p.283 | |
| | LFO Phase [degree] | -180...+180 | Sets the phase difference between the tremolo and phaser LFOs p.283 | |
| b | LFO Frequency [Hz] | 0.02...20.00 | Sets the speed of the LFO p.259 | |
| | Src | Off...Tempo | Selects a modulation source for LFO speed | |
| | Amt | -20.00...+20.00 | Sets the LFO speed modulation amount | |
| c | MIDI Sync | Off, On | When this is on, the LFO speed is set by BPM, Base Note, and Times, instead of Frequency p.257 | |
| | BPM | MIDI, 40.00...300.00 | MIDI syncs to the system tempo; 40-300 sets the tempo manually for this individual effect p.257 | |
| | Base Note | | Selects the type of notes that specify the LFO speed p.257 | |
| | Times | x1...x32 | Sets the number of notes that specify the LFO speed p.257 | |
| d | LFO Type | Individual, Common1, Common2 | Selects either (individual) LFO, Common FX LFO1, or Common LFO2 p.257 | |
| | Common LFO Offset [deg] | -180...+180 | Sets the phase offset when Type = Common 1 or Common 2 p.257 | |
| e | Phaser Manual | 0...100 | Sets the phaser frequency range | |
| | Resonance | -100...+100 | Sets the phaser resonance amount | |
| f | Phaser Depth | 0...100 | Sets the phaser modulation depth | |
| | Src | Off...Tempo | Selects the modulation source for the phaser modulation depth | |
| | Amt | -100...+100 | Sets the modulation amount for the phaser modulation depth | |
| g | Phaser Wet/Dry | -Wet, -2 : 98...Dry... 2 : 98, Wet | Sets the balance between the phaser effect and dry sounds p.283 | |
| h | Tremolo Shape | -100...+100 | Sets the degree of the tremolo LFO shaping | |
| i | Tremolo Depth | 0...100 | Sets the tremolo modulation depth | |
| | Src | Off...Tempo | Selects the modulation source for the tremolo modulation depth | |
| | Amt | -100...+100 | Sets the modulation amount of the tremolo modulation depth | |

| | | | | |
|---|---------|----------------------------|---|--|
| j | Wet/Dry | Dry, 1 : 99... 99 : 1, Wet | Sets the balance between the effect and the dry input p.283 | |
| | Src | Off...Tempo | Selects a modulation source for Wet/Dry | |
| | Amt | -100...+100 | Sets the modulation amount for Wet/Dry | |

a: Type

a: LFO Phase [degree]

Select the type of phaser LFO and tremolo LFO for the **Type** parameter. How the effect sound moves or rotates depends on the type of LFO. Selecting **LFO Phase** enables you to offset the timing of the phaser peak and control a subtle movement and rotation of the sound.

g: Phaser Wet/Dry

j: Wet/Dry

PHASER Wet/Dry sets the balance between the phaser output and the dry sound. **OUTPUT Wet/Dry** sets the balance between the final phaser and tremolo output level and the dry sound.

060: St. Ring Modulator (Stereo Ring Modulator)

This effect creates a metallic sound by applying the oscillators to the input signal. Use the LFO or Dynamic Modulation to modulate the oscillator to create a radical modulation. Matching the oscillator frequency with a note number will produce a ring modulation effect in specific key ranges.

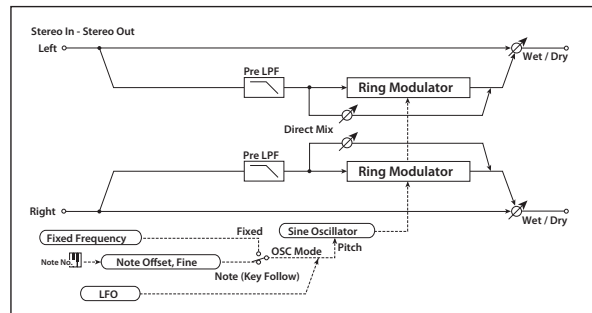

| | | | | |
|---|----------------------|--------------------------|---|--|
| a | OSC Mode | Fixed, Note (Key Follow) | Switching between specifying the oscillator frequency and using a note number p.284 | |
| | Pre LPF | 0...100 | Sets the damping amount of the high range input to the ring modulator p.284 | |
| b | Fixed Frequency [Hz] | 0...12.00k | Sets the oscillator frequency when OSC Mode is set to Fixed p.284 | |
| | Src | Off...Tempo | Selects the modulation source for the oscillator frequency when OSC Mode is set to Fixed | |
| c | Amt | -12.00k...+12.00k | Sets the modulation amount of the oscillator frequency when OSC Mode is set to Fixed | |
| | Note Offset | -48...+48 | Sets the pitch difference from the original note when OSC Mode is set to Note (Key Follow) p.284 | |
| d | Note Fine | -100...+100 | Fine-adjusts the oscillator frequency p.284 | |
| | Direct Mix | 0...100 | Direct signal (after passing through the pre-low-pass filter) mixed into the ring modulation output | |

| | | | | |
|---|-------------------------|------------------------------|---|--|
| d | LFO Frequency [Hz] | 0.02...20.00 | Sets the speed of the LFO p.259 | |
| | Src | Off...Tempo | Selects a modulation source for LFO speed | |
| | Amt | -20.00...+20.00 | Sets the modulation amount of LFO speed | |
| e | MIDI Sync | Off, On | When this is on, the LFO speed is set by BPM, Base Note, and Times, instead of Frequency p.257 | |
| | BPM | MIDI, 40.00...300.00 | MIDI syncs to the system tempo; 40-300 sets the tempo manually for this individual effect p.257 | |
| | Base Note | | Selects the type of notes that specify the LFO speed p.257 | |
| | Times | x1...x32 | Sets the number of notes that specify the LFO speed p.257 | |
| f | LFO Type | Individual, Common1, Common2 | Selects either (individual) LFO, Common FX LFO1, or Common LFO2 p.257 | |
| | Common LFO Offset [deg] | -180...+180 | Sets the phase offset when Type = Common 1 or Common 2 p.257 | |
| g | LFO Depth | 0...100 | Sets the depth of LFO modulation for the oscillator frequency | |
| | Src | Off...Tempo | Selects the modulation source of the depth of modulation | |
| | Amt | -100...+100 | Sets the modulation amount of the depth of modulation | |
| h | Wet/Dry | Dry, 1 : 99...99 : 1, Wet | Sets the balance between the effect and the dry input | |
| | Src | Off...Tempo | Selects a modulation source for Wet/Dry | |
| | Amt | -100...+100 | Sets the modulation amount for Wet/Dry | |

a: OSC Mode

This parameter determines whether or not the oscillator frequency follows the note number.

a: Pre LPF

This parameter enables you to set the damping amount of the high range sound input to the ring modulator. If the input sound contains lots of harmonics, the effect may sound dirty. In this case, cut a certain amount of high range.

b: Fixed Frequency [Hz]

This parameter sets the oscillator frequency when **OSC Mode** is set to Fixed.

c: Note Offset

c: Note Fine

These parameters for the oscillator are used when **OSC Mode** is set to Note (Key Follow). The **Note Offset** sets the pitch difference from the original note in semitone steps. The **Note Fine** parameter fine-adjusts the pitch in cent steps. Matching the oscillator frequency with the note number produces a ring modulation effect in the correct key.

061: Detune

Using this effect, you can obtain a detune effect that offsets the pitch of the effect sound slightly from the pitch of the input signal. Compared to the chorus effect, a more natural sound thickness will be created.

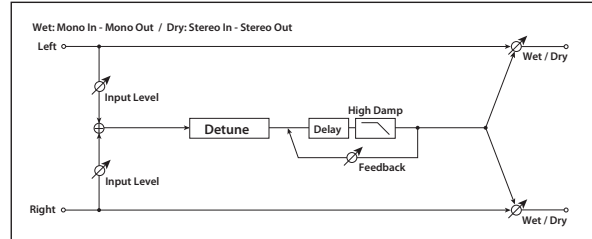

| | | | | |
|---|-----------------------|---------------------------|---|--|
| a | Pitch Shift [cent] | -100...+100 | Sets the pitch difference from the input signal | |
| | Src | Off...Tempo | Selects a modulation source for pitch shift | |
| | Amt | -100...+100 | Sets the modulation amount for pitch shift | |
| b | Delay Time [msec] | 0...1000 | Sets the delay time | |
| c | Feedback | -100...+100 | Sets the feedback amount | |
| d | High Damp [%] | 0...100 | Sets the damping amount in the high range | |
| | Input Level D-mod [%] | -100...+100 | Sets the modulation amount of the input level p.284 | |
| e | Src | Off...Tempo | Selects the modulation source for the input level p.284 | |
| | Wet/Dry | Dry, 1 : 99...99 : 1, Wet | Sets the balance between the effect and the dry input | |
| | Amt | -100...+100 | Sets the modulation amount for Wet/Dry | |

d: Input Level D-mod [%]

d: Src

This parameter sets the dynamic modulation of the input level.

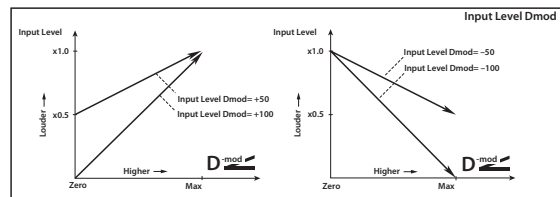

062: Pitch Shifter

This effect changes the pitch of the input signal. You can select from three types: Fast (quick response), Medium, and Slow (preserves tonal quality). You can also create an effect in which the pitch is gradually raised (or dropped) using the delay with feedback.

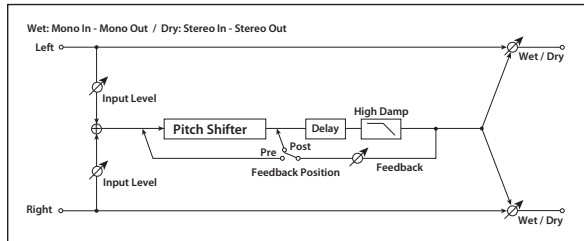

| | | | | |
|---|-----------------------|----------------------------|---|-------|
| a | Mode | Slow, Medium, Fast | Switches Pitch Shifter mode p.285 | |
| b | Pitch Shift [1/2tone] | -24...+24 | Sets the pitch shift amount by steps of a semitone p.285 | D-mod |
| | Src | Off...Tempo | Selects the modulation source of pitch shift amount p.285 | |
| c | Amt | -24...+24 | Sets the modulation amount of pitch shift amount p.285 | |
| | Fine [cent] | -100...+100 | Sets the pitch shift amount by steps of a cent p.285 | D-mod |
| d | Amt | -100...+100 | Sets the modulation amount of pitch shift amount p.285 | |
| | Delay Time [msec] | 0...2000 | Sets the delay time | |
| e | Feedback Position | Pre, Post | Switches the feedback connection p.285 | |
| f | Feedback | -100...+100 | Sets the feedback amount p.285 | |
| | High Damp [%] | 0...100 | Sets the damping amount in the high range | |
| g | Input Level D-mod [%] | -100...+100 | Sets the modulation amount of the input level p.284 | D-mod |
| | Src | Off...Tempo | Selects the modulation source for the input level p.284 | |
| h | Wet/Dry | Dry, 1 : 99... 99 : 1, Wet | Sets the balance between the effect and the dry input | D-mod |
| | Src | Off...Tempo | Selects a modulation source for Wet/Dry | |
| | Amt | -100...+100 | Sets the modulation amount for Wet/Dry | |

a: Mode

This parameter switches the pitch shifter operating mode. With Slow, tonal quality will not be changed too much. With Fast, the effect becomes a Pitch Shifter that has a quick response, but may change the tone. Medium is in-between these two. If you do not need to set too much pitch shift amount, set this parameter to Slow. If you wish to change the pitch significantly, use Fast.

b: Pitch Shift [1/2tone]

b: Src

b: Amt

c: Fine [cent]

c: Amt

The amount of pitch shift will use the value of the **Pitch Shift** plus the **Fine** value. The amount of modulation will use the b: Amt value plus the c: Amt.

The same Modulation Source is used for both **Pitch Shift** and **Fine**.

e: Feedback Position

f: Feedback

When **Feedback Position** is set to **Pre**, the pitch shifter output is again input to the pitch shifter. Therefore, if you specify a higher value for the Feedback parameter, the pitch

will be raised (or lowered) more and more each time feedback is repeated.

If **Feedback Position** is set to **Post**, the feedback signal will not pass through the pitch shifter again. Even if you specify a higher value for the **Feedback** parameter, the pitch-shifted sound will be repeated at the same pitch.

063: Pitch Shifter BPM

This pitch shifter enables you to set the delay time to match the song tempo.

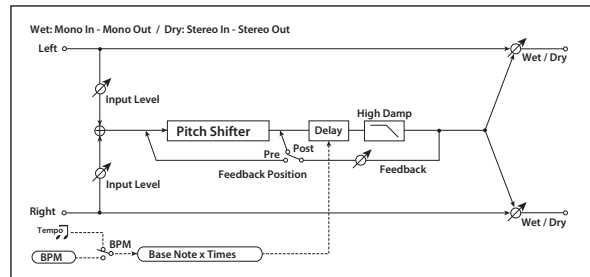

| | | | | |
|---|-----------------------|----------------------------|---|-------|
| a | Mode | Slow, Medium, Fast | Switches Pitch Shifter mode p.285 | |
| b | Pitch Shift [1/2tone] | -24...+24 | Sets the pitch shift amount in steps of a semitone p.285 | D-mod |
| | Src | Off...Tempo | Selects the modulation source of pitch shift amount p.285 | |
| c | Amt | -24...+24 | Sets the modulation amount of pitch shift amount p.285 | |
| | Fine [cent] | -100...+100 | Sets the pitch shift amount in steps of one cent p.285 | D-mod |
| d | Amt | -100...+100 | Sets the modulation amount of pitch shift amount p.285 | |
| | BPM | MIDI, 40.00... 300.00 | MIDI syncs to the system tempo; 40-300 sets the tempo manually for this individual effect p.285 | BPM |
| e | Time Over? | ---, OVER! | Displays an error message when the delay time exceeds the upper limit p.285 | |
| | Delay Base Note | | Selects the type of notes to specify the delay time p.285 | |
| f | Times | x1...x32 | Sets the number of notes to specify the delay time p.285 | |
| | Feedback Position | Pre, Post | Switches the feedback connection p.285 | |
| g | Feedback | -100...+100 | Sets the feedback amount p.285 | |
| | High Damp [%] | 0...100 | Sets the damping amount in the high range | |
| h | Input Level D-mod [%] | -100...+100 | Sets the modulation amount of the input level p.284 | D-mod |
| | Src | Off...Tempo | Selects the modulation source for the input level p.284 | |
| i | Wet/Dry | Dry, 1 : 99... 99 : 1, Wet | Sets the balance between the effect and the dry input | D-mod |
| | Src | Off...Tempo | Selects a modulation source for Wet/Dry | |
| | Amt | -100...+100 | Sets the modulation amount for Wet/Dry | |

d: BPM

e: Delay Base Note

e: Times

The delay time is the duration of **Times** number of **Delay Base Note** note values at the **BPM** tempo (or if **BPM** is set to MIDI, the tempo determined by MIDI Clock).

d: Time Over?

You can set the delay time up to 5,290msec. If the delay time exceeds this limit, the error message "OVER!" appears on the display. Set the delay time parameters so that this message will not appear. **Time Over?** is only a display parameter.

064: Pitch Shift Mod. (Pitch Shift Modulation)

This effect modulates the detuned pitch shift amount using an LFO, adding a clear spread and width to the sound by panning the effect sound and dry sound to the left and right. This is especially effective when the effect sound and dry sound output from stereo speakers are mixed.

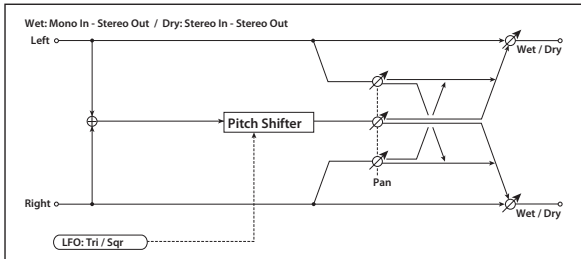

| | | | | |
|---|-------------------------|------------------------------|---|--|
| a | Pitch Shift [cent] | -100...+100 | Sets the pitch difference from the input signal p.286 | |
| b | LFO Waveform | Triangle, Square | Selects the LFO Waveform | |
| c | LFO Frequency [Hz] | 0.02...20.00 | Sets the speed of the LFO p.259 | |
| | Src | Off...Tempo | Selects a modulation source for LFO speed | |
| | Amt | -20.00...+20.00 | Sets the modulation amount of LFO speed | |
| d | MIDI Sync | Off, On | When this is on, the LFO speed is set by BPM, Base Note, and Times, instead of Frequency p.257 | |
| | BPM | MIDI, 40.00...300.00 | MIDI syncs to the system tempo; 40-300 sets the tempo manually for this individual effect p.257 | |
| | Base Note | | Selects the type of notes that specify the LFO speed p.257 | |
| | Times | x1...x32 | Sets the number of notes that specify the LFO speed p.257 | |
| e | LFO Type | Individual, Common1, Common2 | Selects either (individual) LFO, Common FX LFO1, or Common LFO2 p.257 | |
| | Common LFO Offset [deg] | -180...+180 | Sets the phase offset when Type = Common 1 or Common 2 p.257 | |
| f | Depth | -100...+100 | Sets the LFO modulation depth for pitch shift amount p.286 | |
| | Src | Off...Tempo | Selects the modulation source of the depth of modulation | |
| g | Pan | L, 1 : 99...99 : 1, R | Sets the panning effect sound and dry sound separately p.286 | |
| | Wet/Dry | Dry, 1 : 99...99 : 1, Wet | Sets the balance between the effect and the dry input p.286 | |
| h | Src | Off...Tempo | Selects a modulation source for Wet/Dry | |
| | Amt | -100...+100 | Sets the modulation amount for Wet/Dry | |

a: Pitch Shift [cent]

f: Depth

These parameters set the amount of pitch shift and amount of modulation by means of the LFO.

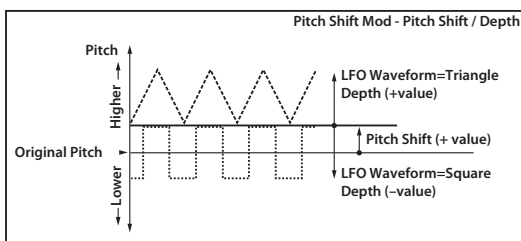

g: Pan

h: Wet/Dry

The Pan parameter pans the effect sound and dry sound to the left and right. With L, the effect sound is panned left, and the dry sound is panned right. With a Wet/Dry = Wet setting, the effect and dry sound will be output in a proportion of 1:1.

065: Organ Vib/Chorus (Organ Vibrato/Chorus)

This effect simulates the chorus and vibrato circuitry of a vintage organ. The modulation speed and depth can be customized.

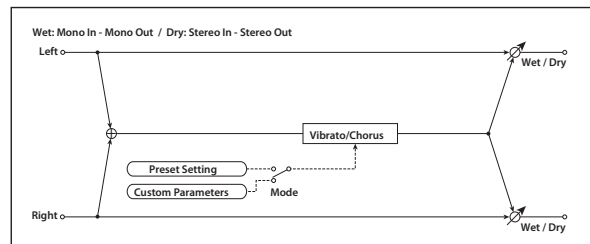

| | | | | |
|---|-------------------|------------------------------|--|--|
| a | Input Trim | 0...100 | Sets the input level | |
| b | Control Mode | Preset, Custom | Selects either preset or custom settings p.286 | |
| c | Preset Type | V1, C1, V2, C2, V3, C3 | Selects the effect type when Mode=Preset V1/V2/V3 are variations of vibrato, and C1/C2/C3 are variations of chorus p.286 | |
| | Src | Off...Tempo | Selects the modulation source that will change the effect type | |
| | Amt | -5...+5 | Sets the modulation amount for changing the effect type p.287 | |
| d | Custom Mix | Vibrato, 1:99...99:1, Chorus | Sets the mix level of the direct sound when Mode=Preset p.286 | |
| | Src | Off...Tempo | Selects the modulation source that will control the mix level of the direct sound | |
| e | Custom Depth | 0...100 | Sets the vibrato depth p.286 | |
| | Amt | -100...+100 | Sets the modulation amount for controlling the mix level of the direct sound | |
| f | Custom Speed [Hz] | 0.02...20.00 | Sets the vibrato speed p.286 | |
| | Src | Off...Tempo | Selects the modulation source for controlling the vibrato speed | |
| | Amt | -20.00...+20.00 | Sets the modulation amount for controlling the vibrato speed | |
| g | Wet/Dry | Dry, 1 : 99...99 : 1, Wet | Sets the balance between the effect and the dry input | |
| | Src | Off...Tempo | Selects a modulation source for Wet/Dry | |
| | Amt | -100...+100 | Sets the modulation amount for Wet/Dry | |

b: Control Mode

c: Preset Type

d: Custom Mix

e: Custom Depth

f: Custom Speed [Hz]

If Control Mode=Preset, you can use c: Preset Type to select the effect. In this case, the Custom Mix/Depth/Speed settings are ignored. If Control Mode=Custom, the Custom Mix/

Depth/Speed settings are valid, and the c: Preset Type setting is ignored.

c: Amt

If Preset Type=V1 and Src=JS+Y, you can set this to +5 and move JS +Y to control the effect in the order of V1→C1→V2→C2→V3→C3.

066: Rotary Speaker

This effect simulates a rotary speaker, and obtains a more realistic sound by simulating the rotor in the low range and the horn in the high range separately. The effect also simulates the stereo microphone settings.

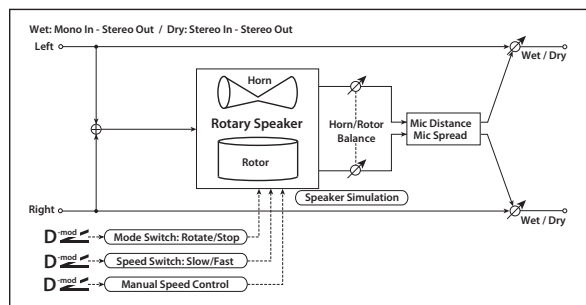

| | | | | |
|---|--------------------|----------------------------|--|-------|
| a | Mode Switch | Rotate, Stop | Switches between speaker rotation and stop | D mod |
| | Src | Off...Tempo | Selects a modulation source for Rotate/Stop | |
| | Sw | Toggle, Moment | Sets the switch mode for Rotate/Stop modulation p.287 | |
| b | Speed Switch | Slow, Fast | Switches the speaker rotation speed between slow and fast p.287 | D mod |
| | Src | Off...Tempo | Selects a modulation source for Slow/Fast | |
| | Sw | Toggle, Moment | Sets the switch mode for Slow/Fast modulation p.287 | |
| c | Manual Speed Ctrl | Off...Tempo | Sets a modulation source for direct control of rotation speed p.287 | D mod |
| d | Horn Acceleration | 0...100 | How quickly the horn rotation speed in the high range is switched p.287 | |
| | Horn Ratio | Stop, 0.50...2.00 | Adjusts the (high-range side) horn rotation speed. Standard value is 1.00. Selecting "Stop" will stop the rotation | |
| e | Rotor Acceleration | 0...100 | Determines how quickly the rotor rotation speed in the low range is switched p.287 | |
| | Rotor Ratio | Stop, 0.50...2.00 | Adjusts the (low-frequency) rotor speed. Standard value is 1.00. Selecting "Stop" will stop the rotation | |
| f | Horn/Rotor Balance | Rotor, 1...99, Horn | Sets the level balance between the high-frequency horn and low-frequency rotor | |
| g | Mic Distance | 0...100 | Sets the distance between the microphone and rotary speaker p.287 | |
| | Mic Spread | 0...100 | Sets the angle of left and right microphones p.287 | |
| h | Wet/Dry | Dry, 1 : 99... 99 : 1, Wet | Sets the balance between the effect and the dry input | D mod |
| | Src | Off...Tempo | Selects a modulation source for Wet/Dry | |
| | Amt | -100...+100 | Sets the modulation amount for Wet/Dry | |

a: Sw

This parameter sets how the modulation source switches between rotation and stop.

When Sw = **Toggle**, the speaker rotates or stops alternately each time you press the pedal or move the joystick. Via MIDI, rotation will switch between start and stop each time the modulation amount exceeds 64.

When Sw = **Moment**, the speaker rotates by default, and stops only when you press the pedal or move the joystick. Via MIDI, modulation values above 64 make the speaker rotate, and values below 64 make it stop.

b: Speed Switch

This parameter controls how the rotation speed (slow and fast) is switched via the modulation source.

When Sw = **Toggle**, the speed will switch between slow and fast each time you press the pedal or move the joystick. Via MIDI, the speed will switch each time the modulation amount exceeds 64.

When Sw = **Moment**, the speed is usually slow. It becomes fast only when you press the pedal or move the joystick. Via MIDI, modulation values above 64 set the speed to **Fast**, and values below 64 set it to **Slow**.

c: Manual Speed Ctrl

If you wish to control the rotation speed manually, instead of switching between Slow and Fast, select a modulation source in the **Manual Speed Ctrl** parameter. If you don't want to use manual control, set this to **Off**.

d: Horn Acceleration

e: Rotor Acceleration

On a real rotary speaker, the rotation speed accelerates or decelerates gradually after you switch the speed. The **Horn** and **Rotor Acceleration** parameters set the transition times between fast and slow speeds.

g: Mic Distance



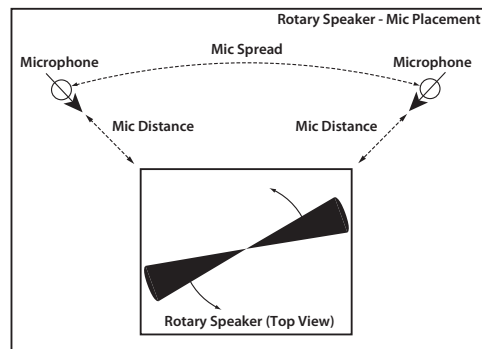

g: Mic Spread

This is a simulation of stereo microphone settings.



067: St.EP Tone+Trml (Stereo EP Tone+Tremolo)

This faithfully simulates the preamp section and vibrato (tremolo) effect from a famous model of fine-type electric piano.

| | | | | |
|---|-------------------|-------------------------------|--|---|
| a | Volume | 0...100 | Sets the volume level of the preamp | |
| b | Treble | -10.0...+10.0 | Sets the high-frequency boost or cut. | |
| c | Bass | -10.0...+10.0 | This controls the low-frequency boost or cut. | |
| d | Vibrato Switch | On, Off | Switches Vibrato on/off |  |
| | Src | Off...Tempo | Selects a modulation source for Vibrato on/off | |
| | Sw | Toggle, Moment | Selects the switching mode for the modulation source that switches the Vibrato on and off p.288 | |
| e | Vibrato Intensity | 1...100 | Sets the intensity of LFO modulation |  |
| | Src | Off...Tempo | Selects a modulation source for Intensity | |
| | Amt | -100...+100 | Sets the modulation amount for Intensity | |
| f | Vibrato Speed | 00.0...100 | Sets the LFO speed |  |
| | Src | Off...Tempo | Selects a modulation source for Speed | |
| | Amt | -100...+100 | Sets the modulation amount for Speed | |
| g | Wet/Dry | Dry, 1 : 99... 99 : 1, Wet | Sets the balance between the effect and the dry input |  |
| | Src | Off...Tempo | Selects a modulation source for Wet/Dry | |
| | Amt | -100...+100 | Sets the modulation amount for Wet/Dry | |

d: Sw

When this is set to **Toggle**, the **Vibrato Switch** will alternate between on and off. For instance, if vibrato is off, and **Src** is assigned to a footswitch, the first press will turn on the Vibrato, and the next press will turn it off again.

Momentary means that the change happens only while the controller is enabled. Continuing the example from above, when the footswitch is pressed down, the Vibrato will turn on; when the footswitch is released, the Vibrato will turn off again.

Src lets you switch to the opposite of the programmed setting. For instance, if vibrato is on, and the **Sw** is set to Moment, then pressing down on the footswitch would turn off the Vibrato.

If you set modulation source to use a continuous controller, such as the Joystick, values of 0-63 are as if the switch was off, and values of 64-127 are as if the switch was on.

Finally - note that the assignable switches, SW1 and SW2, can themselves be set to either moment or toggle modes, and these settings are reflected by the switch LEDs. Individual parameter settings, such as the vibrato on/off and **Sw**, do not affect the LEDs.

So, if you're using SW1 or SW2 as the modulation source, it's best to set the **Sw** to Moment, and then just let the switch itself determine the momentary/toggle behavior.

Delay

068: L/C/R Delay

This multitap delay outputs three Tap signals to the left, right, and center respectively. You can also adjust the left and right spread of the delay sound.

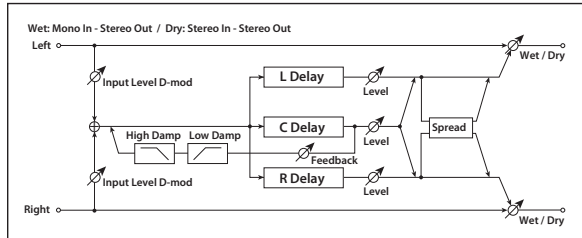

| | | | | |
|---|-----------------------|----------------------------|---|------------------|
| a | L Delay Time [msec] | 0...2730 | Sets the delay time of TapL | |
| | Level | 0...50 | Sets the output level of TapL | |
| b | C Delay Time [msec] | 0...2730 | Sets the delay time of TapC | |
| | Level | 0...50 | Sets the output level of TapC | |
| c | R Delay Time [msec] | 0...2730 | Sets the delay time of TapR | |
| | Level | 0...50 | Sets the output level of TapR | |
| d | Feedback (C Delay) | -100...+100 | Sets the feedback amount of TapC | D ^{mod} |
| | Src | Off...Tempo | Selects the modulation source of the TapC feedback amount | |
| | Amt | -100...+100 | Sets the modulation amount of the TapC feedback amount | |
| e | High Damp [%] | 0...100 | Sets the damping amount in the high range | p.289 |
| | Low Damp [%] | 0...100 | Sets the damping amount in the low range | p.289 |
| f | Input Level D-mod [%] | -100...+100 | Sets the modulation amount of the input level | D ^{mod} |
| | Src | Off...Tempo | Selects the modulation source for the input level | p.284 |
| g | Spread | 0...50 | Sets the width of the stereo image of the effect sound | p.289 |
| h | Wet/Dry | Dry, 1 : 99... 99 : 1, Wet | Sets the balance between the effect and the dry input | D ^{mod} |
| | Src | Off...Tempo | Selects a modulation source for Wet/Dry | |
| | Amt | -100...+100 | Sets the modulation amount for Wet/Dry | |

e: High Damp [%]

e: Low Damp [%]

These parameters set the damping amount of high range and low range. The tone of the delayed sound becomes darker and lighter as it feeds back.

g: Spread

This parameter sets the pan width of the effect sound. The stereo image is widest with a value of 50, and the effect sound of both channels is output from the center with a value of 0.

069: Stereo/CrossDelay

This is a stereo delay, and can be used as a cross-feedback delay effect in which the delay sounds cross over between the left and right by changing the feedback routing.

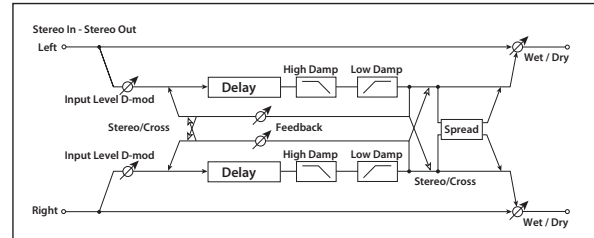

| | | | | |
|---|-----------------------|----------------------------|--|------------------|
| a | Stereo/Cross | Stereo, Cross | Switches between stereo delay and cross-feedback delay | |
| b | L Delay Time [msec] | 0.0...1360.0 | Sets the delay time for the left channel | |
| c | R Delay Time [msec] | 0.0...1360.0 | Sets the delay time for the right channel | |
| d | L Feedback | -100...+100 | Sets the feedback amount for the left channel | D ^{mod} |
| | Src | Off...Tempo | Selects the modulation source of feedback amount | |
| e | Amt L | -100...+100 | Sets the modulation amount of the left channel feedback | |
| | R Feedback | -100...+100 | Sets the feedback amount for the right channel | D ^{mod} |
| f | Amt R | -100...+100 | Sets the modulation amount of the right channel feedback | |
| | High Damp [%] | 0...100 | Sets the damping amount in the high range | p.289 |
| g | Low Damp [%] | 0...100 | Sets the damping amount in the low range | p.289 |
| h | Input Level D-mod [%] | -100...+100 | Sets the modulation amount of the input level | D ^{mod} |
| | Src | Off...Tempo | Selects the modulation source for the input level | p.284 |
| i | Spread | -50...+50 | Sets the width of the stereo image of the effect sound | p.289 |
| j | Wet/Dry | Dry, 1 : 99... 99 : 1, Wet | Sets the balance between the effect and the dry input | D ^{mod} |
| | Src | Off...Tempo | Selects a modulation source for Wet/Dry | |
| | Amt | -100...+100 | Sets the modulation amount for Wet/Dry | |

070: St. Multitap Delay (Stereo Multitap Delay)

The left and right Multitap Delays have two taps respectively. Changing the routing of feedback and tap output allows you to create various patterns of complex effect sounds.

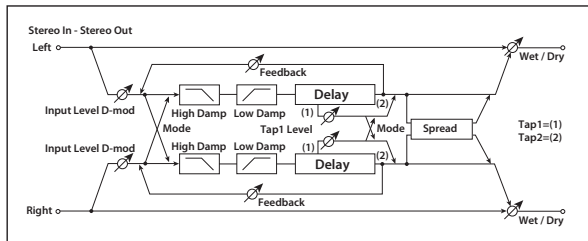

| | | | | |
|---|-----------------------|--|--|--|
| a | Mode | Normal, Cross Feedback, Cross Pan1, Cross Pan2 | Switches the left and right delay routing p.290 | |
| b | Tap1 Time [msec] | 0.0...1360.0 | Sets the Tap1 delay time | |
| c | Tap2 Time [msec] | 0.0...1360.0 | Sets the Tap2 delay time | |
| d | Tap1 Level | 0...100 | Sets the Tap1 output level p.290 | |
| e | Feedback (Tap2) | -100...+100 | Sets the Tap2 feedback amount | |
| | Src | Off...Tempo | Selects the modulation source of the Tap2 feedback amount | |
| f | Amt | -100...+100 | Sets the modulation amount of the Tap2 feedback amount | |
| | High Damp [%] | 0...100 | Sets the damping amount in the high range p.289 | |
| g | Low Damp [%] | 0...100 | Sets the damping amount in the low range p.289 | |
| h | Input Level D-mod [%] | -100...+100 | Sets the modulation amount of the input level p.284 | |
| | Src | Off...Tempo | Selects the modulation source for the input level p.284 | |
| i | Spread | -100...+100 | Sets the width of the stereo image of the effect sound p.289 | |
| | Src | Off...Tempo | Selects the modulation source of the effect sound's stereo image width | |
| | Amt | -100...+100 | Sets the modulation amount of the effect sound's stereo image width | |
| j | Wet/Dry | Dry, 1 : 99... 99 : 1, Wet | Sets the balance between the effect and the dry input | |
| | Src | Off...Tempo | Selects a modulation source for Wet/Dry | |
| | Amt | -100...+100 | Sets the modulation amount for Wet/Dry | |

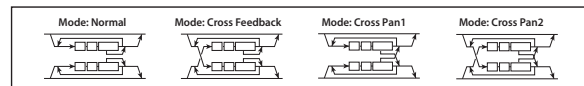

a: Mode

You can change how the left and right delay signals are panned by modifying the routing of the left and right delay as shown in the figure above. You need to input different sounds to each channel in order for this parameter to be effective.

d: Tap1 Level

This parameter sets the output level of Tap1. Setting a different level from Tap2 will add a unique touch to a monotonous delay and feedback.

071: St. Mod Delay (Stereo Modulation Delay)

This stereo delay uses an LFO to sweep the delay time. The pitch also varies, creating a delay sound which swells and shimmers. You can also control the delay time using a modulation source.

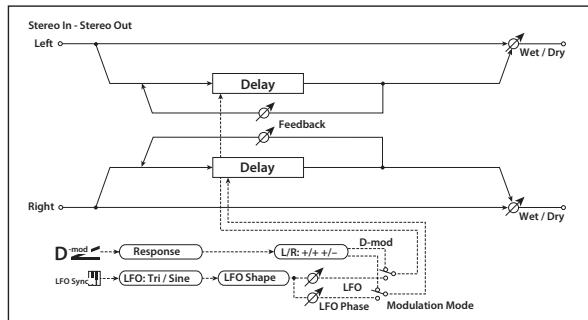

| | | | | |
|---|-------------------------|------------------------------|---|--|
| a | Modulation Mode | LFO, D-mod | Switches between LFO modulation control and modulation source control | |
| b | D-mod Modulation | L/R: +/+, L/R: +/- | Reversed L/R control by modulation source p.291 | |
| | Src | Off...Tempo | Selects the modulation source that controls delay time | |
| c | Response | 0...30 | Sets the rate of response to the modulation source | |
| | LFO Waveform | Triangle, Sine | Selects the LFO Waveform | |
| d | LFO Shape | -100...+100 | Changes the curvature of the LFO Waveform p.258 | |
| | LFO D-mod Sync | Off, On | Switches LFO reset off/on p.291 | |
| e | Src | Off...Tempo | Selects the modulation source that resets the LFO | |
| | LFO Frequency [Hz] | 0.02...20.00 | Sets the speed of the LFO p.259 | |
| f | MIDI Sync | Off, On | When this is on, the LFO speed is set by BPM, Base Note, and Times, instead of Frequency p.257 | |
| | BPM | MIDI, 40.00... 300.00 | MIDI syncs to the system tempo; 40-300 sets the tempo manually for this individual effect p.257 | |
| | Base Note | | Selects the type of notes that specify the LFO speed p.257 | |
| | Times | x1...x32 | Sets the number of notes that specify the LFO speed p.257 | |
| g | LFO Type | Individual, Common1, Common2 | Selects either (individual) LFO, Common FX LFO1, or Common LFO2 p.257 | |
| | Common LFO Offset [deg] | -180...+180 | Sets the phase offset when Type = Common 1 or Common 2 p.257 | |
| h | L LFO Phase [deg] | -180...+180 | Sets the phase obtained when the left LFO is reset p.291 | |
| | L Depth | 0...200 | Sets the depth of the left LFO modulation | |
| i | R LFO Phase [deg] | -180...+180 | Sets the phase obtained when the right LFO is reset p.291 | |
| | R Depth | 0...200 | Sets the depth of the right LFO modulation | |
| j | L Delay Time [msec] | 0.0...1000.0 | Sets the delay time for the left channel | |
| | L Feedback | -100...+100 | Sets the feedback amount of left delay | |
| k | R Delay Time [msec] | 0.0...1000.0 | Sets the delay time for the right channel | |
| | R Feedback | -100...+100 | Sets the feedback amount of right delay | |

| | | | | |
|---|---------|--|--|------------------|
| 1 | Wet/Dry | –Wet... –1 : 99, Dry, 1 : 99...Wet | Sets the balance between the effect and the dry input p.259 | D ^{mod} |
| | Src | Off...Tempo | Selects a modulation source for Wet/Dry | |
| | Amt | –100...+100 | Sets the modulation amount for Wet/Dry | |

b: D-mod Modulation

When the modulation source is used for control, this parameter reverses the left and right modulation direction.

d: LFO D-mod Sync

d: Src

h: L LFO Phase [deg]

i: R LFO Phase [deg]

If **LFO D-mod Sync** is On, the LFO will be reset by the modulation source that is received.

The **Src** parameter sets the modulation source that resets the LFO. For example, you can assign Gate as a modulation source so that the sweep always starts from the specified point.

L LFO Phase and **R LFO Phase** set the phase obtained when the left and right LFOs are reset. In this way, you can create changes in pitch sweep for the left and right channels individually.

MIDI The effect is off when a value of the modulation source specified in the **Src** parameter is 63 or smaller, and the effect is on when the value is 64 or higher. The LFO is triggered and reset to the **L LFO Phase** and **R LFO Phase** settings when the value changes from 63 or smaller to 64 or higher.

072: St. Dynamic Delay (Stereo Dynamic Delay)

This stereo delay controls the level of delay according to the input signal level. You can use this as a ducking delay that applies delay to the sound only when you play keys at a high velocity or only when the volume level is low.

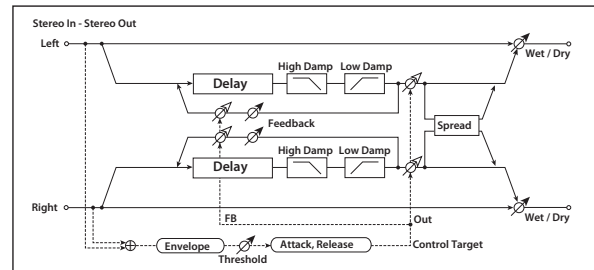

| | | | | |
|---|---------------------|---------------------------------|---|------------------|
| a | Control Target | None, Out, FB | Selects from no control, output, and feedback p.291 | D ^{mod} |
| | Polarity | +, – | Reverses level control p.291 | |
| b | Threshold | 0...100 | Sets the level to which the effect is applied p.291 | |
| | Offset | 0...100 | Sets the offset of level control p.291 | |
| c | Attack | 1...100 | Sets the attack time of level control p.291 | |
| d | Release | 1...100 | Sets the release time of level control p.291 | |
| e | L Delay Time [msec] | 0.0...1360.0 | Sets the delay time for the left channel | |
| f | R Delay Time [msec] | 0.0...1360.0 | Sets the delay time for the right channel | |
| g | Feedback | –100...+100 | Sets the feedback amount | |
| h | High Damp [%] | 0...100 | Sets the damping amount in the high range p.289 | |
| | Low Damp [%] | 0...100 | Sets the damping amount in the low range p.289 | |
| i | Spread | –100...+100 | Sets the width of the stereo image of the effect sound p.289 | |
| j | Wet/Dry | Dry, 1 : 99...99 : 1, Wet | Sets the balance between the effect and the dry input | D ^{mod} |
| | Src | Off...Tempo | Selects a modulation source for Wet/Dry | |
| | Amt | –100...+100 | Sets the modulation amount for Wet/Dry | |

a: Control Target

This parameter selects no level control, delay output control (effect balance), or feedback amount control.

a: Polarity

b: Threshold

b: Offset

c: Attack

d: Release

The **Offset** parameter specifies the value for the **Control Target** parameter (that is set to None), expressed as the ratio relative to the parameter value (the **Wet/Dry** value with **Control Target** = Output Level, or the **Feedback** value with **Control Target** = Feedback).

When **Polarity** is positive, the **Control Target** value is obtained by multiplying the parameter value by the **Offset** value (if the input level is below the threshold), or equals the parameter value if the input level exceeds the threshold.

When **Polarity** is negative, **Control Target** value equals the parameter value if the input level is below the threshold, or is obtained by multiplying the parameter value by the **Offset** value if the level exceeds the threshold.

The **Attack** and **Release** parameters specify attack time and release time of delay level control.

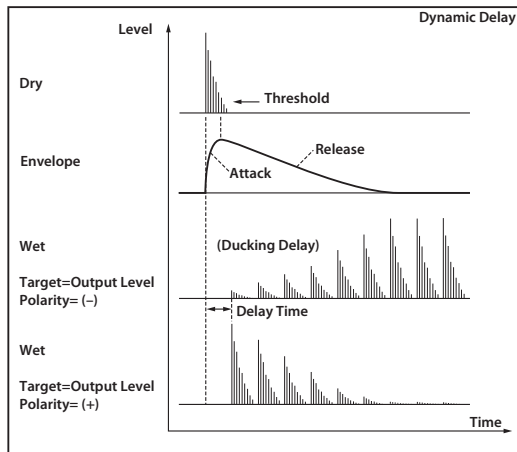

073: St. AutoPanningDly (Stereo Auto Panning Delay)

This stereo delay effect pans the delay sound left and right using the LFO.

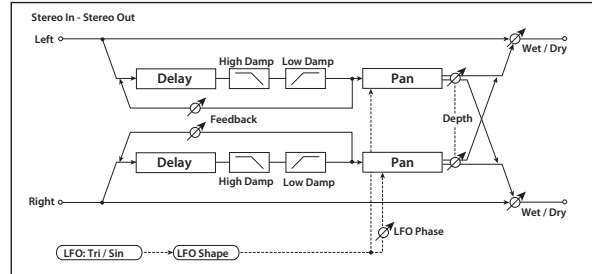

| | | | | |
|---|-------------------------|------------------------------|---|--|
| a | L Delay Time [msec] | 0.0...1360.0 | Sets the delay time for the left channel | |
| | L Feedback | -100...+100 | Sets the feedback amount for the left channel | |
| b | R Delay Time [msec] | 0.0...1360.0 | Sets the delay time for the right channel | |
| | R Feedback | -100...+100 | Sets the feedback amount for the right channel | |
| c | High Damp [%] | 0...100 | Sets the damping amount in the high range p.289 | |
| | Low Damp [%] | 0...100 | Sets the damping amount in the low range p.289 | |
| d | LFO Waveform | Triangle, Sine | Selects the LFO Waveform | |
| | LFO Shape | -100...+100 | Changes the curvature of the LFO Waveform p.258 | |
| e | Phase [degree] | -180...+180 | Sets the LFO phase difference between the left and right p.282 | |
| f | Panning Frequency [Hz] | 0.02...20.00 | Sets the panning speed | |
| g | MIDI Sync | Off, On | Switches between using the frequency of the panning speed and using the tempo and notes p.257 | |
| | BPM | MIDI, 40.00...300.00 | MIDI syncs to the system tempo; 40-300 sets the tempo manually for this individual effect p.257 | |
| | Base Note | | Selects the type of notes to specify the delay time for the panning speed p.257 | |
| | Times | x1...x32 | Sets the number of notes to specify the delay time for the panning speed p.257 | |
| h | LFO Type | Individual, Common1, Common2 | Selects either (individual) LFO, Common FX LFO1, or Common LFO2 p.257 | |
| | Common LFO Offset [deg] | -180...+180 | Sets the phase offset when Type = Common 1 or Common 2 p.257 | |
| i | Panning Depth | 0...100 | Sets the panning width | |
| | Src | Off...Tempo | Selects the modulation source for the panning width | |
| | Amt | -100...+100 | Set the modulation amount of the panning width | |
| j | Wet/Dry | Dry, 1 : 99... 99 : 1, Wet | Sets the balance between the effect and the dry input | |
| | Src | Off...Tempo | Selects a modulation source for Wet/Dry | |
| | Amt | -100...+100 | Sets the modulation amount for Wet/Dry | |

074: Echo Plus

This models a famous analog tape echo unit. On the original device, “echo” was created by a playback head, and the “delay time” was specified by adjusting the speed of the motor. The warmth and subtlety of the echoes it generated made this “lo-fi” unit a favorite with many pro musicians.

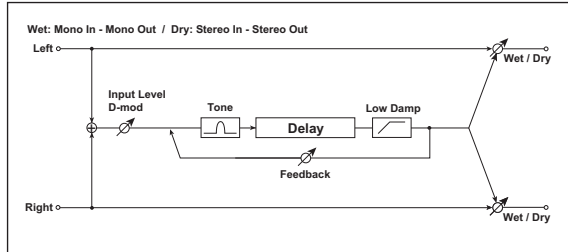

| | | | | |
|---|-----------------------|----------------------------|---|-------|
| a | Time [ms] | 0...2700 | Sets the delay time | D-mod |
| | Src | Off...Tempo | Selects the modulation source of Time [ms] | |
| | Amt | -100...+100 | Sets the amount for Time [ms] | |
| b | Feedback | 0...100 | Sets the amount of feedback | D-mod |
| | Src | Off...Tempo | Selects the modulation source of Feedback | |
| | Amt | -100...+100 | Sets the amount of Feedback | |
| c | Tone | 1...100 | Sets the tone of the delay sound | |
| d | Low Damp [%] | 0...100 | Sets the damping amount in the low range | |
| | | | p.289 | |
| e | Input Level D-mod [%] | -100...+100 | Sets the modulation amount of the input level | D-mod |
| | Input Level Mod Src | Off...Tempo | Selects the modulation source for the input level | |
| f | Wet/Dry | Dry, 1 : 99... 99 : 1, Wet | Sets the balance between the effect and the dry input | D-mod |
| | Src | Off...Tempo | Selects a modulation source for Wet/Dry | |
| | Amt | -100...+100 | Sets the modulation amount for Wet/Dry | |

| | | | | |
|---|-------------------|---------------------------|--|-------|
| e | Tap2 Level | 0...100 | Sets the Tap2 output level | |
| | Pan | L, 1...99, R | Sets the stereo image of tap2 | |
| | Feedback Amt | -100...+100 | Sets the Tap2 feedback amount | p.293 |
| f | Tap3 Level | 0...100 | Sets the Tap3 output level | |
| | Pan | L, 1...99, R | Sets the stereo image of tap3 | |
| | Feedback Amt | -100...+100 | Sets the Tap3 feedback amount | p.293 |
| g | Feedback | 0...100 | Sets the amount of feedback for Taps 1, 2, and 3 | D-mod |
| | Src | Off...Tempo | Selects the modulation source of feedback amount | |
| | Amt | -100...+100 | Sets the feedback amount | |
| h | High Damp [%] | 0...100 | Sets the damping amount in the high range | |
| | Low Damp [%] | 0...100 | Sets the damping amount in the low range | |
| i | Saturation | 0...100 | Sets the distortion amount | |
| j | Input Trim | 0...100 | Sets the input gain | |
| | Pre Tone | 0...100 | Sets the tone of the input | |
| k | Wow Flutter [Hz] | 0.02...1.00 | Sets the frequency at which pitch variation will occur | |
| | Wow Flutter depth | 0...100 | Sets the depth of pitch variation | |
| l | Wet/Dry | Dry, 1 : 99...99 : 1, Wet | Sets the balance between the effect and the dry input | D-mod |
| | Src | Off...Tempo | Selects a modulation source for Wet/Dry | |
| | Amt | -100...+100 | Sets the modulation amount for Wet/Dry | |

a: Delay (Tap1) [msec]

a: Src

a: Amt

b: Tap2 Position [%]

b: Tap3 Position [%]

The delay time for Tap 2 and 3 is specified as a proportion (%) relative to **Delay (Tap1)**. Even if you use dynamic modulation to control **Delay (Tap1)**, Tap 2 and 3 will change at the same proportion.

d: Feedback Amt

e: Feedback Amt

f: Feedback Amt

g: Feedback

The feedback output from Tap 1, 2, and 3 is mixed according to the **Feedback Amt**, and then the final amount of feedback is specified by **Feedback**.

075: Tape Echo

This effect simulates a tape echo unit with three playback heads. The distortion and tonal change typical of magnetic tape are also reproduced.

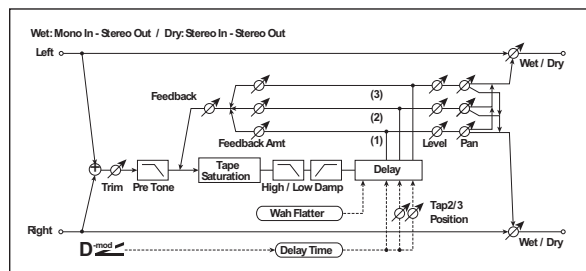

| | | | | | |
|---|---------------------|----------------|--|-------|-------|
| a | Delay (Tap1) [msec] | 0...2700 | Sets the delay time (tap1) | p.293 | D-mod |
| | Src | Off...Tempo | Selects the modulation source of the delay time | p.293 | |
| | Amt | -2700... +2700 | Sets the modulation amount of delay time | p.293 | |
| b | Tap2 Position [%] | 0...100 | Sets the position of Tap 2 relative to the Tap 1 delay time the depth of pitch variation | p.293 | |
| c | Tap3 Position [%] | 0...100 | Sets the position of Tap 3 relative to the Tap 1 delay time the depth of pitch variation | p.293 | |
| d | Tap1 Level | 0...100 | Sets the Tap1 output level | | |
| | Pan | L, 1...99, R | Sets the stereo image of tap1 | | |
| | Feedback Amt | -100...+100 | Sets the Tap1 feedback amount | p.293 | |

076: Auto Reverse

This effect records the input signal and automatically plays it in reverse (the effect is similar to a tape reverse sound).

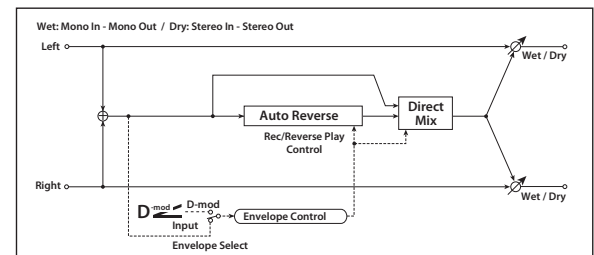

| | | | | | |
|---|---------------------|---------------|---|-------|--|
| a | Rec Mode | Single, Multi | Sets the recording mode | p.294 | |
| b | Reverse Time [msec] | 20...2640 | Sets the maximum duration of the reverse playback | p.294 | |

| | | | | |
|---|-----------------|-----------------------------------|--|------------------|
| c | Envelope Select | D-mod, Input | Selects whether the start and end of recording is controlled via the modulation source or the input signal level p.294 | |
| | Src | Off...Tempo | Selects the modulation source that controls recording when Envelope Select is set to D-mod p.294 | D ^{mod} |
| d | Threshold | 0...100 | Sets the recording start level when Envelope Select is set to Input p.294 | |
| e | Response | 0...100 | Sets the speed of the response to the end of recording p.280 | |
| f | Direct Mix | Always On, Always Off, Cross Fade | Selects how a dry sound is mixed p.280 | |
| g | Wet/Dry | Dry, 1 : 99... 99 : 1, Wet | Selects the balance between the effect and the dry input | D ^{mod} |
| | Src | Off...Tempo | Selects a modulation source for Wet/Dry | |
| | Amt | -100...+100 | Sets the modulation amount for Wet/Dry | |

a: Rec Mode

b: Reverse Time [msec]

When **Rec Mode** is set to Single, you can set up to 2,640msec for **Reverse Time**. If recording starts during the reverse playback, the playback will be interrupted.

When **Rec Mode** is set to Multi, you can make another recording during the reverse playback. However, the maximum Reverse Time is limited to 1,320msec.

If you wish to record a phrase or rhythm pattern, set **Rec Mode** to Single. If you record only one note, set **Rec Mode** to Multi.

The **Reverse Time** parameter specifies the maximum duration of the reverse playback. The part in excess of this limit will not be played in reverse. If you wish to add short pieces of the reverse playback of single notes, make the **Reverse Time** shorter.

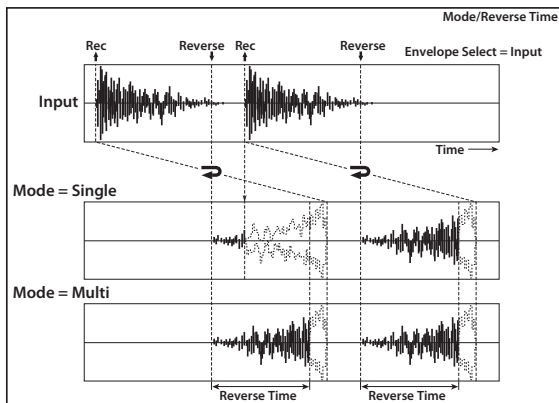

c: Envelope Select

c: Src

d: Threshold

These parameters select the source to control the start and end of recording.

When **Envelope Select** is set to D-mod, the input signal will be recorded only when the value of the modulation source selected by the Src parameter is 64 or higher.

When **Envelope Select** is set to Input, the input signal will be recorded only when its level exceeds the Threshold level.

When recording is completed, reverse playback starts immediately.

077: Sequence BPM Dly (Sequence BPM Delay)

This four-tap delay enables you to select a tempo and rhythm pattern to set up each tap.

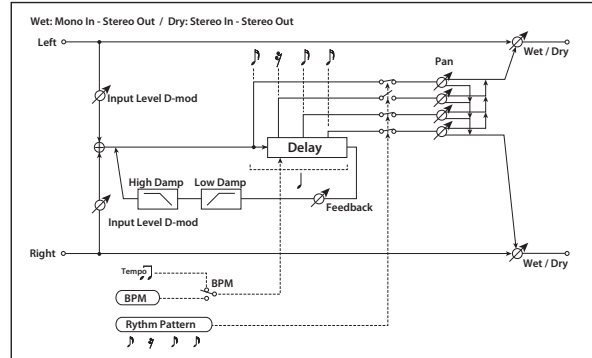

| | | | | |
|---|-----------------------|----------------------------|---|------------------|
| a | BPM | MIDI, 40.00... 300.00 | MIDI syncs to the system tempo; 40-300 sets the tempo manually for this individual effect p.294 | BPM |
| b | Rhythm Pattern | | Selects a rhythm pattern p.294 | BPM |
| c | Tap1 Pan | L, 1...99, R | Sets the panning of Tap1 | |
| | Tap2 Pan | L, 1...99, R | Sets the panning of Tap2 | |
| | Tap3 Pan | L, 1...99, R | Sets the panning of Tap3 | |
| | Tap4 Pan | L, 1...99, R | Sets the panning of Tap4 | |
| d | Feedback | -100...+100 | Sets the feedback amount | D ^{mod} |
| | Src | Off...Tempo | Selects the modulation source of feedback amount | |
| | Amt | -100...+100 | Sets the feedback amount | |
| e | High Damp [%] | 0...100 | Sets the damping amount in the high range p.289 | |
| | Low Damp [%] | 0...100 | Sets the damping amount in the low range p.289 | |
| f | Input Level D-mod [%] | -100...+100 | Sets the modulation amount of the input level p.284 | D ^{mod} |
| | Src | Off...Tempo | Selects the modulation source for the input level p.284 | |
| g | Wet/Dry | Dry, 1 : 99... 99 : 1, Wet | Selects the balance between the effect and the dry input | D ^{mod} |
| | Src | Off...Tempo | Selects a modulation source for Wet/Dry | |
| | Amt | -100...+100 | Sets the modulation amount for Wet/Dry | |

a: BPM

b: Rhythm Pattern

With the tempo specified by the **BPM** parameter (or the MIDI Clock tempo if **BPM** is set to MIDI), the length of one beat equals the feedback delay time, and the interval between taps becomes equal. Selecting a rhythm pattern will automatically turn the tap outputs on and off. When **BPM** is set to MIDI, the lower limit of the **BPM** is 44.

078: L/C/R BPM Delay

The L/C/R delay enables you to match the delay time with the song tempo. You can also synchronize the delay time with the arpeggiator or sequencer. If you program the tempo before performance, you can achieve a delay effect that synchronizes with the song in real-time. Delay time is set by notes.

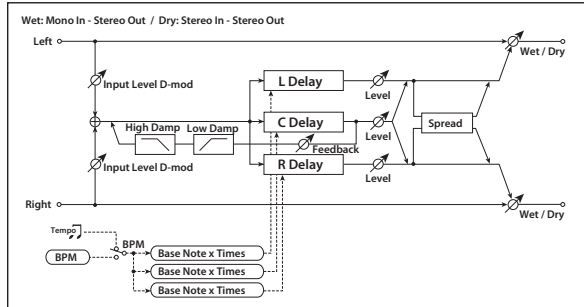

| | | | | |
|---|-----------------------|-------------------------------|---|--|
| a | BPM | MIDI, 40.00... 300.00 | MIDI syncs to the system tempo; 40–300 sets the tempo manually for this individual effect p.285 | |
| | Time Over? | ---, OVER! | Displays an error message when the delay time exceeds the upper limit p.295 | |
| b | L Delay Base Note | | Selects the type of notes to specify the delay time for TapL p.285 | |
| | Times | x1...x32 | Sets the number of notes to specify the delay time for TapL p.285 | |
| | Level | 0...50 | Sets the output level of TapL | |
| c | C Delay Base Note | | Selects the type of notes to specify the delay time for TapC p.285 | |
| | Times | x1...x32 | Sets the number of notes to specify the delay time for TapC p.285 | |
| | Level | 0...50 | Sets the output level of TapC | |
| d | R Delay Base Note | | Selects the type of notes to specify the delay time for TapR p.285 | |
| | Times | x1...x32 | Sets the number of notes to specify the delay time for TapR p.285 | |
| | Level | 0...50 | Sets the output level of TapR | |
| e | Feedback (C Delay) | -100...+100 | Sets the feedback amount of TapC | |
| | Src | Off...Tempo | Selects the modulation source for the TapC feedback | |
| | Amt | -100...+100 | Sets the modulation amount of the TapC feedback | |
| f | High Damp [%] | 0...100 | Sets the damping amount in the high range p.289 | |
| | Low Damp [%] | 0...100 | Sets the damping amount in the low range p.289 | |
| g | Input Level D-mod [%] | -100...+100 | Sets the modulation amount of the input level p.284 | |
| | Src | Off...Tempo | Selects the modulation source for the input level p.284 | |
| h | Spread | 0...50 | Sets the width of the stereo image of the effect sound p.289 | |
| i | Wet/Dry | Dry, 1 : 99... 99 : 1, Wet | Sets the balance between the effect and the dry input | |
| | Src | Off...Tempo | Selects a modulation source for Wet/Dry | |
| | Amt | -100...+100 | Sets the modulation amount for Wet/Dry | |

a: Time Over?

You can set the delay time up to 5,460msec. If the delay time exceeds this limit, the error message “OVER!” appears in the display. Set the delay time parameters so that this message will not appear. **Time Over?** is only a display parameter.

079: Stereo BPM Delay

This stereo delay enables you to set the delay time to match the song tempo.

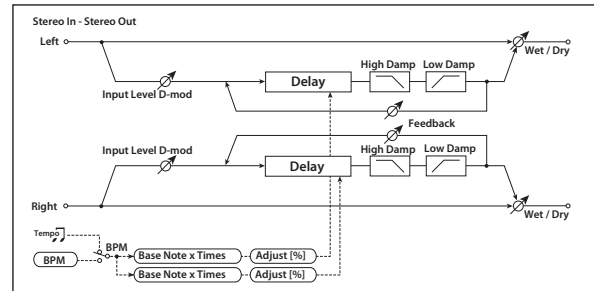

| | | | | |
|---|-----------------------|-------------------------------|---|--|
| a | BPM | MIDI, 40.00... 300.00 | MIDI syncs to the system tempo; 40–300 sets the tempo manually for this individual effect p.285 | |
| | Time Over? L | ---, OVER! | Display the error message if the left channel delay time exceeds the upper limit p.295 | |
| | R | ---, OVER! | Display the error message if the right channel delay time exceeds the upper limit p.295 | |
| b | L Delay Base Note | | Selects the type of notes to specify the left channel delay time p.285 | |
| | Times | x1...x32 | Sets the number of notes to specify the left channel delay time p.285 | |
| | Adjust [%] | -2.50...+2.50 | Fine-adjust the left channel delay time | |
| c | R Delay Base Note | | Selects the type of notes to specify the right channel delay time p.285 | |
| | Times | x1...x32 | Sets the number of notes to specify the right channel delay time p.285 | |
| | Adjust [%] | -2.50...+2.50 | Fine-adjust the right channel delay time | |
| d | L Feedback | -100...+100 | Sets the feedback amount for the left channel | |
| | Src | Off...Tempo | Selects the modulation source of feedback amount | |
| | Amt L | -100...+100 | Sets the modulation amount of the left channel feedback | |
| e | R Feedback | -100...+100 | Sets the feedback amount for the right channel | |
| | Amt R | -100...+100 | Sets the modulation amount of the right channel feedback | |
| f | High Damp [%] | 0...100 | Sets the damping amount in the high range p.289 | |
| g | Low Damp [%] | 0...100 | Sets the damping amount in the low range p.289 | |
| h | Input Level D-mod [%] | -100...+100 | Sets the modulation amount of the input level p.284 | |
| | Src | Off...Tempo | Selects the modulation source for the input level p.284 | |
| i | Wet/Dry | Dry, 1 : 99... 99 : 1, Wet | Sets the balance between the effect and the dry input | |
| | Src | Off...Tempo | Selects a modulation source for Wet/Dry | |
| | Amt | -100...+100 | Sets the modulation amount for Wet/Dry | |

a: Time Over? L, R

You can set the delay time up to 2,730msec. If the delay time exceeds this limit, the error message “OVER!” appears in the display. Set the delay time parameters so that this message will not appear. **Time Over?** is only a display parameter.

080: St.BPM Mtap Delay (Stereo BPM Multitap Delay)

This is a stereo multi-tapped delay that lets you set the delay time to match the tempo of the song.

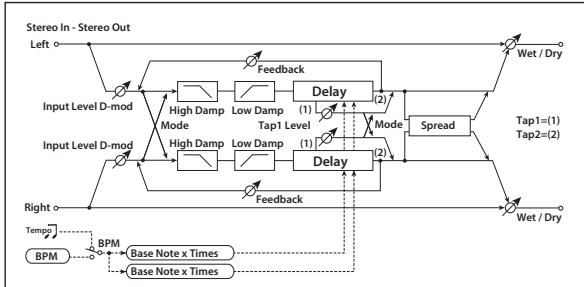

| | | | | |
|---|-----------------------|--|---|--|
| a | Mode | Normal, Cross Feedback, Cross Pan1, Cross Pan2 | Switches the left and right delay routing p.290 | |
| b | BPM | MIDI, 40.00... 300.00 | MIDI syncs to the system tempo; 40–300 sets the tempo manually for this individual effect p.285 | |
| | Time Over? 1 | ---, OVER! | Displays an error message when the delay time for Tap1 exceeds the upper limit p.295 | |
| c | 2 | ---, OVER! | Displays an error message when the delay time for Tap2 exceeds the upper limit p.295 | |
| | Tap 1 Base Note | | Selects the type of notes to specify the delay time for Tap1 p.285 | |
| d | Times | x1...x32 | Sets the number of notes to specify the delay time for Tap1 p.285 | |
| | Tap 2 Base Note | | Selects the type of notes to specify the delay time for Tap2 p.285 | |
| e | Times | x1...x32 | Sets the number of notes to specify the delay time for Tap2 p.285 | |
| | Tap1 Level | 0...100 | Sets the Tap1 output level p.290 | |
| f | Feedback (Tap2) | -100...+100 | Sets the Tap2 feedback amount | |
| | Src | Off...Tempo | Selects the modulation source of the Tap2 feedback amount | |
| | Amt | -100...+100 | Sets the modulation amount of the Tap2 feedback amount | |
| g | High Damp [%] | 0...100 | Sets the damping amount in the high range p.289 | |
| | Low Damp [%] | 0...100 | Sets the damping amount in the low range p.289 | |
| h | Input Level D-mod [%] | -100...+100 | Sets the modulation amount of the input level | |
| | Src | Off...Tempo | Selects the modulation source for the input level p.284 | |
| i | Spread | -100...+100 | Sets the width of the stereo image of the effect sound p.289 | |
| | Src | Off...Tempo | Selects the modulation source of the effect sound's stereo image width | |
| | Amt | -100...+100 | Sets the modulation amount of the effect sound's stereo image width | |
| j | Wet/Dry | Dry, 1 : 99... 99 : 1, Wet | Sets the balance between the effect and the dry input | |
| | Src | Off...Tempo | Selects a modulation source for Wet/Dry | |
| | Amt | -100...+100 | Sets the modulation amount for Wet/Dry | |

081: St.BPM Mod. Delay (Stereo BPM Modulation Delay)

This is a stereo modulation delay that lets you synchronize the delay time to the tempo of the song.

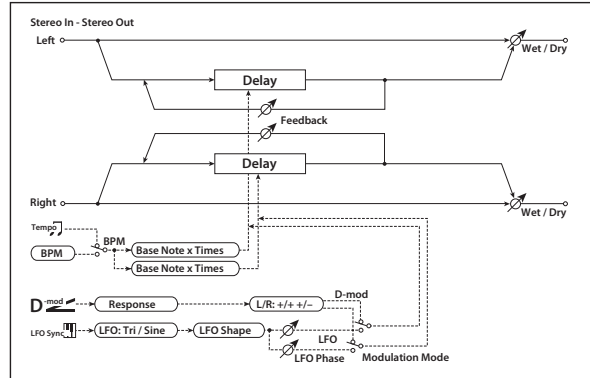

| | | | | |
|---|-------------------------|------------------------------|---|--|
| a | Modulation Mode | LFO, D-mod | Switches between LFO modulation control and modulation source control | |
| b | D-mod Modulation | L/R: +/+, L/R: +/- | Reversed L/R control by modulation source p.291 | |
| | Src | Off...Tempo | Selects the modulation source that controls delay time | |
| c | Response | 0...30 | Sets the rate of response to the modulation source | |
| | LFO Waveform | Triangle, Sine | Selects the LFO Waveform | |
| d | LFO Shape | -100...+100 | Changes the curvature of the LFO Waveform p.258 | |
| | LFO D-mod Sync | Off, On | Switches LFO reset off/on p.291 | |
| e | Src | Off...Tempo | Selects the modulation source that resets the LFO | |
| | LFO Frequency [Hz] | 0.02...20.00 | Sets the speed of the LFO p.259 | |
| | MIDI Sync | Off, On | When this is on, the LFO speed is set by BPM, Base Note, and Times, instead of Frequency p.257 | |
| f | BPM | MIDI, 40.00... 300.00 | MIDI syncs to the system tempo; 40–300 sets the tempo manually for this individual effect p.257 | |
| | Base Note | | Selects the type of notes that specify the LFO speed p.257 | |
| | Times | x1...x32 | Sets the number of notes that specify the LFO speed p.257 | |
| g | LFO Type | Individual, Common1, Common2 | Selects either (individual) LFO, Common FX LFO1, or Common LFO2 p.257 | |
| | Common LFO Offset [deg] | -180...+180 | Sets the phase offset when Type = Common 1 or Common 2 p.257 | |
| h | L LFO Phase [deg] | -180...+180 | Sets the phase obtained when the left LFO is reset p.291 | |
| | Depth | 0...200 | Sets the depth of the left LFO modulation | |
| i | R LFO Phase [deg] | -180...+180 | Sets the phase obtained when the right LFO is reset p.291 | |
| | Depth | 0...200 | Sets the depth of the right LFO modulation | |
| j | BPM(Delay) | MIDI, 40.00... 300.00 | MIDI syncs to the system tempo; 40–300 sets the tempo manually for this individual effect p.285 | |
| | Time Over? L | ---, OVER! | Display the error message if the left channel delay time exceeds the upper limit p.297 | |
| | R | ---, OVER! | Display the error message if the right channel delay time exceeds the upper limit p.297 | |

| | | | | |
|---|-------------------|--|---|--|
| k | L Delay Base Note | | Selects the type of notes to specify the left channel delay time p.285 | |
| | Times | x1...x32 | Sets the number of notes to specify the left channel delay time p.285 | |
| | Feedback | -100...+100 | Sets the feedback amount of left delay | |
| l | R Delay Base Note | | Selects the type of notes to specify the right channel delay time p.285 | |
| | Times | x1...x32 | Sets the number of notes to specify the right channel delay time p.285 | |
| | Feedback | -100...+100 | Sets the feedback amount of right delay | |
| m | Wet/Dry | -Wet... -1 : 99, Dry, 1 : 99...Wet | Sets the balance between the effect and the dry input p.259 | |
| | Src | Off...Tempo | Selects a modulation source for Wet/Dry | |
| | Amt | -100...+100 | Sets the modulation amount for Wet/Dry | |

j: Time Over? L, R

You can set the delay time up to 2,550msec. If the delay time exceeds this limit, the error message "OVER!" appears in the display. Set the delay time parameters so that this message will not appear. **Time Over?** is only a display parameter.

082: St.BPMAutoPanDly (Stereo BPM Auto Panning Delay)

This stereo auto panning delay enables you to set the delay time to match the song tempo.

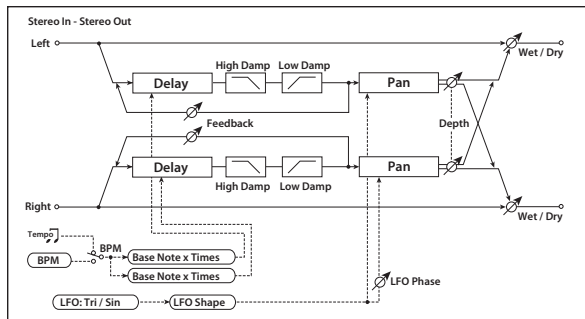

| | | | | |
|---|-------------------|-----------------------|---|--|
| a | BPM | MIDI, 40.00... 300.00 | MIDI syncs to the system tempo; 40-300 sets the tempo manually for this individual effect p.285 | |
| | Time Over? L | ---, OVER! | Display the error message if the left channel delay time exceeds the upper limit p.295 | |
| | R | ---, OVER! | Display the error message if the right channel delay time exceeds the upper limit p.295 | |
| b | L Delay Base Note | | Selects the type of notes to specify the left channel delay time p.285 | |
| | Times | x1...x32 | Sets the number of notes to specify the left channel delay time p.285 | |
| | Feedback | -100...+100 | Sets the feedback amount for the left channel | |
| c | R Delay Base Note | | Selects the type of notes to specify the right channel delay time p.285 | |
| | Times | x1...x32 | Sets the number of notes to specify the right channel delay time p.285 | |
| | Feedback | -100...+100 | Sets the feedback amount for the right channel | |
| d | High Damp [%] | 0...100 | Sets the damping amount in the high range p.289 | |
| | Low Damp [%] | 0...100 | Sets the damping amount in the low range p.289 | |



| | | | | |
|---|-------------------------|------------------------------|--|--|
| e | LFO Waveform | Triangle, Sine | Selects the LFO Waveform | |
| | Shape | -100...+100 | Changes the curvature of the LFO Waveform p.258 | |
| | LFO Phase | -180...+180 | Sets the LFO phase difference between the left and right p.281 | |
| f | Panning Frequency [Hz] | 0.02...20.00 | Sets the panning speed p.257 | |
| g | MIDI Sync | Off, On | When this is on, the pan LFO speed is set by BPM, Base Note, and Times, instead of Frequency p.257 | |
| | BPM | MIDI, 40.00... 300.00 | MIDI syncs to the system tempo; 40-300 sets the tempo manually for this individual effect p.257 | |
| | Base Note | | Selects the type of notes to specify the delay time for the panning speed p.257 | |
| h | Times | x1...x32 | Sets the number of notes to specify the delay time for the panning speed p.257 | |
| | LFO Type | Individual, Common1, Common2 | Selects either (individual) LFO, Common FX LFO1, or Common LFO2 p.257 | |
| | Common LFO Offset [deg] | -180...+180 | Sets the phase offset when Type = Common 1 or Common 2 p.257 | |
| i | Panning Depth | 0...100 | Sets the panning width | |
| | Src | Off...Tempo | Selects the modulation source for the panning width | |
| | Amt | -100...+100 | Set the modulation amount of the panning width | |
| j | Wet/Dry | Dry, 1 : 99... 99 : 1, Wet | Sets the balance between the effect and the dry input | |
| | Src | Off...Tempo | Selects a modulation source for Wet/Dry | |
| | Amt | -100...+100 | Sets the modulation amount for Wet/Dry | |

083: Tape Echo BPM

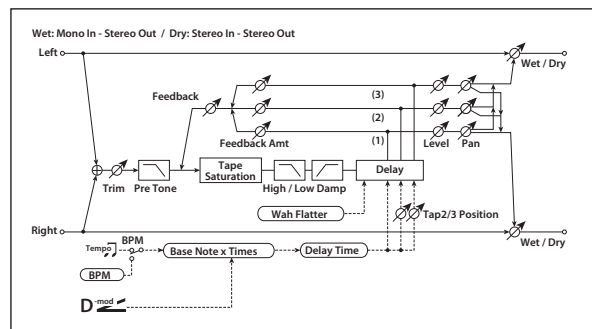
This is a tape echo that lets you synchronize the delay time to the tempo of the song.



| | | | | |
|---|-----------------|-----------------------|--|--|
| a | BPM (Delay) | MIDI, 40.00... 300.00 | MIDI syncs to the system tempo; 40-300 sets the tempo manually for this individual effect p.285 | |
| | Tap1 Dmod Src | Off...Tempo | Selects the modulation source of the delay time p.298 | |
| b | Tap1 Delay Note | | Selects the type of notes to specify the delay time (tap1) p.285, p.298 | |
| | Times | x1...x32 | Sets the number of notes to specify the delay time (tap1) p.285, p.298 | |
| c | Time Over? | ---, OVER! | Displays an error message when the delay time exceeds the upper limit p.298 | |
| | Tap1 Dmod Note | | Selects the note value used to specify the delay time when the modulation is at maximum p.298 | |
| c | Times | x1...x32 | Specifies the number of notes used to specify the delay time when the modulation is at maximum p.298 | |

| | | | | |
|---|-------------------|------------------------------|---|---|
| d | Tap2 Position [%] | 0..100 | Sets the position of Tap 2 relative to the Tap 1 delay time the depth of pitch variation p.293 | |
| e | Tap3 Position [%] | 0..100 | Sets the position of Tap 3 relative to the Tap 1 delay time the depth of pitch variation p.293 | |
| f | Tap1 Level | 0..100 | Sets the Tap1 output level | |
| | Pan | L, 1..99, R | Sets the stereo image of tap1 | |
| | Feedback Amt | -100..+100 | Sets the Tap1 feedback amount p.293 | |
| g | Tap2 Level | 0..100 | Sets the Tap2 output level | |
| | Pan | L, 1..99, R | Sets the stereo image of tap2 | |
| | Feedback Amt | -100..+100 | Sets the Tap2 feedback amount p.293 | |
| h | Tap3 Level | 0..100 | Sets the Tap3 output level | |
| | Pan | L, 1..99, R | Sets the stereo image of tap3 | |
| | Feedback Amt | -100..+100 | Sets the Tap3 feedback amount p.293 | |
| i | Feedback | 0..100 | Sets the amount of feedback for Taps 1, 2, and 3 p.293 |  |
| | Src | Off..Tempo | Selects the modulation source of feedback amount | |
| | Amt | -100..+100 | Sets the depth by which feedback amount will be modulated | |
| j | High Damp [%] | 0..100 | Sets the damping amount in the high range | |
| | Low Damp [%] | 0..100 | Sets the damping amount in the low range | |
| k | Saturation | 0..100 | Sets the distortion amount | |
| l | Input Trim | 0..100 | Sets the input gain | |
| | Pre Tone | 0..100 | Sets the tone of the input | |
| m | Wow Flutter [Hz] | 0.02..1.00 | Sets the frequency at which pitch variation will occur | |
| | Wow Flutter depth | 0..100 | Sets the depth of pitch variation | |
| n | Wet/Dry | Dry, 1 : 99.. 99 : 1, Wet | Sets the balance between the effect and the dry input |  |
| | Src | Off..Tempo | Selects a modulation source for Wet/Dry | |
| | Amt | -100..+100 | Sets the modulation amount for Wet/Dry | |

a: Tap1 Dmod Src

b: Tap1 Delay Note

b: Times

c: Tap1 Dmod Note

c: Times

If **Tap1 Dmod Src** is Off or the selected modulation is at 0, the delay time will be the length specified by **Tap1 Delay Note** and **Times**.

If **Tap1 Dmod Src** is other than Off, the delay time will change so that it will be as specified by **Tap1 Dmod Note** and **Times** when the maximum modulation is reached.

b: Time Over?

You can set the delay time up to 5,400msec. If the delay time exceeds this limit, the error message "OVER!" appears in the display. Set the delay time parameters so that this message will not appear. **Time Over?** is only a display parameter.

Reverb and Early Reflections (Reverb ER)

084: Reverb Hall

This hall-type reverb simulates the reverberation of mid-size concert halls or ensemble halls.

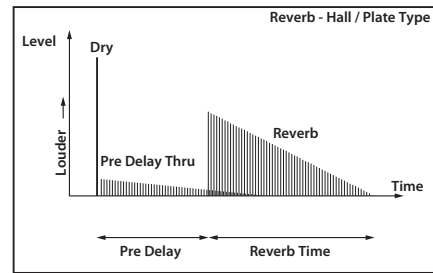

085: Reverb SmoothHall

This hall-type reverb simulates the reverberation of larger halls and stadiums, and creates a smooth release.

086: Reverb Wet Plate

This plate reverb simulates warm (dense) reverberation.

087: Reverb Dry Plate

This plate reverb simulates dry (light) reverberation.

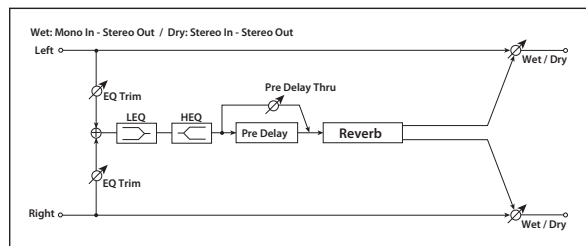

| | | | | |
|---|--------------------|----------------------------|---|------------------|
| a | Reverb Time [sec] | 0.1...10.0 | Sets the reverberation time | |
| | High Damp [%] | 0...100 | Sets the damping amount in the high range | |
| b | Pre Delay [msec] | 0...200 | Sets the delay time from the dry sound p.299 | |
| | Pre Delay Thru [%] | 0...100 | Sets the mix ratio of non-delay sound p.299 | |
| c | EQ Trim | 0...100 | Sets the EQ input level | |
| d | Pre LEQ Fc | Low, Mid-Low | Selects the cutoff frequency (low or mid-low) of the low-range equalizer | |
| | Pre HEQ Fc | High, Mid-High | Selects the cutoff frequency (high or mid-high) of the high-range equalizer | |
| e | Pre LEQ Gain [dB] | -15.0...+15.0 | Sets the gain of Low EQ | |
| | Pre HEQ Gain [dB] | -15.0...+15.0 | Sets the gain of High EQ | |
| f | Wet/Dry | Dry, 1 : 99... 99 : 1, Wet | Sets the balance between the effect and the dry input | D ^{mod} |
| | Src | Off...Tempo | Selects a modulation source for Wet/Dry | |
| | Amt | -100...+100 | Sets the modulation amount for Wet/Dry | |

b: Pre Delay [msec]

b: Pre Delay Thru [%]

The **Pre Delay** sets the delay time to the reverb input, allowing you to control spaciousness.

Using the **Pre Delay Thru** parameter, you can mix the dry sound without delay, emphasizing the attack of the sound.

088: Reverb Room

This room-type reverb emphasizes the early reflections that make the sound tighter. Changing the balance between the early reflections and reverb sound allows you to simulate nuances, such as the type of walls of a room.

089: Reverb BrightRoom

This room-type reverb emphasizes the early reflections that make the sound brighter.

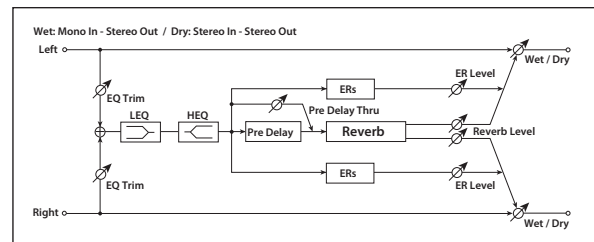

| | | | | |
|---|--------------------|----------------------------|---|------------------|
| a | Reverb Time [sec] | 0.1...3.0 | Sets the reverberation time | |
| | High Damp [%] | 0...100 | Sets the damping amount in the high range | |
| b | Pre Delay [msec] | 0...200 | Sets the delay time from the dry sound p.299 | |
| | Pre Delay Thru [%] | 0...100 | Sets the mix ratio of non-delay sound p.299 | |
| c | ER Level | 0...100 | Sets the level of early reflections p.299 | |
| d | Reverb Level | 0...100 | Sets the reverberation level p.299 | |
| e | EQ Trim | 0...100 | Sets the EQ input level | |
| f | Pre LEQ Fc | Low, Mid-Low | Selects the cutoff frequency (low or mid-low) of the low-range equalizer | |
| | Pre HEQ Fc | High, Mid-High | Selects the cutoff frequency (high or mid-high) of the high-range equalizer | |
| g | Pre LEQ Gain [dB] | -15.0...+15.0 | Sets the gain of Low EQ | |
| | Pre HEQ Gain [dB] | -15.0...+15.0 | Sets the gain of High EQ | |
| h | Wet/Dry | Dry, 1 : 99... 99 : 1, Wet | Sets the balance between the effect and the dry input | D ^{mod} |
| | Src | Off...Tempo | Selects a modulation source for Wet/Dry | |
| | Amt | -100...+100 | Sets the modulation amount for Wet/Dry | |

c: ER Level

d: Reverb Level

These parameters set the early reflection level and reverb level.

Changing these parameter values allows you to simulate the type of walls in the room. That is, a larger **ER Level** simulates a hard wall, and a larger **Reverb Level** simulates a soft wall.

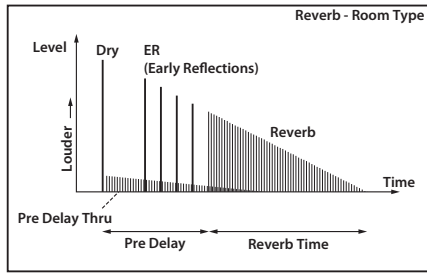

090: Reverb2 Spring

The Reverb2-type reverbs Reverb2 Spring–Reverb2 Room have a different sonic character than Rev.Hall–Rev.Room2. They model the spring reverb systems that are built into some amps.

091: Reverb2 Hall

This models the reverberation of a concert hall that includes numerous echo components.

092: Reverb2 Plate

This models a type of reverb unit that vibrates a metal plate rather than springs. The reverb time is relatively short. Because the reverberation has a fast attack, it is suitable for percussive playing.

093: Reverb2 Room

This models the reverberation of a typical room that includes numerous early reflections.

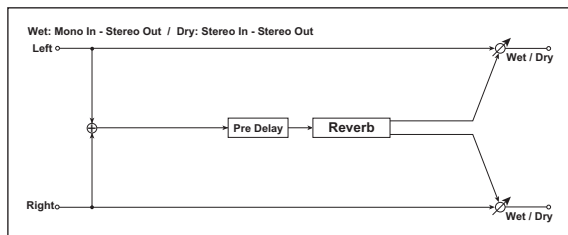

| | | | | |
|---|------------------|-------------------------------|---|--|
| a | Time [sec] | 0..100 | Sets the reverberation time p.300 | |
| b | High Damp [%] | 0..100 | Sets the damping amount in the high range | |
| c | Low Damp [%] | 0..100 | Sets the damping amount in the low range | |
| d | Pre Delay [msec] | 0..70 | Sets the delay time from the dry sound p.299 | |
| e | Wet/Dry | Dry, 1 : 99... 99 : 1, Wet | Sets the balance between the effect and the dry input | |
| | Src | Off...Tempo | Selects a modulation source for Wet/Dry | |
| | Amt | -100...+100 | Sets the modulation amount for Wet/Dry | |

Time

In these reverbs, **Time** is not expressed in seconds, but instead is a value from 1 to 100. A value of 1 produces the shortest reverb, and 100 provides the longest reverb.

094: Early Reflections

This effect is only the early reflection part of a reverberation sound, and adds presence to the sound. You can select one of the four decay curves.

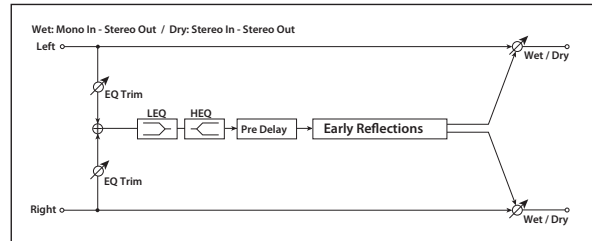

| | | | | |
|---|-------------------|----------------------------------|---|--|
| a | Type | Sharp, Loose, Modulated, Reverse | Selects the decay curve for the early reflection p.300 | |
| b | ER Time [msec] | 10..800 | Sets the time length of early reflection | |
| c | Pre Delay [msec] | 0..200 | Sets the time taken from the original sound to the first early reflection | |
| d | EQ Trim | 0..100 | Sets the input level of EQ applied to the effect sound | |
| e | Pre LEQ Fc | Low, Mid-Low | Selects the cutoff frequency (low or mid-low) of the low-range equalizer | |
| | Pre HEQ Fc | High, Mid-High | Selects the cutoff frequency (high or mid-high) of the high-range equalizer | |
| f | Pre LEQ Gain [dB] | -15.0...+15.0 | Sets the gain of the Low EQ | |
| | Pre HEQ Gain [dB] | -15.0...+15.0 | Sets the gain of the High EQ | |
| g | Wet/Dry | Dry, 1 : 99... 99 : 1, Wet | Sets the balance between the effect and the dry input | |
| | Src | Off...Tempo | Selects a modulation source for Wet/Dry | |
| | Amt | -100...+100 | Sets the modulation amount for Wet/Dry | |

a: Type

This parameter selects the decay curve for the early reflection.

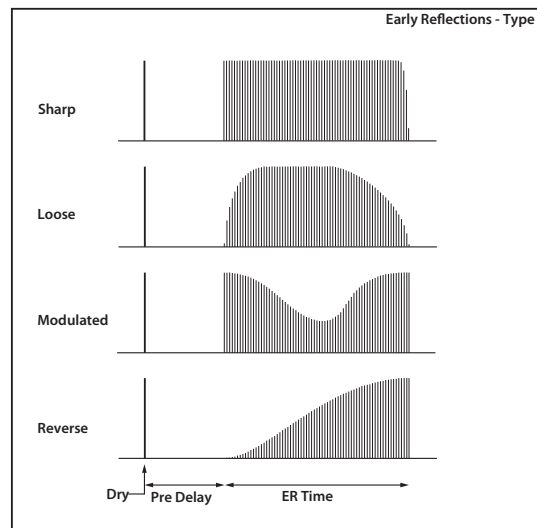

Mono-Mono Serial (Mono-Mono)

095: P4EQ - Exciter (Parametric 4-Band EQ - Exciter)

This effect combines a mono four-band parametric equalizer and an exciter.

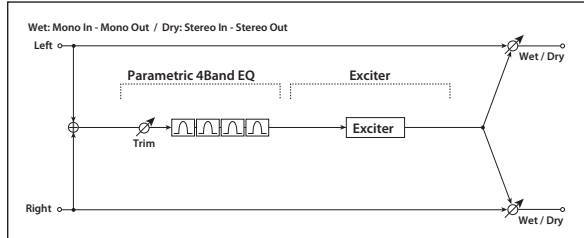

| P4EQ | | | | |
|---------|-----------------------|---------------------------|---|--------------|
| a | [E]Trim | 0...100 | Sets the parametric EQ input level | |
| b | [E]B1 Cutoff [Hz] | 20...1.00k | Sets the center frequency of Band 1 | |
| | Q | 0.5...10.0 | Sets the bandwidth of Band 1 | p.255 |
| | Gain [dB] | -18...+18 | Sets the gain of Band 1 | |
| c | [E]B2 Cutoff [Hz] | 50...5.00k | Sets the center frequency of Band 2 | |
| | Q | 0.5...10.0 | Sets the bandwidth of Band 2 | p.255 |
| | Gain [dB] | -18...+18 | Sets the gain of Band 2 | |
| d | [E]B3 Cutoff [Hz] | 300...10.00k | Sets the center frequency of Band 3 | |
| | Q | 0.5...10.0 | Sets the bandwidth of Band 3 | p.255 |
| | Gain [dB] | -18...+18 | Sets the gain of Band 3 | |
| e | [E]B4 Cutoff [Hz] | 500...20.00k | Sets the center frequency of Band 4 | |
| | Q | 0.5...10.0 | Sets the bandwidth of Band 4 | p.255 |
| | Gain [dB] | -18...+18 | Sets the gain of Band 4 | |
| EXCITER | | | | |
| f | [X]Exciter Blend | -100...+100 | Sets the intensity (depth) of the Exciter effect | p.256 |
| g | [X]Emphasis Frequency | 0...70 | Sets the frequency range to be emphasized | p.256 |
| h | Wet/Dry | Dry,1 : 99... 99 : 1, Wet | Sets the balance between the effect and the dry input | D-mod |
| | Src | Off...Tempo | Selects a modulation source for Wet/Dry | |
| | Amt | -100...+100 | Sets the modulation amount for Wet/Dry | |

096: P4EQ - Wah (Parametric 4-Band EQ - Wah/Auto Wah)

This effect combines a mono four-band parametric equalizer and a wah. You can change the order of the connection.

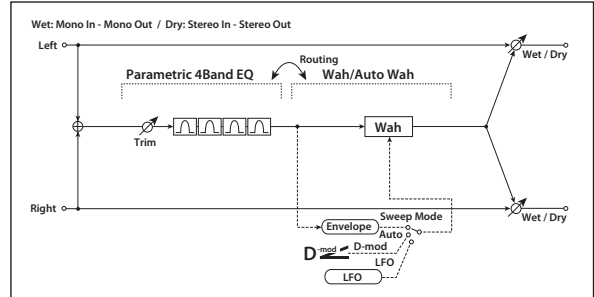

| P4EQ | | | | |
|------|-----------------------|---------------------------|--|--------------|
| a | [E]Trim | 0...100 | Sets the parametric EQ input level | |
| a | Routing | P4EQ → Wah, Wah → P4EQ | Changes the order of the parametric equalizer and wah connection | |
| | [E]B1 Cutoff [Hz] | 20...1.00k | Sets the center frequency of Band 1 | |
| b | Q | 0.5...10.0 | Sets the bandwidth of Band 1 | p.255 |
| | Gain [dB] | -18...+18 | Sets the gain of Band 1 | |
| | [E]B2 Cutoff [Hz] | 50...5.00k | Sets the center frequency of Band 2 | |
| c | Q | 0.5...10.0 | Sets the bandwidth of Band 2 | p.255 |
| | Gain [dB] | -18...+18 | Sets the gain of Band 2 | |
| | [E]B3 Cutoff [Hz] | 300...10.00k | Sets the center frequency of Band 3 | |
| d | Q | 0.5...10.0 | Sets the bandwidth of Band 3 | p.255 |
| | Gain [dB] | -18...+18 | Sets the gain of Band 3 | |
| | [E]B4 Cutoff [Hz] | 500...20.00k | Sets the center frequency of Band 4 | |
| e | Q | 0.5...10.0 | Sets the bandwidth of Band 4 | p.255 |
| | Gain [dB] | -18...+18 | Sets the gain of Band 4 | |
| | WAH | | | |
| f | [W]Frequency Bottom | 0...100 | Sets the lower limit of the wah center frequency | p.257 |
| | Frequency Top | 0...100 | Sets the upper limit of the wah center frequency | p.257 |
| g | [W]Sweep Mode | Auto, D-mod, LFO | Selects the control from auto-wah, modulation source, and LFO | p.257 |
| | Src | Off...Tempo | Selects the modulation source for the wah when Sweep Mode=D-mod | D-mod |
| h | [W]LFO Frequency [Hz] | 0.02...20.00 | Sets the speed of the LFO | |
| | Resonance | 0...100 | Sets the resonance amount | |
| | LPF | Off, On | Switches the wah low pass filter on and off | |
| i | [W]Wet/Dry | Dry,1 : 99... 99 : 1, Wet | Sets the wah effect balance | D-mod |
| | Src | Off...Tempo | Selects the Wet/Dry modulation source for the wah | |
| | Amt | -100...+100 | Sets the Wet/Dry modulation amount for the wah | |
| j | Wet/Dry | Dry,1 : 99... 99 : 1, Wet | Sets the balance between the effect and the dry input | D-mod |
| | Src | Off...Tempo | Selects a modulation source for Wet/Dry | |
| | Amt | -100...+100 | Sets the modulation amount for Wet/Dry | |

097: P4EQ - Cho/Flng (Parametric 4-Band EQ - Chorus/Flanger)

This effect combines a mono four-band parametric equalizer and a chorus/flanger.

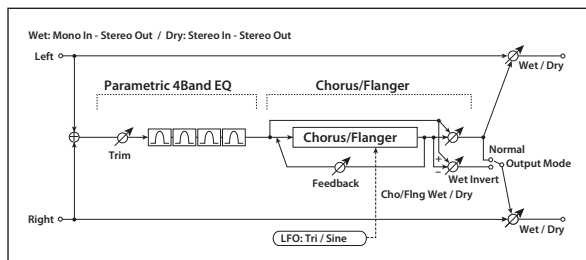

| P4EQ | | | |
|----------------|-----------------------|--|---|
| a | [E]Trim | 0..100 | Sets the parametric EQ input level |
| b | [E]B1 Cutoff [Hz] | 20...1.00k | Sets the center frequency of Band 1 |
| | Q | 0.5...10.0 | Sets the bandwidth of Band 1 p.255 |
| | Gain [dB] | -18...+18 | Sets the gain of Band 1 |
| c | [E]B2 Cutoff [Hz] | 50...5.00k | Sets the center frequency of Band 2 |
| | Q | 0.5...10.0 | Sets the bandwidth of Band 2 p.255 |
| | Gain [dB] | -18...+18 | Sets the gain of Band 2 |
| d | [E]B3 Cutoff [Hz] | 300...10.00k | Sets the center frequency of Band 3 |
| | Q | 0.5...10.0 | Sets the bandwidth of Band 3 p.255 |
| | Gain [dB] | -18...+18 | Sets the gain of Band 3 |
| e | [E]B4 Cutoff [Hz] | 500...20.00k | Sets the center frequency of Band 4 |
| | Q | 0.5...10.0 | Sets the bandwidth of Band 4 p.255 |
| | Gain [dB] | -18...+18 | Sets the gain of Band 4 |
| CHORUS/FLANGER | | | |
| f | [F]LFO Frequency [Hz] | 0.02...20.00 | Sets the speed of the LFO |
| | LFO Waveform | Triangle, Sine | Selects the LFO Waveform |
| g | [F]Delay Time [msec] | 0.0...1350.0 | Sets the delay time |
| | Depth | 0..100 | Sets the depth of LFO modulation |
| | Feedback | -100...+100 | Sets the feedback amount p.272 |
| h | [F]Cho/Flng Wet/Dry | -Wet... -1 : 99, Dry, 1 : 99...Wet | Sets the effect balance of the chorus/flanger p.259, p.272 |
| | Src | Off...Tempo | Selects the Wet/Dry modulation source for the chorus/flanger |
| | Amt | -100...+100 | Sets the Wet/Dry modulation amount for the chorus/flanger |
| i | [F]Output Mode | Normal, Wet Invert | Selects the output mode for the chorus/flanger p.302 |
| j | Wet/Dry | Dry, 1 : 99... 99 : 1, Wet | Sets the balance between the effect and the dry input D ^{mod} |
| | Src | Off...Tempo | Selects a modulation source for Wet/Dry |
| | Amt | -100...+100 | Sets the modulation amount for Wet/Dry |

i: [F]Output Mode

When Wet Invert is selected, the right channel phase of the chorus/flanger effect sound is inverted. This creates pseudo-stereo effects and adds spread.

However, if a mono-input type effect is connected after this effect, the left and right sounds may cancel each other, eliminating the chorus/flanger effects.

098: P4EQ - Phaser (Parametric 4-Band EQ - Phaser)

This effect combines a mono four-band parametric equalizer and a phaser.

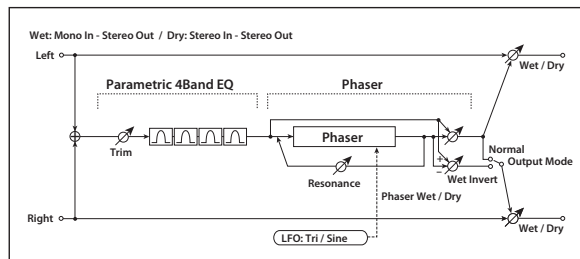

| P4EQ | | | |
|--------|-----------------------|--|---|
| a | [E]Trim | 0..100 | Sets the parametric EQ input level |
| b | [E]B1 Cutoff [Hz] | 20...1.00k | Sets the center frequency of Band 1 |
| | Q | 0.5...10.0 | Sets the bandwidth of Band 1 p.255 |
| | Gain [dB] | -18...+18 | Sets the gain of Band 1 |
| c | [E]B2 Cutoff [Hz] | 50...5.00k | Sets the center frequency of Band 2 |
| | Q | 0.5...10.0 | Sets the bandwidth of Band 2 p.255 |
| | Gain [dB] | -18...+18 | Sets the gain of Band 2 |
| d | [E]B3 Cutoff [Hz] | 300...10.00k | Sets the center frequency of Band 3 |
| | Q | 0.5...10.0 | Sets the bandwidth of Band 3 p.255 |
| | Gain [dB] | -18...+18 | Sets the gain of Band 3 |
| e | [E]B4 Cutoff [Hz] | 500...20.00k | Sets the center frequency of Band 4 |
| | Q | 0.5...10.0 | Sets the bandwidth of Band 4 p.255 |
| | Gain [dB] | -18...+18 | Sets the gain of Band 4 |
| PHASER | | | |
| f | [P]LFO Frequency [Hz] | 0.02...20.00 | Sets the speed of the LFO |
| | LFO Waveform | Triangle, Sine | Selects the LFO Waveform |
| g | [P]Manual | 0..100 | Sets the frequency to which the effect is applied |
| | Depth | 0..100 | Sets the depth of LFO modulation |
| | Resonance | -100...+100 | Sets the resonance amount p.274 |
| h | [P]Phaser Wet/Dry | -Wet... -1 : 99, Dry, 1 : 99...Wet | Sets the phaser effect balance p.259, p.274 |
| | Src | Off...Tempo | Selects the Wet/Dry modulation source for the phaser |
| | Amt | -100...+100 | Sets the Wet/Dry modulation amount for the phaser |
| i | [P]Output Mode | Normal, Wet Invert | Selects the phaser output mode p.305 |
| j | Wet/Dry | Dry, 1 : 99... 99 : 1, Wet | Sets the balance between the effect and the dry input D ^{mod} |
| | Src | Off...Tempo | Selects a modulation source for Wet/Dry |
| | Amt | -100...+100 | Sets the modulation amount for Wet/Dry |

099: P4EQ - Mt. Delay (Parametric 4-Band EQ - Multitap Delay)

This effect combines a mono four-band parametric equalizer and a multitap delay.

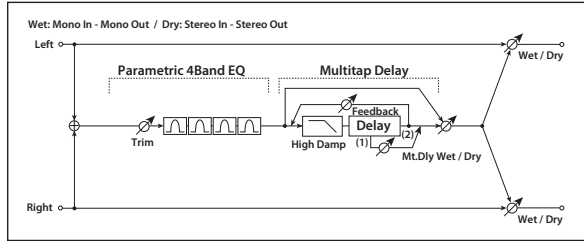

| P4EQ | | | | |
|----------------|---------------------|----------------------------|--|--------------|
| a | [E]Trim | 0...100 | Sets the parametric EQ input level | |
| b | [E]B1 Cutoff [Hz] | 20...1.00k | Sets the center frequency of Band 1 | |
| | Q | 0.5...10.0 | Sets the bandwidth of Band 1 | p.255 |
| | Gain [dB] | -18...+18 | Sets the gain of Band 1 | |
| c | [E]B2 Cutoff [Hz] | 50...5.00k | Sets the center frequency of Band 2 | |
| | Q | 0.5...10.0 | Sets the bandwidth of Band 2 | p.255 |
| | Gain [dB] | -18...+18 | Sets the gain of Band 2 | |
| d | [E]B3 Cutoff [Hz] | 300...10.00k | Sets the center frequency of Band 3 | |
| | Q | 0.5...10.0 | Sets the bandwidth of Band 3 | p.255 |
| | Gain [dB] | -18...+18 | Sets the gain of Band 3 | |
| e | [E]B4 Cutoff [Hz] | 500...20.00k | Sets the center frequency of Band 4 | |
| | Q | 0.5...10.0 | Sets the bandwidth of Band 4 | p.255 |
| | Gain [dB] | -18...+18 | Sets the gain of Band 4 | |
| MULTITAP DELAY | | | | |
| f | [D]Tap1 Time [msec] | 0.0...1360.0 | Sets the Tap1 delay time | |
| | Tap1 Level | 0...100 | Sets the Tap1 output level | p.290 |
| g | [D]Tap2 Time [msec] | 0.0...1360.0 | Sets the Tap2 delay time | |
| | Feedback (Tap2) | -100...+100 | Sets the Tap2 feedback amount | |
| h | [D]High Damp [%] | 0...100 | Sets the damping amount in the high range | |
| | [D]Mt.Delay Wet/Dry | Dry, 1 : 99... 99 : 1, Wet | Sets the multitap delay effect balance | D-mod |
| i | Src | Off...Tempo | Selects the Wet/Dry modulation source for the multitap delay | |
| | Amt | -100...+100 | Sets the Wet/Dry modulation amount for the multitap delay | |
| | Wet/Dry | Dry, 1 : 99... 99 : 1, Wet | Sets the balance between the effect and the dry input | D-mod |
| j | Src | Off...Tempo | Selects a modulation source for Wet/Dry | |
| | Amt | -100...+100 | Sets the modulation amount for Wet/Dry | |

100: Comp - Wah (Compressor - Wah/Auto Wah)

This effect combines a mono compressor and a wah. You can change the order of the connection.

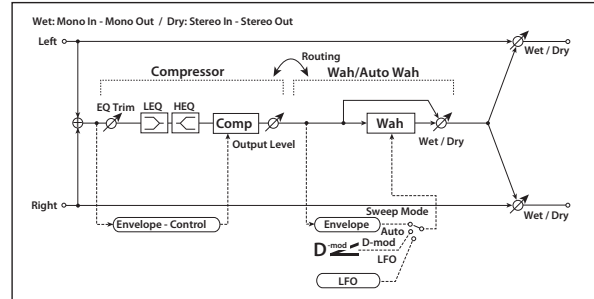

| COMPRESSOR | | | | |
|------------|-----------------------|----------------------------|---|--------------|
| a | [C]Sensitivity | 1...100 | Sets the sensitivity | p.251 |
| b | [C]Attack | 1...100 | Sets the attack level | p.251 |
| | Output Level | 0...100 | Sets the compressor output level | p.251 |
| c | [C]EQ Trim | 0...100 | Sets the EQ input level | |
| d | [C]Pre LEQ Gain [dB] | -15...+15 | Sets the gain of Low EQ | |
| | Pre HEQ Gain [dB] | -15...+15 | Sets the gain of High EQ | |
| WAH | | | | |
| e | [W]Frequency Bottom | 0...100 | Sets the lower limit of the wah center frequency | p.257 |
| | Frequency Top | 0...100 | Sets the upper limit of the wah center frequency | p.257 |
| f | [W]Sweep Mode | Auto, D-mod, LFO | Selects the control from auto-wah, modulation source, and LFO | |
| | Src | Off...Tempo | Selects the modulation source for the wah when Sweep Mode=D-mod | D-mod |
| g | [W]LFO Frequency [Hz] | 0.02...20.00 | Sets the speed of the LFO | |
| | Resonance | 0...100 | Sets the resonance amount | |
| | LPF | Off, On | Switches the wah low pass filter on and off | |
| h | [W]Wet/Dry | Dry, 1 : 99... 99 : 1, Wet | Sets the wah effect balance | D-mod |
| | Src | Off...Tempo | Selects the Wet/Dry modulation source for the wah | |
| | Amt | -100...+100 | Sets the Wet/Dry modulation amount for the wah | |
| i | Routing | Comp → Wah, Wah → Comp | Switches the order of the compressor and wah | |
| j | Wet/Dry | Dry, 1 : 99... 99 : 1, Wet | Sets the balance between the effect and the dry input | D-mod |
| | Src | Off...Tempo | Selects a modulation source for Wet/Dry | |
| | Amt | -100...+100 | Sets the modulation amount for Wet/Dry | |

101: Comp - Amp Sim (Compressor - Amp Simulation)

This effect combines a mono compressor and an amp simulation. You can change the order of the effects.

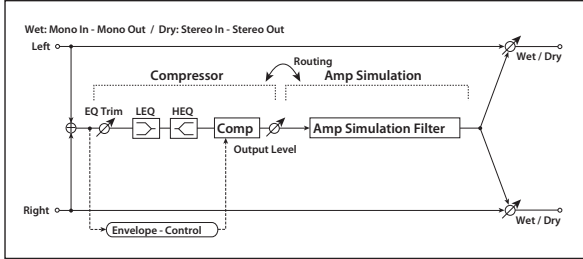

| COMPRESSOR | | | | |
|------------|-----------------------|----------------------------|---|-------|
| a | [C] Sensitivity | 1...100 | Sets the sensitivity | p.251 |
| b | [C] Attack | 1...100 | Sets the attack level | p.251 |
| | Output Level | 0...100 | Sets the compressor output level | p.251 |
| c | [C] EQ Trim | 0...100 | Sets the EQ input level | |
| d | [C] Pre LEQ Gain [dB] | -15...+15 | Sets the gain of Low EQ | |
| | Pre HEQ Gain [dB] | -15...+15 | Sets the gain of High EQ | |
| AMP SIM | | | | |
| e | [A] Amplifier Type | 5S, EL84, 6L6 | Selects the type of guitar amplifier | |
| f | Routing | Comp → Amp, Amp → Comp | Switches the order of the compressor and amp simulation | |
| g | Wet/Dry | Dry, 1 : 99... 99 : 1, Wet | Sets the balance between the effect and the dry input | |
| | Src | Off...Tempo | Selects a modulation source for Wet/Dry | |
| | Amt | -100...+100 | Sets the modulation amount for Wet/Dry | |

102: Comp - OD/HiGain (Compressor - Overdrive/HiGain)

This effect combines a mono compressor and an overdrive/high-gain distortion. You can change the order of the effects.

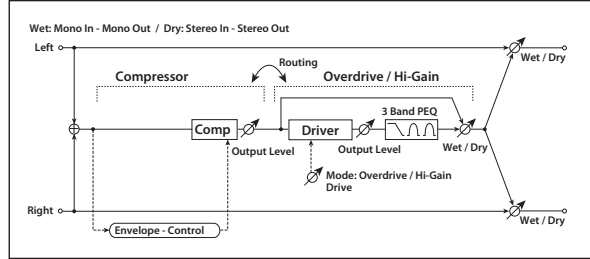

| COMPRESSOR | | | | |
|------------|----------------------|----------------------------|--|-------|
| a | [C] Sensitivity | 1...100 | Sets the sensitivity | p.251 |
| b | [C] Attack | 1...100 | Sets the attack level | p.251 |
| | Output Level | 0...100 | Sets the compressor output level | p.251 |
| OD/HI-GAIN | | | | |
| c | [O] Drive Mode | Overdrive, Hi-Gain | Switches between overdrive and high-gain distortion | |
| | Drive | 1...100 | Sets the degree of distortion | p.263 |
| d | [O] Output Level | 0...50 | Sets the overdrive output level | |
| | Src | Off...Tempo | Selects the modulation source for the overdrive output level | |
| | Amt | -50...+50 | Sets the modulation amount of the overdrive output level | |
| e | [O] Low Cutoff [Hz] | 20...1.00k | Sets the center frequency for Low EQ (shelving type) | |
| | Gain [dB] | -18...+18 | Sets the gain of Low EQ | |
| f | [O] Mid1 Cutoff [Hz] | 300...10.00k | Sets the center frequency for Mid/High EQ 1 (peaking type) | |
| | Q | 0.5...10.0 | Sets the band width of Mid/High EQ 1 | p.255 |
| | Gain [dB] | -18...+18 | Sets the gain of Mid/High EQ 1 | |
| g | [O] Mid2 Cutoff [Hz] | 500...20.00k | Sets the center frequency for Mid/High EQ 2 (peaking type) | |
| | Q | 0.5...10.0 | Sets the band width of Mid/High EQ 2 | p.255 |
| | Gain [dB] | -18...+18 | Sets the gain of Mid/High EQ 2 | |
| h | [O] Wet/Dry | Dry, 1 : 99... 99 : 1, Wet | Sets the overdrive effect balance | |
| | Src | Off...Tempo | Selects the Wet/Dry modulation source for the overdrive | |
| | Amt | -100...+100 | Sets the Wet/Dry modulation amount for the overdrive | |
| i | Routing | Comp → OD/HG, OD/HG → Comp | Switches the order of the compressor and overdrive | |
| j | Wet/Dry | Dry, 1 : 99... 99 : 1, Wet | Sets the balance between the effect and the dry input | |
| | Src | Off...Tempo | Selects a modulation source for Wet/Dry | |
| | Amt | -100...+100 | Sets the modulation amount for Wet/Dry | |

103: Comp - P4EQ (Compressor - Parametric 4-Band EQ)

This effect combines a mono compressor and a four-band parametric equalizer. You can change the order of the effects.

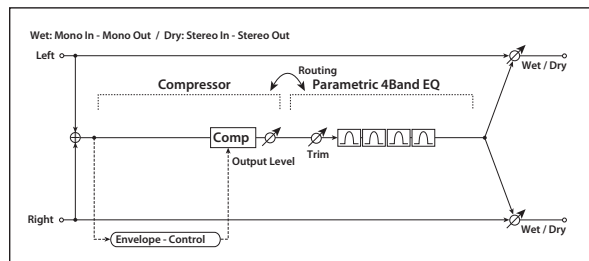

| COMPRESSOR | | | | |
|------------|-------------------|----------------------------|--|-------|
| a | [C] Sensitivity | 1...100 | Sets the sensitivity | p.251 |
| b | [C]Attack | 1...100 | Sets the attack level | p.251 |
| | Output Level | 0...100 | Sets the compressor output level | p.251 |
| P4EQ | | | | |
| c | [E]Trim | 0...100 | Sets the parametric EQ input level | |
| d | [E]B1 Cutoff [Hz] | 20...1.00k | Sets the center frequency of Band 1 | |
| | Q | 0.5...10.0 | Sets the bandwidth of Band 1 | p.255 |
| | Gain [dB] | -18...+18 | Sets the gain of Band 1 | |
| e | [E]B2 Cutoff [Hz] | 50...5.00k | Sets the center frequency of Band 2 | |
| | Q | 0.5...10.0 | Sets the bandwidth of Band 2 | p.255 |
| | Gain [dB] | -18...+18 | Sets the gain of Band 2 | |
| f | [E]B3 Cutoff [Hz] | 300...10.00k | Sets the center frequency of Band 3 | |
| | Q | 0.5...10.0 | Sets the bandwidth of Band 3 | p.255 |
| | Gain [dB] | -18...+18 | Sets the gain of Band 3 | |
| g | [E]B4 Cutoff [Hz] | 500...20.00k | Sets the center frequency of Band 4 | |
| | Q | 0.5...10.0 | Sets the bandwidth of Band 4 | p.255 |
| | Gain [dB] | -18...+18 | Sets the gain of Band 4 | |
| h | Routing | Comp→P4EQ, P4EQ→Comp | Switches the order of the compressor and parametric EQ | |
| i | Wet/Dry | Dry, 1 : 99... 99 : 1, Wet | Sets the balance between the effect and the dry input | |
| | Src | Off...Tempo | Selects a modulation source for Wet/Dry | |
| | Amt | -100...+100 | Sets the modulation amount for Wet/Dry | |

104: Comp - Cho/Flng (Compressor - Chorus/Flanger)

This effect combines a mono compressor and a chorus/flanger. You can change the order of the effects.

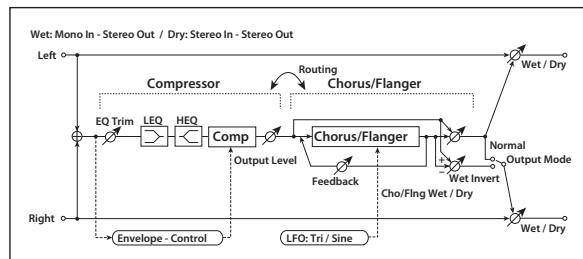

| COMPRESSOR | | | | |
|----------------|-----------------------|------------------------------------|--|--------------|
| a | [C] Sensitivity | 1...100 | Sets the sensitivity | p.251 |
| b | [C]Attack | 1...100 | Sets the attack level | p.251 |
| | Output Level | 0...100 | Sets the compressor output level | p.251 |
| c | [C]EQ Trim | 0...100 | Sets the EQ input level | |
| d | [C]Pre LEQ Gain [dB] | -15...+15 | Sets the gain of Low EQ | |
| | Pre HEQ Gain [dB] | -15...+15 | Sets the gain of High EQ | |
| CHORUS/FLANGER | | | | |
| e | [F]LFO Frequency [Hz] | 0.02...20.00 | Sets the speed of the LFO | |
| | LFO Waveform | Triangle, Sine | Selects the LFO Waveform | |
| f | [F]Delay Time [msec] | 0.0...1350.0 | Sets the delay time | |
| | Depth | 0...100 | Sets the depth of LFO modulation | |
| | Feedback | -100...+100 | Sets the feedback amount | p.272 |
| g | [F]Cho/Flng Wet/Dry | -Wet... -1 : 99, Dry, 1 : 99...Wet | Sets the effect balance of the chorus/flanger | p.259, p.272 |
| | Src | Off...Tempo | Selects the Wet/Dry modulation source for the chorus/flanger | |
| | Amt | -100...+100 | Sets the Wet/Dry modulation amount for the chorus/flanger | |
| h | [F]Output Mode | Normal, Wet Invert | Selects the output mode for the chorus/flanger | p.305 |
| i | Routing | Comp→Flanger, Flanger→Comp | Switches the order of the compressor and chorus/flanger | p.305 |
| j | Wet/Dry | Dry, 1 : 99... 99 : 1, Wet | Sets the balance between the effect and the dry input | |
| | Src | Off...Tempo | Selects a modulation source for Wet/Dry | |
| | Amt | -100...+100 | Sets the modulation amount for Wet/Dry | |

h: [F]Output Mode

i: Routing

When Wet Invert is selected, the right channel phase of the chorus/flanger effect sound is inverted. This creates pseudo-stereo effects and adds spread.

However, if a mono-input type effect is connected after this effect, the left and right sounds may cancel each other, eliminating the chorus/flanger effects.

When **Routing** is set to Flanger→Comp, **[F]Output Mode** will be set to Normal.

105: Comp - Phaser (Compressor - Phaser)

This effect combines a mono compressor and a phaser. You can change the order of the effects.

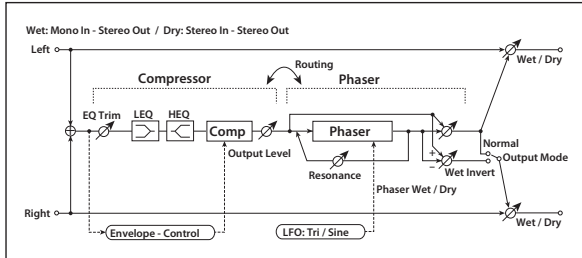

| COMPRESSOR | | | | |
|------------|------------------------|-----------------------------------|---|--------------|
| a | [C] Sensitivity | 1...100 | Sets the sensitivity | p.251 |
| | [C] Attack | 1...100 | Sets the attack level | p.251 |
| b | Output Level | 0...100 | Sets the compressor output level | p.251 |
| | [C] EQ Trim | 0...100 | Sets the EQ input level | |
| d | [C] Pre LEQ Gain [dB] | -15...+15 | Sets the gain of Low EQ | |
| | Pre HEQ Gain [dB] | -15...+15 | Sets the gain of High EQ | |
| PHASER | | | | |
| e | [P] LFO Frequency [Hz] | 0.02...20.00 | Sets the speed of the LFO | |
| | LFO Waveform | Triangle, Sine | Selects the LFO Waveform | |
| f | [P] Manual | 0...100 | Sets the frequency to which the effect is applied | |
| | Depth | 0...100 | Sets the depth of LFO modulation | |
| | Resonance | -100...+100 | Sets the resonance amount | p.274 |
| g | [P] Phaser Wet/Dry | -Wet...-1 : 99, Dry, 1 : 99...Wet | Sets the phaser effect balance | p.259, p.274 |
| | Src | Off...Tempo | Selects the Wet/Dry modulation source for the phaser | |
| | Amt | -100...+100 | Sets the Wet/Dry modulation amount for the phaser | |
| h | [F] Output Mode | Normal, Wet Invert | Selects the phaser output mode | p.302 |
| i | Routing | Comp → Phaser, Phaser → Comp | Switches the order of the compressor and phaser | p.305 |
| j | Wet/Dry | Dry, 1 : 99...99 : 1, Wet | Sets the balance between the effect and the dry input | |
| | Src | Off...Tempo | Selects a modulation source for Wet/Dry | |
| | Amt | -100...+100 | Sets the modulation amount for Wet/Dry | |

106: Comp - Mt. Delay (Compressor - Multitap Delay)

This effect combines a mono compressor and a multitap delay. You can change the order of the effects.

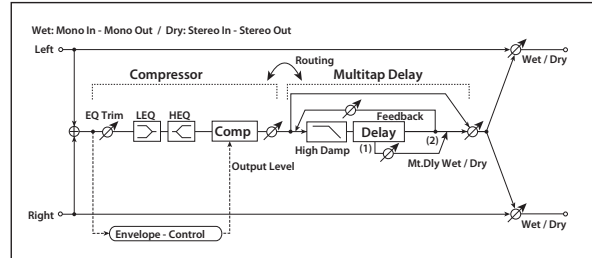

| COMPRESSOR | | | | |
|----------------|-----------------------|------------------------------------|--|-------|
| a | [C] Sensitivity | 1...100 | Sets the sensitivity | p.251 |
| | [C] Attack | 1...100 | Sets the attack level | p.251 |
| b | Output Level | 0...100 | Sets the compressor output level | p.251 |
| | [C] EQ Trim | 0...100 | Sets the EQ input level | |
| d | [C] Pre LEQ Gain [dB] | -15...+15 | Sets the gain of Low EQ | |
| | Pre HEQ Gain [dB] | -15...+15 | Sets the gain of High EQ | |
| MULTITAP DELAY | | | | |
| e | [D] Tap1 Time [msec] | 0.0...1360.0 | Sets the Tap1 delay time | |
| | Tap1 Level | 0...100 | Sets the Tap1 output level | p.290 |
| f | [D] Tap2 Time [msec] | 0.0...1360.0 | Sets the Tap2 delay time | |
| | Feedback (Tap2) | -100...+100 | Sets the Tap2 feedback amount | |
| g | [D] High Damp [%] | 0...100 | Sets the damping amount in the high range | p.289 |
| h | [D] Mt. Delay Wet/Dry | Dry, 1 : 99...99 : 1, Wet | Sets the multitap delay effect balance | |
| | Src | Off...Tempo | Selects the Wet/Dry modulation source for the multitap delay | |
| | Amt | -100...+100 | Sets the Wet/Dry modulation amount for the multitap delay | |
| i | Routing | Comp → Mt. Delay, Mt. Delay → Comp | Switches the order of the compressor and multitap delay | |
| j | Wet/Dry | Dry, 1 : 99...99 : 1, Wet | Sets the balance between the effect and the dry input | |
| | Src | Off...Tempo | Selects a modulation source for Wet/Dry | |
| | Amt | -100...+100 | Sets the modulation amount for Wet/Dry | |

107: Limiter - P4EQ (Limiter - Parametric 4-Band EQ)

This effect combines a mono limiter and a four-band parametric equalizer. You can change the order of the effects.

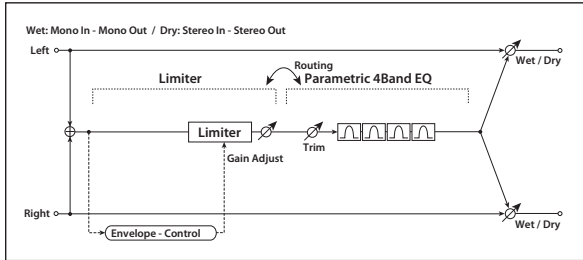

| LIMITER | | | |
|---------|---------------------|---------------------------------|--|
| a | [L]Ratio | 1.0 : 1... 50.0 : 1, Inf : 1 | Sets the signal compression ratio p.307 |
| | Threshold [dB] | -40...0 | Sets the level above which the compressor is applied p.307 |
| b | [L]Attack | 1...100 | Sets the attack time |
| | Release | 1...100 | Sets the release time |
| c | [L]Gain Adjust [dB] | -Inf...+24 | Sets the limiter output gain p.307 |
| | P4EQ | | |
| d | [E]Trim | 0...100 | Sets the parametric EQ input level |
| e | [E]B1 Cutoff [Hz] | 20...1.00k | Sets the center frequency of Band 1 |
| | Q | 0.5...10.0 | Sets the bandwidth of Band 1 p.255 |
| | Gain [dB] | -18...+18 | Sets the gain of Band 1 |
| f | [E]B2 Cutoff [Hz] | 50...5.00k | Sets the center frequency of Band 2 |
| | Q | 0.5...10.0 | Sets the bandwidth of Band 2 p.255 |
| | Gain [dB] | -18...+18 | Sets the gain of Band 2 |
| g | [E]B3 Cutoff [Hz] | 300...10.00k | Sets the center frequency of Band 3 |
| | Q | 0.5...10.0 | Sets the bandwidth of Band 3 p.255 |
| | Gain [dB] | -18...+18 | Sets the gain of Band 3 |
| h | [E]B4 Cutoff [Hz] | 500...20.00k | Sets the center frequency of Band 4 |
| | Q | 0.5...10.0 | Sets the bandwidth of Band 4 p.255 |
| | Gain [dB] | -18...+18 | Sets the gain of Band 4 |
| i | Routing | Limiter→P4EQ, P4EQ→Limiter | Switches the order of the limiter and parametric EQ |
| j | Wet/Dry | Dry, 1 : 99... 99 : 1, Wet | Sets the balance between the effect and the dry input D-mod |
| | Src | Off...Tempo | Selects a modulation source for Wet/Dry |
| | Amt | -100...+100 | Sets the modulation amount for Wet/Dry |

a: [L]Ratio

a: Threshold [dB]

c: [L]Gain Adjust [dB]

This parameter sets the signal compression **[L]Ratio**. Compression is applied only when the signal level exceeds the **Threshold** value.

Adjust the output level using the **Gain Adjust** parameter, since compression causes the entire level to be reduced.

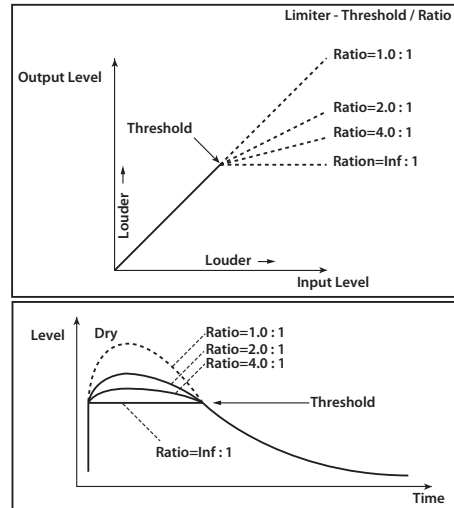

108: Limiter - Cho/Flng (Limiter - Chorus/Flanger)

This effect combines a mono limiter and a chorus/flanger. You can change the order of the effects.

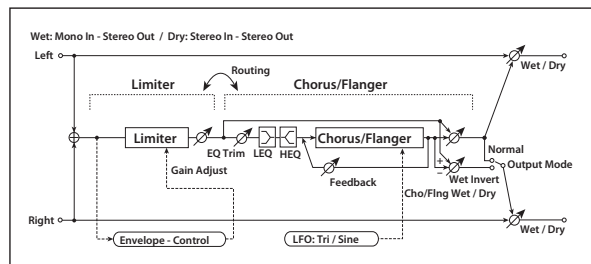

| LIMITER | | | |
|---------|-----------------------|--|--|
| a | [L]Ratio | 1.0 : 1... 50.0 : 1, Inf : 1 | Sets the signal compression ratio p.307 |
| | Threshold [dB] | -40...0 | Sets the level above which the compressor is applied p.307 |
| b | [L]Attack | 1...100 | Sets the attack time |
| | Release | 1...100 | Sets the release time |
| c | [L]Gain Adjust [dB] | -Inf...+24 | Sets the limiter output gain p.307 |
| | CHORUS/FLANGER | | |
| d | [F]LFO Frequency [Hz] | 0.02...20.00 | Sets the speed of the LFO |
| | LFO Waveform | Triangle, Sine | Selects the LFO Waveform |
| e | [F]Delay Time [msec] | 0.0...1350.0 | Sets the delay time |
| | Depth | 0...100 | Sets the depth of LFO modulation |
| | Feedback | -100...+100 | Sets the feedback amount p.272 |
| f | [F]EQ Trim | 0...100 | Sets the EQ input level |
| g | [F]Pre LEQ Gain [dB] | -15...+15 | Sets the gain of Low EQ |
| | Pre HEQ Gain [dB] | -15...+15 | Sets the gain of High EQ |
| h | [F]Cho/Flng Wet/Dry | -Wet... -1 : 99, Dry, 1 : 99...Wet | Sets the effect balance of the chorus/flanger p.259, p.272 D-mod |
| | Src | Off...Tempo | Selects the Wet/Dry modulation source for the chorus/flanger |
| | Amt | -100...+100 | Sets the Wet/Dry modulation amount for the chorus/flanger |

| | | | | |
|---|----------------|---------------------------------------|---|--|
| i | [F]Output Mode | Normal, Wet Invert | Selects the output mode for the chorus/flanger p.305 | |
| | Routing | Limiter → Flanger → Flanger → Limiter | Switches the order of the limiter and chorus/flanger | |
| j | Wet/Dry | Dry, 1 : 99... 99 : 1, Wet | Sets the balance between the effect and the dry input | |
| | Src | Off...Tempo | Selects a modulation source for Wet/Dry | |
| | Amt | -100...+100 | Sets the modulation amount for Wet/Dry | |

109: Limiter - Phaser

This effect combines a mono limiter and a phaser. You can change the order of the effects.

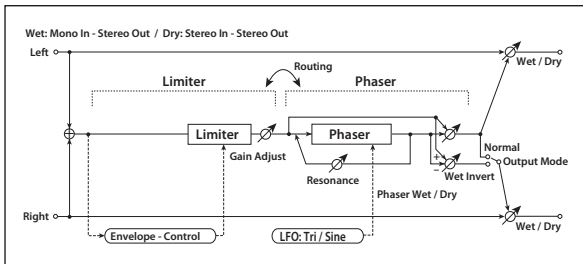

| LIMITER | | | | |
|---------|-----------------------|------------------------------------|--|--|
| a | [L]Ratio | 1.0 : 1... 50.0 : 1, Inf : 1 | Sets the signal compression ratio p.307 | |
| | Threshold [dB] | -40...0 | Sets the level above which the compressor is applied p.307 | |
| b | [L]Attack | 1...100 | Sets the attack time | |
| | Release | 1...100 | Sets the release time | |
| c | [L]Gain Adjust [dB] | -Inf, -38...+24 | Sets the limiter output gain p.307 | |
| PHASER | | | | |
| d | [P]LFO Frequency [Hz] | 0.02...20.00 | Sets the speed of the LFO | |
| | LFO Waveform | Triangle, Sine | Selects the LFO Waveform | |
| e | [P]Manual | 0...100 | Sets the frequency to which the effect is applied | |
| | Depth | 0...100 | Sets the depth of LFO modulation | |
| | Resonance | -100...+100 | Sets the resonance amount p.274 | |
| f | [P]Phaser Wet/Dry | -Wet... -1 : 99, Dry, 1 : 99...Wet | Sets the phaser effect balance p.259, p.274 | |
| | Src | Off...Tempo | Selects the phaser's Wet/Dry modulation source | |
| | Amt | -100...+100 | Sets the phaser's Wet/Dry modulation amount | |
| g | [P]Output Mode | Normal, Wet Invert | Selects the phaser output mode p.302 | |
| h | Routing | Limiter → Phaser, Phaser → Limiter | Switches the order of the limiter and phaser p.305 | |
| i | Wet/Dry | Dry, 1 : 99... 99 : 1, Wet | Sets the balance between the effect and the dry input | |
| | Src | Off...Tempo | Selects a modulation source for Wet/Dry | |
| | Amt | -100...+100 | Sets the modulation amount for Wet/Dry | |

110: Limiter - Mt.Delay (Limiter - Multitap Delay)

This effect combines a mono limiter and a multitap delay. You can change the order of the effects.

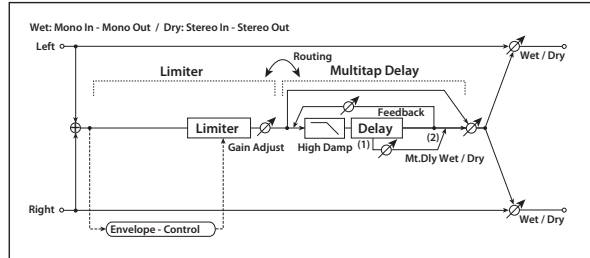

| LIMITER | | | | |
|----------------|---------------------|--|--|--|
| a | [L]Ratio | 1.0 : 1... 50.0 : 1, Inf : 1 | Sets the signal compression ratio p.307 | |
| | Threshold [dB] | -40...0 | Sets the level above which the compressor is applied p.307 | |
| b | [L]Attack | 1...100 | Sets the attack time | |
| | Release | 1...100 | Sets the release time | |
| c | [L]Gain Adjust [dB] | -Inf, -38...+24 | Sets the limiter output gain p.307 | |
| MULTITAP DELAY | | | | |
| d | [D]Tap1 Time [msec] | 0.0...1360.0 | Sets the Tap1 delay time | |
| | Tap1 Level | 0...100 | Sets the Tap1 output level p.290 | |
| e | [D]Tap2 Time [msec] | 0.0...1360.0 | Sets the Tap2 delay time | |
| | Feedback | -100...+100 | Sets the Tap2 feedback amount | |
| f | [D]High Damp [%] | 0...100 | Sets the damping amount in the high range p.289 | |
| g | [D]Mt.Delay Wet/Dry | Dry, 1 : 99... 99 : 1, Wet | Sets the multitap delay effect balance | |
| | Src | Off...Tempo | Selects the multitap delay's Wet/Dry modulation source | |
| | Amt | -100...+100 | Sets the multitap delay's Wet/Dry modulation amount | |
| h | Routing | Limiter → Mt.Delay, Mt.Delay → Limiter | Switches the order of the limiter and multitap delay | |
| i | Wet/Dry | Dry, 1 : 99... 99 : 1, Wet | Sets the balance between the effect and the dry input | |
| | Src | Off...Tempo | Selects a modulation source for Wet/Dry | |
| | Amt | -100...+100 | Sets the modulation amount for Wet/Dry | |

111: Exciter - Comp (Exciter - Compressor)

This effect combines a mono exciter and a compressor. You can change the order of the effects.

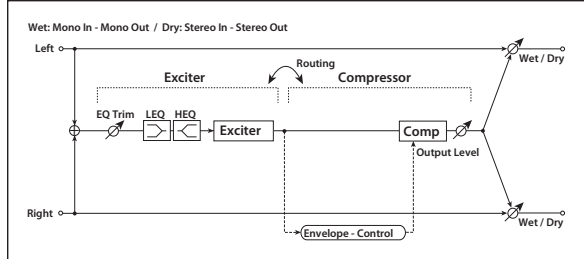

| EXCITER | | | | |
|------------|-----------------------|--------------------------------|---|-------|
| a | [X]Exciter Blend | -100...+100 | Sets the intensity (depth) of the Exciter effect | p.256 |
| b | [X]Emphasis Frequency | 0...70 | Sets the frequency range to be emphasized | p.256 |
| c | [X]EQ Trim | 0...100 | Sets the EQ input level | |
| d | [X]Pre LEQ Gain [dB] | -15...+15 | Sets the gain of Low EQ | |
| | Pre HEQ Gain [dB] | -15...+15 | Sets the gain of High EQ | |
| COMPRESSOR | | | | |
| e | [C]Sensitivity | 1...100 | Sets the sensitivity | p.251 |
| f | [C]Attack | 1...100 | Sets the attack level | p.251 |
| | Output Level | 0...100 | Sets the compressor output level | p.251 |
| g | Routing | Exciter → Comp, Comp → Exciter | Switches the order of the exciter and compressor | |
| h | Wet/Dry | Dry, 1 : 99... 99 : 1, Wet | Sets the balance between the effect and the dry input | |
| | Src | Off...Tempo | Selects a modulation source for Wet/Dry | |
| | Amt | -100...+100 | Sets the modulation amount for Wet/Dry | |

112: Exciter - Limiter

This effect combines a mono exciter and a limiter. You can change the order of the effects.

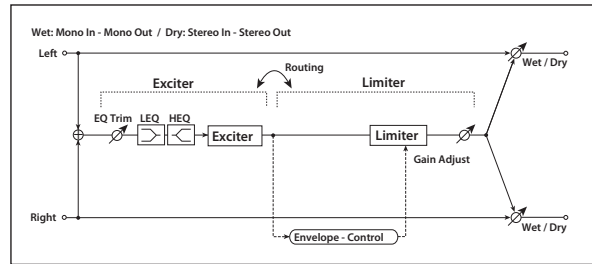

| EXCITER | | | | |
|---------|-----------------------|--------------------------------------|---|-------|
| a | [X]Exciter Blend | -100...+100 | Sets the intensity (depth) of the Exciter effect | p.256 |
| b | [X]Emphasis Frequency | 0...70 | Sets the frequency range to be emphasized | p.256 |
| c | [X]Trim | 0...100 | Sets the EQ input level | |
| d | [X]Pre LEQ Gain [dB] | -15...+15 | Sets the gain of Low EQ | |
| | Pre HEQ Gain [dB] | -15...+15 | Sets the gain of High EQ | |
| LIMITER | | | | |
| e | [L]Ratio | 1.0 : 1... 50.0 : 1, Inf : 1 | Sets the signal compression ratio | p.307 |
| f | [L]Threshold [dB] | -40...0 | Sets the level above which the compressor is applied | p.307 |
| g | [L]Attack | 1...100 | Sets the attack time | |
| | Release | 1...100 | Sets the release time | |
| h | [L]Gain Adjust [dB] | -Inf, -38...+24 | Sets the limiter output gain | p.307 |
| i | Routing | Exciter → Limiter, Limiter → Exciter | Switches the order of the exciter and limiter | |
| j | Wet/Dry | Dry, 1 : 99... 99 : 1, Wet | Sets the balance between the effect and the dry input | |
| | Src | Off...Tempo | Selects a modulation source for Wet/Dry | |
| | Amt | -100...+100 | Sets the modulation amount for Wet/Dry | |

113: Exciter - Cho/Flng (Exciter - Chorus/Flanger)

This effect combines a mono limiter and a chorus/flanger.

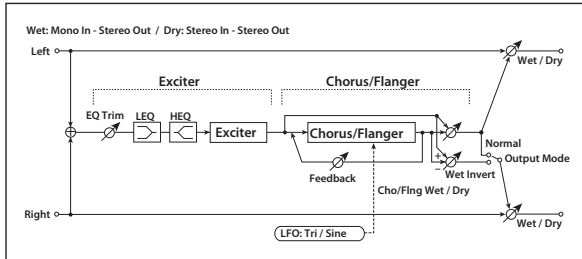

| EXCITER | | | |
|----------------|-----------------------|-----------------------------------|--|
| a | [X]Exciter Blend | -100...+100 | Sets the intensity (depth) of the Exciter effect p.256 |
| b | [X]Emphasis Frequency | 0...70 | Sets the frequency range to be emphasized p.256 |
| c | [X]Trim | 0...100 | Sets the EQ input level |
| d | [X]Pre LEQ Gain [dB] | -15...+15 | Sets the gain of Low EQ |
| | Pre HEQ Gain [dB] | -15...+15 | Sets the gain of High EQ |
| CHORUS/FLANGER | | | |
| e | [F]LFO Frequency [Hz] | 0.02...20.00 | Sets the speed of the LFO |
| | LFO Waveform | Triangle, Sine | Selects the LFO Waveform |
| f | [F]Delay Time [msec] | 0.0...1350.0 | Sets the delay time |
| | Depth | 0...100 | Sets the depth of LFO modulation |
| | Feedback | -100...+100 | Sets the feedback amount p.272 |
| g | [F]Cho/Flng Wet/Dry | -Wet...-1 : 99, Dry, 1 : 99...Wet | Sets the effect balance of the chorus/flanger p.259, p.272 |
| | Src | Off...Tempo | Selects the Wet/Dry modulation source for the chorus/flanger |
| | Amt | -100...+100 | Sets the Wet/Dry modulation amount for the chorus/flanger |
| h | [F]Output Mode | Normal, Wet Invert | Selects the output mode for the chorus/flanger p.302 |
| i | Wet/Dry | Dry, 1 : 99... 99 : 1, Wet | Sets the balance between the effect and the dry input |
| | Src | Off...Tempo | Selects a modulation source for Wet/Dry |
| | Amt | -100...+100 | Sets the modulation amount for Wet/Dry |

114: Exciter - Phaser

This effect combines a mono limiter and a phaser.

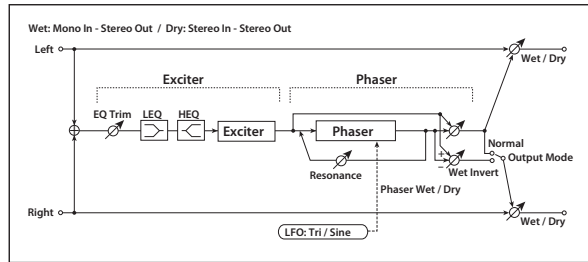

| EXCITER | | | |
|---------|-----------------------|-----------------------------------|--|
| a | [X]Exciter Blend | -100...+100 | Sets the intensity (depth) of the Exciter effect p.256 |
| b | [X]Emphasis Frequency | 0...70 | Sets the frequency range to be emphasized p.256 |
| c | [X]Trim | 0...100 | Sets the EQ input level |
| d | [X]Pre LEQ Gain [dB] | -15...+15 | Sets the gain of Low EQ |
| | Pre HEQ Gain [dB] | -15...+15 | Sets the gain of High EQ |
| PHASER | | | |
| e | [P]LFO Frequency [Hz] | 0.02...20.00 | Sets the speed of the LFO |
| | LFO Waveform | Triangle, Sine | Selects the LFO Waveform |
| f | [P]Manual | 0...100 | Sets the frequency to which the effect is applied |
| | Depth | 0...100 | Sets the depth of LFO modulation |
| | Resonance | -100...+100 | Sets the resonance amount p.274 |
| g | [P]Phaser Wet/Dry | -Wet...-1 : 99, Dry, 1 : 99...Wet | Sets the phaser effect balance p.259, p.274 |
| | Src | Off...Tempo | Selects the Wet/Dry modulation source for the phaser |
| | Amt | -100...+100 | Sets the Wet/Dry modulation amount for the phaser |
| h | [P]Output Mode | Normal, Wet Invert | Selects the phaser output mode p.302 |
| i | Wet/Dry | Dry, 1 : 99... 99 : 1, Wet | Sets the balance between the effect and the dry input |
| | Src | Off...Tempo | Selects a modulation source for Wet/Dry |
| | Amt | -100...+100 | Sets the modulation amount for Wet/Dry |

115: Exciter - Mt.Delay (Exciter - Multitap Delay)

This effect combines a mono exciter and a multitap delay.

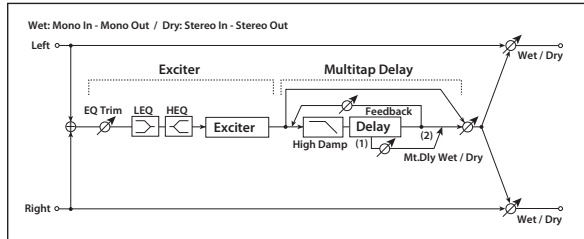

| EXCITER | | | |
|----------------|-----------------------|----------------------------|--|
| a | [X]Exciter Blend | -100...+100 | Sets the intensity (depth) of the Exciter effect p.256 |
| b | [X]Emphasis Frequency | 0...70 | Sets the frequency range to be emphasized p.256 |
| c | [X]Trim | 0...100 | Sets the EQ input level |
| d | [X]Pre LEQ Gain [dB] | -15...+15 | Sets the gain of Low EQ |
| | Pre HEQ Gain [dB] | -15...+15 | Sets the gain of High EQ |
| MULTITAP DELAY | | | |
| e | [D]Tap1 Time [msec] | 0.0...1360.0 | Sets the Tap1 delay time |
| | Tap1 Level | 0...100 | Sets the Tap1 output level p.290 |
| f | [D]Tap2 Time [msec] | 0.0...1360.0 | Sets the Tap2 delay time |
| | Feedback (Tap2) | -100...+100 | Sets the Tap2 feedback amount |
| g | [D]High Damp [%] | 0...100 | Sets the damping amount in the high range p.289 |
| h | [D]Mt.Delay Wet/Dry | Dry, 1 : 99... 99 : 1, Wet | Sets the multitap delay effect balance D-mod |
| | Src | Off...Tempo | Selects the Wet/Dry modulation source for the multitap delay |
| | Amt | -100...+100 | Sets the Wet/Dry modulation amount for the multitap delay |
| i | Wet/Dry | Dry, 1 : 99... 99 : 1, Wet | Sets the balance between the effect and the dry input D-mod |
| | Src | Off...Tempo | Selects a modulation source for Wet/Dry |
| | Amt | -100...+100 | Sets the modulation amount for Wet/Dry |

116: OD/HG - Amp Sim (Overdrive/Hi.Gain - Amp Simulation)

This effect combines a mono overdrive/high-gain distortion and an amp simulation. You can change the order of the effects.

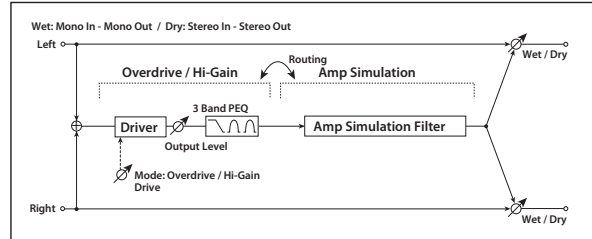

| OD/HI-GAIN | | | |
|------------|---------------------|----------------------------|--|
| a | [O]Drive Mode | Overdrive, Hi-Gain | Switches between overdrive and high-gain distortion |
| | Drive | 1...100 | Sets the degree of distortion p.263 |
| b | [O]Output Level | 0...50 | Sets the overdrive output level p.263 D-mod |
| | Src | Off...Tempo | Selects the modulation source for the overdrive output level |
| | Amt | -50...+50 | Sets the modulation amount of the overdrive output level |
| e | [O]Low Cutoff [Hz] | 20...1.00k | Sets the center frequency for Low EQ (shelving type) |
| | Gain [dB] | -18...+18 | Sets the gain of Low EQ |
| f | [O]Mid1 Cutoff [Hz] | 300...10.00k | Sets the center frequency for Mid/High EQ 1 (peaking type) |
| | Q | 0.5...10.0 | Sets the band width of Mid/High EQ 1 p.255 |
| | Gain [dB] | -18...+18 | Sets the gain of Mid/High EQ 1 |
| g | [O]Mid2 Cutoff [Hz] | 500...20.00k | Sets the center frequency for Mid/High EQ 2 (peaking type) |
| | Q | 0.5...10.0 | Sets the band width of Mid/High EQ 2 p.255 |
| | Gain [dB] | -18...+18 | Sets the gain of Mid/High EQ 2 |
| AMP SIM | | | |
| h | [A]Amplifier Type | SS, EL84, 6L6 | Selects the type of guitar amplifie |
| i | Routing | OD/HG → Amp, Amp → OD/HG | Switches the order of the overdrive and amp |
| j | Wet/Dry | Dry, 1 : 99... 99 : 1, Wet | Sets the balance between the effect and the dry input D-mod |
| | Src | Off...Tempo | Selects a modulation source for Wet/Dry |
| | Amt | -100...+100 | Sets the modulation amount for Wet/Dry |

117: OD/HG - Cho/Flng (Overdrive/Hi.Gain - Chorus/ Flanger)

This effect combines a mono overdrive/high-gain distortion and a chorus/flanger. You can change the order of the effects.

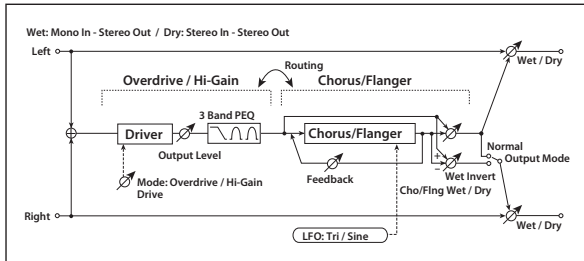

| OD/HI-GAIN | | | |
|---------------------|-----------------------|-----------------------------------|--|
| a | [O]Drive Mode | Overdrive, Hi-Gain | Switches between overdrive and high-gain distortion |
| | Drive | 1...100 | Sets the degree of distortion p.263 |
| | [O]Output Level | 0...50 | Sets the overdrive output level p.263 |
| b | Src | Off...Tempo | Selects the modulation source for the overdrive output level |
| | Amt | -50...+50 | Sets the modulation amount of the overdrive output level |
| | [O]Low Cutoff [Hz] | 20...1.00k | Sets the center frequency for Low EQ (shelving type) |
| e | Gain [dB] | -18...+18 | Sets the gain of Low EQ |
| | [O]Mid1 Cutoff [Hz] | 300...10.00k | Sets the center frequency for Mid/High EQ 1 (peaking type) |
| | f | Q | 0.5...10.0 |
| Gain [dB] | | -18...+18 | Sets the gain of Mid/High EQ 1 |
| [O]Mid2 Cutoff [Hz] | | 500...20.00k | Sets the center frequency for Mid/High EQ 2 (peaking type) |
| g | Q | 0.5...10.0 | Sets the band width of Mid/High EQ 2 p.255 |
| | Gain [dB] | -18...+18 | Sets the gain of Mid/High EQ 2 |
| | CHORUS/FLANGER | | |
| h | [F]LFO Frequency [Hz] | 0.02...20.00 | Sets the speed of the LFO |
| | LFO Waveform | Triangle, Sine | Selects the LFO Waveform |
| i | [F]Delay Time [msec] | 0.0...1350.0 | Sets the delay time |
| | Depth | 0...100 | Sets the depth of LFO modulation |
| | Feedback | -100...+100 | Sets the feedback amount p.272 |
| j | [F]Cho/Flng Wet/Dry | -Wet...-1 : 99, Dry, 1 : 99...Wet | Sets the effect balance of the chorus/flanger p.259, p.272 |
| | Src | Off...Tempo | Selects the Wet/Dry modulation source for the chorus/flanger |
| | Amt | -100...+100 | Sets the Wet/Dry modulation amount for the chorus/flanger |
| k | [F]Output Mode | Normal, Wet Invert | Selects the output mode for the chorus/flanger p.305 |
| | Routing | OD/HG→ Flanger, Flanger→ OD/HG | Switches the order of the overdrive and chorus / flanger |
| l | Wet/Dry | Dry, 1 : 99... 99 : 1, Wet | Sets the balance between the effect and the dry input |
| | Src | Off...Tempo | Selects a modulation source for Wet/Dry |
| | Amt | -100...+100 | Sets the modulation amount for Wet/Dry |

118: OD/HG - Phaser (Overdrive/Hi.Gain - Phaser)

This effect combines a mono overdrive/high-gain distortion and a phaser. You can change the order of the effects.

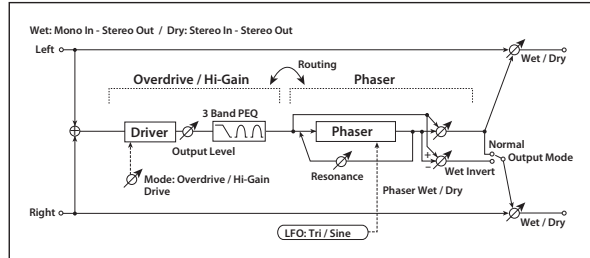

| OD/HI-GAIN | | | |
|---------------------|-----------------------|-----------------------------------|--|
| a | [O]Drive Mode | Overdrive, Hi-Gain | Switches between overdrive and high-gain distortion |
| | Drive | 1...100 | Sets the degree of distortion p.263 |
| | [O]Output Level | 0...50 | Sets the overdrive output level p.263 |
| b | Src | Off...Tempo | Selects the modulation source for the overdrive output level |
| | Amt | -50...+50 | Sets the modulation amount of the overdrive output level |
| | [O]Low Cutoff [Hz] | 20...1.00k | Sets the center frequency for Low EQ (shelving type) |
| e | Gain [dB] | -18...+18 | Sets the gain of Low EQ |
| | [O]Mid1 Cutoff [Hz] | 300...10.00k | Sets the center frequency for Mid/High EQ 1 (peaking type) |
| | f | Q | 0.5...10.0 |
| Gain [dB] | | -18...+18 | Sets the gain of Mid/High EQ 1 |
| [O]Mid2 Cutoff [Hz] | | 500...20.00k | Sets the center frequency for Mid/High EQ 2 (peaking type) |
| g | Q | 0.5...10.0 | Sets the band width of Mid/High EQ 2 p.255 |
| | Gain [dB] | -18...+18 | Sets the gain of Mid/High EQ 2 |
| | PHASER | | |
| h | [P]LFO Frequency [Hz] | 0.02...20.00 | Sets the speed of the LFO |
| | LFO Waveform | Triangle, Sine | Selects the LFO Waveform |
| i | [P]Manual | 0...100 | Sets the frequency to which the effect is applied |
| | Depth | 0...100 | Sets the depth of LFO modulation |
| | Resonance | -100...+100 | Sets the resonance amount p.274 |
| j | [P]Phaser Wet/Dry | -Wet...-1 : 99, Dry, 1 : 99...Wet | Sets the phaser effect balance p.259, p.274 |
| | Src | Off...Tempo | Selects the Wet/Dry modulation source for the phaser |
| | Amt | -100...+100 | Sets the Wet/Dry modulation amount for the phaser |
| k | [P]Output Mode | Normal, Wet Invert | Selects the phaser output mode p.305 |
| | Routing | OD/HG→ Phaser, Phaser→ OD/HG | Switches the order of the overdrive and phaser p.305 |
| l | Wet/Dry | Dry, 1 : 99... 99 : 1, Wet | Sets the balance between the effect and the dry input |
| | Src | Off...Tempo | Selects a modulation source for Wet/Dry |
| | Amt | -100...+100 | Sets the modulation amount for Wet/Dry |

119: OD/HG - Mt.Delay (Overdrive/Hi.Gain - Multitap Delay)

This effect combines a mono overdrive/high-gain distortion and a multitap delay.

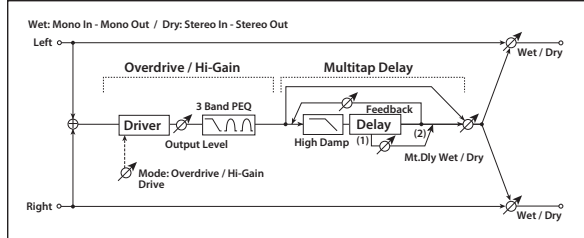

| OD/HI-GAIN | | | |
|----------------|---------------------|----------------------------|--|
| a | [O]Drive Mode | Overdrive, Hi-Gain | Switches between overdrive and high-gain distortion |
| | Drive | 1...100 | Sets the degree of distortion p.263 |
| b | [O]Output Level | 0...50 | Sets the overdrive output level p.263 D-mod |
| | Src | Off...Tempo | Selects the modulation source for the overdrive output level |
| | Amt | -50...+50 | Sets the modulation amount of the overdrive output level |
| e | [O]Low Cutoff [Hz] | 20...1.00k | Sets the center frequency for Low EQ (shelving type) |
| | Gain [dB] | -18...+18 | Sets the gain of Low EQ |
| f | [O]Mid1 Cutoff [Hz] | 300...10.00k | Sets the center frequency for Mid/High EQ 1 (peaking type) |
| | Q | 0.5...10.0 | Sets the band width of Mid/High EQ 1 p.255 |
| | Gain [dB] | -18...+18 | Sets the gain of Mid/High EQ 1 |
| g | [O]Mid2 Cutoff [Hz] | 500...20.00k | Sets the center frequency for Mid/High EQ 2 (peaking type) |
| | Q | 0.5...10.0 | Sets the band width of Mid/High EQ 2 p.255 |
| | Gain [dB] | -18...+18 | Sets the gain of Mid/High EQ 2 |
| MULTITAP DELAY | | | |
| h | [D]Tap1 Time [msec] | 0.0...1360.0 | Sets the Tap1 delay time |
| | Tap1 Level | 0...100 | Sets the Tap1 output level p.290 |
| i | [D]Tap2 Time [msec] | 0.0...1360.0 | Sets the Tap2 delay time |
| | Feedback | -100...+100 | Sets the Tap2 feedback amount |
| j | [D]High Damp [%] | 0...100 | Sets the damping amount in the high range p.289 |
| k | [D]Mt.Delay Wet/Dry | Dry, 1 : 99... 99 : 1, Wet | Sets the multitap delay effect balance D-mod |
| | Src | Off...Tempo | Selects the Wet/Dry modulation source for the multitap delay |
| | Amt | -100...+100 | Sets the Wet/Dry modulation amount for the multitap delay |
| l | Wet/Dry | Dry, 1 : 99... 99 : 1, Wet | Sets the balance between the effect and the dry input D-mod |
| | Src | Off...Tempo | Selects a modulation source for Wet/Dry |
| | Amt | -100...+100 | Sets the modulation amount for Wet/Dry |

120: Wah - Amp Sim (Wah - Amp Simulation)

This effect combines a mono wah and an amp simulation. You can change the order of the effects.

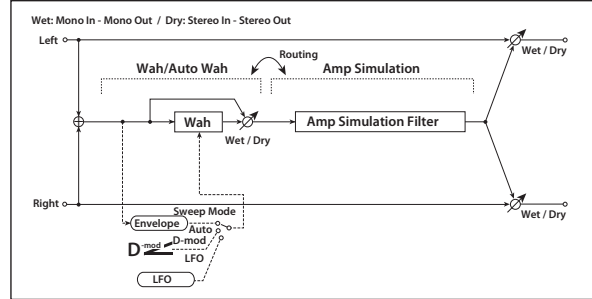

| WAH | | | |
|---------|-----------------------|----------------------------|--|
| a | [W]Frequency Bottom | 0...100 | Sets the lower limit of the wah center frequency p.257 |
| | Frequency Top | 0...100 | Sets the upper limit of the wah center frequency p.257 |
| b | [W]Sweep Mode | Auto, D-mod, LFO | Selects the control from auto-wah, modulation source, and LFO p.257 |
| | Src | Off...Tempo | Selects the modulation source for the wah when Sweep Mode=D-mod D-mod |
| c | [W]LFO Frequency [Hz] | 0.02...20.00 | Sets the speed of the LFO |
| | Resonance | 0...100 | Sets the resonance amount |
| | LPF | Off, On | Switches the wah low pass filter on and off |
| d | [W]Wet/Dry | Dry, 1 : 99... 99 : 1, Wet | Sets the wah effect balance D-mod |
| | Src | Off...Tempo | Selects the Wet/Dry modulation source for the wah |
| | Amt | -100...+100 | Sets the Wet/Dry modulation amount for the wah |
| AMP SIM | | | |
| e | [A]Amplifier Type | SS, EL84, 6L6 | Selects the type of guitar amplifier |
| f | Routing | Wah → Amp, Amp → Wah | Switches the order of the wah and amp simulation |
| g | Wet/Dry | Dry, 1 : 99... 99 : 1, Wet | Sets the balance between the effect and the dry input D-mod |
| | Src | Off...Tempo | Selects a modulation source for Wet/Dry |
| | Amt | -100...+100 | Sets the modulation amount for Wet/Dry |

121: Decimator - Amp (Decimator - Amp Simulation)

This effect combines a mono decimator and an amp simulation. You can change the order of the effects.

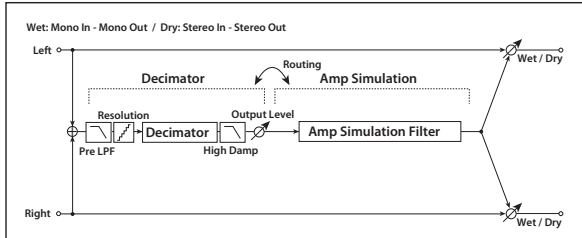

| DECIMATOR | | | |
|-----------|----------------------------|----------------------------------|---|
| a | [D]Pre LPF | Off, On | Turn the harmonic noise caused by lowered sampling on and off p.262 |
| | High Damp [%] | 0...100 | Sets the ratio of high-range damping |
| b | [D]Sampling Frequency [Hz] | 1.00k...48.00k | Sets the sampling frequency |
| | Resolution | 4...24 | Sets the data bit length p.262 |
| c | [D]Output Level | 0...100 | Sets the decimator output level p.262 |
| AMP SIM | | | |
| d | [A]Amplifier Type | SS, EL84, 6L6 | Selects the type of guitar amplifier |
| e | Routing | Decimator → Amp, Amp → Decimator | Switches the order of the decimator and amp simulation |
| f | Wet/Dry | Dry, 1 : 99... 99 : 1, Wet | Sets the balance between the effect and the dry input |
| | Src | Off...Tempo | Selects a modulation source for Wet/Dry |
| | Amt | -100...+100 | Sets the modulation amount for Wet/Dry |

122: Decimator - Comp (Decimator - Compressor)

This effect combines a mono decimator and a compressor. You can change the order of the effects.

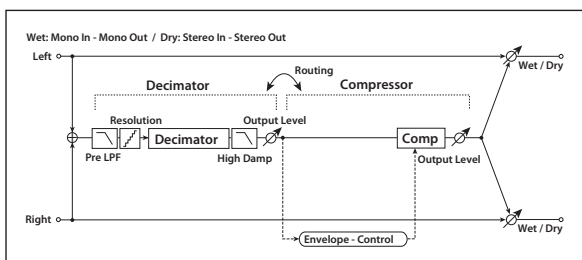

| DECIMATOR | | | |
|------------|----------------------------|----------------|---|
| a | [D]Pre LPF | Off, On | Turn the harmonic noise caused by lowered sampling on and off p.262 |
| | High Damp [%] | 0...100 | Sets the ratio of high-range damping |
| b | [D]Sampling Frequency [Hz] | 1.00k...48.00k | Sets the sampling frequency |
| | Resolution | 4...24 | Sets the data bit length p.262 |
| c | [D]Output Level | 0...100 | Sets the decimator output level p.262 |
| COMPRESSOR | | | |
| d | [C]Sensitivity | 1...100 | Sets the sensitivity p.251 |

| | | | | |
|---|--------------|------------------------------------|---|--|
| e | [C]Attack | 1...100 | Sets the attack level p.251 | |
| | Output Level | 0...100 | Sets the compressor output level p.251 | |
| f | Routing | Decimator → Comp, Comp → Decimator | Switches the order of the decimator and compressor | |
| g | Wet/Dry | Dry, 1 : 99... 99 : 1, Wet | Sets the balance between the effect and the dry input | |
| | Src | Off...Tempo | Selects a modulation source for Wet/Dry | |
| | Amt | -100...+100 | Sets the modulation amount for Wet/Dry | |

123: AmpSim - Tremolo (Amp Simulation - Tremolo)

This effect combines a mono amp simulation and a tremolo.

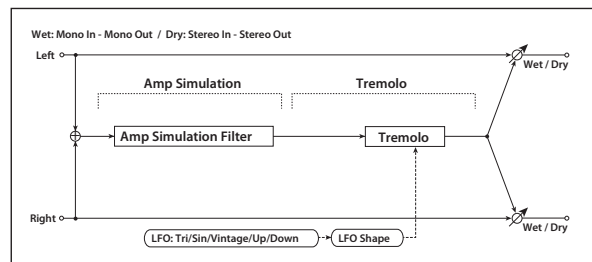

| AMP SIM | | | |
|---------|-----------------------|-----------------------------------|---|
| a | [A]Amplifier Type | SS, EL84, 6L6 | Selects the type of guitar amplifier |
| TREMLO | | | |
| b | [T]LFO Waveform | Triangle, Sine, Vintage, Up, Down | Selects the LFO Waveform p.281 |
| | LFO Shape | -100...+100 | Changes the curvature of the LFO Waveform p.258 |
| c | [T]LFO Frequency [Hz] | 0.02...20.00 | Sets the speed of the LFO |
| d | [T]Depth | 0...100 | Sets the depth of LFO modulation |
| e | Wet/Dry | Dry, 1 : 99... 99 : 1, Wet | Sets the balance between the effect and the dry input |
| | Src | Off...Tempo | Selects a modulation source for Wet/Dry |
| | Amt | -100...+100 | Sets the modulation amount for Wet/Dry |

124: Cho/Flng - Mt.Dly (Chorus/Flanger - Multitap Delay)

This effect combines a mono chorus/flanger and a multitap delay.

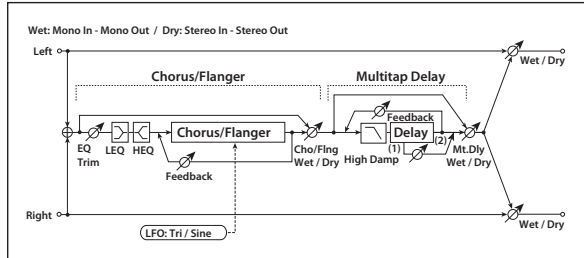

| CHORUS/FLANGER | | | | |
|----------------|-----------------------|-----------------------------------|--|------------------------|
| a | [F]LFO Frequency [Hz] | 0.02...20.00 | Sets the speed of the LFO | |
| | LFO Waveform | Triangle, Sine | Selects the LFO Waveform | |
| b | [F]Delay Time [msec] | 0.0...1350.0 | Sets the delay time | |
| | Depth | 0...100 | Sets the depth of LFO modulation | |
| | Feedback | -100...+100 | Sets the feedback amount | p.272 |
| c | [F]EQ Trim | 0...100 | Sets the EQ input level | |
| d | [F]PreLEQ Gain [dB] | -15...+15 | Sets the gain of Low EQ | |
| | PreHEQ Gain [dB] | -15...+15 | Sets the gain of High EQ | |
| e | [F]Cho/Flng Wet/Dry | -Wet...-1 : 99, Dry, 1 : 99...Wet | Sets the effect balance of the chorus/flanger | p.259, p.272 |
| MULTITAP DELAY | | | | |
| a | [D]Tap1 Time [msec] | 0.0...1360.0 | Sets the Tap1 delay time | |
| | Tap1 Level | 0...100 | Sets the Tap1 output level | p.290 |
| b | [D]Tap2 Time [msec] | 0.0...1360.0 | Sets the Tap2 delay time | |
| | Feedback | -100...+100 | Sets the Tap2 feedback amount | |
| c | [D]High Damp [%] | 0...100 | Sets the damping amount in the high range | p.289 |
| d | [D]Mt.DelayWet/Dry | Dry, 1 : 99...99 : 1, Wet | Sets the multitap delay effect balance | D^{mod} |
| | Src | Off...Tempo | Selects the Wet/Dry modulation source for the multitap delay | |
| | Amt | -100...+100 | Sets the Wet/Dry modulation amount for the multitap delay | |
| e | Wet/Dry | Dry, 1 : 99...99 : 1, Wet | Sets the balance between the effect and the dry input | D^{mod} |
| | Src | Off...Tempo | Selects a modulation source for Wet/Dry | |
| | Amt | -100...+100 | Sets the modulation amount for Wet/Dry | |

125: Phaser - Cho/Flng (Phaser - Chorus/Flanger)

This effect combines a mono phaser and a chorus/flanger.

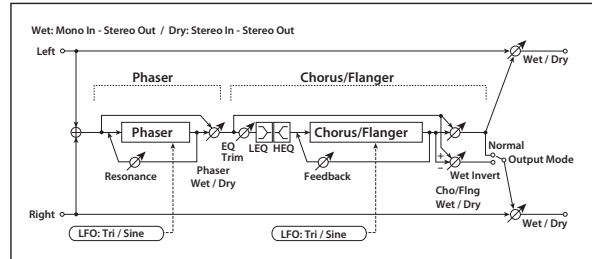

| PHASER | | | | |
|----------------|-----------------------|-----------------------------------|--|------------------------|
| a | [P]LFO Frequency [Hz] | 0.02...20.00 | Sets the speed of the LFO | |
| | LFO Waveform | Triangle, Sine | Selects the LFO Waveform | |
| b | [P]Manual | 0...100 | Sets the frequency to which the effect is applied | |
| | Depth | 0...100 | Sets the depth of LFO modulation | |
| | Resonance | -100...+100 | Sets the resonance amount | p.274 |
| c | [P]Phaser Wet/Dry | -Wet...-1 : 99, Dry, 1 : 99...Wet | Sets the phaser effect balance | p.259, p.274 |
| CHORUS/FLANGER | | | | |
| d | [F]LFO Frequency [Hz] | 0.02...20.00 | Sets the speed of the LFO | |
| | LFO Waveform | Triangle, Sine | Selects the LFO Waveform | |
| e | [F]Delay Time [msec] | 0.0...1350.0 | Sets the delay time | |
| | Depth | 0...100 | Sets the depth of LFO modulation | |
| | Feedback | -100...+100 | Sets the feedback amount | p.272 |
| f | [F]EQ Trim | 0...100 | Sets the EQ input level | |
| g | [F]PreLEQ Gain [dB] | -15...+15 | Sets the gain of Low EQ | |
| | PreHEQ Gain [dB] | -15...+15 | Sets the gain of High EQ | |
| h | [F]Cho/Flng Wet/Dry | -Wet...-1 : 99, Dry, 1 : 99...Wet | Sets the effect balance of the chorus/flanger | p.259, p.272 |
| | Src | Off...Tempo | Selects the Wet/Dry modulation source for the chorus/flanger | D^{mod} |
| | Amt | -100...+100 | Sets the Wet/Dry modulation amount for the chorus/flanger | |
| i | [F]Output Mode | Normal, Wet Invert | Selects the output mode for the chorus/flanger | p.302 |
| j | Wet/Dry | Dry, 1 : 99...99 : 1, Wet | Sets the balance between the effect and the dry input | D^{mod} |
| | Src | Off...Tempo | Selects a modulation source for Wet/Dry | |
| | Amt | -100...+100 | Sets the modulation amount for Wet/Dry | |

126: Reverb - Gate

This effect combines a mono reverb and a gate.

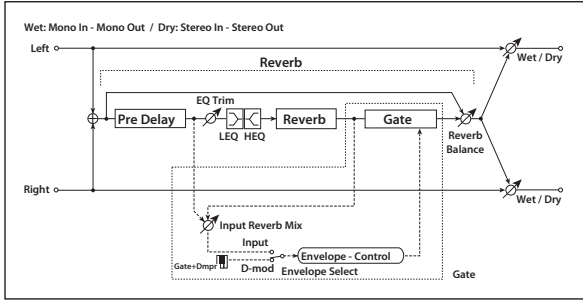

Normally, set **[G]Input Reverb Mix** to Dry (the gate is controlled only by the dry sound). If you wish to extend the gate time, set the **[G]Input Reverb Mix** value higher and adjust the **Threshold** value.

| REVERB | | | | |
|--------|----------------------|----------------------------|---|--|
| a | [R]Reverb Time [sec] | 0.1...10.0 | Sets the reverberation time | |
| | High Damp [%] | 0...100 | Sets the damping amount in the high range | |
| b | [R]Pre Delay [msec] | 0...200 | Sets the delay time of the reverb sound and gate control signal | |
| c | [R]EQ Trim | 0...100 | Sets the EQ input level | |
| | Reverb Balance | Dry, 1 : 99... 99 : 1, Wet | Sets the reverb effect balance | |
| d | [R]PreLEQ Fc | Low, Mid-Low | Selects the cutoff frequency (low or mid-low) of the low-range equalizer | |
| | Pre HEQ Fc | High, Mid-High | Selects the cutoff frequency (high or mid-high) of the high-range equalizer | |
| e | [R]PreLEQ Gain [dB] | -15.0...+15.0 | Sets the gain of Low EQ | |
| | Pre HEQ Gain [dB] | -15.0...+15.0 | Sets the gain of High EQ | |
| GATE | | | | |
| f | [G]Envelope Select | D-mod, Input | Switches between modulation source control and input signal control p.316 | |
| | Src | Off...Tempo | Selects the modulation source that controls the gate when Envelope Select is set to D-mod p.316 | |
| g | [G]Input Reverb Mix | Dry, 1 : 99... 99 : 1, Wet | Sets the balance between the dry and reverb sounds of the gate control signal p.316 | |
| | Threshold | 0...100 | Sets the gate threshold level p.316 | |
| h | [G]Polarity | +, - | Switches between non-invert and invert of the gate on/off state p.254 | |
| i | [G]Attack | 1...100 | Sets the attack time p.254 | |
| | Release | 1...100 | Sets the release time p.254 | |
| j | Wet/Dry | Dry, 1 : 99... 99 : 1, Wet | Sets the balance between the effect and the dry input | |
| | Src | Off...Tempo | Selects a modulation source for Wet/Dry | |
| | Amt | -100...+100 | Sets the modulation amount for Wet/Dry | |

f: [G]Envelope Select

f: Src

g: [G]Input Reverb Mix

g: Threshold

The **[G]Envelope Select** parameter enables you to select whether turning the gate on and off is triggered by the input signal level or controlled directly by the modulation source. You can select from Off to Gate2+Dmpr for the Src parameter to specify the modulation source.

When **[G]Envelope Select** is set to Input, the gate is controlled by the level of signals that are the combination of the dry sound and the reverb sound. When the signal level exceeds the threshold, the gate opens and the reverb sound is output.

Mono/Mono Parallel (Mono//Mono)

127: P4EQ // P4EQ (Parametric 4-Band EQ // Parametric 4-Band EQ) through 171: BPM DI // BPM DI (Multitap BPM Delay // Multitap BPM Delay) are parallel effects.

The pan and effect balance of each effect can be set independently.

In the screen, the L-side is shown as [1], and the R-side as [2].

These provide various combinations of 4-band EQ, Compressor, Limiter, Exciter, Overdrive, Wah, Chorus/Flanger, Phaser, and Multitap Delay, as described below.

P4EQ (4-band EQ)

| P4EQ | | | |
|------|-----------------------|----------------------------|---|
| a | Trim | 0...100 | Sets the input level |
| b | B1 Cutoff [Hz] | 20...1.00k | Sets the center frequency of Band 1 |
| | Q | 0.5...10.0 | Sets the bandwidth of Band 1 p.255 |
| | Gain [dB] | -18.0...+18.0 | Sets the gain of Band 1 |
| c | B2 Cutoff [Hz] | 50...5.00k | Sets the center frequency of Band 2 |
| | Q | 0.5...10.0 | Sets the bandwidth of Band 2 p.255 |
| | Gain [dB] | -18.0...+18.0 | Sets the gain of Band 2 |
| d | B3 Cutoff [Hz] | 300...10.00k | Sets the center frequency of Band 3 |
| | Q | 0.5...10.0 | Sets the bandwidth of Band3 p.255 |
| | Gain [dB] | -18.0...+18.0 | Sets the gain of Band 3 |
| e | B4 Cutoff [Hz] | 500...20.00k | Sets the center frequency of Band 4 |
| | Q | 0.5...10.0 | Sets the bandwidth of Band 4 p.255 |
| | Gain [dB] | -18.0...+18.0 | Sets the gain of Band 4 |
| f | L Wet/Dry (R Wet/Dry) | Dry, 1 : 99... 99 : 1, Wet | Sets the balance between the effect and the dry input |
| | Src | Off...Tempo | Selects a modulation source for Wet/Dry |
| | Amt | -100...+100 | Sets the modulation amount for Wet/Dry |
| g | L Pan (R Pan) | L000...C064...R127 | Sets the stereo image |

Comp (Compressor)

| COMPRESSOR | | | |
|------------|-----------------------|----------------------------|---|
| a | Sensitivity | 1...100 | Sets the sensitivity p.251 |
| b | Attack | 1...100 | Sets the attack level p.251 |
| c | Output Level | 0...100 | Sets the output level |
| d | EQ Trim | 0...100 | Sets the EQ input level |
| e | Pre LEQ Gain [dB] | -15...+15 | Sets the gain of Low EQ |
| | Pre HEQ Gain [dB] | -15...+15 | Sets the gain of High EQ |
| f | L Wet/Dry (R Wet/Dry) | Dry, 1 : 99... 99 : 1, Wet | Sets the balance between the effect and the dry input |
| | Src | Off...Tempo | Selects a modulation source for Wet/Dry |
| | Amt | -100...+100 | Sets the modulation amount for Wet/Dry |
| g | L Pan (R Pan) | L000...C064...R127 | Sets the stereo image |

Limiter

| LIMITER | | | |
|---------|-----------------------|------------------------------|--|
| a | Ratio | 1.0 : 1... 50.0 : 1, Inf : 1 | Sets the signal compression ratio p.307 |
| b | Threshold [dB] | -40...0 | Sets the level above which the compressor is applied p.307 |
| c | Attack | 1...100 | Sets the attack time |
| d | Release | 1...100 | Sets the release time |
| e | Gain Adjust [dB] | -Inf, -38...+24 | Sets the output gain p.307 |
| f | L Wet/Dry (R Wet/Dry) | Dry, 1 : 99... 99 : 1, Wet | Sets the balance between the effect and the dry input |
| | Src | Off...Tempo | Selects a modulation source for Wet/Dry |
| | Amt | -100...+100 | Sets the modulation amount for Wet/Dry |
| g | L Pan (R Pan) | L000...C064...R127 | Sets the stereo image |



Exciter

| EXCITER | | | |
|---------|-----------------------|----------------------------|--|
| a | Exciter Blend | -100...+100 | Sets the intensity (depth) of the Exciter effect p.256 |
| b | Emphasis Frequency | 0...70 | Sets the frequency range to be emphasized p.256 |
| c | Trim | 0...100 | Sets the EQ input level |
| d | Pre LEQ Gain [dB] | -15...+15 | Sets the gain of Low EQ |
| e | Pre HEQ Gain [dB] | -15...+15 | Sets the gain of High EQ |
| f | L Wet/Dry (R Wet/Dry) | Dry, 1 : 99... 99 : 1, Wet | Sets the balance between the effect and the dry input |
| | Src | Off...Tempo | Selects a modulation source for Wet/Dry |
| | Amt | -100...+100 | Sets the modulation amount for Wet/Dry |
| g | L Pan (R Pan) | L000...C064...R127 | Sets the stereo image |

OD/HG (Overdrive)

| OD/HI GAIN | | | |
|------------|-----------------------|----------------------------|--|
| a | Drive Mode | Overdrive, Hi-Gain | Switches between overdrive and high-gain distortion |
| | Drive | 1...100 | Sets the degree of distortion p.263 |
| b | Output Level | 0...50 | Sets the output level p.263 |
| | Src | Off...Tempo | Selects the modulation source for the output level |
| | Amt | -50...+50 | Sets the modulation amount of the output level |
| c | Low Cutoff [Hz] | 20...1.00k | Sets the center frequency for Low EQ (shelving type) |
| | Gain [dB] | -18...+18 | Sets the gain of Low EQ |
| d | Mid1 Cutoff [Hz] | 300...10.00k | Sets the center frequency for Mid/High EQ 1 (peaking type) |
| | Q | 0.5...10.0 | Sets the band width of Mid/High EQ 1 p.255 |
| | Gain [dB] | -18...+18 | Sets the gain of Mid/High EQ 1 |
| e | Mid2 Cutoff [Hz] | 500...20.00k | Sets the center frequency for Mid/High EQ 2 (peaking type) |
| | Q | 0.5...10.0 | Sets the band width of Mid/High EQ 2 p.255 |
| | Gain [dB] | -18...+18 | Sets the gain of Mid/High EQ 2 |
| f | L Wet/Dry (R Wet/Dry) | Dry, 1 : 99... 99 : 1, Wet | Sets the balance between the effect and the dry input |
| | Src | Off...Tempo | Selects a modulation source for Wet/Dry |
| | Amt | -100...+100 | Sets the modulation amount for Wet/Dry |
| g | L Pan (R Pan) | L000...C064...R127 | Sets the stereo image |

Wah

| WAH | | | |
|-----|-----------------------|----------------------------|---|
| a | Frequency Bottom | 0...100 | Sets the lower limit of the wah center frequency p.257 |
| | Frequency Top | 0...100 | Sets the upper limit of the wah center frequency p.257 |
| b | Sweep Mode | Auto, D-mod, LFO | Selects the control from auto-wah, modulation source, and LFO p.257 |
| | Src | Off...Tempo | Selects the modulation source for the wah when Sweep Mode=D-mod  |
| c | LFO Frequency [Hz] | 0.02...20.00 | Sets the speed of the LFO |
| d | Resonance | 0...100 | Sets the resonance amount |
| e | Low Pass Filter | Off, On | Switches the wah low pass filter on and off |
| f | L Wet/Dry (R Wet/Dry) | Dry, 1 : 99... 99 : 1, Wet | Sets the balance between the effect and the dry input  |
| | Src | Off...Tempo | Selects a modulation source for Wet/Dry |
| | Amt | -100...+100 | Sets the modulation amount for Wet/Dry |
| g | L Pan (R Pan) | L000...C064...R127 | Sets the stereo image |







Cho/Fing (Chorus / Flanger)

| CHORUS/FLANGER | | | |
|----------------|-----------------------|------------------------------------|---|
| a | LFO Frequency [Hz] | 0.02...20.00 | Sets the speed of the LFO |
| | LFO Waveform | Triangle, Sine | Selects the LFO Waveform |
| b | Delay [msec] | 0.0...1350.0 | Sets the delay time |
| c | Depth | 0...100 | Sets the depth of LFO modulation |
| | Feedback | -100...+100 | Sets the feedback amount p.272 |
| d | EQ Trim | 0...100 | Sets the EQ input level |
| e | Pre LEQ Gain [dB] | -15...+15 | Sets the gain of Low EQ |
| | Pre HEQ Gain [dB] | -15...+15 | Sets the gain of High EQ |
| f | L Wet/Dry (R Wet/Dry) | -Wet... -1 : 99, Dry, 1 : 99...Wet | Sets the balance between the effect and the dry input  |
| | Src | Off...Tempo | Selects a modulation source for Wet/Dry |
| | Amt | -100...+100 | Sets the modulation amount for Wet/Dry |
| g | L Pan (R Pan) | L000...C064...R127 | Sets the stereo image |

Phaser

| PHASER | | | |
|--------|-----------------------|------------------------------------|---|
| a | LFO Frequency [Hz] | 0.02...20.00 | Sets the speed of the LFO |
| b | LFO Waveform | Triangle, Sine | Selects the LFO Waveform |
| c | Manual | 0...100 | Sets the frequency to which the effect is applied |
| d | Depth | 0...100 | Sets the depth of LFO modulation |
| e | Resonance | -100...+100 | Sets the resonance amount p.274 |
| f | L Wet/Dry (R Wet/Dry) | -Wet... -1 : 99, Dry, 1 : 99...Wet | Sets the balance between the effect and the dry input  |
| | Src | Off...Tempo | Selects a modulation source for Wet/Dry |
| | Amt | -100...+100 | Sets the modulation amount for Wet/Dry |
| g | L Pan (R Pan) | L000...C064...R127 | Sets the stereo image |

BPM Dly (Multi-tap BPM Delay)

| MULTITAP BPM DELAY | | | |
|--------------------|-----------------------|--|---|
| a | BPM | MIDI, 40.00... 300.00 | MIDI syncs to the system tempo; 40-300 sets the tempo manually for this individual effect p.285  |
| | Time Over? L | ---, OVER! | Displays an error message when the delay time exceeds the upper limit p.295 |
| | Time Over? R | ---, OVER! | Displays an error message when the delay time exceeds the upper limit p.295 |
| b | Tap1 Base Note |  | Selects the type of notes to specify the delay time for the Tap1 p.285  |
| | Times | x1...x32 | Sets the number of notes to specify the delay time for the Tap1 p.285 |
| c | Tap2 Base Note |  | Selects the type of notes to specify the delay time for the Tap2 p.285  |
| | Times | x1...x32 | Sets the number of notes to specify the delay time for the Tap2 p.285 |
| d | Tap1 Level | 0...100 | Sets the Tap1 output level |
| | Feedback (Tap2) | -100...+100 | Sets the Tap2 feedback amount |
| e | High Damp[%] | 0...100 | Sets the damping amount in the high range p.289 |
| f | L Wet/Dry (R Wet/Dry) | Dry, 1 : 99... 99 : 1, Wet | Sets the balance between the effect and the dry input  |
| | Src | Off...Tempo | Selects a modulation source for Wet/Dry |
| | Amt | -100...+100 | Sets the modulation amount for Wet/Dry |
| g | L Pan (R Pan) | L000...C064...R127 | Sets the stereo image |

127: P4EQ // P4EQ (Parametric 4-Band EQ // Parametric 4-Band EQ)

This effect connects two four-band EQ (p.317) units in parallel.

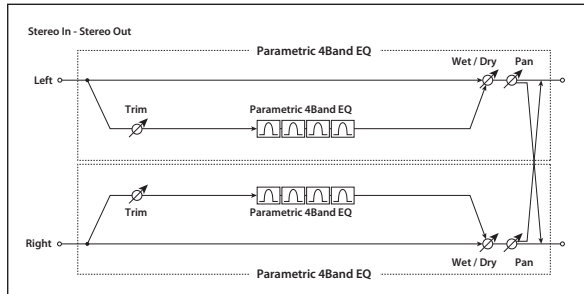

130: P4EQ // Exciter (Parametric 4-Band EQ // Exciter)

This effect connects a four-band EQ (p.317) and an exciter (p.317) in parallel.

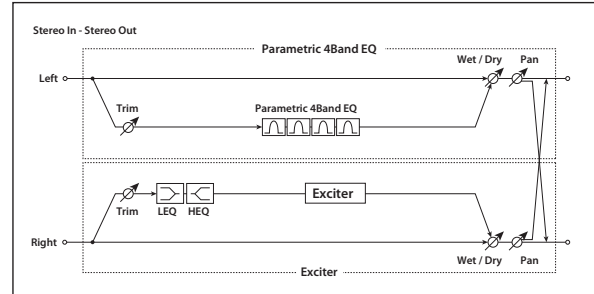

128: P4EQ // Comp (Parametric 4-Band EQ // Compressor)

This effect connects a four-band EQ (p.317) and a compressor (p.317) in parallel.

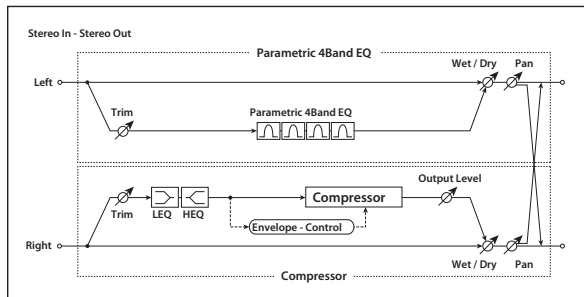

131: P4EQ // OD/HG (Parametric 4-Band EQ // Overdrive/Hi.Gain)

This effect connects a four-band EQ (p.317) and an overdrive (p.317) in parallel.

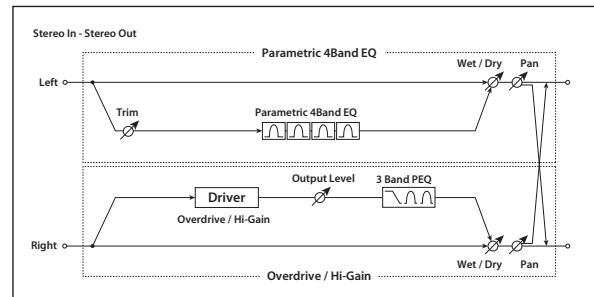

129: P4EQ // Limiter (Parametric 4-Band EQ // Limiter)

This effect connects a four-band EQ (p.317) and a limiter (p.317) in parallel.

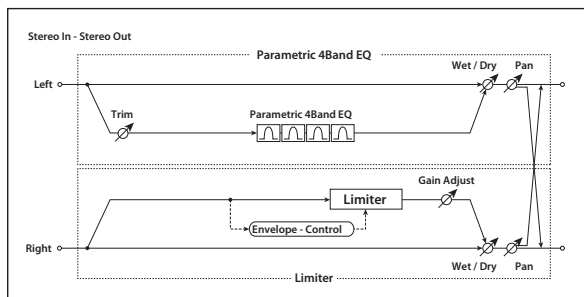

132: P4EQ // Wah (Parametric 4-Band EQ // Wah)

This effect connects a four-band EQ (p.317) and a wah (p.318) in parallel.

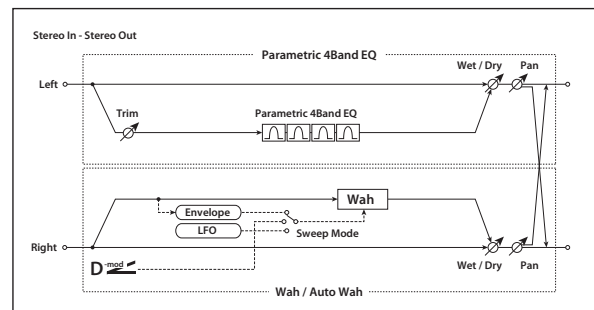

133: P4EQ // Cho/Flng (Parametric 4-Band EQ // Chorus/Flanger)

This effect connects a four-band EQ (p.317) and a chorus / flanger (p.318) in parallel.

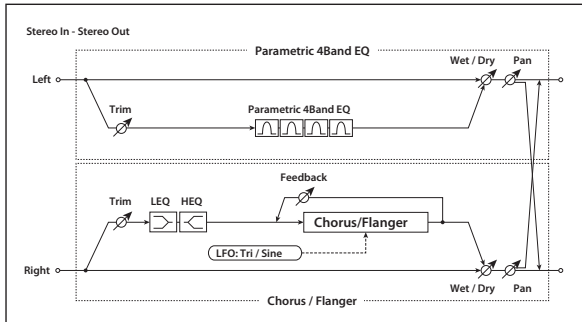

134: P4EQ // Phaser (Parametric 4-Band EQ // Phaser)

This effect connects a four-band EQ (p.317) and a phaser (p.318) in parallel.

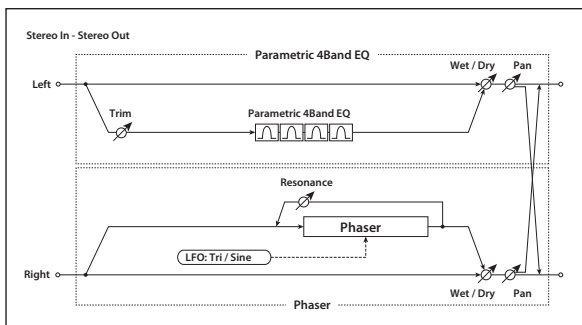

135: P4EQ // BPM Dly (Parametric 4-Band EQ // Multitap BPM Delay)

This effect connects a four-band EQ (p.317) and a multitap BPM delay (p.318) in parallel.

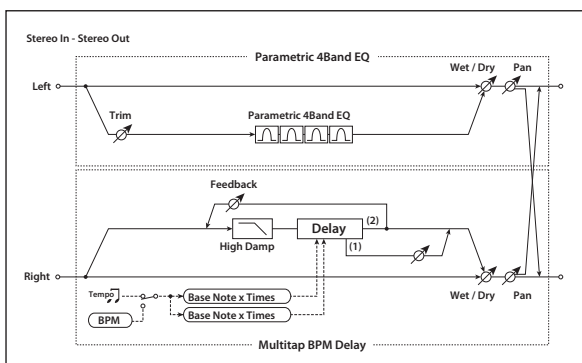

136: Comp // Comp (Compressor // Compressor)

This effect connects two compressor (p.317) units in parallel.

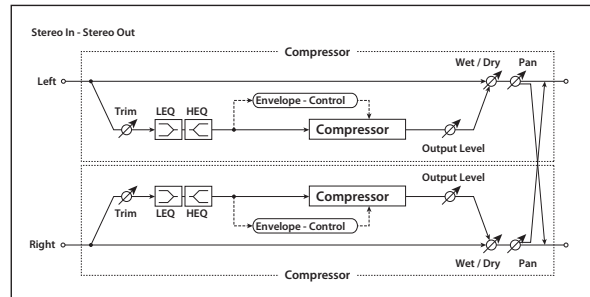

137: Comp // Limiter (Compressor // Limiter)

This effect connects a compressor (p.317) and a limiter (p.317) in parallel.

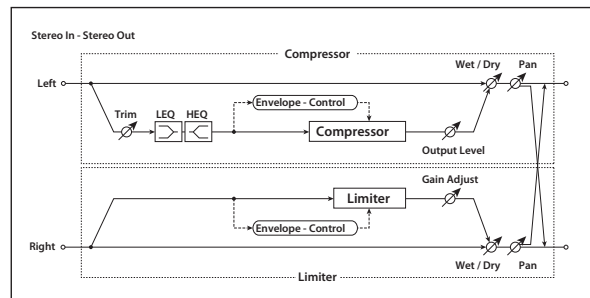

138: Comp // Exciter (Compressor // Exciter)

This effect connects a compressor (p.317) and an exciter (p.317) in parallel.

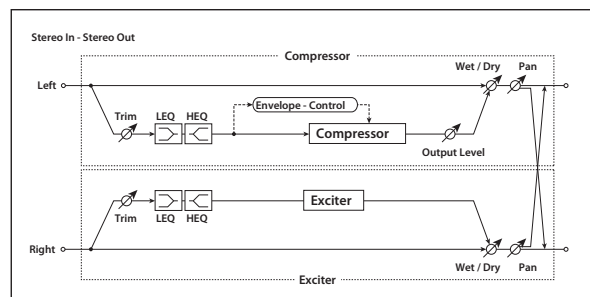

139: Comp // OD/HG (Compressor // Overdrive Hi.Gain)

This effect connects a compressor (p.317) and an overdrive (p.317) in parallel.

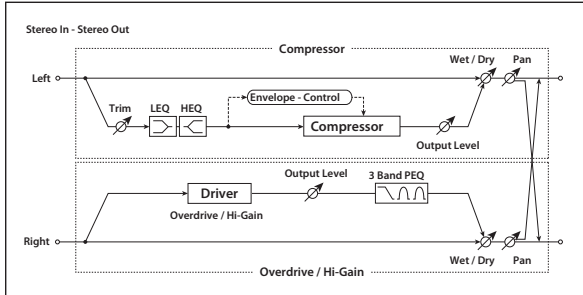

142: Comp // Phaser (Compressor // Phaser)

This effect connects a compressor (p.317) and a phaser (p.318) in parallel.

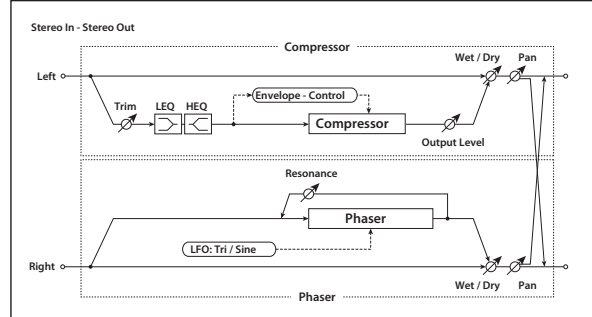

140: Comp // Wah (Compressor // Wah)

This effect connects a compressor (p.317) and a wah (p.318) in parallel.

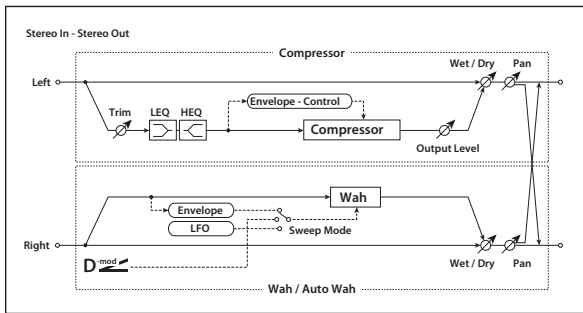

143: Comp // BPM Dly (Compressor // Multitap BPM Delay)

This effect connects a compressor (p.317) and a multitap BPM delay (p.318) in parallel.

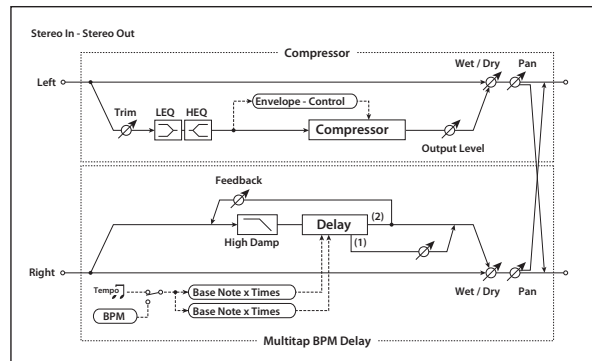

141: Comp // Cho/Flng (Compressor // Chorus/Flanger)

This effect connects a compressor (p.317) and a chorus / flanger (p.318) in parallel.

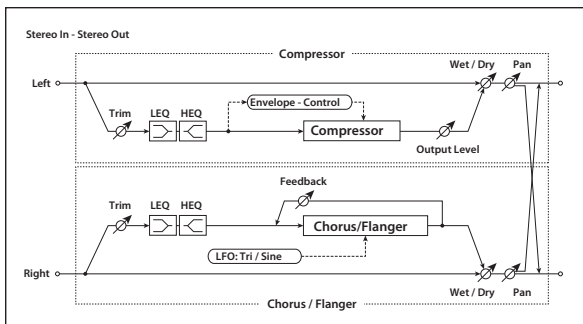

144: Limiter // Limiter

This effect connects two limiter (p.317) units in parallel.

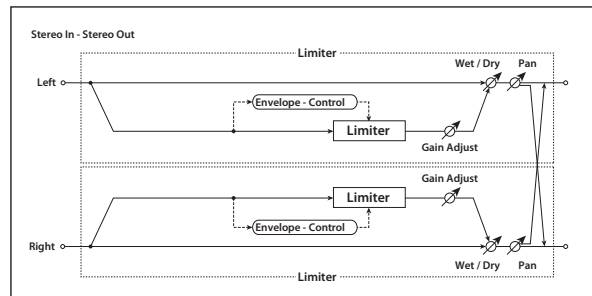

145: Limiter // Exciter

This effect connects a limiter (p.317) and an exciter (p.317) in parallel.

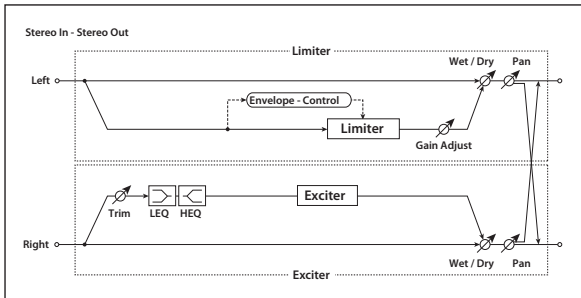

146: Limiter // OD/HG (Limiter / Overdrive/Hi.Gain)

This effect connects a limiter (p.317) and an overdrive (p.317) in parallel.

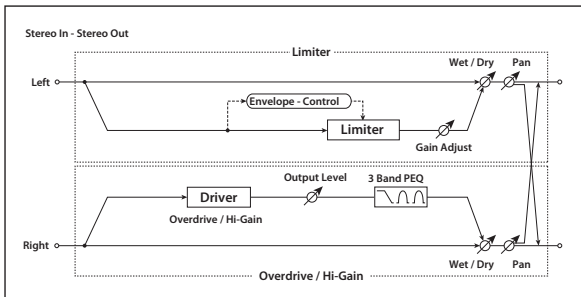

147: Limiter // Wah

This effect connects a limiter (p.317) and a wah (p.318) in parallel.

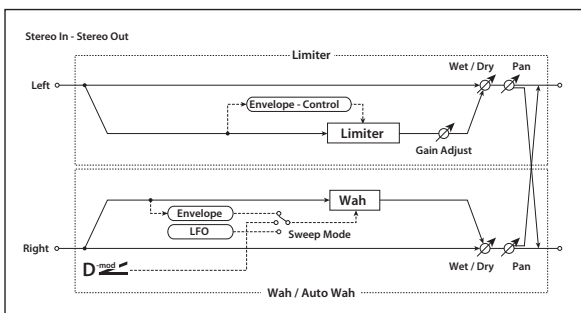

148: Limiter // Cho/FI (Limiter / Chorus/Flanger)

This effect connects a limiter (p.317) and a chorus / flanger (p.318) in parallel.

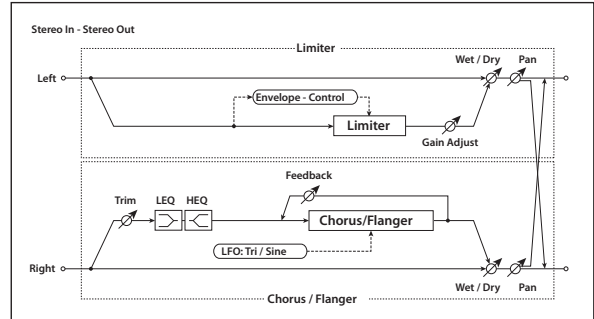

149: Limiter // Phaser

This effect connects a limiter (p.317) and a phaser (p.318) in parallel.

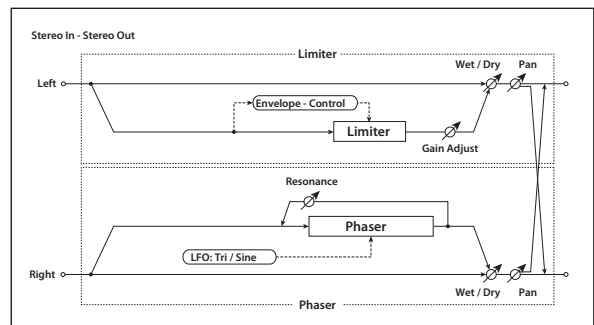

150: Limiter // BPM DI (Limiter // Multitap BPM Delay)

This effect connects a limiter (p.317) and a multitap BPM delay (p.318) in parallel.

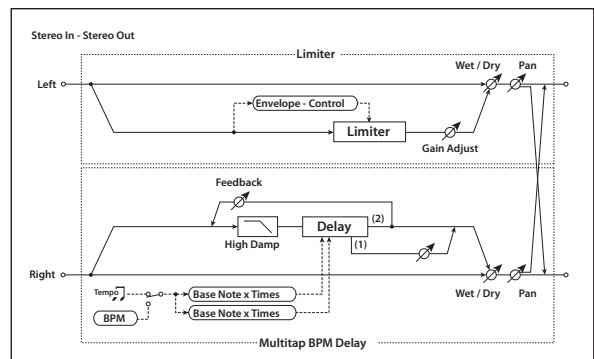

151: Exciter // Exciter

This effect connects two exciter (p.317) units in parallel.

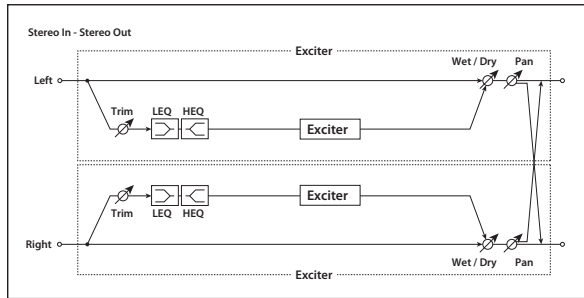

152: Exciter // OD/HG (Exciter // Overdrive/Hi.Gain)

This effect connects an exciter (p.317) and an overdrive (p.317) in parallel.

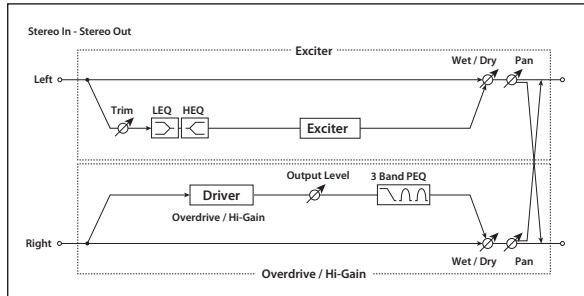

153: Exciter // Wah

This effect connects an exciter (p.317) and a wah (p.318) in parallel.

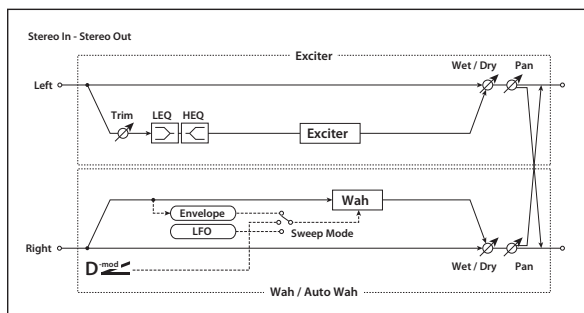

154: Exciter // Cho/Fl (Exciter // Chorus/Flanger)

This effect connects an exciter (p.317) and a chorus / flanger (p.318) in parallel.

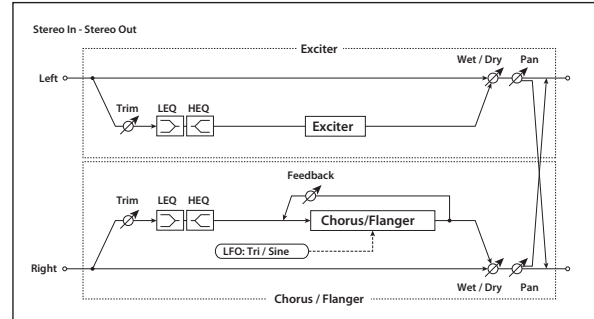

155: Exciter // Phaser

This effect connects an exciter (p.317) and a phaser (p.318) in parallel.

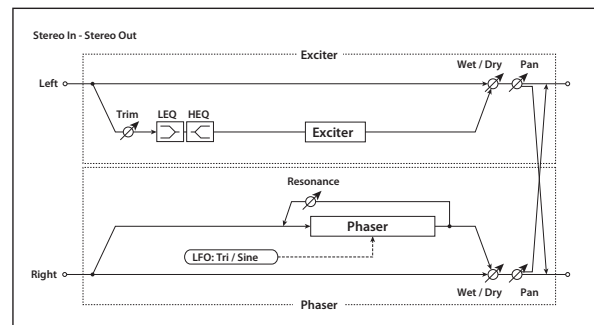

156: Exciter // BPM DI (Exciter // Multitap BPM Delay)

This effect connects an exciter (p.317) and a multitap BPM delay (p.318) in parallel.

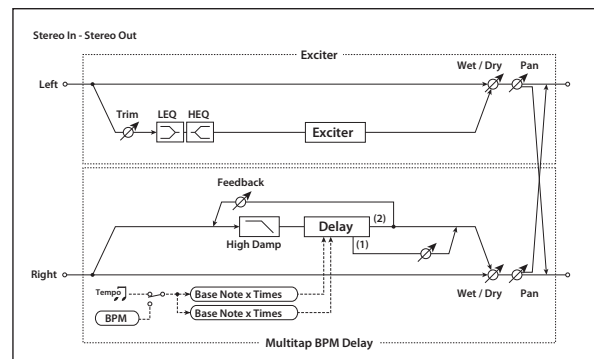

157: OD/HG // OD/HG (Overdrive/Hi.Gain // Overdrive/Hi.Gain)

This effect connects two overdrive (p.317) units in parallel.

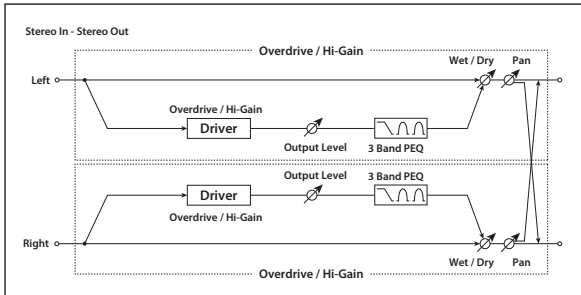

160: OD/HG // Phaser (Overdrive/Hi.Gain // Phaser)

This effect connects an overdrive (p.317) and a phaser (p.318) in parallel.

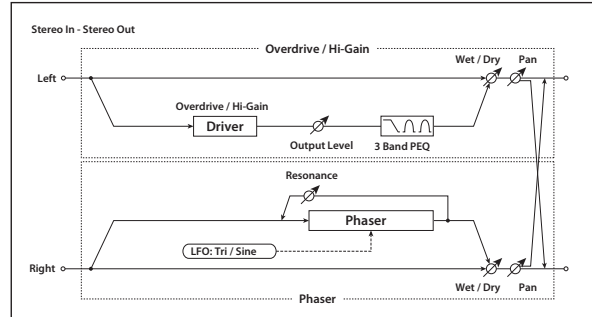

158: OD/HG // Wah (Overdrive/Hi.Gain // Wah)

This effect connects an overdrive (p.317) and a wah (p.318) in parallel.

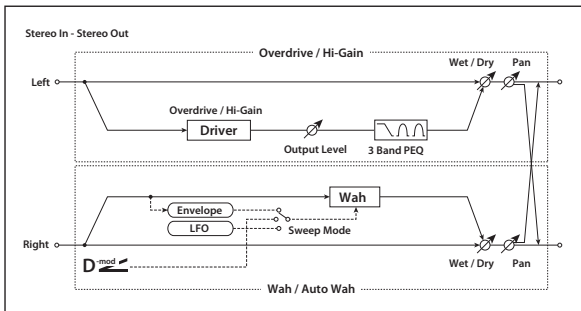

161: OD/HG // BPMdly (Overdrive/Hi.Gain // Multitap BPM Delay)

This effect connects an overdrive (p.317) and a multitap BPM delay (p.318) in parallel.

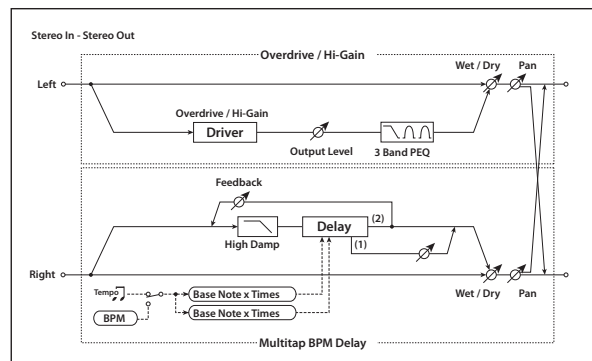

159: OD/HG // Cho/Fln (Overdrive/Hi.Gain // Chorus/Flanger)

This effect connects an overdrive (p.317) and a chorus / flanger (p.318) in parallel.

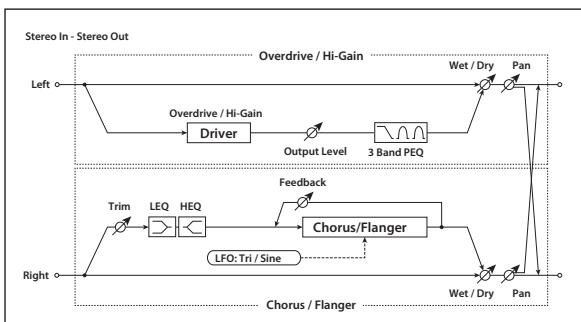

162: Wah // Wah

This effect connects two wah (p.318) units in parallel.

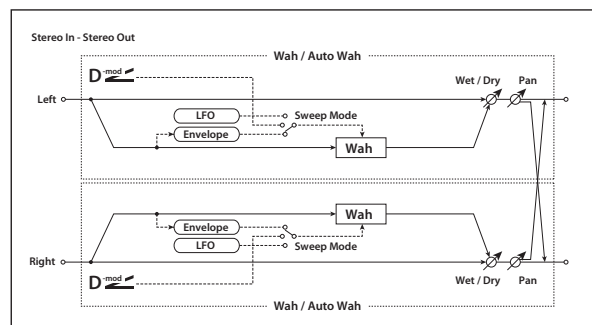

163: Wah // Cho/Fing (Wah // Chorus/Flanger)

This effect connects a wah (p.318) and a chorus / flanger (p.318) in parallel.

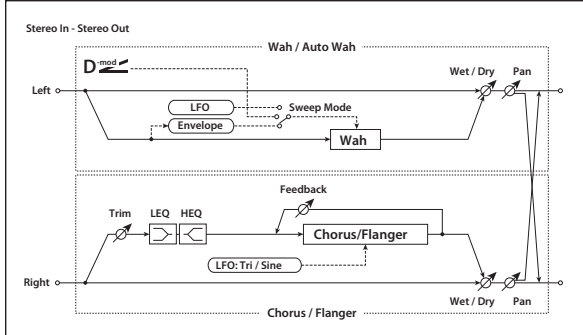

166: Cho/FI // Cho/FI (Chorus/Flanger // Chorus/Flanger)

This effect connects two chorus / flanger (p.318) units in parallel.

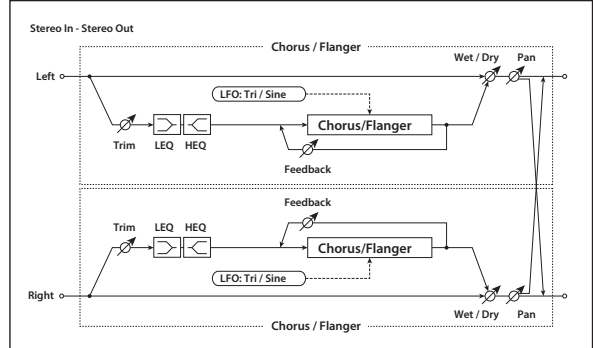

164: Wah // Phaser

This effect connects a wah (p.318) and a phaser (p.318) in parallel.

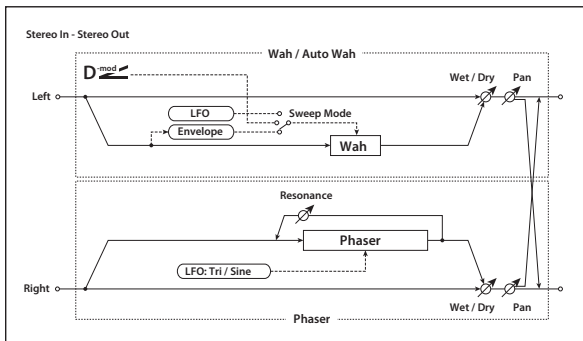

167: Cho/FI // Phaser (Chorus/Flanger // Phaser)

This effect connects a chorus / flanger (p.318) and phaser (p.318) in parallel.

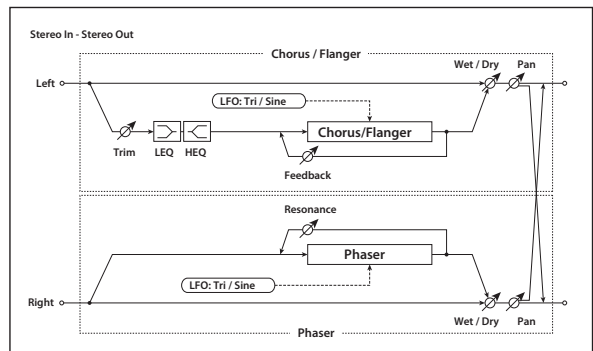

165: Wah // BPM Dly (Wah // Multitap BPM Delay)

This effect connects a wah (p.318) and a multitap BPM delay (p.318) in parallel.

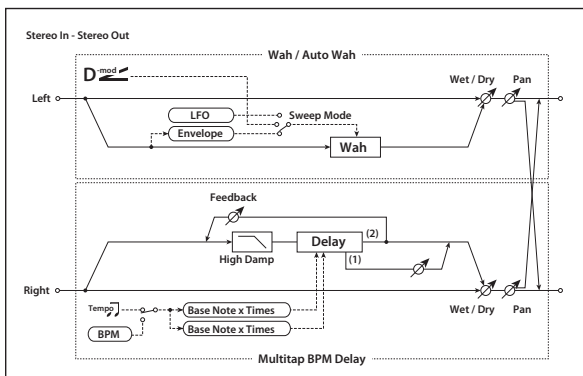

168: Cho/FI // BPMDly (Chorus/Flanger // Multitap BPM Delay)

This effect connects a chorus / flanger (p.318) and a multitap BPM delay (p.318) in parallel.

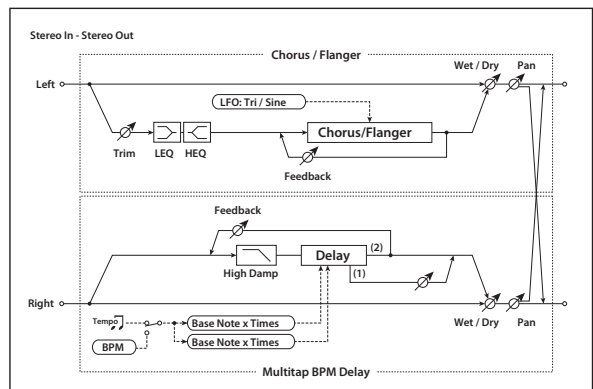

169: Phaser // Phaser

This effect connects two phaser (p.318) units in parallel.

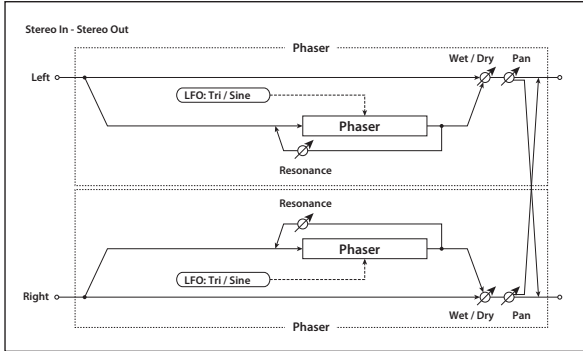

170: Phaser // BPMDly (Phaser // Multitap BPM Delay)

This effect connects a phaser (p.318) and a multitap BPM delay (p.318) in parallel.

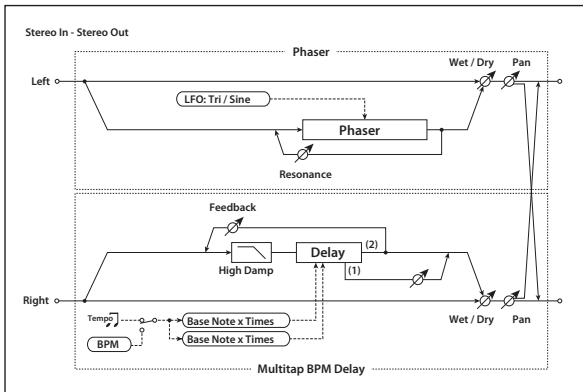

171: BPM DI // BPM DI (Multitap BPM Delay // Multitap BPM Delay)

This effect connects two multitap BPM delay (p.318) units in parallel.

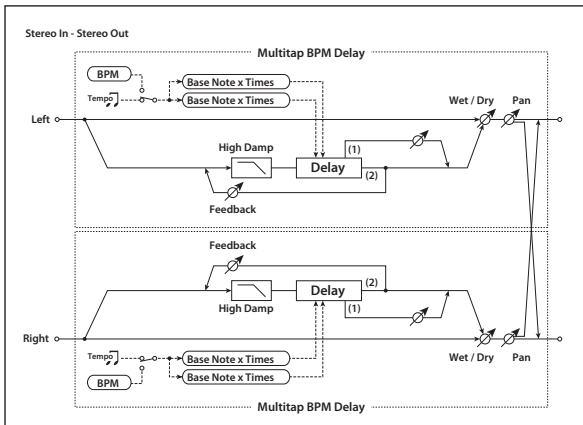

Double Size

Double-size effects can be used only with insert effects IFX1, 2, 3, 4 and master effect MFX1.

172: St. Mltband Limiter (Stereo Multiband Limiter)

This is a stereo multiband limiter.

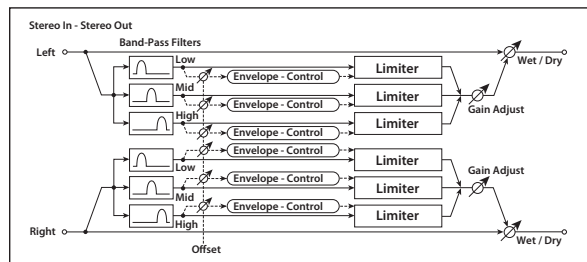

| | | | | |
|---|------------------|---------------------------------|--|------------------|
| a | Ratio | 1.0 : 1... 50.0 : 1, Inf : 1 | Sets the signal compression ratio p.307 | |
| b | Threshold [dB] | -40...0 | Sets the level above which the compressor is applied p.307 | |
| c | Attack | 1...100 | Sets the attack time | |
| d | Release | 1...100 | Sets the release time | |
| e | Low Offset [dB] | -40...0 | Sets the low range gain of trigger signal p.253 | |
| f | Mid Offset [dB] | -40...0 | Sets the mid range gain of trigger signal p.253 | |
| g | High Offset [dB] | -40...0 | Sets the high range gain of trigger signal p.253 | |
| h | Gain Adjust [dB] | -Inf...+24 -38...+24 | Sets the output gain p.307 | D ^{mod} |
| | Src | Off...Tempo | Selects the modulation source for the output gain | |
| | Amt | -63...+63 | Sets the modulation amount of the output gain | |
| i | Wet/Dry | Dry, 1 : 99... 99 : 1, Wet | Sets the balance between the effect and the dry input | D ^{mod} |
| | Src | Off...Tempo | Selects a modulation source for Wet/Dry | |
| | Amt | -100...+100 | Sets the modulation amount for Wet/Dry | |

173: PianoBody/Damper (PianoBody/Damper Simulation)

This effect simulates the resonance of the piano sound board caused by the string vibration, and also simulates the resonance of other strings that are not being played when you press the damper pedal. It will create a very realistic sound when applied to acoustic piano sounds.

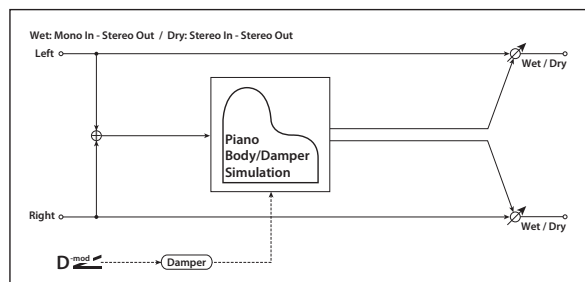

| | | | | |
|---|-------------------|-------------------------------|---|------------------|
| a | Sound Board Depth | 0...100 | Sets the intensity of resonance of the sound board p.327 | |
| b | Damper Depth | 0...100 | Sets the intensity of the string resonance created when the damper pedal is pressed p.327 | D ^{mod} |
| | Src | Off...Tempo | Selects the modulation source of damper effect p.327 | |
| c | Tone | 1...100 | Sets tonal quality of effect sound p.327 | |
| d | Mid Shape | 0...36 | Sets the mid range of tonal quality p.327 | |
| e | Tune | -50...+50 | Fine tuning p.327 | |
| f | Wet/Dry | Dry, 1 : 99... 99 : 1, Wet | Sets the balance between the effect and the dry input | D ^{mod} |
| | Src | Off...Tempo | Selects a modulation source for Wet/Dry | |
| | Amt | -100...+100 | Sets the modulation amount for Wet/Dry | |

a: Sound Board Depth

This parameter sets the intensity of resonance of the piano sound board.

b: Damper Depth

b: Src

This parameter sets the resonance intensity of the other strings created when the damper pedal is pressed. The Src parameter selects the modulation source from which the damper effect is applied. Usually, select Damper #64 Pdl (Damper pedal).

MIDI The effect is off when a value for the modulation source specified for the Src parameter is 63 or smaller, and the effect is on when the value is 64 or higher.

c: Tone

d: Mid Shape

These parameters control the tonal quality of the effect sound.

e: Tune

Since this effect simulates the resonance of the strings, the sound varies depending on the pitch. If you have changed tuning using the Master Tune (Global P0), adjust this parameter value.

174: Vocoder

This effect applies the timbral character of a one signal (the modulator) to a second signal (the carrier).

On the KROME, an external source such as a mic cannot be used as the modulator source, but you can create unique effects by using an internal sound source as the modulator. Try selecting voice-type sounds, rhythms, or sound effects as the modulator. The most suitable choices for the carrier are sounds that contain a large number of overtones, such as strings or distorted guitar. For details on how to make settings, refer to "Example: Vocoder (Combination)" on page 238.

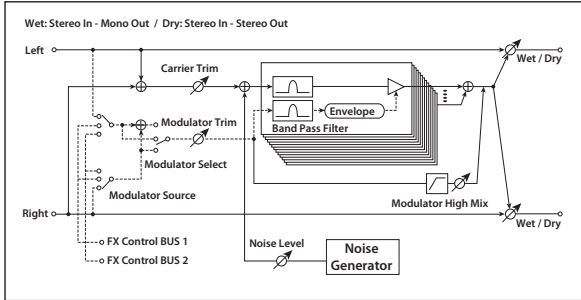

| | | | | |
|---|--------------------|-----------------------------------|--|--|
| a | Carrier Trim | 0...100 | Sets the Carrier input level | |
| b | Modulator Trim | 0...100 | Sets the Modulator input level | |
| c | Modulator Source | Input, FX Control 1, FX Control 2 | Selects the modulator input | |
| d | Modulator Select | L/R Mix, L Only, R Only | Selects whether to use the left/right mix, only left, or only right of the modulator input | |
| e | Formant Shift | -2...+2 | Sets the height of the frequency for the vocoder effect p.328 | |
| f | Response | 0...100 | Sets the speed of the response to the modulator input | |
| g | Noise Level | 0...100 | Sets the noise mix level to the Carrier p.328 | |
| | Src | Off...Tempo | Selects the modulation source for the noise mix level | |
| | Amt | -100...+100 | Sets the modulation amount for the noise mix level | |
| h | Modulator High Mix | 0...100 | Sets the high-range output level of the modulator p.328 | |
| i | Low Gain [dB] | -12...+12 | Sets the low-range output level of the vocoder | |
| | High Gain [dB] | -12...+12 | Sets the high-range output level of the vocoder | |
| j | Wet/Dry | Dry, 1 : 99... 99 : 1, Wet | Sets the balance between the effect and the dry input | |
| | Src | Off...Tempo | Selects a modulation source for Wet/Dry | |
| | Amt | -100...+100 | Sets the modulation amount for Wet/Dry | |

e: Formant Shift

By offsetting the Carrier filter, you can adjust the height of the frequency range to which the vocoder effect is applied. The tonal quality will change significantly.

g: Noise Level

This parameter enables you to mix white noise with the Carrier.

h: Modulator High Mix

This parameter sets the high-range output level of the modulator sound. If the modulator is a human voice, it will make the words more clear.

175: OD/HyperGain Wah (Overdrive/Hyper Gain Wah)

This distortion effect has two modes: overdrive and hyper-gain that produces a strong distortion. A higher high-gain setting is required for this effect relative to a normal-size effect.

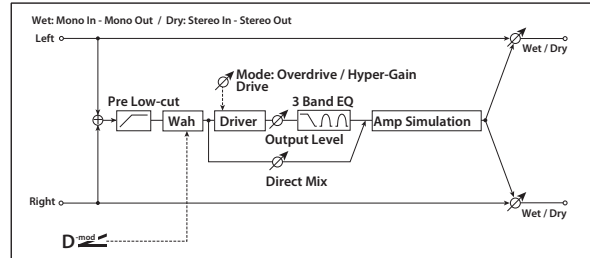

| | | | | | |
|---|--------------------|----------------------------|---|-------|--|
| a | Wah | Off, On | Switches Wah on/off | p.263 | |
| | Src | Off...Tempo | Selects the modulation source that switches the Wah on and off | p.263 | |
| | Sw | Toggle, Moment | Selects the switching mode for the modulation source that switches the Wah on and off | p.263 | |
| b | Wah Sweep Range | -10...+10 | Sets the range of Wah | p.263 | |
| | Wah Sweep Src | Off...Tempo | Selects the modulation source that controls the Wah | p.263 | |
| c | Drive Mode | Overdrive, Hyper-Gain | Switches between overdrive and hi-gain distortion | | |
| d | Drive | 1...120 | Sets the degree of distortion | p.263 | |
| | Pre Low-cut | 0...10 | Sets the low range cut amount of the distortion input | p.263 | |
| e | Output Level | 0...50 | Sets the output level | p.263 | |
| | Src | Off...Tempo | Selects the modulation source for the output level | | |
| | Amt | -50...+50 | Sets the modulation amount of the output level | | |
| f | Low Cutoff [Hz] | 20...1.00k | Sets the center frequency for Low EQ (shelving type) | | |
| | Gain [dB] | -18...+18 | Sets the gain of Low EQ | | |
| g | Mid1 Cutoff [Hz] | 300...10.00k | Sets the center frequency for Mid/High EQ 1 (peaking type) | | |
| | Q | 0.5...10.0 | Sets the band width of Mid/High EQ 1 | p.255 | |
| | Gain [dB] | -18...+18 | Sets the gain of Mid/High EQ 1 | | |
| h | Mid2 Cutoff [Hz] | 500...20.00k | Sets the center frequency for Mid/High EQ 2 (peaking type) | | |
| | Q | 0.5...10.0 | Sets the band width of Mid/High EQ 2 | p.255 | |
| | Gain [dB] | -18...+18 | Sets the gain of Mid/High EQ 2 | | |
| i | Direct Mix | 0...50 | Sets the amount of the dry sound mixed to the distortion | | |
| | Speaker Simulation | Off, On | Switches the speaker simulation on/off | | |
| j | Wet/Dry | Dry, 1 : 99... 99 : 1, Wet | Sets the balance between the effect and the dry input | | |
| | Src | Off...Tempo | Selects a modulation source for Wet/Dry | | |
| | Amt | -100...+100 | Sets the modulation amount for Wet/Dry | | |

176: GuitarAmp + P4EQ (Guitar Amp Model + Parametric 4-Band EQ)

This combines a guitar amp simulation (which even faithfully replicates the distortion and tone control circuitry) with a four-band equalizer.

By using this in conjunction with “021: St. Guitar Cabinet (Stereo Guitar Cabinet)” on p.264, you can obtain an even more realistic guitar sound that simulates a guitar amp + speaker cabinet.

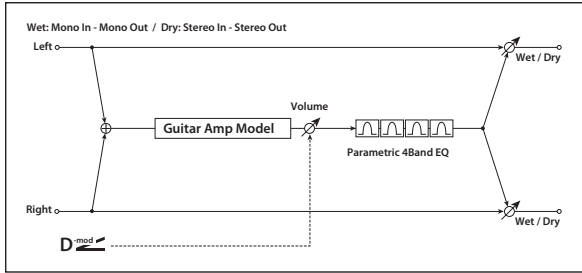

| | | | | |
|---|-------------------|--|---|-------|
| a | Amplifier Type | VOX AC15, VOX AC15TB, VOX AC30, VOX AC30TB, UK BLUES, UK 70'S, UK 80'S, UK 90'S, UK MODERN, US MODERN, US HIGAIN, BOUTIQUE OD, BOUTIQUE CL, BLACK 2x12, TWEED - 1x12, TWEED - 4x10 | Selects the type of the amplifier p.329 | |
| | Drive Gain | 0...100 | Sets the input gain | |
| b | Volume | 0...100 | Sets the output level | D-mod |
| | Src | Off...Tempo | Selects the modulation source for the output level | |
| | Amt | -100...+100 | Sets the modulation amount of the output level | |
| c | Bass | 0...100 | Sets the bass (low range) level | |
| | Middle | 0...100 | Sets the middle (mid range) level | |
| d | Treble | 0...100 | Sets the treble (high range) level | |
| | Presence | 0...100 | Sets the presence (high-frequency tone) p.329 | |
| e | Post P4EQ | Thru, On | Selects through or on for the equalizer p.329 | |
| f | Band1 Cutoff [Hz] | 20...1.00k | Sets the center frequency of Band 1 | |
| | Q | 0.5...10.0 | Sets Band 1's bandwidth | |
| | Gain [dB] | -18...+18 | Sets the gain of Band 1 | |
| g | Band2 Cutoff [Hz] | 50...5.00k | Sets the center frequency of Band 2 | |
| | Q | 0.5...10.0 | Sets Band 2's bandwidth | |
| | Gain [dB] | -18...+18 | Sets the gain of Band 2 | |
| h | Band3 Cutoff [Hz] | 300...10.00k | Sets the center frequency of Band 3 | |
| | Q | 0.5...10.0 | Sets Band 3's bandwidth | |
| | Gain [dB] | -18...+18 | Sets the gain of Band 3 | |
| i | Band4 Cutoff [Hz] | 500...20.00k | Sets the center frequency of Band 4 | |
| | Q | 0.5...10.0 | Sets Band 4's bandwidth | |
| | Gain [dB] | -18...+18 | Sets the gain of Band 4 | |
| j | Wet/Dry | Dry, 1 : 99... 99 : 1, Wet | Sets the balance between the effect and the dry input D-mod | |
| | Src | Off...Tempo | Selects a modulation source for Wet/Dry | |
| | Amt | -100...+100 | Sets the modulation amount for Wet/Dry | |

a: Amplifier Type

d: Presence

If the Amplifier Type is VOX AC15...VOX AC30TB, this sets the attenuation of the high-frequency range. For other types, this sets the boost of the high-frequency range.

This corresponds to the Cut knob control of amps made by the VOX Corporation.

e: Post P4EQ

By chaining this with 19: St.Guitar Cabinet you can simulate the combination of a guitar amp and speaker cabinet. In this case, we recommend that you set **Post P4EQ** to “Thru,” but if necessary you can turn it “On” and adjust the tone.

Recommended Combinations of Guitar Amp Models and Cabinet Simulators:

| Amplifier Type | Cabinet Type |
|----------------|------------------------------|
| VOX AC15 | VOX AC15 - 1x12 |
| VOX AC15TB | VOX AC15 - 1x12 |
| VOX AC30 | VOX AC30 - 2x12 |
| VOX AC30TB | VOX AC30 - 2x12 |
| UK BLUES | UK H30 - 4x12 |
| UK 70'S | UK H30 - 4x12 |
| UK 80'S | UK T75 - 4x12 |
| UK 90'S | UK T75 - 4x12 |
| UK MODERN | UK T75 - 4x12, US V30 - 4x12 |
| US MODERN | US V30 - 4x12 |
| US HIGAIN | US V30 - 4x12, UK T75 - 4x12 |
| BOUTIQUE OD | UK H30 - 4x12 |
| BOUTIQUE CL | UK H30 - 4x12 |
| BLACK 2x12 | BLACK - 2x12 |
| TWEED - 1x12 | TWEED - 1x12 |
| TWEED - 4x10 | TWEED - 4x10 |

Note: It is convenient to use the Effect Preset function to preset your favorite pairings of amp model and cabinet. (see p.60)

177: G.Amp Clean Combo

This models the clean channel of a amp that went on sale in 1975 and contained two 12" speakers. As the name suggests, it produces a clean tone with a tight sounding character, and a deep and compact low-end.

178: G.Amp California

This American combo amp with four 10" speakers was produced during the years 1963–1968, and was known for its big, clean sound and its warm and husky sound when driven heavily.

179: G.Amp Tweed

This American-made tweed-covered 1957 model combo amp with two 12" speakers is known for its rich, clean tone that is ideal for classic rock, blues, and country. By raising the volume you can also produce a powerful and punchy overdrive sound.

180: G.Amp Modded OD

This models a 100W boutique amp head produced in North Hollywood. An overdrive tone with a rich harmonic structure is combined with a relaxed sustain, making for an enjoyable playing experience.

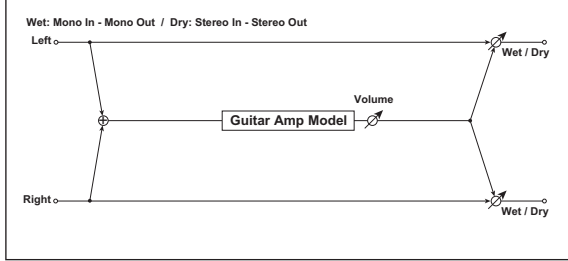

| | | | | |
|---|----------|---------------------------|---|--|
| a | Gain | 0..100 | Sets the input gain | |
| b | Volume | 0..100 | Sets the output level | |
| | Source | Off..Tempo | Selects a modulation source for Volume | |
| | Amount | -100...+100 | Sets the modulation amount for Volume | |
| c | Bass | 0..100 | Sets the bass (low range) level | |
| d | Middle | 0..100 | Sets the middle (mid range) level | |
| e | Treble | 0..100 | Sets the treble (high range) level | |
| f | Presence | 0..100 | Sets the presence (high-frequency tone) | |
| g | Wet/Dry | Dry, 1 : 99...99 : 1, Wet | Sets the balance between the effect and the dry input | |
| | Source | Off..Tempo | Selects a modulation source for Wet/Dry | |
| | Amount | -100...+100 | Sets the modulation amount for Wet/Dry | |

Examples of amp and cabinet combinations

We recommend that you use these amp model effects in a chain with the cabinet model effect (S21: St.Gt Cab). You are free to use any combination to create a variety of sounds, so try out various combinations and listen to the result. Here are some typical combinations.

| | |
|------------------------|-------------|
| 177: G.Amp Clean Combo | 1x12 TWEED |
| | 2x10 BLACK |
| | 2x12 BLACK |
| | 4x12 UK H30 |
| 178: G.Amp California | 1x12 TWEED |
| | 4x10 TWEED |
| | 2x12 BLACK |
| | 4x12 UK H30 |
| 179: G.Amp Tweed | 1x12 TWEED |
| | 2x10 BLACK |
| | 2x12 BLACK |
| 180: G.Amp Modded OD | 4x12 UK T75 |
| | 4x12 US V30 |

181: BassTubeAmp+Cab. (Bass Tube Amp Model + Cabinet)

This simulates a bass amp (with gain and drive) and speaker cabinet.

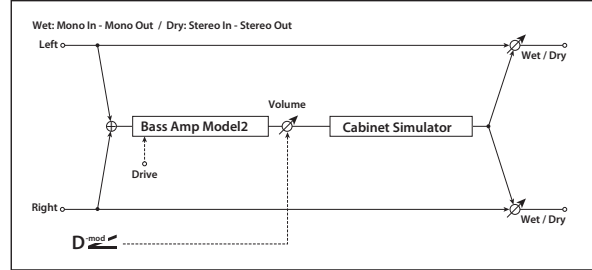

| | | | | |
|---|-------------------|---|---|--|
| a | Amplifier Type | STUDIO COMBO | Selects the type of the amplifier p.329 | |
| | | VOX AC100 | A 100W tube amp AC100 made by Vox | |
| | | UK MAJOR | A 200W tube amp made in the UK | |
| b | Drive Gain | 0..100 | Sets the input gain | |
| c | Volume | 0..100 | Sets the output level | |
| | | Src | Off..Tempo | Selects the modulation source for the output level |
| | | Amt | -100...+100 | Sets the modulation amount of the output level |
| d | Bass | 0..100 | Sets the bass (low range) level | |
| e | Middle | 0..100 | Sets the middle (mid range) level | |
| f | Treble | 0..100 | Sets the treble (high range) level | |
| g | Presence | 0..100 | Sets the presence (high-frequency tone) | |
| h | Cabinet Simulator | Off, On | Switches the cabinet simulator on/off | |
| i | Cabinet Type | LA - 4x10, MODERN - 4x10, METAL - 4x10, CLASSIC - 8x10, UK - 4x12, STUDIO - 1x15, JAZZ - 1x15, VOX AC100 - 2x15, US - 2x15, UK - 4x15, LA - 1x18, COMBI - 1x12 & 1x18 | Selects the cabinet type p.265, p.330 | |
| | | | | |
| j | Wet/Dry | Dry, 1 : 99...99 : 1, Wet | Sets the balance between the effect and the dry input | |
| | | Src | Off..Tempo | Selects a modulation source for Wet/Dry |
| | | Amt | -100...+100 | Sets the modulation amount for Wet/Dry |

a: Amplifier Type

i: Cabinet Type

Recommended Combinations of Bass Amp Models and Cabinets:

| Amplifier Type | Cabinet Type |
|----------------|----------------------|
| STUDIO COMBO | STUDIO - 1x15 |
| AC100 | VOX AC100 - 2x15 |
| UK MAJOR | UK - 4x15, UK - 4x12 |

Note: It is convenient to use the Effect Preset function to preset your favorite pairings of amp model and cabinet. (see p.60)

182: EP Cabinet/Drive

This faithfully simulates the characteristics of the power amp and speaker cabinet of a famous model of tine-type electric piano. It produces a tone with a distinctive sense of drive and warmth.

| | | | | |
|---|--------------|--------------------------------|--|--|
| a | Cabinet Type | Tine EP I, Tine EP II, Reed EP | Select the power amp and speaker cabinet. | |
| b | Drive Switch | Off, On | Switches drive on/off | |
| | Src | Off...Tempo | Selects a modulation source to switch drive on/off | |
| c | Sw | Toggle, Moment | Sets the switch mode for drive on/off modulation | |
| | Drive | 00.0...100 | Sets the amount of overdrive and distortion in the amp | |
| | Src | Off...Tempo | Selects a modulation source for Drive | |
| d | Amt | -100...+100 | Sets the modulation amount for Drive | |
| | Wet/Dry | Dry, 1 : 99...99 : 1, Wet | Sets the balance between the effect and the dry input | |
| | Src | Off...Tempo | Selects a modulation source for Wet/Dry | |
| | Amt | -100...+100 | Sets the modulation amount for Wet/Dry | |

c: Drive

At lower settings, the amp is very clean; as you increase the **Drive**, it gets dirtier and more distorted. The output level is compensated, so increasing **Drive** causes only a moderate increase in perceived volume.

183: St. Mic + PreAmp (Stereo Mic Modeling + PreAmp)

This is a stereo mic and preamp simulator (See "028: Mic Model+PreAmp (Mic Modeling + PreAmp)" on page 267.). For example you might use this to simulate micing of a stereo source such as a rotary speaker.

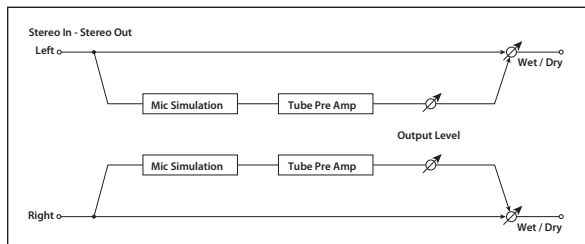

184: Multitap Cho/Delay (Multitap Chorus/Delay)

This effect has six chorus blocks with different LFO phases. You can produce a complex stereo image by setting a different delay time and depth for each block. You can control the delay output level via a modulation source.

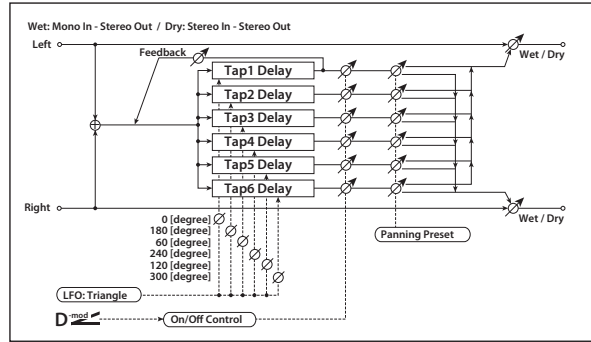

| | | | | |
|---|--------------------|---|--|-------|
| a | LFO Frequency [Hz] | 0.02...13.00 | Sets the speed of the LFO | |
| b | Tap1 (000) [msec] | 0...2000 | Sets the Tap1 (LFO phase=0 degrees) delay time | |
| | Depth | 0...30 | Sets the Tap1 chorus depth | |
| c | Status | Always On, Always Off, On→Off (Dm), Off→On (Dm) | Selects on, off, or modulation source for the control of Tap1 output | p.332 |
| | Tap2 (180) [msec] | 0...2000 | Sets the Tap2 (LFO phase=180 degrees) delay time | |
| d | Depth | 0...30 | Sets the Tap2 chorus depth | |
| | Status | Always On, Always Off, On→Off (Dm), Off→On (Dm) | Selects on, off, or modulation source for the control of Tap2 output | p.332 |
| e | Tap3 (060) [msec] | 0...2000 | Sets the Tap3 (LFO phase=60 degrees) delay time | |
| | Depth | 0...30 | Sets the Tap3 chorus depth | |
| f | Status | Always On, Always Off, On→Off (Dm), Off→On (Dm) | Selects on, off, or modulation source for the control of Tap3 output | p.332 |
| | Tap4 (240) [msec] | 0...2000 | Sets the Tap4 (LFO phase=240 degrees) delay time | |
| g | Depth | 0...30 | Sets the Tap4 chorus depth | |
| | Status | Always On, Always Off, On→Off (Dm), Off→On (Dm) | Selects on, off, or modulation source for the control of Tap4 output | p.332 |
| h | Tap5 (120) [msec] | 0...2000 | Sets the Tap5 (LFO phase=120 degrees) delay time | |
| | Depth | 0...30 | Sets the Tap5 chorus depth | |
| i | Status | Always On, Always Off, On→Off (Dm), Off→On (Dm) | Selects on, off, or modulation source for the control of Tap5 output | p.332 |
| | Tap6 (300) [msec] | 0...2000 | Sets the Tap6 (LFO phase=300 degrees) delay time | |
| j | Depth | 0...30 | Sets the Tap6 chorus depth | |
| | Status | Always On, Always Off, On→Off (Dm), Off→On (Dm) | Selects on, off, or modulation source for the control of Tap6 output | p.332 |

| | | | | |
|---|----------------|--|---|--|
| h | Panning Preset | 1 : L 1 2 3 4 5 6 R, 2 : L 1 3 5 2 4 6 R, 3 : L 1 4 5 6 3 2 R | Selects the stereo panning pattern for each tap p.332 | |
| | Tap1 Feedback | -100...+100 | Sets the Tap1 feedback amount | |
| i | Src | Off...Tempo | Selects the modulation source for the Tap output level, feedback amount, and effect balance | |
| | Amt | -100...+100 | Sets the modulation amount of Tap1 feedback amount | |
| j | Wet/Dry | Dry, 1 : 99... 99 : 1, Wet | Sets the balance between the effect and the dry input | |
| | Src | Off...Tempo | Selects a modulation source for Wet/Dry | |
| | Amt | -100...+100 | Sets the modulation amount for Wet/Dry | |

b, c, d, e, f, g: Status

These parameters set the output status of each Tap.

Always On: Output is always on. (No modulation)

Always Off: Output is always off. (No modulation)

On→Off (dm): Output level is switched from on to off depending on the modulation source.

Off→On (dm): Output level is switched from off to on depending on the modulation source.

Combining these parameters, you can change from 4-phase chorus to two-tap delay by crossfading them gradually via the modulation source during a performance.

h: Panning Preset

This parameter selects combinations of stereo images of the tap outputs.

184: St. Pitch Shifter (Stereo Pitch Shifter)

This is a stereo pitch shifter. The pitch shift amount for the left and right channels can be reversed from each other.

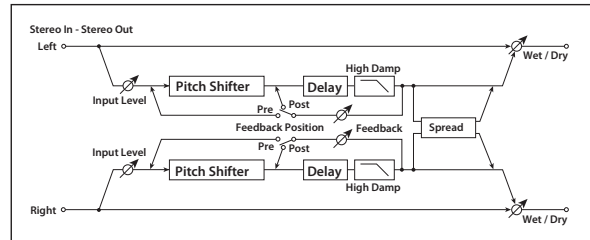

| | | | | |
|---|-----------------------|-------------------------------|---|--|
| a | Mode | Slow, Medium, Fast | Switches Pitch Shifter mode p.287 | |
| | L/R Pitch | Normal, Up/Down | Determines whether or not the L/R pitch shift amount is inverted p.332 | |
| b | Pitch Shift [1/2tone] | -24...+24 | Sets the pitch shift amount in steps of a semitone p.285 | |
| | Src | Off...Tempo | Selects the modulation source of pitch shift amount p.285 | |
| | Amt | -24...+24 | Sets the modulation amount of pitch shift amount p.285 | |
| c | Fine [cent] | -100...+100 | Sets the pitch shift amount in steps of one cent p.285 | |
| | Amt | -100...+100 | Sets the modulation amount of pitch shift amount p.285 | |
| d | L Delay [msec] | 0...2000 | Sets the delay time for the left channel | |
| e | R Delay [msec] | 0...2000 | Sets the delay time for the right channel | |
| f | Feedback | -100...+100 | Sets the feedback amount p.285 | |
| | High Damp [%] | 0...100 | Sets the damping amount in the high range | |
| | Feedback Position | Pre, Post | Switches the feedback connection p.285 | |
| g | Spread | -100...+100 | Sets the width of the stereo image of the effect sound p.289 | |
| | Input Level D-mod [%] | -100...+100 | Sets the modulation amount of the input level p.284 | |
| i | Src | Off...Tempo | Selects the modulation source for the input level p.284 | |
| | Wet/Dry | Dry, 1 : 99... 99 : 1, Wet | Sets the balance between the effect and the dry input | |
| | Amt | -100...+100 | Sets the modulation amount for Wet/Dry | |

a: L/R Pitch

When you select Up/Down for this parameter, the pitch shift amount for the right channel will be reversed. If the pitch shift amount is positive, the pitch of the left channel is raised, and the pitch of the right channel is lowered.

185: St. PitchShift BPM (Stereo Pitch Shifter BPM)

This stereo pitch shifter enables you to set the delay time to match the song tempo.

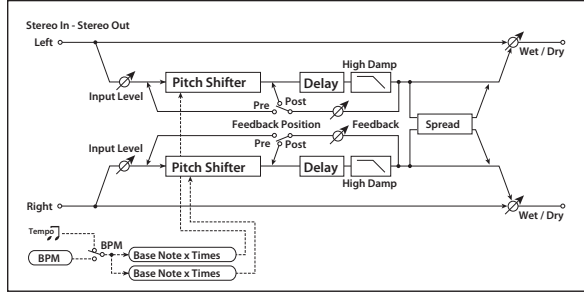

| | | | | |
|---|-----------------------|----------------------------|---|--|
| a | Mode | Slow, Medium, Fast | Switches Pitch Shifter mode p.285 | |
| | L/R Pitch | Normal, Up/Down | Determines whether or not the L/R pitch shift amount is inverted p.332 | |
| b | Pitch Shift [1/2tone] | -24...+24 | Sets the pitch shift amount in steps of a semitone p.285 | |
| | Src | Off...Tempo | Selects the modulation source of pitch shift amount p.285 | |
| | Amt | -24...+24 | Sets the modulation amount of pitch shift amount p.285 | |
| c | Fine [cent] | -100...+100 | Sets the pitch shift amount in steps of one cent p.285 | |
| | Amt | -100...+100 | Sets the modulation amount of pitch shift amount Sets the modulation amount of pitch shift amount p.285 | |
| d | BPM | MIDI, 40.00... 300.00 | MIDI syncs to the system tempo; 40-300 sets the tempo manually for this individual effect p.285 | |
| | Time Over? L | ---, OVER! | Display the error message if the left channel delay time exceeds the upper limit p.285 | |
| | R | ---, OVER! | Display the error message if the right channel delay time exceeds the upper limit p.285 | |
| e | L Delay Base Note | | Selects the type of notes to specify the left channel delay time p.285 | |
| | Times | x1...x32 | Sets the number of notes to specify the left channel delay time p.285 | |
| f | R Delay Base Note | | Selects the type of notes to specify the right channel delay time p.285 | |
| | Times | x1...x32 | Sets the number of notes to specify the right channel delay time p.285 | |
| g | Feedback Position | Pre, Post | Switches the feedback connection p.285 | |
| | Spread | -100...+100 | Sets the width of the stereo image of the effect sound p.285 | |
| h | Feedback | -100...+100 | Sets the feedback amount p.285 | |
| | High Damp [%] | 0...100 | Sets the damping amount in the high range | |
| i | Input Level D-mod [%] | -100...+100 | Sets the modulation amount of the input level p.284 | |
| | Src | Off...Tempo | Selects the modulation source for the input level p.284 | |
| j | Wet/Dry | Dry, 1 : 99... 99 : 1, Wet | Sets the balance between the effect and the dry input | |
| | Src | Off...Tempo | Selects a modulation source for Wet/Dry | |
| | Amt | -100...+100 | Sets the modulation amount for Wet/Dry | |

186: Rotary SpeakerOD (Rotary Speaker Overdrive)

This is a stereo rotary speaker effect. It has an internal speaker simulator that simulates overdrive (recreating the amp distortion) and characteristics of the rotary speaker, producing a very realistic rotary speaker sound.

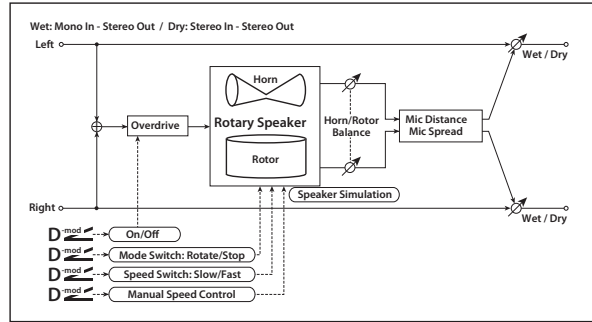

| | | | | |
|---|--------------------|----------------------------|---|--|
| a | Overdrive | Off, On | Switches overdrive on/off | |
| | Src | Off...Tempo | Selects a modulation source to switch overdrive on/off | |
| b | Sw | Toggle, Moment | Sets the switch mode for overdrive on/off modulation p.334 | |
| | Overdrive Gain | 0...100 | Determines the degree of distortion | |
| c | Overdrive Level | 0...100 | Sets the overdrive output level | |
| | Overdrive Tone | 0...15 | Sets the tonal quality of the overdrive | |
| d | Speaker Simulator | Off, On | Switches the speaker simulation on/off | |
| | Mode Switch | Rotate, Stop | Switches between speaker rotation and stop | |
| | Src | Off...Tempo | Selects a modulation source for Rotate/Stop | |
| e | Sw | Toggle, Moment | Sets the switch mode for Rotate/Stop modulation p.287 | |
| | Speed Switch | Slow, Fast | Switches the speaker rotation speed between slow and fast | |
| | Src | Off...Tempo | Selects a modulation source for Slow/Fast | |
| f | Sw | Toggle, Moment | Sets the switch mode for Slow/Fast modulation p.287 | |
| | Horn/Rotor Balance | Rotor, 1...99, Horn | Sets the volume balance between the high-range horn and low-range rotor | |
| g | Manual SpeedCtrl | Off...Tempo | Sets a modulation source for direct control of rotation speed p.287 | |
| | Horn Acceleration | 0...100 | Sets how quickly the horn rotation speed changes p.287 | |
| h | Horn Ratio | Stop, 0.50...2.00 | Adjusts the (high-frequency) horn rotation speed. Standard value is 1.00. "Stop" stops the rotation | |
| | Rotor Acceleration | 0...100 | Sets how quickly the rotor speed changes p.287 | |
| i | Rotor Ratio | Stop, 0.50...2.00 | Adjusts the (low-frequency) rotor rotation speed. Standard value is 1.0. "Stop" stops the rotation | |
| | Mic Distance | 0...100 | Distance between the microphone and rotary speaker p.287 | |
| j | Mic Spread | 0...100 | Angle of left and right microphones p.287 | |
| | Wet/Dry | Dry, 1 : 99... 99 : 1, Wet | Sets the balance between the effect and the dry input | |
| | Src | Off...Tempo | Selects a modulation source for Wet/Dry | |
| j | Amt | -100...+100 | Sets the modulation amount for Wet/Dry | |

a: Sw

This parameter determines how to switch on/off the overdrive via a modulation source.

When **Sw** = Toggle, overdrive is turned on/off each time the pedal or joystick is operated.

MIDI Overdrive will be switched on/off each time the value of the modulation source exceeds 64.

When **Sw** = Moment, overdrive is applied only when you press the pedal or operate the joystick.

MIDI Only when the value for the modulation source is 64 or higher, the overdrive effect is applied.

188: L/C/R Long Delay

This multitap delay outputs three Tap signals to left, right and center respectively. You can set a maximum of 5,460msec for the delay time.

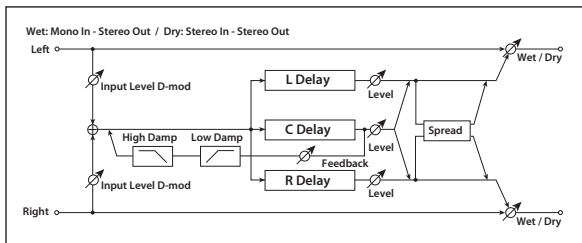

| | | | | |
|---|-----------------------|----------------------------|--|------------------------|
| a | L Delay Time [msec] | 0...5460 | Sets the delay time of TapL | |
| | Level | 0...50 | Sets the output level of TapL | |
| b | C Delay Time [msec] | 0...5460 | Sets the delay time of TapC | |
| | Level | 0...50 | Sets the output level of TapC | |
| c | R Delay Time [msec] | 0...5460 | Sets the delay time of TapR | |
| | Level | 0...50 | Sets the output level of TapR | |
| d | Feedback (C Delay) | -100...+100 | Sets the feedback amount of the TapC feedback | D^{mod} |
| | Src | Off...Tempo | Selects the modulation source for the TapC feedback | |
| | Amt | -100...+100 | Sets the modulation amount of the TapC feedback | |
| e | High Damp [%] | 0...100 | Sets the damping amount in the high range | p.289 |
| | Low Damp [%] | 0...100 | Sets the damping amount in the low range | p.289 |
| f | Input Level D-mod [%] | -100...+100 | Sets the modulation amount of the input level | D^{mod} |
| | Src | Off...Tempo | Selects the modulation source for the input level | p.284 |
| g | Spread | 0...50 | Sets the width of the stereo image of the effect sound | p.289 |
| h | Wet/Dry | Dry, 1 : 99... 99 : 1, Wet | Sets the balance between the effect and the dry input | D^{mod} |
| | Src | Off...Tempo | Selects a modulation source for Wet/Dry | |
| | Amt | -100...+100 | Sets the modulation amount for Wet/Dry | |

189: St/Cross Long Delay (Stereo/Cross Long Delay)

This is a stereo delay, and can be used as a cross-feedback delay effect in which the delay sounds cross over between left and right by changing the feedback routing. You can set a maximum of 2,730msec for the delay time.

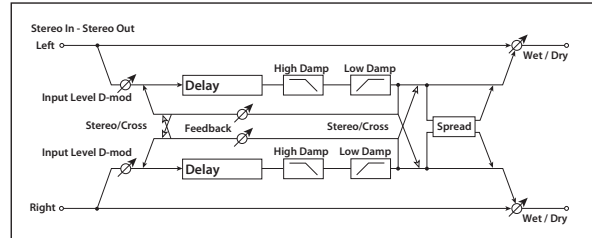

| | | | | |
|---|-----------------------|----------------------------|--|------------------------|
| a | Stereo/Cross | Stereo, Cross | Switches between stereo delay and cross-feedback delay | |
| b | L Delay Time [msec] | 0.0...2730.0 | Sets the delay time for the left channel | |
| c | R Delay Time [msec] | 0.0...2730.0 | Sets the delay time for the right channel | |
| d | L Feedback | -100...+100 | Sets the feedback amount for the left channel | D^{mod} |
| | Src | Off...Tempo | Selects the modulation source of feedback amount | |
| e | Amt | -100...+100 | Sets the modulation amount of the left channel feedback | |
| | R Feedback | -100...+100 | Sets the feedback amount for the right channel | D^{mod} |
| f | Amt | -100...+100 | Sets the modulation amount of the right channel feedback | |
| | High Damp [%] | 0...100 | Sets the damping amount in the high range | p.289 |
| g | Low Damp [%] | 0...100 | Sets the damping amount in the low range | p.289 |
| h | Input Level D-mod [%] | -100...+100 | Sets the modulation amount of the input level | D^{mod} |
| | Src | Off...Tempo | Selects the modulation source for the input level | p.284 |
| i | Spread | -50...+50 | Sets the width of the stereo image of the effect sound | p.289 |
| j | Wet/Dry | Dry, 1 : 99... 99 : 1, Wet | Sets the balance between the effect and the dry input | D^{mod} |
| | Src | Off...Tempo | Selects a modulation source for Wet/Dry | |
| | Amt | -100...+100 | Sets the modulation amount for Wet/Dry | |

190: Hold Delay

This effect records the input signal and plays it back repeatedly. You can control the start of recording and reset via a modulation source. Easy to use for real-time performances.

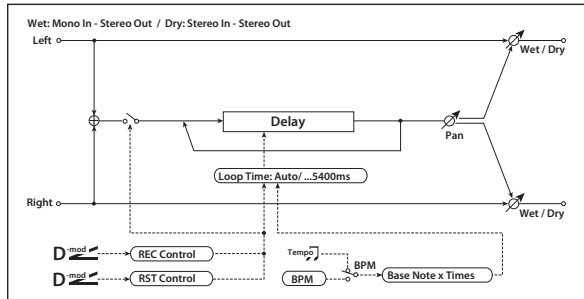

| | | | | |
|---|--------------------|----------------------------|---|--|
| a | Loop Time [msec] | Auto, 1...10800 | Sets Automatic loop time setup mode or specifies loop time p.335 | |
| b | Loop BPM Sync | Off, On | Specifies whether delay time is set in milliseconds, or as a note value relative to tempo p.335 | |
| c | BPM | MIDI, 40.00...300.00 | MIDI syncs to the system tempo; 40-300 sets the tempo manually for this individual effect p.335 | |
| | Time Over? | ---, OVER! | An error indication that appears if delay time exceeds the upper limit when MIDI/Tempo Sync=On | |
| d | Loop Base Note | | Selects the type of notes to specify the delay time p.335 | |
| | Times | x1...x32 | Sets the number of notes to specify the delay time p.335 | |
| e | REC Control Src | Off...Tempo | Selects control source for recording p.335 | |
| f | RST Control Src | Off...Tempo | Selects control source for reset p.335 | |
| g | Manual REC Control | REC Off, REC On | Sets the recording switch p.335 | |
| h | Manual RST Control | Off, RESET | Sets the reset switch p.335 | |
| i | Pan | L100..L1, C, R1..R100 | Sets the stereo image of the effect | |
| | Src | Off...Tempo | Selects the modulation source of stereo image of the effect | |
| | Amt | -100...+100 | Sets the modulation amount of stereo image of the effect | |
| j | Wet/Dry | Dry, 1 : 99... 99 : 1, Wet | Sets the balance between the effect and the dry input | |
| | Src | Off...Tempo | Selects a modulation source for Wet/Dry | |
| | Amt | -100...+100 | Sets the modulation amount for Wet/Dry | |

a: Loop Time [msec]

With Auto, the loop time is automatically set. Otherwise, you can specify the loop time.

When Auto is selected, the Loop Time is automatically set to the time it takes for a performance recorded while the Modulation Source or **Manual REC Control** is on. However, if the time length exceeds 10,800msec, the loop time will be automatically set to 10,800msec.

c: Time Over?

You can set the delay time up to 10,800msec. If the delay time exceeds this limit, the error message "OVER!" appears in the display. Set the delay time parameters so that this message will not appear. **Time Over?** is only a display parameter.

b: Loop BPM Sync

c: BPM

d: Loop Base Note

d: Times

If **Loop BPM Sync** is on, the **Times** setting is ignored; the loop time is determined by **BPM**, **Loop Base Note**, and **Times**. Even in this case, the delay time cannot exceed 10,800 msec.

"Hold" procedure (when Loop Time = Auto)

1. "Rec Src" JS +Y: #01
 "Reset Src" JS -Y: #02
 "Manual REC Control" REC Off
 "Manual RST Control" RESET
 "Loop Time [msec]" Auto
 "MIDI/Tempo Sync" Off
 It should be noted that all recordings will be deleted while Reset is On.
2. "Manual RST Control" Off
 Reset is cancelled and the unit enters Rec ready mode.
3. Push the joystick in the +Y direction (forward) and play a phrase you wish to hold. When you pull the joystick to its original position, the recording will be finished and the phrase you just played will be held.
 Loop Time is automatically set only for the first recording after resetting. If the time length exceeds 10,800msec, Loop Time will be automatically set to 10,800msec. (If you have set **Times** to 1-10,800msec, the specified loop time will be used regardless of the time taken from pushing the joystick forward until it is pulled back. However, the recording method remains the same. The phrase being played while the joystick is pushed forward will be held.)
4. If you made a mistake during recording, pull the joystick in the -Y direction (back) to reset. In this way, the recording will be erased. Repeat step 3. again.
5. The recorded phrase will be repeated again and again. You can use this to create an accompaniment.
6. By pushing the joystick in the +Y direction (forward), you can also overdub performances over the phrase that is being held.

e: REC Control Src

g: Manual REC Control

REC Control Src selects the modulation source that controls recording.

If this modulation is on, or if **Manual REC Control** is set to On, you can record the input signal. If a recording has already been carried out, additional signals will be overdubbed.

The effect is off when a value for the modulation source specified for the **REC Control Src** parameter is 63 or smaller, and the effect is on when the value is 64 or higher.

f: RST Control Src

h: Manual RST Control

The **RST Control Src** parameter specifies the modulation source that controls the reset operation.

When you set this modulation source to On, or **Manual RST Control** to RESET, you can erase what you recorded. If the Loop Time parameter has been set to Auto, the loop time is also reset.

The effect is off when a value for the modulation source specified for the **RST Control Src** parameter is 63 or smaller, and the effect is on when the value is 64 or higher.

191: LCR BPM Long Dly (L/C/R BPM Long Delay)

The L/C/R delay enables you to match the delay time with the song tempo.

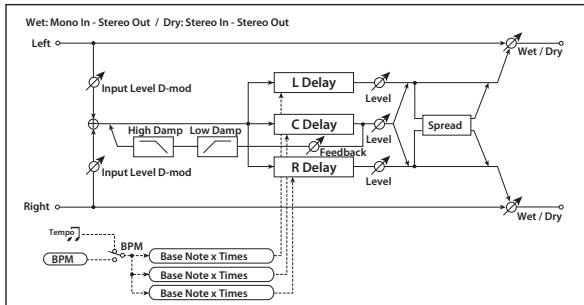

| | | | | |
|---|-----------------------|----------------------------|---|--|
| a | BPM | MIDI, 40.00... 300.00 | MIDI syncs to the system tempo; 40–300 sets the tempo manually for this individual effect p.285 | |
| | Time Over? | ---, OVER! | Displays an error message when the delay time exceeds the upper limit p.336 | |
| b | L Delay Base Note | | Selects the type of notes to specify the delay time for TapL p.285 | |
| | Times | x1...x32 | Sets the number of notes to specify the delay time for TapL p.285 | |
| | Level | 0..50 | Sets the output level of TapL | |
| c | C Delay Base Note | | Selects the type of notes to specify the delay time for TapC p.285 | |
| | Times | x1...x32 | Sets the number of notes to specify the delay time for TapC p.285 | |
| | Level | 0..50 | Sets the output level of TapC | |
| d | R Delay Base Note | | Selects the type of notes to specify the delay time for TapR p.285 | |
| | Times | x1...x32 | Sets the number of notes to specify the delay time for TapR p.285 | |
| | Level | 0..50 | Sets the output level of TapR | |
| e | Feedback (C Delay) | -100...+100 | Sets the feedback amount of TapC | |
| | Src | Off...Tempo | Selects the modulation source for the TapC feedback | |
| | Amt | -100...+100 | Sets the modulation amount of the TapC feedback | |
| f | High Damp [%] | 0..100 | Sets the damping amount in the high range p.289 | |
| | Low Damp [%] | 0..100 | Sets the damping amount in the low range p.289 | |
| g | Input Level D-mod [%] | -100...+100 | Sets the modulation amount of the input level p.284 | |
| | Src | Off...Tempo | Selects the modulation source for the input level p.284 | |
| h | Spread | 0..50 | Sets the width of the stereo image of the effect sound p.289 | |
| i | Wet/Dry | Dry, 1 : 99... 99 : 1, Wet | Sets the balance between the effect and the dry input | |
| | Src | Off...Tempo | Selects a modulation source for Wet/Dry | |
| | Amt | -100...+100 | Sets the modulation amount for Wet/Dry | |

a: Time Over?

You can set the delay time up to 10,920msec. If the delay time exceeds this limit, the error message “OVER!” appears in the display. Set the delay time parameters so that this message will not appear. **Time Over?** is only a display parameter.

192: St. BPM Long Dly (Stereo BPM Long Delay)

The stereo delay enables you to match the delay time with the song tempo.

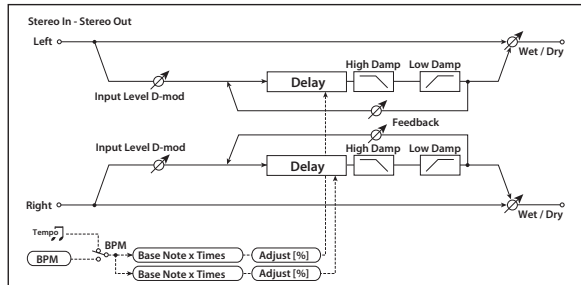

| | | | | |
|---|-----------------------|----------------------------|---|--|
| a | BPM | MIDI, 40.00... 300.00 | MIDI syncs to the system tempo; 40–300 sets the tempo manually for this individual effect p.285 | |
| | Time Over? L | ---, OVER! | Display the error message if the left channel delay time exceeds the upper limit p.336 | |
| | R | ---, OVER! | Display the error message if the right channel delay time exceeds the upper limit p.336 | |
| b | L Delay Base Note | | Selects the type of notes to specify the left channel delay time p.285 | |
| | Times | x1...x32 | Sets the number of notes to specify the left channel delay time p.285 | |
| | Adjust [%] | -2.50...+2.50 | Fine-adjust the left channel delay time | |
| c | R Delay Base Note | | Selects the type of notes to specify the right channel delay time p.285 | |
| | Times | x1...x32 | Sets the number of notes to specify the right channel delay time p.285 | |
| | Adjust [%] | -2.50...+2.50 | Fine-adjust the right channel delay time | |
| d | L Feedback | -100...+100 | Sets the feedback amount for the left channel | |
| | Src | Off...Tempo | Selects the modulation source of feedback amount | |
| | L Amt | -100...+100 | Sets the modulation amount of the left channel feedback | |
| e | R Feedback | -100...+100 | Sets the feedback amount for the right channel | |
| | R Amt | -100...+100 | Sets the modulation amount of the right channel feedback | |
| f | High Damp [%] | 0..100 | Sets the damping amount in the high range p.289 | |
| g | Low Damp [%] | 0..100 | Sets the damping amount in the low range p.289 | |
| h | Input Level D-mod [%] | -100...+100 | Sets the modulation amount of the input level p.284 | |
| | Src | Off...Tempo | Selects the modulation source for the input level p.284 | |
| i | Wet/Dry | Dry, 1 : 99... 99 : 1, Wet | Sets the balance between the effect and the dry input | |
| | Src | Off...Tempo | Selects a modulation source for Wet/Dry | |
| | Amt | -100...+100 | Sets the modulation amount for Wet/Dry | |

a: Time Over? L, R

You can set the delay time up to 5,460msec. If the delay time exceeds this limit, the error message “OVER!” appears in the display. Set the delay time parameters so that this message will not appear. **Time Over?** is only a display parameter.

193: Early Reflections

This early reflection effect has more precise early reflections with twice the maximum length of a normal-size effect (See “094: Early Reflections” on page 300.). You can create a very smooth and dense sound.

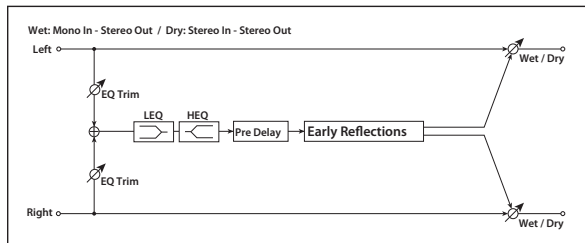

| | | | | |
|---|-------------------|----------------------------------|---|--|
| a | Type | Sharp, Loose, Modulated, Reverse | Selects the decay curve for the early reflection p.300 | |
| b | ER Time [msec] | 10...1600 | Sets the time length of early reflection | |
| c | Pre Delay [msec] | 0...200 | Sets the time taken from the original sound to the first early reflection | |
| d | EQ Trim | 0...100 | Sets the input level of EQ applied to the effect sound | |
| e | Pre LEQ Fc | Low, Mid-Low | Selects the cutoff frequency (low or mid-low) of the low-range equalizer | |
| | Pre HEQ Fc | High, Mid-High | Selects the cutoff frequency (high or mid-high) of the high-range equalizer | |
| f | Pre LEQ Gain [dB] | -15.0...+15.0 | Sets the gain of Low EQ | |
| | Pre HEQ Gain [dB] | -15.0...+15.0 | Sets the gain of High EQ | |
| g | Wet/Dry | Dry, 1 : 99... 99 : 1, Wet | Sets the balance between the effect and the dry input | |
| | Src | Off...Tempo | Selects a modulation source for Wet/Dry | |
| | Amt | -100...+100 | Sets the modulation amount for Wet/Dry | |



Appendices

Alternate Modulation Sources (AMS)

Alternate Modulation Overview

Alternate Modulation lets you use controllers, envelopes, LFOs, etc. to modulate Program parameters. You can use one controller to modulate multiple parameters simultaneously. You can also create complex modulation setups in which (for example) an envelope modulates the frequency of an LFO, and that LFO is then used to modulate a filter.

Programs provide 48 types (88 destinations) for alternate modulation.

Alternate Modulation Sources

You can use the sources listed on the following page to control Alternate Modulation. If you select two or more Alternate Modulation destinations for control by the same AMS, a single source will apply modulation to each of the specified destinations.

Frequently used assignments such as using Joystick X to control pitch are provided as special parameters, so it is not necessary to use Alternate Modulation to accomplish this.

AMS Mixers

The AMS Mixers combine two AMS sources into one, or process an AMS source to make it into something new.

For instance, they can add two AMS sources together, or use one AMS source to scale the amount of another. You can also use them to change the shapes of LFOs and EGs in various ways, modify the response of realtime controllers, and more.

The AMS Mixer outputs appear in the list of AMS sources, just like the LFOs and EGs.

The original, unmodified inputs to the AMS Mixers are still available as well. For instance, if you use LFO 1 as an input to a AMS Mixer, you can use the processed version of the LFO to control one AMS destination, and the original version to control another.

Finally, you can cascade two AMS Mixers together, by using one as the input of another.

For more information, please see “6-1: OSC1 AMS Mix1” on page 46.

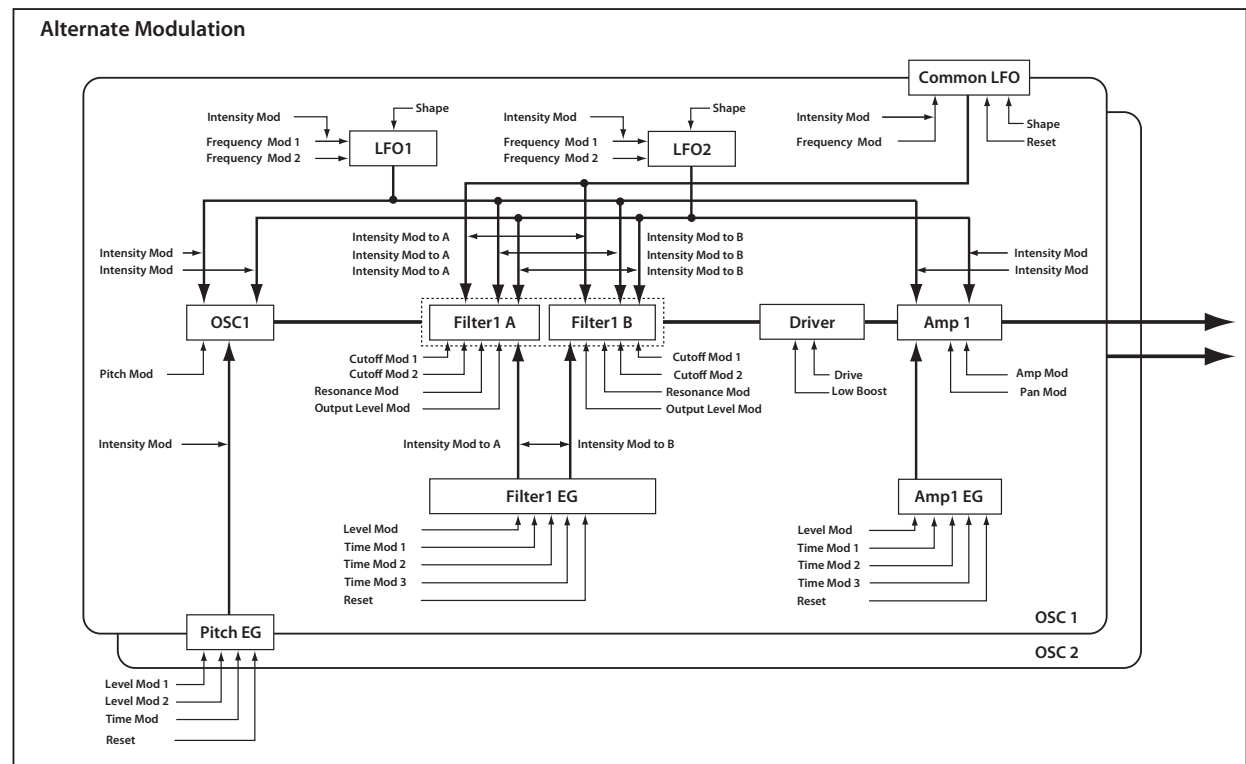

AMS (Alternate Modulation Source) List

Physical and MIDI controllers

Off

This means that no modulation source is selected.

Note Number

This is the note's MIDI note number, from 0 (C-2) to 127 (G9).

Velocity

This is the note's MIDI note-on velocity.

Exp. Velocity (Exponential Velocity)

This is MIDI note-on velocity through an exponential curve. The curve means that low velocities won't have very much effect, and the difference between two lower velocity values won't be very noticeable.

On the other hand, high velocities produce increasingly greater effects, and the difference between any two higher velocity values will be more pronounced.

Poly After

Polyphonic aftertouch allows a different aftertouch value for each note. This can be received from external MIDI devices or generated by the internal sequencer. The KROME keyboard itself does not generate poly aftertouch, however.

After Touch

The effect will be applied by channel aftertouch messages from the KROME's sequence data or received from MIDI IN.

JS X

This is the horizontal movement of the main joystick. It also receives MIDI Pitchbend.

JS+Y: CC#01

This is the vertical movement of the main joystick, upwards from the center. It also receives MIDI CC#01 (mod wheel).

JS-Y: CC#02

This is the vertical movement of the main joystick, downwards from the center. It also receives MIDI CC#02 (breath controller).

JS +Y & AT/2 (Joy Stick +Y & After Touch/2)

The effect will be controlled by the joystick +Y (Vertical upward) and by aftertouch. In this case, the effect of aftertouch will be only half of the specified intensity.

JS -Y & AT/2 (Joy Stick -Y & After Touch/2)

The effect will be controlled by the joystick -Y (Vertical downward) and by aftertouch. In this case, the effect of aftertouch will be only half of the specified intensity.

Pedal: CC#04 (Foot Pedal: CC#04)

This AMS source receives MIDI CC#04. It can also be generated by a foot pedal connected to the rear-panel ASSIGNABLE PEDAL input, if the Global **Foot Pedal Assign** parameter is set to Foot Pedal (CC#04). For more information, please see "Foot Pedal Assignments" on page 350.

KnobMod1: #17 (Realtime Knob Modulation1: CC#17)

This AMS source always responds to MIDI CC#17. A MIDI value of 0 causes the maximum negative modulation; 64 (center) means no modulation; and 127 causes the maximum positive modulation. (You can invert this response, if desired, by using a negative AMS intensity.)

It also usually corresponds to Realtime Controls USER knob 1 on the Controllers Setup page; but this will depend on the Realtime Controls knob Assign settings of each individual Program, Combination, and Song.

Basically, there are two separate factors: a physical knob named USER knob 1, and an AMS source named "Knob Mod.1: #17." This provides a great deal of flexibility—but it's also easy to link the two together. To do so:

1. Go to the current mode's **Controllers** page.
2. Set knob USER 1's **Realtime Controls Knob Assign to Knob Mod.1: #17**.

For more information, please see "1-3: Controllers Setup" on page 16, and "Realtime Controls Knobs 1-4 Assignments" on page 348.

KnobMod2: #19 (Realtime Knob Modulation2: CC#19)

This AMS source always responds to MIDI CC#19, and will usually also correspond to Realtime Controls USER knob 2. For more information, please see "KnobMod1: #17 (Realtime Knob Modulation1: CC#17)" on page 340.

KnobMod3: #20 (Realtime Knob Modulation3: CC#20)

This AMS source always responds to MIDI CC#20, and will usually also correspond to Realtime Controls USER knob 3. For more information, please see "KnobMod1: #17 (Realtime Knob Modulation1: CC#17)" on page 340.

KnobMod4: #21 (Realtime Knob Modulation4: CC#21)

This AMS source always responds to MIDI CC#21, and will usually also correspond to Realtime Controls USER knob 4. For more information, please see "KnobMod1: #17 (Realtime Knob Modulation1: CC#17)" on page 340.

KnobMod1[+] (Realtime Knob Modulation1[+])

KnobMod2[+] (Realtime Knob Modulation2[+])

KnobMod3[+] (Realtime Knob Modulation3[+])

KnobMod4[+] (Realtime Knob Modulation4[+])

With these AMS sources, the knob position and the direction of the resulting change are different than KnobMod1: #17–KnobMod4: #21. If AMS intensity is set to a positive (+) value, rotating the knob to the far left will produce an AMS effect of 0. Rotating the knob toward the right will apply change only in the positive direction. (If the intensity is set to a negative value, the result will be the opposite.)

Damper: #64

This is the Damper pedal, also sometimes called the sustain pedal. It corresponds to MIDI CC#64.

When using Korg's optional half-damper pedal, the DS-1H, this AMS source is continuous—not just on/off.

Porta.SW: #65

This is the MIDI portamento switch (CC#65), which also enables and disables portamento.

Sostenuto: #66

This is the MIDI sostenuto pedal (CC#66).

Soft: CC#67

This is the MIDI oft pedal (CC#67).

SW 1: CC#80 (SW 1 Modulation: CC#80)

This is CC#80, which is the default for assignable front-panel switch 1 (SW1). To use SW1 and SW2 as AMS sources:

1. Go to the **Controllers Setup** page.
2. Under **Panel Switch Assign**, assign SW1 to SW1 Mod. (CC#80) and SW2 to SW2 Mod. (CC#81).

These assignments are stored separately for each Program, Combination, and Song.

For more information, please see "SW1/2 Assignments" on page 348.

SW 2: CC#81 (SW 2 Modulation: CC#81)

This is CC#81, which is the default for assignable front-panel switch 2 (SW2). For more information, please see "SW 1: CC#80 (SW 1 Modulation: CC#80)" above.

Foot SW: #82 (Foot SW: CC#82)

This AMS source receives MIDI CC#82. It can also be generated by a foot switch connected to the rear-panel ASSIGNABLE SWITCH input, if the Global **Foot Pedal Assign** parameter is set to Foot SW (CC#82). For more information, please see “Foot Switch Assignments” on page 349.

MIDI: CC#83

MIDI control change (CC#83)

Tempo

This lets you use the system tempo as a modulation source. 120 is the center, for a value of 0; 60BPM is -99, and 240BPM is +99.

Note that this is different from actually syncing to tempo; for that purpose, use the dedicated synchronization functions for the LFOs, effects, etc.

Gate1

Gate1+Damper

Gate 1 is triggered by a new note after all notes have been released, such as at the beginning of a phrase. Gate 1+Damper is similar, except that it is triggered by a new note-on after all notes and the damper are released.

You can use this to reset the Common LFO. For instance, to create an effect similar to the per-voice LFO and Step Sequencer’s **Key Sync Off** setting, use **Gate 1 + Damper** as the reset source.

Gate2

Gate2+Damper

Gate 2 is similar to Gate 1, but it triggers with every new note-on, even in the middle of a legato phrase. Gate2+Damper includes the damper pedal in the equation, as shown in the diagram below.

Note: When used as a reset controller for Common LFO, Gate2 and Gate2+Damper will have the same effect.

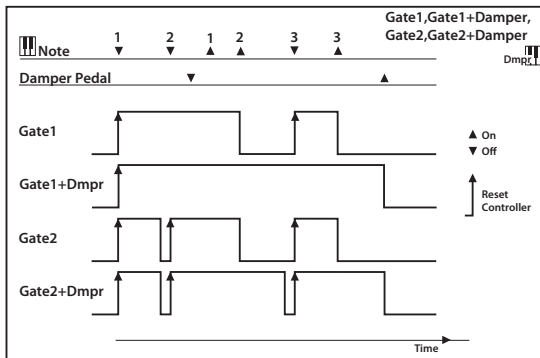

Alternate Modulation settings

When you operate an AMS (Alternate Modulation Source), the modulation destination will be affected as shown in the table below.

By using alternate modulation, you can create complex systems of modulation in which EG, LFO, keyboard tracks, and controllers work together.

- You can apply complex change to an LFO or EG, for example by using the pitch/filter/amp EG to control the frequency or intensity of an LFO that modulates the pitch/filter/amp, or by using LFO2 to control the frequency of LFO1.

- The tone, EG, and LFO etc. can be controlled not only by key velocity or the joystick, but also from a button, knob, or pedal etc.
- Panning can be controlled in realtime from a controller, EG, or LFO etc.
- You can use the filter EG to control pitch or volume at the same time that it controls the filter.
- Controllers etc. can be used to control EG levels or times. This lets you shape the EG in realtime.
- Filter/amp keyboard tracking or note number can be used to control the EG or LFO according to the keyboard pitch that is played.
- Pitch, tone, EG or LFO can be controlled by the tempo of the arpeggiator and/or sequencer.

AMS operations and their result

| AMS source & value range | Amp EG 0...+99 | Pitch & Filter EGs -99...0...+99 | LFO1 & 2 -99...0...+99 | Common LFO -99...0...+99 | Filter & Amp Key Track -99...0...+99 | Common Key Track 1 & 2 -99...0...+99 | Note Number C-1...C4...C9 | EXT(+/-) *1 -Max...0...+Max | EXT(+) *3 0...127 |
|--|------------------------|--|--|-----------------------------|--|---|------------------------------|---|----------------------|
| Parameter AMS Intensity | | | | | | | | EXT (Tempo) *2 = .60.00...120.00...240.00... | |
| Pitch *4 (+12.00) | 0...+1 Octave | -1...0...+1 Octaves (Filter EG as AMS; dedicated parameter for Pitch EG) | Dedicated parameter | -1...0...+1 Octaves | - | | Dedicated parameter | -1...0...+1 Octaves | 0...+1 Octave |
| Pitch EG Int. (+12.00) | - | Dedicated parameter for Pitch EG | - | | -1...0...+1 Octaves | | | -1...0...+1 Octaves | 0...+1 Octave |
| Pitch LFO1/2 Int. (+12.00) | 0...+1 Octave | -1...0...+1 Octaves | - | | | | -1...0...+1 Octaves | | 0...+1 Octave |
| Filter Frequency (+99) | 0...+10 Octaves | -10...0...+10 Octaves (Pitch EG as AMS; dedicated parameter for Filter EG) | Dedicated parameter | | Dedicated parameter for Filter KTrk | -10...0...+10 Octaves | - | -10...0...+10 Octaves | 0...+10 Octaves |
| Filter Resonance (+99) | 0...+99 | | | | | | | | 0...+99 |
| Filter EG Int. (+99) | - | Dedicated parameter for Filter EG | - | -99...0...+99 | - | -99...0...+99 | - | -99...0...+99 | 0...+99 |
| Filter LFO1/ 2 Int. (+99) | 0...+99 | -99...0...+99 | - | | | | | -99...0...+99 | 0...+99 |
| Filter Output Level A/B (+99) | 0...+99 | | | | | | | -99...0...+99 | 0...+99 |
| Drive (+99) | 0...+99 | | | | | | | -99...0...+99 | 0...+99 |
| Low Boost (+99) | 0...+99 | | | | | | | -99...0...+99 | 0...+99 |
| Amp (+99) | Dedicated parameter | 0...1x...8x | Dedicated parameter | 0...1x...8x | Dedicated parameter for Amp KTrk | - | - | 0...1x...8x | 1x...8x |
| Amp LFO1/2 Int. (+99) | 0...+99 | -99...0...+99 | - | | | | | -99...0...+99 | 0...+99 |
| Pan (+50) | 0...+63 | | | | | | | -63...0...+63 | 0...+63 |
| EG Level (+66) | | | | | | | | -99...0...+99 | 0...+99 |
| EG Time (+49) | | | | | | | | 1/64x...1x...64x | 1x...64x |
| LFO 1 Frequency *4 (+99) | 1x...64x | | 1/64x... 1x...64x (LFO2 only) | | | | | 1/64x...1x...64x | 1x...64x |
| LFO 2 Frequency *4 (+99) | 1x...64x | | - | | | | | 1/64x...1x...64x | 1x...64x |
| Common LFO Frequency *4 (+99) | | | - | | | | | 1/64x...1x...64x | 1x...64x |
| LFO 1 Shape (+99) | 0...+99 | | -99...0...+99 (LFO2 only) | | | | | -99...0...+99 | 0...+99 |
| LFO 2 Shape (+99) | 0...+99 | | - | | | | | -99...0...+99 | 0...+99 |
| Common LFO Shape (+99) | | | - | | | | | -99...0...+99 | 0...+99 |

Notes for the table

- *1 EXT(+/-): JS X, Ribbon:CC#16, Knob Mod1 (CC#17), Knob Mod2 (CC#19), Knob Mod3 (CC#20), Knob Mod4 (CC#21)
- *2 When Tempo is selected as an AMS source, the base value is $\downarrow=120.00$.
For example if the Pitch AMS is set to Tempo, and Intensity is set to 12.00, doubling the tempo value ($\downarrow=120.00 \rightarrow 240.00$) will raise the pitch one octave, and halving the tempo ($\downarrow=120.00 \rightarrow 60.00$) will lower the pitch one octave. The stated modulation results are for tempo values between 60bpm and 240bpm. As the tempo decreases from 60 to 0bpm, AMS modulation will have increasingly negative effects; as it increases from 240 to 250bpm, modulation will have increasingly positive effects.
- *3 EXT(+): Velocity, Exp. Velocity, Poly After, After Touch, JS+Y:CC#01, JS-Y:CC#02, JS+Y & AT/2, JS-Y & AT/2, Pedal:CC#04, ValueSlidr:#18, Knob Mod1[+], Knob Mod2[+], Knob Mod3[+], Knob Mod4[+], Damper:CC#64, Porta.SW:CC#65, Sostenuo:CC#66, Soft:CC#67, SW1:CC#80, SW2:CC#81, MIDI:CC#83, MIDI:CC#85, MIDI:CC#86, MIDI:CC#87, MIDI:CC#88.
- *4 It is possible to control LFO **Frequency** by using Tempo **AMS** and **Intensity**. However if you use the Frequency MIDI/Tempo Sync function (Prog 5-1c), the LFO frequency can be synchronized to the tempo and note value.

The effects of AMS on various parameters, and example applications

We'll describe some examples of using alternate modulation.

Pitch (Prog 2-2a)

Pitch can be controlled by the Common LFO, filter/amp EG, controllers, or tempo etc.

- If you select Filter EG or Amp EG as the **AMS** and set **Intensity** to +12.00, the pitch will change up to ± 1 octave in synchronization with the EG.
- If you select Tempo as the **AMS** and set **Intensity** to +12.00, doubling the tempo (based on $\downarrow=120.00$) will raise the pitch one octave, and halving the tempo will lower the pitch one octave.

Pitch EG (Prog 2-2b)

Pitch EG intensity can be controlled by the Common LFO, keyboard tracking, controllers, or tempo.

- If you select JS +Y:CC#01 as the **AMS** and set **Intensity** to +12.00, moving the joystick in the +Y direction will gradually increase the effect of the Pitch EG to a maximum of ± 1 octave. If **Intensity** has a negative value, the effect of the Pitch EG will be inverted.

LFO 1/2 (Prog 2-2d)

Pitch modulation intensity of the LFO1/2 can be controlled by the Common LFO, an EG, keyboard tracking, controllers, or tempo etc.

- If you select EG as the **AMS**, the pitch change width of LFO modulation etc. can be controlled in synchronization with the level changes of the EG. With positive (+) settings of **Intensity**, the vibrato effect will gradually deepen as the EG level rises, or gradually lessen as the EG level decreases. With negative (-) settings of **Intensity**, the LFO phase will be inverted.
- If you select a controller such as SW1 or 2 as the **AMS**, you can press the SW1 or SW2 switch when desired to turn on the vibrato effect.

Filter (Cutoff) Frequency (Prog 3-1b(c))

The cutoff frequency of filter A/B can be controlled by the pitch/amp EG, Common keyboard tracking, controllers, or tempo. Use the 3-3: Filter1 Modulation page Filter A/B Modulation (Prog 3-3b) to set AMS and Intensity for Filter A or B.

- If you select JS X as the AMS1 or AMS2 and set **Intensity** to a positive (+) value, moving the joystick toward the right will raise the cutoff frequency, and moving it toward the left will lower the cutoff frequency. Negative (-) settings will have the opposite effect.
- If you select the same controller as an AMS1 or AMS2 and set separate intensities for Filter A (Low Pass Filter) **Intensity** and Filter B (High Pass Filter) **Intensity**, you can operate a single controller to simultaneously control the cutoff frequencies of both filters.

Resonance (Prog 3-1b)

You can use the EG, LFO, keyboard tracking, controllers, or tempo etc. to control the resonance level.

- If you select Filter KTrk or Amp KTrk as the **AMS**, you can use the filter or amp keyboard tracking settings to control the resonance level. For example if the amp keyboard tracking parameters **Ramp BtmLo** and **Ramp HiTop** are set to positive (+) values, Amp KTrk is selected as the **AMS**, and **Intensity** it set to a positive (+) value, playing toward either end of the keyboard will cause amp keyboard tracking to increase the volume, and **AMS** to raise the resonance level.
- You can select a controller as the **AMS**, and apply resonance when desired by operating the controller.
- You can select Common LFO, LFO1 or 2 as the **AMS**, and use the LFO to control the resonance level.

Output (Prog 3-1b)

You can use the EG, LFO, keyboard tracking, controllers, or tempo etc. to control the output level of Filter A/B.

- Set the Filter Routing to Parallel, and specify the desired Type and other settings for Filter A and Filter B. Set the **AMS** to LFO for Filter A and Filter B, and set the LFO to +99 and -99 respectively. The output of Filter A and Filter B will be cyclically faded-in/out by the LFO.

Filter EG Intensity (Prog 3-3a)

Filter EG intensity can be controlled by the Common LFO, Common keyboard tracking, a controller or tempo etc. You can use **Intensity to A** and **Intensity to B** to independently specify the intensity for Filter A and B.

- If you select JS -Y (CC#02) as the **AMS** and set **Intensity to A** and **Intensity to B** to a positive (+) value, moving the joystick in the -Y direction will gradually increase the effect of the Filter EG. If you set **Intensity to A** and **Intensity to B** to a negative (-) value, the effect of the Filter EG will be inverted.
- If you select JS X as the **AMS** and set **Intensity to A** and **Intensity to B** to a positive (+) value, operating the joystick toward the right will gradually increase the effect of the Filter EG. Operating the joystick toward the left will gradually increase the effect of the Filter EG with an inverted phase.

Filter LFO1/2 Intensity (Prog 3-4a)

The LFO 1/2 filter modulation intensity can be controlled by the EG, Common LFO, keyboard tracking, controller, or tempo etc. You can use **Intensity to A** and **Intensity to B** to independently specify the intensity for Filter A and B.

- If you select EG as the **AMS**, the auto-wah effect produced by LFO modulation will be controlled by the changes in EG level. If you set **Intensity to A** and **Intensity to B** to a positive (+) value, the wah effect will deepen as the EG level rises, and will lessen as the EG

level falls. With negative (–) values of **Intensity to A** and **Intensity to B**, the phase of the LFO will be inverted.

- If you use a controller such as SW1 or 2 as the **AMS**, you can apply the auto-wah effect when desired by pressing the SW1 or SW2 switch.

Filter Common LFO (Prog 3–4b)

You can use the EG, LFO, keyboard tracking, controllers, or tempo etc. to control the Common LFO filter modulation intensity. You can use **Intensity to A** and **Intensity to B** to specify the intensity separately for Filter A and B.

- You can set **AMS** to a controller, and operate the controller only when desired to control the depth of the filter sweep produced by the Common LFO.

Driver Drive (Prog 4–1a)

Driver Low Boost (Prog 4–1a)

You can use the EG, LFO, keyboard tracking, controllers, and tempo etc. to control the driver’s boost and low boost. Although you can use separate **AMS** to control these two parameters, it is also effective to control them simultaneously by using controllers such as the knobs etc. (It is particularly effective to control the filter resonance at the same time. This is also nice for synth bass sounds.)

- If you choose Knob Mod.1 (CC#17) as the **AMS**, set **Intensity** to a positive (+) value, and set Realtime Controls to USER, turning knob 1 toward the right of center will raise the drive or low boost level, while turning the knob toward the left of center will lower the drive or low boost level. If **Intensity** is set to a negative (–) value, the opposite will occur.
- If you set **AMS** to Common LFO, LFO 1, or 2, the drive amount will be controlled cyclically by the LFO.

Amp (Prog 4–2b)

The volume can be controlled by the pitch/filter EG, Common LFO, controllers, or tempo etc.

- If an EG or controller that changes with a positive (+) value (EXT(+)) is selected as the **AMS**, setting the **Intensity** to +99 will allow you to increase the volume to a maximum of eight times that of the current volume.
- If an EG, LFO, or controller that changes with a ± value (Pitch EG, Filter EG, LFO, KT, EXT(+–)) is selected as the **AMS**, setting the **Intensity** to +99 will allow you to increase the volume to a maximum of eight times that of the current volume (for positive (+) changes of the **AMS**), or to decrease the volume to zero (for negative (–) changes of the **AMS**).
- In addition to the time-variant changes in volume produced by the amp EG, you can also make the volume change in synchronization with the pitch/filter EG. Select Pitch EG or Filter EG as the **AMS**, and adjust **Intensity**. If you wish to cancel the effect of the Amp EG and use the pitch/filter EG to control the volume, set all levels of the Amp EG to +99.

Amp LFO1/2 Intensity (Prog 4–2b)

The amp modulation intensity of LFO 1/2 can be controlled by the EG, Common LFO, keyboard tracking, controllers, or tempo etc.

- If you select EG as the **AMS**, the depth of the tremolo effect produced by LFO modulation will change in synchronization with the changes in EG level. If you set **Intensity** to a positive (+) value, the tremolo effect will deepen as the EG level rises, and lessen as the EG level falls. If **Intensity** is set to a negative (–) value, the phase of the LFO will be inverted.
- If select a controller such as SW1 or 2 as the **AMS**, you can apply the tremolo effect by pressing the SW1 or SW2 switch when desired.

Pan (Prog 4–1c)

The oscillator pan can be controlled by the EG, LFO, keyboard tracking, controllers, or tempo etc.

- If you select Note Number as the **AMS** and set **Intensity** to +50, panning will be controlled by the keyboard position: center at the C4 note, far right at C9 or above, and far left at C–1 or below.
- If EG is selected as the **AMS**, the oscillator pan will be controlled in synchronization with the changes in EG level. If **Intensity** is set to a positive (+) value, the pan will move toward the right as the EG level increases, and toward the left as the EG level decreases. If **Intensity** is set to a negative (–) value, the opposite effect will occur.

EG Reset —

Pitch EG (Prog 2–8a)

Filter EG (Prog 3–5a)

Amp EG (Prog 4–3a)

You can use the EG, LFO, keyboard tracking, controllers, or tempo etc. to control EG Reset. Use the Threshold setting to specify the **AMS** value at which result will occur.

- By setting **AMS** to Common LFO, you can reset the envelope cyclically at the interval of the Common LFO. The result is just as if the shape specified by the envelope were being used as a special LFO.
- You can reset the envelope by setting **AMS** to a controller such as JS+Y, and operating the controller when desired, producing a one-shot filter envelope sweep.

EG Level —

Pitch EG (Prog 2–8c)

Filter EG (Prog 3–5c)

Amp EG (Prog 4–3c)

EG levels can be controlled by the Common LFO, keyboard tracking, controllers, or tempo etc.

You can specify an **Intensity** value for each EG segment (**Start**, **Attack**, **Break**). If you set the **Intensity** value to +66, you will be able to control the respective level over a maximum range of ±99.

- Set **AMS** to Velocity for Amp EG Level Modulation, **Intensity Start** to +00, **Attack** to +66, and **Break** to –66. Set all Amp EG levels to +00. As you play with increasing velocity, the EG levels will change more greatly. At the maximum velocity, the Start Level will stay at +00, but the Attack Level will change to +99 and the Break Level will change to –99.

EG Time —

Pitch EG (Prog 2–8c)

Filter EG (Prog 3–5c)

Amp EG (Prog 4–3d)

EG times can be controlled by the Common LFO, keyboard tracking, controllers, or tempo etc.

You can specify an **Intensity** value for each EG segment (**Attack**, **Decay**, **Slope**, **Release**). EG times are determined by the Alternate Modulation value when the preceding point is reached. For example, the Alternate Modulation value at the moment the envelope reaches the attack level will determine the decay time.

If **Intensity** is set to a value of 8, 17, 25, 33, 41, or 49, the corresponding time can be multiplied by a maximum of 2, 4, 8, 16, 32, or 64 times (or divided by 1/2, 1/4, 1/8, 1/16, 1/32, 1/64).

- Select JS +Y:CC#01 for **AMS**, and set **AMS Intensity** to +8, **At** to +, **Dc** to –, and **Sl** and **Rl** to 0. When you move the joystick in the +Y direction, the Attack Time will be lengthened by a maximum of 2 times. The Decay Time will be shortened by a maximum of 1/2. The Slope and Release times will not change.

LFO Frequency (Prog 5–1a)

The frequency of LFO 1, 2 or Common LFO can be controlled by the EG, keyboard tracking, controllers, or tempo etc.

You can also use the LFO2 frequency to modulate LFO1, or use the Common LFO frequency to modulate LFO 1/2.

If **Intensity** is set to a value of 16, 33, 49, 66, 82, or 99, the corresponding frequency can be multiplied by a maximum of 2, 4, 8, 16, 32, or 64 times (or divided by 1/2, 1/4, 1/8, 1/16, 1/32, 1/64).

- Select JS +Y:CC#01 for **AMS**, and set **Intensity** to +16. When you move the joystick in the +Y direction, the LFO frequency will be increased by a maximum of 2 times. If you set **Intensity** to -16 and move the joystick in the +Y direction, the LFO frequency will be decreased by up to 1/2.

LFO Frequency AMS Intensity (Prog 5–1b)

You can use the EG, keyboard tracking, controllers, or tempo etc. to control the intensity of the AMS that controls the frequency of the LFO 1, 2, or Common LFO.

For example if you're using the pitch EG to modulate the LFO frequency, you could use a separate AMS to control the depth of this effect.

- Set **AMS** to a controller such as SW 1 or 2, so that the pitch EG will lightly control the LFO frequency when the switch is off, and more deeply when the switch is on.

LFO Shape (Prog 5–1a)

You can use a EG, keyboard tracking, controllers, or tempo etc. to control the shape of the LFO 1, 2, or Common LFO waveform. You can also use the LFO2 frequency to modulate LFO1, or use the Common LFO frequency to modulate LFO 1/2.

- You can control the LFO waveform by setting **AMS** to a controller such as JS+Y, and operating the controller when desired.

Common LFO Reset (Prog 5–10a)

You can use a controller or tempo etc. to reset the Common LFO.

- By setting **AMS** to Gate 1, you can make the Common LFO reset when a note is played from a state in which all notes are off. For example, this will ensure that a filter sweep always starts from the same place.
- You can set **AMS** to a controller such as JS+Y: CC#01, and operate the controller when you want to reset the LFO.

Dynamic Modulation Sources (Dmod)

You can control certain effect parameters using the joystick, Realtime Controls knobs, SW1/SW2, etc. “on the fly.”

These parameters can also be controlled by the sequencer.

Controlling effects in this way is referred to as Dynamic Modulation. For example, you can use After Touch to speed up the LFO of the chorus and flanger, or you can use the joystick to sweep a wah effect. This lets you take full advantage of the effects as part of the expressive potential of your instrument.

Most of the parameters for dynamic modulation consist of parameter values for **Source** and **Amount**. The **Source** field selects the modulation source, and **Amount** sets the modulation intensity. When the **Source** is at its maximum value (for instance, when JS+Y is moved all the way up), the actual degree of the effect will be the parameter value plus the **Amount**.

Example: Wet/Dry 10:90, Source JS+Y:#01, Amount +50

In this case, the effect balance will normally be 10:90 and moving the joystick in the +Y direction will gradually increase the proportion of the effect sound. When the joystick is moved all the way in the +Y direction, the effect balance will be 60:40.

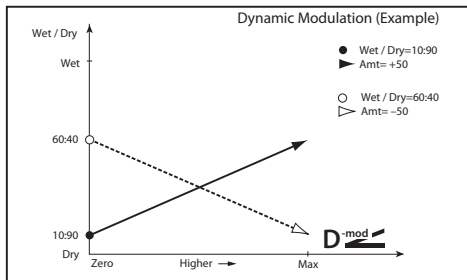

See the individual effects descriptions for explanations of other dynamic modulation parameters. Parameters which can be controlled through dynamic modulation are marked by the **D^{mod}** symbol.

Dmod and MIDI



In Program mode, dynamic modulation is always controlled via the global MIDI Channel.

In Combination and Sequencer modes, dynamic modulation is controlled via the MIDI channel independently specified by the **Ch** for IFX1–5, MFX1, 2, and TFX.

Dynamic Modulation Source List

| | |
|---------------|--|
| Off | dynamic modulation is not used |
| Gate1 | note on/off (p.347) |
| Gate1+Dmpr | note on + damper on/off (p.347) |
| Gate2 | note on/off (retrigger) (p.347) |
| Gate2+Dmpr | note on + damper on/off (retrigger) (p.347) |
| Note Numbr | note number |
| Velocity | velocity |
| Exp Velocity | exponential velocity (p.347) |
| After Touch | aftertouch (Channel After Touch) reception |
| JS X | joystick X (horizontal) direction |
| JS+Y: #01 | joystick +Y (Vertical upward) direction (CC#01) |
| JS-Y: #02 | joystick -Y (Vertical downward) direction (CC#02) |
| Pedal: #04 | assignable foot pedal (CC#04) (p.347) |
| FXCtrl1: #12 | MIDI effect control 1 (CC#12) |
| FXCtrl2: #13 | MIDI effect control 2 (CC#13) |
| Ribbon: #16 | MIDI Control Change (CC#16) |
| ValSlidr: #18 | MIDI Control Change (CC#18) (p.347) |
| KnobM1: #17 | Realtime Controls USER knob (knob modulation 1 CC#17) (p.347) |
| KnobM2: #19 | Realtime Controls USER knob (knob modulation 2 CC#19) (p.347) |
| KnobM3: #20 | Realtime Controls USER knob (knob modulation 3 CC#20) (p.347) |
| KnobM4: #21 | Realtime Controls USER knob (knob modulation 4 CC#21) (p.347) |
| KnobM1 [+] | Realtime Controls USER knob 1 [+] (p.347) |
| KnobM2 [+] | Realtime Controls USER knob 2 [+] (p.347) |
| KnobM3 [+] | Realtime Controls USER knob 3 [+] (p.347) |
| KnobM4 [+] | Realtime Controls USER knob 4 [+] (p.347) |
| Damper: #64 | damper pedal (CC#64) |
| PrtaSW: #65 | portamento switch (CC#65) |
| Sostenu: #66 | sostenuto pedal (CC#66) |
| Soft: #67 | soft pedal (CC#67) |
| SW 1: #80 | assignable panel switch 1 (SW1 modulation CC#80) (p.348) |
| SW 2: #81 | assignable panel switch 2 (SW2 modulation CC#81) (p.348) |
| FootSW: #82 | assignable foot switch (CC#82) (p.349) |
| MIDI: CC#83 | MIDI Control Change (CC#83) |
| MIDI: CC#85 | MIDI Control Change (CC#85) |
| MIDI: CC#86 | MIDI Control Change (CC#86) |
| MIDI: CC#87 | MIDI Control Change (CC#87) |
| MIDI: CC#88 | MIDI Control Change (CC#88) |
| Tempo | tempo (internal clock or external MIDI clock tempo data) (p.347) |

Gate1, Gate1+Dmpr (Gate1, Gate1+Damper)

The effect is at maximum during note-on, and will stop when all keys are released. With Gate1 + Damper, the effect will remain at maximum even after the keys are released, as long as the damper (sustain) pedal is pressed.

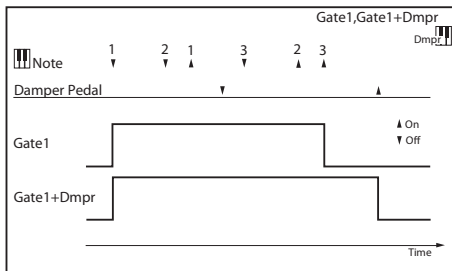

Gate2, Gate2+Dmpr (Gate2, Gate2+Damper)

This is essentially the same as for Gate 1 or Gate 1 + Dmpr. However when Gate 2 or Gate 2 + Damper are used as a dynamic modulation source for the EG of 041: St. Env. Flanger etc. or the AUTOFADE of 049: Stereo Vibrato, a trigger will occur at each note-on. (In the case of Gate 1 and Gate 1 + Dmpr, the trigger occurs only for the first note-on.)

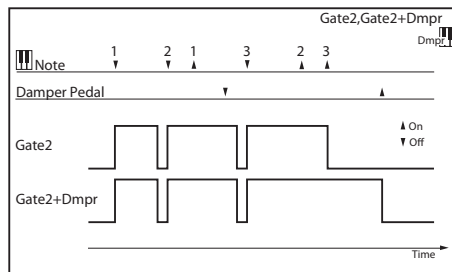

Exp Velocity (Exponential Velocity)

Modulation will be applied exponentially according to the velocity value. Weak velocity values will produce little effect, but the effect will increase rapidly as the velocity values rise.

Pedal: #04 (Foot Pedal: CC#04)

If you wish to use the assignable foot pedal as a dynamic modulation source, set **Foot Pedal Assign** (Global P2: Controller 2-1a) to Foot Pedal (CC#04). (See "Foot Pedal Assignments" on page 350.)

A foot controller etc. connected to the ASSIGNABLE PEDAL jack can be used to control an effect.

KnobM1:#17 (Knob Modulation1: CC#17)

KnobM2:#19 (Knob Modulation2: CC#19)

KnobM3:#20 (Knob Modulation3: CC#20)

KnobM4:#21 (Knob Modulation4: CC#21)

If you want to use knobs 1-4 as a dynamic modulation source when the Realtime Controls is USER, use the Controllers Setup page **Realtime Controls Knob Assign** parameter to assign **Knob USER 1** to Knob Mod.1 (CC#17), **Knob USER 2** to Knob Mod.2 (CC#19), **Knob USER 3** to Knob Mod.3 (CC#20), and **Knob USER 4** to Knob Mod.4 (CC#21) for each program, combination, or song. (See "Realtime Controls Knobs 1-4 Assignments" on page 348.)

Then put the Realtime Controls in USER, and you can use knobs 1-4 to control the effects.

If the knob is set to the 12 o'clock position, the resulting effect as a dynamic modulation source will be zero. If the **Amount** is a positive (+) value, rotating the knob toward the right will apply positive change, and rotating it toward the left it will produce negative change. (With negative values, the result will be the opposite.)

KnobM1 [+](Knob Modulation1 [+])

KnobM2 [+](Knob Modulation2 [+])

KnobM3 [+](Knob Modulation3 [+])

KnobM4 [+](Knob Modulation4 [+])

The knob position and the direction of the resulting change are different than Knob Mod.1 (CC#17)–Knob Mod.4 (CC#21). If **Amount** is set to a positive (+) value, rotating the knob to the far left all the way will produce an effect of 0 as the dynamic modulation source all the way will apply change only in the positive direction. (If the **Amount** is set to a negative value, the result will be the opposite.)

SW 1: #80 (Switch Modulation 1: CC#80)

SW 2: #81 (Switch Modulation 2: CC#81)

If you wish to use the SW1 or SW2 switch as a dynamic modulation source, make settings in Program, or Song to set the Controllers Setup page parameter **Panel Switch Assign** to the following values respectively: **SW1** to SW1 Mod. (CC#80), or **SW2** to SW2 Mod. (CC#81) (See "SW1/2 Assignments" on page 348.).

The effect will be controlled when you operate the SW1 or SW2 switch.

FootSW: #82 (Foot Switch: CC#82)

If you wish to use an assignable foot switch as a dynamic modulation source, set **Foot Switch Assign** (Global 2-1a) to Foot Switch (CC#82) (See "Foot Switch Assignments" on page 349.).

The effect will be controlled when you operate a foot switch etc. connected to the ASSIGNABLE SWITCH jack.

Tempo

The resulting modulation will be zero at 120 BPM, the maximum positive value at 240 BPM, and the maximum negative value at 60 BPM.

Controller Assignments

SW1/2 Assignments

Switch assignments are saved separately with each Program, Combination, and Song.

For more information, see:

- Programs: “1–3: Controllers Setup” on page 16
- Combinations: “1–1: Controllers Setup” on page 78
- Sequencer mode: “1–1: Setup” on page 122

List of SW 1/2 assignments

The following functions can be assigned to SW1 and SW2.

Off

This setting disables the switch.

SW1 Mod. (CC#80) (SW1 Modulation: CC#80)

SW2 Mod. (CC#81) (SW2 Modulation: CC#81)

This lets you use the switch as an AMS or Dmod source. Note that you’ll also need to assign SW1 Mod or SW2 Mod to control the desired parameter within the Program or Effect.

Each time the switch is turned on or off, it transmits the corresponding MIDI CC (80 or 81); Off is 0, and On is 127.

Porta.SW (CC#65) (Portamento SW: CC#65)

This turns Portamento on and off. When the LED is lit, Portamento is on.

Each time the switch is turned on or off, it transmits MIDI CC#65; Off is 0, and On is 127.

With single Programs, this simply enables and disables Portamento, regardless of the of the Program’s stored **Portamento Enable** setting.

With double Programs, it’s slightly more complex. If Portamento is either enabled for both OSC 1 and 2, or off for both, then the Portamento Switch controls both OSC.

If Portamento is enabled for only one of the two, only that element will be affected by the switch; for the other element, Portamento will always be off.

Octave Down

When the switch is on (LED lit), the pitch will be transposed down by one octave.

Octave Up

When the switch is on (LED lit), the pitch will be transposed up by one octave.

Lock functions

The Lock functions let you use SW1 or SW2 to “lock” the current position of the joystick. This leaves your hands free to play on the keyboard, or to use other controllers.

For instance, let’s say that JS+Y is assigned to create a filter sweep, and that SW2 is assigned to JS+Y Lock. You can then:

1. Move the joystick to open up the filter.
2. Press SW2 to turn on JS+Y Lock.
3. Release the joystick.

Since SW2 is locking JS+Y, the filter remains open, even though the joystick has physically snapped back to its center position.

Note that Lock affects only the physical controls. Even if Lock is On, incoming MIDI messages can still change the joystick.

For more information, please see “Locking the Joystick” on page 25 of the Operation guide.

JS X Lock

Locks the effect of the joystick X axis.

JS Y Lock

Locks the effect of the joystick Y axis (both + and – directions).

JS+Y Lock

Locks the effect of the joystick +Y direction.

JS–Y Lock

Locks the effect of the joystick –Y direction.

Realtime Controls Knobs 1–4 Assignments

The following functions can be assigned as the function of knobs 1–4 when the Realtime Controls is assigned to USER.

Knob assignments are saved separately with each Program, Combination, and Song.

For more information, see:

- Programs: “1–3: Controllers Setup” on page 16
- Combinations: “1–1: Controllers Setup” on page 78
- Sequencer mode: “1–1: Setup” on page 122

List of Knobs 1–4 assignments

The following functions can be assigned to Realtime Controls knobs 1–4.

Off

This setting disables the knob.

Knob Mod. 1–4 (CC#s17, 19, 20, 21)

These settings let you use the knob as an AMS or Dmod source. Note that you’ll also need to assign the knob to control the desired parameter within the Program or Effect.

Master Volume

This controls the overall volume, and transmits the Universal System Exclusive Master Volume message [F0H, 7FH, nn, 04, 01, vv, mm, F7H]. You can use this to adjust the volumes of all Tracks or Timbres at the same time, while preserving their relative balance.

Portamento Time (CC#05)

This controls the portamento time. Note that a different controller, CC#65, turns Portamento on and off; see “Porta.SW (CC#65) (Portamento SW: CC#65)” on page 348.

Volume (CC#07)

Controls the volume, and transmits CC#7.

Post IFX Pan (CC#08)

Controls the panning after the last Insert Effect in the chain, and transmits CC#8.

Pan (CC#10)

Controls stereo pan, and transmits CC#10.

Expression (CC#11)

Expression is a secondary volume control, which you can use to scale level without affecting the main volume settings or CC#7 values.

When used one at a time, MIDI Volume and Expression affect level in exactly the same way: a MIDI value of 127 is equal to Program’s main Level setting, and lower values

reduce the volume.

If both CC#7 and CC#11 are used simultaneously, the one with the lower value determines the maximum volume, and the one with the higher value scales down from that maximum.

FX Control 1 & 2 (CC#s12 & 13)

These assignments are intended for Effect Dynamic Modulation (Dmod). Note that you'll also need to assign **FX Control 1** or **2** to control the desired parameter within the Effect.

Cutoff (CC#74)

This scales the cutoff frequency of all of the filters at once. For instance, it affects both Filters A and B.

Resonance (CC#71)

This scales the resonance of all of the filters at once. For instance, it affects both Filters A and B.

Filter EG Int. (CC#79)

This scales the effect of the Filter EG on the cutoff frequency. It affects all of the filters at once; for instance, it affects both Filters A and B.

F/A Attack (CC#73)

This scales the attack times of the Filter and Amp EGs, along with other related parameters.

When the CC value is above 64, this also affects the Amp EG's Start and Attack Levels, Start Level AMS, and Attack Time AMS, as described below:

Between values of 65 and 80, the Start Level, Start Level AMS, and Attack Time AMS will change from their programmed values to 0. Over the same range, the Attack Level will change from its programmed value to 99.

F/A Decay (CC#75)

This scales the decay and slope times of the Filter and Amp EGs.

F/A Sustain (CC#70)

This scales the sustain levels of the Filter and Amp EGs.

F/A Release (CC#72)

This scales the release times of the Filter and Amp EGs.

Pitch LFO1 Spd (CC#76)

This scales LFO1's frequency.

Pitch LFO1 Dep (CC#77)

This scales the effect of LFO1 on the Pitch.

Pitch LFO1 Dly (CC#78)

This scales LFO1's fade-in time.

SW 1 Mod. & SW 2 Mod (CC#s 80 & 81)

Normally, these are used for the two assignable switches - but you can assign them to the knobs instead, if you like.

Foot Switch (CC#82)

You can use this general-purpose controller as an AMS or Dmod source. Note that you'll also need to assign **FootSW (CC#82)** to control the desired parameter within the Program or Effect.

MIDI CC#83 (CC#83)

You can use this general-purpose controller as an AMS or Dmod source. Note that you'll also need to assign **MIDI CC#83** to control the desired parameter within the Program or Effect.

MFx Send 1 & 2 (CC#s 93 & 91)

These control the send levels to Master Effects 1 and 2, respectively.

CC#s 93 and 91 actually control send levels in two different places: the sends directly from the Program OSC and the send levels of the last Insert Effect in the chain which matches the CC's MIDI channel.

MIDI CC#00-95 and 102-119

These settings let you transmit any MIDI CC, except for registered and non-registered parameters (CCs 96-101). If you choose a CC which is used by AMS, Dmod, or the standard CC routings, then it will affect the corresponding KROME parameters.



When the Realtime Controls in TONE, the function of knobs 1-4 is fixed.

Knobs 1-4

Realtime Controls knob 1-4 have preset assignments, as below:

TONE [1]: CUTOFF (Filter Cutoff: CC#74)

This scales the cutoff frequency of all of the filters at once.

TONE [2]: RESONANCE (Filter Resonance: CC#71)

This scales the resonance of all of the filters at once.

TONE [3]: EG INTENSITY (Filter EG Intensity: CC#79)

This scales the effect of the Filter EG on the cutoff frequency.

TONE [4]: EG RELEASE (Filter, Amplifier EG Release: CC#72)

This scales the release times of the Filter and Amp EGs.

Foot Switch Assignments

You can connect a footswitch (such as the optional Korg PS-1 or PS-3) to the rear-panel ASSIGNABLE SWITCH input, and then use it to control a wide variety of functions, as described below.

This setting is made globally, on the Global P2: Controllers-Foot Controllers page.

Foot Switch and MIDI CCs

Some of the assignments include MIDI CCs, which are transmitted each time the switch is turned on or off (Off = 0, and On = 127). Note that the MIDI CCs can still be received even if they are not assigned to a physical controller.

USER [1] - [4] and SW1/2 are special cases, since these can themselves be assigned to different MIDI CCs. If the footswitch is assigned to duplicate these controls, it will also use their CC assignments.

List of Foot Switch assignments

Off

This setting disables the switch.

Foot Switch (CC#82)

This lets you use the switch as an AMS or Dmod source. Note that you'll also need to assign Foot SW (CC#82) to control the desired parameter within the Program or Effect.

Portamento SW (CC#65)

This controls portamento on/off. For more information, please see "Porta.SW (CC#65) (Portamento SW: CC#65)" on page 348.

Sostenuto (CC#66)

This controls the sostenuto effect, which holds only the notes being played at the moment that the footswitch is turned on.

Soft (CC#67)

Turns the soft pedal effect on and off.

Damper (CC#64)

Turns the damper pedal effect on and off.

Program Up

This lets you use the switch to increment the current Program or Combination number, for hands-free patch changes. Note that this is only active while on the Prog P0: Play or Combi P0: Play pages, respectively.

When you use this control, the KROME will also transmit the corresponding MIDI Program Change and Bank Select messages.

Program Down

This decrements the current Program or Combination number, for hands-free patch changes. For more information, please see "Program Up" above.

Value Inc

Operating the foot switch will produce the same operation as pressing the INC button. For more information, please see "2-1: Menu Command" on page 202.

Value Dec

Operating the foot switch will produce the same operation as pressing the DEC button.

Song Start/Stop

The foot switch will control sequencer start/stop. Simultaneously, a MIDI Start or Stop message will be transmitted.

Song Punch In/Out

If Seq P0: Preference "Recording Setup" (0-8b) is set to Manual Punch In, the switch can be used to punch-in and punch-out when recording on the sequencer.

Cue Repeat Control

This is valid if the Repeat setting for each step in Seq P11: Cue List is set to FS (11-1b). If you press the pedal switch while a step is repeating, this will be the trigger to proceed to the next step.

Tap Tempo

This duplicates the function of the front-panel TAP button, for setting the system tempo in real-time.

ARP ON/OFF

The foot switch will turn the arpeggiator on/off.

DRUM TRACK ON/OFF

The foot switch will turn the Drum Track on/off.

JS+Y (CC#01)

The switch will control the effect produced by joystick movement in the +Y direction (Vertical upward).

JS-Y (CC#02)

The switch will control the effect produced by joystick movement in the -Y direction (Vertical downward).

Value Slider (CC#18)

You can use this general-purpose controller as an AMS or Dmod source. Note that you'll also need to assign ValueSlider (CC#18) to control the desired parameter within the Program or Effect.

TONE [1]...TONE [4]

USER [1]...USER [4]

Use the switch to control the effect of knobs 1-4 when the Realtime Controls is in USER/TONE.

(Foot switch "on" is equivalent to turning the knob to the far right; foot switch "off" is equivalent to turning the knob to the far left.)

SW1, 2

The footswitch duplicates the function of the selected front-panel switch.

ARP GATE

Use the switch to control the arpeggiator's Gate.

(Foot switch "on" is equivalent to turning the knob to the far right; foot switch "off" is equivalent to turning the knob to the far left.)

ARP VELOCITY

Use the switch to control the arpeggiator's Velocity.

(Foot switch "on" is equivalent to turning the knob to the far right; foot switch "off" is equivalent to turning the knob to the far left.)

ARP LENGTH

Use the switch to control the arpeggiator's Length.

(Foot switch "on" is equivalent to turning the knob to the far right; foot switch "off" is equivalent to turning the knob to the far left.)

ARP STEP

Use the switch to control the arpeggiator's Step.

(Foot switch "on" is equivalent to turning the knob to the far right; foot switch "off" is equivalent to turning the knob to the far left.)

Foot Pedal Assignments

You can connect a pedal (such as the optional Korg XVP-10 or EXP-2) to the rear-panel ASSIGNABLE PEDAL input, and then use it to control a wide variety of functions, as described below.

This setting is made for the entire KROME, on the Global P2: Controllers- Foot Controllers page.

A note on MIDI CCs

Some of the assignments include MIDI CCs, which are transmitted whenever the knob is moved. Note that the MIDI CCs can still be received even if they are not assigned to a physical controller.

If you select USER [1] -USER [4], the MIDI control change message specified by the Realtime Controls Knob Assign settings in each mode will be transmitted.

List of Foot Pedal assignments

Off

This setting disables the pedal.

Master Volume

This controls the overall volume, and transmits the Universal System Exclusive Master Volume message [F0H, 7FH, nn, 04, 01, vv, mm, F7H]. You can use this to adjust the volumes of all Tracks or Timbres at the same time, while preserving their relative balance.

Foot Pedal (CC#04)

You can use this general-purpose controller as an AMS or Dmod source. Note that you'll also need to assign Foot Pedal (CC#04) to control the desired parameter within the Program or Effect.

Portamento Time (CC#05)

Controls the speed at which portamento will change the pitch.

Volume (CC#07)

Control the volume of a Program, Combination, or of a MIDI track in Sequencer modes.

Post IFX Pan (CC#08)

Control the pan after passing through the Insert Effect.

Pan (CC#10)

Control the pan of a Program, of a timbre in a Combination, or of a MIDI track in Sequencer modes.

Expression (CC#11)

Expression is a secondary volume control, which you can use to scale level without affecting the main volume settings or CC#7 values. For more information, please see “Expression (CC#11)” on page 348.

FX Control 1 & 2 (CC#s12 & 13)

These assignments are intended for Effect Dynamic Modulation (Dmod). Note that you’ll also need to assign **FX Ctrl1** or **2** to control the desired parameter within the Effect.

MFx Send 1 & 2 (CC#s 93 & 91)

These control the send levels to Master Effects 1 and 2, respectively.

CC#s 93 and 91 actually control send levels in two different places: the sends directly from the Program OSC and the send levels of the last Insert Effect in the chain which matches the CC’s MIDI channel.

JS+Y (CC#01)

This duplicates the function of JS+Y. Whatever JS+Y is assigned to control, the pedal will control as well.

JS-Y (CC#02)

This duplicates the function of JS-Y. Whatever JS-Y is assigned to control, the pedal will control as well.

Ribbon (CC#16)

You can use this general-purpose controller as an AMS or Dmod source. Note that you’ll also need to assign **Ribbon (CC#16)** to control the desired parameter within the Program or Effect.

Value Slider (CC#18)

You can use this general-purpose controller as an AMS or Dmod source. Note that you’ll also need to assign ValueSlider (CC#18) to control the desired parameter within the Program or Effect.

TONE [1]...TONE [4]**USER [1]...USER [4]**

Use the pedal to control the effect of knobs 1-4 when the Realtime Controls is in USER/TONE.

ARP GATE

Use the pedal to control the arpeggiator’s **Gate**.

ARP VELOCITY

Use the pedal to control the arpeggiator’s **Velocity**.

ARP SWING

Use the pedal to control the arpeggiator’s **Swing**.

ARP STEP

Use the pedal to control the arpeggiator’s **Step**.

System exclusive messages affected by Create Excl Data, Erase Excl Data, and Event Edit

| Create/Erase | | Event Edit | | |
|--------------------------|----------------------|-----------------------|-------------------|---------------|
| | | *Dump/Ext* | | |
| | | *Unavailable* | | |
| Univ: Mater Volume | | MaterVolume | | |
| Univ: Master Balance | | MasterBalance | | |
| Univ: Master Fine Tune | | MasterFineTune | | |
| Univ: Master Coarse Tune | | MasterCoarseTune | | |
| Song Setup | Song Common | Controls [SELECT] | Controls [SELECT] | |
| | | Tone Adjust Track | Tone Adjust Track | |
| | | Tone Adjust Auto Load | TA AutoLoad | |
| | | Scale Type | Scale Type | |
| | | Scale Key | Scale Key | |
| | | Scale Random | Scale Random | |
| | | [SW1] | [SW1] | |
| | | SW1:Assign | SW1:Assign | |
| | | SW1:Mode | SW1:Mode | |
| | | [SW2] | [SW2] | |
| | | SW2:Assign | SW2:Assign | |
| | | SW2:Mode | SW2:Mode | |
| | | USER CONTROL1: Assign | USER1:Assign | |
| | | USER CONTROL2: Assign | USER2:Assign | |
| | | USER CONTROL3: Assign | USER3:Assign | |
| | | USER CONTROL4: Assign | USER4:Assign | |
| | | [ON/OFF] | DT:[ON/OFF] | |
| | | Pattern Bank | DT:Pattern Bank | |
| | | Pattern Number | DT:PatternNumber | |
| | | Shift | DT:Shift | |
| | Input MIDI Channel | DT:In MIDI Ch | | |
| | Output MIDI Channel | DT:Out MIDI Ch | | |
| | Trigger Mode | DT:Trigger Mode | | |
| | Trigger Sync | DT:Trigger Sync | | |
| | Trigger Latch | DT:Trigger Latch | | |
| | Keyboard Zone Bottom | DT:KeyZone Btm | | |
| | Keyboard Zone Top | DT:KeyZone Top | | |
| | Velocity Zone Bottom | DT:VelZone Btm | | |
| | Velocity Zone Top | DT:VelZone Top | | |
| | Track 01 | Play/Mute/Solo | Play/Mute | T01:Play/Mute |
| | | Solo | | T01:Solo |
| | Parameter | Program | | T01:Program |
| | | Pan | | T01:Pan |
| Volume | | | T01:Volume | |
| EX2 Bank Select(MSB) | | | T01:EX2Bank MSB | |
| EX2 Bank Select(LSB) | | | T01:EX2Bank LSB | |
| Force OSC Mode | | | T01:OSC Mode | |
| OSC Select | | | T01:OSC Select | |
| Arpeggiator Assign | | | T01:Portamento | |
| Portamento | | | T01:Portamento | |
| Transpose | | | T01:Transpose | |
| Detune | | | T01:Detune | |
| Bend Range | | | T01:Bend Range | |
| Use Program's Scale | | | T01:Prog's Scale | |
| Delay Time [ms] | | | T01:DelayTime:ms | |
| Delay MIDI/Tempo Sync | | | T01:DelayMIDISync | |
| Delay Sync Base Note | | | T01:Delay Base | |
| Delay Sync Times | | | T01:Delay Times | |
| Auto Load Program EQ | | | T01:Auto Prog EQ | |
| EQ Bypass | | | T01:EQ Bypass | |
| EQ Input Trim | | | T01:EQ Input Trim | |
| EQ High Gain | | | T01:EQ High Gain | |
| EQ Mid Freq | | | T01:EQ Mid Freq | |
| EQ Mid Gain | | | T01:EQ Mid Gain | |

| Create/Erase | | Event Edit | | | |
|----------------|----------------------|------------------|-------------------|------------------|------------------|
| | | EQ Low Gain | T01:EQ Low Gain | | |
| | | Bus Select | T01:Bus Select | | |
| | | Send1(MFX1) | T01:Send1(MFX1) | | |
| | | Send2(MFX2) | T01:Send2(MFX2) | | |
| | | FX Control Bus | T01:FX Ctrl Bus | | |
| | | Tone Adjust | SW1:Assign | T01TA:SW1:Assign | |
| | | | SW2:Assign | T01TA:SW2:Assign | |
| | | | SW3:Assign | T01TA:SW3:Assign | |
| | SW4:Assign | | T01TA:SW4:Assign | | |
| | SW5:Assign | | T01TA:SW5:Assign | | |
| | SW6:Assign | | T01TA:SW6:Assign | | |
| | SW7:Assign | | T01TA:SW7:Assign | | |
| | SW8:Assign | | T01TA:SW8:Assign | | |
| | SW1:On/Off | | T01TA:SW1:on/off | | |
| | SW2:On/Off | | T01TA:SW2:on/off | | |
| | SW3:On/Off | | T01TA:SW3:on/off | | |
| | SW4:On/Off | | T01TA:SW4:on/off | | |
| | SW5:On/Off | | T01TA:SW5:on/off | | |
| | SW6:On/Off | | T01TA:SW6:on/off | | |
| | SW7:On/Off | | T01TA:SW7:on/off | | |
| | SW8:On/Off | | T01TA:SW8:on/off | | |
| | SW1:(On)Value | | T01TA:SW1:Value | | |
| | SW2:(On)Value | | T01TA:SW2:Value | | |
| | SW3:(On)Value | | T01TA:SW3:Value | | |
| | SW4:(On)Value | | T01TA:SW4:Value | | |
| | SW5:(On)Value | | T01TA:SW5:Value | | |
| | SW6:(On)Value | | T01TA:SW6:Value | | |
| | SW7:(On)Value | | T01TA:SW7:Value | | |
| | SW8:(On)Value | | T01TA:SW8:Value | | |
| | Slider1:Assign | | T01TA:SL1:Assign | | |
| | Slider2:Assign | | T01TA:SL2:Assign | | |
| | Slider3:Assign | | T01TA:SL3:Assign | | |
| | Slider4:Assign | | T01TA:SL4:Assign | | |
| Slider5:Assign | T01TA:SL5:Assign | | | | |
| Slider6:Assign | T01TA:SL6:Assign | | | | |
| Slider7:Assign | T01TA:SL7:Assign | | | | |
| Slider8:Assign | T01TA:SL8:Assign | | | | |
| Slider1:Value | T01TA:SL1:Value | | | | |
| Slider2:Value | T01TA:SL2:Value | | | | |
| Slider3:Value | T01TA:SL3:Value | | | | |
| Slider4:Value | T01TA:SL4:Value | | | | |
| Slider5:Value | T01TA:SL5:Value | | | | |
| Slider6:Value | T01TA:SL6:Value | | | | |
| Slider7:Value | T01TA:SL7:Value | | | | |
| Slider8:Value | T01TA:SL8:Value | | | | |
| Track 02...16 | Play/Mute/Solo | Play/Mute | T02:Play/Mute | | |
| Arpeggiator | Arpeggio | [ON/OFF] | KAR:[ON/OFF] | | |
| | | Run A | KAR:[LATCH] | | |
| | | Run B | KAR:[MOD.CTRL] | | |
| | | [GATE] | KAR:[M] SCENE | | |
| | | [VELOCITY] | KAR:SceneQuantze | | |
| | | [SWING] | KAR:LinkStartSeed | | |
| | | [STEP] | KAR:Load GE Opt | | |
| | | Arpeggiator-A, B | Pattern | | KAR:UserRTCModel |
| | | | Resolution | | KAR:Reset Scenes |
| | | | Octave | | KAR:DT Run 1 |
| | Gate | | | KAR:DT Run 2 | |
| | | Velocity | | KAR:DT Run 3 | |
| | | Sort | | KAR:DT Run 4 | |
| | | Latch | | KAR:DT Run 1 | |
| | Key Sync. | | KAR:DT Run 2 | | |
| | Keyboard | | KAR:DT Run 3 | | |
| | Keyboard Zone Bottom | | KAR:DT Run 4 | | |
| | Keyboard Zone Top | | KAR:DT Run 1 | | |

System exclusive messages affected by Create Excl Data, Erase Excl Data, and Event Edit

| Create/Erased | | Event Edit | | |
|----------------|-------------------------------------|--------------------------------|--|--|
| | | Velocity Zone Bottom | KAR:DT Run 2 | |
| | | Velocity Zone Top | KAR:DT Run 3 | |
| Insert Effect | Setup | IFX1 SW | IFX1:SW | |
| | | IFX1 | IFX1 | |
| | | IFX1 Control Channel | IFX1:Control Ch. | |
| | | IFX1 Chain To | IFX1:Chain To | |
| | | IFX1 Chain | IFX1:Chain | |
| | | IFX1 Pan | IFX1:Pan | |
| | | IFX1 Bus Select | IFX1:Bus Select | |
| | | IFX1 Control Bus | IFX1:Control Bus | |
| | | IFX1 Send1 | IFX1:Send1 | |
| | | IFX1 Send2 | IFX1:Send2 | |
| | | IFX2 SW | IFX2:SW | |
| | | : | : | |
| | IFX5 | IFX5:Send2 | | |
| | IFX1:No Effect | Parameter0 : Parameter71 | IFX1:Parameter0 : IFX1:Parameter71 | |
| | IFX2:No Effect... IFX5:No Effect | Parameter0 : Parameter71 | IFX2:Parameter0 : IFX5:Parameter71 | |
| | Common FX LFO1 | Frequency[Hz] | FX LFO1:Freq[Hz] | |
| | | Sync(Reset) | FX LFO1:Sync | |
| | | Sync Source | FX LFO1:Sync Src | |
| | | Sync Control Channel | FX LFO1:Sync Ctrl | |
| | | MIDI/Tempo Sync | FX LFO1:MIDI Sync | |
| | | MIDI Sync BPM | FX LFO1:BPM | |
| | | MIDI Sync BaseNote | FX LFO1:Base Note | |
| | | MIDI Sync Times | FX LFO1:Times | |
| Common FX LFO2 | Frequency[Hz] | FX LFO1:Freq[Hz] | | |
| | : | : | | |
| | MIDI Sync Times | FX LFO2:Times | | |
| Master Effect | Setup | MFX1 SW | MFX1:SW | |
| | | MFX1 | MFX1 | |
| | | MFX1 Control Channel | MFX1:Control Ch. | |
| | | MFX1 Return | MFX1:Return | |
| | | MFX2 SW | MFX2:SW | |
| | | MFX2 | MFX2 | |
| | | MFX2 Control Channel | MFX2:Control Ch. | |
| | | MFX2 Return | MFX2:Return | |
| | | MFX Chain | MFX Chain | |
| | | Chain Direction | MFX Chain Direct. | |
| | | Chain Level | MFX Chain Level | |
| | | MFX1:No Effect | Parameter0 : Parameter71 | MFX1:Parameter0 : MFX1:Parameter71 |
| | MFX2:No Effect | Parameter0 : Parameter71 | MFX2:Parameter0 : MFX2:Parameter71 | |
| | Total Effect | Setup | TFX SW | TFX SW |
| | | | TFX | TFX |
| | | | TFX Control Channel | TFX:Control Ch. |
| | | | Master Volume | TFX Master Vol. |
| | | TFX:No Effect | Parameter0 : Parameter71 | TFX:Parameter0 : TFX:Parameter71 |

MIDI transmission when the KROME's controllers are operated

The following tables show the relation between the MIDI messages that are transmitted when the KROME's controllers are operated, and the AMS (alternate modulation source) or DMS (dynamic modulation source) that

correspond to each MIDI message.

indicates a fixed function, and * indicates an assignable function.

MIDI Messages and physical controllers

| MIDI messages | Joystick | Realtime Knob TONE1...4 | Realtime Knob USER1...4 | SW1, 2 | On/Off | ARP | | | | Damper | Foot Switch | Foot Pedal | Available for AMS | Available for Dmod |
|-------------------------------------|----------|-------------------------|-------------------------|--------|--------|--------------|------------------|---------------|--------------|--------|-------------|------------|-------------------|--------------------|
| | | | | | | Knob1 (GATE) | Knob2 (VELOCITY) | Knob3 (SWING) | Knob4 (STEP) | | | | | |
| Note-off | | | | | | | | | | | | | | |
| Note-on (note number) | | | | | | | | | | | | | * | * |
| Note-on (velocity) | | | | | | | | | | | | | * | * |
| Poly aftertouch | | | | | | | | | | | | | * | * |
| 0 Bank select (MSB) | | | * | | * | * | * | * | * | | | | | |
| 1 Modulation 1 | #(+Y) | | * | | * | * | * | * | * | | * | * | * | * |
| 2 Modulation 2 | #(-Y) | | * | | * | * | * | * | * | | * | * | * | * |
| 3 - | | | * | | * | * | * | * | * | | * | * | * | * |
| 4 Foot controller | | | * | | * | * | * | * | * | | * | * | * | * |
| 5 Portamento time | | | * | | * | * | * | * | * | | * | * | * | * |
| 6 Data entry (MSB) | | | * | | * | * | * | * | * | | * | * | * | * |
| 7 Volume | | | * | | * | * | * | * | * | | * | * | * | * |
| 8 Post Insert Effect panpot | | | * | | * | * | * | * | * | | * | * | * | * |
| 9 - | | | * | | * | * | * | * | * | | * | * | * | * |
| 10 Panpot | | | * | | * | * | * | * | * | | * | * | * | * |
| 11 Expression | | | * | | * | * | * | * | * | | * | * | * | * |
| 12 Effect control 1 | | | * | | * | * | * | * | * | | * | * | * | * |
| 13 Effect control 2 | | | * | | * | * | * | * | * | | * | * | * | * |
| 14 ARP On/Off control | | | * | | [*] | * | * | * | * | | *(1) | | | * |
| 15 - | | | * | | * | * | * | * | * | | | | | |
| 16 Controller (CC#16) | | | * | | * | * | * | * | * | | * | * | * | * |
| 17 Knob modulation 5 | | | * | | * | * | * | * | * | | * | * | * | * |
| 18 Controller (CC#18) | | | * | | * | * | * | * | * | | * | * | * | * |
| 19 Knob modulation 6 | | | * | | * | * | * | * | * | | * | * | * | * |
| 20 Knob modulation 7 | | | * | | * | * | * | * | * | | * | * | * | * |
| 21 Knob modulation 8 | | | * | | * | * | * | * | * | | * | * | * | * |
| 22 ARP-GATE control | | | * | | [*] | * | * | * | * | | *(1) | *(1) | | * |
| 23 ARP-VELOCITY control | | | * | | | [*] | * | * | * | | *(1) | *(1) | | * |
| 24 ARP-SWING control | | | * | | * | * | * | [*] | * | | *(1) | *(1) | | * |
| 25 ARP-STEP control | | | * | | * | * | * | * | [*] | | *(1) | *(1) | | * |
| 26 - | | | * | | * | * | * | * | * | | | | | |
| 27 - | | | * | | * | * | * | * | * | | | | | |
| 28 - | | | * | | * | * | * | * | * | | | | | |
| 29 - | | | * | | * | * | * | * | * | | | | | |
| 30 - | | | * | | * | * | * | * | * | | | | | |
| 31 - | | | * | | * | * | * | * | * | | | | | |
| 32 Bank select (LSB) | | | * | | * | * | * | * | * | | | | | |
| 33...37 - | | | * | | * | * | * | * | * | | | | | |
| 38 Data entry (LSB) | | | * | | * | * | * | * | * | | | | | |
| 39...63 - | | | * | | * | * | * | * | * | | | | | |
| 64 Damper | | | * | | * | * | * | * | * | # | * | * | * | * |
| 65 Portamento On/Off | | | * | * | * | * | * | * | * | | * | * | * | * |
| 66 Sostenuto | | | * | | * | * | * | * | * | | * | * | * | * |
| 67 Soft pedal | | | * | | * | * | * | * | * | | * | * | * | * |
| 68...69 - | | | * | | * | * | * | * | * | | | | | |
| 70 Sustain level | | | * | | * | * | * | * | * | | | | | |
| 71 Filter resonance level | | # (Knob2) | * | | * | * | * | * | * | | * | * | * | * |
| 72 Release time | | # (Knob4) | * | | * | * | * | * | * | | * | * | * | * |
| 73 Attack time | | * | * | | * | * | * | * | * | | * | * | * | * |
| 74 Filter cutoff frequency | | # (Knob1) | * | | * | * | * | * | * | | * | * | * | * |
| 75 Decay time | | * | * | | * | * | * | * | * | | * | * | * | * |
| 76 LFO1 speed | | * | * | | * | * | * | * | * | | * | * | * | * |
| 77 LFO1 depth (pitch) | | * | * | | * | * | * | * | * | | * | * | * | * |
| 78 LFO1 delay | | * | * | | * | * | * | * | * | | * | * | * | * |
| 79 Filter EG intensity | | # (Knob3) | * | | * | * | * | * | * | | * | * | * | * |
| 80 SW1 modulation On/Off | | * | * | *(SW1) | * | * | * | * | * | | * | * | * | * |
| 81 SW2 modulation On/Off | | * | * | *(SW2) | * | * | * | * | * | | * | * | * | * |
| 82 Foot switch On/Off | | * | * | * | * | * | * | * | * | | * | * | * | * |
| 83 Controller (CC#83) | | * | * | * | * | * | * | * | * | | * | * | * | * |
| 84 - | | * | * | * | * | * | * | * | * | | * | * | * | * |
| 85 Controller (CC#85) | | * | * | * | * | * | * | * | * | | * | * | * | * |
| 86 Controller (CC#86) | | * | * | * | * | * | * | * | * | | * | * | * | * |
| 87 Controller (CC#87) | | * | * | * | * | * | * | * | * | | * | * | * | * |
| 88 Controller (CC#88) | | * | * | * | * | * | * | * | * | | * | * | * | * |
| 89...90 - | | * | * | * | * | * | * | * | * | | * | * | * | * |
| 91 Effect depth 1 (send 2 level) | | * | * | * | * | * | * | * | * | | * | * | * | * |
| 92 Effect depth 2 (IFX 1-5 On/Off) | | * | * | * | * | * | * | * | * | | * | * | * | * |
| 93 Effect depth 3 (send 1 level) | | * | * | * | * | * | * | * | * | | * | * | * | * |
| 94 Effect depth 4 (MFX 1, 2 On/Off) | | * | * | * | * | * | * | * | * | | * | * | * | * |
| 95 Effect depth 5 (TFX 1, 2 On/Off) | | * | * | * | * | * | * | * | * | | * | * | * | * |
| 96 Data increment | | * | * | * | * | * | * | * | * | | * | * | * | * |
| 97 Data decrement | | * | * | * | * | * | * | * | * | | * | * | * | * |
| 98 NRPN(LSB) | | * | * | * | * | * | * | * | * | | * | * | * | * |
| 99 NRPN(MSB) | | * | * | * | * | * | * | * | * | | * | * | * | * |
| 100 RPN(LSB) | | * | * | * | * | * | * | * | * | | * | * | * | * |
| 0: Bend range | | * | * | * | * | * | * | * | * | | * | * | * | * |
| 1: Fine tune | | * | * | * | * | * | * | * | * | | * | * | * | * |
| 2: Coarse tune | | * | * | * | * | * | * | * | * | | * | * | * | * |
| 101 RPN(MSB) 0 | | * | * | * | * | * | * | * | * | | * | * | * | * |
| 102 - | | * | * | * | * | * | * | * | * | | * | * | * | * |
| 103 - | | * | * | * | * | * | * | * | * | | * | * | * | * |
| 104 - | | * | * | * | * | * | * | * | * | | * | * | * | * |
| 105 - | | * | * | * | * | * | * | * | * | | * | * | * | * |
| 106 - | | * | * | * | * | * | * | * | * | | * | * | * | * |
| 107 - | | * | * | * | * | * | * | * | * | | * | * | * | * |
| 108 - | | * | * | * | * | * | * | * | * | | * | * | * | * |
| 109 - | | * | * | * | * | * | * | * | * | | * | * | * | * |
| 114 - | | * | * | * | * | * | * | * | * | | * | * | * | * |
| 115 - | | * | * | * | * | * | * | * | * | | * | * | * | * |
| 116 - | | * | * | * | * | * | * | * | * | | * | * | * | * |
| 117 - | | * | * | * | * | * | * | * | * | | * | * | * | * |
| 118 - | | * | * | * | * | * | * | * | * | | * | * | * | * |
| 119 - | | * | * | * | * | * | * | * | * | | * | * | * | * |
| Program change | | | | | | | | | | | | | * | * |
| Channel aftertouch | | | | | | | | | | | | | * | * |
| Pitch Bend | +X, -X | | | | | | | | | | | | * | * |
| Universal exclusive | | | | | | | | | | | | | * | * |
| Master volume | | | * | | | | | | | | * | | | |
| Master balance | | | | | | | | | | | | * | | |
| Master fine tune | | | | | | | | | | | | | * | |
| Master coarse tune | | | | | | | | | | | | | * | |

(1):When an arpeggiator controller is assigned to a CC# indicated by [*] (Global P2: Controllers– MIDI CC# Assign)

*: Assignable

[*]:The ARP Controllers can be assigned to CC#00–119. CC#s indicated by [*] will be assigned automatically when you execute the Global P2– MIDI CC# Assign menu command **Reset Controller MIDI Assign** with the CC Default setting.

The CC Default settings are the CC#s recommended as the CC# for each of these controllers. Normally you should use these settings when assigning CC#s.

When one of the KROME's controllers is operated, the corresponding or the assigned control change will be transmitted.

If you choose USER [1] –USER [4], or SW1/2, its MIDI control change message will be transmitted according to the settings in Realtime Controls Knob Assign, SW1/2 Assign.

If you've selected ARP ON/OFF, ARP GATE, ARP VELOCITY, ARP SWING, ARP STEP, those MIDI control change messages will be transmitted according to the Global P2-MIDI CC# Assign settings.

The following sections describes operation in each mode.

Program mode

When one of the KROME's controllers is operated, a control change message will be transmitted on the global MIDI channel (**MIDI Channel** Global 1–1a).

 If the Realtime Controls is set to USER, and knobs 1–4 or the assignable pedal are assigned to Master Volume, the universal exclusive message Master Volume will be transmitted.

Combination mode

When one of the KROME's controllers is operated, a control change message will be transmitted on the global MIDI channel (**MIDI Channel** Global 1–1a).

Simultaneously, the message will also be transmitted on the MIDI channel (**MIDI Channel** Combi 3–1(2)c) of any timbre whose **Status** (Combi 3–1(2)c) is EXT or EX2.

When one of the KROME's controllers is operated, its effect will apply to any timbre whose **Status** is INT and whose **MIDI Channel** setting is either Gch or the same as the global MIDI channel.

 In the case of Master Volume, the universal exclusive message Master Volume will be transmitted only on the global MIDI channel.

 You can make settings for MIDI Filter (Combi P5) to enable or disable control changes and controllers for each timbre. When checked, the above operations will be enabled.

Effect dynamic modulation can be controlled when the **Ch** (Combi 8–4a, 9–2a) setting for IFX1–5, MFX1, 2, or TFX is either set to Gch or to the same channel as the global MIDI channel. (In the case of All Routed, control is possible on the MIDI channel of any routed timbre.)

Sequencer mode

When one of the KROME's controllers is operated, its effect will apply to the MIDI track 1–16 that is currently selected by **Track Select** (Seq 0–1(2)a).

If the **Status** (Seq 3–1(2)c) of the track selected by **Track Select** is EXT, EX2, or BTH, a control change message will be

transmitted on the MIDI channel specified by **MIDI Channel** (Seq 3–1(2)c).

If the **Status** is INT or BTH, operating one of the KROME's controllers will affect only that MIDI track. Simultaneously, the same effect will also apply to any MIDI track with the same **MIDI Channel** setting.

 In the case of Master Volume, the universal exclusive message Master Volume will be transmitted.

 You can make settings for MIDI Filter (Seq P3) to enable or disable control changes and controllers for each track. When checked, the operations effective for a **Status** of INT or BTH will be enabled. Tracks whose **Status** is EXT, EX2, or BTH will transmit control changes regardless of this setting.

Effect dynamic modulation can be controlled when the **Ch** (Seq 8–4a, 9–2a) setting for IFX1–5, MFX1, 2, or TFX matches the MIDI channel of the track selected by **Track Select**. (In the case of All Routed, control is possible on the MIDI channel of all routed tracks.)

If one of the KROME's controllers is operated during realtime recording, the corresponding or assigned control change will be recorded.

KROME and MIDI CCs

Responses to standard MIDI controllers

The following table shows how the KROME responds to MIDI control change messages, and the relation between settings and controller movements on the KROME.

| CC# | Control | Value | Function |
|---------|---------------------------|------------------------------|---|
| 0 | Bank select (MSB) | 0...127 | bank select message MSB *1 |
| 1 | Modulation 1 | 0...127 | corresponds to joystick movement in the +Y direction (Vertical upward) |
| 2 | Modulation 2 | 0...127 | corresponds to joystick movement in the -Y direction (Vertical downward) |
| 3 | - | - | - |
| 4 | Foot controller | 0...127 | corresponds to when the assignable pedal function is set to Foot Pedal |
| 5 | Portamento time | 0...127 | portamento time |
| 6 | Data entry (MSB) | 0...127 | MSB of RPN and NRPN data *2 |
| 7 | Volume | 0...127 | volume *3 |
| 8 | Post Insert Effect panpot | 0...127 | pan after the Insert Effect |
| 9 | - | - | - |
| 10 | Panpot | 0...127 | pan |
| 11 | Expression | 0...127 | volume *3 |
| 12 | Effect control 1 | 0...127 | corresponds to effect dynamic control source FX Control1 (p.363) |
| 13 | Effect control 2 | 0...127 | corresponds to effect dynamic control source FX Control2 (p.363) |
| 14 | ARP ON/OFF control | 0...63(Off), 64...127(On) | equivalent to on/off when CC#14 is assigned to the ARP buttons *7 |
| 15 | - | - | - |
| 16 | Controller (CC#16) | 0...127 | for controlling AMS or Dmod |
| 17 | Knob modulation 1 | 0...127 | corresponds to when the Realtime Controls knob function is set to Knob Mod.1 |
| 18 | Controller (CC#18) | 0...127 | for controlling AMS or Dmod *8 |
| 19 | Knob modulation 2 | 0...127 | corresponds to when the Realtime Controls knob function is set to Knob Mod.2 |
| 20 | Knob modulation 3 | 0...127 | corresponds to when the Realtime Controls knob function is set to Knob Mod.3 |
| 21 | Knob modulation 4 | 0...127 | corresponds to when the Realtime Controls knob function is set to Knob Mod.4 |
| 22 | ARP-GATE control | 0...127 | equivalent to when CC#22 is assigned to arpeggio control knob 1 (GATE) *7 |
| 23 | ARP-VELOCITY control | 0...127 | equivalent to when CC#23 is assigned to arpeggio control knob 2 (VELOCITY) *7 |
| 24 | ARP-SWING control | 0...127 | equivalent to when CC#24 is assigned to arpeggio control knob 3 (SWING) *7 |
| 25 | ARP-STEP control | 0...127 | equivalent to when CC#25 is assigned to arpeggio control knob 4 (STEP) *7 |
| 26...31 | - | - | - |
| 32 | Bank select (LSB) | 0...127 | LSB of bank select message *1 |
| 33...37 | - | - | - |
| 38 | Data entry (LSB) | 0...127 | LSB of RPN or NRPN data *2 |
| 39...63 | - | - | - |
| 64 | Damper | 0...127 | damper effect |
| 65 | Portamento On/Off | 0...63(Off), 64...127(On) | turn the portamento effect on/off |
| 66 | Sostenuto On/Off | 0...63(Off), 64...127(On) | turn the sostenuto effect on/off |
| 67 | Soft | 0...127 | soft pedal effect |
| 68...69 | - | - | - |
| 70 | Sustain level | 0...127 | sustain levels of the filter EG and amp EG *4 |
| 71 | Filter resonance level | 0...127 | resonance level of the filter *4 |
| 72 | Release time | 0...127 | cutoff frequency of the high pass filter *4 |
| 73 | Attack time | 0...127 | release times of the filter EG and amp EG *4 |
| 74 | Filter cutoff frequency | 0...127 | cutoff frequency of the low pass filter *4 |
| 75 | Decay time | 0...127 | decay times/slope times of the filter EG and amp EG *4 |
| 76 | LFO1 speed | 0...127 | LFO1 speed *4 |

| CC# | Control | Value | Function |
|-----------|--|------------------------------|---|
| 77 | LFO1 depth | 0...127 | pitch LFO1 intensity *4 |
| 78 | LFO1 delay | 0...127 | LFO1 delay *4 |
| 79 | Filter EG intensity | 0...127 | filter EG intensity *4 |
| 80 | SW1 modulation On/Off | 0...63(Off), 64...127(On) | corresponds to on/off when the SW1 function is set to SW1 Mod. |
| 81 | SW2 modulation On/Off | 0...63(Off), 64...127(On) | corresponds to on/off when the SW2 function is set to SW2 Mod. |
| 82 | Foot switch On/Off | 0...63(Off), 64...127(On) | corresponds to on/off when the function of the assignable foot switch is set to Foot SW |
| 83 | Controller (CC#83) | 0...127 | for controlling AMS or Dmod |
| 84 | - | - | - |
| 85...88 | Controller (CC#85...88) | 0...127 | for controlling AMS or Dmod |
| 89, 90 | - | - | - |
| 91 | Effect depth 1 (send 2 level) | 0...127 | send 2 level |
| 92 | Effect depth 2 (Insert Effect 1-5 On/Off) | 0...63(Off), 64...127(On) | turn Insert effect 1...5 on/off *5 |
| 93 | Effect depth 3 (send 1 level) | 0...127 | send 1 level |
| 94 | Effect depth 4 (master effect 1, 2 On/Off) | 0...63(Off), 64...127(On) | master effect 1, 2 on/off *5 |
| 95 | Effect depth 5 (total effect On/Off) | 0...63(Off), 64...127(On) | total effect on/off *5 |
| 96 | Data increment | 0 | |
| 97 | Data decrement | 0 | |
| 98 | NRPN(LSB) | - | LSB of NRPN |
| 99 | NRPN(MSB) | - | MSB of NRPN |
| 100 | RPN(LSB) | 0 | selects the pitch bend range *2 |
| | | 1 | controls Fine Tune *2 |
| | | 2 | controls Coarse Tune *2 |
| 101 | RPN(MSB) | 0 | MSB of RPN |
| 102...119 | - | - | - |

You can assign any control change number (CC#00-119) to the Realtime Controls Knobs USER 1-4. In this case, the transmitted values will all be 0...127.

You can assign any control change number (CC#00-119) to the ARP button, arpeggio control knobs 1-4. In this case, ARP buttons will transmit values of 0 (Off) or 127 (On), knobs 1-4 will transmit values of 0...127.

*1 In the KROME sequencer, bank select messages are normally specified as program change events ("MIDI Event Edit" Sequencer P6). However in some cases this will be insufficient when you wish to change banks on an external device. In such cases, you can use CC#00 and CC#32 to specify the banks.

For information on the relation between bank select numbers and the banks of your external device, refer to the owner's manual for your external device.

*2 Unlike conventional control changes, pitch bend range, fine tune, and coarse tune settings are made using RPC (Registered Parameter Control) messages. In Program, Combination, and Sequencer modes, you can use RPC messages to control the bend range and tuning for each program, Timbre (Combination), or Track (Sequencer).

The procedure is to use an RPN (Registered Parameter Number) message to select the parameter that you wish to edit, and then use Data Entry to input a value for that parameter. To select the parameter, use CC#100 (with a value of 00...02) and CC#101 (with a value of 00). use CC#06 and CC#38 to enter the data.

The data entry values for each parameter and the corresponding settings are as follows.

RPN=0 (Pitch bend range)

| CC#06 | CC#38 | Parameter value (Semitone steps) |
|-------|-------|----------------------------------|
| 0 | 00 | 0 |
| ⋮ | ⋮ | ⋮ |
| 12 | 00 | +12 |
| ⋮ | ⋮ | ⋮ |
| 24 | 00 | +24 |
| ⋮ | ⋮ | ⋮ |
| 127 | 00 | +24 |

RPN=1 (Fine tune)

| CC#06 | CC#38 | Parameter value (1 cent steps) |
|-------|-------|--------------------------------|
| 0 | 00 | -100 |
| ⋮ | ⋮ | ⋮ |
| 64 | 00 | 0 |
| ⋮ | ⋮ | ⋮ |
| 127 | 00 | +98 |
| ⋮ | ⋮ | ⋮ |
| 127 | 127 | +99 |

RPN=2 (Coarse tune)

| CC#06 | CC#38 | Parameter value (Semitone steps) |
|-------|-------|----------------------------------|
| 0 | 00 | -24 |
| ⋮ | ⋮ | ⋮ |
| 40 | 00 | -24 |
| ⋮ | ⋮ | ⋮ |
| 64 | 00 | 0 |
| ⋮ | ⋮ | ⋮ |
| 88 | 00 | +24 |
| ⋮ | ⋮ | ⋮ |
| 127 | 00 | +24 |

For example, if in Sequencer mode you wish to set a MIDI track that is receiving channel 1 to a transpose (coarse tuning) value of -12, you would first transmit [B0, 64, 02] (64H=CC#100) and [B0, 65, 00] (65H=CC#101) to the KROME to select the RPN coarse tune. Then you

- would set this to -12 by transmitting [B0, 06, 34] (06H=CC#6), 34H=52 (corresponds to -12), and [B0, 26, 00] (26H=CC#38, 00H=0).
- *3 The volume of the KROME is determined by multiplying the Volume (CC#07) with the Expression (CC#11). In Sequencer mode when you stop the song playback and return the location to the beginning of the track, the Volume will be set to the starting value, and the Expression will be set to the maximum value (127).
 - *4 A value of 64 will correspond to the value specified by the program parameter. 0 is the minimum, and 127 is the maximum. Changing from 63-1 or from 65-126 will adjust the effect from the program parameter setting toward the minimum value or maximum value.
 - For details about the specific parameters controlled by these CCs, please see "Parameters controlled by MIDI CCs #70-79" on page 358.
 - *5 Controlled on the global MIDI channel.
 - *6 If you assign a CC# to the ARP button or arpeggio control knobs 1-4 and perform these operations on the KROME, the assigned CC# will be transmitted, and the KROME itself will also be controlled at the same time. If this message is received, the result will be the same as if the KROME itself had been operated.
- The CC# settings for each knob and button are made in the Global P2-MIDI CC# Assign page. Use these settings if you need to assign control change messages, for example when you want to record button operations on the internal sequencer or an external MIDI sequencer, or to control the arpeggiator from an external MIDI device.

Each knob and button can be assigned to any desired MIDI control change message CC#00-119, but normally you will choose the Global P2-MIDI CC# Assign menu command **Reset Controller MIDI Assign** and use the CC Default settings.

This table shows the operations for the CC Default settings. The CC Default settings are the CC#s recommended for use with these controllers. Normally, you will assign these CC#s.

Parameters controlled by MIDI CCs #70-79

CC#70-79 correspond to the KROME's program parameters listed below.

In Program mode, the corresponding program parameters will be temporarily edited when CC#70-79 messages are received on the global MIDI channel (**MIDI Channel** Global 1-1a), when knobs 1-4 are operated when the Realtime Controls is in TONE, or when knobs 1-4 are operated when assigned to CC#70-79 with the Realtime Controls in USER.

In most cases, you can use the **Write Program** menu command to save the edited values, over-writing the previous Program settings.

 In Combination and Sequencer modes, you can use these CCs to temporarily edit the parameters for all Timbres or Tracks on a given MIDI channel. However,

| CC# | Internal parameters controlled by the CC |
|------------------------------|---|
| 70 (Sustain level) | Filter EG 1/2 Sustain (see page 32) Amp EG 1/2 Sustain (see page 39) |
| 71 (Filter resonance) | Filter A/B, 1/2 Resonance (see page 27) |
| 72 (Release time) | Filter EG 1/2 Release (see page 32) Amp EG 1/2 Release (see page 39) |
| 73 (Attack time) | EG Times: Filter EG 1/2 Attack (see page 32) Amp EG 1/2 Attack (see page 39) Amp EG 1/2 Time Modulation: Attack (see page 39) EG Levels: Amp EG 1/2 Level Start (see page 38) Amp EG 1/2 Level Attack (see page 38) Amp EG 1/2 Level Modulation: Start (see page 40) |
| 74 (Filter cutoff frequency) | Filter A/B, 1/2 Frequency (see page 27) |
| 75 (Decay time) | Filter EG 1/2 Decay (see page 32) Filter EG 1/2 Slope (see page 32) Amp EG 1/2 Decay (see page 39) Amp EG 1/2 Slope (see page 39) |
| 76 (LFO1 speed) | LFO 1 Frequency (see page 42) |
| 77 (LFO1 Pitch intensity) | Pitch LFO1 Intensity (see page 22) |
| 78 (LFO1 delay) | LFO 1 Delay (see page 43) |
| 79 (Filter EG intensity) | Filter EG 1/2 Intensity to A (see page 30) Filter EG 1/2 Intensity to B (see page 30) |

MIDI applications

About MIDI

MIDI stands for Musical Instrument Digital Interface, and is a world-wide standard for exchanging various types of musical data between electronic musical instruments and computers. When MIDI cables are used to connect two or more MIDI devices, performance data can be exchanged between the devices, even if they were made by different manufacturers.

Settings when connected to a MIDI device or computer

Here we will explain the settings you'll make on the KROME when connecting it to another device.

The "Convert Position" setting

The KROME's settings **Key Transpose**, **Velocity Curve**, and **After Touch Curve (MIDI IN)** (Global 0–1a) respectively allow you to adjust the transposition, velocity sensitivity, and aftertouch (received only from the internal sequencer or from MIDI IN) sensitivity.



The aftertouch curve is applied only to data received from the internal sequencer or from MIDI IN. The **After Touch Curve (MIDI IN)** setting does nothing if **Convert Position** (Global 1–1a) is Pre-MIDI.

The effect that these settings will have on the internal sequencer and on the MIDI data that is transmitted and received will depend on **Convert Position** (Global 1–1a) setting.

- If you want to control an external MIDI tone generator from the KROME, set **Convert Position** to PreMIDI. The various settings listed above will be reflected in the MIDI data that is transmitted. These settings will also be reflected in the data that is recorded on the internal sequencer.

Incoming MIDI data will be handled with settings equivalent to **Key Transpose 0**, **Velocity Curve 4**, and **After Touch Curve 3**.

- When controlling the KROME's tone generator from an external MIDI device, select PostMIDI. The above-listed settings will affect the MIDI data that is received. These settings will also affect the data that is played back from the internal sequencer.

Outgoing MIDI data will be handled with settings equivalent to **Key Transpose 0**, and **Velocity Curve 4**.

Local Control On settings

If you've connected the KROME to a computer or external MIDI sequencer and want to use the "echo-back" from that device to play the KROME, turn echo-back on for your external MIDI sequencer or computer (so that the data it receives at MIDI IN will be retransmitted from MIDI OUT), and turn off the KROME's local control setting (so that the KROME's keyboard section and sound generator will be internally disconnected).

When you play the keyboard of the KROME, the musical data will be transmitted to the external MIDI sequencer or computer, and then echoed back to play the KROME's tone generator. In other words, by turning Local Control OFF, you can prevent notes from being sounded in duplicate, as would otherwise occur if a note were sounded by the KROME's own keyboard and again by the data that was echoed-back.

If the arpeggiator function is on, playing the KROME's keyboard will not cause the arpeggiator to operate, and only the musical data produced by playing the keyboard will be transmitted. The arpeggiator will operate only in response to the notes that are echoed-back and received at MIDI IN. In this way, turning off Local Control prevents the arpeggiator from operating in duplicate.

Use this setting when you wish to record on the external MIDI sequencer or computer only the notes that trigger the arpeggiator, and to use the echoed-back notes to operate the arpeggiator while monitoring your recording or during playback.

Note: If you want the note data produced by the arpeggiator to be recorded on the external sequencer/computer, set Local Control on, and turn off the Echo Back setting of the external sequencer/computer.

To turn off Local Control, press the **Local Control On** (Global 1–1a) check box to uncheck it.

When using the KROME by itself, leave Local Control turned on. (If this is off when the KROME is used by itself, playing the keyboard will not produce sound.)

Messages transmitted and received by the KROME

In the text below, [...] indicates hexadecimal notation.

MIDI channels

MIDI messages can be exchanged when the transmitting and receiving devices are set to the same MIDI channel. MIDI uses sixteen channels, numbered 1–16. The way in which channels are handled will differ depending on the mode.

Program mode

- Other than transmission for the Drum Track function, all data is transmitted and received on the global MIDI channel.

The global MIDI channel is the basic channel that the KROME uses for MIDI transmission/reception, and is set by **MIDI Channel** (Global 1–1a).

- The Drum Track function in Program mode will transmit and receive on the following MIDI channels.

Receive: Global MIDI channel.

Transmit: The MIDI channel specified by the Drum Track **Prog MIDI Out** (Global 1–1a) setting (default: channel 10).

Note: Transmission is enabled if Drum Track **Prog MIDI Out** (Global 1–1a) is checked. By default, this is off (unchecked).

Combination mode

- The global MIDI channel is used to transmit/ receive messages for selecting a combination and turning effects on/off, and to transmit/receive exclusive data.
- Each timbre will transmit/receive MIDI data on the **MIDI Channel** (Combi 3–1(2)c) that is specified for that timbre.
- The Drum Track function will transmit and receive on the following MIDI channels.

Receive: Global MIDI channel. The KROME’s keyboard will control triggering.

Transmit: The MIDI channel specified by the Drum Pattern **Output** (Combi 7–6a) setting of each combination. Set this to match the MIDI channel of a timbre to which a drum program is assigned.

- The **Ch** MIDI channel specified for each effect (Combi 8–4a, 9–2a) is used to control dynamic modulation of the insert/master/total effect, the pan following the insert effect, and send 1 and 2.
- When you operate the keyboard or controllers of the KROME, messages will be transmitted on the global MIDI channel, and will also be transmitted on the MIDI channel of any timbre whose **Status** (Combi 2–1a) is set to EXT or EX2.
- Channel messages will be received if they match the MIDI channel of a timbre whose **Status** is set to INT (Combi 3–1(2)c).

Sequencer mode

- The global MIDI channel is used to transmit/ receive exclusive data and for messages that switch effects on/off.
- MIDI data transmission/reception for each MIDI track will occur on the MIDI channel specified for each MIDI track by **MIDI Channel** (Seq 3–1(2)c).
- The Drum Track function will transmit and receive on the following MIDI channels.

Receive: The MIDI channel specified by the Drum Pattern **Input** (Seq 1–1a) setting of each song. You will normally set this to Tch and use the KROME’s keyboard to control triggering.

Transmit: The MIDI channel specified by the Drum Pattern **Output** (Seq 1–1a) setting of each song. Set this to match the MIDI channel of the MIDI track to which a drum pattern is assigned.

- The MIDI channel specified for each effect by the **Ch** parameter (Seq 8–4a, 9–2a) is used to control dynamic modulation of the insert/master/total effect, the pan following the insert effect, and send 1 and 2.
- When you operate the keyboard or controllers of the KROME, messages will be transmitted on the MIDI channel selected by **Track Select** (Seq 0–1(2)a). However, messages will be transmitted only if the selected MIDI track has a **Status** of BTH, EXT, or EX2. For more information, please see “Track Select” on page 110.
- When the sequencer is played back, musical data of MIDI tracks whose **Status** is BTH, EXT, or EX2 will be transmitted on the specified MIDI channels.
- MIDI tracks whose **Status** is INT or BTH will receive channel messages of the matching MIDI channel. For more information, please see “Status” on page 125, and “MIDI Channel” on page 125.

Note on/off

Note-on [9n, kk, vv]

Note-off [8n, kk, vv]

(n: channel, kk: note number, vv: velocity)

When you play a note on the KROME’s keyboard, it will transmit note-on/off messages.

When the arpeggiator is running, note-on/off messages generated by the arpeggiator are transmitted. If Local is Off, note-on/off messages generated by the arpeggiator will not be transmitted. (See “Local Control On settings” on page 359)

If the Drum Track **Prog MIDI Out** setting (Global 1–1a) is checked, the drum track pattern will transmit note-on/off messages while the drum track function is operating.

However, most instruments do not receive or transmit note-off velocity, and neither does the KROME.

Program Change/Bank Select

Changing the program/bank

Program change [Cn, pp]

(n: channel, pp: program number that allows 128 sounds to be selected)

- Programs 000–127 in banks A–E correspond to program changes [Cn, 00]–[Cn, 7F].
- Programs 001–128 in banks GM, g(1), g(2), g(3), g(4), g(5), g(6), g(7), g(8), g(9), and g(d) correspond to program changes [Cn, 00]–[Cn, 7F].

Bank select MSB (CC#0) [Bn, 00, mm]

Bank select LSB (CC#32) [Bn, 20, bb]

(n: channel, mm: bank number upper byte, bb: bank number lower byte)

- The internal banks that correspond to each bank select number will depend on the **Bank Map** setting (Global 0–2a). KORGE is the default setting. For more information, please see “Bank Map” on page 196.

Simply receiving a Bank Select message will not cause the program or bank to change. The program or bank will

actually change when a Program Change message is received.

Program mode

- In Prog P0: Play, these messages will transmit and receive program change and bank select operations. They will not be received in P1–P9.

Note: Drum track programs do not support transmission or reception of program change or bank select messages.

Combination, Sequencer modes

- Program change and bank select messages can be received on the MIDI channel specified for each timbre/MIDI track to select programs on that timbre/track.
- When you select a combination, program change and bank select messages will be transmitted by timbres whose **Status** is EXT or EX2.

In Sequencer mode, program change or bank select messages will be transmitted by tracks whose **Status** is BTH, EXT, or EX2 when you select the **Program Select** parameter (0–1(2)b), when you select a song, or when you return to the beginning of a measure. For more information, please see “Program Select” on page 112.

- In Combination and Sequencer modes, transmission/reception can be switched on/off for each timbre/track. See “Enable Program Change” on page 87, and Global P1: MIDI “Track MIDI Out” on page 200.

Selecting combinations

You can use program change and bank select messages to select combinations in the same way that you select programs.

- Combinations 000–127 in banks A–D correspond to program changes [Cn, 00]–[Cn, 7F].
- Similarly as for program banks, the internal banks that correspond to each bank select number will depend on the **Bank Map** setting (Global 0–2a). For more information, please see “Bank Map” on page 196.
- In Combi P0: Play, program change and bank select messages are transmitted/received on the global MIDI channel. They are not received in P1–P9.

Note: All program changes can be turned off in **MIDI Filter** (Global 1–2b)

As needed, you can independently turn all program changes on/off, specify whether or not incoming messages will be able to change combinations, and turn reception/transmission of bank select messages on/off.

- If **Combination Change** (Global 1–2b) is unchecked, the combination will not change even if a program change on the global MIDI channel is received in Combi P0: Play. In this case, the program of the timbre that matches the MIDI channel of the received message will change.
- If **Bank Change** (Global 1–2b) is unchecked, bank select messages will not be transmitted or received.

Aftertouch

Channel aftertouch [Dn, vv]

(n: channel, vv: value)

When this message is received, the aftertouch effect will be applied. The assigned alternate modulation or dynamic modulation effect will also be applied.



The keyboard of the KROME itself cannot transmit aftertouch. Aftertouch can be received only from the internal sequencer or from MIDI IN.

- Aftertouch reception for the entire instrument can be turned on/off in **Enable After Touch** (Global 1–2b).

- In Combination and Sequencer modes, aftertouch can be turned on/off independently for each timbre/track (**Enable After Touch** Combi/Seq 5–1(2)c).

Polyphonic aftertouch [An, kk, vv]

(n: channel, kk: note number, vv: value)

There is another type of aftertouch called Polyphonic Key Pressure, which allows aftertouch to be applied independently for individual keys. This message can be used as an alternate modulation source, but cannot be transmitted by the KROME's keyboard. In order to use this message, it will have to be received from an external device, or recorded on your sequencer.

The aftertouch mentioned in this manual refers to Channel After Touch.

Pitch bend

Pitch bend change [En, bb, mm]

(n: channel, bb: lower byte of the value, mm: upper byte of the value, together expressing a value of 16,384 steps where 8,192 [bb, mm = 00H, 40H] is the center value)

When the KROME's joystick is moved in the X axis (left/right), a pitch bend effect will be applied, and pitch bender messages will also be transmitted. When these messages are received, a pitch bend effect will be applied.

The range of pitch change that is produced by pitch bend messages can also be adjusted via MIDI. (See “Changing the pitch bend range” on page 365)

Control change

[Bn, cc, vv]

Transmitted and received as (n: channel, cc: control change no., vv: value)

For more information, please see “MIDI transmission when the KROME's controllers are operated” on page 354, and “KROME and MIDI CCs” on page 356.

- Control changes can be turned on/off as a whole in **Enable Control Change** (Global 1–2b).
- In Combination and Sequencer modes, the P3: MIDI Filter1 settings allow transmission/reception of control changes to be individually turned on/off for each timbre/track. For the assignable controllers (SW1, SW2, Realtime Controls Knob USER1 – USER4, and Foot Pedal/Switch), MIDI filter settings will apply to the control change number to which each controller is assigned. **Other Control Change** applies to control changes that are not covered by the items of the other check boxes.

Note: You can select MIDI CC#00–CC#119 for knobs 1–4 when the Realtime Controls USER is selected.

Although you can select MIDI CC#00–CC#119 for the ARP Controllers, you will normally use the default settings that are assigned when you execute the menu command **Reset Controller MIDI Assign** with Default Setting, ARP Controllers SW – ARP ON/OFF at CC#014, KNOB1 – ARP GATE at CC#022, KNOB2 – ARP VELOCITY at CC#023, KNOB3 – ARP SWING at CC#024, KNOB4 – ARP STEP at CC#025.

Selecting program/combination banks

Bank select (CC#00, CC#32)

Technically, Bank Select is a controller. In practice, however, it is a component of Program Change. For more information, please see “Program Change/Bank Select” on page 360)

Using the joystick to apply modulation

Modulation 1 depth (CC#01) [Bn, 01, vv]

When you move the KROME's joystick in the +Y direction (Vertical upward), Modulation 1 Depth messages will be transmitted. When these messages are received, the same effect will be applied as when the KROME's joystick is operated. Normally this will apply a vibrato effect (pitch LFO).

- In Combination and Sequencer modes, transmission/reception can be turned on/off for each timbre/track (**Enable JS+Y** Combi/Seq 5-3(4)c).

Modulation 2 depth (CC#02) [Bn, 02, vv]

When you move the KROME's joystick in the -Y direction (Vertical downward), Modulation 2 Depth messages will be transmitted. When these messages are received, the same effect will be applied as when the KROME's joystick is operated. Normally this will apply a wah effect (filter LFO).

- In Combination and Sequencer modes, transmission/reception can be turned on/off for each timbre/track (**Enable JS-Y** Combi/Seq 5-3(4)c).

Other manufacturers use this message for other purposes (e.g., breath controller, etc.)

Controlling portamento

Portamento time (CC#05) [Bn, 05, vv]

If you assign the above CC# to an Assignable Pedal or knobs 1-4 when the Realtime Controls USER is selected, rotating that knob will transmit Portamento Time messages, and will modify the speed at which the portamento pitch changes. When this message is received, the result will be the same as when the controller is operated.

Portamento switch (CC#65) [Bn, 41, vv]

When the above CC# is assigned to SW1, SW2 or the Assignable Switch, operating that switch will transmit vv=127 [7F] for ON or vv=0 [00] for OFF, and the portamento effect will be switched on/off. When this message is received, the result will be the same as when the controller is operated. (vv of 63 [3F] or less will be OFF, and 64 [40] or greater will be ON.) (See "SW1/2 Assignments" on page 348)

- In Combination and Sequencer modes, transmission/reception of this message can be turned on/off independently for each timbre/track (**Enable Portamento SW** Combi 5-1(2)c/Seq 3-1a).
- In Sequencer mode, portamento time/switch messages will be transmitted by each track whose **Status** is BTH, EXT, or EX2 when you set **Portamento** (Seq 3-3(4)c), re-select a song or SMF, or return to the beginning of a measure. For more information, please see "Portamento" on page 126.

Controlling volume

Volume (CC#07) [Bn, 07, vv]

When the above CC# is assigned to the Assignable Pedal or knobs 1-4 when the Realtime Controls USER is selected, operating that controller will transmit Volume messages, and the volume will change. When this message is received, the result will be the same as when the controller is operated.

Expression (CC#11) [Bn, 0B, vv]

When the above CC# is assigned to the Assignable Pedal or knobs 1-4 when the Realtime Controls USER is selected, operating that controller will transmit Expression messages, and the volume will change. When this message is received, the result will be the same as when the controller is operated.

The volume of the KROME is determined by multiplying the value of the Volume message with the value of the Expression message.

If adjusting the Volume message does not increase the volume as you expect, or if there is no sound, transmit MIDI messages from an external device to reset the value of the Expression message (set vv to 127).

Note: In Sequencer mode, this will be reset when the **Location** of the song is moved to 001:01.000.

- In Combination mode, Volume messages will be transmitted by each timbre whose **Status** is EXT or EX2 when you re-select the combination.
- When you change the **Volume** setting (Seq 0-3(4)b) in Sequencer mode, or when you re-select the song or return to the beginning of the song in Sequencer mode, volume messages will be transmitted by each track whose **Status** is BTH, EXT, or EX2. See Global P1: MIDI "Track MIDI Out" on page 200.

Note: Regardless of the **Status** settings, re-selecting a song, or returning to the beginning will reset the internal Volume value to the value specified by each track (the starting settings), and will reset the Expression value to the maximum.

Note: This message can be used to control the volume of each MIDI track. Normally, you will include a Volume message in the MIDI track setting data (the settings at the beginning of the track) to set the initial volume, and use Expression to create changes in dynamics as the song progresses.

By using the universal exclusive Master Volume message, you can adjust the overall volume without changing the volume balance between timbres or tracks. ("About system exclusive messages" on page 365)

Controlling pan (stereo position)

Pan (CC#10) [Bn, 0A, vv]

(vv: value, where 00 is far left, 64 is center, and 127 is far right)

When the above CC# is assigned to the Assignable Pedal or knobs 1-4 when the Realtime Controls USER is selected, operating that controller will transmit Pan messages, and the panning will change. When this message is received, the result will be the same as when the controller is operated.

- When you set the **Pan** (Seq 0-3(4)b) in Sequencer mode, or when you re-select the song or return to the beginning of the measure in Sequencer mode, Panpot messages (except for RND) will be transmitted by each track whose **Status** is BTH, EXT, or EX2. See "Pan" on page 113, Global P1: MIDI "Track MIDI Out" on page 200.

Post insert effect pan (CC#08) [Bn, 08, vv]

(vv: value, where 00 is far left, 64 is center, and 127 is far right)

When the above CC# is assigned to the Assignable Pedal or knobs 1-4 when the Realtime Controls USER is selected, operating that controller will transmit Post Insert Effect Panpot messages, and the panning of the sound following the insert effect will change. When this message is received, the result will be the same as when the controller is operated.

- In Program mode, this message is transmitted/received on the global MIDI channel. In Combination, and Sequencer modes, this message is transmitted/received on the MIDI channel specified for each insert effect.
- When you set **Pan: #8** (Seq 8-3b) in Sequencer mode, or when you re-select the song or return to the beginning of the measure in Sequencer mode, Post Insert Effect Panpot

messages will be transmitted by each track whose **Status** is BTH, EXT, or EX2. For more information, please see “8–3b: Insert Effect” on page 149.

Controlling effects

Effect control 1 (CC#12) [Bn, 0C, vv]

Effect control 2 (CC#13) [Bn, 0D, vv]

When the above CC# is assigned to the Assignable Pedal or knobs 1–4 when the Realtime Controls USER is selected, operating that controller will transmit Effect Control 1/2 messages, and the specified dynamic modulation will be controlled. When this message is received, the result will be the same as when the controller is operated.

Although various types of control change can be selected as dynamic modulation sources, Effect Control 1 (CC#12) and 2 (CC#13) are dedicated for dynamic modulation.

Effect 1 depth (Send 2) (CC#91) [Bn, 5B, vv]

Effect 3 depth (Send 1) (CC#93) [Bn, 5D, vv]

When the above CC# is assigned to the Assignable Pedal or Realtime Controls knobs 1–4, operating that controller will transmit Effect 1 Depth (Send 2) or Effect 3 Depth (Send 1) messages, and the send level 1 or 2 to the master effects MFX1 or MFX2 will be controlled respectively. When this message is received, the result will be the same as when the controller is operated.

On the corresponding MIDI channels, this will simultaneously control the timbre/track setting as well as the setting following the Insert Effect.

- In Combination, and Sequencer modes, the actual send level of the timbre/track is determined by multiplying this value with the send 1/2 settings for each oscillator (Prog 8–1d). (See “Send 1 (MFX1),” “Send 2 (MFX2)” on page 96, Global P1: MIDI “Track MIDI Out” on page 200)
- When you adjust **Send 1 (MFX1)** or **Send 2 (MFX2)** (Sequencer 8–1b) in Sequencer mode, or when you re-select a song or return to the beginning of the measure in Sequencer mode, Send 1/2 will be transmitted by each track whose **Status** is BTH, EXT, or EX2. (See “Send 1 (MFX1)” on page 148).

Effect 2 depth (IFX1–5 on/off) (CC#92) [Bn, 5C, vv]

Effect 4 depth (MFX1, 2 on/off) (CC#94) [Bn, 5E, vv]

Effect 5 depth (TFX on/off) (CC#95) [Bn, 5F, vv]

Separately from the effect on/off settings in each mode, **Effect Global SW** (Global 0–1b) allows you to turn off insert effects IFX1–5 and master effects MFX1, 2 and total effect TFX. Master effects MFX1/2 and the total effect TFX can also be turned off using the front panel MASTER FX button and TOTAL FX button.

If you uncheck **Enable IFX1–5**, **Enable MFX1&2** or **Enable TFX**, the corresponding message will be transmitted with vv=0 [00]. If you check these settings, the corresponding message will be transmitted with vv=127 [7F]. If you uncheck these settings, the corresponding effect(s) will be turned off as a group. If you check these settings, the on/off settings of each mode will be used. The same applies to reception. (vv of 00 is off, and 01 or greater is the original setting.) These messages are transmitted/received on the global MIDI channel. (“IFX 1–5 on/off” - “MFX 1, 2 on/off” - “TFX on/off” on page 59, page 61)

Note: These messages are defined simply for use in adjusting the effect levels, and may not have the same function on another instrument connected to the KROME.

Using various controllers

Here we will explain typical ways to use the various controllers. You can choose from MIDI CC#00–CC#119 for knobs 1–4 when the Realtime Controls USER is selected.

Foot controller (CC#04) [Bn, 04, vv]

If the above CC# is assigned as the Assignable Pedal function, this message will be transmitted when the controller is operated.

- In Combination and Sequencer modes, transmission/reception of this message can be turned on/off independently for each timbre/track (**Enable Foot Pedal/Switch Combi/Seq 5–1(2)c**).

Controller (CC#18) [Bn, 12, vv]

This message will be transmitted when the KROME’s VALUE dial is operated.

This is valid in **Program Select** (Prog 0–1a) and **Combination Select** (Combi 0–1(2)a) when the program or combination number/name is selected (highlighted).

Knob modulation USER [1], USER [2], USER [3], USER [4] (CC#17, 19, 20, 21)

[Bn, 11, vv], [Bn, 13, vv], [Bn, 14, vv], [Bn, 15, vv]

If the above CC# are assigned to the knobs 1–4 when the Realtime Controls USER mode is selected, these messages will be transmitted when the knobs are operated.

- In Combination and Sequencer modes, transmission/reception of this message can be turned on/off independently for each timbre/track (**Enable Realtime Controls Knob UER [1], USER [2], USER [3], USER [4] Combi 5–7(8)c/Seq 5–7(8)c**).

Controller (CC#83) [Bn, 53, vv]

If you assign the above CC# to a knobs 1–4 when the Realtime Controls USER mode is selected, this message will be transmitted when you operate the corresponding controller of the KROME.

Damper pedal (CC#64) [Bn, 40, vv]

This message is transmitted when you operate a damper pedal (optional DS-1H) connected to the DAMPER jack, and the damper effect will be turned on/off. If the DS-1H is used, a half-damper effect can be applied.

- In Combination and Sequencer modes, transmission/reception of this message can be turned on/off independently for each timbre/track (**Enable Damper Combi/Seq 5–1(2)c**).

SW1 modulation (CC#80) [Bn, 50, vv]

SW2 modulation (CC#81) [Bn, 51, vv]

If the above CC# are assigned as the function of SW1 or SW2, operating the switch will transmit this message with vv=127 [7F] for ON, and vv=00 [00] for OFF.

- In Combination and Sequencer modes, transmission/reception of these messages can be turned on/off independently for each timbre/track (**Enable SW1, Enable SW2 Combi/Seq 5–9(10)c**).

Foot switch (CC#82) [Bn, 52, vv]

If the above CC# is assigned as the function of the ASSIGNABLE SWITCH, operating the switch will transmit this message with vv=127 [7F] for ON, and vv=00 [00] for OFF.

- In Combination and Sequencer modes, transmission/reception of this message can be turned on/off independently for each timbre/track (“Enable Foot Switch” Combi/Seq 5–9(10)c).

Sostenuto (CC#66) [Bn, 42, vv]

If the above CC# is assigned as the function of the ASSIGNABLE SWITCH, operating the switch will transmit this message with vv=127 [7F] for ON, and vv=00 [00] for

OFF, and the sostenuto effect will be turned on/off. When this message is received, the result will be the same as when the controller is operated (OFF for vv=63 [3F] or below, and ON for vv=64 [40] or above).

Soft pedal (CC#67) [Bn, 43, vv]

If the above CC# is assigned as the function of the ASSIGNABLE SWITCH, operating the switch will transmit, and the soft pedal effect will be turned on. When this message is received, the result will be the same as when the controller is operated.

When “Foot controller (CC#04)”–“Soft pedal (CC#67)” are operated on the KROME, the specified alternate modulation or dynamic modulation etc. will be controlled. When these messages are received, the result will be the same as if the controller had been operated. For “SW1 modulation (CC#80)”–“Soft pedal (CC#67),” vv of 63 [3F] or less will be OFF, and 64 [3F] or greater will be ON.

Controlling via the controllers of a connected MIDI instrument such as the KRONOS

Ribbon Controller (CC#16) [Bn, 10, vv]

When a control change is received from the ribbon controller or other assigned controller of a MIDI instrument (such as the KRONOS), the specified effect (e.g., alternate modulation or dynamic modulation) will be applied.

- In Combination or Sequencer modes, transmission and reception can be turned on/off for each timbre/track. (“Enable Ribbon CC#16” on page 88, page 134)

Controller (CC#85, CC#86, CC#87, CC#88)

[Bn, 12, vv], [Bn, 13, vv], [Bn, 14, vv], [Bn, 15, vv]

When the VALUE dial of MIDI instruments such as the KRONOS, or a control change assigned to a controller is received, the specified alternate modulation or dynamic modulation effect will be applied.

Controlling Program tone & envelope shapes

CC#70–79 control specific parameters of a program.

For details on the program parameters that correspond to each control change, and how the KROME will respond in each mode when these are received, refer to “KROME and MIDI CCs” on page 356.

Filter cutoff (CC#74) [Bn, 4A, vv]

Resonance level (CC#71) [Bn, 47, vv]

Filter EG intensity (CC#79) [Bn, 4F, vv]

Release time (CC#72) [Bn, 4B, vv]

These messages are transmitted when you operate the Realtime Controls TONE [1] – [4] knobs. (They can also be set as Realtime Controls USER [1] – [4] knobs functions.)

Sustain level (CC#70) [Bn, 46, vv]

Attack time (CC#73) [Bn, 49, vv]

Decay time (CC#75) [Bn, 4B, vv]

LFO 1 speed (CC#76) [Bn, 4C, vv]

LFO 1 depth (pitch) (CC#77) [Bn, 4D, vv]

LFO 1 delay (CC#78) [Bn, 4E, vv]

These messages are transmitted when assign the above CC# to the Realtime Controls USER [1] – [4] knobs function.

When you operate these, the corresponding program parameters will be controlled, and the sound and envelope will change. When these messages are received, the result will be the same as when the controller is operated. (When the message has a value vv=64 [40], the setting will have the value that was set by the program parameter.)

- In Combination and Sequencer modes, transmission/reception can be turned on/off independently for each timbre/track (Enable Realtime Controls–

CUTOFF...RELEASE, USER [1]...USER [4] Combi/Seq 5–5 (6/7/8)).

Note: In Program mode, the corresponding program parameters will be temporarily edited by these messages. You can Write the program to save the modified state (except for certain parameters). The Write operation can also be performed by a MIDI System Exclusive Program Write Request message, in addition to the usual method of using the KROME’s buttons. When you write the data, the values of the corresponding program parameters will be rewritten.

Note: The results of receiving these messages will depend on the instrument. The operation may be different when a device other than the KROME is connected.

Control the arpeggiator

If you assign the following CC#s to knob and switch of arpeggiator, the specified CC# will be transmitted when you operate the KROME, and the KROME itself will be controlled simultaneously. When these messages are received, the result will be the same as if you operated the KROME itself.

The CC# settings for the knobs and buttons are made in the Global P2– MIDI CC# Assign page. However, you can edit these settings if you need to assign MIDI control change messages to the controllers, such as when you want to record the Realtime Controls ARP knob, ARP button operations on the internal sequencer or an external MIDI sequencer, or to control the arpeggiator from an external MIDI device. If Global P1: MIDI ARP Controllers MIDI Out is set to Control Change, MIDI control change messages will be transmitted. (See “ARP Controllers MIDI Out” on page 200)

Each knob and button can be assigned any MIDI control change CC#00–CC#119, or a desired MIDI note number. However, you will normally use the default settings that are assigned when you execute the menu command **Reset Controller MIDI Assign** with CC Default. For more information, please see “Reset Controller MIDI Assign” on page 220.

The operations described below are for these CC Default settings. Transmitted when the corresponding KROME controller is transmitted. When this is received, the same effect will apply as when the KROME’s controller is operated.

ARP ON/OFF (CC#14) [Bn, 0E, vv]

Corresponds to the ARP button. It will transmit vv=127[7F] when On, and vv=000[7F] when Off.

KNOB1 – ARP GATE (CC#22) [Bn, 16, vv]

KNOB2 – ARP VELOCITY (CC#23) [Bn, 17, vv]

KNOB3 – ARP LENGTH (CC#24) [Bn, 18, vv]

KNOB4 – ARP STEP (CC#25) [Bn, 19, vv]

Corresponds to knobs 1–4 when the Realtime Controls is set to ARP.

Silencing all notes on a specific channel

All note off (CC#123) [Bn, 7B, 00] (value 00)

When this is received, all currently-sounding notes on that channel will be turned off (as though the keys had been released). However, the release portion of the notes will remain.

All sound off (CC#120) [Bn, 78, 00] (value 00)

When this is received, all currently-sounding notes on that channel will be silenced. While the All Note Off message allows the release portion of the notes to remain, the All Sound Off message will silence the notes immediately.

However, these messages are provided for emergency use, and are not something that you will use while performing.

Resetting all controllers on a specific channel

Reset all controllers (CC#121) [Bn, 79, 00] (value 00)

When this is received, the value of all controllers on that channel will be reset.

Using RPN (Registered Parameter Numbers)

RPN (Registered Parameter Numbers) are a type of message that allow settings to be made in a way that is common between instrument manufacturers. (NRPN (Non-registered Parameter Numbers) and exclusive messages can be freely used in non-compatible ways by different manufacturers and models of instrument.)

RPN messages can be used for editing with the following procedure.

1. Use RPN MSB (CC#101) [Bn, 65, mm] and RPN LSB (CC#100) [Bn, 64, rr] (n: channel, mm, rr: upper and lower bytes of the parameter number) messages to select the parameter.
2. Use data entry MSB (CC#6) [Bn, 06, mm] and data entry LSB (CC#38) [Bn, 26, vv] (n: channel, mm, vv: upper and lower bytes of the value, together expressing 16,384 levels) to specify the value.
3. You can use data increment (CC#96) [Bn, 60, 00] or data decrement (CC#97) [Bn, 61, 00] (n: channel, value is fixed at 00) to change the value in steps of one.

The KROME can receive the following three RPN messages (tuning, transpose, and pitch bend range).

Tuning

RPN fine tune [Bn, 65, 00, 64, 01]

This RPN message can be used to adjust the detuning for a program or timbre (in Combination mode), or for a track (in Sequencer mode).

The procedure is as follows.

1. [Bn, 65, 00, 64, 01]: Select RPN parameter 01.
2. [Bn, 06, mm, 26, vv]: Use data entry to set the value. A value of 8192 [mm, vv=40, 00] is center, 0 [mm, vv=00, 00] is -100 cents, and 16383 [mm, vv=7F, 7F] is +99 cents.

Note: You can use the universal exclusive Fine Tune message to adjust the overall tuning that corresponds to the **Master Tune** (Global P0: 0-1a) parameter. (See "About system exclusive messages" on page 365)

Transposing

RPN coarse tune [Bn, 65, 00, 64, 02]

This RPN message can be used to adjust the transposition for a program or timbre (in Combination mode), or for a track (in Sequencer mode).

The procedure is as follows.

1. [Bn, 65, 00, 64, 02]: Select RPN parameter 02.
2. [Bn, 06, mm, 26, vv]: Use data entry to set the value. Normally only the upper byte is used.

A value of 8192 [mm, vv=40, 00] is center, 6656 [mm, vv=34, 00] is -12 semitones, and 9728 [mm, vv=4C, 00] is +12 semitones.

Note: You can use the universal exclusive Coarse Tune message to adjust the overall tuning that corresponds to the **Key Transpose** (Global P0: 0-1a) parameter. (See "About system exclusive messages" on page 365)

Changing the pitch bend range

RPN pitch bend range [Bn, 64, 00, 65, 00]

This RPN message can be used to adjust the pitch bend range for a program or timbre (in Combination mode) or for a track (in Sequencer mode).

The procedure is as follows.

1. [Bn, 65, 00, 64, 00]: Select RPN parameter 00.
2. [Bn, 06, mm, 26, vv]: Use data entry to set the value. Normally only the upper byte is used.

A value of 0 [mm, vv=00, 00] is +00, and a value of 1536 [mm, vv=0C, 00] is +12 (one octave). Although it is possible to set a negative value for a timbre/track, only positive values can be set using RPN messages.

About system exclusive messages

Since the way in which these messages are used is left up to each manufacturer, they are mainly used to transmit and receive sound data and editing data for parameters that are unique to a particular instrument. The KROME's system exclusive message format is [F0, 42, 3n, 00, 01, 15, ff, F7]

F0: exclusive status

42: Korg ID

3n: [n=0-F] global MIDI channel 1-16

mm: Model ID byte 1 (00)

mm: Model ID bytes 2 (01)

mm: Model ID bytes 3 (15)

ff: function ID (type of message)

:

:

F7: end of exclusive

Note: To obtain a copy of the "MIDI Implementation" which includes MIDI System Exclusive format information, please contact your Korg distributor.

Universal system exclusive

Certain of the system exclusive messages are publicly defined for a specific use, and these are called universal system exclusive messages.

The KROME uses the following six universal system exclusive messages.

Inquiry message request [F0, 7E, nn, 06, 01, F7]

Inquiry message [F0, 7E, nn, 06, 02, (nine bytes), F7]

When an inquiry message request is received, the KROME will respond by transmitting an inquiry message that means "I am a Korg KROME, with system version ..."

GM system on [F0, 7E, nn, 09, 01, F7]

When this message is received in Sequencer mode, the KROME will be initialized for GM playback.

Master volume [F0, 7F, nn, 04, 01, vv, mm, F7]

(vv: lower byte of the value, mm: upper byte of the value, together indicating 16384 steps)

This message is transmitted if you assign Master Volume as the function of the Assignable Pedal or as a Realtime Controls USER 1 - 4 knobs. This will adjust the overall volume balance without changing the relative volume balance between timbres/tracks. When this message is received, the result will be the same as when the controller is operated.

Master balance [F0, 7F, nn, 04, 02, vv, mm, F7]

(vv: lower byte of the value, mm: upper byte of the value, together indicating 16384 steps, where 8192 is the default

position, and lower values will move the sound toward the left)

When this is received, the overall panning will be adjusted without changing the relative panning between timbres/tracks.

Master fine tuning [F0, 7F, nn, 04, 03, vv, mm, F7]

(A value of 8192 [mm, vv=40, 00] is center, 4096 [mm, vv=20, 00] is -50 cents, and 12288 [mm, vv=60, 00] is +50 cents.)

When this is received, the **Master Tune** (Global P0: 0-1a) parameter will be set.

Master coarse tuning [F0, 7F, nn, 04, 04, vv, mm, F7]

(Normally only the upper byte mm is used. A value of 8192 [mm, vv=40, 00] is center, 6656 [mm, vv=34, 00] is -12 semitones, and 9728 [mm, vv=4C, 00] is +12 semitones.)

When this is received, the **Key Transpose** (Global 0-1a) parameter will be set.

Transmitting sound settings data (Data Dump)

Data for programs, combinations, drum kits, user arpeggio pattern, global settings, and sequencer data can be transmitted as MIDI System Exclusive messages. The operation of sending this system exclusive data to an external device is called a “data dump.”

By performing a data dump, you can store the KROME’s sounds and settings on an external device, or rewrite the sounds and settings of another KROME.

There are the following two types of data dump.

- When you use the **Dump** (Global P1) menu command to dump data, various types of internal memory data will be transmitted. If this data is received by the KROME, the data will be written directly into internal memory, and it will not be necessary to perform the Write operation. (See “Sending SysEx data dumps” on “Receiving SysEx data dumps” on page 219)
- If the **Enable Exclusive** (Global 1-2b) setting is checked, data will also be dumped in response to a Dump Request message. This data is transmitted and received on the global MIDI channel.

When the KROME receives this data, the data will be written into the edit buffer. If you want to save the data into internal memory, you’ll have to execute the Write operation. This can be done either by executing the Write operation (See “Writing to internal memory” on page 115 of the Operation guide) on the KROME itself, or by a MIDI System Exclusive program write request, combination write request, drum kit write request, user arpeggio pattern write request or global setting write request.

Editing sounds via SysEx

By using various MIDI System Exclusive data dumps, you can rewrite all programs or an individual program. By using parameter change messages, you can edit individual parameters as follows.

Parameter changes

- In Program mode, all parameters other than the program name can be edited.
- In Combination mode, parameters other than the combination name can be edited.
- In Sequencer mode, you can edit the track parameters in P0, 1, 2, 3, 4, and 5, and the P7: Arpeggiator/Drum Track, P8: Insert Effect, and P9: Master/Total Effect parameters. (See “System Exclusive events supported in Sequencer mode” on page 191)

Drum kit parameter change and user arpeggio pattern parameter change

In Global mode, you can edit drum kit and user arpeggio pattern.

Since the other global parameters or Sequencer mode musical data cannot be edited, you will use data dumps to transfer this data.

The global MIDI channel is used to transmit and receive this data.

First check the **Enable Exclusive** (Global 1-2b) setting to enable transmission and reception of exclusive data. When you switch modes on the KROME, a mode change will be transmitted. When you edit individual parameters, parameter change messages will be transmitted.

When these messages are received, the same editing operation will be performed as on the transmitted device.

 **Cautions regarding data dumps and sound editing**

- After MIDI System Exclusive data has been received and processed, a Data Load Completed message will be transmitted. The control master device must not transmit the next message until this message is received (or until a sufficient interval of time has elapsed).
- When you change use parameter changes to edit, the changes will affect the data in the edit buffer and will not be stored in internal memory unless you Write, so that the changes will be lost if you re-select the program or combination. The Write operation can be performed by a MIDI System Exclusive Program Write Request or Combination Write Request message, in addition to the usual method of using the KROME’s buttons. For more information, please see “Writing to internal memory” on page 113 of the Operation guide.
- There is no need to write a song, but it will not be backed-up when you turn off the power. Important data that you want to keep must be saved to an SD card before you turn off the power. For more information, please see “Saving to SD card” on page 113 of the Operation guide.

If notes are “stuck”

If some problem causes “stuck” notes that continue sounding even though you are no longer playing on the keyboard or via MIDI, you can stop the sound by switching the KROME’s mode.

Playing the KROME multi-timbrally from an external device

The KROME can be connected to an external device and played multi-timbrally in the following ways.

- MIDI messages from the external device can play a combination (16-part multi-timbral performance). You can change the overall settings (programs, levels, and effects) by using program change messages to switch combinations.
- MIDI messages from the external device can be used to play a song (16-part multi-timbral performance). Overall settings (programs, levels, effects etc.) can be changed by using a Song Select message to switch songs.
- MIDI Clock messages from the external device can be used to make the KROME playback a song (set **MIDI Clock** to External MIDI, and run the KROME’s sequencer). (“Synchronizing the playback of the Arpeggiator, Drum Track function or sequencer”) You can change the overall settings (programs, levels, effects) by using song select messages to switch songs.

Note: MIDI Clock External USB will operate in the same way as External MIDI. With the Auto setting, an external MIDI clock received at the MIDI IN connector or the USB B connector will automatically cause the KROME to switch to the same method of operation as External MIDI or External USB.

Synchronizing the playback of the Arpeggiator, Drum Track function or sequencer

The choice of whether the KROME will be the master (the controlling device) or the slave (the controlled device) is made by **MIDI Clock** (Global 1–1a).

Note: When MIDI Clock is set to Auto, the KROME will normally operate in the same way as for the Internal setting. When an external MIDI clock is received from the MIDI IN or USB connector, the KROME will automatically operate as for the External MIDI setting.

Using the KROME as master and the external MIDI device as slave

Connect the KROME's MIDI OUT connector to the MIDI IN connector of the external MIDI device. Connect the KROME's USB B connector to your computer's USB port.

- When you set **MIDI Clock** to Internal, the KROME will be the master device, and will transmit MIDI timing clock messages.

Arpeggiator and Drum Track function: The tempo can be controlled from the KROME.

Performance data will be transmitted via MIDI. (Performance data from the drum track will be transmitted in Program mode if the Drum Track **Prog MIDI Ch** setting (Global 1–1a) is checked. Performance data from the Arpeggiator and the Drum Track function in Combination or Sequencer mode will be transmitted from timbres or MIDI tracks whose **Status** is BTH, EXT, or EX2.) An external tone generator connected to MIDI OUT or USB will sound, and the tempo of an external sequencer can be controlled.

Sequencer: The musical data can be played back and controlled on the KROME.

Simultaneously, the sequencer playback will be transmitted via MIDI from MIDI tracks whose **Status** is BTH, EXT, or EX2. An external tone generator connected to MIDI OUT or USB will sound, and the tempo of an external sequencer can be controlled.

Using the external MIDI device as master and the KROME as slave

Connect the KROME's MIDI IN connector to the MIDI OUT connector of the external MIDI device. Connect the KROME's USB connector to your computer's USB port.

- If you use the MIDI connectors to make connections, set **MIDI Clock** to External MIDI. If you use the USB connector to make connections, set it to External USB. The KROME will be the slave.

Arpeggiator and Drum Track function: The tempo will follow the MIDI timing clock. If you playback the external sequencer, the KROME's Arpeggiator or Drum Track function will synchronize to the external timing clock.

Even if **MIDI Clock** is External MIDI or External USB and the KROME is being controlled from the external device, the performance of the Arpeggiator or Drum Track function will still be transmitted via MIDI. (Performance data from the Drum Track will be transmitted in Program mode if the Drum Track **Prog MIDI Out** setting (Global 1–1a) is checked. Performance data from the

arpeggiator and the drum track function in Combination or Sequencer mode will be transmitted from timbres or MIDI tracks whose **Status** is BTH, EXT, or EX2.)

Sequencer: The KROME will not be able to control the performance data; it will be controlled by the external MIDI device connected to MIDI IN or the computer connected to USB. If you wish to playback the external sequencer to make the KROME's sequencer playback in synchronization to the external timing clock, you must first set the same time signature and starting measure locations on both devices.

Even if **MIDI Clock** is set to External MIDI or External USB and the KROME is being controlled from an external device, musical data will be transmitted by tracks whose **Status** is BTH, EXT, or EX2.

Recording musical data from an external device

There are two ways in which you can play back an external sequencer and record its playback on the KROME.

- Set **MIDI Clock** (Global 1–1a) to Internal, begin recording, and then start the external sequencer. With this method, the MIDI messages will be recorded without the two devices being synchronized. Since the incoming musical data will simply be recorded, this method allows the performance to be reproduced faithfully, but since measure divisions etc. will not be kept track of, this method is not suitable if you intend to edit the data later.
- If you set **MIDI Clock** to External MIDI or External USB, the start of recording and the tempo etc. will all be under the control of the external sequencer. Since the two devices will be synchronized during the recording process, measure divisions etc. will be accurately preserved. (You will need to set the time signature before recording.) For more information, please see "Multi REC" on page 118.

Recording the MIDI output of the KROME's controllers, Arpeggiator, Drum Track function and internal sequencer to an external sequencer/computer

If you wish to record the MIDI output of the KROME's controllers, Arpeggiator, Drum Track function, and internal sequencer on an external sequencer or computer and use the KROME as the monitoring and playback tone generator while you record, you must turn off the KROME's Local Control setting (**Local Control On** Global 1–1a), and set your external sequencer/computer for echo-back (a function by which the data received at MIDI IN is retransmitted without change from MIDI OUT) so that the data from the KROME's controllers, Arpeggiator, Drum Track function and internal sequencer will not be applied in duplicate to the tone generator.

Using an external MIDI sequencer/computer to record performance data from the Drum Track function

Turn off the KROME's local control setting. In Program mode, the Drum Track function will transmit performance data if the Drum Track **Prog MIDI Out** setting (Global 1–1a) is on (checked). By default, this is off (unchecked), so you'll need to turn it on.

In your external sequencer/computer, turn the echo-back setting on. With these settings, the sound generator won't produce duplicate notes, and recording and playback will occur correctly.

Using the Realtime Controls Knob 1–4 to record MIDI control changes on an external MIDI sequencer/computer

Set the KROME to Local Control Off. Set the external MIDI sequencer/computer to Echo Back On. With these settings, recording and playback will occur correctly, and the control changes will not be applied to the tone generator in duplicate.

Recording the Arpeggiator or RPPR function on an external MIDI sequencer/computer

When the arpeggiator is on, playing the keyboard or operating the controllers of the KROME will operate and control the arpeggiator.

In the same way, the arpeggiator will be controlled by MIDI messages received from MIDI IN.

Notes transmitted from MIDI OUT (USB) by the arpeggiator are controlled as follows, according to the local control setting (**Local Control On** Global 1–1a).

In Sequencer mode, when the RPPR function is on, playing the keyboard will cause RPPR to operate. Similarly, the RPPR function will also operate in response to notes received on the MIDI channel of the track selected by **Track Select** (Seq 0–1(2)a). Notes will be transmitted by RPPR from MIDI OUT according to the local control setting (**Local Control On**) as described below.

Local Control On: Notes from the arpeggiator or RPPR will be transmitted from MIDI OUT (USB).

Local Control Off: Notes from the arpeggiator or RPPR will not be transmitted from MIDI OUT (USB). The KROME will sound only in response to MIDI messages received at MIDI IN, or generated by the arpeggiator or RPPR.

Setting example 1

Record the note messages generated by the arpeggiator or RPPR function on the external MIDI sequencer/computer.

1. Turn on this instrument's arpeggiator or RPPR function. Set this instrument to Local Control On.
2. Turn Local Control On for this instrument.
3. Turn Echo Back Off on your external sequencer/computer.

By turning echo back off, you will prevent the arpeggiator or RPPR function from performing duplicate processing on the monitored notes during recording.

4. During playback, turn off the arpeggiator and RPPR functions of this instrument.

Setting example 2

Use the external MIDI sequencer/computer to record only the notes that trigger the arpeggiator or RPPR function, and operate this instrument's arpeggiator or RPPR function for monitoring while recording, and during playback.

1. Turn on the KROME's arpeggiator or RPPR function.
2. Set the KROME to Local Control Off.

The note messages generated by the arpeggiator or RPPR function will not be output.

3. On your external MIDI sequencer/computer, turn echo back on.

With these settings, the data will be recorded and played correctly, and the arpeggiator or RPPR function will not be applied in duplicate.

About GM (General MIDI)

The KROME supports the GM standard. It also supports the GM2 sound map (including bank select) with 256 programs and 9 drum programs provided in ROM banks GM, g(1)–g(9), and g(d). (Banks g(1)–g(9) are GM2 variation programs, and g(d) contains drum programs.)

GM is a standard that ensures basic compatibility of sounds and controllers between GM-compatible instruments made by different manufacturers. When using GM with KROME, be aware of the following.

- GM System On is supported in Sequencer mode. For more information, please see "GM Initialize" on page 165.
- When you wish to play a GM sequence, or load GM data into a song, set **Bank Map** (Global 0–2a) to GM(2).

About standard MIDI files

Standard MIDI files (SMF) make it possible for different computer programs or musical instruments made by different manufacturers to exchange time-based MIDI data. Each standard MIDI file contains one song. The KROME supports format 0 (type 0) in which all of the MIDI data is combined into one track, and format 1 (type 1) in which the data is separated by track.

When a SMF is loaded into a song in Media mode, the program bank that is selected will differ depending on the **Bank Map** (Global 0–2a) setting. When playing/loading SMF data that conforms to the GM specifications, set **Bank Map** to GM(2).

Sequencer mode

In Media mode when you convert a song into a Standard MIDI File and save it, you can choose either format 0 or format 1.

- If KROME song data that was saved as a format 1 SMF file is loaded into another device, the track configuration may be different than it was before being saved. This is because MIDI tracks that contain no musical data are omitted, and the remaining tracks are moved into the unused tracks. This will not affect the playback itself.
- If song data that was saved by another device as a format 1 SMF file is loaded into the KROME, the track configuration may be different than it was before being saved. This is because tracks that contain no musical data are omitted, and the remaining tracks are moved into the unused tracks. This will not affect the playback itself.

When exchanging sequence data between two KROME, we recommend that you save the sequence data in the KROME's native format (**Save SEQ**).

When sequence data is saved in the KROME's native format, all of the settings and patterns unique to the KROME will be saved, which will ensure a higher level of reproducibility than when the data is saved as a Standard MIDI File (**Save to Std MIDI File**).

Parameter changes and other recorded data is included in the song data as System Exclusive events, so it can be saved to or loaded from media as usual. Exclusive messages can also be loaded or saved as SMF (Standard MIDI File) data (**Load Standard MIDI File, Save Song as Standard MIDI File**). This allows recorded System Exclusive events to be saved as SMF data, or exclusive messages included in SMF data to be converted into song data.

During playback, this data can be transmitted to an external MIDI device, or used to control track parameters or effect parameters of the song.

Compatibility with the M50

The KROME can load M50 format .PCG and .SNG files while converting them. Data compatibility is supported for loading and saving each type of data via media.

KROME format .PCG and .SNG files cannot be loaded by the M50. Song data (.SNG) can be loaded into the M50 if you first save it as Standard MIDI File (SMF format) data (see p.232).

When loading M50 format .PCG or .SNG files into the KROME, please be aware that the following limitations will apply.

Pad parameters (Program, Combination, Song)

Since the KROME does not have these functions, the corresponding parameters will not be loaded.

External Setup parameters (Global)

Since the KROME does not have these functions, the corresponding parameters will not be loaded.

Global Mode "Foot Switch Assign" parameters

Settings related to other functions will be loaded in the following ways.

| M50 | KROME |
|------------------------------------|--------------------------------------|
| RT Knob 1-A...4-B | TONE [1] - [4], USER [1] - [4] knobs |
| ARP GATE, VELOCITY, LENGTH, OCTAVE | ARP GATE, VELOCITY, SWING, STEP |

Global Mode "Foot Pedal Assign" parameter

Settings related to other functions will be loaded in the following ways.

| M50 | KROME |
|------------------------------------|--------------------------------------|
| RT Knob 1-A...4-B | TONE [1] - [4], USER [1] - [4] knobs |
| ARP GATE, VELOCITY, LENGTH, OCTAVE | ARP GATE, VELOCITY, SWING, STEP |

Bank/number configurations on the KROME and M50

The following table shows the configuration of the Combination, Program, Drum Kit, Drum Pattern, Multisample, and Drumsample banks and numbers for the KROME and the M50. The table at the right shows what will happen when an M50 format file is loaded into the KROME. If the data being loaded contains a bank or number that doesn't exist on the KROME, its settings will be modified if there is no corresponding bank. This means that the data may not sound correctly. Please use caution when loading files between the KROME and the M50.

| Bank configurations on the M50 | Bank configurations on the KROME |
|--------------------------------|----------------------------------|
| Combination | |
| A | A |
| B | B |
| C | C |
| D | D |
| Program | |
| A | A |
| B | B |
| C | C |
| D | D |
| E | E |
| | F |
| G (GM), g(1)... g(9), g(d) | GM, g(1)... g(9), g(d) |
| Drum Kit | |
| 00...31(INT) | 00...31(INT) |
| 32...47(USER) | 32...47(USER) |
| 48...56(GM) | 48...56(GM) |
| User Drum Track Pattern | |
| U000...U999 | U000...U999 |
| User Arpeggio Pattern | |
| U000...U999 | U000...U1027 |
| Multisample | |
| Mono | Mono |
| Stereo | Stereo |
| - | XL Mono |
| - | XL Stereo |
| Drumsample | |
| Mono | Mono |
| Stereo | Stereo |
| - | XL Mono |
| - | XL Stereo |

MIDI Implementation

F#1 : Assignable Foot Pedal
 ASW : Assignable Foot Switch
 Knob : Realtime Control Knob 1,2,3,4
 S Chg : Transmitted when change a Song No. (Seq. mode). (Status = EXT,EX2,BTH)
 C/S Chg : Transmitted when change a Combination or Song No. (Seq. mode). (Status = EXT,EX2 or BTH)
 n : MIDI Channel No. (0 - 15) ----- Usually Global Channel.
 When in Combination/Sequencer mode, each timbre/s/track's channel. (Status = EXT,EX2 or BTH)
 g : Always Enabled.
 RMA = A : When Enable Control Change in Global mode is checked.
 P : When Enable Program Change in Global mode is checked.
 PB : Enabled when Enable Program and Bank Change in Global mode is checked.
 T : Enabled when Enable After Touch in Global mode is checked.
 Q : Enabled when Sequencer is playing(transmit), recording(receive).

*1 : kk = 24 - 108 : KROME 61keys (61keys + Transpose)
 = 02 - 108 : KROME 73keys (73keys + Transpose)
 = 00 - 114 : KROME 85keys (85keys + Transpose)
 = 00 - 127 : Sequencer

*2 : Program Combination MIDI Out [Hex] (Bank Map is KORGS) (Bank Map is GK(21))
 Bank A 000 - 127 : Bank A 000 - 127 : mm,bb,pp = 00,00, 00 - 7F = 3F,00, 00 - 7F
 B 000 - 127 : B 000 - 127 : 00,01, 00 - 7F = 3F,01, 00 - 7F
 C 000 - 127 : C 000 - 127 : 00,02, 00 - 7F = 3F,02, 00 - 7F
 D 000 - 127 : D 000 - 127 : 00,03, 00 - 7F = 3F,03, 00 - 7F
 E 000 - 127 : E 000 - 127 : 00,04, 00 - 7F = 3F,04, 00 - 7F
 F 000 - 127 : F 000 - 127 : 00,05, 00 - 7F = 3F,05, 00 - 7F
 g(1)-(9) 001 - 128 : 79,01-09, 00 - 7F = 79,01-09, 00 - 7F
 g(d) 001 - 128 : 78,00, 00 - 7F = 78,00, 00 - 7F

*3 : When CC# by "CC Default" is assigned to the ARP Controllers in Global Mode.
 Reset Controller MIDI Assign = CC Default
 ARP Knob1 GATE :CC#22
 ARP Knob2 VELOCITY :CC#23
 ARP Knob3 SWING :CC#24
 ARP Knob4 STEP :CC#25

1-2 SYSTEM COMMON MESSAGES

| [Status] | Second | Third | Description (Transmitted when) |
|----------|---------|---------|---|
| [Hex] | [H] | [D] | |
| F2 | ss (ss) | tt (tt) | Song Position Pointer ss : Least significant [LSB] tt : Most significant [MSB] *4 |
| F3 | ss (ss) | | Song Select (Song or Cue List is selected) ss : Song(0-127) |

Transmits Song Position Pointer message when in Sequencer mode. (Internal Clock)
Transmits Song Select message when in Sequencer mode.

*4 : For example, if time signature is 4/4 or 8/8, tt,ss = 00,10 means one measure.

March.15.'12

KROME MIDI IMPLEMENTATION

Consult your local Korg dealer for more information on MIDI System Exclusive Implementation.

1. TRANSMITTED DATA

1-1 CHANNEL MESSAGES

| [Status] | Second | Third | [H] | [Hex, D] | Decimal | Bank |
|----------|---------|-------|-----|----------|--|-------|
| [Hex] | [H] | [D] | [H] | [D] | | |
| 9n | kk (kk) | 40 | | | (Key Off) | *1 A |
| Bn | kk (kk) | 41 | | | More Off (pp)h-127 | *1 A |
| Bn | kk (kk) | 42 | | | (Seq. mode data) | 0 |
| Bn | 00 (00) | mm | | | Poly Key Pressure | *2 PB |
| Bn | 00 (00) | mm | | | (BANK keys, Prog/Combi change) | |
| Bn | 01 (01) | vv | | | Bank Select (MSB) | |
| Bn | 01 (01) | vv | | | (Joystick +/-, ASW/Pd1) | C |
| Bn | 02 (02) | vv | | | Modulation1 | C |
| Bn | 04 (04) | vv | | | (Joystick +/-, ASW/Pd1) | C |
| Bn | 05 (05) | vv | | | Modulation2 | C |
| Bn | 07 (07) | vv | | | (Pedal = Foot Pedal) | C |
| Bn | 08 (08) | vv | | | Fortamento Time | C |
| Bn | 08 (08) | vv | | | (Knob/Pd1 = FXA Para, S Chg) | C |
| Bn | 09 (09) | vv | | | Volume | C |
| Bn | 09 (09) | vv | | | (Knob/Pd1 = FXA Para, S Chg) | C |
| Bn | 0B (0B) | vv | | | Foot FXA Pumpot | C |
| Bn | 0C (0C) | vv | | | (Knob/Pd1 = Expression) | C |
| Bn | 0C (0C) | vv | | | Effect Control 1 | C |
| Bn | 0C (0C) | vv | | | (Knob/Pd1 = FX Control1) | C |
| Bn | 0E (0E) | vv | | | Effect Control 2 | C |
| Bn | 0E (0E) | vv | | | (Knob/Pd1 = FX Control2) | C |
| Bn | 10 (10) | vv | | | (ARP ON/OFF, ASW) | *3 C |
| Bn | 11 (11) | vv | | | Multi Purpose Ctrl1 (ASW/Pd1) | C |
| Bn | 11 (11) | vv | | | (Knob = Knob Mod1) | C |
| Bn | 12 (12) | vv | | | Multi Purpose Ctrl2 (ASW/Pd1) | C |
| Bn | 13 (13) | vv | | | (Knob = Knob Mod2) | C |
| Bn | 13 (13) | vv | | | Multi Purpose Ctrl3 (ASW/Pd1) | C |
| Bn | 14 (14) | vv | | | (Knob = Knob Mod3) | C |
| Bn | 15 (15) | vv | | | Multi Purpose Ctrl4 (ASW/Pd1) | C |
| Bn | 16 (16) | vv | | | (Knob = Knob Mod4) | C |
| Bn | 17 (17) | vv | | | Multi Purpose Ctrl5 (ASW/Pd1) | C |
| Bn | 18 (18) | vv | | | (ARP Knob1 GATE, ASW/Pd1) | *3 C |
| Bn | 19 (19) | vv | | | Multi Purpose Ctrl6 (ASW/Pd1) | C |
| Bn | 19 (19) | vv | | | (ARP Knob2 VELOCITY, ASW/Pd1) | *3 C |
| Bn | 20 (20) | bb | | | Multi Purpose Ctrl7 (ASW/Pd1) | C |
| Bn | 20 (20) | bb | | | (ARP Knob3 SWING, ASW/Pd1) | *3 C |
| Bn | 40 (60) | vv | | | Bank Select (LSB) | *2 PB |
| Bn | 41 (61) | vv | | | (BANK keys, Prog/Combi change) | |
| Bn | 42 (62) | vv | | | Hold | C |
| Bn | 43 (63) | vv | | | (Dampner) | C |
| Bn | 43 (63) | vv | | | Fortamento Off/On | C |
| Bn | 43 (63) | vv | | | (SM1/SM2/ASW = Porta, SW, S Chg) | C |
| Bn | 43 (63) | vv | | | Soft Pedal | C |
| Bn | 46 (70) | vv | | | (ASW = Soft) | C |
| Bn | 47 (71) | vv | | | Sound Controller 1 | C |
| Bn | 48 (72) | vv | | | (Knob = E/A Sustain) | C |
| Bn | 49 (73) | vv | | | Sound Controller 2 | C |
| Bn | 4A (74) | vv | | | (Knob TONE2, Knob = Resonance, ASW/Pd1) | C |
| Bn | 4B (75) | vv | | | Sound Controller 3 | C |
| Bn | 4C (76) | vv | | | (Knob TONE4, Knob = F/A Release, ASW/Pd1) | C |
| Bn | 4D (77) | vv | | | Sound Controller 4 | C |
| Bn | 4E (78) | vv | | | (Knob = F/A Attack) | C |
| Bn | 4F (79) | vv | | | Sound Controller 5 | C |
| Bn | 50 (80) | 00/7F | | | (Knob TONE1, Knob = Filter Cutoff, ASW/Pd1) | C |
| Bn | 51 (81) | 00/7F | | | (Knob = F/A Decay) | C |
| Bn | 52 (82) | 00/7F | | | Sound Controller 6 | C |
| Bn | 53 (83) | vv | | | (Knob = F/A Decay) | C |
| Bn | 54 (84) | vv | | | Sound Controller 7 | C |
| Bn | 55 (85) | vv | | | (Knob = F/A Leaky) | C |
| Bn | 56 (86) | vv | | | Sound Controller 8 | C |
| Bn | 57 (87) | vv | | | (Knob = F/A Leaky Spd) | C |
| Bn | 58 (88) | vv | | | Sound Controller 9 | C |
| Bn | 59 (89) | vv | | | (Knob = Pitch LED, Div) | C |
| Bn | 5A (90) | 00/7F | | | Sound Controller 10 | C |
| Bn | 5B (91) | 00/7F | | | (Knob = Pitch LED, Div) | C |
| Bn | 5C (92) | 00/7F | | | Multi Purpose Ctrl5 (SM1/ASW = SW1 Mod.) | C |
| Bn | 5D (93) | 00/7F | | | Multi Purpose Ctrl6 (SM2/ASW = SW2 Mod.) | C |
| Bn | 5E (94) | 00/7F | | | Multi Purpose Ctrl7 (ASW/ASW = Foot SW) | C |
| Bn | 5F (95) | 00/7F | | | Multi Purpose Ctrl8 (ASW/ASW = Foot SW) | C |
| Bn | 60 (96) | vv | | | Multi Purpose Ctrl9 (Knob = MIDI CC#81) | C |
| Bn | 61 (97) | vv | | | Effect 1 Depth | C |
| Bn | 62 (98) | vv | | | (Knob/Pd1 = FX Off/On) | C |
| Bn | 63 (99) | vv | | | Effect 2 Depth | C |
| Bn | 64 (9A) | 00/7F | | | (Knob/Pd1 = FX Off/On) | C |
| Bn | 65 (9B) | 00/7F | | | Effect 3 Depth | C |
| Bn | 66 (9C) | 00/7F | | | (Knob/Pd1 = FX Off/On) | C |
| Bn | 67 (9D) | 00/7F | | | Effect 4 Depth | C |
| Bn | 68 (9E) | 00/7F | | | (Master FX1/2 Off/On) | C |
| Bn | 69 (9F) | 00/7F | | | Effect 5 Depth | C |
| Bn | 6A (A0) | 00/7F | | | (Total FX Off/On) | C |
| Bn | 6B (A1) | 00/7F | | | Control (cc)=0-119 (Sequencer data) | Q |
| Bn | 6C (A2) | 00/7F | | | Control (cc)=0-119 (Sequencer data) | Q |
| Bn | 6D (A3) | 00/7F | | | Control (cc)=0-119 (Knob = MIDI CC#00-119) | C |
| Bn | 6E (A4) | 00/7F | | | Control (cc)=0-119 (ARP Controllers = MIDI CC#00-119) | C |
| Bn | 6F (A5) | 00/7F | | | Program Change | *2 P |
| Ca | vv (vv) | -- | | | (Prog/Combi change) | Q |
| Da | vv (vv) | -- | | | Channel Pressure | Q |
| En | bb (bb) | bb | | | (After Touch) | Q |
| | | | | | (Joy Stick X) | C |

1-3 SYSTEM REALTIME MESSAGES

```

-----
| Status (Hex) | Description | Transmitted when |
-----
| F8 | Timing Clock | ( Always in Prog/Combi/Seq/Global mode ) *5 |
| FA | Start | ( START in Seq mode ) *5 |
| FB | Continue | ( Continue START in Seq mode ) *5 |
| FC | Stop | ( STOP in Seq mode ) *5 |
| FE | Active Sensing | ( Always ) *6 |
-----
*5 Transmits these messages when MIDI Clock in Global mode is Internal.
*6 Transmits this message when MIDI Clock in Global mode is External.

```

1-4 SYSTEM EXCLUSIVE

```

1-4-1 UNIVERSAL SYSTEM EXCLUSIVE MESSAGE ( NON REALTIME )
DEVICE INQUIRY REPLY ( Transmits when received a INQUIRY MESSAGE REQUEST )
[ F0,7E,05,06,02,42,15,01,mm,00,vv,ww,xx,00,F7 ] 3rd byte g : Global Channel
7th byte 15 : KROME series ID LSB
8th byte 01 : KROME series ID MSB
9th byte mm : KROME 73keys member code mm = 0E
10th byte vv : KROME 88keys member code vv = 17
11th byte ww : System Version 1st ( 1 - )
12th byte xx : System Version 2nd ( 0 - )
13th byte yy : System Version 3rd ( 0 - )
(d.e. Version 1.0.2 : vv=01, ww=00, xx=02 )

```

1-4-2 UNIVERSAL SYSTEM EXCLUSIVE MESSAGES (REALTIME)

```

3rd byte g : Global Channel
6th byte vv : Value (LSB)
7th byte mm,vv = 00,00 - 7F,7F : Min - Max

```

2. RECOGNIZED RECEIVE DATA

| 2-1 CHANNEL MESSAGES (Hex, D) : Decimal | | Description (Use) | | ENVA |
|---|-----------|---------------------------|--|------|
| (Hex) | (H) (D) | (H) (D) | | |
| 9h | kk (kk) | xx (xx) | Note Off | A |
| 9h | kk (kk) | vv (vv) | Note On (vv) = 1-127 | A |
| 9h | kk (kk) | vv (vv) | Poly Key Pressure (as AMS) | A |
| Bn | 00 (00) | mm (mm) | Bank Select(MSB) (for Prog/Combi change) | *1 P |
| Bn | 01 (01) | vv (vv) | Modulation (as Joy Stick *5) | C |
| Bn | 02 (02) | vv (vv) | Modulation2 (as Joy Stick *5) | C |
| Bn | 05 (05) | vv (vv) | Formamento Time (as AMS & FX Dmod Src = Foot Pedal) | C |
| Bn | 06 (06) | vv (vv) | Data Entry (MSB) (for RPC edit) | C |
| Bn | 07 (07) | vv (vv) | Volume (for Foot FX Pampot control) | *2 C |
| Bn | 08 (08) | vv (vv) | Balance Control | C |
| Bn | 0A (0A) | vv (vv) | Tempo | C |
| Bn | 0B (0B) | vv (vv) | Expression | C |
| Bn | 0C (0C) | vv (vv) | Effect Control 1 | C |
| Bn | 0C (0C) | vv (vv) | Effect Control 2 (as FX Dmod Src = FX Control) | C |
| Bn | 0E (0E) | vv (vv) | Multi Purpose Ctrl1 (as AMS & FX Dmod Src = Ribbon CC16) | C |
| Bn | 10 (10) | vv (vv) | Multi Purpose Ctrl2 (as AMS & FX Dmod Src = Knob Mod3) | C |
| Bn | 11 (11) | vv (vv) | Multi Purpose Ctrl3 (as AMS & FX Dmod Src = Knob Mod4) | C |
| Bn | 13 (13) | vv (vv) | Multi Purpose Ctrl4 (as AMS & FX Dmod Src = Knob Mod2) | C |
| Bn | 14 (14) | vv (vv) | Multi Purpose Ctrl5 (as AMS & FX Dmod Src = Knob Mod3) | C |
| Bn | 15 (15) | vv (vv) | (as AMS & FX Dmod Src = Knob Mod4) | C |
| Bn | 16 (16) | vv (vv) | (as ARP Knob1 GATE) | *4 C |
| Bn | 17 (17) | vv (vv) | (as ARP Knob2 GATE) | *4 C |
| Bn | 18 (18) | vv (vv) | (as ARP Knob3 STING) | *4 C |
| Bn | 19 (19) | vv (vv) | (as ARP Knob4 STEP) | *4 C |
| Bn | 20 (20) | bb (bb) | Bank Select(LSB) (for Prog / Combi change) | *1 P |
| Bn | 26 (26) | vv (vv) | Data Entry (LSB) (for RPC edit) | C |
| Bn | 40 (40) | vv (vv) | Hold | C |
| Bn | 41 (41) | vv (vv) | Statements Off/On (<=3F/>=40 (<=63/>=64) | C |
| Bn | 42 (42) | vv (vv) | Soft Pedal | C |
| Bn | 43 (43) | vv (vv) | Soft Pedal | C |
| Bn | 46 (46) | vv (vv) | Sound Controller 1 (for Sustain Level control) | C |
| Bn | 47 (47) | vv (vv) | Sound Controller 2 (for Resonance control) | C |
| Bn | 48 (48) | vv (vv) | Sound Controller 3 (for Release Time control) | C |
| Bn | 49 (49) | vv (vv) | Sound Controller 4 (for Filter Time control) | C |
| Bn | 4A (4A) | vv (vv) | Sound Controller 5 (for Filter Cutoff control) | C |
| Bn | 4B (4B) | vv (vv) | Sound Controller 6 (for Delay Time control) | C |
| Bn | 4C (4C) | vv (vv) | Sound Controller 7 (for LFO1 Speed control) | C |
| Bn | 4D (4D) | vv (vv) | Sound Controller 8 (for LFO1 Pitch Depth control) | C |
| Bn | 4E (4E) | vv (vv) | Sound Controller 9 (for LFO1 Delay control) | C |
| Bn | 4F (4F) | vv (vv) | Sound Controller 10 (for LFO1 Delay control) | C |
| Bn | 50 (50) | vv (vv) | Multi Purpose Ctrl6 (as AMS & FX Dmod Src = SW 1) | C |
| Bn | 51 (51) | vv (vv) | Multi Purpose Ctrl7 (as AMS & FX Dmod Src = SW 2) | C |
| Bn | 52 (52) | vv (vv) | Multi Purpose Ctrl8 (as AMS & FX Dmod Src = Foot Switch) | C |
| Bn | 53 (53) | vv (vv) | (as AMS & FX Dmod Src = CC#83) | C |
| Bn | 55 (55) | vv (vv) | (as AMS & FX Dmod Src = CC#85) | C |
| Bn | 57 (57) | vv (vv) | (as AMS & FX Dmod Src = CC#87) | C |
| Bn | 58 (58) | vv (vv) | (as AMS & FX Dmod Src = CC#88) | C |
| Bn | 5B (5B) | vv (vv) | Effect 1 Depth (for Send 2 Level control) | C |
| Bn | 5C (5C) | 00/1-00 | Effect 2 Depth (for All Inset EX Off/On) | C |
| Bn | 5D (5D) | 00/0-00 | Effect 3 Depth (for Send 1 Level control) | C |
| Bn | 5E (5E) | 00/0-00 | Effect 4 Depth (for All Inset EX Off/On) | C |
| Bn | 5F (5F) | 00/1-00 | Effect 5 Depth (for Total FX Off/On) | C |
| Bn | 60 (60) | 00 (00) | Data Increment (for RPC edit) | C |
| Bn | 61 (61) | 00 (00) | Data Decrement (for RPC edit) | C |
| Bn | 64 (64) | 0r (0r) | RPN Param No. (LSB) (for RPN select) | *3 C |
| Bn | 65 (65) | 00 (00) | RPN Param No. (MSB) (for RPN select) | *3 C |
| Bn | 78 (78) | 00 (00) | All Sound Off | C |
| Bn | 79 (79) | 00 (00) | Reset All Controllers | C |
| Bn | 7A (7A) | 00/7F (00/127) | Local Control Off/On | A |
| Bn | 7B (7B) | 00 (00) | All Notes Off | A |
| Bn | 7C (7C) | 00 (00) | Omni Mode Off | A |
| Bn | 7D (7D) | 00 (00) | Omni Mode On | A |
| Bn | 7E (7E) | <=16 (<=16) | Memo Mode On | A |
| Bn | 7F (7F) | <=40 (<=40) | Poly mode On | A |
| Cn | pp (pp) | -- -- | Program Change (for Prog/Combi change) | *1 P |
| En | bb (bb) | bb (bb) | Channel Pressure (as After Touch) | C |
| En | bb (bb) | bb (bb) | Banker Change | C |

AMS : Alternate Modulation Source
 FX Dmed Src : Effect Dynamic Modulation Source
 n : MIDI Channel No. (0 - 15) Usually Global Channel.
 g : When in Combination/Sequencer mode, each timbre's/track's channel. (Status is INT or BTH)
 x : Always Global Channel No. (0 - 15)
 ENA : Random
 : Same as Transmitted data

*1 : When Bank Map in Global mode is KORG;

| | | | |
|----------|--------------|--|--------------------------------|
| MIDI In | [Hex] | Program | Combination |
| mm,bb,pp | 00,00, 00-7F | : Bank A 000 - 127 : Bank B 000 - 127 | A 000 - 127 : Bank C 000 - 127 |
| | 00,01, 00-7F | : Bank B 000 - 127 : Bank C 000 - 127 | D 000 - 127 |
| | 00,02, 00-7F | : Bank C 000 - 127 : Bank D 000 - 127 | E 000 - 127 |
| | 00,03, 00-7F | : Bank D 000 - 127 : Bank E 000 - 127 | F 000 - 127 |
| | 00,04, 00-7F | : Bank E 000 - 127 : Bank F 000 - 127 | GM 001 - 128 |
| | 00,05, 00-7F | : Bank F 000 - 127 : Bank GM 001 - 128 | g(1)-g(4) 001 - 128 |
| | 79,00, 00-7F | : g(1)-g(4) 001 - 128 | g(4) 001 - 128 |
| | 79,01, 00-7F | : g(1)-g(4) 001 - 128 | GM 001 - 128 |
| | 38,00, 00-7F | : GM 001 - 128 | g(4) 001 - 128 |
| | 38,01, 00-7F | : GM 001 - 128 | |
| | 3E,00, 00-7F | : g(4) 001 - 128 | |

When Bank Map in Global mode is GM(2) :

| | | | |
|----------|-----------------|--|---------------------|
| MIDI In | [Hex] | Program | Combination |
| mm,bb,pp | 3E,00, 00-7F | : Bank A 000 - 127 : Bank B 000 - 127 | A 000 - 127 |
| | 3E,01, 00-7F | : Bank B 000 - 127 : Bank C 000 - 127 | C 000 - 127 |
| | 3E,02, 00-7F | : Bank C 000 - 127 : Bank D 000 - 127 | D 000 - 127 |
| | 3E,03, 00-7F | : Bank D 000 - 127 : Bank E 000 - 127 | E 000 - 127 |
| | 3E,04, 00-7F | : Bank E 000 - 127 : Bank F 000 - 127 | F 000 - 127 |
| | 3E,05, 00-7F | : Bank F 000 - 127 : Bank GM 001 - 128 | GM 001 - 128 |
| | 79,00, 00-7F | : GM 001 - 128 | g(1)-g(9) 001 - 128 |
| | 79,01-09, 00-7F | : g(1)-g(9) 001 - 128 | g(10) 001 - 128 |
| | 90,00, 00-7F | : g(10) 001 - 128 | GM 001 - 128 |
| | 90,01, 00-7F | : GM 001 - 128 | g(10) 001 - 128 |
| | 3E,00, 00-7F | : g(10) 001 - 128 | |
| | 3E,01, 00-7F | : g(10) 001 - 128 | |
| | 3E,7F, 00-7F | : Note (KORG MUTE) | |

*2 : When in Program mode, Global channel.
 When in Combination/Sequencer mode, each IFX's channel.

*3 : * = 0 : Pitch Bend Sensitivity (Bend Range)
 = 1 : Fine Tune (Detune)
 = 2 : Coarse Tune (Transpose)

For drum program, both of Fine Tune and Coarse Tune affect to Detune.
 Data Entry LSB value has no effect for Pitch Bend Sensitivity and Coarse Tune.

*4 : When Ctl by "cc Default" is assigned to the ARP Controllers in Global Mode.
 n : When Proc/Combination/Global Channel's channel's channel.
 When in Sequencer mode, current selected track's channel.

2-2 SYSTEM COMMON MESSAGES

| | | | |
|--------|---------|---------|---------------------------------------|
| Status | Second | Third | [H] : Hex, [D] : Decimal |
| [Hex] | [H] [D] | [H] [D] | Description (Use for) |
| E2 | ss (ss) | tt (tt) | Song Position Pointer (Location) *6 |
| | | | ss : least significant (LSB) |
| | | | tt : Most significant (MSB) |
| E3 | ss (ss) | | Song Select (Song or Cue list select) |
| | | | ss : Song(0-127) No. |

Receive when in Sequencer mode.

2-3 SYSTEM REALTIME MESSAGES

| | | |
|--------|-------|--|
| Status | [Hex] | Description (Use for) |
| FB | | Fading Clock (Tempo, AMS & FX Dmed Src) *5 |
| FA | | Start (Seq Start & Arpeggiator Control) *6 |
| FB | | Continue (Seq Continue start & Arpeggiator Control) *6 |
| FC | | Stop (Seq Stop & Arpeggiator Control) *6 |
| FE | | Active Sensing (MIDI Connect check) |

*5 : Receive when MIDI Clock in Global mode is External MIDI.
 *6 : Receive when MIDI Clock in Global mode is External MIDI.
 and Receive Ext. Realtime Commands in Global mode is checked.

2-4 SYSTEM EXCLUSIVE

2-4-1 UNIVERSAL SYSTEM EXCLUSIVE MESSAGE (NON REALTIME)
 DEVICE INQUIRY (When received this message, transmits INQUIRY MESSAGE REPLY)
 [F0,7E,mm,05,01,F7] 3rd byte mm : Channel = 0 - F : Global Channel
 = 7F : Any Channel

GM System On (Receive when in Sequencer mode)
 [F0,7E,mm,09,01,F7] 3rd byte mm : Channel = 0 - F : Global Channel
 = 7F : Any Channel

2-4-2 UNIVERSAL SYSTEM EXCLUSIVE MESSAGES (REALTIME)

Master Volume
 [F0,7E,09,04,01,vv,mm,F7] 3rd byte g : Global Channel
 4th byte mm : Value (LSB)
 5th byte mm : Value (MSB)
 7th byte mm : Value (MSB)
 mm,vv = 00,00 - 7E,7F : Min - Max

Master Balance

[F0,7E,09,04,02,vv,mm,F7] 3rd byte g : Global Channel
 4th byte vv : Value (LSB)
 5th byte mm : Value (MSB)
 mm,vv = 00,00:left, 40,00:center, 7E,7F:right

Master Fine Tune (Control Master Tune (cent) in Global)

[F0,7E,09,04,03,vv,mm,F7] 3rd byte g : Global Channel
 4th byte vv : Value (LSB)
 5th byte mm : Value (MSB)
 mm,vv = 20,00:-50, 40,00:+00, 60,00:+50

Master Coarse Tune (Control Transpose (chromatic step) in Global)

[F0,7E,09,04,04,vv,mm,F7] 3rd byte g : Global Channel
 4th byte vv : Value (LSB)
 5th byte mm : Value (MSB)
 7th byte mm : Value (MSB)
 mm,vv = 34,00:-12, 40,00:+00, 4C,00:+12

IMPORTANT NOTICE TO CONSUMERS

This product has been manufactured according to strict specifications and voltage requirements that are applicable in the country in which it is intended that this product should be used. If you have purchased this product via the internet, through mail order, and/or via a telephone sale, you must verify that this product is intended to be used in the country in which you reside.

WARNING: Use of this product in any country other than that for which it is intended could be dangerous and could invalidate the manufacturer's or distributor's warranty.

Please also retain your receipt as proof of purchase otherwise your product may be disqualified from the manufacturer's or distributor's warranty.

KORG KORG INC.

4015-2 Yanokuchi, Inagi-city, Tokyo 206-0812 Japan