



Getting Started

Mbox 2™

Version 7.0



Copyright

© 2005 Digidesign, a division of Avid Technology, Inc. All rights reserved. This guide may not be duplicated in whole or in part without the express written consent of Digidesign.

Avid, Digidesign, Mbox 2, and Pro Tools are either trademarks or registered trademarks of Avid Technology, Inc. in the US and other countries. All other trademarks contained herein are the property of their respective owners.

Product features, specifications, system requirements, and availability are subject to change without notice.

PN 9320-17750-00 REV A 10/05

Communications and Safety Regulation Information

Compliance Statement

This model Digidesign Mbox 2 complies with the following standards regulating interference and EMC:

- FCC Part 15 Class B
- EN 55022
- EN 55204
- AS/NZS 3548 Class B
- CISPR 22 Class B

Radio and Television Interference

This equipment has been tested and found to comply with the limits for a Class B digital device, pursuant to Part 15 of the FCC Rules.

DECLARATION OF CONFORMITY

We Digidesign,

2001 Junipero Serra Boulevard, Suite 200

Daly City, CA 94014 USA

tel: 650-731-6300

declare under our sole responsibility that the product Mbox 2

complies with Part 15 of FCC Rules.

Operation is subject to the following two conditions: (1) this device may not cause harmful interference, and (2) this device must accept any interference received, including interference that may cause undesired operation.

NOTE: This equipment has been tested and found to comply with the limits for a Class B digital device, pursuant to Part 15 of the FCC Rules. These limits are designed to provide reasonable protection against harmful interference in a residential installation. This equipment generates, uses, and can radiate radio frequency energy and, if not installed and

used in accordance with the instructions, may cause harmful interference to radio communications. However, there is no guarantee that interference will not occur in a particular installation. If this equipment does cause harmful interference to radio or television reception, which can be determined by turning the equipment off and on, the user is encouraged to try and correct the interference by one or more of the following measures:

- Reorient or locate the receiving antenna.
- Increase the separation between the equipment and receiver.
- Connect the equipment into an outlet on a circuit different from that to which the receiver is connected.
- Consult the dealer or an experienced radio/TV technician for help.

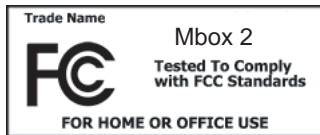

Any modifications to the unit, unless expressly approved by Digidesign, could void the user's authority to operate the equipment.

Canadian Compliance Statement:

This Class B digital apparatus complies with Canadian ICES-003.

Cet appareil numérique de la classe B est conforme à la norme NMB-003 du Canada.

Australian Compliance

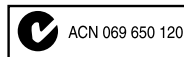

European Compliance





This symbol on the product or its packaging indicates that this product must not be disposed of with other waste. Instead, it is your responsibility to dispose of your waste equipment by handing it over to a designated collection point for the recycling of waste electrical and electronic equipment. The separate collection and recycling of your waste equipment at the time of disposal will help conserve natural resources and ensure that it is recycled in a manner that protects human health and the environment. For more information about where you can drop off your waste equipment for recycling, please contact your local city recycling office or the dealer from whom you purchased the product.

contents

Chapter 1. Welcome to Mbox 2	1
Mbox 2 Package	1
Mbox 2 Features	2
Pro Tools LE Capabilities	2
System Requirements	3
Digidesign Registration	5
About the Pro Tools Guides	5
About www.digidesign.com	6
Chapter 2. Windows Configuration	7
Installation Overview	7
Windows System Optimization	7
Hard Drive Configuration and Maintenance	10
Installing Pro Tools LE and Mbox 2	12
Optional Software on the Pro Tools Installer CD	13
Launching Pro Tools LE	14
Configuring Pro Tools LE	15
Removing Pro Tools LE	18
Chapter 3. Macintosh Configuration	19
Installation Overview	19
Macintosh System Optimization	19
Hard Drive Configuration and Maintenance	21
Installing Pro Tools LE	21
Optional Software on the Pro Tools Installer CD	22
Connecting Mbox 2 to the Computer	22
Launching Pro Tools LE	22
Configuring Pro Tools LE	23
Removing Pro Tools LE	26

Chapter 4. Mbox 2 Hardware and Connections	27
Mbox 2 Front Panel Features	29
Mbox 2 Back Panel Features	32
Making Signal Connections to Mbox 2	33
Chapter 5. Working with Pro Tools LE	37
Session Basics	37
Transport Controls	43
Tracks	44
Region List	47
Navigating in a Session	48
Importing Data into Pro Tools Sessions	51
Basic Recording	53
Editing	57
Mixing	61
Plug-Ins	63
Mix Automation	64
Final Mixdown	65
Appendix A. Configuring MIDI Studio Setup (Windows Only)	67
MIDI Studio Setup	67
MIDI Patch Name Support	69
Appendix B. Configuring AMS (Mac OS X Only)	71
Audio MIDI Setup	71
MIDI Patch Name Support	73
Appendix C. Troubleshooting	75
Backing Up Your Work	75
Common Issues	75
Performance Factors	76
Before You Call Digidesign Technical Support	76
Index	79

chapter 1

Welcome to Mbox 2

Welcome to Mbox 2, Digidesign's portable Pro Tools micro-studio.

Mbox 2 provides your USB-equipped computer with two channels of analog audio input and output, two channels of digital audio input and output, MIDI In and Out ports, analog monitor outs, and a headphone output with front panel level control. Mbox 2 provides professional-quality mic preamps and 24-bit analog-to-digital and digital-to-analog converters.

Mbox 2 Package

The Mbox 2 package includes the following:

- Mbox 2 desktop audio interface
- Installer CDs containing Pro Tools LE software, DigiRack RTAS (Real-Time AudioSuite) and AudioSuite plug-ins, optional software, and electronic PDF guides
- This *Mbox 2 Getting Started Guide*, which includes instructions for installing and configuring Mbox 2, and an introduction to Pro Tools LE software
- The *Mbox 2 Basics Guide*, designed to give new users specific methods for accomplishing common tasks (such as getting sound in and out of your Mbox 2, connecting a mic or instrument, and recording a session)
- USB connector cable
- Digidesign registration card

Mbox 2 Features

The Mbox 2 provides the following:

- Two channels of analog audio input with microphone preamps and switchable 48V phantom power
 - Analog input jacks include one XLR and two 1/4-inch connectors (one TRS, one TS), with switchable Mic, Line, and DI levels
 - -20 dB pad available separately on each analog input channel
- Two channels of S/PDIF digital input and output
 - S/PDIF inputs are available independently, in addition to analog inputs 1–2
 - S/PDIF outputs mirror analog outs 1–2
- Up to a total of four channels of input, using analog and digital inputs simultaneously
- One MIDI In and one MIDI Out port, providing 16 MIDI input channels and 16 MIDI output channels
- Two 1/4-inch TRS analog monitor outputs
- 24-bit A/D and D/A converters, supporting sample rates of 44.1 kHz and 48 kHz
- Zero-latency analog record monitoring with adjustable balance between input and playback
- Mono switch for enhanced monitoring of single-channel input sources (does not affect recording)
- 1/4-inch (TRS) stereo headphone output with adjustable level control
- USB-powered operation

 *Mbox 2 will not function properly if connected to a passive USB hub. If you need to use a hub for other USB peripherals, use a powered hub or a separate dedicated USB port for Mbox 2 to function properly.*

Pro Tools LE Capabilities

Pro Tools LE 7.0 on Windows or Macintosh provides the following capabilities with Mbox 2:

- Playback of up to 32 mono digital audio tracks, and of playback up to 28 tracks while recording up to 4 tracks, depending on your computer's capabilities
- Up to 128 audio tracks (with 32 voiceable tracks maximum), 128 Auxiliary Input tracks, 64 Master Fader tracks, 256 MIDI tracks, and 32 Instrument tracks per session
- 16-bit or 24-bit audio resolution, at sample rates up to 48 kHz
- Non-destructive, random-access editing and mix automation
- Audio processing with up to 5 RTAS plugins per track, depending on your computer's capabilities
- Up to 5 inserts per track
- Up to 10 sends per track
- Up to 32 internal mix busses

 *Pro Tools LE uses your computer's CPU to mix and process audio tracks (host processing). Computers with faster clock speeds yield higher track counts and more plug-in processing.*

System Requirements

Mbox 2 can be used with a Digidesign-qualified Windows or Macintosh computer running Pro Tools LE software.

For complete system requirements, visit the compatibility page of the Digidesign Web site (www.digidesign.com/compato).

Compatibility Information

Digidesign can only assure compatibility and provide support for hardware and software it has tested and approved.

For a list of Digidesign-qualified computers, operating systems, hard drives, and third-party devices, refer to the latest compatibility information on the Digidesign Web site (www.digidesign.com/compato).

MIDI Requirements

Mbox 2 includes one MIDI In port and one MIDI Out port, providing 16 channels of MIDI input and 16 channels of MIDI output.

If you require additional MIDI ports, add a MIDI interface to your system.

USB MIDI interfaces work effectively with Pro Tools systems on Windows or Macintosh. Serial MIDI interfaces are supported on Windows systems only.

⚠ *Only USB MIDI interfaces are compatible with Pro Tools systems for Mac OS X. Modem-to-serial port adapters and serial MIDI devices are not supported.*

For a list of supported adapters, refer to the Digidesign Web site (www.digidesign.com).

Hard Drive Requirements

For a list of qualified hard drives, see our Web site (www.digidesign.com/compato).

If you are using an ATA/IDE or FireWire hard drive, initialize your drive with Windows Disk Management (Windows) or the Disk Utility application included with Apple System software (Macintosh).

Avoid Recording to the System Drive

Recording to your system drive is not recommended. Recording and playback on a system drive may result in lower track counts and fewer plug-ins.

⚠ *Digidesign does not recommend recording to the system drive. Record to a system drive only when necessary.*

Hard Disk Storage Space

Mono audio tracks recorded with 16-bit resolution at 44.1 kHz (CD quality) require approximately 5 MB of hard disk space per minute. The same tracks recorded with 24-bit resolution require about 7.5 MB per minute.

Stereo audio tracks recorded with 16-bit resolution at 44.1 kHz (CD quality) require approximately 10 MB of hard disk space per minute. The same tracks recorded with 24-bit resolution require about 15 MB per minute.

Table 2 lists the required disk space for certain track numbers and track lengths, to help you estimate your hard disk usage.

Table 2. Required hard drive space for audio tracks

Number of tracks and length	16-bit at 44.1 kHz	16-bit at 48 kHz	24-bit at 44.1 kHz	24-bit at 48 kHz
1 mono track, 1 minute	5 MB	5.5 MB	7.5 MB	8.2 MB
1 stereo track (or two mono tracks), 5 minutes	50 MB	55 MB	75 MB	83 MB
1 stereo track (or two mono tracks), 60 minutes	600 MB	662 MB	900 MB	991 MB
24 mono tracks, 5 minutes	600 MB	662 MB	900 MB	991 MB
24 mono tracks, 60 minutes	7 GB	7.8 GB	10.5 GB	11.6 GB
32 mono tracks, 5 minutes	800 MB	883 MB	1.2 GB	1.3 GB
32 mono tracks, 60 minutes	9.4 GB	10.4 GB	14 GB	15.4 GB

Digidesign Registration

Review the enclosed registration information card and follow the instructions on it to quickly register your purchase online. Registering your purchase is the only way you can be eligible to receive complimentary technical support and future upgrade offers. It is one of the most important steps you can take as a new user.

About the Pro Tools Guides

This *Getting Started with Mbox 2 Guide* explains how to install and use Mbox 2 to record, edit, and mix audio and MIDI tracks in Pro Tools LE.

If you are new to working with digital workstations, it is recommended that you read the following:

- *Mbox 2 Basics Guide* provides simple steps for getting sound in and out of your Mbox 2, connect a microphone or instrument, record to a Pro Tools session, import audio from a CD, create an audio CD from a Pro Tools session, and other topics.

For additional information, see the following online (PDF) guides:

- *Pro Tools Reference Guide* explains Pro Tools LE software in detail.
- *Pro Tools Menus Guide* covers all the Pro Tools on-screen menus.
- *DigiRack Plug-Ins Guide* explains how to use the RTAS and AudioSuite plug-ins included with Pro Tools LE.
- *Digidesign Plug-Ins Guide* explains how to use optional Digidesign plug-ins.
- *DigiBase Guide* provides details on using Pro Tools DigiBase databasing and browsers for data and media management.
- *Pro Tools Keyboard Shortcuts* lists keyboard shortcuts for Pro Tools LE.

PDF versions of the Pro Tools guides are installed automatically with Pro Tools LE, and are accessible from the Pro Tools Help menu. To view or print the PDF guides, you can use Adobe Reader or Apple Preview.



Printed copies of the Pro Tools Reference Guide and other guides in the Pro Tools guide set can be purchased separately from the DigiStore (www.digidesign.com).

Conventions Used in This Guide

Digidesign guides use the following conventions to indicate menu choices and key commands:

Convention	Action
File > Save	Choose Save from the File menu
Control+N	Hold down the Control key and press the N key
Control-click	Hold down the Control key and click the mouse button
Right-click (Windows)	Click with the right mouse button

The following symbols are used to highlight important information:



User Tips are helpful hints for getting the most from your Pro Tools system.



Important Notices include information that could affect your data or the performance of your system.



Shortcuts show you useful keyboard or mouse shortcuts.



Cross References point to related sections in other Digidesign guides.

About www.digidesign.com

The Digidesign Web site (www.digidesign.com) is your best source for information to help you get the most out of your Pro Tools system. The following are just a few of the services and features available.

Registration Register your purchase online. See the enclosed registration form for instructions.

Support Contact Digidesign Technical Support or Customer Service; download software updates and the latest online manuals; browse the Compatibility documents for system requirements; search the online Answerbase; join the worldwide Pro Tools community on the Digidesign User Conference.

Training and Education Become a certified Pro Tools Operator or Expert; study on your own using courses available online, or find out how you can learn in a classroom setting at a certified Pro Tools Training Center.

Products and Developers Learn about Digidesign products; download demo software; learn about our Development Partners and their plug-ins, applications, and hardware.

News and Events Get the latest news from Digidesign; sign up for a Pro Tools demo.

To learn more about these and other resources available from Digidesign, visit the Digidesign Web site (www.digidesign.com).

chapter 2

Windows Configuration

This chapter contains information for Windows systems only. If you are installing Pro Tools on a Macintosh computer, see Chapter 3, “Macintosh Configuration.”

▲ *Before installing this version of Pro Tools, refer to the Read Me information included on the Pro Tools LE Installer CD.*

Installation Overview

Installing the Mbox 2 on a Windows computer includes the following steps:

- 1 “Windows System Optimization” on page 7.
- 2 “Installing Pro Tools LE and Mbox 2” on page 12.
- 3 “Launching Pro Tools LE” on page 14.
- 4 “Configuring Pro Tools LE” on page 15.
- 5 Making audio and MIDI connections to the Mbox 2. (See Chapter 4, “Mbox 2 Hardware and Connections” for details.)

Windows System Optimization

Before configuring your computer, make sure you are logged in as an Administrator for the account where you want to install Pro Tools. For details on Administrator privileges, refer to your Windows documentation.

Required Optimizations

To ensure optimum performance with Pro Tools LE, configure the following settings before you install Pro Tools hardware and software.

▲ *When you are finished changing Windows system settings, restart your computer.*

Enabling DMA

Enabling your computer's DMA (Direct Memory Access) frees up CPU bandwidth so the computer can do other Pro Tools tasks.

In most cases the DMA option will already be set correctly, as Windows XP detects and activates DMA mode by default.

To enable DMA for any IDE hard drives:

- 1 Choose Start > Control Panel.
- 2 In Classic View, double-click System.
- 3 Click the Hardware tab.
- 4 Under Device Manager, choose Device Manager.
- 5 In the Device Manager window, double-click IDE ATA/ATAPI controllers, then double-click the Primary IDE Channel for your IDE hard drive.
- 6 Click the Advanced Settings tab.
- 7 For each device, set the Transfer Mode to "DMA if available," and click OK.
- 8 Repeat steps 5–7 for any additional IDE Channels.
- 9 Close the Computer Management window.

Disabling System Standby and Power Management

When using Pro Tools, the Windows System Standby power scheme must be set to Always On. This helps prevent long record or playback passes from stopping due to system resources powering down.

To configure Windows Power Management:

- 1 Choose Start > Control Panel.
- 2 Double-click Power Options.
- 3 Click the Power Schemes tab.
- 4 From the Power Schemes pop-up menu, select Always On.
- 5 Click OK.

This sets System Standby, System Hibernate, and "Turn off hard disks" to Never.



On AMD processors, be sure to check and disable Cool N'Quiet in the System BIOS (in the Cool & Quiet Configuration section). Refer to the manufacturer's documentation for instructions on disabling this power option, if necessary.

Disabling ClearType Font Smoothing

When using Pro Tools, the Effects "Clear Type" setting must be disabled.

To disable ClearType font smoothing:

- 1 Choose Start > Control Panel.
- 2 Double-click Display.
- 3 Click the Appearance tab.
- 4 Click Effects.
- 5 Deselect "Use the following method to smooth edges of screen fonts."
- 6 Click OK to save your settings and close the Effects dialog.
- 7 Click OK.
- 8 Restart the computer.

Recommended Optimizations

Pro Tools can also be affected by other software and hardware drivers installed on your computer. It is recommended (but not required) that you do the following:

- Avoid running any unneeded programs at the same time as Pro Tools.
- Turn off any software utilities that run in the background, such as Windows Messenger, calendars, and disk maintenance programs.
- Turn off any nonessential USB devices while running Pro Tools.
- If your video display card supports it, enable Bus Mastering in the manufacturer's Control Panel. Refer to the manufacturer's instructions for details.

Optional Optimizations

The following system optimizations may help Pro Tools perform better on some systems. It is recommended that you only try these optimizations if necessary, as they may disable or adversely affect the functionality of other programs on your system.

Disabling Network Cards

If applicable, disable any networking cards (other than a FireWire card that you might use to connect an external drive to your system).

To disable a network card:

- 1 Right-click My Computer and choose Manage.
- 2 Under System Tools, select Device Manager.
- 3 In the Device Manager window, double-click Network adapters, then double-click the Network Adapter card you want to disable.

4 Under the General tab, choose "Do not use this device (disable)" from the Device Usage pop-up menu, and click OK.

5 Close the Computer Management window.

Adjusting Processor Scheduling

To Adjust Processor Scheduling Performance:

1 Choose Start > Control Panel.

2 In Classic View, double-click System.

3 Click the Advanced tab.

4 Under the Performance section, click the Settings button.

5 In the Performance Options window, click the Advanced tab.

6 Under the Processor scheduling section, select the Background Services option.

7 Under the Memory Usage section, select the System cache option.

8 Click OK to close the Performance Options window.

9 Click OK to close the System Properties window.

10 Restart the computer for the changes to take effect.

Disabling Hyper-Threading

Pro Tools LE 7.0 takes advantage of the added processing power of computers that have multiple processors, or that feature multi-core processing or Hyper-Threading, for RTAS processing.

However, if you set the number of processors available for RTAS processing to 1 (in the Pro Tools Playback Engine dialog), some computers with hyperthreading capability may experience decreased performance.

If this occurs, you can increase the number of RTAS processors in the Playback Engine dialog, or you can disable Hyper-Threading on the computer.

Refer to your computer's documentation for steps on how to enter the computer's BIOS and disable Hyper-Threading.

Disabling System Startup Items

The fewer items in use by your computer, the more resources are available for Pro Tools. Some startup applications may be consuming unnecessary CPU resources, and should be turned off.

If you disable any of the following startup items, do so carefully:

- Portable media serial number (required for applications that utilize a copy protection key)
- Plug and play
- Event log
- Cryptographic services
- DHCP Client, TCP/IP Net BIOS, and other networking-related items (unless the computer has no network or internet connection, in which case these items can be disabled)

To Disable System Startup Items:

- 1 From the Start menu, choose Run.
- 2 Type "msconfig" and click OK. The System Configuration Utility opens.
- 3 Under the General tab, choose Selective Startup.
- 4 Deselect Load Startup Items and click OK.
- 5 Click Restart to restart the computer.
- 6 After restarting, the computer displays a System Configuration message. Check to see if Pro Tools performance has increased before you deselect the "Don't show this message again" option. If performance has not changed, run "msconfig" and return your computer Selective Startup back to Normal Startup. Alternatively, try disabling Startup items and non-essential processes individually.

Hard Drive Configuration and Maintenance

It is recommended that you start with a newly initialized audio drive. You should also periodically defragment your audio drive to ensure continued system performance.

 *Always back up any important data on your drive before initializing it, as it will erase all data on the drive.*

Avoid Recording to the System Drive

Recording to your system drive is not recommended. Recording and playback on a system drive may result in lower track counts or fewer plug-ins.

Formatting an Audio Drive

For optimum performance, audio drives should be formatted as FAT32 or NTFS.

To format an audio drive:

- 1 Right-click My Computer and choose Manage.
- 2 Under Storage, choose Disk Management.

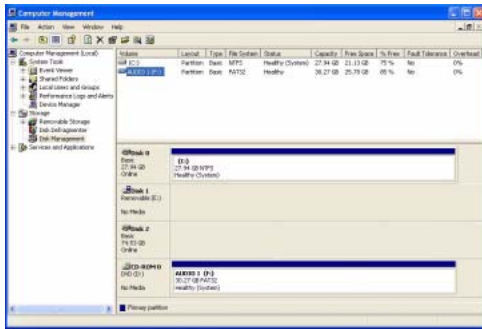

Disk Management window (Windows XP)

3 In the Disk Management window, right-click the hard drive you will use for audio and choose Format.

4 Do one of the following:

- Select the Quick Format option. Quick option should be sufficient for qualified mechanisms.

– OR –

- For optimal disk performance, you can select 32K from the Allocation unit size pop-up menu (make sure Quick Format is not selected). Though this option takes longer to complete, it can increase efficiency of drive recording and playback.

5 Click Start, and follow the on-screen instructions.

A *Pro Tools only supports Basic drive Types.*

6 When formatting is complete, close the Format window.

Audio Drives and Disk Cleanup

The process of recording and editing can quickly decrease overall drive performance. It is suggested that you regularly use Disk Cleanup (or an equivalent utility) to assess the condition of drives and, if necessary, delete temporary files and other unused data.

To use Disk Cleanup:

- 1 Choose Start > Control Panel.
- 2 Double-click Administrative Tools.
- 3 Double-click Computer Management.
- 4 Double-click Storage.
- 5 Double-click Disk Management.
- 6 Select the desired volume in the list, then choose File > Options.

Disk Cleanup determines how performance is being affected by drive conditions, and lets you review and delete unnecessary files from the selected volume. For more information, see your Windows XP documentation.

Defragmenting an Audio Drive

Periodically *defragment* audio drives to maintain system performance.

To defragment an audio drive:

- 1 Right-click My Computer and choose Manage.
- 2 Under Storage, choose Disk Defragmenter.
- 3 In the Disk Defragmenter window, choose the drive you want to defragment

4 Click the Defragment button and follow the on-screen instructions.

5 When defragmenting is complete, close the Computer Management window.

Installing Pro Tools LE and Mbox 2

To install Pro Tools LE:

1 Start Windows, logging in with Administrator privileges. For details on Administrator privileges, refer to your Windows documentation.

2 Connect the small end of the included USB cable to the USB port on Mbox 2.

⚠ *Mbox 2 may not function properly if connected to a USB hub. If you need to use a hub for other USB peripherals, connect the hub to a separate USB port; Mbox 2 must have a dedicated port in order to function properly.*

3 Connect the other end of the USB cable to any available USB port on your computer. Wait for the Found New Hardware Wizard dialog to appear and leave it open: Do not click Next.

4 Insert the Pro Tools LE Installer CD for Windows in your CD-ROM drive. Locate and open the Pro Tools Installer folder, and double-click the Setup icon.

5 Click Next to begin installation.

6 Select the install location. For maximum reliability, install Pro Tools on your startup drive. Click Next.

7 Select any options you want to install. For more information, see “Optional Software on the Pro Tools Installer CD” on page 13.

8 Click Next.

⚠ *If you get a warning dialog about the driver not passing Windows Logo testing, click Continue Anyway.*

9 Wait for the installer to finish installing all software components, drivers, and PACE System files before proceeding to the next step.

10 When installation is complete, click Finish.

Installing QuickTime

QuickTime 6.5 or later is required for Pro Tools if you plan to include movie files, or import MP3 or MP4 (AAC) files in your sessions. QuickTime for Windows XP is available as a free download from the Apple Web site (www.apple.com).

To install QuickTime:

1 Visit www.apple.com and go to the QuickTime page.

2 Download the QuickTime installer application to your computer.

3 Double-click the QuickTime installer application and follow the on-screen installation instructions.

4 Restart your computer.

⚠ *If the USB LED on the front panel of the Mbox 2 does not illuminate after installation, try unplugging the USB cable from the Mbox 2 USB port, and plugging it back in. If the USB LED still does not illuminate, shut down the computer, disconnect Mbox 2 and start the computer. Once the computer has fully restarted, reconnect Mbox 2.*

Optional Software on the Pro Tools Installer CD

Your Pro Tools Installer CD includes several software options.

Digidesign ASIO Driver

The Digidesign ASIO (Audio Sound Input Output) Driver is a single-client multichannel sound driver that allows third-party audio programs that support the ASIO standard to record and play back through Digidesign hardware.

The Digidesign ASIO Driver is automatically installed when you install Pro Tools.

 *For detailed information on configuring the Digidesign ASIO Driver, see the Digidesign ASIO Guide.*

 *To use the Digidesign ASIO Driver without Pro Tools, you can install the standalone version of the Digidesign ASIO Driver, available on the Digidesign Web site (www.digidesign.com).*

Digidesign WaveDriver

The Digidesign WaveDriver is a single-client, stereo sound driver that allows third-party audio programs that support the WaveDriver MME (Multimedia Extension) standard to play back through Digidesign hardware.

The Digidesign WaveDriver is automatically installed when you install Pro Tools.

 *For detailed information on configuring the Digidesign WaveDriver, see the Digidesign WaveDriver Guide.*

 *To use the Digidesign WaveDriver without Pro Tools, you can install the standalone version of the Digidesign WaveDriver, available on the Digidesign Web site (www.digidesign.com).*

Digidesign Ethernet Software for Control Surface Support

Control|24 Only

If you plan to use a Control|24 with your system, you will need to install the Digidesign Ethernet software.

To install Digidesign Ethernet software:

- 1 Click Start, right-click My Network Places, and then choose Properties.
- 2 Right-click the relevant Local Area Connection icon, and then choose Properties.
- 3 Click Install, select Protocol, and click Add.
- 4 Click Have Disk.
- 5 Select the DigiNet.inf file (on your Pro Tools Installer CD, in the Controllers folder), and click OK.

The Installer installs the DigiNet.inf files in the Program Files\Common Files\Digidesign\DAE\Controllers folder.

- 6 Click Close.

Pro Tools Demo Session

The Pro Tools LE Installer CD includes a demo session that you can use to verify that your system is working.

⚠ *Before installing the demo session to your audio drive, make sure the drive is configured as described in “Formatting an Audio Drive” on page 11.*

To install the demo session:

- 1 Insert the Pro Tools LE Installer CD into your CD-ROM drive.
- 2 From your CD-ROM drive, locate and open the Additional Files/Pro Tools LE Demo Session Installer folder.
- 3 Double-click Setup.exe.
- 4 Select your audio drive as the install location and click Install.
- 5 When installation is complete, click OK.

MacDrive

The MacDrive utility lets you mount Macintosh-based HFS+ drives on a Windows-based Pro Tools system and use them as Transfer drives.

⚠ *Transfer drives can be used for storage, but not for playback or recording. To use Mac-based audio files on a Windows Pro Tools system, copy the files from the Mac-based HFS+ audio drive to a Windows-based NTFS audio drive.*

To install the MacDrive demo included with Pro Tools:

- 1 Insert the Pro Tools Installer CD into your CD-ROM drive.
- 2 From your CD-ROM drive, locate and open the Additional Files/MacDrive Demo Installer folder.
- 3 Double-click the MacDrive demo installer.
- 4 Follow the on-screen instructions to install MacDrive. After installation is complete, restart your computer.

⚠ *All formatting and maintenance of HFS+ drives should be carried out when the drives are connected to a Macintosh. Do not use the MacDrive utility to initialize or partition Macintosh drives.*

Launching Pro Tools LE

When launching Pro Tools LE the first time, you are prompted to enter an authorization code.

To authorize Pro Tools LE software:

- 1 Double-click the Pro Tools LE shortcut on your desktop (or the application icon in the Pro Tools folder inside the Digidesign folder).
- 2 Enter the authorization code in the dialog (making sure to type it exactly as printed, and observing any spaces and capitalization), then click Validate.

Your authorization code is located on the inside front cover of this guide.

Configuring Pro Tools LE

Pro Tools System Settings

Pro Tools LE lets you adjust the performance of your system by changing *system settings* that affect its capacity for processing, playback, and recording.

In most cases, the default settings for your system provide optimum performance, but you may want to adjust them to accommodate large or processing-intensive Pro Tools sessions.

Hardware Buffer Size

The Hardware Buffer Size (H/W Buffer Size) controls the size of the buffer used to handle host processing tasks such as Real-Time AudioSuite (RTAS) plug-ins. The H/W Buffer setting can also be used to manage monitoring latency.

- ◆ Lower Hardware Buffer Size settings reduce monitoring latency, and are useful when you are recording live input.
- ◆ Higher Hardware Buffer Size settings allow for more audio processing and effects, and are useful when you are mixing and using more RTAS plug-ins.

⚠ *In addition to causing slower screen response and monitoring latency, higher Hardware Buffer Size settings can increase the latency caused by RTAS plug-ins, and affect the accuracy of plug-in automation, mute data, and MIDI track timing.*

To change the Hardware Buffer Size:

- 1 Choose Setup > Playback Engine.

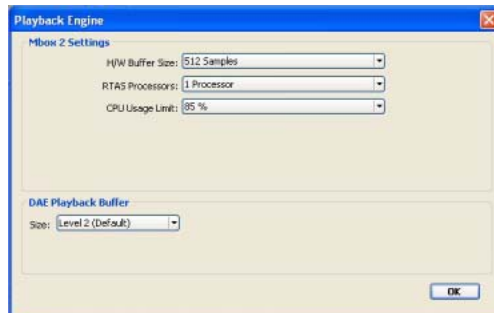

Playback Engine dialog for Mbox 2

- 2 From the H/W Buffer Size pop-up menu, select the audio buffer size, in samples.
- 3 Click OK.

RTAS Processors

The RTAS Processors setting determines the number of processors in your computer allocated for RTAS plug-in processing.

With computers that have multiple processors, or that feature multi-core processing or hyper-threading, this setting lets you enable multi-processor support for RTAS processes. Used in combination with the CPU Usage Limit setting, the RTAS Processors setting lets you control the way RTAS processing and other Pro Tools tasks are carried out by the system.

- ◆ A higher number of processors reserves more CPU processing capacity for RTAS plug-in processing. This is useful for sessions with large number of RTAS plug-ins.
- ◆ A lower number of processors leaves more CPU processing capacity for automation, screen redraws, and video playback in Pro Tools, or for other application running at the same time as Pro Tools.

To set the number of RTAS Processors:

- 1 Choose Setup > Playback Engine.
- 2 From the RTAS Processors pop-up menu, select the number of available processors you want to allocate for RTAS plug-in processing.
- 3 Click OK.

CPU Usage Limit

The CPU Usage Limit controls the percentage of CPU resources allocated to Pro Tools host processing tasks. Used in combination with the RTAS Processors setting, the CPU Usage Limit setting lets you control the way Pro Tools tasks are carried out by the system.

- ◆ Lower CPU Usage Limit settings limit the effect of Pro Tools processing on other CPU-intensive tasks, such as screen redraws, and are useful when you are experiencing slow system response, or when running other applications at the same time as Pro Tools.
- ◆ Higher CPU Usage Limit settings allocate more processing power to Pro Tools, and are useful for playing back large sessions or using more real-time plug-ins.

The maximum available CPU Usage Limit depends on the number of processors in your computer and on the number of processors you specify for RTAS processing. This value can range from 85 percent for single-processor computers to 99 percent for multi-processor computers.

- ⚠ *Increasing the CPU Usage Limit may slow down screen response on slower computers.*

To change the CPU Usage Limit:

- 1 Choose Setup > Playback Engine.
- 2 From the CPU Usage Limit pop-up menu, select the percentage of CPU processing you want to allocate to Pro Tools.
- 3 Click OK.

DAE Playback Buffer Size

The DAE Playback Buffer Size determines the amount of memory DAE allocates for disk buffers. The optimum DAE Playback Buffer Size for most disk operations is Level 2.

- ◆ DAE Playback Buffer Size settings lower than Level 2 may improve playback and recording initiation speed, but may make it difficult to play or record tracks reliably with sessions containing a large number of tracks or a high density of edits, or with systems that have slower or heavily fragmented hard drives.
- ◆ DAE Playback Buffer Size settings higher than Level 2 will allow for a higher density of edits in a session or a higher track count when using slower hard drives. However, a higher setting can also cause a time lag to occur when starting playback or recording, or longer audible time lag while editing during playback.

 *Using a larger DAE Playback Buffer Size leaves less system memory for other tasks. The default setting of Level 2 is recommended unless you are encountering -9073 ("Disk too slow or fragmented") errors.*

To change the DAE Playback Buffer Size:

- 1 Choose Setup > Playback Engine.
- 2 From the DAE Playback Buffer pop-up menu, select a buffer size.
- 3 Click OK.

Pro Tools Hardware Settings

Pro Tools lets you set the default sample rate and clock source for your system, as well as a range of controls specific to each type of audio interface.

Default Sample Rate

The Sample Rate setting appears as the default sample rate when you create a new session. (This setting is available in the Hardware Setup dialog only when no session is open.)

 You can change the sample rate when creating a new Pro Tools session by selecting a different sample rate in the New Session dialog. (Refer to the Pro Tools Reference Guide for details.)

To change the default Sample Rate:

- 1 Choose Setup > Hardware.

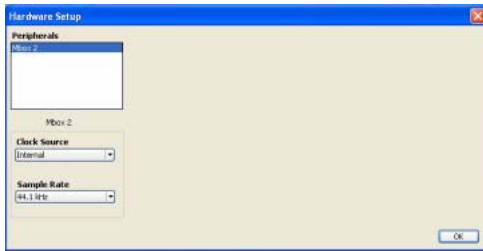

Hardware Setup dialog for Mbox 2

- 2 Select the sample rate from the Sample Rate pop-up menu.
- 3 Click OK.

Clock Source

The Pro Tools Hardware Setup dialog lets you select the Clock Source for the system.

Internal Use this setting if you are recording analog signals directly into Mbox 2 analog inputs 1–2 and/or are recording digital inputs into Mbox 2 inputs 3–4 where the digital device is synchronized to the Mbox 2 digital output.

S/PDIF Use this setting if you are recording through the Mbox 2 S/PDIF inputs from an external digital device. This setting will synchronize Pro Tools to that digital device.

To select the Clock Source:

- 1 Choose Setup > Hardware.
- 2 Choose the clock source from the Clock Source pop-up menu.
- 3 Click OK.

 Your digital input device must be connected and powered on for Pro Tools to synchronize to it. If your input device is not powered on, leave the Clock Source set to Internal.

Configuring I/O Setup

Using the I/O Setup dialog, you can label Pro Tools LE input, output, insert, and bus *signal paths*. The I/O Setup dialog provides a graphical representation of the inputs, outputs, and signal routing of the Mbox 2.

Pro Tools LE has default I/O Setup settings that will get you started. Use the I/O Setup dialog only if you want to rename the default I/O paths.

To rename I/O paths in I/O Setup:

1. Choose Setup > I/O.

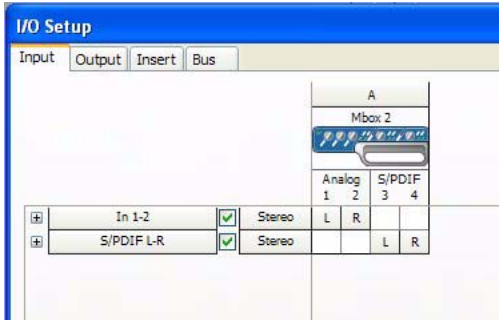

I/O Setup dialog for Mbox 2

2. Click the Input, Output, Insert, or Bus tab to display the corresponding connections.
3. To change the name of a path or subpath, double-click directly on the Path Name, type a new name for the path, and press Enter.
4. Click OK.

 See the *Pro Tools Reference Guide* (or choose *Help > Pro Tools Reference Guide*) for more information on renaming I/O paths.

MIDI Studio Setup

(Optional)

If you plan to use any MIDI devices with Pro Tools, configure your MIDI setup with MIDI Studio Setup. See Appendix A, “Configuring MIDI Studio Setup (Windows Only)” for details.

Backing Up your System Configuration

After configuring your system and Pro Tools, you should save an image of your system drive using a backup utility such as Norton Ghost. By doing this, you can quickly restore your system configuration and settings if you encounter any problems.

Removing Pro Tools LE

If you need to remove Pro Tools LE software from your computer, you can use the Add or Remove Programs command.

To remove Pro Tools from your computer:

1. Choose Start > Control Panel.
2. Double-click Add or Remove Programs.
3. From the Currently Installed Programs list, select Digidesign Pro Tools LE.
4. Click the Change/Remove button.
5. Follow the on-screen instructions to remove Pro Tools LE.

chapter 3

Macintosh Configuration

This chapter contains information for Macintosh systems only. If you are installing Pro Tools on a Windows computer, see Chapter 2, “Windows Configuration.”

▲ *Before installing this version of Pro Tools, refer to the Read Me information included on the Pro Tools LE Installer CD.*

Installation Overview

Installation of the Mbox 2 on a Macintosh includes the following steps:

- 1 “Macintosh System Optimization” on page 19.
- 2 “Installing Pro Tools LE” on page 21.
- 3 “Connecting Mbox 2 to the Computer” on page 22.
- 4 “Launching Pro Tools LE” on page 22.
- 5 “Configuring Pro Tools LE” on page 23.
- 6 Making audio connections to the Mbox 2. (See Chapter 4, “Mbox 2 Hardware and Connections” for details.)

Macintosh System Optimization

To ensure optimum performance with Pro Tools, configure your computer before installing Pro Tools hardware and software.

Before configuring your computer, make sure you are logged in as an Administrator for the account where you want to install Pro Tools. For details on Administrator privileges in Mac OS X, refer to your Apple OS X documentation.

▲ *Do not use the Mac OS X automatic Software Update feature, as it may upgrade your system to a version of Mac OS that has not yet been qualified for Pro Tools. For details on qualified versions of Mac OS, refer to the latest compatibility information on the Digidesign Web site (www.digidesign.com/compato).*

Turning Off Software Update

To turn off the Software Update feature:

- 1 Choose System Preferences from the Apple menu and click Software Update.
- 2 Click Update Software and deselect Check for Updates.

Turning Off Energy Saver

To turn off the Energy Saver feature:

- 1 Choose System Preferences from the Apple menu and click Energy Saver.
- 2 Click Sleep and do the following:
 - Set the computer sleep setting to Never.
 - Set the display sleep setting to Never.
 - Deselect “Put the hard disk(s) to sleep when possible” option.

Setting Processor Performance

(Macintosh G5 Computers Only)

To set the Processor Performance:

- 1 Choose System Preferences from the Apple menu and click Energy Saver.
- 2 Click Options and set Processor Performance to Highest.

Disabling Spotlight Indexing

The Mac OS X Spotlight feature indexes files and folders in the background, affecting system performance. It is recommended that you disable Spotlight indexing before using Pro Tools.

To disable Spotlight indexing:

- 1 Choose System Preferences from the Apple menu and click Spotlight.
- 2 In the Spotlight window, click Privacy.
- 3 To prevent indexing of a drive, drag its icon from the desktop into the list.

Disabling the Spotlight Shortcuts

The Mac OS X Spotlight feature uses the same key commands Pro Tools uses to start recording (Command+Spacebar), and to record online (Command+Option+Spacebar). If you want to retain use of these key commands in Pro Tools, these shortcuts must be disabled.

To disable the Spotlight keyboard shortcut:

- 1 Choose System Preferences from the Apple menu and click Spotlight.
- 2 Deselect “Spotlight menu keyboard shortcut” and “Spotlight window keyboard shortcut.”

Disabling the Dashboard Shortcut

The Mac OS X Dashboard feature uses the same key command Pro Tools uses to start recording (F12). If you want to retain use of this key command in Pro Tools, this shortcut must be disabled.

To disable the Dashboard keyboard shortcut:

- 1 Choose System Preferences from the Apple menu and click Dashboard and Exposé.
- 2 Set the Dashboard keyboard shortcut to “–” to disable the shortcut.

Hard Drive Configuration and Maintenance

It is recommended that you start with a newly initialized audio drive.

- ⚠ *Always back up any important data on your drive before initializing it, as initializing will erase all data on the drive.*

Avoid Recording to the System Drive

Recording to your system drive is not recommended. Recording and playback on a system drive may result in lower track counts, fewer plug-ins, or drive errors.

Formatting an Audio Drive

For optimum performance, audio drives should be formatted as Mac OS Extended (Journaled).

To format an audio drive:

- 1 Launch the Disk Utility application, located in Applications/Utilities.

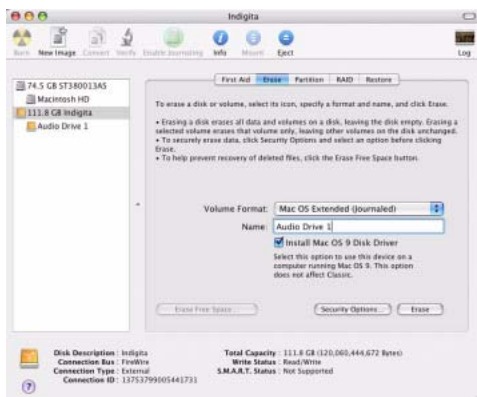

Disk Utility (Mac OS X)

- 2 Click the Erase tab.
- 3 Select the drive you want to initialize in the column on the left side of the window.

- 4 Choose the Mac OS Extended (Journaled) format.

- ⚠ *Do not choose the “Case-Sensitive” format option. Pro Tools will not operate properly with case-sensitive formatted drives.*

- 5 Type a name for the new volume.
- 6 If you plan to connect the drive to a Mac OS 9 computer, select Install Mac OS 9 Drivers.
- 7 Click Erase.

The drive appears on the Desktop with the new volume name.

Installing Pro Tools LE

After the Apple System software settings are configured, you are ready to install Pro Tools LE.

To install Pro Tools LE on Mac OS X:

- 1 Make sure you are logged in as an Administrator for the account where you want to install Pro Tools. For details on Administrator privileges in Mac OS X, refer to your Apple Mac OS X documentation.
- 2 Insert the Pro Tools LE Installer CD in your CD-ROM drive. Double-click “Install Pro Tools LE.”
- 3 Enter your Administrator password and click OK to authenticate the installation.
- 4 Follow the on-screen instructions to continue and accept installation.
- 5 In the Installer window, make sure the Install Location is on your Startup drive.
- 6 In the Installer window, choose Custom Install from the pop-up menu, and click Install.

7 Follow the remaining on-screen instructions to install Pro Tools and any options. (See also “Launching Pro Tools LE” on page 22.)

8 When installation is complete, click Restart.

Mbox 2 CoreAudio Driver

The Mbox 2 CoreAudio Driver is a multi-client, multichannel sound driver that allows CoreAudio compatible applications to record and play back through Digidesign hardware.

The CoreAudio Driver is installed by default when you install Pro Tools.

 For information on configuring the Mbox 2 CoreAudio Driver, see the Mbox 2 CoreAudio Guide.

Optional Software on the Pro Tools Installer CD

Your Pro Tools LE Installer CD includes separate installers for the following optional items.

Pro Tools Demo Session

The Pro Tools LE Installer CD includes a demo session that you can use to verify that your system is working.

To install the demo session:

- 1 Insert the Pro Tools LE Installer CD in your CD-ROM drive. Locate and double-click the demo session installer icon.
- 2 Select your audio drive as the install location and click Install.
- 3 When installation is complete, click Quit.

Connecting Mbox 2 to the Computer

Before launching Pro Tools LE software, connect Mbox 2 to your computer.

To connect Mbox 2 to your computer:

- 1 Connect the small end of the included USB cable to the USB port on Mbox 2.
- 2 With your computer on, connect the other end of the USB cable to any available USB port on your computer.

 *If the USB LED on the front panel of the Mbox 2 does not illuminate after installation, try unplugging the USB cable from the Mbox 2 USB port, and plugging it back in. If the USB LED still does not illuminate, shut down the computer, disconnect Mbox 2 and start the computer. Once the computer has fully restarted, reconnect Mbox 2.*

 *Mbox 2 may not function properly if connected to a USB hub. If you need to use a hub for other USB peripherals, connect the hub to a separate USB port; Mbox 2 must be connected to a dedicated port on the computer in order to function properly.*

Launching Pro Tools LE

When launching Pro Tools LE the first time, you are prompted to enter an authorization code to validate your software.

To authorize Pro Tools LE software:

- 1 Click the Pro Tools LE icon in the Dock (or double-click the application icon in the Pro Tools folder inside the Digidesign folder).

2 Enter the authorization code in the dialog when prompted (making sure to type it exactly as printed, and observing any spaces and capitalization), then click Validate.

Your authorization code is located on the inside front cover of this guide.

Configuring Pro Tools LE

Pro Tools System Settings

Pro Tools LE lets you adjust the performance of your system by changing *system settings* that affect its capacity for processing, playback, and recording.

In most cases, the default settings for your system provide optimum performance, but you may want to adjust them to accommodate large or processing-intensive Pro Tools sessions.

Hardware Buffer Size

The Hardware Buffer Size (H/W Buffer Size) controls the size of the buffer used to handle host processing tasks such as Real-Time AudioSuite (RTAS) plug-ins. The H/W Buffer setting can also be used to manage monitoring latency.

- ◆ Lower Hardware Buffer Size settings reduce monitoring latency, and are useful when you are recording live input.
- ◆ Higher Hardware Buffer Size settings allow for more audio processing and effects, and are useful when you are mixing and using more RTAS plug-ins.

⚠ *In addition to causing slower screen response and monitoring latency, higher Hardware Buffer Size settings can increase the latency caused by RTAS plug-ins, and affect the accuracy of plug-in automation, mute data, and MIDI track timing.*

To change the Hardware Buffer Size:

- 1 Choose Setup > Playback Engine.



Playback Engine dialog for Mbox 2

- 2 From the H/W Buffer Size pop-up menu, select the audio buffer size, in samples.
- 3 Click OK.

RTAS Processors

The RTAS Processors setting determines the number of processors in your computer allocated for RTAS plug-in processing.

With computers that have multiple processors, or that feature multi-core processing or hyper-threading, this setting lets you enable multi-processor support for RTAS processes. Used in combination with the CPU Usage Limit setting, the RTAS Processors setting lets you control the way RTAS processing and other Pro Tools tasks are carried out by the system.

- ◆ A higher number of processors reserves more CPU processing capacity for RTAS plug-in processing. This is useful for sessions with large number of RTAS plug-ins.

◆ A lower number of processors leaves more CPU processing capacity for automation, screen redraws, and video playback in Pro Tools, or for other application running at the same time as Pro Tools.

To set the number of RTAS Processors:

- 1 Choose Setup > Playback Engine.
- 2 From the RTAS Processors pop-up menu, select the number of available processors you want to allocate for RTAS plug-in processing.
- 3 Click OK.

CPU Usage Limit

The CPU Usage Limit controls the percentage of CPU resources allocated to Pro Tools host processing tasks. Used in combination with the RTAS Processors setting, the CPU Usage Limit setting lets you control the way Pro Tools tasks are carried out by the system.

- ◆ Lower CPU Usage Limit settings limit the effect of Pro Tools processing on other CPU-intensive tasks, such as screen redraws, and are useful when you are experiencing slow system response, or when running other applications at the same time as Pro Tools.
- ◆ Higher CPU Usage Limit settings allocate more processing power to Pro Tools, and are useful for playing back large sessions or using more real-time plug-ins.

The maximum available CPU Usage Limit depends on the number of processors in your computer and on the number of processors you specify for RTAS processing. This value can range from 85 percent for single-processor computers to 99 percent for multi-processor computers.

 *Increasing the CPU Usage Limit may slow down screen response on slower computers.*

To change the CPU Usage Limit:

- 1 Choose Setup > Playback Engine.
- 2 From the CPU Usage Limit pop-up menu, select the percentage of CPU processing you want to allocate to Pro Tools.
- 3 Click OK.

DAE Playback Buffer Size

The DAE Playback Buffer Size determines the amount of memory DAE allocates for disk buffers. The optimum DAE Playback Buffer Size for most disk operations is Level 2.

- ◆ DAE Playback Buffer Size settings lower than Level 2 may improve playback and recording initiation speed, but may make it difficult to play or record tracks reliably with sessions containing a large number of tracks or a high density of edits, or with systems that have slower or heavily fragmented hard drives.
- ◆ DAE Playback Buffer Size settings higher than Level 2 will allow for a higher density of edits in a session or a higher track count when using slower hard drives. However, a higher setting can also cause a time lag to occur when starting playback or recording, or longer audible time lag while editing during playback.

 *Using a larger DAE Playback Buffer Size leaves less system memory for other tasks. The default setting of Level 2 is recommended unless you are encountering -9073 (“Disk too slow or fragmented”) errors.*

To change the DAE Playback Buffer Size:

- 1 Choose Setup > Playback Engine.
- 2 From the DAE Playback Buffer pop-up menu, select a buffer size.
- 3 Click OK.

Pro Tools Hardware Settings

Pro Tools lets you set the default sample rate and clock source for your system.

Default Sample Rate

The Sample Rate setting appears as the default sample rate when you create a new session. (This setting is available in the Hardware Setup dialog only when no session is open.)

 You can change the sample rate when creating a new Pro Tools session by selecting a different sample rate in the New Session dialog. (See “Starting a Session” on page 37.)

To change the default Sample Rate:

- 1 Make sure that no Pro Tools session is open.
- 2 Choose Setup > Hardware.



Hardware Setup dialog for Mbox 2

- 3 Select the sample rate from the Sample Rate popup menu.
- 4 Click OK.

Clock Source

The Pro Tools Hardware Setup dialog lets you select the Clock Source for the system.

Internal Use this setting if you are recording analog signals directly into Mbox 2 analog inputs 1–2 and/or are recording digital inputs into Mbox 2 inputs 3–4 where the digital device is synchronized to the Mbox 2 digital output.

S/PDIF Use this setting if you are recording material into Mbox 2 S/PDIF inputs from an external digital device. This setting will synchronize Pro Tools to that digital device.

To select the clock source:

- 1 Choose Setup > Hardware.
- 2 Choose the clock source from the Clock Source pop-up menu.
- 3 Click OK.

 Your digital input device must be connected and powered on for Pro Tools to synchronize to it. If your input device is not powered on, leave the Clock Source set to Internal.

Configuring I/O Setup

Using the I/O Setup dialog, you can label Pro Tools LE input, output, insert, and bus *signal paths*. The I/O Setup dialog provides a graphical representation of the inputs, outputs, and signal routing of the Mbox 2.

Pro Tools LE has default I/O Setup settings that will get you started. Use the I/O Setup dialog only if you want to rename the default I/O paths.

To rename I/O paths in I/O Setup:

- 1 Choose Setup > I/O

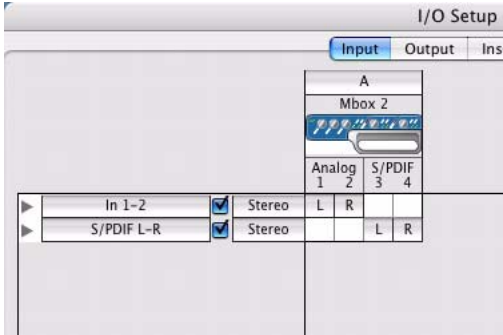

I/O Setup dialog for Mbox 2

- 2 Click the Input, Output, Insert, or Bus tab to display the corresponding connections.
- 3 To change the name of a path or subpath, double-click directly on the Path Name, type a new name for the path, and press Return.
- 4 Click OK.

 See the *Pro Tools Reference Guide* (or choose *Help > Pro Tools Reference Guide*) for more information on renaming I/O paths.

Audio MIDI Setup (AMS)

(Optional)

If you plan to use any MIDI devices with Pro Tools LE, configure your MIDI setup with the Apple Audio MIDI Setup (AMS) utility. See Appendix B, “Configuring AMS (Mac OS X Only)” for details.

Backing Up your System Configuration

After configuring your system and Pro Tools, you should save an image of your system drive using a backup utility such as Bombich Carbon Copy Cloner. By doing this, you can quickly restore your system configuration and settings if you encounter any problems.

Removing Pro Tools LE

If you need to remove Pro Tools software from your computer, you can use the Installer CD or the downloaded Installer file.

To remove Pro Tools from your computer:

- 1 Make sure you are logged in as an Administrator for the account where Pro Tools is installed. For details on Administrator privileges in Mac OS X, refer to your Apple OS X documentation.
- 2 Insert the Pro Tools Installer CD-ROM in your CD-ROM drive or locate the downloaded Installer file.
- 3 Double-click “Install Pro Tools LE.”
- 4 Enter your Administrator password and click OK.
- 5 In the Installer window, choose Uninstall from the pop-up menu, and click Uninstall.
- 6 Follow the on-screen instructions to remove Pro Tools LE.
- 7 When finished, click Quit to close the Installer window.

chapter 4

Mbox 2 Hardware and Connections

This chapter explains how to connect your Mbox 2 for monitoring, playback and recording. If you are new to working with digital audio workstations, first read through the *Mbox 2 Basics Guide* for basic setup information (such as connecting audio inputs, headphones, mics and instruments).

The following illustrations show two possible setups depending on the equipment in your studio.

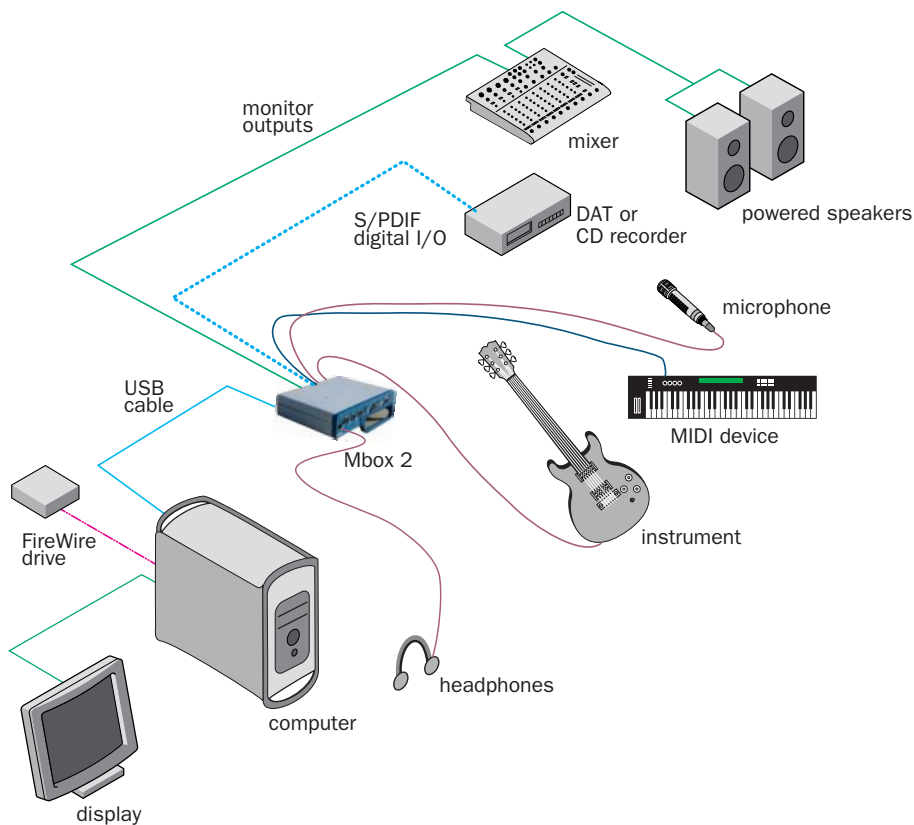

Figure 1. Mbox 2 micro studio configuration running Pro Tools LE on a desktop computer

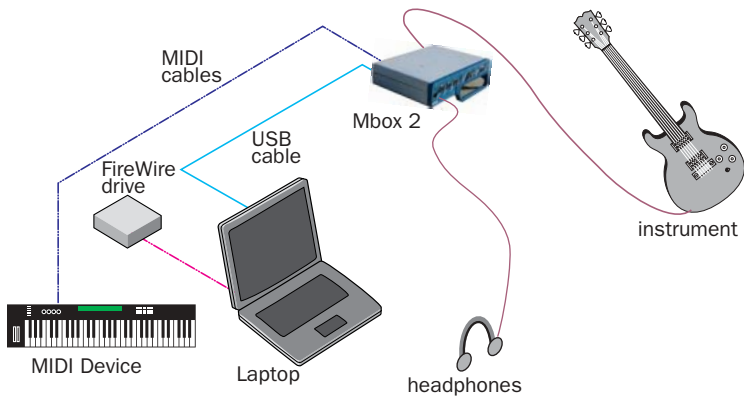

Figure 2. Mbox 2 micro studio configuration running Pro Tools LE on a laptop computer

Mbox 2 Front Panel Features

The Mbox 2 front panel has the following features:

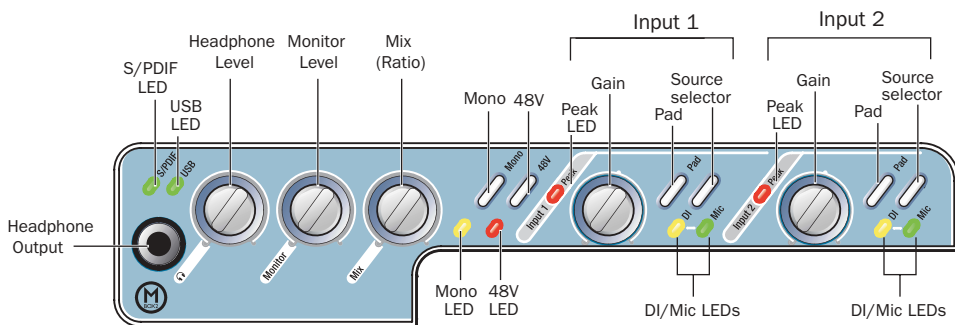

Figure 3. Mbox 2 front panel

S/PDIF LED

This LED indicates that Mbox 2 is using the S/PDIF inputs as the clock source. See “S/PDIF Digital I/O” on page 32.

USB LED

The USB LED indicates that the Mbox 2 has received power from its USB connection. Once the USB light is on, audio can pass in or out of the system.

Front Panel Headphone Output

Use the Headphone Output to connect stereo headphones with a 1/4-inch stereo mini connector.

Headphone Level

The headphone knob adjusts the output level of the Headphone port, which outputs the signal that is routed to Outputs 1–2 in Pro Tools LE, and mirrors the Line Outputs.

Monitor Level

The Monitor knob adjusts the output level of the Line Out ports. In Pro Tools, this will be the signal routed to Outputs 1–2.

Mix (Ratio) Control

Mbox 2 gives you the ability to monitor your analog input signals while recording, without the delay incurred by A/D/A converters and host-based processing.

This zero-latency analog monitoring is controlled with the Mix knob, which you can use to blend and adjust the monitor ratio between Mbox 2 analog inputs and Pro Tools playback. The Mix knob has no effect when you are using S/PDIF digital inputs, since it controls the signal before it reaches the A/D converters.

To listen to just the Source input signal, turn the Mix knob fully left to Input. To listen to Pro Tools output only, turn the knob fully right to Playback.

The output from the Mix control is routed directly to the TRS line outputs, and is mirrored in the Headphone ports and S/PDIF output ports.

This ability to blend and control the relative levels of Pro Tools playback and latency-free live analog inputs can be particularly effective when overdubbing.

Mono Switch and LED

The Mono switch sums the input channels to a mono signal (delivering that identical signal to both speakers). This has no effect on Pro Tools playback monitoring, recording, or on the main outputs. Switching your stereo source signal to mono is useful when you are recording a mono input while listening to stereo playback (to hear your playing in both sides), or for checking the phase relationship of stereo inputs. When engaged, the Mono LED lights.

Monitoring while Overdubbing

By panning signals to the center or using the Mono switch, as opposed to panning them hard left and right in the Headphone outputs, you can create a more focused monitor mix to help minimize distractions while overdubbing.

In situations where you are monitoring stereo microphones, stereo synthesizers, or any source pairs with a comfortable balance, you will probably not want to use the Mono switch.

Checking Phase Relationships

The Mono switch can also be used for a quick check of the phase relationship between Source 1 and Source 2 inputs.

When the two input signals are out of phase, pressing the Mono switch will result in a sudden “hollow” sound that is the result of phase cancellation. This quick test with the Mono switch can help to avoid phase problems later when mixing these tracks. Frequent checking of phase relationships with the Mono switch can also assist you in finding the optimal microphone placement.

48V Switch and LED

Phantom power is activated by the switch labeled 48V on the front panel of Mbox 2. The LED, when lit, indicates that 48V phantom power is active on the Mic/Line inputs. These inputs provide phantom power for microphones that require it to operate.

About Phantom Power

Dynamic microphones (such as a Shure SM57) do not require phantom power to operate, but are not harmed by it. Most *condenser* microphones (like an AKG C3000) *do* require phantom power to operate.

⚠ *Although phantom power can be used safely with most microphones, it is possible to damage some ribbon microphones with it. Always turn off phantom power and wait at least ten seconds before connecting or disconnecting a ribbon microphone.*

If you are not sure about the phantom power requirements for your microphone, consult your microphone's documentation or contact the manufacturer.

Peak LEDs

These LEDs are clip indicators. If the Peak LEDs flicker occasionally, the signal reaching Mbox 2 has clipped.

Gain Controls

These knobs adjust the input gain levels of the Mic/Line inputs.

Pad Switches and LEDs

The Pad switches engage a –20 dB pad on their corresponding input channels. When engaged, the Pad LEDs light.

Source Selectors and LEDs

These switches select either the Mic or DI inputs for each channel. The DI and Mic LEDs indicate the current source input. For more information, see “Analog Audio” on page 34.

Removable Handle

Mbox 2 includes a handle that can be used for carrying and tilting, as well as a replacement panel that makes the unit more compact.

- ◆ The handle can be used as a stand that tilts the unit into a more easily viewable angle when the Mbox 2 is placed on a desktop. The handle can also be used to carry the unit.
- ◆ The handle can also be replaced with the optional Mbox 2 faceplate panel. This panel lets Mbox 2 sit flat on a desktop, and reduces the space required when packed for traveling.

To replace the handle with the Mbox 2 panel:

- 1 Unscrew the handle mounting screw located along the right edge of the handle (when viewing from the front).
- 2 Remove the handle.
- 3 Mount the replacement panel in position where the handle had been.
- 4 Secure the panel to the unit in its new position using the same screw you removed in step 1.
- 5 Repeat the above basic instructions to replace the panel with the handle.

Mbox 2 Back Panel Features

Figure 4 identifies each port on the Mbox 2 back panel.

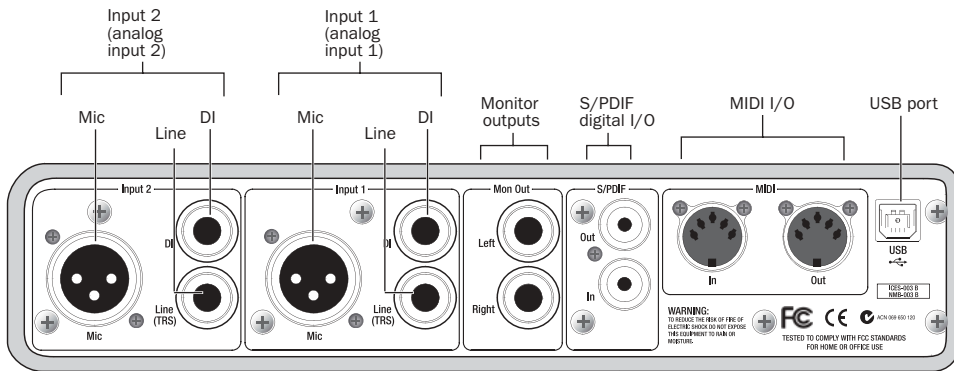

Figure 4. Mbox 2 back panel

The Mbox 2 back panel has the following features:

USB Port

This standard USB v1.1 connector is used to connect your computer to the Mbox 2. One standard USB cable is included with your system.

The Mbox 2 is compatible with USB 2.0 ports. However, the USB 2.0 bus will switch to the slower USB v.1.1 speed to accommodate Mbox 2.

MIDI I/O

The MIDI In and MIDI Out ports are standard 5-pin MIDI ports, each providing 16 channels of MIDI input and output.

S/PDIF Digital I/O

The S/PDIF in and out ports are unbalanced two-conductor phono (RCA) connectors that utilize a full 24-bit, two-channel digital data stream.

The Sony/Philips Digital Interface Format (S/PDIF) is used in many professional and consumer CD recorders and DAT recorders. To avoid RF interference, use 75-ohm coaxial cable for S/PDIF transfers and keep the cable length to a maximum of 10 meters.

In use, the S/PDIF input channels are available in addition to the two channels of analog audio input. This lets Mbox 2 be used as a 4-in/2-out digital audio interface for Pro Tools LE.

The S/PDIF output channels always mirror the main outs 1–2.

Mon Out (Monitor Output)

These outputs support balanced TRS, or unbalanced TS, 1/4-inch connections. To monitor your mix, these outputs can be connected to a mixing board, directly to a monitoring system such as a stereo power amp, or another stereo destination.

The Mon Out Left and Right play the audio that is routed to analog outputs 1 and 2 from within Pro Tools, respectively. These analog outputs feature 24-bit digital-to-analog converters.

Input 1 and Input 2

Each analog source input channel (Input 1 and Input 2) provides Mic, DI, and Line (TRS) ports. These balanced/unbalanced analog audio inputs support a broad range of input levels, as follows:

- Mic (microphone) for XLR inputs
- Line (TRS) for line level signals on TRS or TS inputs
- Inst (instrument) for other 1/4-inch TRS or TS connections

On the front panel, the input signal is adjusted by the Gain control for each channel and the source (Mic/Line, or DI) is chosen using the Source selectors.

Source 2 is at the far left (when looking at the back panel), and Source 1 is to its right. The back panel inputs for Source 1 and Source 2 are located such that they are directly in line with their associated input controls on the front panel. This lets you locate input jacks more easily when viewing from the front of the unit.



Though the XLR connectors support instrument and microphone level inputs, whenever a TRS cable is plugged in to the Line(TRS) port, the XLR port on that channel is ignored.

Making Signal Connections to Mbox 2

Mbox 2 can be used in a variety of audio setups. This section describes how to make basic connections for:

- Monitoring
- Analog and digital input for recording
- MIDI
- Mixdown

Monitoring Audio

Connect headphones to the 1/4-inch port on the front panel to monitor through headphones. Use the Headphones level control to adjust level.

Mbox 2 Mon Outs (monitor outputs) play the audio that is routed in Pro Tools to Analog Outputs 1–2, and can provide left and right outputs to a two-track deck for mixdown, or to another stereo destination.

The Mbox 2 Monitor Outputs feature 24-bit digital-to-analog converters capable of maximum output of +4 dBu/+2 dBV (balanced/unbalanced signal). The connectors are TRS ports; unbalanced TS connectors are also supported.

 *You cannot monitor Pro Tools audio through speakers connected to your computer. To monitor audio, connect headphones, powered speakers, or an external amplifier to your Mbox 2.*

To connect headphones:

- Connect headphones with an 1/4-inch stereo connector (or an adapter) to the Headphone jack.

 *The Mbox 2 headphone output can produce very loud output levels. Prolonged exposure can cause hearing damage. Adjust headphone volume carefully using the front panel Headphone Level control.*

To connect to a home stereo:

- Using 1/4-inch cables, connect the left and right Mon Outs on the back panel of Mbox 2 to the appropriate inputs on your stereo.

 *Home stereo systems often use RCA connectors. You can use an adaptor or a special cable to convert from the TRS or TS connectors used by Mbox 2 to the RCA connectors on your home stereo.*

To connect monitor speakers with a power amp or self-powered monitor speakers:

- Using 1/4-inch cables, connect the left and right Mon Outs on the back of Mbox 2 to the appropriate inputs on your mixer, power amp, or powered speakers.

Connecting Audio Sources to Mbox 2 for Recording

Digital and analog audio sources can be connected directly to Mbox 2.

Analog Audio

Analog audio signals are output by microphones, synthesizers, mixers, and instruments with magnetic pickups. Of these sources, microphones and magnetic pickup instruments output the quietest signals, and generally require the most amplification. Keyboards, preamps, and mixers output “line-level” audio, which varies with each device between the -10 dBV and +4 dBu standards.

To accommodate these varying sources, Mbox 2 provides switchable line input types with adjustable gain for each input channel.

To connect an analog audio source:

- 1 Do one of the following:
 - To connect a microphone, plug an XLR cable directly into the Input 1 or Input 2 Mic input.
 - To connect a keyboard, mixer, or other 1/4-inch TRS source, plug its TRS cable(s) directly into the Input 1 and/or Input 2 Line (TRS) ports. Make sure nothing is plugged into the same channel’s Mic input.
 - To connect a guitar, bass, or similar device, plug its TS cable into the Input 1 or Input 2 DI ports.

2 On the front panel, press the channel Source Select switch as appropriate:

- To select the Mic input (XLR), press that channel's Source switch until the Mic LED lights. Make sure nothing is plugged in to that channel's Line (TRS) port.
- To select the Line (TRS) port, press that channel's Source switch until the Mic LED lights.
- To select the DI port, press that channel's Source switch until the DI LED lights.

To activate phantom power:

- If your microphone requires phantom power, first make sure the microphone is connected, then press the Phantom Power switch (labeled 48V).

 *Enabling phantom power enables 48V through both mic inputs.*

Digital Audio

Mbox 2 provides digital inputs and outputs for S/PDIF format digital audio. The two channels of S/PDIF digital input can be used in combination with the two analog inputs (for a total of four simultaneous input channels).

About S/PDIF

S/PDIF (Sony/Philips Digital Interchange Format) I/O is available on many CD recorders, DAT decks and other digital devices. Each S/PDIF connection provides two channels of 24-bit digital audio.

To connect a S/PDIF device to Mbox 2:

- 1** Use two 75-ohm coaxial cables with male RCA connectors on both ends (purchased separately).
- 2** Connect the device's S/PDIF output to Mbox 2's S/PDIF input port, and the device's S/PDIF input to Mbox 2's S/PDIF output port.



*To configure Mbox 2 to record from a digital source, choose **Setups > Hardware Setup** in **Pro Tools**, then select **S/PDIF** in the **Clock Source**.*

To configure Pro Tools to record from a S/PDIF device:

- 1** Choose **Setups > Hardware Setup**.
- 2** Choose S/PDIF from the Clock Source selector. On the front panel, the S/PDIF LED lights to indicate this setting.
- 3** On the recording track, choose the appropriate stereo or mono S/PDIF source from the track Input selector.

S/PDIF Mirroring

Pro Tools LE uses S/PDIF mirroring to automatically “mirror” the audio that is sent to Line Outputs 1 and 2 on the S/PDIF RCA outputs. This is useful, for example, if you are monitoring a mix using your Line Outputs, and also recording the same source to an external S/PDIF device.

MIDI Connections

The two MIDI ports on Mbox 2 let you take advantage of all the MIDI features of Pro Tools LE, including recording and editing MIDI tracks.

 See the *Mbox 2 Basics Guide* for information on basic MIDI concepts.

If you need additional MIDI ports you can add a compatible MIDI interface. USB MIDI interfaces work effectively with Pro Tools systems on Windows or Macintosh.

Serial MIDI interfaces are supported on Windows systems only.

 Only USB MIDI interfaces are compatible with Pro Tools systems for Mac OS X. Modem-to-serial port adapters and serial MIDI devices are not supported.

 See Appendix A, “Configuring MIDI Studio Setup (Windows Only)” or Appendix B, “Configuring AMS (Mac OS X Only)” for information on configuring your MIDI studio for use with Pro Tools.

To connect MIDI devices to your system:

- 1 Connect the MIDI OUT of your MIDI device or controller to the MIDI IN port on the back of Mbox 2.
- 2 Connect the MIDI IN of your MIDI device or controller to the MIDI OUT port on the back of Mbox 2.

 MIDI is not audio. To hear the output of your MIDI devices within Pro Tools, you must route the audio output of your MIDI device into your Mbox 2 audio inputs, and monitor or record the audio into your session. See “Making Signal Connections to Mbox 2” on page 33.

Connecting a Recorder for Mixdowns

After you record and mix your sessions in Pro Tools, you may want to mix them down to a DAT, CD recorder, Mini-Disc, or other stereo 2-track recording device.

 For more information on mixdown options, see Chapter 5, “Working with Pro Tools LE.”

Connecting an Analog Deck

Connect the left and right Mon Outs on the back of the Mbox 2 to your recorder's analog inputs. Mon Outs Left and Right should be routed to the left and right inputs, respectively, on your recorder. These outputs are TRS ports. You may need adapter cables if your mixdown deck has RCA inputs.

Connecting a Digital Deck

If you have a CD recorder, DAT deck or other device that accepts S/PDIF connections, connect it to the S/PDIF In and S/PDIF Out RCA ports on the back of Mbox 2

 When recording from Pro Tools to a digital device, make sure the Pro Tools Clock Source setting is set to Internal clock mode.

chapter 5

Working with Pro Tools LE

This tutorial of Pro Tools LE software introduces its main windows and features, and also includes a step-by-step overview of audio recording.

All features described in this chapter are explained fully in the *Pro Tools Reference Guide*.

You can view an electronic PDF version of the *Reference Guide* by choosing it from the Pro Tools Help menu.

Session Basics

Pro Tools LE projects are created and saved as *sessions*. Sessions store all tracks, audio, MIDI, and other session information. Audio files, and fade files, Region group files, and backup Session files are stored in folders within the session folder.

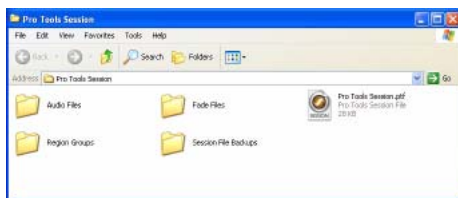

Session folder containing the session file and its associated folders

Starting a Session

To create a new session:

- 1 Launch Pro Tools LE.
- 2 Choose File > New Session.
- 3 In the New Session dialog, set the audio file type, sample rate, and bit depth parameters for the new session.

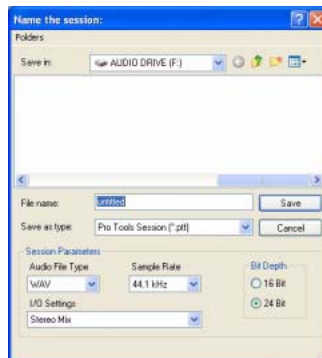

New Session dialog

- 4 Choose where you want to save your session. If you are using external hard drives with your Pro Tools system, make sure you select the appropriate drive in the New Session dialog.
- 5 Type a name for your session.
- 6 Click Save. The new session opens its Mix, Edit, and Transport windows.

Main Windows

The Mix, Edit, and Transport windows are the main Pro Tools work areas. You can show any of these windows by choosing them from the Window menu.

Edit Window Displays tracks in the session along the Timeline, for editing of audio, MIDI, and automation data.

Mix Window Displays the Pro Tools mixer, with its familiar fader strip controls for volume, pan, solo, mute, and signal routing.

 To switch between the Edit and Mix windows, press **Control+Equals (=)** (Windows) or **Command+Equals (=)** (Macintosh).

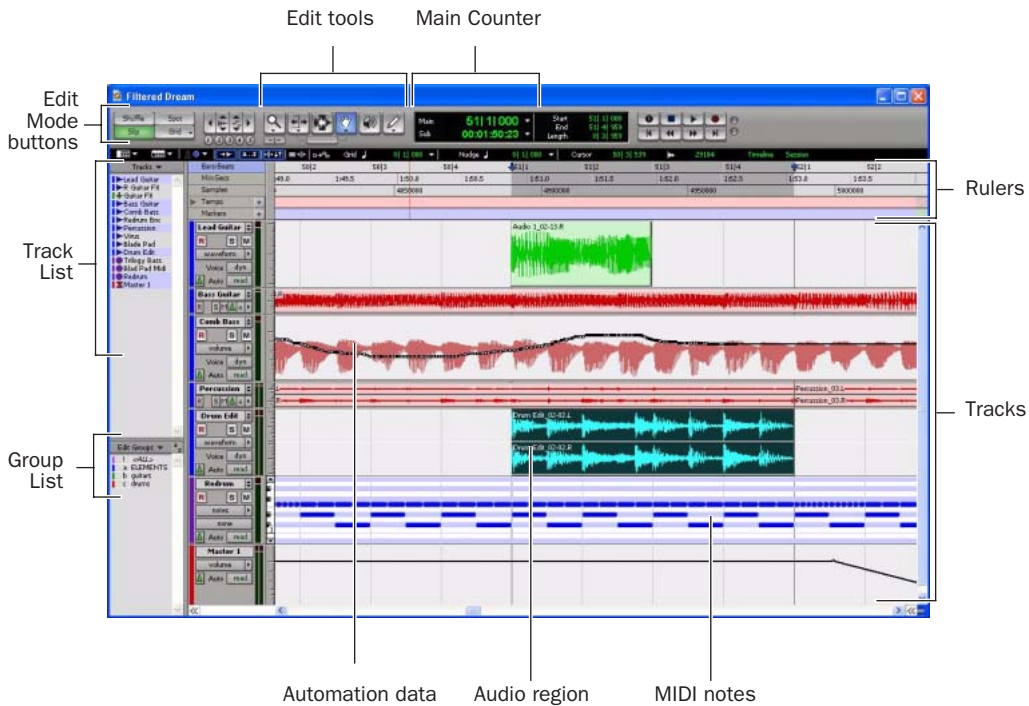

Figure 5. Edit window

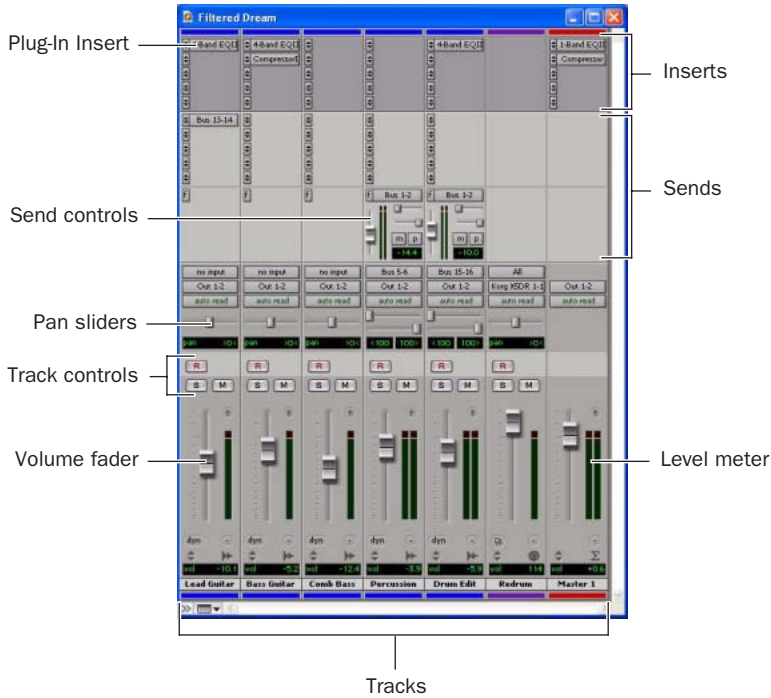

Figure 6. Mix window

Transport Window Provides controls for Play, Stop, Rewind, Fast-Forward, Pause, and Record. The Transport window can also show Counter and MIDI Control displays.

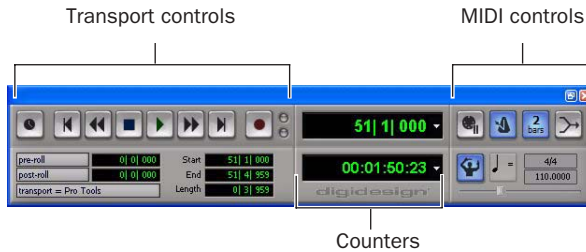

Figure 7. Transport window

Rulers

Pro Tools LE provides several different rulers to help navigate your session.

Timebase Rulers

Timebase rulers, displayed along the top of the Edit window, include *Bars:Beats*, *Minutes:Seconds*, and *Samples*. The current timebase determines the format of the Main counter, and provides the basis for the Edit window Grid.

To select a Timebase ruler:

- Click the name of the ruler at the top left side of the Edit window.

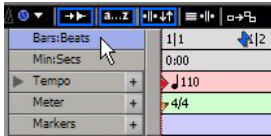

Selecting a Timebase ruler

Conductor Rulers

The Conductor rulers, displayed just below the Timebase rulers, include *Tempo*, *Meter*, and *Markers*. The Meter and Tempo rulers indicate changes in meter and tempo within the session. The Markers ruler displays markers to important track locations.

Setting a Tempo

You can set the tempo for your session by using the Song Start Marker, located in the Tempo ruler.

To set the session tempo with the Song Start Marker:

- 1 In the Tempo ruler, double-click the Song Start Marker.

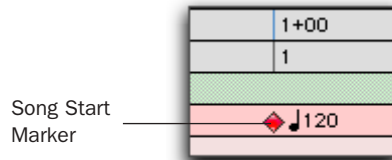

Song Start Marker

- 2 In the Tempo Change dialog, enter the BPM (beats per minute) value you will use for the session. The inserted tempo event replaces the default session tempo.



Change Tempo dialog

- 3 To base the BPM value on a different note value (such as an eighth note rather than the default quarter note), select a note value from the Resolution pop-up menu.
- 4 Click OK.

Using the Click Plug-In

The Click plug-in creates an audio click during session playback. This works like a metronome that you can use as a tempo reference when performing and recording.

The Click plug-in is synchronized to the tempo and meter of the Pro Tools session, and follows any changes in tempo and meter.

 *The Click plug-in is one of many plug-ins that can be inserted on a Pro Tools track. See “Plug-Ins” on page 63.*

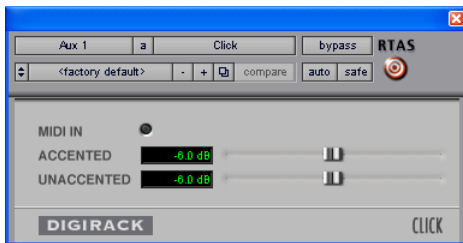

Click plug-in

Click Parameters

MIDI In LED Illuminates each time the Click plug-in receives a click message from the Pro Tools application, indicating the tempo.

Accented Controls the output level of the accent beat (beat 1 of each bar) of the audio click.

Unaccented Controls the output level of the unaccented beats of the audio click.

To use the Click plug-in:

1 Choose Options > Click to enable the Click option.

– or –

Enable the Metronome Click button in the Transport window.

Metronome Click button



Click controls in the Transport window

2 Create a mono Auxiliary Input (Aux Input) track.

3 Insert a Click plug-in on the Auxiliary Input track.

4 In the Click plug-in window, choose a click sound from the Librarian pop-up menu (this menu displays “factory default” when you first insert the plug-in).



Selecting a Click sound

5 Choose Setup > Click and set the Click and Countoff options.

 *The Note, Velocity, Duration, and Output options in this dialog are for use with MIDI instrument-based clicks and do not affect the Click plug-in.*

6 Click OK.

7 Begin playback. A click is generated according to the tempo and meter of the current session and the settings in the Click/Countoff Options dialog.

Using an External MIDI Click

Pro Tools also lets you use an external MIDI device to play the click. This feature can be turned on and off in the Transport window, and is configured from the Click/Countoff Options dialog.

To configure and enable an external MIDI click:

- 1 Choose Setup > Click.

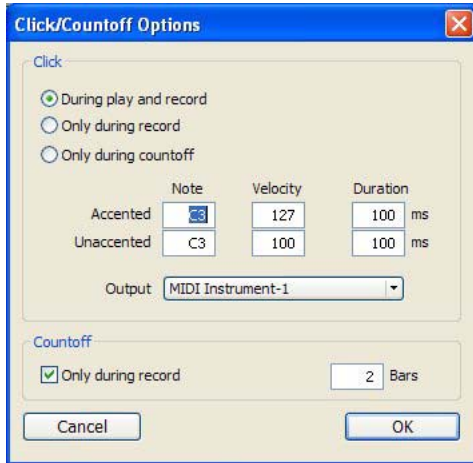

Click/Countoff Options dialog

- 2 Configure the click parameters as needed for your MIDI sound source.

▲ See Appendix A, “Configuring MIDI Studio Setup (Windows Only)” or Appendix B, “Configuring AMS (Mac OS X Only)” for information on identifying external MIDI devices connected to your hardware and configuring your MIDI studio for use with Pro Tools.

- 3 Choose a MIDI sound source from the Output pop-up menu and click OK.

- 4 During recording or playback, you can turn the Click on or off with the Metronome Click button in the MIDI Controls display of the Transport window.

Metronome Click button



Click controls in the Transport window

Saving Sessions

As you build a session by adding tracks and changing session controls, you will want to save your work. Pro Tools provides three ways to save sessions.

To save a session:

- Choose File > Save, File > Save As, or File > Save Copy In.

Save Saves the currently open session file, leaving it open for you to continue working.

Save As Creates a duplicate session file with the name you choose, and leaves the duplicate open for you to continue working. This can be useful if you want to experiment with different arrangements in the session without affecting the original session.

Save Copy In Saves a copy of the session file and lets you save copies of all audio files that are used in the session. This can be useful for archiving a session, preparing a session for transfer to another system, saving to older Pro Tools session formats, or saving a session at another sample rate.

System Resources and Settings

You can change specific Pro Tools system settings to optimize system performance.

Playback Engine Dialog

The Playback Engine dialog lets you adjust system buffer sizes and allocate CPU processing power in Pro Tools.

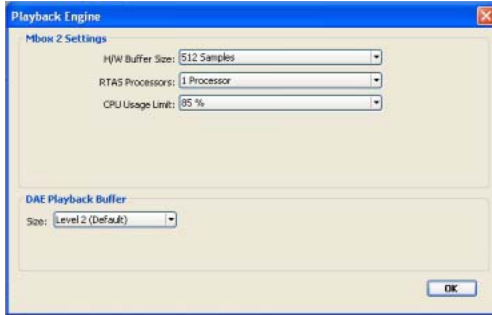

Playback Engine dialog for Pro Tools LE system

To configure system resources:

- Choose Setup > Playback Engine.

See the configuration chapter for your platform for details on configuring system settings.

System Usage Window

The System Usage window displays approximate information on CPU load and overall disk performance, so you can gauge your system's processing capacity.

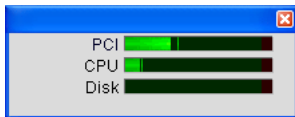

Meters in the System Usage window

To view system resources and usage:

- Choose Window > System Usage.

Transport Controls

The Transport window provides access to all Pro Tools LE transport commands. Different transport controls can be displayed or hidden in this window.

To show the Transport window:

- Choose Window > Transport.



Transport window (Expanded view shown)

To configure the Transport window:

- Choose View > Transport and select from the available view options.

The Transport window provides Play, Stop, and other standard transport controls.

The Expanded view of the Transport window provides pre- and post-roll, start, end, and length indicators for Timeline selection, as well as the Transport Master selector.

The Transport window can also display the following MIDI controls: Wait for Note, Metronome Click, Countoff, MIDI Merge, Conductor, Meter, and Tempo.

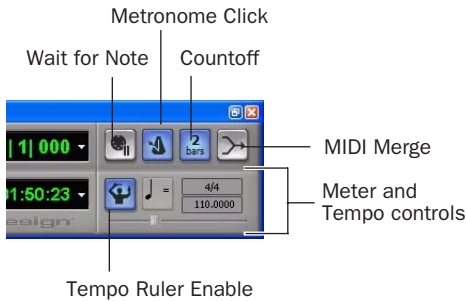

Transport window (MIDI Controls)

To start and stop playback:

- 1 Click Play in the Transport window to begin playback.
- 2 Click Stop in the Transport window to stop playback.

 Press the Spacebar on your computer keyboard to start and stop playback.

 Pro Tools LE starts playing from the location of the cursor, or from the beginning of the current selection. The current setting of the Link Edit and Timeline Selection command in the Options menu also affects playback. See the Pro Tools Reference Guide for more information.

Tracks

Pro Tools LE lets you create tracks for audio and MIDI recording, submixing, routing, automating, and editing.

Pro Tools LE provides five types of tracks: audio tracks, Auxiliary Input tracks, Master Faders, MIDI tracks, and Instrument tracks. Audio tracks, Auxiliary Inputs, Master Faders, and Instrument tracks can be mono or stereo.

Audio Tracks Record and play back audio to and from hard disk, monitor audio input when record-enabled, and edit audio regions

Auxiliary Inputs Audio mixer channels, used for input, routing, and submixing

Master Faders Provide master channel controls and options for any output or bus path

MIDI Tracks Record, play back, and edit MIDI data

Instrument Tracks Combine the functions of MIDI and Auxiliary Input tracks, letting you control and monitor instrument plug-ins or external MIDI devices in a single channel strip.

To create a new track:

- 1 Choose Track > New.

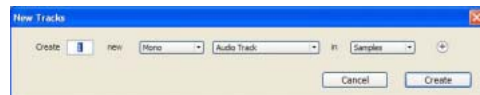

New Track dialog

- 2 Specify the number of tracks, track type, and mono or stereo (for all types except MIDI).

To create multiple new track types in one step, click the “+” button in the New Tracks dialog. Specify the number of tracks, track type, and track format for each additional row of new tracks you want to create.

3 Click Create.

In the Mix window, audio tracks, Auxiliary Inputs, Master Faders, MIDI tracks, and Instrument tracks appear as vertical channel strips.

Track type is indicated by the Track Type icons just below the faders, and by the track colors.



Tracks in the Mix window

In the Edit window, tracks are displayed horizontally along the Timeline. The area in which audio appears for each track is the Playlist.

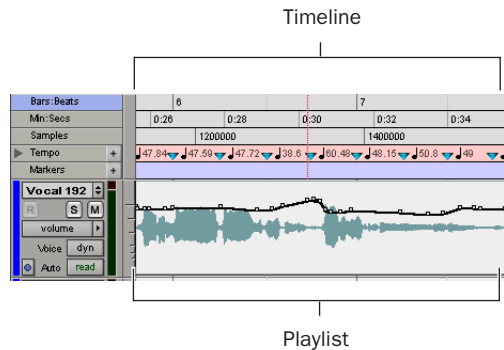

Timeline rulers and an audio track in the Edit window

Audio tracks, Auxiliary Inputs, Master Faders, MIDI tracks, and Instrument tracks can all be automated. See “Mix Automation” on page 64 for more information.

Audio Tracks

Audio tracks, Auxiliary Inputs, and Master Faders share many identical controls. Figure 8 shows the controls found in audio or Auxiliary Input tracks. Master Faders provide all the same features as audio tracks and Auxiliary Input tracks, with the following exceptions:

Input Selector A Master Fader’s output assignment determines its input, or source.

Inserts Inserts on Master Faders are post-fader only. (Audio track and Auxiliary Input track inserts are all pre-fader.)

Sends Master Faders do not provide sends. To send an output to another destination, use an Auxiliary Input track.

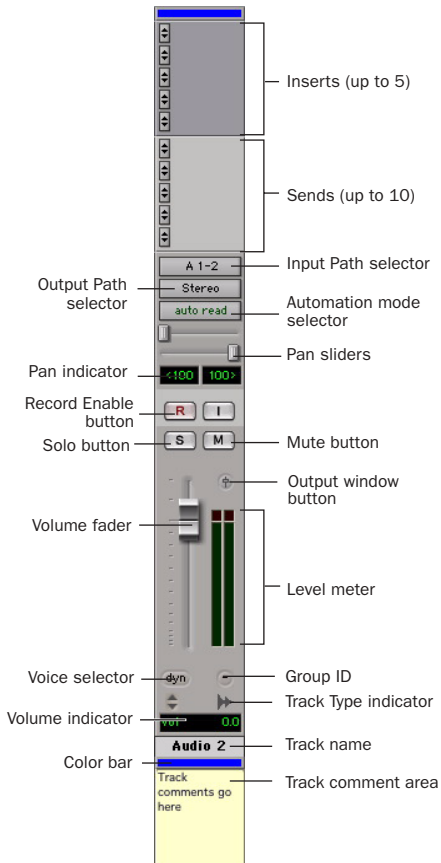

Figure 8. Stereo audio track in the Mix window

MIDI Tracks

MIDI tracks provide volume, solo, and mute, in addition to MIDI input, output, channel, and program (patch) controls. Figure 9 shows the controls found in MIDI tracks.

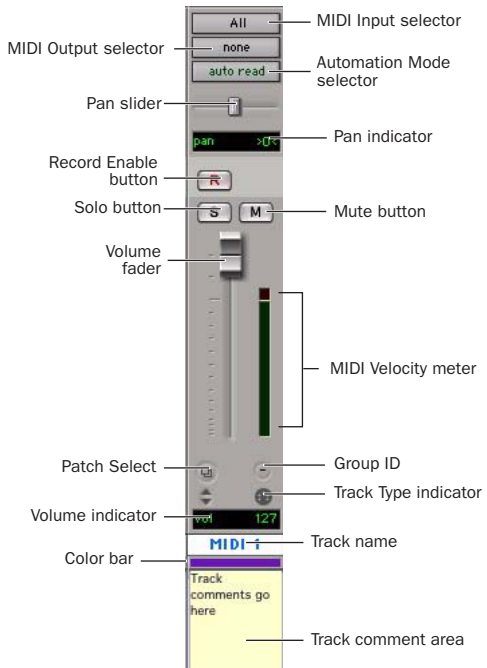

Figure 9. MIDI track in the Mix window

Instrument Tracks

Instrument tracks have many controls in common with audio tracks, and also have an additional Instruments View, which provides controls for MIDI input, output, mute, volume, and pan. Figure 10 shows the controls found in Instrument tracks.

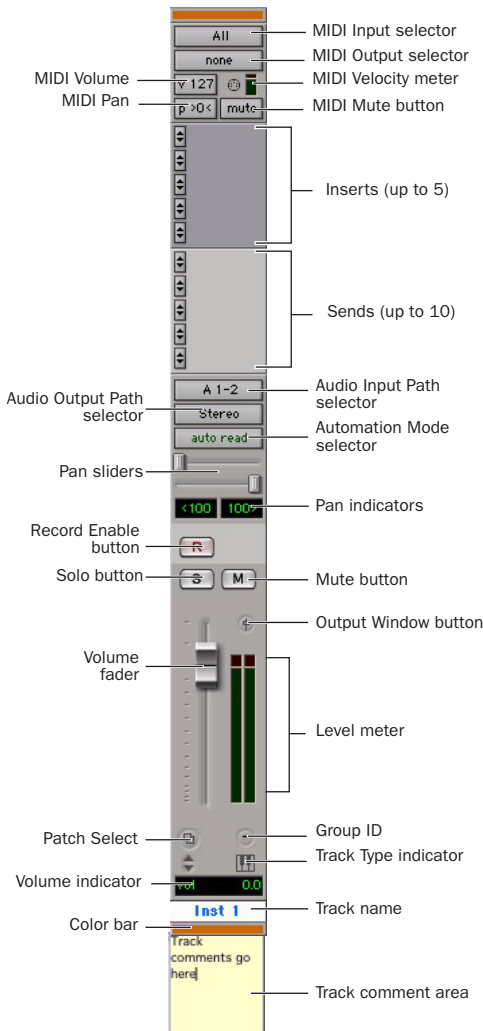

Figure 10. Stereo Instrument track in the Mix window

Region List

A region is a piece of audio or MIDI data that can also have associated automation data. For example, a region could be a loop, a guitar riff, a verse of a song, a sound effect, a piece of dialog, or an entire sound file.

In Pro Tools, regions are created from audio or MIDI files, and can be arranged in audio, MIDI, and Instrument track playlists.

All regions that are recorded, imported, or created by editing appear in the Region List. Regions can be dragged from the list to tracks and arranged in any order. Audio regions can also be auditioned from the Region List by Alt-clicking (Windows) or Option-clicking (Macintosh) the audio region name. The Region List pop-up menu provides features for managing regions and files (such as sorting, selecting, importing, or exporting files).

Drag border to resize width of Region List Click Regions button for pop-up menu

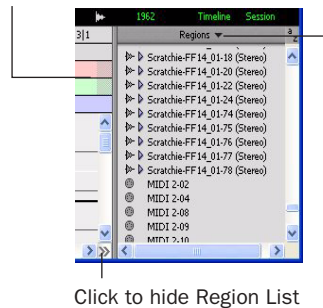

Click to hide Region List

Region List

 For more information on the Region List, see the Pro Tools Reference Guide.

Navigating in a Session

Pro Tools LE provides many ways to navigate in a session, including using the mouse or entering a memory location into one of the counters.

To navigate to a location in the Edit window:

- 1 In the Options menu, make sure Link Timeline and Edit Selection is enabled.
- 2 Enable the Selector tool at the top of the Edit window by clicking it.



Edit tools in Edit window

- 3 Click in a track or Timebase ruler. The cursor appears at the selected location and the counters display the current time location.

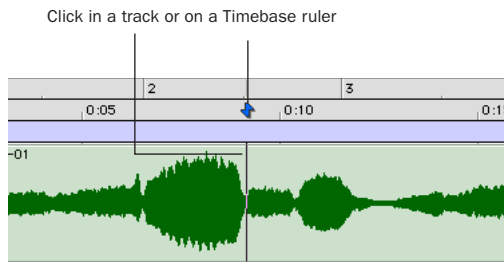

Clicking with the Selector in the Edit window

To navigate using the counters:

- 1 Click in the Main Counter and enter a location using your computer keyboard.

- 2 Press Enter (Windows) or Return (Macintosh).



Navigating with the Counter

 Press the * (asterisk) key on the numeric keypad as an alternative to clicking in the counter. (The cursor will always appear in the Transport window's Main Counter if it is displayed.)

Memory Locations

Memory Locations and markers provide another way to navigate within sessions. Memory Locations appear as markers under the Timebase rulers. You can store up to 999 Memory Locations or markers in a session.

To define a memory location:

- 1 Navigate to the location where you want to store a marker or memory location.

– or –

Begin playback somewhere before the point where you want to store a Memory Location or marker.

- 2 Create a memory location by doing one of the following:

- Press Enter on the numeric keypad.

– or –

- Click the Add Marker/Memory Location (“+”) button, located to the left of the Markers ruler.

 On some Windows laptops, you can press **Fn+Enter** to create a memory location. This is especially useful for laptops that do not have a numeric keypad.

In the New Memory Location dialog, you can define a marker, store a selection, or store any combination of the other available settings. These settings include Track Height, Group Enables, Pre- and Post-Roll values, and Track Show/Hide status.

- 3 Choose settings for the Memory Location and click OK.

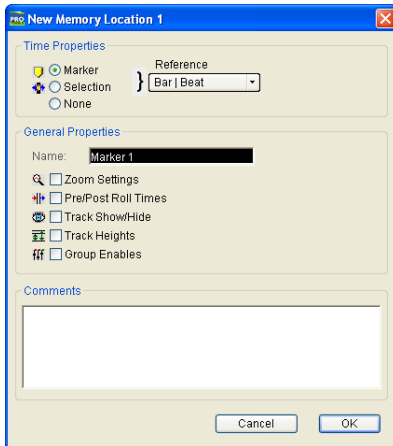

New Memory Location dialog

To go to a stored Memory Location:

- 1 Choose Window > Memory Locations.
- 2 In the Memory Locations window, click the name of the memory location.



Memory Locations window

Viewing and Zooming

When viewing tracks in the Edit window, you can adjust the height of tracks as well as zoom in vertically and horizontally using the Track Height selector and Zoom tools.

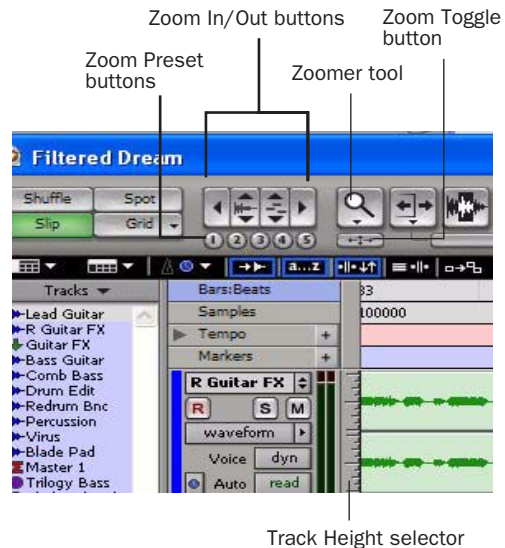

Zoom and Track Height tools in the Edit window

To change track height:

- Click the Track Height selector (the scaled vertical bar at the left of the track), and select a track height from the pop-up menu.

You can apply many commands, including track height selection, to more than just a single track. Hold down the Alt key (Windows) or Option key (Macintosh) while performing an operation to apply it to all tracks. Hold down both the Shift and Alt keys (Windows) or Shift and Option keys (Macintosh) while performing an operation to apply it to all selected tracks.

To zoom in or out on any area of a track in the Edit window:

- 1 Click to select the Zoomer tool.
- 2 Click or drag with the Zoomer tool to zoom in horizontally for a track or ruler.
 - or –

Press Alt (Windows) or Option (Macintosh) and click with the Zoomer tool to zoom out horizontally for a track or ruler.

To zoom in or out incrementally:

- Click the appropriate Zoom button:
 - Zoom Out button (Left Arrow)
 - Zoom In button (Right Arrow)
 - Audio or MIDI Zoom buttons, to increase or decrease vertical zoom of the corresponding track type

To zoom in or out continuously:

- 1 Select the Zoom tool.
- 2 Hold the Start key (Windows) or Control (Macintosh) and drag in a track as follows:
 - Drag up to zoom in vertically
 - Drag down to zoom out vertically
 - Drag to the right to zoom in horizontally
 - Drag to the left to zoom out horizontally

Zoom Toggle

The Zoom Toggle button lets you store a zoom state and toggle between it and the current zoom state. When Zoom Toggle is enabled, the Edit window displays the stored zoom state. When Zoom Toggle is disabled, the Edit window reverts to the last zoom state.

To store a zoom state using Zoom Toggle:

- 1 Make an Edit selection.
- 2 Click the Zoom Toggle button so that it is highlighted.



Zoom Toggle button

Zoom Toggle button in the Tool bar

- 3 Adjust Track Height, Vertical Zoom, Track view, and the Grid setting.
- 4 Make any desired edits.
- 5 Click the lit Zoom Toggle button again to revert to the last zoom state.
- 6 Make another edit selection and click the Zoom Toggle button to recall the stored zoom state, and continue editing.

Zoom Presets

Pro Tools provides five Zoom Preset buttons. You can use these to immediately return to established zoom levels. You can define the magnification level for each preset, on a session-by-session basis.

To store a new Zoom preset definition:

- 1 Use the Zoom tool to establish a Zoom setting.
- 2 Click a Zoom Preset button (1–5) and choose Save Zoom Preset from the Zoom Preset pop-up menu.



Zoom Preset pop-up menu

To recall a saved Zoom preset:

- Click the corresponding Zoom Preset button (1–5).

Using Memory Locations for Zoom Control

Pro Tools Memory Locations let you store many attributes with each marker or memory location, including Track Height and Zoom Settings. By creating Memory Locations that are neither markers nor selections, but have Track Height, Zoom Settings, or other options enabled, you can use Memory Locations to zoom in and out using just the numeric keypad.

For more information on creating memory locations, see “Memory Locations” on page 48.

Importing Data into Pro Tools Sessions

Pro Tools LE lets you import audio, MIDI, and a wide range of Pro Tools session data into your current session.

Importing Audio

Pro Tools LE lets you import audio files from your hard drive or from a CD. This is very useful if you have audio files already recorded to disk or if you are working with CD-based sample libraries that you want to use in a session.

To import audio files or regions from disk:

- Choose File > Import > Audio to Track to import files and regions to new audio tracks (they will also appear as regions in the Region List).

– or –

- Choose File > Import > Audio to Region List to import files and regions to the Region List only.

To import a CD audio track:

- 1 Put the source CD into your computer’s CD drive.
- 2 Choose Window > Workspace and click the Audio CD icon to show the files on the CD.
- 3 Click the speaker icon in the waveform column of the Workspace browser to audition the corresponding file. Press the Spacebar to stop playback.

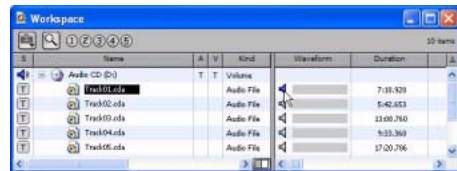

Auditioning an audio file in the Workspace Browser

4 Do one of the following:

- Drag audio files from the Workspace browser to the Track List in the Edit window to import the files to new audio tracks (they will also appear as regions in the Region List).

– Or –

- Drag audio files from the Workspace browser to the Region List in the Edit window to import the files to the Region List only.

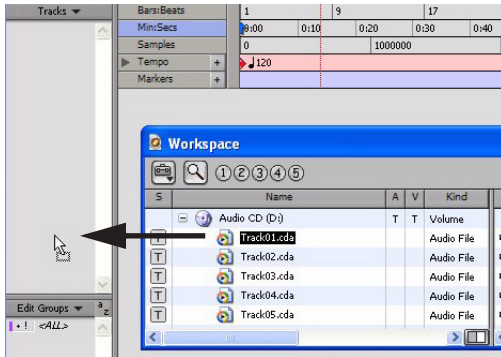

Dragging an audio file from the Workspace Browser to the Edit window Track List

 For more information on searching, auditioning, and importing audio with DigiBase, refer to the DigiBase Guide.

Importing MIDI

Pro Tools lets you import MIDI files into the Region List or directly into MIDI tracks in a session.

To import MIDI files into the Region List:

- Choose File > Import > MIDI to Region List.

To import MIDI files to tracks:

1 Choose Window > Workspace and locate the MIDI files you want to import.

2 Drag MIDI files from the Workspace browser to the Track List.

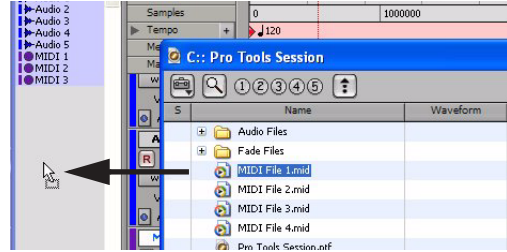

Dragging a MIDI file from the Workspace Browser to the Edit window Track List

3 In the Import MIDI Settings dialog, choose the import location and settings for the MIDI you are importing.

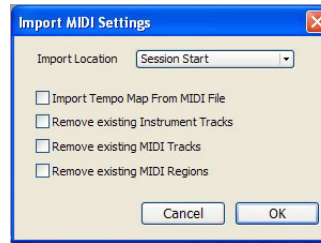

Import MIDI Settings dialog

Importing Files from Windows Explorer and Macintosh Finder

Pro Tools lets you drag and drop audio, MIDI, region group, REX, and ACID files directly from Windows Explorer or Macintosh Finder to the Timeline or the Region List of a Pro Tools session.

 For more information on importing data into Pro Tools sessions, see the Pro Tools Reference Guide.

Basic Recording

This section describes how to record audio and MIDI into Pro Tools LE.

Preparing for Recording

To prepare an audio track for recording:

- 1 Verify the connections to your microphones or instruments. Refer to Chapter 4, “Mbox 2 Hardware and Connections” for more information about connecting microphones or instruments to Mbox 2.
- 2 Choose Track > New. Specify 1 Mono or Stereo audio track (depending on your sound source) and click Create.
- 3 In the Mix window, click the Audio Input Path selector on the new track.

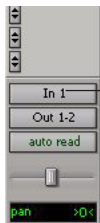

Audio Input Path selector

Routing an input to a mono track

- 4 From the pop-up menu, select the interface input you want to record. For example, select In 1 if your audio source is plugged into an Input 1 jack on the back of the Mbox 2. Select In 1–2 if your audio source is stereo and is connected to Input 1 and Input 2 connectors.



Routing an input to a stereo track

 *Mbox 2 lets you record as many as four tracks simultaneously, by creating and assigning tracks to analog inputs 1–2 and S/PDIF digital inputs 3–4 (left and right).*

Setting Input Levels

Input levels are adjustable using the gain knobs on the front of Mbox 2. You can also adjust input signal levels at the source.

When you feed a signal into Pro Tools, make sure to adjust the input level to optimize the dynamic range and signal-to-noise ratio of the recorded file. If the input level is too low, you will not take full advantage of the dynamic range of your Pro Tools system. If the input level is too high, the waveform will be clipped, distorting the recording.

Try to set levels so that they register within the top 6 dB of the input meter without triggering the clipping indicator. on your audio interface.

 *Set input levels to avoid clipping. Clipping is indicated by the red Peak LEDs on the front of the Mbox 2, and by the red indicator at the top of each on-screen meter.*

To adjust input levels on Mbox 2:

- 1 Play the instrument or sound source at the volume you will record.
- 2 Using the Gain controls on Mbox 2, increase or decrease gain until you are able to achieve maximum levels without clipping.

To adjust the monitoring balance on Mbox 2:

- Using the Mix controls on the front of the Mbox 2, do one of the following:
 - To hear only the input signal, turn the Mix control fully left to Input.
 - To hear an equal mix of playback and input signals, turn the Mix control to the center.

Recording an Audio Track

To record an audio track:

- 1 Assign the input for a track and set its input levels.
- 2 Click the Track Record Enable button.



Record enabling a track in the Mix window

- 3 Choose Window > Transport to display the Transport window.

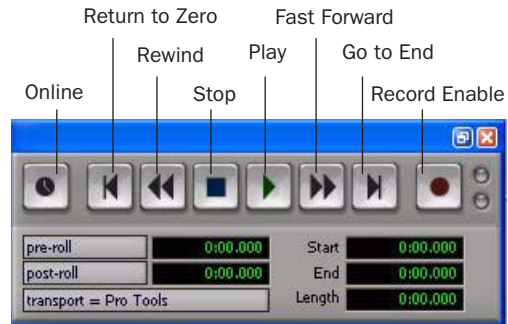

Transport window (Expanded view shown)

- 4 Click Return To Zero to start recording from the beginning of the session. You can also record to a selection in a track, or from the cursor location in the Edit window.
- 5 Click Record Enable in the Transport window to enable recording.
- 6 Click Play or press the Spacebar to record on all record-enabled tracks.
- 7 Record your performance.
- 8 Click Stop in the Transport window or press the Spacebar when you are finished recording.

To play back a recorded track:

- 1 Click the track's Record Enable button a second time to take it out of Record mode.
- 2 On the front of the Mbox 2, turn the Mix control fully right to Playback.
- 3 Click Play in the Transport window or press the Spacebar to start playback.
- 4 Click Stop in the Transport window or press the Spacebar to stop playback.

Recording MIDI

Instrument tracks combine a MIDI track and Auxiliary Input into a single channel strip that provides both MIDI and audio capabilities. Instrument tracks let you record MIDI and monitor audio from software and hardware instruments.

To create an Instrument track and configure it for recording:

- 1 Choose Setup > MIDI > Input Devices and make sure your input device is selected in the MIDI Input Enable window, and Click OK.
- 2 Choose Track > New and specify 1 Mono Instrument Track, then click Create.
- 3 Select View > Mix Window > Instruments to display the MIDI controls at the top of the Instrument track in the Mix window.
- 4 Click the track's MIDI Input selector and assign the device and channel to be recorded, or leave it set to All.

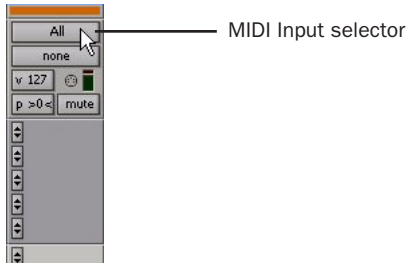

MIDI Input selector in an Instrument track

5 Do one of the following, depending on the type of instrument you are using:

- If you are using an instrument plug-in, click an Insert selector and insert the plug-in on the Instrument track. The track's MIDI output is automatically assigned to the instrument plug-in.

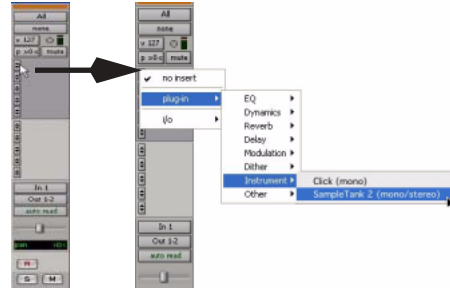

Inserting an instrument plug-in on an Instrument track

- If you are using an external MIDI device, click the track's MIDI Output selector (at the top of the Instrument track) and assign the device and channel to receive the MIDI output (the choices will vary depending on the device).

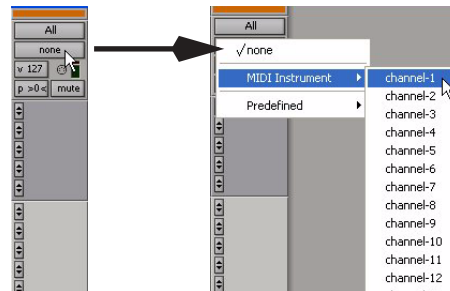

MIDI Output selector in an Instrument track

 If your connected MIDI device does not appear, check that you have configured your computer and its MIDI settings. See Appendix A, “Configuring MIDI Studio Setup (Windows Only)” or Appendix B, “Configuring AMS (Mac OS X Only)” for more information.

6 You can assign a default program change to the track by clicking the Patch Select button in the Mix window and making the necessary selections for program and bank select, and then clicking Done. Default program changes are sent when playing the track.



Patch Select button

Patch Select button in an Instrument track

7 If you are using an external MIDI device and connected its audio output to an audio interface for monitoring in Pro Tools, click the Input selector of the Instrument track and choose the corresponding audio input.

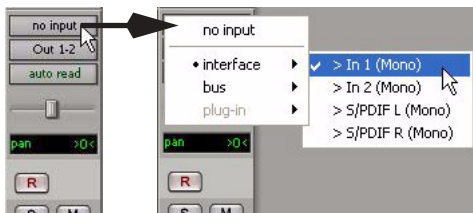

Choosing an audio input for an Instrument track

8 Click the Track Record Enable button to enable the Instrument track for MIDI recording.

9 Make sure Options > MIDI Thru is selected.

10 Play some notes on your MIDI controller and look for the track's MIDI Velocity meter to move. Remember, MIDI is not audio, and the MIDI Velocity meter is not registering sound output, but MIDI activity.

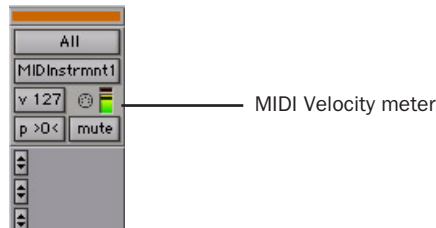

MIDI Velocity meter

MIDI meter in Instrument track showing MIDI activity

11 Adjust the audio output level of the Instrument track with its Volume fader.

To record MIDI on the Instrument track:

1 Verify that the Instrument track you want to record to is record-enabled and receiving MIDI.

2 In the Transport window, click Return To Zero to start recording from the beginning of the session. You can also record to a selection in a track, or from the cursor location in the Edit window.

3 Click Record Enable in the Transport window.

4 Do one of the following:

- Click Play in the Transport window or press the Spacebar to begin recording.
- If you are using Wait for Note, the Play, Record, and Wait for Note buttons flash. Recording begins when the first MIDI event is received.
- If you are using Countoff, click Play. The Record and Play buttons flash during the Countoff, then recording begins.

5 Play your MIDI controller or input device.

6 When you have finished recording, click Stop in the Transport window, or press the Spacebar. The newly recorded MIDI data appears as a MIDI region on the track in the Edit window, as well as in the Region List.

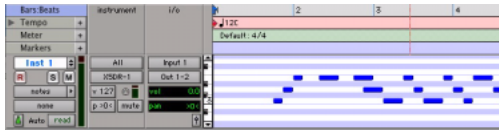

MIDI data in the Instrument track

To play back recorded MIDI data:

- 1 Click the Record Enable button to take the Instrument track out of Record mode.
- 2 In the Transport window, click Return To Zero to play back from the beginning of the track.
- 3 Click Play in the Transport window to begin playback. The recorded MIDI data plays back through the track's assigned instrument and channel.

Editing

Pro Tools LE provides several tools for editing audio and MIDI. In the Edit window, audio and MIDI tracks can be edited into regions or repeated in different locations to create loops, re-arrange sections or entire songs, or to assemble tracks using material from multiple takes.

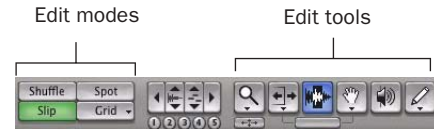

Edit modes and tools

Audio and MIDI editing are typically used to:

- Fix or replace mistakes
- Re-arrange songs and projects
- Clean up track timing and rhythm by aligning hits to Grid values like bars and beats, or grooves
- Create final tracks using selections from multiple takes (also known as *comp tracks*).

Edit Modes

Pro Tools LE has the following Edit modes: Shuffle, Spot, Slip, and two Grid modes, Absolute (standard Pro Tools Grid mode), and Relative.

The Edit mode is selected by clicking the corresponding button in the upper left of the Edit window.

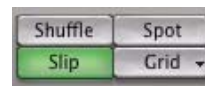

Edit mode buttons

 Press F1 (Shuffle), F2 (Slip), F3 (Spot), and F4 (Grid) to set the Edit mode.

The Edit mode affects the movement and placement of audio and MIDI regions (and individual MIDI notes), how commands like Copy and Paste function, and also how the various Edit tools (Trimmer, Selector, Grabber, and Pencil) work.

 For detailed descriptions of the Edit modes, see the *Pro Tools Reference Guide*.

Edit Tools

Pro Tools LE has seven Edit tools: Zoomer, Trimmer, Selector, Grabber, Scrubber, Pencil, and Smart Tool. Select an Edit tool by clicking it in the Edit window. The Zoomer, Trimmer, Grabber, and Pencil tools have multiple modes, which you can select from a pop-up menu when you click the tool.

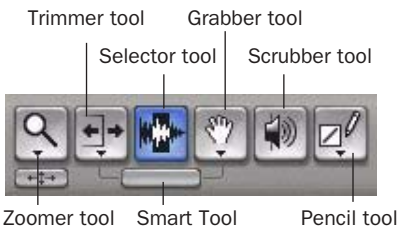

Edit tools in Edit window

 Press the **Escape** key to toggle through the Edit tools.

 For detailed descriptions of the Edit Tools, see the *Pro Tools Reference Guide*.

Playlists and Nondestructive Editing

Playlists let you create and retrieve multiple versions of track edits. A playlist can be a complete take, an overdub, or an arrangement of selections from multiple takes. You can duplicate playlists to save edits in their current state, then continue making additional edits to the new playlist, knowing you can always go back to the previous version.

To create multiple playlists for editing:

- 1 Start with a track on which you want to try different edits.
- 2 From the Playlist selector's pop-up menu, choose Duplicate.

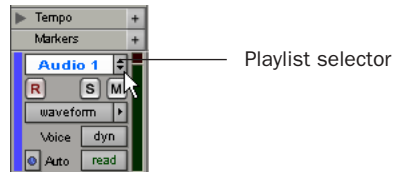

Playlist selector and pop-up menu

- 3 Name the duplicated playlist and click OK.
- 4 Make your first series of edits.
- 5 Return to the original playlist by clicking the Playlist selector and selecting its name.
- 6 Repeat steps 2–5 for any further edits.

In this way, you can try out different edits of a track, and switch back and forth between playlists for comparison.

Editing Regions

The Edit tools in Pro Tools LE are used to edit regions in the Edit window.

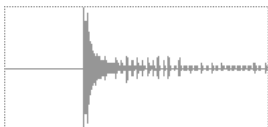

Audio region

Trimming Regions

After recording an audio track, you will have an audio region on that track. If there is some silence at the beginning of the region, or there is some extra audio at the end of the region, you can use the Trimmer tool in Slip mode to shorten the beginning or end of the region.



Audio region on a track

To trim an audio region:

- 1 Select Slip mode.
- 2 Select the Trimmer tool.
- 3 Move the cursor near the beginning of the audio region (notice the cursor displays as a “[”).



Trimming the beginning of a region

- 4 Click at the beginning of the region and drag right to shorten the region.

- 5 Move the cursor near the end of the audio region (notice the cursor displays as a “]”).



Trimming the end of a region

- 6 Click at the end of the region and drag left to shorten the region.



The trimmed region

You can also extend a region using the Trimmer tool if there is audio data beyond the current boundaries of the region. To extend the region's beginning, drag to the left; to extend the region's end, drag to the right.

Arranging Regions

There are many ways to edit and arrange regions; the following example demonstrates how you might create and arrange a drum loop to compose a rhythm track.

To create and arrange a rhythm sequence:

- 1 Open or create a session in Pro Tools LE.
- 2 Set the session meter and tempo by doing the following in the Edit window:
 - Click the Ruler View selector and select both Tempo and Meter.
 - Click the Add Tempo Change button and specify the tempo.

- Click the Add Meter Change button and specify the meter.

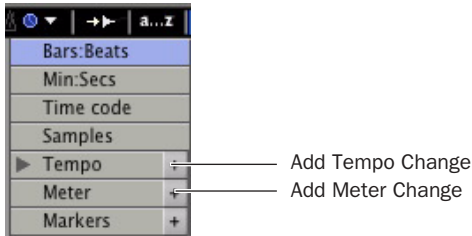

Add Tempo Change and Add Meter Change buttons

3 Click the Grid mode button to put Pro Tools in Grid mode.

4 Prepare to record using a click (see “Using the Click Plug-In” on page 41 or “Using an External MIDI Click” on page 42).

5 Record a drum track (see “Recording an Audio Track” on page 54) keeping in mind that you want to use only the best bar (measure). Your recording should fit the grid at the specified tempo and meter.

– or –

Import an existing audio file, such as a drum loop from a sample library, and place it on an audio track (see “Importing Audio” on page 51).

6 Click the Selector tool, and drag on the waveform to make a one-bar selection. Note that the selection snaps to the specified grid.

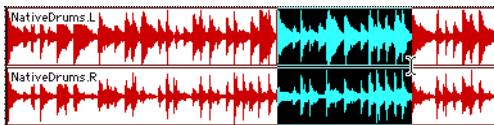

Making a selection in Grid mode

7 Choose Track > New and create a new Stereo Audio track.

8 Click the Grabber tool and select the Separation Grabber tool.

9 With the Separation Grabber tool, drag the selection to the beginning of the new audio track. A new region is created and appears at the beginning of the new track.

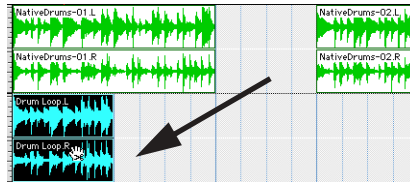

Dragging a selection with the Separation Grabber tool

10 With the new region still selected, choose Region > Loop.

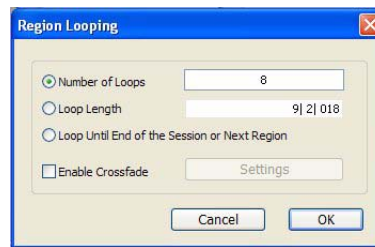

Region Looping dialog

11 In the Region Looping dialog, enter the number times you want to loop the region, and click OK.

You now have a new rhythm track with a “looped” (repeated) phrase.

You can use these editing tools and Beat Detective to do much more advanced editing of regions.

Grouping Regions

The Region Groups feature in Pro Tools lets you group regions on multiple adjacent audio, MIDI, and Instrument tracks. Region Groups are useful for groove and tempo manipulation, editing, and arranging.

 For more information on Region Groups, see the Pro Tools Reference Guide.

Mixing

The Pro Tools mix environment provides many familiar channel strip controls for setting volume, pan, solo, and mute. Mixer and I/O controls can be shown in both the Mix and Edit windows.

To view the Mix window:

- Select Window > Mix.



Press Control+Equals (=) (Windows) or Command+Equals (=) (Macintosh) to switch between the Edit and Mix windows.

Using Channel Strip Controls

The following controls are common to Audio, Auxiliary Input, and Instrument tracks.

Volume Fader Increase or decrease the track level by dragging its Volume fader up or down.

Pan Slider Pan a track left or right in the mix by dragging its Pan slider left or right.

Solo Button Solo a track (muting all other tracks) by clicking its Solo button.

Mute Button Mute a track by clicking its Mute button.

Basic Signal Routing

Signal routing is accomplished by assigning track inputs and outputs. Audio track inputs can be from any hardware input or bus path. Once recorded, an audio track's input is its audio file on disk. Auxiliary Inputs can be any hardware input or internal bus path. For all types of audio tracks, outputs can be routed to any hardware output or internal bus path.

You can use these signal routing features to set up virtually any mixer architecture for your projects, including sends and returns for effects processing and submixing.

Send and Return Submixing for Effects Processing

When you are submixing for reverb, delay, and similar effects processing, you can use sends and Auxiliary Inputs to achieve traditional send/return bussing. You can use a real-time plug-in (see "Plug-Ins" on page 63) as a shared resource for all tracks included in a submix. The wet/dry balance in the mix can be controlled using the track faders (dry level) and Auxiliary Input fader (wet, or effect return level).

Creating a Send

Pro Tools LE provides up to ten sends per audio track. A send can be mono or stereo, routing to an output or one of 32 internal bus paths.

To assign a send on a track:

- 1 Make sure the Sends you want to use are visible in the Mix window (View > Mix Window > Sends A–E or Sends F–J).
- 2 In the Mix window, click a Send selector on an audio track and choose a bus path from the pop-up menu.

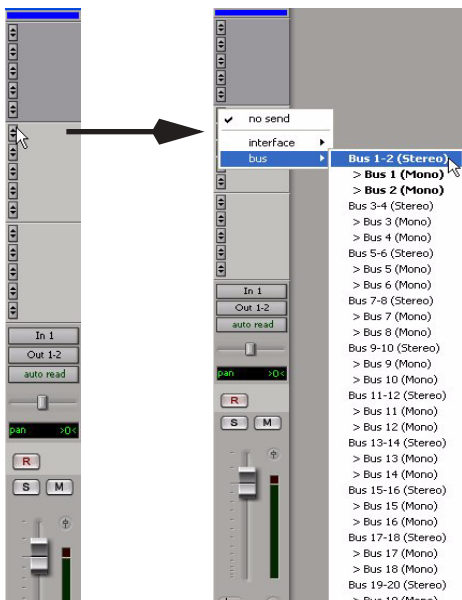

Assigning a send to a stereo bus path

- 3 Set the output level of the send. You can set the send level to zero by Alt-clicking (Windows) or Option-clicking (Macintosh) the Send fader.

 You can configure the default level for new sends to be $-\infty$ or at unity gain (0 dB) by enabling or disabling the Sends Default To “-INF” option in the Operation Preferences page.

Creating a Return

Auxiliary Input tracks can be created to act as return channels for busses, as well as for inputs from hardware sources.

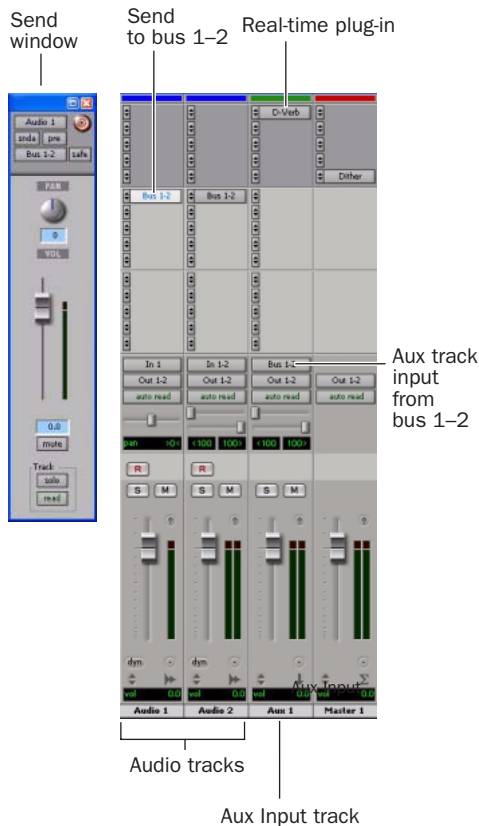

Audio and Auxiliary Input tracks configured for a send and return

To create a return:

- 1 Choose Track > New and specify 1 Mono or Stereo Auxiliary Input, then click Create.
- 2 Click the Input selector of the Auxiliary Input and set it to the bus path you assigned to the sends on the source tracks.
- 3 Click the Output selector of the Auxiliary Input and choose an output path.

Master Faders

Master Faders are used as output and bus masters, and can control any mono or stereo output or bus path in a session. You can then use the controls on the Master Fader to control the volume, solo and mute, or apply inserts to those paths.

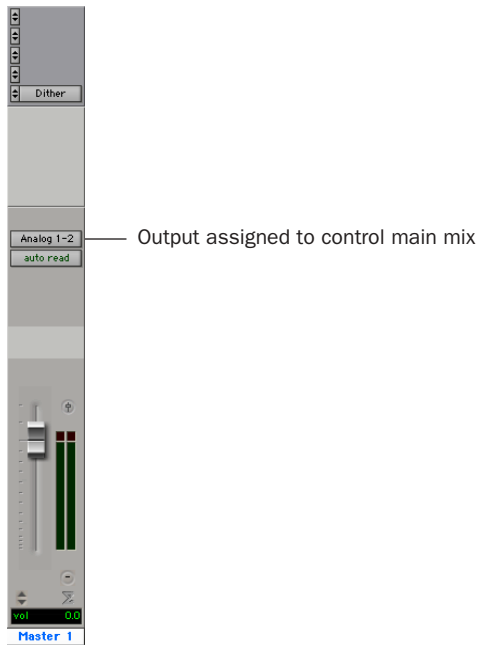

Master Fader controlling main output path

To create a Master Fader:

- 1 Choose Track > New and specify 1 Mono or Stereo Master Fader track, then click Create.
- 2 In the Mix window, click the Master Fader's Output selector and choose the output path that you want to control. You can choose either outputs or internal busses.

To use a Master Fader as a master stereo volume control for all tracks in a session:

- 1 Choose Track > New and specify 1 Stereo Master Fader track, then click Create.
- 2 Set the outputs of all audio tracks in the session to Outputs 1–2 and set the panning of each track.
- 3 Set the output of the Master Fader to your main output path (Outputs 1–2).

Plug-Ins

Plug-ins provide EQ, dynamics, delay, and many other types of effects processing, and function either in real time (RTAS) or in non-real time (AudioSuite).

RTAS plug-ins are nondestructive effects, which are inserted on tracks to process audio in real time, during playback—just like an external hardware processor.

AudioSuite plug-ins are used to process and modify audio files on disk, rather than non-destructively in real time. Depending on how you configure a non-real-time AudioSuite plug-in, it will either create an entirely new audio file, or alter the original source audio file.

Real-time plug-ins are assigned to tracks from the Inserts view in the Mix or Edit windows. Once assigned to a track, plug-ins appear in the track's Inserts view, and can be opened by clicking the Insert button.

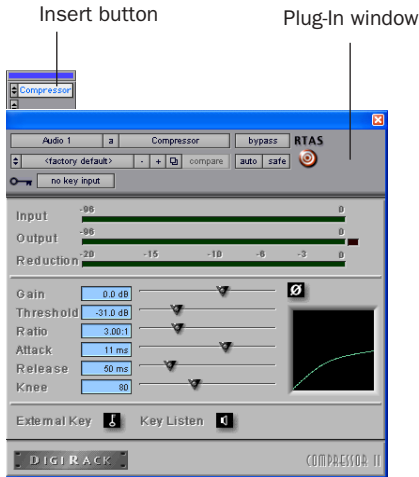

Compressor plug-in

To insert a real-time plug-in on a track:

- 1 Make sure the Inserts View is shown in the Mix or Edit window.
- 2 Click the Insert selector on the track and select the plug-in that you want to use.

Pro Tools comes with a complete set of DigiRack plug-ins, and many more are available from Digidesign and our Development Partners.

 For more information about plug-ins included with Pro Tools, see the *DigiRack Plug-Ins Guide*.

Mix Automation

Mix automation lets you record, or *automate*, changes to track volume, send levels, mutes, pan, and plug-in parameters.

To write automation:

- 1 Choose Window > Automation Enable.
- 2 In the Automation Enable window, enable an automation *type* (volume, pan, mute, send level, send pan, send mute, or any plug-in automation) by clicking its button so that it is highlighted.



Enabling automation

- 3 In each track you want to automate, select an automation *mode* with the Automation Mode selector (Write, Touch, or Latch mode).

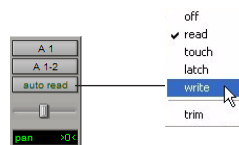

Setting the Automation mode of a track

- 4 Start playback and begin writing automation by adjusting faders and other controls during playback. Pro Tools LE remembers all moves performed on enabled parameters.

Once written, automation can be re-written or displayed and edited graphically in the Edit window.

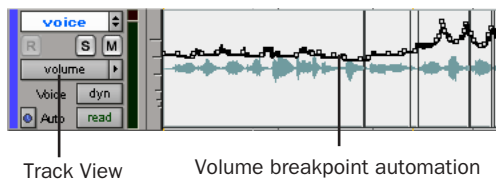

Volume automation in a track in the Edit window

 For more information on using automation, see the Pro Tools Reference Guide.

Final Mixdown

The Bounce to Disk command lets you write a final mix to disk, create a new loop, print effects, or bounce any submix. Once you have bounced your final mix to disk, you can use another program to burn the resulting file to CD.

When you bounce a track to disk, the bounced mix includes the following:

Audible Tracks All audible tracks are included in the bounce. Any muted tracks do not appear in the bounce. If you solo a track or region, only the soloed elements appear in the bounced mix.

Automation All read-enabled automation is played back and incorporated in the bounced mix.

Inserts and Sends All active inserts, including real-time plug-ins and hardware inserts, are applied to the bounced mix.

Selection or Track Length If you make a selection in a track, the bounced mix will be the length of the selection. If there is no selection in any track, the bounce will continue until it reaches the end of the session.

To Bounce to Disk:

- 1 Choose File > Bounce to > Disk.
- 2 Select any mono or stereo output or bus path as the source for the bounce.
- 3 Select the File Type (such as WAV), Format (such as mono or stereo), Resolution (such as 16-bit), and Sample Rate (such as 44.1 kHz).



To create a mixdown that can be written to an audio CD, be sure to select WAV, stereo interleaved, 16-bit, 44.1 kHz.

- 4 If you are changing the sample rate of the bounced file, choose a Conversion Quality setting.
- 5 Click Bounce.

Using Dither on Mixdown

You should use a dither plug-in whenever you are bouncing or mixing down audio to a lower bit depth (for example, when mastering a 24-bit session to 16-bit resolution for release on an audio CD.)

If you are bouncing or mixing down audio for reuse at the same bit depth (for example, for transfer from one 24-bit capable system to another), you do not need to dither the output.

It is preferable to use Master Faders instead of Auxiliary Inputs for applying dither, because Master Fader inserts are post-fader. With a Master Fader, any changes to the track's Volume fader will be processed by the dither plug-in.

To dither audio for mixdown:

- 1** Create a Master Fader and assign it to control the output path for the audio you want to mix down or bounce.
- 2** Insert the included POW-r Dither plug-in (or another dither plug-in) on the Master Fader, after any other plug-ins or inserts on the track.
- 3** In the dither plug-in window, click the Bit Resolution button and select the destination bit depth (20-bit or 16-bit).
- 4** In the dither plug-in window, click the Noise Shaping button and select a Noise Shaping setting. Type 1 is appropriate for mono files, and Type 2 or Type 3 are appropriate for stereo files.
- 5** Choose File > Bounce to Disk to perform the mixdown.

Sample Rate Conversion on Mixdown

When you specify a different sample rate for a bounced file (for example, when mixing down a session recorded at 48 kHz to 44.1 kHz for release on an audio CD), a Conversion Quality setting becomes available in the Bounce to Disk dialog.

There are five possible Conversion Quality settings, ranging from Low (lowest quality) to TweakHead (highest quality). The higher the quality of sample rate conversion, the longer it takes to convert the bounced file.

 *For more information on using dither and sample rate conversion when mixing down, see the Pro Tools Reference Guide.*

appendix a

Configuring MIDI Studio Setup (Windows Only)

MIDI Studio Setup

MIDI Studio Setup (MSS) lets you configure the MIDI controllers and sound modules that are connected to your system, and control the routing of MIDI data between your MIDI equipment and Pro Tools.

MSS automatically finds MIDI interfaces, and lets you specify a custom name for each of the MIDI ports within the MIDI Studio Setup document.

MSS also supports XML-based patch file names for storing and importing patch names for your external MIDI devices.

Entire MIDI Studio Setup configurations created within MSS can be imported and exported.

MIDI Studio Setup Window

The MIDI Studio Setup window is organized into three sections. Interface controls are at the top of the window. All the currently defined instruments are displayed in the Instrument Name list on the left side of the window. A detailed view of MIDI parameters is shown in the Properties section on the right.

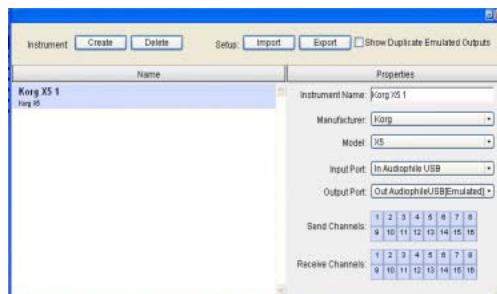

MIDI Studio Setup window

Interface Controls

Create This button adds a new instrument to the Instrument Name list.

Delete This button deletes the instrument or instruments selected in the Instrument Name list.

Import This button lets you import an existing MIDI Studio Setup file.

Export This button lets you export the current MIDI Studio Setup file.

Show Duplicate Emulated Ports When this option is selected and you are using a MIDI interface that supports timestamping (such as MIDI I/O), in addition to the MIDI ports on Mbox 2, the MIDI Studio setup window shows both the DirectMusic time-stamped output ports, and non-stamped duplicate emulated output ports.

⚠ *Some MIDI Interfaces will not properly load or unload their drivers unless you quit and re-launch Pro Tools. Check the documentation that came with your MIDI interface for more information.*

Instrument List

The Instrument list contains all the currently defined instruments. Selecting an instrument in the list displays that instrument's properties in the Properties section of the window.

Properties Section

The Properties section lets you edit information for new instruments, or instrument currently selected in the Instrument list.

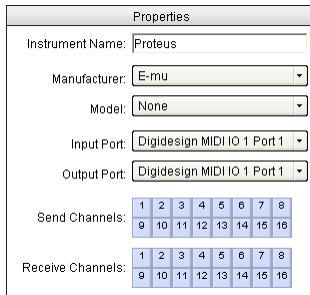

MIDI Studio Setup Properties section

When a previously defined instrument is selected in the Instrument list, the Properties section changes to reflect the properties of the selected instrument.

To define an instrument with MIDI Studio Setup:

- 1 Choose Setup > MIDI > MIDI Studio.
- 2 Click Create.
- 3 In the Instrument Name field, type the name of your instrument, and press Enter.



If you do not enter an instrument name, the Instrument Name field will automatically inherit information from the Manufacturer and Model pop-up menu.

- 4 Set a manufacturer and model for the new device from the corresponding pop-up menus. If the Manufacturer and Model pop-up menus do not provide a name for your particular device, choose None.
- 5 From the Input pop-up menu, choose the input port on your MIDI interface that is connected to the MIDI Out of your instrument.
- 6 From the Output pop-up menu, choose the output port on your MIDI interface that is connected to the MIDI In of your instrument.
- 7 Enable the appropriate MIDI channels (1–16) for the Send Channels and Receive Channels options (These determine which channels send and receive MIDI.)

Instrument Name

The Instrument Name field shows the user-definable instrument name for the currently selected instrument.

Manufacturer

The Manufacturer pop-up menu provides a list of MIDI equipment manufacturers. This list is derived from the XML-based MIDI device files.



For more information, see “MIDI Patch Name Support” on page 69.

Model

The Model pop-up menu provides a list of MIDI devices, filtered by the manufacturer name. This list is derived from the XML-based MIDI device files provided with your Pro Tools installation.

 For more information, see “MIDI Patch Name Support” on page 69.

Input Port

The Input Port pop-up menu displays a list of available MIDI interface input ports. Inputs will include Mbox 2 and any additional MIDI interfaces enabled on your system. The MIDI interface port that is set and displayed here is the port through which MIDI data is sent from the external MIDI device specified in the Instrument Name field into your MIDI interface.

 *If you set the input port to None, the defined instrument will not appear as a choice in a MIDI Input selector.*

Output Port

The Output Port pop-up menu displays a list of available MIDI interface output ports. The port set and displayed here is the port through which MIDI data is sent from your MIDI interface to the MIDI device specified in the Instrument Name field.

 *If you set the output port to None, the defined instrument will not appear as a choice in a MIDI Output selector.*

Send Channels

The Send Channels grid sets the send channels for the MIDI device specified in the Instrument Name field.

Receive Channels

The Receive Channels grid sets the receive channels for the MIDI device specified in the Instrument Name field.

MIDI Patch Name Support

Pro Tools supports XML (Extensible Markup Language) for storing and importing patch names for your external MIDI devices. Pro Tools installs MIDI patch name files (.midnam) for the factory default patch names of many common MIDI devices. These files reside in directories, sorted by manufacturer, in Program Files \ Common Files \ Digidesign \ MIDI Patch Names \ Digidesign.

To import MIDI patch names into Pro Tools:

- 1 Verify the MIDI Device name in the MIDI Studio Setup window (see “MIDI Studio Setup” on page 67).
- 2 Verify the MIDI track’s output is correctly assigned to the MIDI device.

3 Click the MIDI track's Patch Select button.

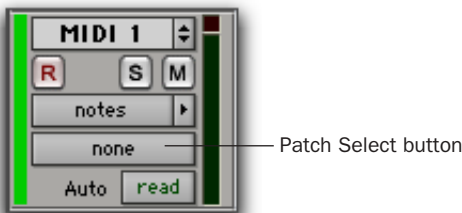

Patch Select button, Edit window



Patch Select button, Mix window

4 In the Patch Select dialog, click the Change button.

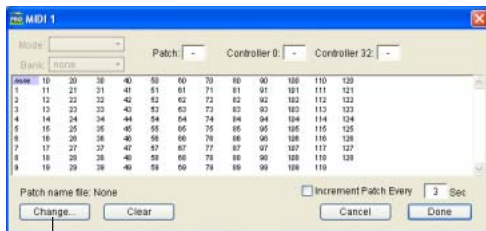

Change button

Patch Select dialog

5 In the Open dialog, navigate to Program Files\Common Files\Digidesign\MIDI Patch Names\Digidesign\

6 Click Open.

The Patch Select dialog is populated with patch names and the Patch Name Bank pop-up menu appears in the upper left hand corner of the window.

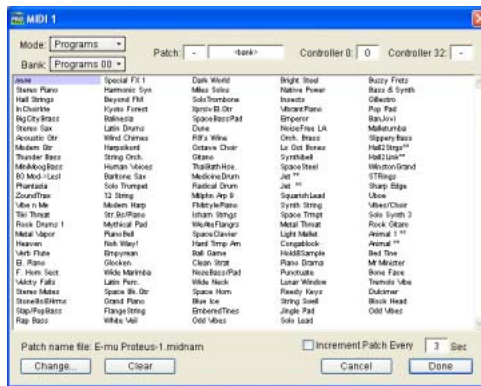

Patch Select dialog with patch names

Once patch names have been imported into Pro Tools, they are available for that MIDI device in all sessions.

To clear patch names:

- In the Patch Select dialog, click the Clear button, and click Done.



MIDI patch name files (.midnam) can be edited in any text editor, or you can use third party patch librarian and editor software to create your own custom patch names.

appendix b

Configuring AMS (Mac OS X Only)

Audio MIDI Setup

Pro Tools recognizes the ports on your MIDI interface as generic ports. With Mac OS X, you use Apple's Audio MIDI Setup (AMS) utility to identify external MIDI devices connected to your MIDI interface and configure your MIDI studio for use with Pro Tools.

To configure your MIDI studio in AMS:

1 Launch Audio MIDI Setup (located in Applications/Utilities).

– OR –

In Pro Tools, choose Setup > MIDI > MIDI Studio.

2 Click MIDI Devices. AMS scans your system for connected MIDI interfaces. If your MIDI interface is properly connected, it appears in the window with each of its ports numbered.



Audio MIDI Setup (MIDI Devices)

3 For any MIDI devices connected to the MIDI interface, click Add Device. A new external device icon with the default MIDI keyboard image will appear.

4 Drag the new device icon to a convenient location within the window.

5 Connect the MIDI device to the MIDI interface by clicking the arrow for the appropriate output port of the device and dragging a connection or “cable” to the input arrow of the corresponding port of the MIDI interface.

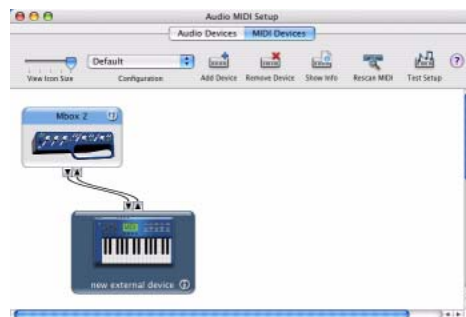

Making MIDI input and output connections

6 Click the arrow for the appropriate input port of the device and drag a cable to the output arrow of the corresponding port of the MIDI interface.



To remove a connection, select the cable and press Delete. To delete all connections, click Clear Cables.

7 Repeat steps 3–6 for each MIDI device in your MIDI setup.

To configure an external MIDI device:

1 Select the external device icon and click Show Info (or double-click the new device icon).

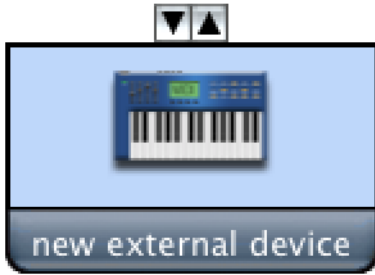

External Device Icon

2 Select a manufacturer and model for the new device from the corresponding pop-up menus. (If the Manufacturer and Model pop-up menus do not provide a name for your particular device, you can type a name.)



Naming a new MIDI device

💡 For Manufacturer and Model names, AMS refers to one or more files with the suffix “.middev” in the directory Root/Library/Audio/MIDI Devices. Pro Tools installs a file that contains information for many commercially available MIDI devices, named “Digidesign Device List.middev.” If the Manufacturer or Model names for any of your external MIDI devices is not available in the AMS Manufacturer and Model pop-up menus, you can add them by editing the .middev file in any text editor (such as TextEdit).

3 Click the More Properties arrow to expand the dialog, then enable the appropriate MIDI channels (1–16) for the Transmits and Receives options. (These determine which channels the device will use to send and receive MIDI.)

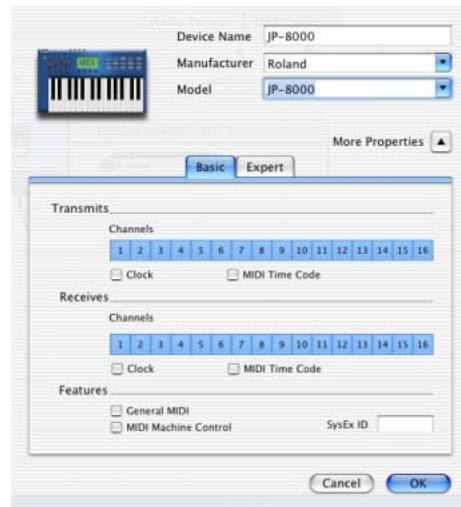

Enabling MIDI channels

4 Click the device image. The window expands to show images for various MIDI devices (such as keyboards, modules, interfaces, and mixers). Select an icon for your device.



Selecting a device icon

 To use your own custom icons, you can place TIFF image files in /Library/Audio/MIDI Devices/Generic/Images, and they will appear as choices in the AMS device window.

5 Click OK.

The device names you enter appear as MIDI input and output choices in Pro Tools.

MIDI Patch Name Support

Pro Tools supports XML (Extensible Markup Language) for storing and importing patch names for you external MIDI devices. Pro Tools installs MIDI patch name files (.midnam) for the factory default patch names of many common MIDI devices. These files reside in directories, sorted by manufacturer, in /Library/Audio/MIDI Patch Names/Digidesign.

To import MIDI patch names into Pro Tools:

- 1 Verify the MIDI Device name in the Audio MIDI Setup window (see “Audio MIDI Setup” on page 71).
- 2 Verify the MIDI track’s output is correctly assigned to the MIDI device.
- 3 Click the MIDI track’s Patch Select button.



Patch Select button, Edit window



Patch Select button, Mix window

4 In the Patch Select dialog, click the Change button.

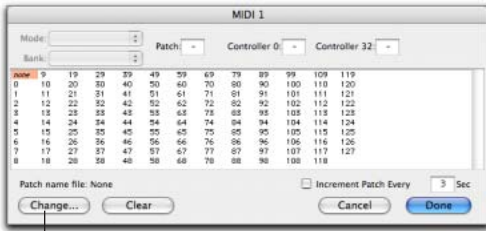

Change button

Patch Select dialog

5 In the Open dialog, navigate to /Library/Audio/MIDI Patch Names/Digidesign/<name of manufacturer>, and select the MIDI Patch Name file (.midnam) for the MIDI device.

6 Click Open.

The Patch Select dialog is populated with patch names and the Patch Name Bank pop-up menu appears in the upper left hand corner of the window.

Once patch names have been imported into Pro Tools, they are available for that MIDI device in all sessions.

To clear patch names:

- In the Patch Select dialog, click the Clear button, and click Done.



MIDI patch name files (.midnam) can be edited in any text editor, or you can use third party patch librarian and editor software to create your own custom patch names.

Appendix C: Troubleshooting

Backing Up Your Work

It is highly recommended that you back up your work on a regular basis, and especially before making changes to your system configuration.

Backing Up Your Session Data

Back up your session and audio data frequently. There are a variety of media that are suited to back up projects of various sizes, from automated tape backup systems to high-capacity optical drives, or to CD burners.

The best way to back up an entire session is to use the Save Copy In command. This command lets you save the session file and all of its associated files to a new location.



You can also use the Auto Save Backup feature (in the Operation Preferences page) to have Pro Tools automatically save backups of the session file while you work.

Backing Up Your System Configuration

After configuring your system and Pro Tools, you should save an image of your system drive using a backup utility such as Norton Ghost (Windows) or Bombich Carbon Copy Cloner (Macintosh). By doing this, you can quickly restore your system configuration and settings if you encounter any problems.

Common Issues

Pro Tools Won't Launch

Problem

When you double-click the Pro Tools application or a Pro Tools session file, Pro Tools doesn't launch, or displays an error message.

Possible Solutions

- ◆ Check to be sure your computer has the required amount of RAM to launch Pro Tools. See the compatibility page of the Digidesign Web site (www.digidesign.com/compato).
- ◆ Try a complete restart. Turn off your audio interfaces, computer peripherals and your computer, and then turn them on again in the proper sequence.
- ◆ If you tried to launch Pro Tools by double-clicking a Pro Tools session file, do the following:
 - Close any error message.
 - Double-click the Pro Tools application.
 - In Pro Tools, choose File > Open Session to open the session.
- ◆ Reinstall the Pro Tools application, using the Pro Tools Installer CD. See your *Getting Started Guide* or *Pro Tools Upgrading Guide* for installation instructions.

Audio Interface Is Not Recognized

Problem

When you launch Pro Tools it does not recognize an audio interface, or a connected audio interface is not available.

Possible Solutions

 For the following possible solutions, refer to your *Getting Started Guide*.

- ◆ Turn off your computer and check to be sure your cables are properly and securely connected to your computer and to your audio interface.
- ◆ Verify that your Hardware Setup dialog settings are correct.

Performance Factors

There are several conditions that may adversely affect the performance of Pro Tools. These include:

Network Connections Close any network connections unless you are using them for network interchange of audio data.

Background Applications Any software utilities that run in the background or generate disk activity, such as virus protection, disk optimization, or file savers, should be turned off or removed.

Screen Savers Screen saver software should be completely disabled on your computer before running Pro Tools.

Power Saver Features Some automatic power saver features, such as those that spin down the system hard drive, can affect Pro Tools performance. These features should be turned off.

Before You Call Digidesign Technical Support

Register Your System

Register your purchase immediately after reviewing the registration information card included with every Pro Tools system. Registering your purchase is the only way you become eligible to receive complimentary technical support and future upgrade offers. Registering is one of the most important steps to complete as a new user.

Use Digidesign Resources

In addition to the printed and PDF versions of Pro Tools guides, your system includes the following sources of information:

Read Me Files These contain late-breaking information and known issues pertaining to Pro Tools software and hardware configurations. Read Me files are installed in Documentation folder when you install Pro Tools.

Answerbase This is a database of common problems and DAE errors, and their solutions based on the latest information from Digidesign Technical Support. This database is installed in the Digidesign folder when you install Pro Tools. Answerbase is also available on the Digidesign Web site (www.digidesign.com).

Web Site (www.digidesign.com) This is your best online source for information to help you get the most out of your Pro Tools system.

Gather Important Information

Digidesign wants to help you resolve problems as quickly and efficiently as possible. If you have the following information handy when you contact Technical Support, it will make the diagnosis of your problem easier. Take a few minutes to collect the following basic information:

System Information

Computer

- Make, model, processor speed
- Amount of system RAM
- Operating system (version of Windows or Mac OS)
- Any Drivers, Disk Utilities, or other system-related applications you may have installed

Digidesign Hardware

- Type of cards, interfaces, or peripherals

Hard Drives

- Make, Model
- Drive size (GB)
- Drive speed (RPM)
- Drive type (SCSI, FireWire, IDE/ATA)
- Utility used to format the drive
- Number and size of partitions on the drive

Digidesign Software

- Pro Tools software version
- Plug-in versions
- Other Digidesign software
- Additional plug-ins from Digidesign Development Partners

Other Hardware

Refer to the manufacturer's documentation for operational details.

The most common hardware additions include:

- 1394 (FireWire) cards for Windows systems (manufacturer, model)
- Video Capture cards (manufacturer, model)

To verify that your hardware is qualified for use with your Pro Tools system, refer to the compatibility page of the Digidesign Web site (www.digidesign.com/compato).

Other Software

If you are using other audio or video applications, refer to the manufacturer's documentation for operational details.

Make note of any other software that was running when a problem occurred.

Diagnostic Information

Note any DAE errors or other error codes you encounter. Additionally, note the ability to reproduce the problem under different conditions, for example, with another session, or after changing settings (such as the Hardware Buffer Size).

index

A

- ASIO driver (Windows) 13
- audio
 - analog connections 34
 - digital connections 35
 - editing 57
 - importing 51
 - monitor connections 34
 - monitoring 33
 - routing 53, 61
- audio drivers
 - ASIO driver (Windows) 13
 - CoreAudio driver (Macintosh) 22
 - WaveDriver (Windows) 13
- Audio MIDI Setup (AMS) (Macintosh) 71
- audio tracks 44, 45
- authorizing Pro Tools LE
 - Macintosh 22
 - Windows 14
- automation 64
 - editing 65
 - writing 64
- Auxiliary Input tracks 44, 45, 61

B

- Bounce to Disk command 65

C

- channel strip controls
 - Mute 61
 - Pan 61
 - Solo 61
 - Volume 61
- click
 - external MIDI 42
 - plug-in 41
- Click plug-in 41

- Clock Source 17, 25
 - and digital output 36
 - Internal setting 17, 25
 - S/PDIF (digital) setting 17, 25
- Conductor ruler 40
- connecting Mbox 2
 - Macintosh 22
 - Windows 12
- CoreAudio driver (Macintosh) 22
- CPU Usage Limit 16, 24

D

- DAE Playback Buffer Size 16, 24
- dither 65
- drive formatting
 - Macintosh 21
 - Windows 11
- drive maintenance
 - Macintosh 21
 - Windows 10, 11
- drive requirements 3

E

- Edit modes 57
 - Grid 57
 - Shuffle 57
 - Slip 57
 - Spot 57
- Edit tools 58
 - Grabber 58
 - Pencil 58
 - Scrubber 58
 - Selector 58
 - Smart Tool 58
 - Trimmer 58
 - Zoomer 58

Edit window 38
editing 57, 59
Ethernet Support software 13

F

fade files 37

G

gain
 headphones 29
 input 31

Grabber tool 58

Grid mode 57

H

hard drives

- formatting 11, 21
- MacDrive utility 14
- maintenance 10, 21
- requirements 3
- space requirements 4

Hardware Buffer Size 15, 23

headphones

- connecting 34
- gain control 29
- output 29

I

I/O Setup

- Macintosh 25
- Windows 17

importing

- audio 51
- files with drag and drop 52
- MIDI 52

indicators

- peak level 31
- phantom power 31
- S/PDIF 29
- USB connection 29

input and output connectors 32

inputs

- analog 33
- digital 32
- gain 31
- monitoring 30

inserts

- plug-ins 64

installing Pro Tools LE

- Macintosh 21
- Windows 12

installing QuickTime (Windows) 12

Instrument tracks 44, 47

K

key commands 6

L

latency

- see monitoring

Link Timeline and Edit Selection option 48

M

MacDrive utility (Windows) 14

Master Faders 44, 45, 63

Mbox 2

- back panel 32
- connecting (Macintosh) 22
- connecting (Windows) 12
- features 2
- front panel 29
- removing the handle 31

memory locations 48

- defining 48
- recalling 49
- using for zoom control 51

Meter ruler 40

MIDI

- connections 36
- editing 57
- importing 52
- requirements 3
- setup (Macintosh) 71
- setup (Windows) 67

- MIDI controls 46, 47
 - MIDI Input selector 55
 - MIDI Output selector 55
 - MIDI Velocity meter 56
 - Patch Select button 56
- MIDI Studio Setup (MSS) (Windows) 67
- MIDI tracks 44, 46
- mix automation 64
- mix control (Mbox 2) 30
- Mix window 38, 61
- mixdown 65
 - and bit resolution 65
 - and sample rate conversion 66
- mixing 61
- monitoring 33
 - when overdubbing 30
 - with headphones 33
 - zero latency 30
- mono switch 30
- Mute button 61

N

- network connections 76

O

- outputs
 - digital 32
 - Monitor outputs 33
 - S/PDIF mirroring 35

P

- Pan slider 61
- Patch Select dialog
 - Macintosh 74
 - Windows 70
- peak indicators 31
- Pencil tool 58
- phantom power 35
 - indicator 31
 - when to use 31
- playback
 - audio 54
 - MIDI 57
 - starting and stopping 44
- Playback Engine dialog 43
- playlists 58

- plug-ins 63
 - AudioSuite 63
 - Click 41
 - dither 65
 - inserting on tracks 64
 - RTAS (Real-Time AudioSuite) 63
- power management settings
 - Macintosh 20
 - Windows 8
- Pro Tools LE
 - capabilities 2
 - configuration (Macintosh) 23
 - configuration (Windows) 15
 - installing (Macintosh) 21
 - installing (Windows) 12
 - main windows 38

Q

- QuickTime
 - installing (Windows) 12

R

- ratio control (Mbox 2) 30
- recording
 - analog inputs 34
 - audio 54
 - digital inputs 35
 - MIDI 55, 56
- Region List 47
- regions 47
 - arranging 59
 - auditioning 47
 - creating 47
 - editing 59
 - grouping 60
 - looping 60
 - trimming 59
- returns 62
- RTAS Processors setting 15, 23
- rulers 40
 - Conductor 40
 - Meter 40
 - Tempo 40
 - Timebase 40

S

- S/PDIF 32
 - input indicator 29
 - mirroring 35
- Sample Rate 17, 25
- screen savers 76
- Scrubber tool 58
- Selector tool 58
- sends 45, 62
- sessions 37
 - creating 37
 - duplicating 42
 - navigating 48
 - saving 37, 42
 - saving copies of 42
- Shuffle mode 57
- Slip mode 57
- Smart Tool 58
- Solo button 61
- sources
 - analog 33
 - digital 32
 - instrument 33
 - line 33
 - microphone 33
 - selecting 31
- Spot mode 57
- submixing 61
- system optimization
 - Macintosh 19, 20
 - Windows 7, 8, 9, 10
- system requirements 3
- system settings
 - Clock Source 17, 25
 - CPU Usage Limit 16, 24
 - DAE Playback Buffer Size 16, 24
 - Hardware Buffer Size 15, 23
 - I/O Setup 17, 25
 - RTAS Processors 15, 23
 - Sample Rate 17, 25

T

- technical support
 - product registration required 76
- tempo 40, 41
- Tempo Change dialog 40
- Tempo ruler 40
- Timebase ruler 40
- Track Height selector 49
- tracks 44
 - audio 44, 45
 - Auxiliary Inputs 44, 45, 61
 - creating 44
 - Instrument 44, 47
 - Master Faders 44, 45, 63
 - MIDI 44, 46
 - playing back audio 54
 - playing back MIDI 57
 - recording audio 54
 - recording MIDI 55, 56
 - types 44
- Transport window 39, 43, 44
- Trimmer tool 58

U

- USB connection indicator 29

V

- Volume fader 61

W

- WaveDriver (Windows) 13
- windows 38
 - Edit window 38
 - Mix window 38, 61
 - Transport window 39, 43, 44

Z

- Zoom Presets 51
- Zoom Toggle 50
- Zoomer tool 58
- zooming 49



www.digidesign.com

DIGIDESIGN

2001 Junipero Serra Boulevard
Daly City, CA 94014-3886 USA
Tel: 650.731.6300
Fax: 650.731.6399

TECHNICAL SUPPORT (USA)

Tel: 650.731.6100
Fax: 650.731.6384

PRODUCT INFORMATION (USA)

Tel: 650.731.6102
Fax: 800.333.2137

INTERNATIONAL OFFICES

Visit our Digidesign Web site
for contact information