

FCB1010

MIDI FOOT CONTROLLER

User's Manual

Version 1.4 March 2003

ENGLISH

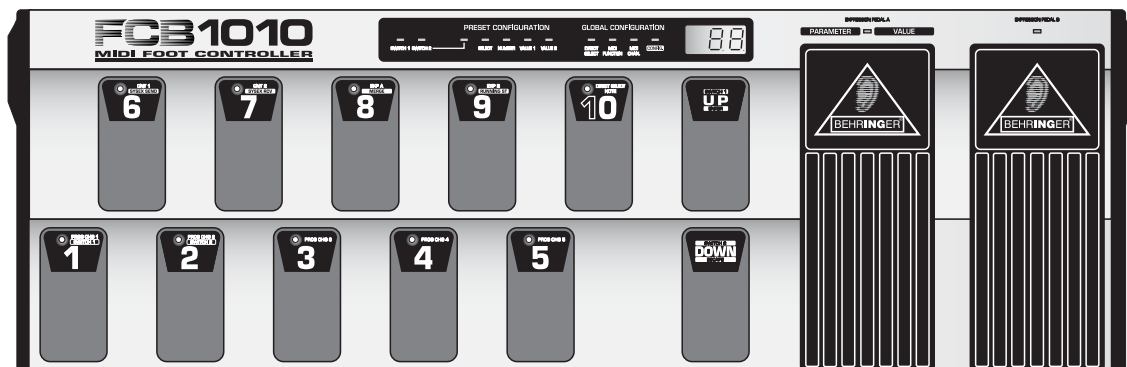

www.behringer.com



MIDI FOOT CONTROLLER FCB1010

IMPORTANT SAFETY INSTRUCTIONS



CAUTION: To reduce the risk of electric shock, do not remove the top cover (or the rear section). No user serviceable parts inside; refer servicing to qualified personnel.

WARNING: To reduce the risk of fire or electric shock, do not expose this appliance to rain and moisture.



This symbol, wherever it appears, alerts you to the presence of uninsulated dangerous voltage inside the enclosure—voltage that may be sufficient to constitute a risk of shock.



This symbol, wherever it appears, alerts you to important operating and maintenance instructions in the accompanying literature. Please read the manual.

DETAILED SAFETY INSTRUCTIONS:

- 1) Read these instructions.
 - 2) Keep these instructions.
 - 3) Heed all warnings.
 - 4) Follow all instructions.
 - 5) Do not use this device near water.
 - 6) Clean only with a dry cloth.
 - 7) Do not block any ventilation openings. Install in accordance with the manufacturer's instructions.
 - 8) Do not install near any heat sources such as radiators, heat registers, stoves, or other apparatus (including amplifiers) that produce heat.
 - 9) Do not defeat the safety purpose of the polarized or grounding-type plug. A polarized plug has two blades with one wider than the other. A grounding type plug has two blades and a third grounding prong. The wide blade or the third prong are provided for your safety. If the provided plug does not fit into your outlet, consult an electrician for replacement of the obsolete outlet.
 - 10) Protect the power cord from being walked on or pinched particularly at plugs, extension cords, and the point at which they exit the unit.
 - 11) Only use attachments/accessories specified by the manufacturer.
 - 12) Use only with the cart, stand, tripod, bracket, or table specified by the manufacturer, or sold with the device. When a cart is used, use caution when moving the cart/device combination to avoid injury from stumbling over it.
- 
- 13) Unplug this device during lightning storms or when not used for long periods of time.
 - 14) Refer all servicing to qualified service personnel. Servicing is required when the unit has been damaged in any way, such as power supply cord or plug is damaged, liquid has been spilled or objects have fallen into the device, the unit has been exposed to rain or moisture, does not operate normally, or has been dropped.

MIDI FOOT CONTROLLER

Ultra-Flexible MIDI FOOT CONTROLLER with Two Expression Pedals and MIDI Merge Function

- ▲ 10 banks of presets, each with 10 fully user-editable presets customized for BEHRINGER amplifiers, V-AMP 2 and BASS V-AMP
- ▲ Two expression pedals with freely assignable MIDI channel, controller number and range
- ▲ Simultaneous transmission of five MIDI program change commands and two MIDI controllers per preset
- ▲ MIDI NOTE commands for trigger and tap-tempo applications
- ▲ Two programmable, relais controlled SWITCH jacks, e.g. to select channels on any guitar amp
- ▲ Enhanced ergonomic design
- ▲ No need to take a seat—everything can be easily programmed while standing up
- ▲ Global Configuration allows for individual customization
- ▲ MIDI SysEx backup function
- ▲ MIDI MERGE function allows for SOFT THRU and merging of controller and input data
- ▲ Built-in power supply ensures trouble-free operation
- ▲ Open architecture for future software upgrades
- ▲ Extremely rugged construction ensures long life even under the most demanding conditions
- ▲ Manufactured under ISO9000 certified management system

MIDI FOOT CONTROLLER FCB1010

FOREWORD



Dear Customer,

welcome to the team of BEHRINGER users, and thank you very much for expressing your confidence in us by purchasing the FCB1010.

Writing this foreword for you gives me great pleasure, because it represents the culmination of many months of hard work delivered by our engineering team to achieve a very ambitious goal: to present you with an outstanding device that gives you maximum flexibility and perfor-

mance; both live on stage and in the studio. The task of designing our new FCB1010 certainly meant a great deal of responsibility, which we assumed by focusing on you, the discerning user and musician. Meeting your expectations also meant a lot of work and night shifts. But it was fun, too. Developing a product usually brings a lot of people together, and what a great feeling it is when all who participated in such a project can be proud of what they've achieved.

It is our philosophy to share our enjoyment with you, because you are the most important member of the BEHRINGER team. With your highly competent suggestions for new products you've made a significant contribution to shaping our company and making it successful. In return, we guarantee you uncompromising quality as well as excellent technical and audio properties at an extremely reasonable price. All of this will enable you to give free rein to your creativity without being hampered by budget constraints.

We are often asked how we manage to produce such high-quality devices at such unbelievably low prices. The answer is quite simple: it's you, our customers! Many satisfied customers mean large sales volumes enabling us to get better purchasing terms for components, etc. Isn't it only fair to pass this benefit on to you? Because we know that your success is our success too!

I would like to thank all of you who have made the FCB1010 possible. You have all made your own personal contributions, from the developers to the many other employees at this company, and to you, the BEHRINGER user.

My friends, it's been worth the effort!

Thank you very much,

Uli Behringer

TABLE OF CONTENTS

1. INTRODUCTION	5
1.1 Before you get started	5
1.1.1 Shipment	5
1.1.2 Initial operation	5
1.1.3 Warranty	5
1.2 The user's manual	5
1.3 Control elements	5
1.3.1 Front panel	5
1.3.2 Rear panel	6
2. PROGRAMMING THE FCB1010	6
2.1 Selecting BANKS and PRESETS	6
2.1.1 DIRECT SELECT deactivated	6
2.1.2 DIRECT SELECT activated	6
2.2 GLOBAL CONFIGURATION	7
2.2.1 DIRECT SELECT page	7
2.2.2 MIDI channel setting	7
2.2.3 CONFIG page	7
2.3 Quick start guide for PRESET programming	8
2.4 Detailed PRESET programming	9
2.4.1 Preset copy function	9
2.4.2 Programming switches	9
2.4.3 Programming program changes	9
2.4.4 Programming CONTROL CHANGES	9
2.4.5 Programming EXPRESSION PEDALS A/B	9
2.4.6 Programming the NOTE function	10
2.5 Controller toggle function	11
2.6 TAP-TEMPO function	11
2.7 Data storage	11
2.7.1 Saving the FCB1010 memory with the help of SysEx dumps	11
2.7.2 Receiving SysEx dumps	12
2.8 Restoring factory presets	12
2.9 Calibrating expression pedals A and B	12
3. APPLICATIONS	13
3.1 Basic setup	13
3.2 Expanded setup (using the switch function)	13
3.3 Connections (general)	13
4. MIDI—A STANDARD, A REVOLUTION	14
4.1 MIDI connections	14
4.2 MIDI data format	14
4.2.1 NOTE ON and NOTE OFF messages	14
4.2.2 CONTROL CHANGE messages	14
4.2.3 PROGRAM CHANGE messages	14
4.2.4 Running status	15
5. MIDI IMPLEMENTATION	15
6. SPECIFICATIONS	15
7. WARRANTY	16

MIDI FOOT CONTROLLER FCB1010

1. INTRODUCTION

Congratulations! With the BEHRINGER MIDI FOOT CONTROLLER FCB1010 you purchased an ultra-flexible controller unit for a wide range of applications, whether you are a guitarist, keyboard player or studio engineer: 10 BANKS with 10 PRESETS each and two fully user-programmable expression pedals will give you enough flexibility to manage your MIDI equipment. Guitar players will particularly appreciate the option of selecting channels using two analog SWITCHES, as they allow you to fully control both amplifier and effects from one “switching center”. And with its ultra-rugged enclosure and built-in power supply the FCB1010 is absolutely ready for the road, too. The easy-to-use programming interface gives you fun instead of frustration, and invites you to fully exploit the capabilities of your MIDI equipment.

 The following user’s manual is intended to familiarize you with the unit’s control elements, so that you can master all the functions. After having thoroughly read the user’s manual, store it at a safe place for future reference.

1.1 Before you get started

1.1.1 Shipment

The FCB1010 was carefully packed at the factory to assure secure transport. Should the condition of the cardboard box suggest that damage may have taken place, please inspect the unit immediately and look for physical indications of damage.

 Damaged units should NEVER be sent directly to us. Please inform the dealer from whom you acquired the unit immediately as well as the transportation company from which you took delivery of the unit. Otherwise, all claims for replacement/repair may be rendered invalid.

1.1.2 Initial operation

Please make sure the unit is provided with sufficient ventilation, and never place the FCB1010 on top of an amplifier or in the vicinity of a heater to avoid the risk of overheating.

 Before plugging the unit into a power socket, please make sure you have selected the correct voltage:

The fuse compartment near the power plug socket contains three triangular markings. Two of these triangles are opposite one another. The voltage indicated adjacent to these markings is the voltage to which your unit has been set up, and can be altered by rotating the fuse compartment by 180°. **ATTENTION: This does not apply to export models that were for example manufactured only for use with 120 V!**

 If you alter the unit’s voltage, you must change the fuse accordingly. The correct value of the fuse needed can be found in the chapter “SPECIFICATIONS”.

 Faulty fuses must be replaced with fuses of appropriate rating without exception! The correct value of the fuses needed can be found in the chapter “SPECIFICATIONS”.

Power is delivered via the cable enclosed with the unit. All required safety precautions have been adhered to.

 Please make sure that the unit is grounded at all times. For your own protection, you should never tamper with the grounding of the cable or the unit itself.

1.1.3 Warranty

Please take a few minutes and send us the completely filled out warranty card within 14 days of the date of purchase. You may also register online at www.behringer.com. The serial number needed for the registration is located at the top of the unit. Failure to register your product may void future warranty claims.

1.2 The user’s manual

The user’s manual is designed to give you both an overview of the control elements, as well as detailed information on how to use them. In order to help you understand the links between the controls, we have arranged them in groups according to their function. If you need to know more about specific issues, please visit our website at www.behringer.com, where you’ll find additional information on mixing consoles, effects units and dynamic processors.

1.3 Control elements

1.3.1 Front panel

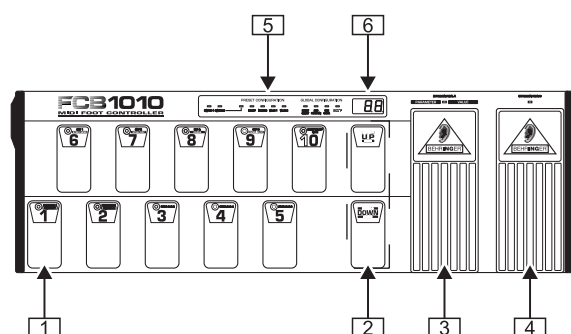









Fig. 1.1: Front panel control elements

-  **FOOTSWITCHES 1 through 10/0.** These keys are used for changing the presets, programming, entering values in programming mode and activating the DIRECT SELECT function (10/0 only).
-  **UP/DOWN keys.** These keys are used to navigate through different banks and programming layers. When in programming mode, use the UP key for ENTER (confirm) and the DOWN key for ESCAPE (cancel).
-  **When DIRECT SELECT mode is activated (see chapter 2 “PROGRAMMING THE FCB1010”), the UP/DOWN switches are no longer needed for BANK selection and are free to perform a special function: in the GLOBAL CONFIGURATION menu you can program them to control the SWITCH RELAYS (UP: SWITCH 1 RELAY, DOWN: SWITCH 2 RELAY).** In this case, you can toggle between the preprogrammed SWITCH settings, each time you step on these switches.
-  **EXPRESSION PEDAL A.** Allows you to change controller values continuously. In programming mode, the pedal is used for data entry.
-  **EXPRESSION PEDAL B.** Allows you to change controller values continuously.
-  **STATUS LEDs.** The yellow LEDs display the current status of the PRESET programming or GLOBAL CONFIGURATION functions.
-  **LED display.** Informs you about the currently selected BANK/PRESET number. In programming mode, it displays any value changes.

MIDI FOOT CONTROLLER FCB1010

1.3.2 Rear panel

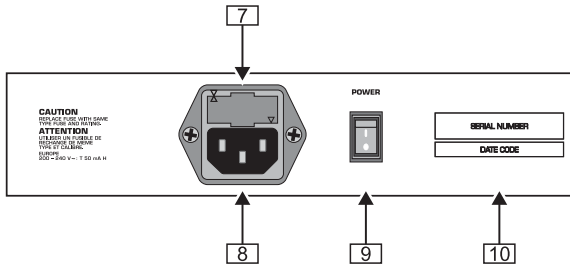

Fig. 1.2: Rear panel connectors

- 7 **FUSE HOLDER / VOLTAGE SELECTOR.** Please make sure that your local voltage matches the voltage indicated on the unit, before you attempt to connect and operate the FCB1010. Blown fuses may only be replaced by fuses of the same type and rating. Some models allow for inserting the fuse holder in two different positions, in order to switch over from 230-V to 120-V operation, and vice versa. Please note that for 120-V operation outside Europe, you need to use a fuse of a higher rating (see chapter 6 "SPECIFICATIONS").
- 8 **IEC POWER CONNECTOR.** Use the enclosed power cord to connect the unit to the mains.
- 9 Use the **POWER** switch to power up your FCB1010. Always make sure the **POWER** switch is in its "Off" setting when you connect the FCB1010 to the mains.
- Attention: The POWER switch does not physically disconnect the unit from the mains. Always unplug the unit from the mains when you do not plan on using it for prolonged periods of time.**
- 10 **SERIAL NUMBER.** Please take the time to have the warranty card filled out completely, and return it within 14 days after the date of purchase, so as to be entitled to benefit from our extended warranty. Or use our online registration option available on the World Wide Web under www.behringer.com.

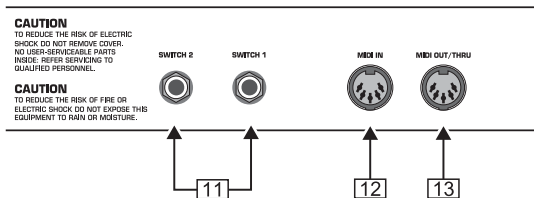

Fig. 1.3: Rear panel connectors

- 11 **SWITCH 1 and 2.** Use these jacks to connect your amplifier for channel selection (mono or stereo phone jack cable).
- 12 **MIDI IN.** The MIDI IN of your FCB1010 connects to a sequencer or similar device, in order to download the memory data saved before with the help of the MIDI SysEx function. Additionally, data can be looped through the FCB1010 and merged with other data using the MIDI MERGE function. Subsequently, the combined data are available at the MIDI OUT/THRU connector.
- 13 **MIDI OUT/THRU.** Use this jack to connect the devices you wish to control from your FCB1010. The SOFT THRU circuit allows you to loop through any signals present at the MIDI IN of your FCB1010, merge them with the unit's own data stream, and finally output the combined data at the MIDI OUT.

2. PROGRAMMING THE FCB1010

In this chapter you will learn to program your FCB1010 and adapt it to your specific MIDI set-up. But don't worry, you won't have to learn a programming language before you could give your FCB1010 a single MIDI command. The unit will perform all functions for you, one after the other. Simply make and confirm your choices. If particular functions prompt you to enter a parameter, this will be covered specifically.

2.1 Selecting BANKS and PRESETS

There are two options to select a BANK and the PRESETS it contains. Which one you use depends on the DIRECT SELECT parameter in the GLOBAL CONFIGURATION menu. If DIRECT SELECT is on, you can use the PRESET footswitches to directly select the BANK number followed by the PRESET number. If DIRECT SELECT is off, you need to step through the various BANKS (using the UP/DOWN switches), then select a PRESET from a bank. The default setting is OFF. The illustrations below show the two options.

2.1.1 DIRECT SELECT deactivated

Let's assume you wish to select PRESET #1 from BANK #3...

Step 1

Use the UP/DOWN switches to go to the BANK that contains the PRESET of your choice (here: BANK #3).

Step 2:

Select the PRESET you wish to use (here: PRESET #1).

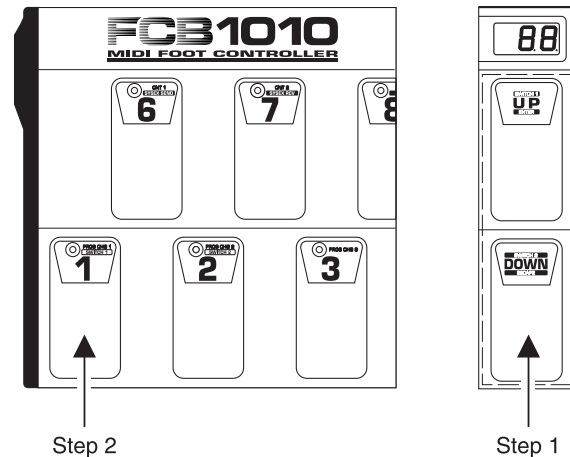

Fig. 2.1: PRESET selection with DIRECT SELECT disabled

2.1.2 DIRECT SELECT activated

If DIRECT SELECT is on, do as follows to select PRESET #1 from BANK #3 (activating DIRECT SELECT is discussed in ch. 2.2.1):

Step 1

Select the BANK of your choice (here: BANK #3) by stepping on footswitch #3.

Step 2

Select the PRESET you wish to use (here: PRESET #1) by stepping on footswitch #1. The display shows that preset 31 is selected.

MIDI FOOT CONTROLLER FCB1010

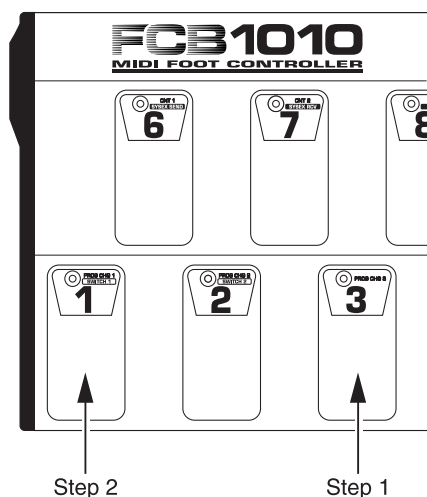

Fig. 2.2: PRESET selection with DIRECT SELECT enabled

As this example shows, the DIRECT SELECT feature gives you a faster access to BANKS and PRESETS than without this function. Which option to use is entirely up to you. As long as you need the PRESETS from one BANK only, it will be advisable to disable the DIRECT SELECT function because this way you can recall a new preset with only one keystroke.

2.2 GLOBAL CONFIGURATION

In the GLOBAL CONFIGURATION menu you can set the parameters that apply to both the PRESETS and FUNCTIONS of your FCB1010 (e.g. MIDI channel selection, SYSEX SEND & RCV, DIRECT SELECT etc.). Keep the DOWN switch pressed during power-up for about 2.5 sec to enter GLOBAL CONFIGURATION mode.

The DIRECT SELECT LED in the display lights up.

You can use the UP and DOWN keys to navigate through GLOBAL CONFIGURATION main pages. Pressing UP leafs through the pages forward, pressing DOWN leafs the pages backward. A corresponding LED indicates what page you are on.

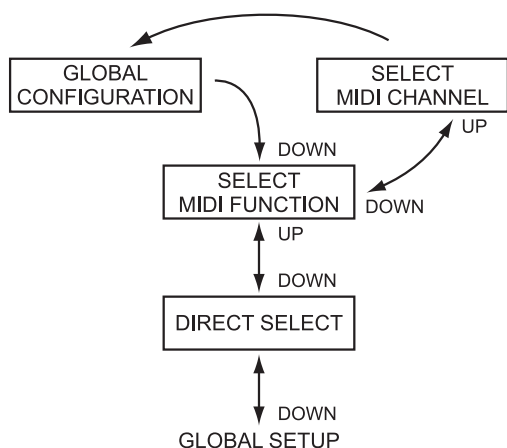

Fig. 2.3: GLOBAL CONFIGURATION menu structure

To leave GLOBAL CONFIGURATION menu, you need to press the DOWN/ESCAPE key for at least 2.5 sec.

⚠️ Only keeping the DOWN/ESCAPE key pressed for at least 2.5 sec. saves your newly entered settings!

2.2.1 DIRECT SELECT page

Keep the DOWN/ESCAPE key pressed while you power up the unit. This takes you to the GLOBAL CONFIGURATION menu; the green DIRECT SELECT LED lights up. To activate DIRECT SELECT, press 10/0 key. The red LED lights up. Now, you have

to confirm activating DIRECT SELECT to be able to directly select presets. To do this, keep DOWN/ESCAPE pressed for 2.5 sec. to exit GLOBAL CONFIGURATION. The display now shows "00". Now you can directly select the presets, as described in ch. 2.1.2.

2.2.2 MIDI channel setting

To get from DIRECT SELECT to MIDI FUNCTION, press UP. The MIDI FUNCTION LED flashes correspondingly.

This is where you determine the MIDI channels that can be sent from the FCB1010 for various MIDI functions. You can assign different MIDI channels to MIDI functions, For example, you can control several pieces of equipment from your FCB1010. The selection of MIDI functions is done via footswitches 1 to 10/0. MIDI channel 1 is the factory default for all functions.

Switch	MIDI function
1	PRG CHG 1
2	PRG CHG 2
3	PRG CHG 3
4	PRG CHG 4
5	PRG CHG 5
6	CNT 1
7	CNT 2
8	EXP A
9	EXP B
10/0	NOTE

Tab. 2.1: Footswitches and assigned MIDI functions

- ▲ After selecting a MIDI function by pressing one of the footswitches, the respective footswitch LED starts to blink.
- ▲ Press UP/ENTER to confirm the selected MIDI function. The MIDI CHAN. LED lights up.
- ▲ Choose the MIDI channel for the selected function, either directly via footswitches 1 through 10/0 or by using the EXPRESSION PEDAL A. Your selection is shown in the display.
- ▲ Press UP/ENTER to confirm the chosen value and to go to the next level, or press DOWN/ESCAPE to cancel.

2.2.3 CONFIG page

The CONFIG LED lights up if you are on CONFIGURATION page. The following functions, recalled via the footswitches (as in table 2.2), are at your disposal:

MIDI FOOT CONTROLLER FCB1010

Switch	Function	Action
1	SWITCH 1	Determines if UP key toggles SWITCH 1 relay while DIRECT SELECT is enabled.
2	SWITCH 2	Determines if DOWN key toggles SWITCH 2 relay while DIRECT SELECT is enabled.
5	COPY PRESET	Enables copying presets (see ch. 2.4.1).
6	SYSEX SEND	Sends the entire memory as a sysex dump.
7	SYSEX RCV	When this switch is pressed, the FCB1010 waits for the reception of system-exclusive data. Switch LED dies out when the data have been received correctly.
8	MERGE	Allows to merge MIDI IN data with FCB1010-generated data. The combined data stream is subsequently output at the MIDI OUT.
9	RUNNING STATUS	Enables/disables running status feature. Serves to make efficient use of the MIDI transmission rate. The MIDI status byte from the expression pedals is sent only if it differs from the preceding status byte.

Tab. 2.2: Assignment of footswitches in CONFIGURATION setup menu

External equipment, for example guitar or bass amps, can be controlled by using SWITCH 1 and 2 outputs of the FCB1010. If the FCB1010 triggers this function, you should first check if the piece of equipment you are trying to control reacts to connection state (contact open or closed) or current feed (contact closed as long as the switch is depressed). BEHRINGER guitar and bass amps react to current feeds. Therefore, when you wish to remotely control channel change on a BEHRINGER guitar amp not via MIDI but via switch outputs (because you have no MIDI cable at your disposal), you have to power off switch 1 & 2 LEDs in GLOBAL CONFIGURATION menu under CONFIG. These LEDs are on in the default setting and indicate that programmed connection state is kept.

Basically, CONFIGURATION mode functions are active as long as the corresponding footswitch LED is lit.

2.3 Quick start guide for PRESET programming

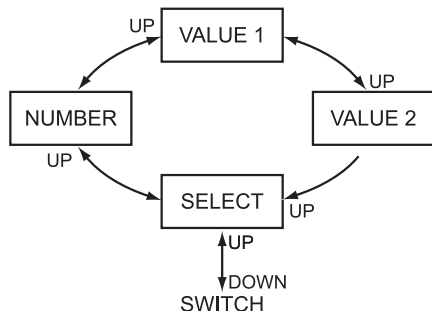

Fig. 2.4: PRESET programming

For each of the 100 PRESETS you can determine which MIDI functions shall be transmitted as soon as you select the respective PRESET. For instance, you can send five different

program change commands, two controller commands, two different controller values (using the expression pedals) and a Note On command to the connected equipment at the same time (menu structure as in fig. 2.4). It is up to you to determine, which commands are stored in a PRESET. Do as follows to program the functions to be sent with each PRESET:

- ▲ Select the PRESET you wish to edit.
 - ▲ Press DOWN for more than 2.5 sec to enter PRESET programming mode. The number in the display disappears while the green SWITCH 1/SWITCH2 LED in the display starts flashing.
 - ▲ Use footswitches 1 and 2 to edit the status of the SWITCHES. The current status is indicated by the foot-switch LED and the corresponding SWITCH LED in the acrylic display. For further details see chapter 3.3 "Connections (general)".
- ⓘ Please note that the status of the SWITCHES can also be toggled with UP (SWITCH 1) and DOWN (SWITCH 2) if DIRECT SELECT is enabled. The only prerequisite is that this function has been enabled for both SWITCHES in the CONFIGURATION menu.
- ▲ Confirm with UP/ENTER. The SELECT LED in the display lights up.
 - ▲ Activate individual MIDI functions by keeping the respective footswitch depressed for roughly 1.5 sec. Footswitch LEDs indicate the activated footswitches of the respective MIDI functions. As long as the display indicates SELECT, you can activate MIDI functions and select them for editing by briefly pressing the corresponding footswitch. The selected footswitch LED and the display blink during selection and activation. The NUMBER LED is also lit. The following MIDI functions are available for selection:

Switch	MIDI function	Action
1	PRG CHG 1	Program change command #1
2	PRG CHG 2	Program change command #2
3	PRG CHG 3	Program change command #3
4	PRG CHG 4	Program change command #4
5	PRG CHG 5	Program change command #5
6	CNT 1	Controller 1
7	CNT 2	Controller 2
8	EXP A	Expression Pedal A
9	EXP B	Expression Pedal B
10/0	NOTE	Transmits a MIDI note

Tab. 2.3: Footswitch assignment in PRESET programming mode

ⓘ MIDI channel adjustment for the respective MIDI functions is not done during preset programming; it is done in GLOBAL CONFIGURATION on MIDI FUNCTION page (see ch. 2.2.2).

- ▲ Confirm your selection with UP/ENTER, in order to start programming the selected MIDI function, or cancel with DOWN/ESCAPE. Use footswitches 1 through 10/0 or EXPRESSION PEDAL A to enter the parameter values of your choice.
- ▲ If you have selected PROGRAM CHANGE as the MIDI function to be edited, you can now enter a program change number from 1 through 128 and confirm your selection with UP/ENTER.
- ▲ If you have selected CNT1 or CNT2, you can now enter the number of the controller to be sent (0 through 127) when you press the corresponding footswitch. After confirming your selection with UP/ENTER you can select a controller value (0 through 127). Confirm your selection with UP/ENTER.

MIDI FOOT CONTROLLER FCB1010

- ▲ If you have selected **EXP A** or **EXP B**, you can now enter the controller number the **EXPRESSION PEDAL** of your choice is aimed to send values for. Confirm your selection with **UP/ENTER** and enter the lower value (pedal up). Confirm with **UP/ENTER**.

Afterwards, enter the upper value (pedal pressed down completely) and confirm once again with **UP/ENTER**.

- 👉 **Please keep in mind that the first controller value always has to be lower than the second controller value!**
- 👉 **You can quit the programming mode at any time by means of a long press on **DOWN**. Any confirmed entries will be stored with the currently selected **PRESET**.**
- 👉 **How to program the **NOTE** function is explained in chapter 2.4.6.**

2.4 Detailed PRESET programming

2.4.1 Preset copy function

The preset copy function copies an already programmed preset to a new preset of your choice. This saves you time, since you do not have to repeat all adjustments for each newly programmed preset.

- ▲ Activate **CONFIG** in the **GLOBAL CONFIGURATION** (see chapter 2.2).
- ▲ Now, press **footswitch 5** to activate the copy function. The **VALUE 1** LED lights up. The number in the display and the footswitch LED start flashing.
- ▲ Enter the number of the preset you wish to copy and confirm your selection with **UP/ENTER**. The **VALUE 2** LED lights up. The number in the display and the footswitch LED start flashing.
- 👉 **Presets 1 - 10 are stored in bank 0, presets 11 - 20 in bank 1, and so on.**
- ▲ Enter the target preset and confirm your selection with **UP/ENTER**, or cancel with **DOWN/ESCAPE**.
- ▲ If you want to copy further presets, please press **footswitch 5** again. Press and hold **DOWN/ESCAPE** to quit the **GLOBAL CONFIGURATION**.

2.4.2 Programming switches

- ▲ Select the **PRESET** you wish to edit.
- ▲ Press **DOWN** for more than 2.5 sec to enter **PRESET programming mode**. The green **SWITCH 1/SWITCH 2** LED in the display starts flashing.
- ▲ Enable/disable the **SWITCHES** using footswitches 1 and/or 2 and confirm your selection with **UP/ENTER**. The corresponding footswitch and **SWITCH** LEDs light up.
- ▲ Exit **PRESET programming mode** through keeping the **DOWN/ESCAPE** key for a few seconds, or press the **UP/ENTER** key in order to get to the next page, where you can edit various **MIDI functions** for the preset selected at the beginning.

2.4.3 Programming program changes

- ▲ Select the **PRESET** you wish to edit.
- ▲ Keep the **DOWN/ESCAPE** key pressed longer than 2.5 sec. to get to the programming mode. The green **SWITCH 1/SWITCH 2** LED in the display starts flashing.
- ▲ Use the **UP/ENTER** key to get to the next page. The **SELECT** LED in the display is lit.

- 👉 **To program a **MIDI** function, you have to first activate it. Individual **MIDI** functions are activated by keeping the corresponding keys pressed for a few seconds. Active **MIDI** functions are indicated by a permanently lit footswitch LED.**

- ▲ Select the **PROGRAM CHANGE** you wish to program for the selected **PRESET** by briefly pressing the respective footswitch (footswitches 1 to 5). The footswitch LED blinks.
- ▲ Confirm your selection by pressing **UP/ENTER**. The **NUMBER** LED in the display lights up.
- ▲ Enter the program change command (1 bis 128) via the footswitch or expression pedal A.
- ▲ Confirm your selection by pressing **UP/ENTER** or cancel by pressing **DOWN/ESCAPE**. The **SELECT** LED in the display lights up.
- ▲ Select an additional **MIDI** function you wish to edit or exit the **PRESET programming mode** by keeping the **DOWN/ESCAPE** key for a few seconds.

2.4.4 Programming CONTROL CHANGES

- ▲ Select the **PRESET** you wish to edit.
- ▲ Keep **DOWN** pressed for more than 2.5 sec to enter **PRESET programming mode**. The green **SWITCH 1/SWITCH 2** LED in the display starts flashing.
- ▲ Use the **UP/ENTER** key to get to the next page. The **SELECT** LED in the display lights up.

- 👉 **To program a **MIDI** function, you have to first activate it. Individual **MIDI** functions are activated by keeping the corresponding keys pressed for a few seconds. Active **MIDI** functions are indicated by a permanently lit footswitch LED.**

- ▲ Keep the corresponding footswitch (foot key 6 or 7) pressed for a few seconds to activate the controller you wish to edit. The controller is selected by pressing the key briefly again. The LED blinks.
- ▲ Confirm your selection by pressing **UP/ENTER**. The **NUMBER** LED in the display lights up.
- ▲ Enter the desired controller number (0 to 127) by using the foot keys or the expression pedal A.
- ▲ Confirm your selection with **UP/ENTER**. The **VALUE 1** LED in the display lights up.
- ▲ Use the footswitches 1 through 10/0 or **EXPRESSION PEDAL A** to enter the controller value (0 through 127).

- 👉 **To correct your selection, use the **DOWN/ESCAPE** key to go one step backward.**

- ▲ Confirm your selection by pressing **UP/ENTER**. The **SELECT** LED in the display lights up.
- ▲ Select an additional **MIDI** function you wish to edit or quit the **PRESET programming mode** by keeping **DOWN/ESCAPE** pressed for a few seconds.

2.4.5 Programming EXPRESSION PEDALS A/B

- ▲ Select the **PRESET** you wish to edit.
- ▲ Keep **DOWN** pressed for more than 2.5 sec to enter **PRESET programming mode**. The green **SWITCH 1/SWITCH 2** LED in the display starts flashing.
- ▲ Use **UP/ENTER** to get to the next page. The **SELECT** LED in the display begins to light up.

- 👉 **To program a **MIDI** function, you have to first activate it. Individual **MIDI** functions are activated by keeping the corresponding keys pressed for a few seconds. Active **MIDI** functions are indicated by a permanently lit footswitch LED.**

MIDI FOOT CONTROLLER FCB1010

- ▲ Activate the expression pedal you wish to program by keeping the corresponding foot key pressed for a few seconds (foot keys 8 or 9). The foot key LED blinks after you briefly press the foot key yet again.
- ▲ Confirm with UP/ENTER. The NUMBER LED lights up.
- ▲ Enter the control number (0 bis 127) via the footswitches or the expression pedal A.
- ▲ Confirm your selection with UP/ENTER. The VALUE 1 LED lights up.
- ▲ Enter the value to be transmitted when the pedal is completely open by using the foot keys or the expression pedal A.
- ▲ Confirm your selection with UP/ENTER. The VALUE 2 LED lights up.
- ▲ Enter the value to be transmitted when the pedal is completely pressed downward by using the foot keys or the expression pedal A.
- 👉 Use DOWN/ESCAPE to go one step backward.
- ▲ Confirm your selection with UP/ENTER. The SELECT LED lights up.
- ▲ Quit PRESET programming mode by means of a long press on DOWN, or select another MIDI function for editing.

2.4.6 Programming the NOTE function

The NOTE function allows you to send a MIDI note, for example, to use the tap-tempo features offered by many MIDI devices or to play sounds the same way you would on a keyboard.

- ▲ Select the PRESET you wish to edit.
- ▲ Keep DOWN pressed for more than 2.5 sec to enter PRESET programming mode. The green SWITCH 1/SWITCH 2 LED in the display starts flashing.
- ▲ Use UP/ENTER to get to the next page. The SELECT LED in the display begins to light up.
- 👉 To program a MIDI function, you have to first activate it. Individual MIDI functions are activated by keeping the corresponding keys pressed for a few seconds. Active MIDI functions are indicated by a permanently lit footswitch LED.
- ▲ Keep footswitch 10/0 pressed for a few seconds to activate the NOTE function. Pressing the footswitch briefly once again makes the footswitch LED blink.
- ▲ Confirm your selection with UP/ENTER. The NUMBER LED lights up.
- ▲ Use the footswitches 1 through 10/0 or EXPRESSION PEDAL A to enter the MIDI NOTE number you wish to send with the PRESET. You can choose from the values 0 through 127.

The table below shows which musical notes are assigned to which MIDI notes (with a detailed list for the octave from C-2 to C-1; simply use this pattern to assign the remaining notes/octaves yourself).

Musical Note	MIDI Note Number
C-2	0
C#-2/D \flat -2	1
D-2	2
D#-2/E \flat -2	3
E-2	4
F-2	5
F#-2/G \flat -2	6
G-2	7
G#-2/A \flat -2	8
A-2	9
A#-2/B \flat -2	10
H-2	11
C-1	12
C0	24
C1	36
C2	48
C3 (Clef C)	60 (Yamaha Convention)
C4	72
C5	84
C6	96
C7	108
C8	120
G8	127

Tab. 2.4: Assignment of MIDI NOTE numbers

- ▲ Confirm your selection by pressing UP/ENTER or cancel by pressing DOWN/ESCAPE. The SELECT LED in the display lights up.
- ▲ Select an additional MIDI function you wish to edit or exit the PRESET programming mode by keeping DOWN/ESCAPE pressed for a few seconds.

The NOTE function will be particularly useful for so-called tap-tempo applications. Many of today's multi-effects devices allow the user to enter the delay time by means of an on-board TAP button. The device measures the time between two TAP button presses and uses this interval to adjust the delay time. Often, this function can be remotely controlled via MIDI. In this case, "tapping" is the transmission of two subsequent NOTE ON commands, which is what the NOTE function of your FCB1010 does for you. For example, this is how a sequencing software can be launched or closed.

- 👉 If you program the NOTE function with a PRESET, a NOTE ON command will be sent each time you select the PRESET. Getting your foot off the switch transmits the NOTE OFF command.
- 👉 To "tap" the tempo, simply press the PRESET switch several times in the rhythm of the music.

- 👉 CNT 1 is always transmitted together with the note on command. For example, it can be used for sending a volume value (number 07) together with a note to trigger a sound. When the controller's operation is not desired, it can either be relayed to an unused MIDI channel in GLOBAL CONFIGURATION (this channel is then valid for all presets) or an unused controller number can be assigned to the controller (can be done for each individual preset).

MIDI FOOT CONTROLLER FCB1010

2.5 Controller toggle function

This function allows you to configure one controller so that it alternately sends two different values, e.g. effect bypass, drive on/off, etc.

- ▲ In order to enable the controller switch-over function, you need to globally select the same MIDI channel for CNT1 and CNT2 (see chapter 2.2), and enter the same controller number for CNT1 and CNT2 in the preset (NUMBER, see chapter 2.4.4).

The first time you recall the preset, it will send the controller value of CNT1 (VALUE 1), with each additional key press you can alternate between CNT2 and CNT1. **Example:** Select preset 1 without DRIVE function on the BEHRINGER V-AMP—each time you press the same button again, DRIVE will be switched on or off respectively: PROG CHG 1 = 1, CNT 1 NUMBER = 26, VALUE 1 = 0, CNT 2 NUMBER = 26, VALUE 1 = 127.

2.6 TAP-TEMPO function

In addition to the NOTE function, which is used by many effects devices to “tap” the song tempo, the FCB1010 offers you another way to reach this goal: the TAP-TEMPO function also allows you to enter the song tempo, however, transmits a FCB1010-generated controller value to the controlled effects device, in order to adjust the delay time. Advantage: you can also control devices that cannot process NOTE commands, but only allow for changing the delay time by means of a MIDI controller.

 **The TAP-TEMPO function does not work with DIRECT SELECT enabled.**

The TAP-TEMPO function has no dedicated switch, but is activated as follows:

- ▲ Select the PRESET you wish to edit.
- ▲ Keep the DOWN/ESCAPE key pressed longer than 2.5 sec. to get to the programming mode. The green SWITCH 1/ SWITCH 2 LED in the display starts flashing.
- ▲ Use the UP/ENTER key to get to the next page. The SELECT LED in the display is lit.

 **To program a MIDI function, you have to first activate it. Individual MIDI functions are activated by keeping the corresponding keys pressed for a few seconds. Active MIDI functions are indicated by a permanently lit footswitch LED.**

- ▲ Select the NOTE function you wish to edit by keeping the 10/0 key pressed for a few seconds and then consequently tap it once again briefly. The footswitch LED blinks.
- ▲ Confirm your selection with UP/ENTER. The NUMBER LED lights up.
- ▲ Enter the maximal possible delay time value for the equipment you wish to control. Calculate the value that is to be entered for NOTE by dividing the maximum delay time value by 10 ms. Confirm your selection with UP/ENTER. The SELECT LED lights up.

 **Please note that the FCB1010 allows for a maximum delay time of 1,270 ms, which is due to the MIDI standard's maximum resolution of 7 bits (= 128 values).**

- ▲ Activate control change 1 (CNT 1) by keeping the footswitch 6 pressed for a few seconds. The footswitch LED lights up and is activated by briefly tapping the footswitch (the LED blinks).
- ▲ Press UP/ENTER again. Now the FCB1010 prompts you to enter a controller number. The NUMBER LED lights up. Enter the controller number which the manufacturer of your effects device has preset for delay time changes. Confirm your selection with UP/ENTER. The VAL1 LED lights up.

- ▲ The VALUE to be entered now corresponds to the upper limit of the parameter range determined by the controlled device. That might sound a bit confusing, but it's quite easy: the manual that came with the device usually contains an effects table listing the parameter range to be input via MIDI in order to control the delay time. For example, the device might use the entire range from 0 through 127; or a limited range from 0 through 63, and so on. So, the VALUE parameter simply determines the resolution with which the delay time can be programmed. The higher the value, the higher the resolution.

- ▲ Confirm your entry with UP/ENTER. The SELECT LED lights up.

- ▲ Disable Control Change 1 (CNT 1) by means of a long footswitch press on footswitch #6. This is necessary because otherwise each time you select the PRESET used for tempo tapping, the FCB1010 would transmit the controller defined here (including the adjusted VALUE parameter), instead of the FCB1010-generated value.

- ▲ Quit PRESET programming mode by means of a long press on DOWN. Now, the TAP-TEMPO function is ready for use.

To use the tap-tempo feature, press the footswitch (which selects the PRESET just programmed) twice in the rhythm of the music, e.g. every crotchet or quaver note. The FCB1010 will calculate the delay time and send it to the receiving device, by means of the controller you selected before. If the interval between the two footswitch presses is greater than the maximum NOTE/NUMBER value, the FCB1010 will divide the time by 2 until it is equal to or smaller than the maximum value. Thus, a crotchet delay becomes a quaver or semiquaver delay, depending on which value can be processed in the receiving device.

2.7 Data storage

2.7.1 Saving the FCB1010 memory with the help of SysEx dumps

The FCB1010 allows you to transmit PRESETS in the form of system-exclusive data to a sequencer or other MIDI recorder. In this way, you can save your data or manage several MIDI setups (e.g. studio equipment, guitar equipment, etc.).

If you wish to save your data on an external sequencer/computer, please follow the instructions below:

- ▲ Connect the MIDI OUT of your FCB1010 to the MIDI IN of your sequencer/computer (see fig. 2.5)
- ▲ Keep the DOWN switch pressed roughly 2.5 sec during power-up to enter the GLOBAL CONFIGURATION menu.
- ▲ Press UP until the CONFIGURATION LED lights up. Now the unit is in CONFIGURATION mode.
- ▲ Start the RECORD function on your sequencer/computer. The footswitch LED lights up and is no longer lit up when all SysEx data from the FCB1010 have been transmitted. Then press footswitch #6 to dump the FCB1010 data. Quit the GLOBAL CONFIGURATION menu by means of a long press on DOWN/ESCAPE.

MIDI FOOT CONTROLLER FCB1010

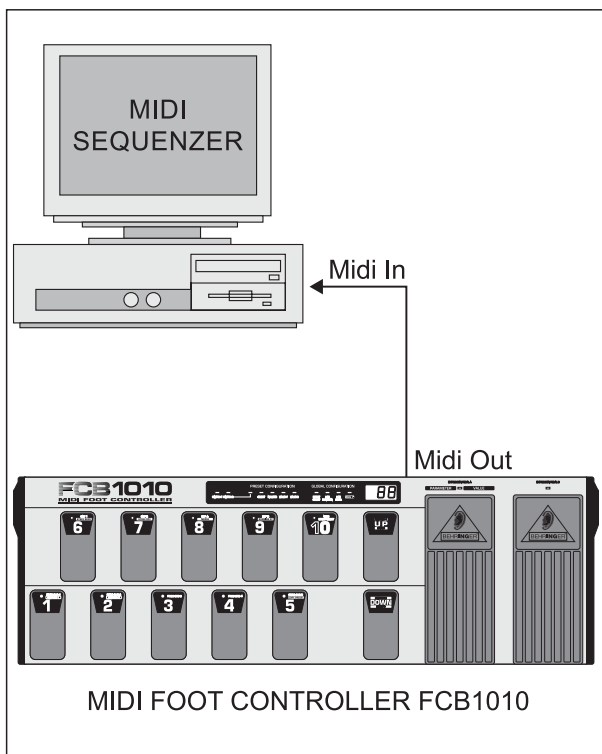

Fig. 2.5: Sending a SysEx-Dump

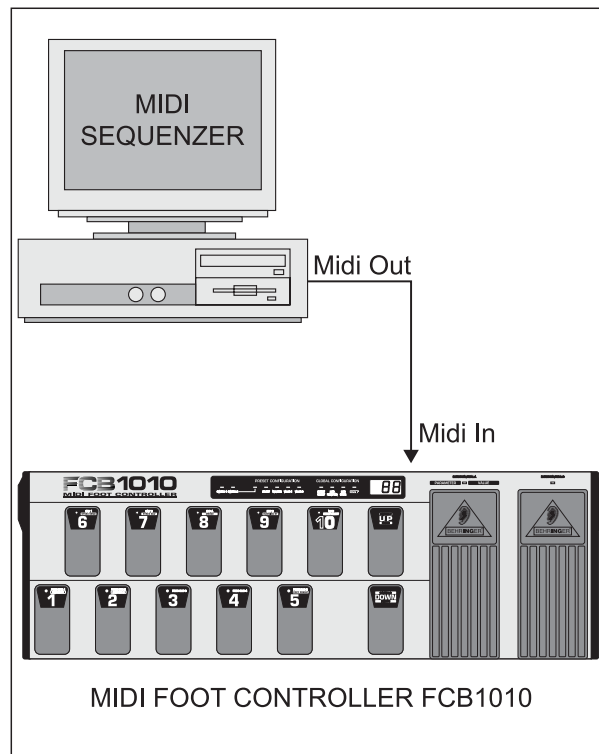

Fig. 2.6: Receiving a SysEx dump

2.7.2 Receiving SysEx dumps

To send back FCB1010 data stored on a sequencer/computer before, please follow the instructions below:

- ▲ Connect the MIDI OUT connector of your sequencer or computer to the MIDI IN connector of the FCB1010 (see fig. 2.6).
- ▲ Keep the DOWN switch pressed during power-up to enter the GLOBAL CONFIGURATION menu.
- ▲ Press UP until the CONFIGURATION LED lights up. Now the unit is in CONFIGURATION mode.
- ▲ Press footswitch #7 (SYSEX RCV) to "tell" the FCB1010 to wait for system-exclusive data (the footswitch LED lights up). Start the PLAYBACK function on your sequencer/computer to play back the previously stored file. The footswitch LED flashes while the FCB1010 is receiving data. Once the data have been received correctly, the LED dies out. Now your programs are back in the FCB1010's memory. Quit GLOBAL CONFIGURATION mode by means of a long press on DOWN.

2.8 Restoring factory presets

This function allows you to restore factory defaults of your FCB1010.

In doing so, all preset settings made by you are overwritten!

Resetting your FCB1010 lets you restore various default settings that are optimized for use with BEHRINGER audio equipment. This is why there are three different key combinations that let you reload the desired defaults into the memory of your FCB1010. This key combinations are shown in table 2.5:

Switch	Default setting for
1 + 6	V-AMP family products
1 + 7	BEHRINGER guitar amps
1 + 8	BASS V-AMP product range

Tab. 2.5: Reset key combinations

Keep the respective footswitches pressed for roughly 2.5 sec while powering up your FCB1010. The displays reads "09" to "00" and the points are blinking. When the points are no longer shown, your FCB1010 has been reset to factory defaults and is ready for operation.

2.9 Calibrating expression pedals A and B

Should you experience problems with exact MIDI controller data transmission while using the expression pedals, we recommend calibrating the pedals. Calibrating the pedals follows the completion of the FCB1010 self-test.

All software versions 1.4 and newer allow for direct calibration by keeping the switches 1 and 5 pressed while powering up the unit. If your FCB1010 features the software version 1.4 or higher, skip the first 4 steps in the set of instructions that follow (i.e. start at point number 5). To find if your unit features version 1.4 or higher of the software, first try keeping the switches 1 and 5 pressed while powering up the unit. If nothing happens, start calibrating your FCB1010 beginning with the first step in the list that follows.

MIDI FOOT CONTROLLER FCB1010

- ▲ Keep the switches 1 and 3 pressed while powering up the unit. This puts your FCB1010 into self-test mode, and all LEDs are being tested.
- ▲ Please wait until all switch LEDs light up. Then press all the switches, including the UP/ENTER and DOWN/ESCAPE keys, so that all LEDs are turned off.
- ▲ Wait for a moment while the relay test is completed (four quiet clicking sounds are heard). The display shows F1 if no MIDI connection is present. If you connected MIDI Out to MIDI In, the display shows A1. In this case, the MIDI connections operate correctly.
- ▲ Press DOWN/ESCAPE once.
- ▲ Move the expression pedal A to the lowest value possible (pedal open). The VALUE 1 LED lights up. When the value is adjusted, press the UP/ENTER key.
- ▲ Move the expression pedal A to the highest value possible (pressed down all the way). The VALUE 2 LED lights up. When the value is adjusted, press the UP/ENTER key.
- ▲ Move the expression pedal B to the lowest value possible. When the value is adjusted, press the UP/ENTER key.
- ▲ Move the expression pedal B to the highest value possible. When the value is adjusted, press the UP/ENTER key.

Both pedals are now correctly calibrated.

3. APPLICATIONS

Several application examples that should help you with the MIDI setup are described in this chapter.

As long as your equipment features MIDI connectors, you can control it entirely via the FCB1010. All you need is a MIDI IN connector at the other end.

No audio signal pass through the FCB1010 and consequently no signal processing takes place in it either. The FCB1010 merely transmits control data to your MIDI equipment, so it can for example call up presets, turn effects on or off, or adjust volume. You can find more detailed information on this subject in chapter 4 "MIDI—A STANDARD, A REVOLUTION."

3.1 Basic setup

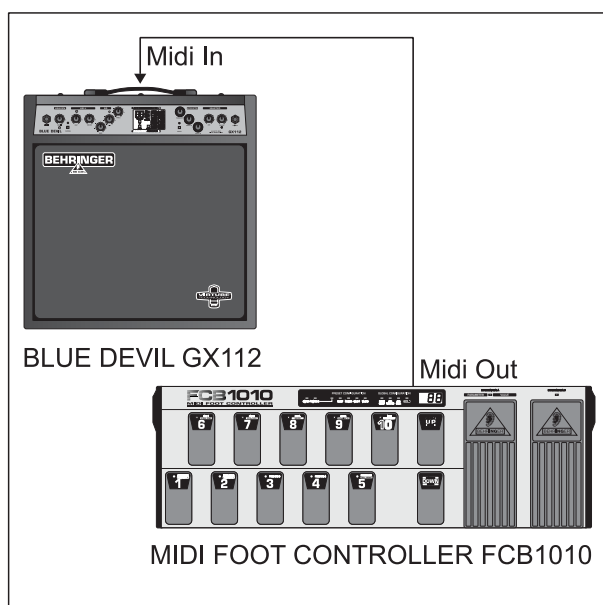

Fig. 3.1: Basic setup with a guitar amp

Here, the FCB1010 is used to control a guitar amp that is equipped with a MIDI interface.

Connect the MIDI OUT jack of your FCB1010 to the MIDI IN of your amp (see fig. 3.1), using a standard 5-pole MIDI cable. Program your FCB1010 as described in chapter 2.4. Please refer to the user's manual of your amp to find out what functions can be controlled via MIDI.

3.2 Expanded setup (using the switch function)

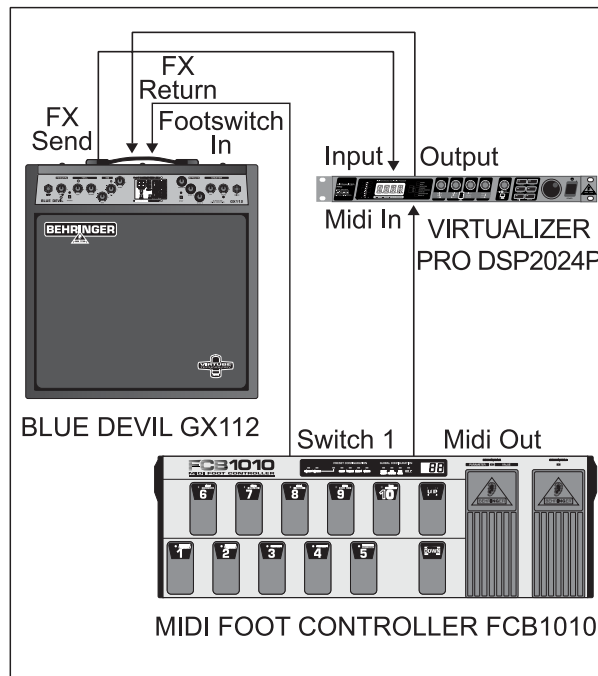

Fig. 3.2: Guitar setup (using the switch function)

Here, the FCB1010 is used to control an effects device via MIDI. In addition, the switch function is used to toggle between the two channels (clean/overdrive) of the guitar amp. Please connect your effects device via the FX send/return loop of your amp. Now connect the SWITCH 1 connector with the footswitch input of your guitar amp. Use a standard jack cable for this purpose. Connect the MIDI OUT connector of the FCB1010 to the MIDI IN connector of the effects device using a standard MIDI cable.

The effects processor is controlled via MIDI, while the SWITCH function toggles the amp. Thus, you'll need no additional footswitch when you switch between the channels; instead, your entire setup is centrally controlled from the FCB1010.

3.3 Connections (general)

Please use commercial-grade cables with phone plugs to connect the SWITCH outputs of your FCB1010 to your amplifier. Since these outputs are normalized, you can send both switching pulses from one SWITCH output, by using a stereo cable, which is useful in combination with amplifiers that have a stereo phone jack to select several functions (e.g. channel select and effect on/off). In this case, please use only one of the two SWITCH outputs with one stereo cable connected.

👉 Find out whether or not your guitar amp supports a stereo connection via SWITCH 1 or SWITCH 2. Simply try and experiment to identify the switching configuration of your amp.

MIDI FOOT CONTROLLER FCB1010

4. MIDI—A STANDARD, A REVOLUTION

In the early 80's several leading manufacturers of electronic musical instruments developed a common standard, which was soon to revolutionize the entire MI industry—both from a technical and musical point of view. The MIDI standard (short for: Musical Instruments Digital Interface) was invented to allow musical instruments of different makes to communicate with each other. What is surprising in view of the rapidly developing MI industry is the fact that this standard has basically not changed ever since, because it was designed with future upgrades in mind. So, the MIDI interface's range of applications could be expanded over the years: from the simple connection of several keyboard instruments to one master keyboard to connecting whole studios and live set-ups within a single MIDI network—MIDI has become an infinite source of ideas and innovation. Numerous musicians recognized the versatility of this standard and created new and exciting worlds of sounds by combining different instruments to one homogeneous whole. It is important to know that the MIDI interface transmits no audio signals but only control data (e.g. key, program change or volume numbers)! MIDI is just an interface for the control and networking of devices and instruments.

At the heart of this network you could use your FCB1010 to control all of your amplifiers, effects and peripheral devices. Live on stage and in the studio you could control your entire equipment in real time. MIDI control data can be stored and edited on a computer, so that you can also use your FCB1010 to enter controller and program change information into your computer.

4.1 MIDI connections

The MIDI connectors on the rear of the unit are on internationally standardized 5-pin DIN jacks. To connect your FCB1010 to other MIDI devices you need a dedicated MIDI cable. Usually, commercially available cables are used. However, you can also use a two-conductor shielded cable (e.g. microphone cable) and two (rugged) 180° DIN plugs to make your own MIDI cable: pin 2 (center) = shield, pins 4 and 5 (right and left of pin 2) = internal conductor, pins 1 und 3 (the two outer pins) are not used. MIDI cables should not be longer than 15 meters.

MIDI IN: serves to receive recorded system-exclusive data or to merge any MIDI signals with FCB1010-generated data.

 **The FCB1010 has no dedicated MIDI THRU port. However, the data received at the MIDI IN can be routed to the MIDI OUT provided that the MERGE function is enabled (GLOBAL CONFIGURATION).**

MIDI OUT: The MIDI OUT allows you to transmit data to any MIDI-compatible device/instrument.

4.2 MIDI data format

Although the FCB1010 is very easy to operate, it does make sense to know a few things about the format of MIDI data. Each MIDI command or message consists of up to three bytes (1 byte = 8 bits). There's a difference between status bytes and data bytes: status bytes define the type of a specific MIDI message, i.e. the actual instruction to be sent to a device, while data bytes contain the information or parameters defined by the corresponding status byte. One status byte can be followed by up to two data bytes.

There are various types of MIDI messages. Since the FCB1010 does not understand or transmit all of them, we will only deal with those that are of importance to you in this context.

4.2.1 NOTE ON and NOTE OFF messages

NOTE ON and NOTE OFF messages are essential MIDI messages for any keyboard virtuoso, as they allow to control remote instruments from one master keyboard or computer. The FCB1010, too, can send NOTE ON messages, however, in a

different context: many effects devices allow for "tapping" delay times, etc., by measuring the time interval between two NOTE ON messages. With the FCB1010 you can "tap" delay times or song tempos by selecting a "NOTE" PRESET twice.

NOTE ON and NOTE OFF messages feature the following data format:

	Status Byte	Data Byte #1	Data Byte #2
Note Off	&8n (n=channel #)	Note #	Velocity
Note On	&9n (n=channel #)	Note #	Velocity

Tab. 4.1: Data format of NOTE ON and NOTE OFF messages

The channel number range is 1 through 16, the data byte range is 0 through 127. It should be noted though that NOTE OFF messages are not so common today (for reasons of data reduction, cf. running status). Usually, NOTE ON messages with zero velocity are transmitted instead. The FCB1010 follows this convention. By the way: when you program the NOTE function on your FCB1010 you only need to enter the note number, because notes are always transmitted with a velocity of 64.

4.2.2 CONTROL CHANGE messages

CONTROL CHANGE messages are the most powerful MIDI messages, as they allow you to select and automate plenty of parameters and functions. On your FCB1010 you can define and transmit CONTROL CHANGE messages, e.g. to change specific effects parameters in real time. The most important CONTROL CHANGE messages are volume control (Controller 07), Balance (08), Panorama (09) and reverb intensity (91).

4.2.3 PROGRAM CHANGE messages

PROGRAM CHANGE messages are used to change presets or sounds in connected devices/instruments. The parameter range is 0 through 127.

The values 0 to 127 of the 128 presets are available. Equipment with more than 128 presets has these presets broken down into several banks for MIDI control.

With your FCB1010, it is possible to send MIDI bank and program change commands by using just one keystroke. An external piece of equipment (e.g. effects processor, sound module etc.) can be controlled via controllers 1 & 3 in connection with PRG 5 (PROG CHG). In doing so, controllers 1 & 2 are used as 2-byte bank select controllers, whereby up to 128 (MSB) x 128 (LSB) banks can be dialed in. Controller 1 needs to contain the number 00 and the MSB bank value, while controller 2 needs to contain the number 32 and the LSB bank value. The program change command that activates the preset in the new bank is sent with PRG 5.

Almost all devices have a list enclosed which shows the program change number versus preset number assignment. Some units even allow you to freely assign program change commands to preset numbers. Please see the corresponding user's manual for detailed information.

MIDI FOOT CONTROLLER FCB1010

4.2.4 Running status

Since the MIDI standard uses a serial transmission format, i.e. transmits data successively, it was soon found that the transmission rate is too low if the system is exploited to its full capacity. To make up for an audibly delayed transmission of MIDI data, the so-called running status was introduced, which suppresses the status byte in two or more identical MIDI messages that follow each other. For example, if the data bytes of a controller (e.g. volume) are changed continuously, the corresponding status byte is sent only once. Only the data byte changes are transmitted, as long as another status byte is sent, i.e. in each message transmitted you can eliminate 8 bits. This is also the reason why NOTE OFF messages are no longer used. When a keyboard player plays a scale on a keyboard and sends these data via MIDI to a computer, each NOTE ON message would be followed by a NOTE OFF message, each time a key is released. The running status would identify the NOTE OFF message as a new status byte and hence send it, which results in a data amount of 8 notes times 8 bits, i.e. 192 bits. Since NOTE ON messages belong to those MIDI messages that are used most often, it was decided to send NOTE ON messages with zero velocity instead. The audible effect is the same, but in the Running Status the data amount can be reduced by 7 times 8 bits, i.e. 56 bits. As a consequence, the overall data amount produced by the scale mentioned above is only 136 bits. With the FCB1010 you are free to switch the Running Status feature on or off (see ch. 2.2.3).

5. MIDI IMPLEMENTATION

MIDI Implementation Chart				
Function		Trans- mitted	Recognized	Remarks
Basic	Default	1-16		
Channel	Changed	1-16		
Mode	Default	x	x	
	Messages	x	x	
Note		0-127	x	programmable
Number				1-128
Velocity	Note ON	0,64	x	
	Note OFF	x	x	
		x	x	
After	Keys	x	x	
Touch	Channels	x	x	
Control		0-127	x	
Progr.				programmable
Change	True #	0	x	1-128
System				
Exclusive		0	0	
System	Song Pos.	x	x	
Common	Song Sel.	x	x	
	Tune	x	x	
System	Clock	x	x	
Real Time	Commands	x	x	
Aux	Local ON/OFF	x	x	
Messages	All notes OFF	x	x	
	Active Sense	x	x	
	Reset	x	x	
Notes		Soft Thru / Merge Function		
O = YES, X = NO				
Mode 1: OMNI ON				
Mode 2: OMNI OFF				

Tab. 5.1: MIDI Implementation

6. SPECIFICATIONS

MIDI INTERFACE

Type 5-pin DIN jacks IN and OUT / THRU

DISPLAY

Type 3-digit LED

SWITCHING OUTPUT

Type 1/4" jack (open)

POWER SUPPLY

Voltage USA/Canada
120 V~, 60 Hz
Europe/U.K./Australia
230 V~, 50 Hz
Japan
100 V~, 50 - 60 Hz
General export model
120/230 V~, 50 - 60 Hz

Power consumption 10 W

Fuse 100 - 120 V~: T 100 mA H
200 - 240 V~: T 50 mA H

Mains connection Standard IEC connector

DIMENSIONS/WEIGHT

Dimensions (H x W x D) approx. 2 3/8" (60 mm) x 27" (687 mm) x 8 3/4" (221 mm)

Weight approx. 3.5 kg (7.71 lbs)

Weight

BEHRINGER is constantly striving to maintain the highest professional standards. As a result of these efforts, modifications may be made from time to time to existing products without prior notice. Specifications and appearance may differ from those listed or illustrated.

MIDI FOOT CONTROLLER FCB1010

7. WARRANTY

§ 1 WARRANTY CARD/ONLINE REGISTRATION

To be protected by the extended warranty, the buyer must complete and return the enclosed warranty card within 14 days of the date of purchase to BEHRINGER Spezielle Studiotechnik GmbH, in accordance with the conditions stipulated in § 3. Failure to return the card in due time (date as per postmark) will void any extended warranty claims. Based on the conditions herein, the buyer may also choose to use the online registration option via the Internet (www.behringer.com or www.behringer.de).

§ 2 WARRANTY

1. BEHRINGER (BEHRINGER Spezielle Studiotechnik GmbH including all BEHRINGER subsidiaries listed on the enclosed page, except BEHRINGER Japan) warrants the mechanical and electronic components of this product to be free of defects in material and workmanship for a period of one (1) year* from the original date of purchase, in accordance with the warranty regulations described below. If the product shows any defects within the specified warranty period that are not excluded from this warranty as described under § 3 and 4, BEHRINGER shall, at its discretion, either replace or repair the product using suitable new or reconditioned parts. In the case that other parts are used which constitute an improvement, BEHRINGER may, at its discretion, charge the customer for the additional cost of these parts.

2. If the warranty claim proves to be justified, the product will be returned to the user freight prepaid.

3. Warranty claims other than those indicated above are expressly excluded.

§ 3 RETURN AUTHORIZATION NUMBER

1. To obtain warranty service, the buyer (or his authorized dealer) must call BEHRINGER (see enclosed list) during normal business hours **BEFORE** returning the product. All inquiries must be accompanied by a description of the problem. BEHRINGER will then issue a return authorization number.

2. Subsequently, the product must be returned in its original shipping carton, together with the return authorization number to the address indicated by BEHRINGER.

3. Shipments without freight prepaid will not be accepted.

§ 4 WARRANTY REGULATIONS

1. Warranty services will be furnished only if the product is accompanied by a copy of the original retail dealer's invoice. Any product deemed eligible for repair or replacement by BEHRINGER under the terms of this warranty will be repaired or replaced within 30 days of receipt of the product at BEHRINGER.

2. If the product needs to be modified or adapted in order to comply with applicable technical or safety standards on a national or local level, in any country which is not the country for which the product was originally developed and manufactured, this modification/adaptation shall not be considered a defect in materials or workmanship. The warranty does not cover any such modification/adaptation, irrespective of whether it was carried out properly or not. Under the terms of this warranty, BEHRINGER shall not be held responsible for any cost resulting from such a modification/adaptation.

3. Free inspections and maintenance/repair work are expressly excluded from this warranty, in particular, if caused by improper handling of the product by the user. This also applies to defects caused by normal wear and tear, in particular, of faders, potentiometers, keys/buttons and similar parts.

4. Damages/defects caused by the following conditions are not covered by this warranty:

▲ improper handling, neglect or failure to operate the unit in compliance with the instructions given in BEHRINGER user or service manuals.

▲ connection or operation of the unit in any way that does not comply with the technical or safety regulations applicable in the country where the product is used.

▲ damages/defects caused by force majeure or any other condition that is beyond the control of BEHRINGER.

5. Any repair or opening of the unit carried out by unauthorized personnel (user included) will void the warranty.

6. If an inspection of the product by BEHRINGER shows that the defect in question is not covered by the warranty, the inspection costs are payable by the customer.

7. Products which do not meet the terms of this warranty will be repaired exclusively at the buyer's expense. BEHRINGER will inform the buyer of any such circumstance. If the buyer fails to submit a written repair order within 6 weeks after notification, BEHRINGER will return the unit C.O.D. with a separate invoice for freight and packing. Such costs will also be invoiced separately when the buyer has sent in a written repair order.

§ 5 WARRANTY TRANSFERABILITY

This warranty is extended exclusively to the original buyer (customer of retail dealer) and is not transferable to anyone who may subsequently purchase this product. No other person (retail dealer, etc.) shall be entitled to give any warranty promise on behalf of BEHRINGER.

§ 6 CLAIM FOR DAMAGES

Failure of BEHRINGER to provide proper warranty service shall not entitle the buyer to claim (consequential) damages. In no event shall the liability of BEHRINGER exceed the invoiced value of the product.

§ 7 OTHER WARRANTY RIGHTS AND NATIONAL LAW

1. This warranty does not exclude or limit the buyer's statutory rights provided by national law, in particular, any such rights against the seller that arise from a legally effective purchase contract.

2. The warranty regulations mentioned herein are applicable unless they constitute an infringement of national warranty law.

* Customers in the European Union please contact BEHRINGER Germany Support for further details.

The information contained in this manual is subject to change without notice. No part of this manual may be reproduced or transmitted in any form or by any means, electronic or mechanical, including photocopying and recording of any kind, for any purpose, without the express written permission of BEHRINGER Spezielle Studiotechnik GmbH.

BEHRINGER, BLUE DEVIL, VIRTUALIZER and V-AMP are registered trademarks.

ALL RIGHTS RESERVED.

© 2003 BEHRINGER Spezielle Studiotechnik GmbH.

BEHRINGER Spezielle Studiotechnik GmbH, Hanns-Martin-Schleyer-Str. 36-38, 47877 Willich-Münchheide II, Germany

Tel. +49 (0) 21 54 / 92 06-0, Fax +49 (0) 21 54 / 92 06-30