

# TRITON



MUSIC WORKSTATION/SAMPLER

# Operation Guide



**HI** HYPER INTEGRATED  
SYNTHESIS SYSTEM

**TouchView**  
Graphical User Interface

**VALVE FORCE**

**GENERAL  
MIDI**

**USB**

# KORG

Thank you for purchasing the **Korg TRITON Extreme music workstation/sampler**. To ensure trouble-free enjoyment, please read this manual carefully and use the instrument as directed.

## About this manual

### The owner's manuals and how to use them

The TRITON Extreme come with the following owner's manuals.

- Quick Start
- Operation Guide
- Parameter Guide
- Voice Name List

#### Quick Start

Read this manual first. This is an introductory guide that will get you started using the TRITON Extreme. It explains how to play back the demo songs, select sounds, use convenient performance functions, and perform simple editing. It also gives examples of using sampling and the sequencer.

#### Operation Guide

This manual describes each part of the TRITON Extreme and what it does, how to make connections, basic operation, and a summary of each mode. It also explains, for each mode, the basics of editing your sounds, recording on the sequencer, and sampling. The arpeggiator, effects, and MIDI are also explained. This manual also contains other information such as a troubleshooting guide and specifications.

#### Parameter Guide

The Parameter Guide contains explanations and other information regarding the operations of the parameters and settings on the TRITON Extreme. The explanations are organized by mode, and page.

Explanations and other information on the effects and their parameters are also provided for each effect. Refer to this guide when an unfamiliar parameter appears in the display, or when you need to know more about a particular function.

#### Voice Name List

This lists the multisamples and drumsamples that are built into the TRITON Extreme, and the factory preset combinations, programs, drum kits, and user arpeggio patterns.

Refer to these lists when you wish to know more about the preloaded sounds.

## Conventions in this manual

### References to the TRITON Extreme

The TRITON Extreme is available in 88-key, 76-key and 61-key models, but all three models are referred to without distinction in this manual as "the TRITON Extreme." Illustrations of the front and rear panels in this manual show the 61-key model, but the illustrations apply equally to the 88-key and 76-key models.

### Abbreviations for the manuals QS, OG, PG, VNL, EM

The names of the manuals are abbreviated as follows.

**QS:** Quick Start

**OG:** Operation Guide

**PG:** Parameter Guide

**VNL:** Voice Name List

**EM:** EXB-MOSS Owner's Manual (included with the EXB-MOSS option)

### Keys and knobs [ ]

References to the keys, dials, and knobs on the TRITON Extreme's panel are enclosed in square brackets [ ]. References to **buttons** or **tabs** indicate objects in the LCD display screen.

### Parameters in the LCD display screen " "

Parameters displayed in the LCD screen are enclosed in double quotation marks " ".

### Boldface type

Parameter values are printed in boldface type. Content that is of particular importance is also printed in boldface type.

### Procedure steps ① ② ③ ...

Steps in a procedure are listed as ① ② ③ ...

### p. ■

These indicate pages or parameter numbers to which you can refer.

### Symbols , ,

These symbols respectively indicate cautions, advice, and MIDI-related explanations.

### Example screen displays

The values of the parameters shown in the example screens of this manual are only for explanatory purposes, and may not necessarily match the values that appear in the LCD screen of your instrument.

### MIDI-related explanations

CC# is an abbreviation for Control Change Number. In explanations of MIDI messages, **numbers in square brackets [ ]** always indicate hexadecimal numbers.

---

.....

## Table of Contents

About this manual.....	ii
<b>Introduction.....</b>	<b>1</b>
Main features.....	1
Front and rear panel.....	3
Names and functions of objects in the LCD screen.....	8
Overview of the TRITON Extreme's modes.....	10
About polyphony.....	12
Basic operation.....	13
<b>Setup.....</b>	<b>15</b>
Connections.....	15
Turning the power on/off.....	18
<b>Playing and editing programs (Program Mode).....</b>	<b>19</b>
Program structure.....	19
Playing a program P0: Play.....	20
Program editing.....	23
Oscillator settings P1: Edit-Basic.....	24
Pitch settings P2: Edit-Pitch.....	26
Filter settings P3: Edit-Filter.....	27
Amplifier settings P4: Edit-Amp.....	28
LFO settings P5: Edit-Common LFO.....	29
Arpeggiator settings P7: Edit-Arpeggiator.....	30
Insert Effect settings P8: Edit-Insert Effect.....	30
Master Effect and Valve Force settings P9: Edit-Master Effect.....	30
More about Alternate Modulation.....	30
Auto Song Setup function.....	30
<b>Playing and editing combinations (Combination Mode).....</b>	<b>31</b>
Combination structure.....	31
Playing a combination P0: Play.....	32
Combination editing.....	33
Timbre 1–8 program, pan and volume P1: Edit-Program/Mixer.....	34
Settings for status, MIDI channel, and pitch parameters P2: Edit-Trk Param.....	35
MIDI filter settings P3: Edit-MIDI Filter.....	36
Layer, split, and velocity switch settings/Controller settings P4: Edit-Zone/Ctrl.....	36
Arpeggiator settings P7: Edit-Arp.....	37
Insert Effect settings P8: Edit-Insert FX.....	37
Master Effect and Valve Force settings P9: Edit-Master FX.....	37
Auto Song Setup function.....	38

<b>Producing songs (Sequencer mode).....</b>	<b>39</b>
Features of the sequencer.....	39
The structure of Sequencer mode.....	40
Preparations for recording.....	41
Recording methods.....	43
Song editing methods.....	50
Creating and playing a Cue List.....	53
Creating and recording RPPR (Realtime Pattern Play/ Record).....	55
Recording the sound of a combination or program... ..	58
Caution and other functions in Sequencer mode.....	59
<b>Sampling (Open Sampling System).....</b>	<b>61</b>
Features of sampling on the TRITON Extreme.....	61
How Sampling mode is organized.....	62
Samples and Multisamples.....	63
Preparations for sampling.....	64
Sampling and editing in Sampling mode.....	68
Sampling in Program, Combination, or Sequencer modes.....	80
<b>SMF (Standard MIDI File) playback.....</b>	<b>85</b>
How Song Play mode is structured.....	85
Playing SMF data.....	86
Playback using the Jukebox function.....	87
Playing along with SMF data.....	88
<b>Settings for the entire TRITON Extreme (Global mode).....</b>	<b>89</b>
How Global mode is structured.....	89
Basic Setup P0: Basic Setup.....	89
MIDI-related settings P1: MIDI.....	90
Pedal and other controller settings P2: Controller.....	90
Creating original scales P3: User Scale.....	91
Drum kit settings P5: Drum Kit.....	92
Arpeggiator settings P7: Edit-Arpeggiator.....	94
<b>Effect and Valve Force settings.....</b>	<b>103</b>
Routing settings and effect settings.....	104
Valve Force settings.....	109
<b>Loading and saving data, creating audio CDs, and editing Wave files (Media mode, etc.).....</b>	<b>113</b>
Types of data that can be saved.....	113
Writing to internal memory.....	114
The pages of Media mode.....	116
Saving on media Media, Save.....	117
File copying, deleting, and formatting (Media, Utility).....	119
Loading data Media, Load.....	121

---

Use sampled Wave files to create an audio CD and play it: Media, Make Audio CD, Play Audio CD.....	123
Editing a Wave file: Media, Edit WAVE.....	125
Viewing information about media: Media, Media Info.....	125
Handling CompactFlash and Microdrive media.....	125

**Restoring the factory settings ..... 127**

Restoring the factory settings .....	127
Loading the EXB-MOSS data.....	128

**Other functions ..... 129**

Setting the function of [SW1] and [SW2] .....	129
Setting the B-mode functions of REALTIME CONTROLS [1]-[4].....	129
Adjusting the contrast (brightness) of the LCD screen .....	129
Using tap tempo control.....	130
Shortcuts .....	130

**Appendices..... 131**

Troubleshooting .....	131
Media that can be used with the TRITON Extreme .	137
Specifications and options .....	138
Options.....	139
System requirements for computer connection.....	139
MIDI implementation chart .....	140
Index.....	141

# Introduction

## Main features

The TRITON Extreme is a music workstation/sampler that features the **HI (Hyper Integrated) synthesis system** as its tone generator.

It provides high-quality preset multisamples/programs/combinations together with a broad range of integrated features such as an effect section, 16-track MIDI sequencer, sampling, dual polyphonic arpeggiators, RPPR, four-channel audio input/six-channel audio output, and song play functionality.

You can modify the sound in realtime by using a wide range of performance controllers such as the joystick, ribbon controller, REALTIME CONTROLS and ARPEGGIATOR knobs, and pedals that you connect.

You can also expand the TRITON Extreme's capabilities by installing the MOSS modeling synthesizer or by adding more sample memory (RAM).

The TRITON Extreme music workstation is a powerful tool for music production or live performance.

### HI (Hyper Integrated) synthesis system

The HI (Hyper Integrated) synthesis system is a PCM tone generator system with full digital signal processing that guarantees pristine sound, and featuring enormous flexibility in musical expression, modulation, and effect routing.

\* The TRITON Extreme contains an analog vacuum tube circuit (Valve Force). When you use Valve Force, the signal is converted into analog form at that point.

#### Tone generator section:

- 160 Mbytes of preset PCM ROM contains 962 multisamples and 1,175 drumsamples.
- The TRITON Extreme is shipped with 16 Mbytes of RAM (you can expand this to a maximum of 96 Mbytes), letting you use samples or multisamples you sampled/resampled or loaded in Media mode.
- The sampling frequency is 48 kHz, and the maximum polyphony is 60 voices (a maximum of 120 voices can be used depending on the PCM sounds you use).

#### Filter/synthesis section:

- Either a 24 dB/oct Resonant Low Pass or a 12 dB/oct Low Pass & High Pass type filter can be used. A wide variety of filter effects can be achieved, from active sounds with aggressive resonance to subtle tones using a high pass filter.
- A broad range of editing parameters gives you precise control over every aspect of the sound.

#### Effect section:

- Five insert effects (stereo-in/stereo-out), two master effects (mono-in/stereo-out), and a three-band master EQ (stereo-in/stereo-out) can all be used simultaneously. You can select and edit any of 102 types of effect algorithms.
- The effect routing is highly flexible. Effects can be routed freely to the individual inputs and outputs.

#### Alternate Modulation and Effect Dynamic Modulation:

- The synthesis section (filter etc.) provides Alternate Modulation capabilities, and the effect section provides Effect Dynamic Modulation. This allows you to freely apply modulation to parameters that affect the pitch, filter, amp, EG, LFO, and effects etc.
- LFO, delay time and other effect parameters can be synchronized to an external MIDI clock. You can also synchronize sounds and effects to the tempo of the internal sequencer or the arpeggiator.

#### Valve Force circuit:

- This section includes an analog low-frequency boost circuit plus a vacuum tube amp that uses a 12AU7 (ECC82) vacuum tube. One vacuum tube is used to support stereo-in/stereo-out. Proprietary Korg technology is used to generate warm and powerful sound with the rich overtones and smooth distortion typical of vacuum tubes, while retaining clarity and definition.

### Programs and combinations

#### Programs:

- In addition to 1,536 user programs, 256 programs (and 9 drum kits) for GM2 compatibility are provided as ROM presets.  
You can use a rich array of editing parameters, effects, Valve Force, and the arpeggiator to modify the 1,536 user programs and create your own original programs. When the TRITON Extreme is shipped from the factory, user memory contains 1,344 high-quality programs that cover a wide range of needs. When the EXB-MOSS option is installed, 128 programs for use with the Korg MOSS tone generator will also be available.
- The TRITON Extreme provides 144 user drum kits as well as 9 ROM drum kits compatible with GM2. The factory settings contain 50 preloaded drum kits that cover a wide range of musical styles.  
You can create your own drum kits by assigning each key to any one of the 1,175 drum samples or to an original sample that you sampled or loaded in from media. For the sound assigned to each key, you can make filter and amp settings, and even route the sound to effects or individual audio outputs.
- You can easily create programs using multisamples or samples that you yourself sampled/resampled or loaded in Media mode. You can then use these programs in combinations and songs. You can also use samples as drum instruments in a drum kit.

#### Combinations:

- The TRITON Extreme provides 1,536 user combinations. Each combination can combine up to eight layered/split/velocity-switched programs, together with settings for effects, the Valve Force circuit, and the two arpeggiators. Combinations let you create very complex sounds that could not be produced by a program alone. You can also use an external sound module as part of a combination. When the TRITON Extreme is shipped, user memory contains a versatile range of 1,280 preloaded combinations.

---

## Sequencer

A sophisticated 16-track MIDI sequencer is built in.

- The TRITON Extreme combines dual arpeggiators, RPPR, time slice, in-track sampling, and many other functions, giving you an integrated music production environment with even more potential than an external sequencer would provide. MIDI exclusive message recording/playback is also supported.
- The Cue List function lets you play up to 99 songs in the order you specify. For example you could create separate songs for the intro, melody A, melody B, and the break, etc., and easily try out different song structures using the same material. You can also specify the number of times that each song will repeat. Songs can also be played back consecutively in jukebox style.
- A completed song can be resampled as a Wave file and burned to a CD-R/RW drive (sold separately) connected to the USB A connector to create an original audio CD.

## Sampling

The TRITON Extreme features our Open Sampling System that allows sampling and resampling to be performed not only in Sampling mode, but also in Program, Combination, or Sequencer modes.

48 kHz 16-bit linear mono/stereo sampling is supported.

- **Sample memory (RAM)** of 16 Mbytes is factory-installed, allowing approximately 2 minutes 54 seconds of mono sampling (or approximately 1 minute 27 seconds of stereo sampling). Sample memory can be expanded to a maximum of 96 Mbytes, which allows you to record up to six samples of approximately 2 minutes 54 seconds each (mono) or approximately 1 minute 27 seconds each (stereo), for a total 17 minutes 28 seconds of sampling time.
- The **media** (Option) lets you record up to 80 minutes as a single sample file in either mono or stereo (monaural: approximately 440 Mbytes, stereo: approximately 879 Mbytes). This will create a WAVE file. (In order to play a media sample from the TRITON Extreme's keyboard, it must be able to be loaded into the sampling memory (RAM).)

 In order to sample to media on the TRITON Extreme, you will need to obtain media of the recommended type (sold separately). (p.137)

## Song Play

In Song Play mode you can play SMF (Standard MIDI File) data directly from media. You can also play the keyboard along with the SMF playback, and use the arpeggiator in synchronization with the playback tempo of the SMF. Format 0 and 1 are supported, and you can also use the Jukebox function to edit the playback order of the songs.

## Dual polyphonic arpeggiator

- Five preset **arpeggio patterns** (UP, DOWN, ALT1, ALT2, RANDOM) and 507 user arpeggio patterns are built-in.
- With the factory settings, these contain a wide variety of preload user patterns (489).
- In addition to providing conventional arpeggiator functions, the polyphonic arpeggiator of the TRITON Extreme can respond to the pitches or timing at which you play the keyboard, and produce a diverse range of chords or phrases. This can be used to play a variety of

drum phrases (using the "Fixed Note Mode" that is ideal for drums), bass phrases, or guitar and keyboard backing riffs. The arpeggiator is also effective for use with subtly moving pads, synth sounds, or sound effects.

- In Combination mode, Sequencer mode, and Song Play mode, the TRITON Extreme provides dual arpeggiators that can simultaneously play two arpeggio patterns. You can apply separate arpeggio patterns to drum and bass programs, or use keyboard splits or velocity to switch between arpeggio patterns for an even more dynamic performance.

## RPPR

- The TRITON Extreme features Korg's RPPR (Realtime Pattern Play/Recording) function.

In Sequencer mode, this function allows you to assign preset patterns or user patterns (with a specified playback track) to individual notes of the keyboard, and playback that pattern in realtime simply by pressing the assigned note. Numerous preset patterns, including patterns ideal for drum tracks, are built into the internal memory.

## 4-channel audio input/

## 6-channel audio output

- Both analog (2 channel) and digital (2 channel) audio inputs are standard, allowing you to record stereo samples. The analog inputs have a MIC/LINE level select switch and a level knob, accommodating a wide range of audio sources from mic level to line level. The built-in digital input supports 48 kHz S/P DIF format digital audio. The audio input can be routed through effects and/or Valve Force. During sampling, you can apply effects or Valve Force, use the TRITON Extreme as a 4-in/6-out effect processor, or use a vocoder effect that combines the audio input with internal sounds.
- Six channels of audio output are provided. For analog output, you have the L/MONO and R main stereo output, as well as four independent audio outputs (INDIVIDUAL) 1, 2, 3, and 4. Individual oscillators, drums, timbres/tracks, or the output of an insert effect can be freely routed to any of these outputs. For digital output, there's an S/P DIF connector (two channels; L/MONO and R) that supports a sampling frequency of 48 kHz.

## TouchView user interface

As its user interface, the TRITON Extreme features the TouchView system with a large 320 × 240 pixel LCD touch-panel that lets you perform functions simply by touching the screen – a revolutionary leap in operability and practicality.

## USB connectors allow connection to a CD-R/RW drive and computer

The TRITON Extreme provides a USB A connector and a USB B connector, allowing you to save data on USB storage media (hard disks, removable disks, CD-R/RW drives).

You can back-up data from media in the CF card slot to your computer, or edit data on your computer and load it into the TRITON Extreme.

## Front and rear panel

### Front panel

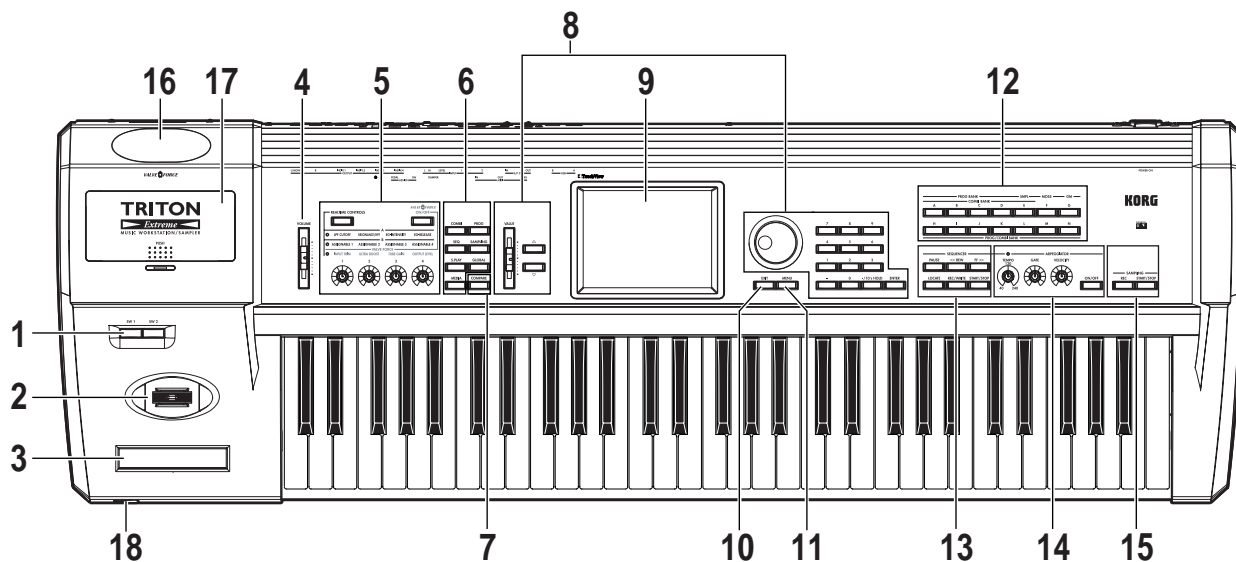

#### 1. [SW1] key, [SW2] key

These keys are on/off switches, their function can be assigned in Program, Combination, Sequencer, Song Play, and Sampling modes. When on, the key will light (☞p.21).

#### 2. Joystick

Various program parameters and effect parameters will determine what is being controlled by the joystick. Move the joystick up/down and left/right (+Y, -Y, -X, +X) to vary the effect (☞p.21).

#### 3. Ribbon controller

Various program parameters and effect parameters will determine what is controlled by the ribbon controller. Slide your finger to the left or right on this ribbon controller to vary the effect (☞p.21).

#### 4. [VOLUME] slider

This adjusts the volume that is output from the AUDIO OUTPUT (MAIN) L/MONO, R jacks and the headphone jack.

#### 5. REALTIME CONTROLS

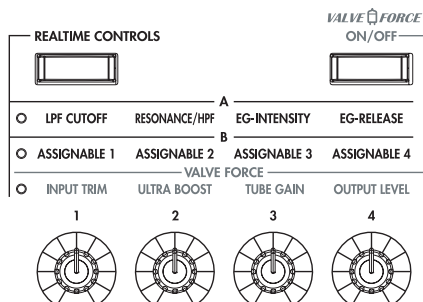

Use the [REALTIME CONTROLS] key to select either the A mode, B mode or VALVE FORCE functions for the realtime controllers, and use knobs [1]–[4] to control the tone, effects, MIDI control changes and Valve Force in realtime (☞p.22, QS p.6).

#### [REALTIME CONTROLS] key

This key selects either A, B or Valve Force mode for the realtime controllers. The selected mode will light.

#### VALVE FORCE [ON/OFF] key

Switches the Valve Force function on/off. When on, this key will light.

#### [1] knob, [2] knob, [3] knob, [4] knob

In **A mode**, the function of each knob is fixed. [1] is the low pass filter cutoff frequency, [2] is the filter resonance level or the cutoff frequency of the high pass filter, [3] is the filter EG intensity, and [4] is the filter/amp release time.

In **B mode**, each knob will control the function that was assigned to it in the Program, Combination, Sequencer, Song Play, or Sampling modes.

The **Valve Force** functions of the knobs are fixed; knob [1] controls the input level to Valve Force, knob [2] controls the mix level of the Valve Force analog ultra-low boost circuit, knob [3] controls input gain to the vacuum tube, and knob [4] controls the output level from Valve Force.

⚠ Depending on the sound you are using, you may hear noise if you turn the Valve Force knobs or edit Valve Force parameters while sound is being produced.

## 6. Mode keys

Use these keys to enter the desired mode.

When you press a key, the key will light, and you will enter the mode whose key you pressed (see p.10).

### [COMBI] key

Combination mode will be selected.

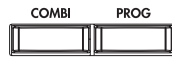

### [PROG] key

Program mode will be selected.

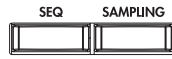

### [SEQ] key

Sequencer mode will be selected.

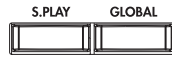

### [SAMPLING] key

Sampling mode will be selected.

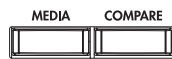

### [S.PLAY] key

Song Play mode will be selected.

### [GLOBAL] key

Global mode will be selected.

### [MEDIA] key

Media mode will be selected.

## 7. [COMPARE] key

Use this key when you wish to compare the sound of the program or combination that you are currently editing with the un-edited sound already in memory. You can also use this key to make "before and after" comparisons when recording or editing in Sequencer mode (see p.14).

## 8. VALUE controllers

The following VALUE controllers are used to set the value of the selected parameter (see p.14).

### [VALUE] slider

Use this to modify the value of a parameter. This controller is convenient when you wish to make large changes in the value.

This slider can also be used as a modulation source.

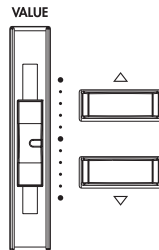

### [△][▽] keys

These are used to increase or decrease the parameter value in steps of one. These keys are convenient for making fine parameter adjustments.

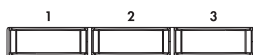
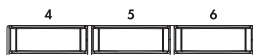
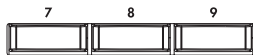
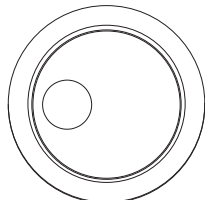

### [VALUE] dial

Use this dial to modify the value of the parameter.

## Numeric keys [0] – [9], [ENTER] key, [-] key

### [./10's HOLD] key

Use these keys to numerically input a parameter value.

Use numeric keys [0]–[9], the [-] key, and the [./10's HOLD] key to enter the value, and press the [ENTER] key to confirm it. The [./10's HOLD] key lets you input a value with a decimal point. The [-] key inverts the sign (+/-) of the parameter value.

The [./10's HOLD] key is also used when you wish to hold the 10's place while selecting programs or combinations.

By holding down the [ENTER] key while you press a numeric key [0]–[9] you can select up to ten page menu commands from the current page. In Program and Combination modes, you can hold down the [ENTER] key and press the SEQUENCER [REC/WRITE] key to turn on the Auto Song Setup function. (see p.58)

## 9. LCD screen

The TRITON Extreme features our exclusive TouchView graphic interface, based on a touch-panel LCD screen.

By touching on objects that are shown in the LCD screen, you can select pages, tabs, and parameters, and set values (see p.8).

## 10. [EXIT] key

When in P (page) 1–9 of each mode, pressing the [EXIT] key will move to P (page) 0 of that mode.

When a dialog box is open, this key will cancel the settings made in the dialog box and close the dialog box (corresponds to the Cancel button). If a popup menu or page menu is open, pressing [EXIT] will close the menu.

## 11. [MENU] key

Use this key to move between pages. When you press the [MENU] key, a list of the pages in the mode will appear in the LCD screen. Press the desired page, and you will move to that page. You can also move to a page by holding down the [MENU] key and pressing the corresponding numeric key [0]–[9] (see p.9, 13).

## 12. BANK keys

These keys are used to switch the program/combination bank.

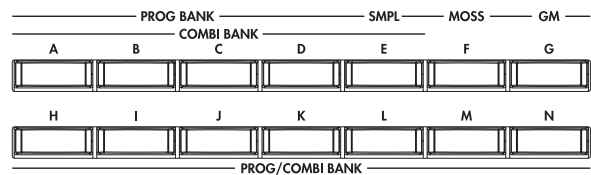

### PROG BANK:

[A], [B], [C], [D], [E] (SMPL), [F] (MOSS), [G] (GM), [H], [I], [J], [K], [L], [M], [N]

### COMBI BANK:

[A], [B], [C], [D], [E], [H], [I], [J], [K], [L], [M], [N]

In Program mode, these keys select the program bank.

In Combination mode, these keys select the combination bank. When assigning a program to the various timbres in a combination, then these keys will select the program bank. In this case, the key of the program bank selected for the timbre will light.

In Sequencer and Song Play modes when the edit cell (highlighted area) is located on the program name of a track, these keys will select the program bank, just as in Combination mode.



Each time you press the [G] key when selecting a program, the bank selection will step to the next GM(2) bank or GM drum bank in the following order: G, g(1), g(2)–g(8), g(9), g(d), G, g(1) etc ...

The F bank can be only be selected in Program mode, and only if the EXB-MOSS option is installed.

### 13. SEQUENCER

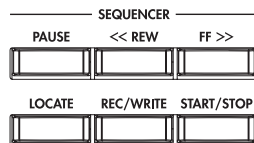

#### [PAUSE] key

In Sequencer mode, this key pauses the playback of the song or cue list. In Song Play mode, this key pauses SMF playback. When paused, the key will light. Press [PAUSE] once again to resume playback; the key will turn off.

#### [<<REW] key

In Sequencer mode, this key will rewind the song or cue list. When you press and hold this key, the key will light, and the playback will rewind. (This key will not function during recording.)

#### [FF>>] key

In Sequencer mode, this key will fast-forward the song or cue list. When you press and hold this key, the key will light, and the playback will fast-forward. (This key will not function during recording.)

#### [LOCATE] key

In Sequencer mode, this key will advance or rewind the song or cue list playback to a specified point. In Song Play mode, this key moves to the specified playback location within the SMF data.

#### SEQUENCER [REC/WRITE] key

In Sequencer mode, pressing this key will make the key light, and if you then press the SEQUENCER [START/STOP] key, recording will begin (see p.43).

In Program, Combination and Global modes, pressing this key will open a dialog box, and if you then press the OK button, the edited contents will be written (see p.114, 116). In Program or Combination mode, you can hold down the [ENTER] key and press this key to turn on the Auto Song Setup function. (see p.58)

#### SEQUENCER [START/STOP] key

This is the start/stop key for song or cue list recording and playback in Sequencer mode, and SMF playback in Song Play mode.

During recording and playback, the key will blink at the current tempo.

These keys are also used to play an audio CD in the USB-connected CD-R/RW drive.

SEQUENCER [START/STOP] key : Play/Stop  
 [FF>>] key : Fast-forward  
 [<<REW] key : Rewind  
 [PAUSE] key : Pause  
 [LOCATE] key : Move to the specified location

### 14. ARPEGGIATOR

These knobs control the performance of the arpeggiator in realtime (see QS p.11).

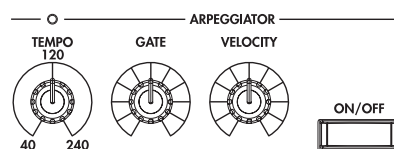

#### [TEMPO] knob

This adjusts the base tempo of the arpeggiator and sequencer. The LED will blink at quarter-note intervals of the current tempo.

#### [GATE] knob

This adjusts the gate time (note duration) of the arpeggiated notes. At the center position (12 o'clock), the gate time will be the same as the "Gate" parameter of the arpeggiator. Rotating the knob toward the left will shorten the gate time, and rotating it toward the right will lengthen the gate time.

#### [VELOCITY] knob

This adjusts the velocity (playing strength) of the arpeggiated notes. At the center position (12 o'clock), the velocity will be the same as the "Velocity" parameter of the arpeggiator. Rotating the knob toward the left will decrease the velocity, and rotating it toward the right will increase the velocity.

#### [ON/OFF] key

This switches the Arpeggiator function on/off. When on, the key will light.

### 15. SAMPLING

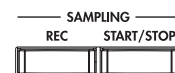

#### SAMPLING [REC] key

In Sampling, Program, Combination, and Sequencer modes, pressing this key will make the key light, and when you continue by pressing the SAMPLING [START/STOP] key, sampling will either begin or you will enter the sample-ready mode.

#### SAMPLING [START/STOP] key

In Sampling, Program, Combination, and Sequencer modes, pressing this key after pressing the SAMPLING [REC] key will either cause sampling to begin, or it will access the sample-ready mode.

In the Sampling P1: Sample Edit page, pressing this key will sound the selected sample.

This key is also used to play back a WAVE file from the media. This function can be used in the directory window of various Media mode pages, in the Media mode Make Audio CD page, and in the "Select Directory" page menu dialog box of the Program, Combination, Sequencer, and Sampling modes.

### 16. Valve cover

A 12AU7 (ECC82) vacuum tube (a.k.a. "valve") is built-in.

 The valve cover may break if subjected to impact. Be particularly careful not to subject it to direct impact, since this may also break the vacuum tube. If the valve cover breaks, have it repaired immediately, since failing to do so may cause the vacuum tube or other parts to malfunction.

---

### 17. Sample memory (RAM) slot cover

You can open this cover and install SIMM boards to expand the sample memory (RAM). A maximum of three 32 Mbyte SIMM boards can be installed as sample memory (RAM). (☞PG p.321)

### 18. Headphone jack

A set of headphones can be connected here (stereo 1/4" jack).

This allows stereo monitoring of the same signal as the OUTPUT L/MONO and R jacks.

---

## Rear panel

### 1. AC power supply connector

Connect the included power supply cable here. After connecting the power supply cable to the TRITON Extreme, connect the other end to an AC outlet (☞p.16).

### 2. [POWER] switch

This switch turns the power on/off (☞p.18).

### 3. AUDIO OUTPUT

Connect these outputs to the input jacks of your amp or mixer. In addition to the L/MONO and R main stereo audio outputs, the TRITON Extreme provides four individual audio outputs. The sound from each oscillator, drum, timbre/track, or insert effect can be freely routed to any output (☞p.104-).

#### (MAIN) L/MONO, R

These are unbalanced phone jacks.

These are the main audio output jacks. By setting "BUS Select" to L/R, the output from an oscillator, an insert effect, an individual drum part, or the metronome can be output to the (MAIN) L/MONO and R jacks.

When making connections in stereo, use L/MONO and R. When making connections in mono, use the L/MONO jack.

#### (INDIVIDUAL) 1, 2, 3, 4

These are unbalanced phone jacks.

These are individual (independent) audio output jacks. By setting the "BUS Select" to 1, 2, 3(Tube), 4(Tube), 1/2, or 3/4(Tube), an oscillator, an insert effect, an individual drum part, or the metronome etc. can be assigned to be output from the (INDIVIDUAL) 1, 2, 3, 4, jacks.

The output from the 1, 2, 3, 4 jacks is not affected by the [VOLUME] slider.

### 4. AUDIO INPUT

These two audio inputs are used when recording a mono/stereo sample from a mic or external audio source, or when applying the TRITON Extreme's internal effects to an external audio source (☞p.64, 107, 111).

The MIC/LINE level select switch ([MIC/LINE] switch) and the level adjustment knob ([LEVEL] knob) allow you to use a wide range of external audio sources, ranging from mic level to line level.

#### AUDIO INPUT 1/2 jacks

These are unbalanced phone jacks.

#### [LEVEL] knob

This adjusts the input level of the AUDIO INPUT 1/2 jacks.

#### [MIC/LINE] switch

This switches the input level of the AUDIO INPUT 1/2 jacks.

### 5. S/P DIF

#### OUT(MAIN) jack

This is an optical type S/P DIF format (IEC60958, EIAJ CP-1201) digital output jack.

It outputs a digital version of the same audio signal as the AUDIO OUTPUT (MAIN) L/MONO and R jacks, at sampling rates of 48 kHz.

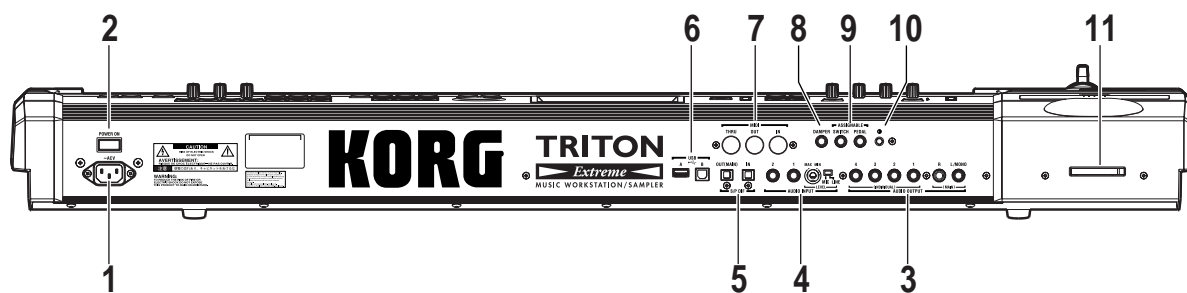

Use an optical cable to connect this to the optical digital input jack of a DAT or MD, etc.  
The [VOLUME] slider does not adjust the output level of this jack.

### IN jack

This is an optical S/P DIF format (IEC 60958, EIAJ CP-1201) digital input jack.  
Digital audio at a sample rate of 48 kHz can be input here.  
Use an optical cable to connect this jack to the optical digital output jack of a DAT or other device.

### 6. USB

#### USB A connector (for connecting a CD-R/RW drive, etc.)

You can connect an external USB device to this connector.  
Use this connector to connect storage media such as a hard disk, MO, or CD-RW drive. (PG p.325)

#### USB B connector (for connecting to a computer)

You can connect your computer to this connector. This lets you use your computer to access data on the TRITON Extreme's CompactFlash (Microdrive) card. This connection also lets you send and receive MIDI data between the TRITON Extreme and your computer. (PG p.325)

#### What is USB?

USB stands for **Universal Serial Bus**, and is an interface for transferring data between a computer, a keyboard and/or peripheral devices.

### 7. MIDI

#### MIDI THRU connector

Musical data and sound settings etc. that are received at the MIDI IN connector are re-transmitted without change from the MIDI THRU connector.

You can use this to connect multiple MIDI devices (PG p.288).

#### MIDI OUT connector

Musical data and sound settings etc. are transmitted from this connector.

Use this to control another MIDI device connected via this port to the TRITON Extreme (PG p.288).

#### MIDI IN connector

Musical data and sound settings etc. are received at this connector.

Use this to play the TRITON Extreme from another MIDI device connected to this port (PG p.288).

### 8. DAMPER jack

An optional switch-type pedal such as the Korg DS-1H damper pedal can be connected here.  
If a DS-1H is connected, it will function as a half-damper pedal. If another switch-type pedal is connected, it will function as a damper switch. In order to ensure that the pedal functions correctly, please adjust the polarity and the half-damper sensitivity (PG p.157, 165).

### 9. ASSIGNABLE

#### SWITCH jack

An optional on/off foot switch such as the Korg PS-1 foot switch can be connected here.

In Global mode you can specify the function of this switch. For example, you can use it as a modulation controller, to select programs or combinations, to start/stop the sequencer, or to set the tap tempo. (p.90).

#### PEDAL jack

An optional Korg EXP-2 or XVP-10 expression pedal can be connected here.

Its function can be assigned in Global mode, allowing you to use the pedal to control the volume etc. (p.90)

### 10. [Contrast adjustment] knob

This adjusts the contrast of the LCD screen.  
The optimal setting will depend on the height or angle from which you view the screen display, so please adjust as necessary.

### 11. CF card slot

You can insert a CompactFlash or Microdrive into this slot. The power must be off when inserting or removing media. For details on how to handle these types of media, refer to p.125.

#### Eject button

After making sure that the TRITON Extreme's power is turned off, press this button to remove the media. If the media does not eject when you press this button, do not attempt to remove the media by force. Contact a nearby musical instrument dealer.

# Names and functions of objects in the LCD screen

The TRITON Extreme uses Korg's TouchView graphical user interface. By touching objects displayed in the LCD screen, you can select pages, set parameter values, rename programs and combinations, write data, and perform many other operations.

**note** References in the TRITON Extreme's owner's manual to the "... button" or "... tab" refer to objects displayed on the LCD screen. References to the "[...] key," "[...] knob," "[...] dial," or "[...] slider" refer to controls on the front or rear panel of the TRITON Extreme.

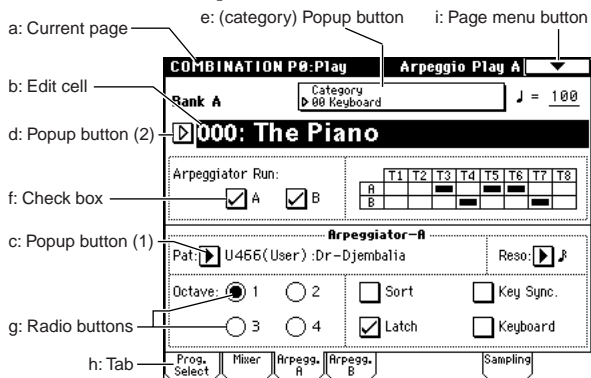

## a: Current page

This indicates the selected page within the current mode. From the left, this shows the mode name, page number, and page name.



## b: Edit cell

When you press a parameter in the LCD screen, the parameter or parameter value will sometimes be high-lighted (displayed in inverse video). This is called the **edit cell**, and the highlighted item will be subject to editing. The parameter value of the edit cell can be modified using the VALUE controllers (p.14) or by using a popup button in the LCD screen. For parameters that accept a note number or a velocity value, you can also hold down the [ENTER] key and play a note on the keyboard to enter the note number or velocity value.

## c: Popup button (1)

When this button is pressed, a popup menu will appear, showing the parameter values that are available for selection.

To input the parameter value, press the desired value in the popup menu.

When a popup menu is displayed, operating a VALUE controller (p.14) will close the popup menu. If the popup menu is unlocked (p. "Pin"), it will close if you touch a location outside the popup menu.

## \* Popup menu

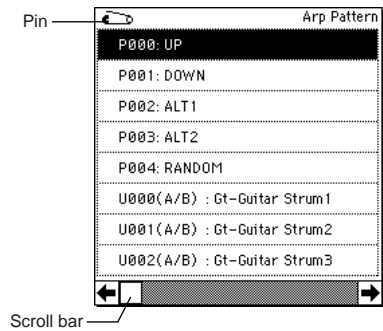

## Pin

This switches the popup menu display between **locked** and **unlocked**.

When locked, the pin will be shown closed, and the popup menu will remain displayed even after you press a parameter value. When unlocked, the pin will be shown opened, and the popup menu will close immediately when you press a parameter value.

## Scroll bar

Use this when you wish to see parameter values that extend beyond what can be displayed in the screen at one time.

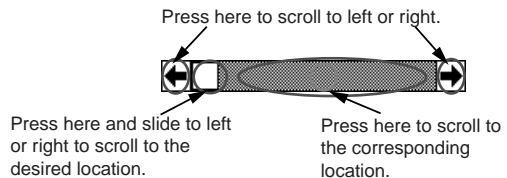

## d: Popup button (2)

When you press this button, a tabbed **popup menu** will appear, allowing you to perform the following selections.

- "Bank/Program Select," "Bank/Combination Select": Select programs or combinations by bank
- "Multisample Select": Select a multisample for a program oscillator by category (ROM multisamples only)
- "Category/Effect Select": Select an insert effect or master effect by category  
To close the tabbed popup menu, press the OK button or Cancel button.

## e: (Category) popup button

When you press this button, a tabbed **popup menu** will appear, allowing you to perform the following selections.

- "Category/Program Select," "Category/Combination Select": Select programs or combinations by category  
To close the tabbed popup menu, press the OK button or Cancel button.

**f: Check box**

Each time you press a check box, a check mark will be added or removed.

When checked, the parameter will function; when unchecked, the parameter will not function.

**g: Radio buttons**

Press a radio button to select one value from two or more choices.

**h: Tab**

Press the tab to select a page.

**i: Page menu button**

When this button is pressed, a list of page menu commands will appear.

The page menu commands that appear will depend on the currently selected page.

You can also select up to ten page menu commands by holding down the [ENTER] key and pressing a numeric key [0]–[9].

The page menu will close when you press the LCD screen at a location other than the page menu, or when you press the [EXIT] key.

**\* Dialog box**

The dialog box that appears will depend on the currently selected page menu command.

When selecting a program or combination number in a dialog box, use the VALUE controllers (p.14) to input the number.

To execute, press the OK button. To cancel without executing, press the Cancel button. (The operation will occur when you press and release the button.) The dialog box will close. The [EXIT] key corresponds to the Cancel button, Done button, and Exit button.

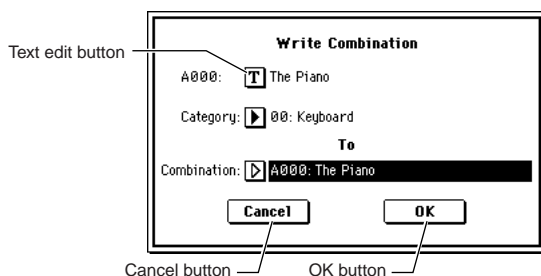

**!** After some commands are executed, the previously-locked page menu will be unlocked automatically, and the page menu will be closed.

**\* Text edit button**

When you press this button, a text edit dialog box will appear.

Here you can rename text (such as the name of a program, combination, or song etc.) (p.115).

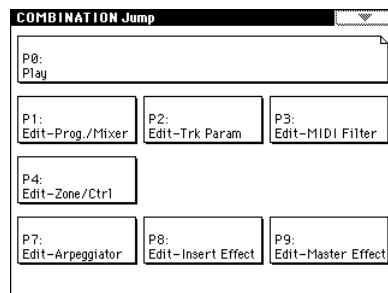
**\* Page jump menu**

In Combination, Program, Sequencer, Sampling, Song Play, or Global modes, you can press the front panel [MENU] key to view a list of the pages in that mode. (As a reminder, the page you were in before you pressed the [MENU] key will have its top right corner bent over.) By pressing one of the pages shown, you can move to that page. (You can also move to the corresponding page by pressing a numeric key [0]–[9].)

When you press the [EXIT] key, P0 will be displayed.

**\* Other objects**

To modify the parameter value of an object shaped like a slider or knob, press it to move the edit cell to that object, and use the VALUE controllers to modify the value. In addition, there are also buttons similar to the OK button and Cancel button explained in “\* dialog box” which execute an operation when they are pressed and released, such as the Done button, Copy button, and Insert button.

**Toggle buttons**

This type of button will change its function or switch on/off each time it is pressed.

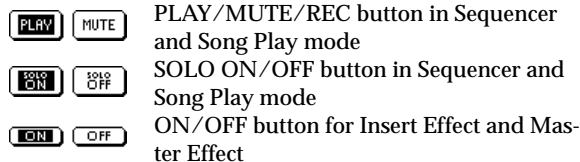

# Overview of the TRITON Extreme's modes

The TRITON Extreme has a large number of functions that let you play and edit programs and combinations, record and play sequence data, record and play back samples, and manage data on media. The largest unit used to organize these functions is called a mode. The TRITON Extreme has seven modes.

## Program mode

- Select and play programs  
You can choose programs from rewritable banks A-F and H-N which contain a total of 1,664 programs, and non-rewritable bank G (256 programs compatible with the GM2 standard, and nine drum programs). (The 128 programs of bank F can be selected only if the EXB-MOSS option has been installed.)
- Sample or resample.  
For example you can sample an external audio source while listening to the performance of the arpeggiator, or resample a performance you play using a program.
- Edit a program  
Make settings for the oscillator, filter, amp, EG, LFO, effects, valve force, and arpeggiator.

The following multisamples are available for the oscillator.

- 962 internal multisamples (160 Mbytes)
- Multisamples (RAM) that you sampled on the TRITON Extreme or loaded in from media (maximum of 96 Mbytes)
- Create drum programs using a drum kit (created in Global mode)

## Combination mode

- Select and play combinations  
A combination is a set of two or more programs (up to a maximum of eight), and allows you to produce complex sounds that could not be created by an individual program.  
You can choose combinations from rewritable banks A-E and H-N which contain a total of 1,536 combinations.
- Sample or resample.  
For example you can sample an external audio source while listening to the performance of the arpeggiators, or resample a performance you play using a combination.
- Edit a combination  
Make settings for volume, pan, layer/split etc. for each timbre (program), and make settings for effects, valve force and the two arpeggiators.

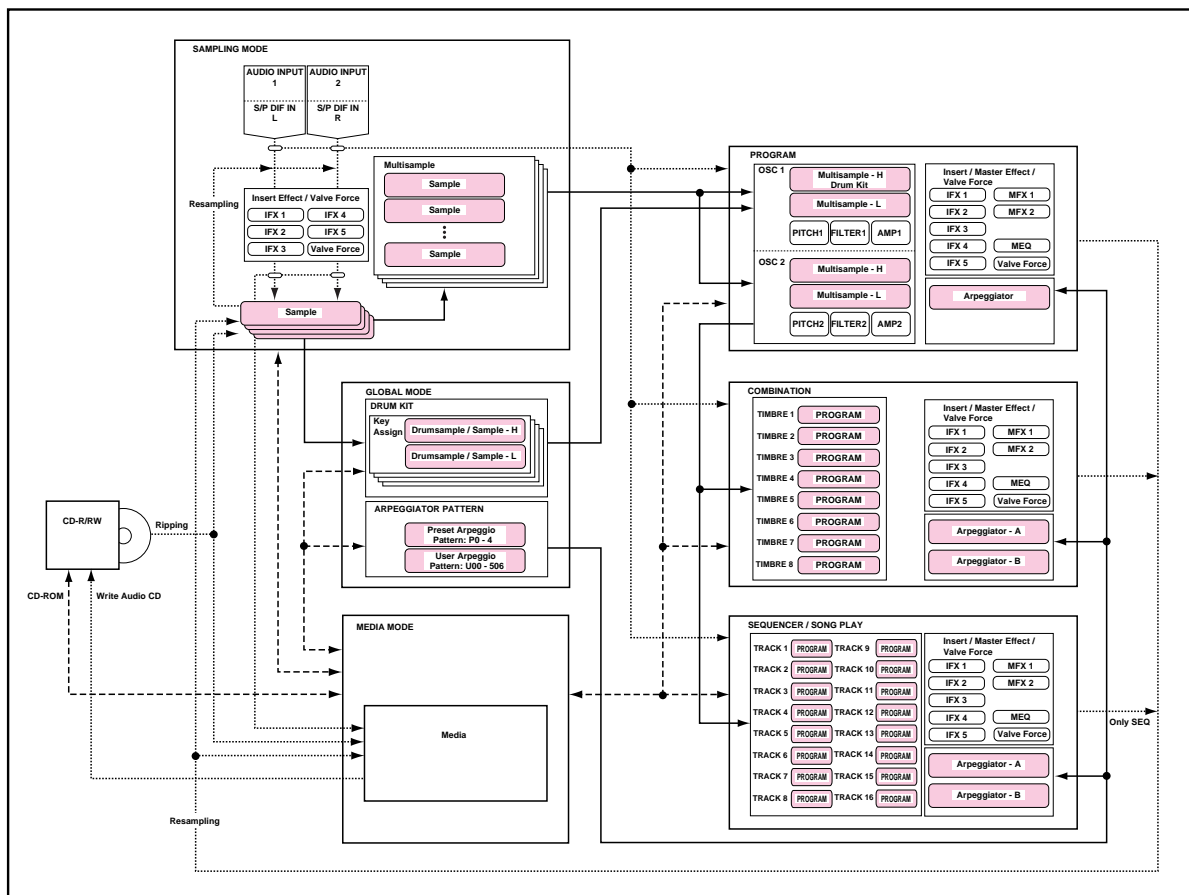

### Sequencer mode

- Use the 16-track MIDI sequencer to record and play songs.
- Record onto the sixteen MIDI tracks individually or all sixteen tracks at once. Exclusive messages can also be recorded and edited.
- Perform sampling/resampling.  
An external audio input source can be sampled in synchronization with the song playback. When doing so, you can automatically create a note event that will be used to trigger the resulting sample, letting you record an external audio source just as if you were recording onto an audio track. (This is called the “In-track Sampling” function.)  
You can also resample the playback of a song. After resampling your song to media, you can then use Media mode to write the song to a CD-R/RW drive connected to the TRITON Extreme’s USB A connector, creating your own audio CD.
- Make effect and Valve Force settings for a song.
- You can record a performance that uses the arpeggiator(s) into a song or pattern.
- You can use a cue list to create an arrangement using individual songs for each verse, chorus, bridge, etc., and specify the number of repeats for each song.
- You can use a maximum of 20 cue lists, 200 songs, and 100 preset patterns. One song can use as many as 100 patterns.
- The TRITON Extreme can be used as a 16-part multitimbral tone generator.
- Perform using the RPPR (Realtime Pattern Play/Recording) function, and adjust the various settings.

### Song Play mode

- SMF (Standard MIDI File) data can be played back from a media, and you can perform along with the playback.
- Make effect and valve force settings for use in Song Play mode.
- The arpeggiator can be used while you play along with the SMF playback.
- SMF songs can be played back in succession.  
You can use the jukebox function to playback songs in any specified order.

### Sampling mode

- Sample external audio sources (i.e., record samples). Insert effects, valve force can be applied to the external input sound while you sample.
- Edit the waveform data you sampled or waveform data that you loaded in from media, and set loop points etc.
- Edit multisamples consisting of two or more samples.
- A multisample can be converted into a program, so that a multisample created in Sampling mode can be used in the Program, Combination, Sequencer, or Song Play modes.
- “Rip” (directly sample) digital data from an audio CD in a CD-R/RW drive connected to the USB A connector. You can also play back audio CDs.

### Global mode

- Make settings that affect the entire TRITON Extreme, such as master tune and global MIDI channel.
- Create user drum kits (144 kits), user arpeggio patterns (507 patterns), and user scales (16 one-octave scales and 1 all-note scale).
- Create drum kits using the 1,171 internal drum samples (ROM). You can also use RAM samples that you created on the TRITON Extreme or loaded from media.
- Rename program and combination categories.
- Set the function of the assignable pedals and assignable switches.
- Transmit data dumps of MIDI exclusive data.

### Media mode

- Data of each mode can be saved and loaded using CompactFlash or Microdrive media.
- Format the above types of media. You can also manage data by copying it, etc.
- Korg, AKAI, AIFF, and WAVE format sample data can be loaded. Sample data can also be saved in Korg format, or exported in AIFF or WAVE formats.
- Songs that you created in Sequencer mode can be saved in SMF format. SMF files can be loaded as Sequencer mode songs.
- You can use the Data Filer function (to save/load MIDI exclusive data).
- Edit Wave files.
- Specify the song order of Wave files and use a CD-R/RW drive connected to the USB A connector to create an audio CD. You can also play back audio CDs.
- Use a computer connected to the USB B connector to manage (e.g., copy or delete) data on media inserted in the TRITON Extreme’s CF card slot. (USB storage mode)

# About polyphony

## Tone generators and oscillators

Each oscillator in the TRITON Extreme is sounded by one of two Tone Generators.

Each tone generator is connected to the various PCM memories as shown in the diagram below.

### Tone Generator 1

- **ROM:** Internal PCM ROM (32 Mbytes)
- **RAM:** User sample memory (16 Mbytes, expandable to a maximum of 96 Mbytes)

### Tone Generator 2

- **Piano:**
  - **New1:**
  - **New2:**
  - **Best:**
  - **OrchS:**
  - **OrchB:**
  - **Vint:**
  - **Synth:**
- Internal PCM ROM (128 Mbytes)

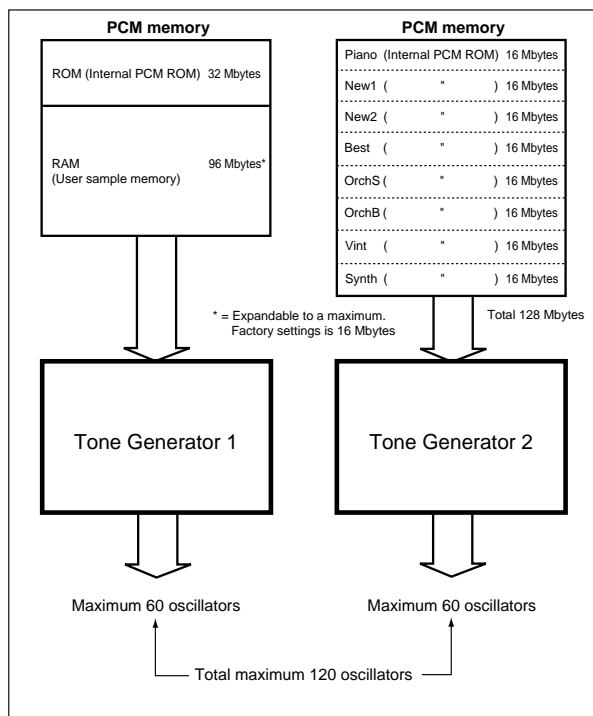

Each tone generator is able to simultaneously sound up to 60 oscillators (i.e., to play the PCM data connected to that tone generator). Together, the two tone generators are able to sound up to 120 oscillators.

For example up to 60 oscillators can use the **ROM**, and up to 60 oscillators can use the **Piano**, making a total of 120 oscillators. However, you can't play 61 or more oscillators from the **ROM** alone.

## Number of voices in each mode

The maximum number of voices that can be played simultaneously will depend on the oscillator mode of the program.

- For a **Single/Drum**-mode program, 1 oscillator = 1 voice
- For a **Double**-mode program, 2 oscillators = 1 voice

### Program mode

#### Single/Drums ("Oscillator Mode")

Normally, 60 voices can be used.

However a maximum of 120 voices will be available if, for example, ROM or RAM is used for the High MS, and Piano-Synth is used for the Low MS, and you use velocity switching to play the two tone generators.

#### Double ("Oscillator Mode")

Normally, 30 voices can be used.

However if OSC1 is sounded by one tone generator and OSC2 is sounded by the other tone generator (e.g., OSC1=ROM, OSC2=Piano-Synth), a maximum of 60 voices can be used. If OSC1 and OSC2 use one tone generator (e.g., OSC1=ROM, OSC2=ROM), then a maximum of 30 voices can be used.

This can also be increased by velocity switch and velocity zone settings.

### Combination, Sequencer, and Song Play modes

Depending on the oscillator mode of the programs you are using, the maximum number will vary between 60 voices and 120 voices.

#### (Example)

For single-mode programs that use ROM or RAM, a total maximum of 60 voices

For single-mode programs that use Piano-Synth, a total maximum of 60 voices

Total 120 voices

For double-mode programs that use ROM or RAM, a total maximum of 30 voices

For double-mode programs that use Piano-Synth, a total maximum of 30 voices

Total 60 voices

### Sampling mode

Tone generator 1 is always used in Sampling mode.

#### Mono samples/multisamples

60 voices.

#### Stereo samples/multisamples

30 voices.



## Basic operation

### 1. Selecting modes

- In order to use a particular function on the TRITON Extreme, you must first select the appropriate mode. Press one of the front panel mode keys ([COMBI] key - [MEDIA] key) to enter the corresponding mode.

[COMBI] key:	Combination mode
[PROG] key:	Program mode
[SEQ] key:	Sequencer mode
[SAMPLING] key:	Sampling mode
[S.PLAY] key:	Song Play mode
[GLOBAL] key:	Global mode
[MEDIA] key:	Media mode

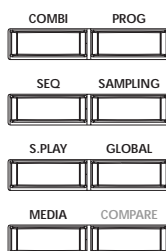

### 2. Selecting pages

Each mode has a large number of parameters, which are organized into pages. These are further subdivided by tabs into up to eight tab pages.

- ① Make sure that the desired mode is selected. To select a mode, press the appropriate mode key ([COMBI] key - [MEDIA] key). Here we will use Program mode as an example for our explanation. Press the [PROG] key.

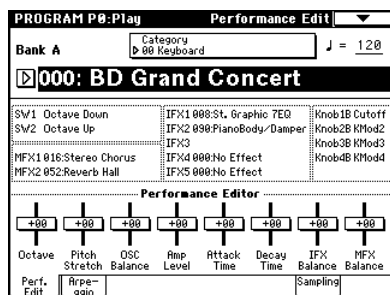

- ② Press the [MENU] key.



The page jump menu will appear.

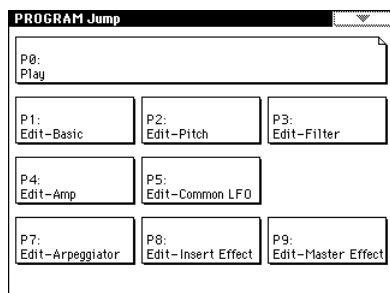

**note** In Media mode there is only one page, so the page jump menu will not appear.

- ③ In the LCD screen, press the desired page. You will jump to the selected page, and it will appear in the display. As an example here, press P1: Edit-Basic.
- As a reminder, the page that was selected before you pressed the [MENU] key will have its top right corner bent over.
  - You can also jump to the corresponding page by pressing a numeric key [0]–[9]. (P0–P9 correspond to numeric keys [0]–[9].)
  - By holding down the [MENU] key and pressing a numeric key [0]–[9], you can jump directly to the corresponding page without displaying the page jump menu.

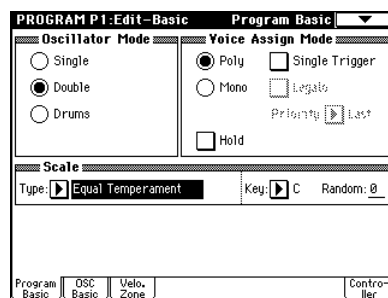

**note** When you press the [EXIT] key, you will return to P0 from any page.

- ④ Press one of the tabs located at the bottom of the page. As an example here, press the OSC Basic tab which is the second from the left.

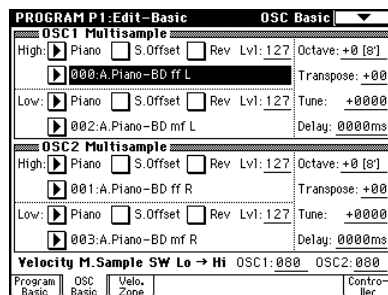

- Some pages have no tabs.
- ⑤ To move to a page with a different 'P' number, press the [MENU] key and continue from step ② of this procedure.

### 3. Setting a parameter

The parameter value in the edit cell can be set by using the front panel VALUE controllers ([VALUE] slider, [Δ] [▽] keys, [VALUE] dial, numeric keys [0]–[9], [-] key, [ENTER] key, and [./10's HOLD] key). As necessary, you can also use the [BANK] keys and the [COMPARE] key. For some parameters, the value can be set by pressing a popup button to display a parameter value, or by holding down the [ENTER] key and playing a note on the keyboard to input a note number or velocity value.

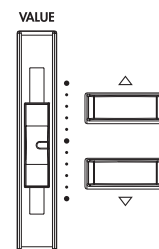

## VALUE controllers

### [VALUE] slider

Use this when you wish to make major changes in the value.

In Program mode and Combination mode, this slider can also be used as a control source for alternate modulation or dynamic modulation. (This is active in Program or Combination P0: Play when the “Program Select” or “Combination Select” (the large characters in the upper part of the LCD) is selected).

### [△][▽] keys

Use these when you wish to make small changes in the value.

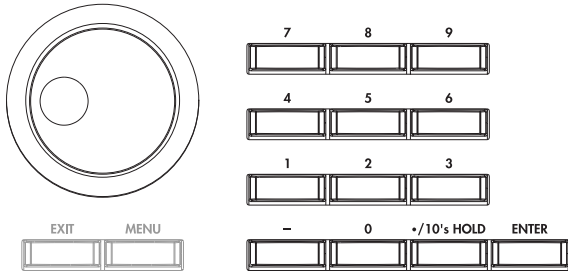

### [VALUE] dial

Use this when you wish to make large changes in a value.

### Numeric keys [0]–[9], [ENTER] key, [-] key, [./10's HOLD] key

Use these when you know the parameter value that you wish to input.

After using the numeric keys [0]–[9] to input a number, press the [ENTER] key to finalize the parameter value.

Use the [-] key to enter negative numbers.

Use the [./10's HOLD] key to enter a decimal point.

In Program and Combination mode P0: Play page other than the Sampling page, the [./10's HOLD] key performs the 10's Hold function. (☞p.21, 32)

### BANK [A]–[G], [H]–[N] keys

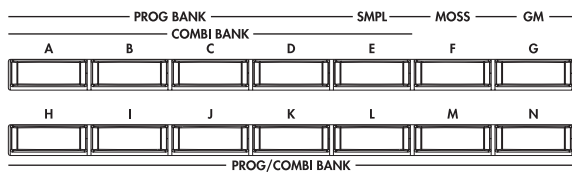

The BANK [A]–[G], [H]–[N] keys are used in Program mode to select the program bank and in Combination mode to select the combination bank. In combination, Sequencer and Song Play modes, these keys are used to select the bank of the program used by each timbre/track.

### [COMPARE] key



Use this key when you wish to compare the edits you have made to a program or combination's sound with the un-edited original (i.e., the sound that is written into memory).

When editing a **program** or **combination**, press this key. The LED will light, and the last-written settings for that program number or combination number will be recalled. When you press the [COMPARE] key once again, the LED will go dark and you will return to the settings that you were editing.

If you edit the settings that are recalled by pressing the [COMPARE] key (i.e., the settings that are written into memory), the LED will go dark, and it will not be possible to return to the previous edits by pressing the [COMPARE] key again.

In **Sequencer mode**, you can use the [COMPARE] key to make “before and after” comparisons immediately after using realtime recording or step recording to record a song, or after performing a track edit operation. For example, this can be used effectively when realtime-recording a track for a song.

- ① Realtime-record a MIDI track. (Take 1)
- ② Once again, realtime-record on the same track. (Take 2)
- ③ Press the [COMPARE] key. The LED will light, and take 1 will be recalled.
- ④ Press the [COMPARE] key once again. The LED will go dark, and take 2 will be recalled.
- ⑤ If at step ③ you once again realtime-record on the same track (take 3), the object of the Compare function will now be take 1. If at step ④ you once again realtime-record on the same track (take 3), the object of the Compare function will be take 2.

In this way, the Compare function lets you recall the previous recording or the previous state of event editing.

⚠ The Compare function is not available Sampling, Song Play, Global, or Media modes.

### Popup buttons and popup menus

You can press a popup button to access a popup menu, and then set parameter values (☞p.8).

### Keyboard input

When inputting a note number or a specific velocity as the value of a parameter, you can use the keyboard to input the setting. Hold down the [ENTER] key and play the note that you wish to enter as a value. The note number or velocity value will be input.

When the Global P5: Drum Kit page is displayed, you can hold down the [ENTER] key and play a note to recall the settings that have been assigned to that note.

In Sampling mode, you can hold down the [ENTER] key and play a note to recall the index that is assigned to that note.

# Setup

## Connections

**⚠** Connections must be made with the power turned off. Please be aware that careless operation may damage your speaker system or cause malfunctions.

### 3. Analog audio input connections



If a passive type guitar (a guitar without an internal preamp) is connected, it will not be possible to sample at an appropriate level due to the impedance mismatch. Such instruments must be connected via a preamp or effect unit.

Effect processor etc.

CD player, analog record player, etc.

AUDIO OUTPUT/AUX OUT etc.

Mic

### 5. Connecting pedals

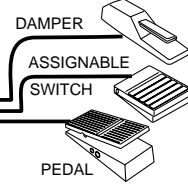

### 8. Connections to MIDI equipment/computers

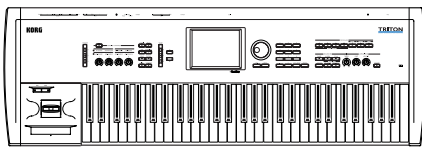

MIDI OUT

MIDI cable

MIDI IN



Power Switch

AC power supply

### 1. Connecting the power cable

Power cable (Included)

to an AC outlet

### 9. Installing options

Option EXB-MOSS  
SIMM

USB A B

S/P DIF OUT IN

AUDIO OUTPUT (INDIVIDUAL) (MAIN)

4 3 2 1 R L/MONO



CompactFlash  
Microdrive card

### 6. Inserting and removing CF card slot media



CD-R/RW, hard disk, removable disks etc.

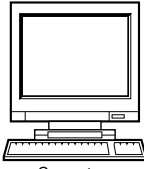

Computer

USB cable

DAT etc.

DIGITAL IN

DIGITAL OUT

### 4. Digital audio input/output connections

### 7. Connecting a USB device

### 2. Analog audio output connections

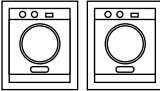

Powered monitors, etc.

Monitor OUTPUT

INPUT

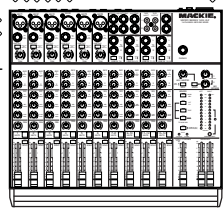

Mixer





PHONES

---

## 1. Connecting the power cable

- ① Turn off the power of the TRITON Extreme.
- ② Plug the included power cable into the AC power supply connector located on the back of the TRITON Extreme.
- ③ Connect the other end of the power cable to an AC outlet.

 Use only the power cable that is included with the TRITON Extreme. Using another power cable may cause malfunctions.

 Make sure that your AC outlet is the correct voltage for your instrument.

---

## 2. Analog audio output connections

Connect a set of amplified monitor speakers or your audio system to the TRITON Extreme.

 If you play back the TRITON Extreme through your stereo audio system, be aware that high volumes may damage your speakers. Be careful not to raise the volume excessively.

- Connecting the AUDIO OUTPUT (MAIN) L/MONO, R, (INDIVIDUAL) 1, 2, 3, and 4 jacks to the INPUT jacks of your mixer or powered monitor system.

L/MONO and R are the main outputs. If you are outputting in stereo, make your connections using the (MAIN) L/MONO jack and the R jack. If you are outputting in mono, make your connection to the (MAIN) L/MONO jack.

The (INDIVIDUAL) 1, 2, 3, and 4 jacks are used to output specific sounds independently. For example, you can use these to apply an external effect to the snare sound of a drum kit.

When you are sampling, and want to hear the sounds played by the TRITON Extreme's sequencer while you sample only the external audio source, send the source to (INDIVIDUAL) 1 and 2. If you want to monitor this sound, you can connect (INDIVIDUAL) 1 and 2 jacks to your mixer, and monitor the sound via your mixer.

### Headphones

- If you are using headphones, connect them to the headphone jack of the TRITON Extreme.

The TRITON Extreme's headphone jack will output the same signal as (MAIN) L/MONO and R.

 If you are using (INDIVIDUAL) 1, 2, 3, and 4, connect these jacks to your mixer, and use the headphone jack of your mixer to monitor the sound.

---

## 3. Analog audio input connections

You can input external analog audio sources, and sample them or process them with the internal effects and output them from the OUTPUT jacks.

- Connect mics or the OUTPUT jacks of your external audio equipment to the AUDIO INPUT 1 and 2 jacks.

---

## 4. Digital audio input/output connections

### Digital audio output

The same audio signal present at the TRITON Extreme's AUDIO OUTPUT (MAIN) L/MONO and R jacks can be output in digital format to a DAT, MD, or digital multi-track recorder that can accept a digital audio input with a sample frequency of 48 kHz.

- Use an optical cable to connect the S/P DIF OUT (MAIN) jack to the optical digital input jack of your DAT, MD, or digital multitrack recorder.

 The [VOLUME] slider does not affect the volume of this output jack.

### Digital audio input

TRITON Extreme can accept a digital audio input from a DAT or other digital device that can output digital audio at a sampling frequency of 48 kHz. This signal can be input to the L and R channels, then sampled or processed by the internal effects and output from the OUTPUT jacks.

- Use an optical cable to connect the optical digital output jacks of your DAT etc. to the S/P DIF IN jack.

---

## 5. Connecting pedals

### Foot pedal connections

A foot pedal can be used to control various synthesis and effect parameters.

Connect an optional expression pedal such as the Korg XVP-10 or EXP-2 to the rear panel ASSIGNABLE PEDAL jack.

The function controlled by the foot pedal is specified in Global: P2 "Foot Pedal Assign" (p.90, PG p.165, 282)

### Foot switch connections

A foot switch controls sostenuto, soft pedal on/off, arpeggiator on/off, to select programs or combinations, and to start/stop the sequencer and tap tempo etc.

Connect an optional foot switch such as the Korg PS-1 to the rear panel ASSIGNABLE SWITCH jack.

The function assigned to the foot switch and the polarity of the foot switch can be set in Global: P2 "Foot Switch Assign," and "Foot Switch Polarity" (p.90, PG p.165, 281)

### Damper pedal connections

This pedal applies a piano style damper effect as you play. Connect an optional footswitch to the DAMPER jack of the TRITON Extreme. If a Korg DS-1H is connected, half-damper effects can be produced.

The polarity of the pedal is set in Global P2: Controller "Damper Polarity" and the sensitivity is set in Global P0 "Half Damper Calibration." (PG p.157, 165)

## 6. Inserting and removing CF card slot media

You can insert a CompactFlash or Microdrive card into the CF card slot, and use it to save or load song data or sample data.

When using a Microdrive, you can save the sampled data directly to media.

**⚠** The TRITON Extreme's CF card slot does not support hot-plugging. You must turn off the power before inserting or removing CF card slot media. Turning off the TRITON Extreme to insert media into the CF slot will cause your unsaved sequence and sample data to be lost; so we suggest you always insert your media before you turn the TRITON Extreme on, in case you want to save any of the data you create.

### Inserting media

- ① **Turn off the power of the TRITON Extreme.**
- ② **Make sure that the CF card slot eject button located on the rear panel is pressed inward.**  
If the eject button is in the outward position, press it in.
- ③ **Insert your CompactFlash or Microdrive card into the CF card slot.**  
Make sure that the card is oriented correctly; the label should be upward, and the connector end inserted first.

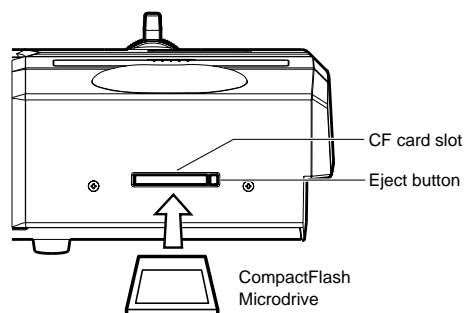

- ④ **Push the card in until the media is inserted all the way into the slot.**
- ⑤ **Turn on the power.**

**note** To verify that the media was recognized correctly, check that the Media mode "Media Select" display shows CF (CompactFlash) or MD (Microdrive). (p.119)

If the display indicates Unformatted, you will need to format the card. Newly purchased media or media that has been used by another device must also be formatted before you use it on the TRITON Extreme for the first time. For the formatting procedure, refer to p.119.

### Removing media

- ① **Turn off the power of the TRITON Extreme.**
- ② **Press the CF card slot eject button located on the rear panel, and pull the button outward.**
- ③ **Press the CF card slot eject button inward, and then pull the media out of the connector inside the slot.**
- ④ **Remove the media from the slot.**  
Store the media correctly as described in the instructions included with the media.

## 7. Connecting a USB device

You can connect an external USB device such as a hard disk or CD-R/RW drive to the USB A connector, and transfer data to and from the device.

- **Connect the TRITON Extreme's USB A connector to the USB connector of your external USB device.**

If you connect the TRITON Extreme's USB B connector to your computer, you will be able to transfer data to and from your computer. You can also send and receive MIDI data to/from your sequencer software or similar application.

- **Connect the TRITON Extreme's USB B connector to the USB connector of your computer.**

PG p.325 For details on connecting USB devices, refer to PG p.325.

## 8. Connections to MIDI equipment/computers

### Connections to MIDI equipment

The keyboard, controllers, and sequencer etc. of TRITON Extreme can be used to control an external MIDI tone generator. Conversely, another MIDI keyboard or sequencer can control the tone generator of TRITON Extreme to produce sound.

- **Use MIDI cables to connect the MIDI connectors of TRITON Extreme with the MIDI connectors of your external device.**

PG p.288 "MIDI applications – Connecting MIDI devices/computers"

### Connections to a computer

Your performance on the TRITON Extreme, as well as controller and sequencer data, can be sent to a computer (connected via MIDI interface), and the tone generator of TRITON Extreme can be played from the computer.

- **Use a MIDI interface to connect the MIDI connectors of TRITON Extreme to the MIDI connectors of your computer.**

- **Connect the TRITON Extreme's USB B connector to the USB connector of your computer.**

PG p.288 "MIDI applications – Connecting MIDI devices/computers"

**⚠** Some USB-MIDI interfaces may not be able to transmit or receive the TRITON Extreme's MIDI exclusive messages.

## 9. Installing options

The functionality of the TRITON Extreme can be extended by installing option boards and/or sample memory. The following two types of options can be installed. For details on installation, refer to PG p.319.

- EXB-MOSS (DSP synthesizer board)
- DRAM SIMM (Memory boards for sample data)

## Turning the power on/off

**⚠** Before you turn on the power, make sure that the desired connections have been made as described in “Connections” (p.15).

### 1. Turning the power on

① Press the rear panel [POWER] switch to turn on the power.

The LCD screen will display the name of your model, and the software version.

(The following graphic shows the factory-set LCD screen. The version number is subject to change without notice.)



② Turn on your powered monitors or stereo amp.

③ Raise the TRITON Extreme’s [VOLUME] slider to an appropriate level, and adjust the volume of your powered monitors or stereo amp.

**⚠** You must turn off the power before inserting media into the CF card slot. The TRITON Extreme’s CF card slot does not support hot-plugging.

### 2. Turning the power off

① Set the front panel [VOLUME] slider and the volume of your powered monitor or stereo amp to zero.

② Turn off the power of your powered monitor or stereo amp.

③ Press the TRITON Extreme’s [POWER] switch to turn off the power.

**⚠** Never turn off the power while data is being written into internal memory.

**⚠** If the power is turned off while processing is being performed, memory write operations will not be completed correctly. If this occurs, TRITON Extreme will automatically initialize its internal memory so that it will operate correctly. This is not a malfunction.

While data is being written, the LCD screen will indicate “Now writing into internal memory.” Data is written into internal memory by the following operations.

- Writing (updating) a Program, Combination, Global Setting, Drum Kits, or Arpeggio Patterns
- Loading Program, Combination, Global Setting, Drum Kit, or Arpeggio Patterns data in Media mode
- Receiving a MIDI data dump for Program, Combination, Global Setting, Drum Kit, or Arpeggio Patterns

- When using Sampling mode page menu commands (“Move Sample,” “Move MS,” “Convert To Program,” “Time Slice,” etc.) to simultaneously modify programs or drum kits.
- When sampling to RAM in Program, Combination, or Sequencer mode, if you simultaneously convert the sample to a program.

**⚠** Never turn off the power while the CompactFlash etc. media is being accessed. If you turn off the power while media is being accessed, the media may become unusable.

**note** You can set the “Power On Mode” (Global P0: System Preference page) so that the mode and page that had been selected when you turned the power off will appear when the power is turned on. (p.90)

### Information displayed in the LCD screen when various options or SIMM modules are installed

The TRITON Extreme allows you to install separately sold options or sample memory (RAM) boards.

When the power is turned on, the type of installed options will be displayed. After installing an option, be sure to check this display to verify that the option was installed correctly. If the option is not displayed here even though it was installed, it was not installed correctly. Turn off the power and re-install the option. (For details on installing an option, refer to PG p.319)

OPTIONS  
EXB – MOSS

SIMM  
Slot1 (16MB)  
Slot2 (32MB)  
Slot3 ----

#### OPTIONS

**EXB-MOSS:** The EXB-MOSS option is installed.

#### SIMM

**Slot 1...3 (\*\* MB):** Sample memory (RAM)’s are installed in SIMM slots 1–2. The capacity of each SIMM is shown in parentheses. When shipped from the factory, a 16 MB SIMM is installed in SIMM slot 1.

# Playing and editing programs

(Program Mode)

## Program structure

When the TRITON Extreme is shipped from the factory, it contains 1,344 programs (excluding the GM2 variation programs). You can create your own original programs by editing these factory-set programs, or by initializing a program and starting “from scratch.” You can also create programs using RAM multisamples that you have sampled or loaded in Media mode. In addition, you can play a program and resample your performance, or sample an external audio source while listening to the sound of a program.

Each of the rewritable banks A–E and H–N contain 128 programs (total 1,536). There are also non-rewritable bank G (GM2 capital programs), banks g(1)–g(9) (variation programs), and bank g(d) (drums). When shipped, banks A–D and H–N contain preloaded programs.

Program banks

Bank	Prog. No.	Explanation
A...D, H...M	000...127	Preloaded programs
E	000...127	User (initial) programs
F	000...127	MOSS programs
G	001...128	GM2 capital programs
g(1)...g(9)	(VNL)	GM2 variation programs
g(d)	(VNL)	GM2 drum programs
N	000...127	Preloaded programs, user (initial) programs

For details on the factory-set programs, refer to “VNL.”

You can select programs from bank F only if the EXB-MOSS option is installed.

P0: Play is where you select and play programs, make simple adjustments using the Performance Editor, and adjust the arpeggiator settings.

In the P1: Edit-Basic–P9: Edit-Master Effect pages you can modify the sound by editing the various parameters of the program you selected in P0: Play.

Program mode page structure

Page	Explanation
P0: Play	Select programs, use the Performance Editor to perform easy editing, select and make settings for arpeggio patterns, make settings for sampling.
P1: Edit-Basic	Set basic program parameters such as oscillator and multisample. Set scale and controllers.
P2: Edit-Pitch	Settings related to the pitch, including the pitch EG.
P3: Edit-Filter	Settings related to the filter (tone), including the filter EG.
P4: Edit-Amp	Settings related to the amplifier (volume), including amp EG and pan.
P5: Edit-Common LFO	For each of the two LFO's provided for each oscillator, select the LFO type and speed, etc. (Settings in the pitch, filter, and amp pages will determine how deeply the LFO that you specify here is applied.)
P6:	---
P7: Edit-Arpeggiator	Settings for the arpeggiator. (Some of these are shared with the arpeggiator settings of P0, and you may edit them in either location.)
P8: Edit-Insert Effect	Select insert effects and make settings for them. Specify the oscillator routing (send levels to the insert effects, master effects, and independent outputs), make settings for Valve Force.
P9: Edit-Master Effect	Select master effects and make settings for them. Make settings for the master EQ and Valve Force.

**note** For details on how to access each mode and page, refer to “Basic operation” (p.13).

**note** Bank F is available only if the EXB-MOSS option is installed. The page structure and parameter structure of bank F programs are different than for the programs of other banks. Refer to the EXB-MOSS owner's manual.

**MIDI** All transmission and reception of MIDI data in Program mode is performed on the global MIDI channel. The global MIDI channel is set in Global P1: MIDI “MIDI Channel.”

**note** You can perform sampling/resampling in Program mode (p.80, QS p.22). You can also apply the TRITON Extreme's effects to an external audio input, for a wide range of possibilities. (p.107, 111)

Program structure and corresponding pages

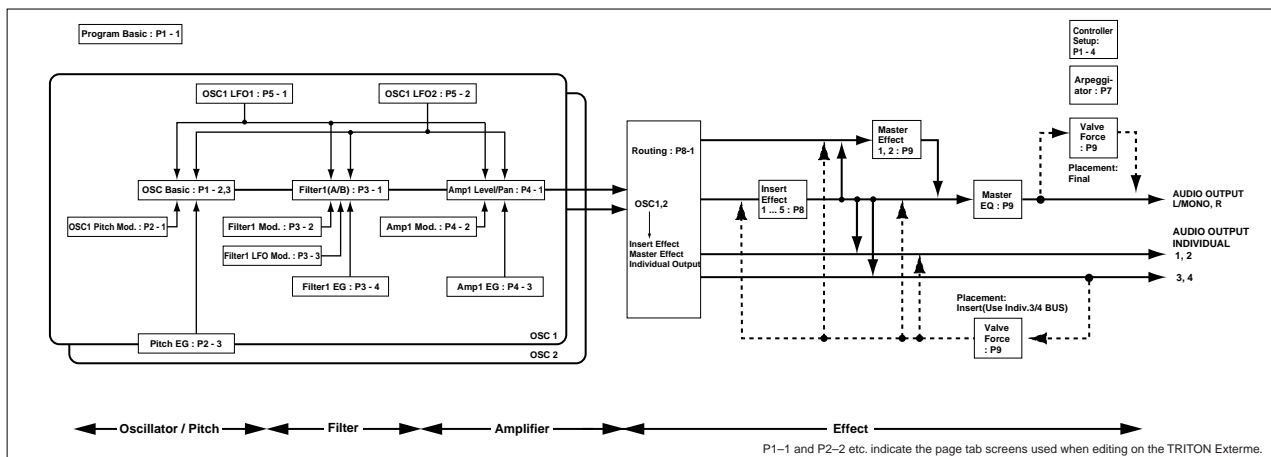

## Playing a program PO: Play

Here you can select and play programs. You can use the Performance Editor to make simple edits, and also make settings for the arpeggiator, external audio input, and sampling.

### Selecting a program

There are three ways to select a program. For the procedure, refer to the appropriate page.

- **Using the controls of the TRITON Extreme**
  - Selecting by bank/program number
  - Selecting by program category
  - Selecting by using 10's Hold
- **Using a connected switch**
- **Receiving MIDI program change messages**

### Selecting a program on the TRITON Extreme

Selecting by bank/program number

- 1 **Make sure that "Program Select" is selected.**  
If it is not selected, access the PROGRAM P0: Play page and press the "Program Select" area to highlight it.

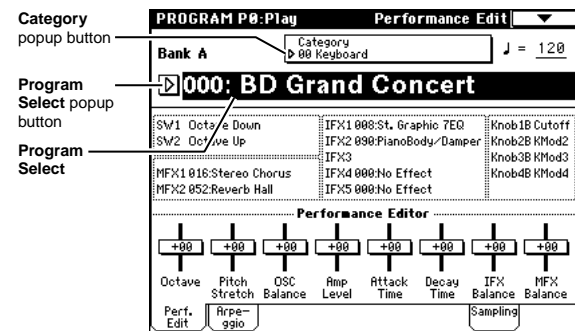

- 2 **Use the VALUE controllers to select the program number that you wish to play.**  
You can use the following methods to select a program.
  - Turn the [VALUE] dial.
  - Press the [ $\Delta$ ] or [ $\nabla$ ] key.
  - Use numeric keys [0]–[9] to specify the number, and press the [ENTER] key.

- 3 **Press a BANK [A]–[N] key to switch banks.**  
By switching banks you can access programs in different banks. (The key will light, and the selected bank will appear in the left side of the LCD screen.)  
For example to select bank B, press the BANK [B] key. (The [B] key will light, and an indication of Bank B will appear in the upper left of the LCD screen.)

**note** The [F] key is only available if the EXB-MOSS option is installed.

**note** Each time the [G] key is pressed, it will advance to the next GM bank in the following order:  
G→g(1)→g(2)→g(3)→g(4)→(5)→g(6)→g(7)→g(8)→g(9)→g(d)→G ... (The LED will light, and an indication of Bank G, g(1)–g(9), or g(d) will appear in the upper left of the LCD screen.)

### Selecting by bank

You can select programs from a list organized by program bank.

- 1 **Press the "Program Select" popup button.**  
A tabbed "Bank/Program Select" popup menu will appear.

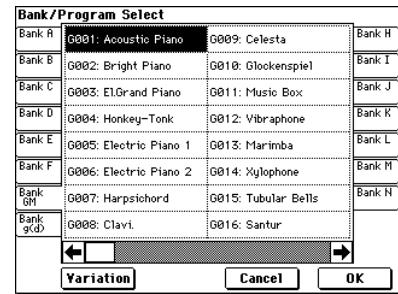

In the illustration above, bank G is selected. The center area shows the programs contained in that bank.

- note** The Variation button will be displayed only when bank G is selected. Each time you press this button, the bank will change in the following order:  
G→g(1)→g(2)...g(8)→g(9)→G...
- 2 **Press the tabs located to the left and right sides of the display to select a bank.**

- 3 **Press one of the program names in the center area to select a program.**  
The selected program will be highlighted.

- 4 **When you are satisfied with the selected program, press the OK button to close the popup menu.**  
If you press the Cancel button, the selection you made here will be discarded, and you will return to the program that had been selected before you opened the popup menu.

### Selecting by category

You can select programs from within a category, such as keyboard, organ, bass, and drums. When shipped from the factory, the preloaded programs are organized into sixteen categories.

- 1 **Press the Category popup button.**  
A tabbed "Category/Program Select" popup menu will appear.

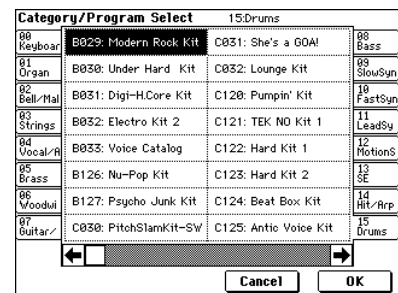

In the illustration above, category 15: Drums is selected. The center area shows the programs contained in that category.

- 2 **Press the tabs located to the left and right sides of the display to select a different category.**  
The name of the selected category will be displayed in full in the upper right.
- 3 **Press one of the program names in the center area to select a program.**  
The selected program will be highlighted.





- ④ When you are satisfied with the selected program, press the OK button to close the popup menu. If you press the Cancel button, your selection will be discarded, and you will return to the program that had been selected when you opened the popup menu.

#### Using 10's HOLD when selecting programs

If you press the [./10's HOLD] key to turn on the 10's Hold function (the LCD screen will indicate ) , the ten's place of the program number will be fixed, and you will be able to switch programs simply by pressing a single numeric key. Each time you press a numeric key, the one's place will change. You can also use the [△][▽] keys to change the value of the ten's place.

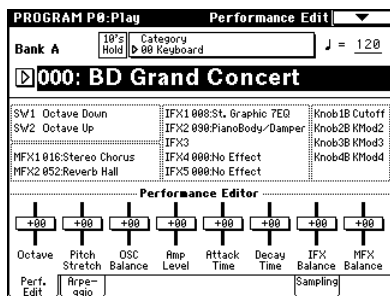
- ① Press the [./10's HOLD] key to make the display indicate  . The ten's place of the program number will be held (fixed).



- ② By pressing a numeric key [0]–[9], you can input the one's place in a single action.
- ③ You can use the [△][▽] keys to change the value of ten's place.
- ④ To cancel the 10's HOLD function, press [./10's HOLD] to erase the  display.

#### Using a footswitch to select programs

You can assign the Program Up/Down function to an on/off type foot switch (such as the optional PS-1) connected to the rear panel ASSIGNABLE SWITCH jack, and use it to switch combinations. (☞p.90)

#### Selecting programs from a MIDI device

MIDI program change messages can be transmitted from an external MIDI device, and received by TRITON Extreme to select programs. (☞PG p.290)

## Using controllers to modify the sound

The TRITON Extreme provides various controllers – a joystick, the ribbon controller, the SW1 and SW2 switches, and the REALTIME CONTROL [1], [2], [3], [4] knobs – that let you modify the tone, pitch, volume, or effects in realtime while you play.

You can use these controllers to modify the sound while you are playing a program.

### Joystick

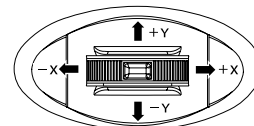

**JS(+X):** Move the joystick toward the right to apply an effect.

Normally this is used to control the pitch (bend up).

**JS(-X):** Move the joystick toward the left to apply an effect.

Normally this is used to control the pitch (bend down).

**JS(+Y):** Move the joystick away from yourself to apply an effect.

Normally this is used to control the oscillator LFO (vibrato).

**JS(-Y):** Move the joystick toward yourself to apply an effect.

Normally this is used to control filter LFO (wah).

**note** You can use the Lock function of [SW1] or [SW2] keys to hold the effect in the current position of the joystick. For the procedure, refer to “The lock function” on the following page.

**note** You can use the joystick as a source for alternate modulation or effect dynamic modulation, to control program parameters or effect parameters.

### Ribbon controller

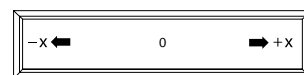

Move your finger to the left and right on the ribbon controller to apply an effect.

Normally, this is used to control pitch, volume or filter etc.

**note** You can use the Lock function of [SW1] or [SW2] keys to hold the effect even after you release your finger from the ribbon controller. For the procedure, refer to “The Lock function” on the following page.

**note** You can use the ribbon controller as a source for alternate modulation or effect dynamic modulation, to control program parameters or effect parameters.

### SW1, SW2

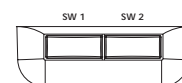

You can use these keys as sources for alternate modulation or effect dynamic modulation to control program parameters or effect parameters.

These switches can also be used to switch the octave, to turn portamento on/off, or to lock the position of the ribbon controller or after touch **lock function**.

You can specify the way in which the [SW1] and [SW2] keys will operate: either **Toggle**, when the assigned function will be switched between on and off each time the key is pressed, or **Momentary**, when the assigned function will be active on only as long as you hold down the switch.

**note** In Program mode, the function of the [SW1] and [SW2] keys can be checked in the P0: Play, Performance Edit page.

**note** When you write a program or combination, the on/off status of the [SW1] and [SW2] keys is saved.

**note** For details on making these settings, refer to “Setting the function of [SW1] and [SW2]” (p.129).

## Using the Lock function (examples)

### Joystick

- ① **Select program bank J001: Acoustic Piano, and play the keyboard.**  
To select a program, make sure that you are in Program mode, and press the BANK [J] key, numeric key [1], and then the [ENTER] key.
- ② **Move the joystick toward yourself (the -Y direction).**  
The modulation will deepen, and at the same time, resonance will be applied to give a unique character to the sound.
- ③ **While holding the joystick toward yourself, press the [SW2] switch (The [SW2] key will light).**  
The modulation effect at this point will be maintained. **(Lock function)**

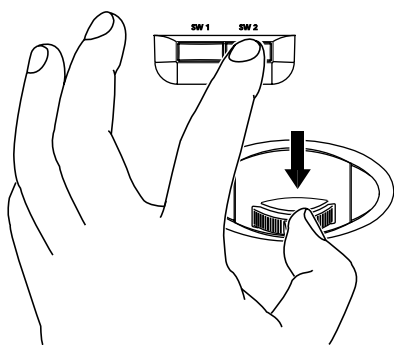

- ④ **Release the joystick, and play the keyboard.**  
The modulation will stay the same as it was when the [SW2] key was pressed. Moving the joystick toward yourself will not affect the sound.
- ⑤ **Press the [SW2] key once again to release the Lock function.**

### Ribbon controller

Make sure that the J001: Acoustic Piano program is selected.

- ① **Press the [SW2] key.** (The [SW2] key will light.)
- ② **Touch the ribbon controller, and move your finger to left and right.**  
Movement in the +X direction will brighten the tone, and movement in the -X direction will darken the tone.
- ③ **Take your finger away from the ribbon controller.**  
The sound will remain as it was before you removed your finger. **(Lock function)**
- ④ **Press the [SW2] key once again to release the Lock function.**

**note** In the LCD screen, SW2 indicates **JS-Y & Ribbon Lock**. This means that the [SW2] key is assigned to control the Lock function for the joystick -Y direction and the ribbon controller (p.279). The key will operate in **Toggle** mode.

If you move the joystick in the -Y direction, press the [SW2] key to turn on the Lock function, then operate the ribbon controller, and finally release both controllers, the sound you modified by the two controllers will be maintained.

**note** In many programs and combinations, the [SW2] key is assigned to control the Lock function for the joystick -Y direction and the ribbon controller.

**note** The Lock function can also be applied to aftertouch. If the [SW1] or [SW2] switch is assigned to **After Touch Lock**, the effect produced by pressing down on the keyboard can be held by turning on the [SW1] or [SW2] switch.

**note** For details on the [SW1] and [SW2] switch functions, refer to PG p.279.

## REALTIME CONTROLS [1], [2], [3], [4]

These knobs can be used to control the filter cutoff frequency and resonance, the amp and filter EG, volume, portamento time, pan, pitch LFO, or the send levels to the master effects, etc. You can also use these knobs to control the Valve Force parameters.

- ① **Press the [REALTIME CONTROLS] key to switch the function of the realtime controllers.**

Each time you press the key, A-mode, B-mode or Valve Force will be alternately selected, and the corresponding LED will light.

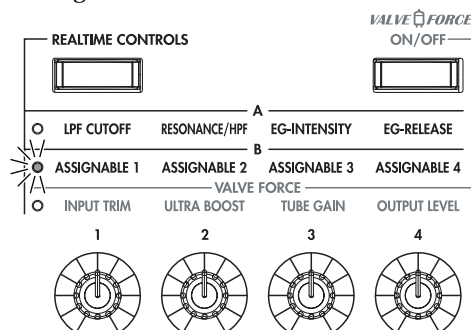

- ② **Rotate the desired knob to control the sound, etc.**

For details about what is controlled, refer to QS p.6.

### [VALUE] slider

When a program number is selected in Program P0: Play page, or when a combination number is selected in Combination mode page P0: Play page, you can use the [VALUE] slider as a source for alternate modulation or effect dynamic modulation, and control program parameters or effect parameters.

### Keyboard

#### Velocity

The force with which you initially strike a note can apply an effect.

Normally this is used to control volume, or the speed or sensitivity of the EG.

#### After Touch

This effect can be applied by varying the pressure on a key that is already being held down.

Normally this is used to control volume, tone (cutoff frequency), or LFO sensitivity etc.

### Note Number

Varying amounts of an effect will be applied depending on the position of the key on the keyboard.

Normally this is used to control volume, tone (cutoff frequency), LFO sensitivity, and EG sensitivity etc.

**note** This can be used as a source for alternate modulation or effect dynamic modulation, to control program parameters or effect parameters.

### Foot pedals/Switch

#### Damper Pedal

An optional switch-type damper pedal such as the Korg DS-1H can be connected to TRITON Extreme. If a DS-1H is connected, it will function as a half-damper pedal. The half-damper function cannot be controlled by other pedals.

#### Assignable Foot Switch

If an optional foot switch such as the Korg PS-1 is connected to the rear panel ASSIGNABLE SWITCH jack, an assigned function can be switched on/off using the foot switch.

The function of the foot switch is assigned in Global P2: Controller “Foot Switch Assign” (p.90).

#### Assignable Foot Pedal

An optional expression pedal such as the Korg EXP-2 foot controller or Korg XVP-10 EXP/VOL pedal can be connected to the rear panel ASSIGNABLE PEDAL jack, and used to apply an effect.

The function of the foot pedal is assigned in Global P2: Controller “Foot Pedal Assign” (p.90).

## Easy program editing

### Performance Edit (the Performance Edit tab)

You can use the eight Performance Editor sliders to make overall adjustments to the major parameters of Program P1–9.

For details on what is controlled, refer to QS p.6 or PG p.2.

### REALTIME CONTROLS [1], [2], [3], [4]

For details on what is controlled, refer to QS p.6.

## Easy arpeggiator editing

### Arpeggio tab

Here you can select the arpeggio pattern, and make real-time adjustments to the arpeggio parameters while you perform.

### ARPEGGIATOR [ON/OFF] key, [TEMPO] knob, [GATE] knob, [VELOCITY] knob

Use the ARPEGGIATOR [ON/OFF] key to turn the arpeggiator on/off.

The ARPEGGIATOR [TEMPO], [GATE], and [VELOCITY] knobs control the tempo, duration, and strength of the arpeggiated notes.

## Program editing

You can edit the preloaded programs (banks A–D, H–N) that the TRITON Extreme is shipped with, or you can start with an initialized program (banks E, N) to create an original program.

The P0: Play page lets you perform basic editing, but more detailed editing can be done in the P1: Edit-Basic–P9: Edit-Master Effect pages.

**!** If you wish to save an edited program into internal memory, be sure to Write the program. (p.114)  
You can write programs to the 1,536 program memory areas (internal memory) of banks A–E and H–N. You can also save and manage programs on various types of media. (p.117)

**note** The P1: Edit-Basic–P5: Edit Common LFO parameters are shared by oscillators 1 and 2, and can be copied using the page menu command “Copy Oscillator.” This command is useful when you want to set both oscillators to the same settings, or when you want to copy settings from a different program.

## The three elements of sound

Sound can be broken down into three elements: **pitch**, **tone**, and **volume**.

On TRITON Extreme, these elements correspond to the **Pitch**, **Filter**, and **Amplifier** settings of a program. In other words you would adjust the Pitch settings to modify the pitch, the Filter settings to modify the tone, and the Amplifier settings to modify the volume.

In **Oscillator** (**Oscillator**: P1: Edit-Basic settings) you select the waveform **multisample** that determines the basic sound, and specify its pitch. This sound is then modified by the **pitch** settings (**Pitch**: P2: Edit-Pitch), **filter** settings (**Filter**: P3: Edit-Filter), and **amp** settings (**Amplifier**: P4: Edit-Amp) to create the basic sound of the program.

This basic sound can then be modified further by using the **insert effects** (P8: Edit-Insert Effect settings), **master effects**, **master EQ**, and **Valve Force** (P9: Edit-Master Effect settings) to apply finishing touches.

When **arpeggiator** settings (P7: Edit-Arpeggiator.) and **controller** settings (P1: Edit: Basic, Control Setup) are added to this, the final result is called a “program.”

## The Compare function

When P1–P9 are selected, pressing the [COMPARE] key (the key will light) will recall the sound as it was written before you edited it.

Pressing [COMPARE] again (the light goes dark) returns you to the version you are editing.

If you edit while the [COMPARE] key is lit, the key will again go dark and your previous unsaved edits will be lost.

## Oscillator settings P1: Edit-Basic

Basic settings for the oscillator are made in the P1: Edit-Basic page. The TRITON Extreme provides two oscillators, and for each oscillator you can select a basic waveform (“multisample”) and set the pitch.

The multisamples provided by the TRITON Extreme include waveforms for musical instruments such as pianos, as well as special waveforms unique to synthesizers. Multisamples reproduce the complex overtone structure and frequency characteristics that allow us to identify a sound as being “piano-like” or “guitar-like” etc..

### Program Basic page

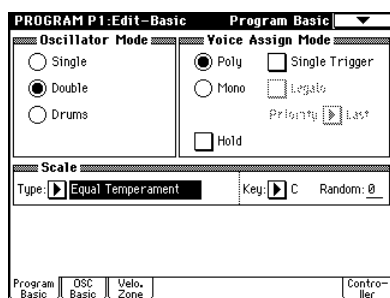

#### Oscillator Mode

This sets the mode of the oscillator. **Single** uses one oscillator and **Double** uses two oscillators. In the case of **Single** the maximum polyphony is **60 notes**, and in the case of **Double** the maximum polyphony is **30 notes**. If you wish to use a Drum Kit to create a drums program, select **Drums**. In the case of **Drums**, the polyphony is normally **60 notes**.

**note** Depending on the multisamples that are selected for each oscillator, the maximum polyphony can be up to **120 notes** for **Single**, up to **60 notes** for **Double**, and up to **120 notes** for **Drums**. (p.12)

#### Voice Assign Mode

Select whether the program will sound in **Poly** (polyphonically) or **Mono** (monophonically). If this is set to **Poly**, you will be able to play chords using the program. If this is set to **Mono**, only one note will sound even if you play a chord. Normally you will set this to **Poly**, but it is effective to use **Mono** when you are playing sounds such as a solo instrument, an analog-synth bass or a synth lead. Try switching between **Poly** and **Mono**, and listen to the results.

### OSC Basic page

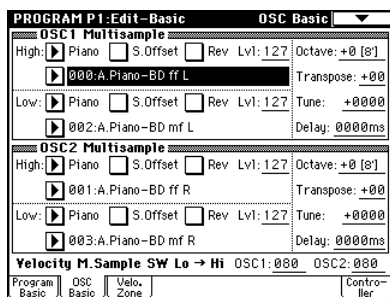

In this page you can select the multisample for each oscillator. The TRITON Extreme contains 962 different multisamples. (p.VNL)

Data sampled on the TRITON Extreme can also be used as a multisample.

#### Selecting a multisample

The multisample will determine the basic character of the program.

- Use “**High MS Bank**” to select the multisample bank, and use “**High Multisample**” to select the multisample.

You can select preset multisamples if “**High MS Bank**” is set to other than **RAM**.

If “**High MS Bank**” is **RAM**, you can select multisamples that were sampled on the TRITON Extreme or loaded in from media. Select from 000–999 for “**High multisample**.”

#### Multisample bank

MS Bank	Mbyte	No.	Explanation
ROM	32	000–424	TRITON Classic preset multisamples
RAM	96	000–999	RAM multisamples (created in Sampling mode or loaded in Media mode)
Piano	16	000–003	Preset multisamples for stereo piano
New1	16	000–007	Preset multisamples for stereo piano and choir
New2	16	000–048	Preset multisamples for organ, solo brass, electric guitar, acoustic guitar, electric bass, acoustic bass, etc.
Best	16	000–046	Preset multisamples for electric piano, clavi, brass, woodwinds, choir, drums, etc.
OrchS	16	000–112	Preset multisamples for orchestral strings
OrchB	16	000–079	Preset multisamples for orchestral brass, woodwinds, percussion, and harp etc.
Vint	16	000–157	Preset multisamples for vintage analog synths
Synth	16	000–077	Preset multisamples for house and trance music

**note** If “**High MS Bank**” is set to **ROM**, pressing the “**High Multisample**” popup button will display all internal **ROM** multisamples, organized into 15 categories. Use the tabs located at the left and right to select the desired category, and select a multisample from within that category.

#### High Multisample and Low Multisample

If you specify a *High* and *Low* multisample for an oscillator, either the *High* or the *Low* multisample will sound depending on the velocity of the note (i.e., the strength at which you play the keyboard). This function is called **velocity multisample switching**.

- ① Specify different multisamples for “**High Multisample**” and “**Low Multisample**.”
- ② Specify a velocity value for “**Velocity M.Sample SW Lo→Hi**.”

Notes played on the keyboard at a velocity less than the value you specify will sound the *Low* multisample; velocities at or above this velocity value will sound the *High* multisample.

For example if you set “**Velocity M.Sample SW Lo→Hi**” to 100, playing the keyboard softly will sound the “*Low* multisample,” and playing strongly will sound the “*High* multisample.”

③ Adjust the “Lvl” (Level) for *High* and *Low* multisamples to set their volume balance.

If you do not wish to use this function, set the “Velocity M.Sample SW Lo→Hi” value to **001**. Only the *High* multisample will sound.

**Rev (Reverse) check box**

If this is **checked**, the multisample will be played backward. This can produce interesting results when used on sound-effects, etc. Normally you will not check this.

● When “Oscillator Mode” = Double

To use OSC2, set “Oscillator Mode” to **Double** in the Program Basic page.

In the same way as for OSC1, you can set *High* and *Low* multisamples for OSC2.

The playback pitch can be set independently. By using the same multisample with slightly different “Tune” settings, you can “detune” the oscillators to produce a richer sound.

**note** It will be convenient to use the page menu command “Copy Oscillator” to make the oscillator settings match each other.

● When “Oscillator Mode” = Drums

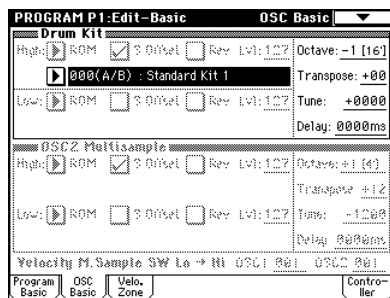

In the Program Basic page, set “Oscillator Mode” to **Drums**. When this is set to **Drums**, you will be able to create a drum program.

This will select a drum kit instead of a multisample. TRITON Extreme provides 50 factory preset drum kits that are suitable for a wide variety of music. (⌘VNL) Here you can only select a drum kit. To edit or create a drum kit, use Global P5: Drum Kit (⌘p.92).

The following multisamples or drum kits can be used for the oscillator.

- Preset multisamples (see the table on the preceding page)
- Multisamples that you sampled (RAM) (Programs can be created from multisamples/samples that you sampled in Sampling mode etc. or loaded from media in Media mode.)
- Nine internal drum kits (ROM)
- 144 user drum kits created in Global mode (Drum samples can be freely assigned to each key to create a drum kit. For the sound of each key, you can make filter and amp settings, and specify routing to the effects and to the individual audio outputs.)

Velocity Zone page

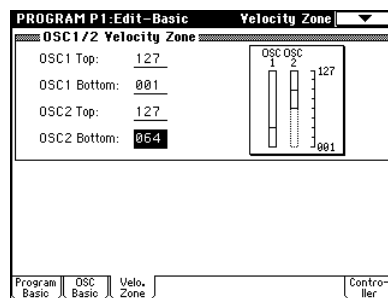

Here you can specify the range of velocities for each oscillator. In the example shown above, the velocity ranges are as follows.

- OSC1 will sound at all velocity values.
- OSC2 will sound only on strongly played notes (64 and above).
- You can use Velocity Multisample Switching in addition to this parameter (⌘“High Multisample, Low Multisample”). For this example, set “OSC1” in “Velocity M.Sample SW Lo→Hi” to **032** and “OSC2” to **096**. The settings are shown as vertical lines in the velocity zone display.

In this example, the multisamples will sound over four levels.

- Velocity values 001–031: sounds only the OSC1 Low multisample.
- Velocity values 032–063: sounds only the OSC1 High multisample.
- Velocity values 064–095: sounds the OSC1 High multisample and the OSC2 Low multisample.
- Velocity values 096–127: sounds the OSC1 High multisample and the OSC2 High multisample.

Controller Setup page

For each program, this tab lets you make settings for the [SW1] and [SW2] key, and for the B-mode of REALTIME CONTROLS knobs [1]–[4] (⌘p.129, PG p.14, 279, 280)

## Pitch settings

## P2: Edit-Pitch

Here you can specify how the pitch of the multisample assigned to each oscillator will change. Pitch EG and LFO settings allow the pitch to varied over time. The OSC1 P.Mod page is valid when “Oscillator Mode” is set to **Single** or **Drums**.

### OSC1 Pitch Mod. page

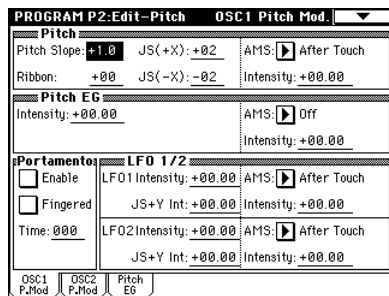

### Pitch

The “**JS (+X)**” and “**JS(-X)**” settings specify the amount of pitch change (in semitones) that will occur when MIDI pitch bend messages are received or when the joystick is moved to left or right. A setting of **+12** allows the pitch to be controlled a maximum of one octave upward; a setting of **-12** allows the pitch to be controlled a maximum of one octave downward.

“**Ribbon**” specifies the amount of pitch change (in semitones) that will occur when MIDI control change (CC) #16 messages are received or when the ribbon controller of a TRITON Extreme or other MIDI-connected instrument is moved to left or right. With a setting of **+12**, the pitch will be raised one octave at the far right of the ribbon controller, and will be lowered by one octave at the far left of the ribbon controller.

### Pitch EG

When the “**Intensity**” value is set to **+12.00**, the pitch EG specified in the Pitch EG page will produce a maximum of  $\pm 1$  octave of pitch change.

### Portamento

If “**Enable**” is **checked**, portamento will be applied. Portamento makes the pitch change smoothly when you play the next note before releasing the previous note. The “**Time**” parameter specifies the portamento time. As this value is increased, the pitch will change over a longer time. With a value of **000**, there will be no portamento.

**note** If **Porta.SW CC#65** is assigned as the function of [SW1] or [SW2] key, the portamento effect can be switched on/off by [SW1] or [SW2] key.

### LFO 1/2

An LFO can be used to cyclically modulate the pitch (a “**vibrato**” effect).

“**LFO 1/2 Intensity**” sets the depth to which the LFO specified in P5: Edit-Common LFO will affect the pitch. With a setting of **+12.00**, vibrato will produce a maximum of  $\pm 1$  octave of pitch change.

“**JS+Y Int**” specifies the amount of vibrato that the LFO will produce when the joystick is pushed away from yourself.

“**Intensity (AMS Intensity)**” specifies the depth of vibrato that will be applied by the LFO when an AMS (Alternate Modulation Source) is used. For example if “**AMS (LFO1 AMS)**” is set to **After Touch** and you set an appropriate value for “**Intensity (AMS Intensity)**,” vibrato will be applied when you apply pressure to the keyboard or when MIDI aftertouch messages are received.

### Pitch EG page

Here you can adjust the settings for the pitch EG.

When you wish to create sound effects etc., set the pitch EG to make major changes in pitch over time.

To realistically simulate the slight change in pitch that occurs when a string is plucked or at the attack of a brass or vocal sound, you can use the EG to create a subtle change in pitch at the attack (PG p.16).

### EG and LFO

By using an **EG** (envelope generator) to apply time-varying change or by using an **LFO** (Low Frequency Oscillator) to apply cyclic change to pitch, filter, or amp, you can create changes in the pitch, tone, or volume.

### EG (Envelope Generator)

TRITON Extreme provides a Pitch EG, Filter EG, and Amplifier EG, which produce time-varying changes in pitch, tone, and volume respectively.

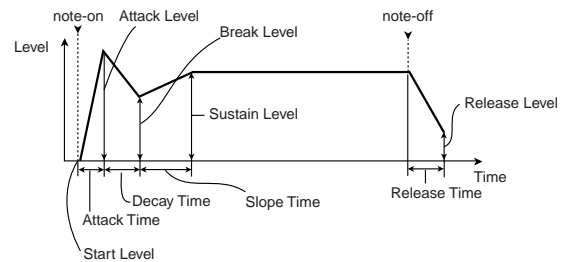

### LFO (Low Frequency Oscillator)

For each oscillator, TRITON Extreme provides two LFO's that can be used to apply cyclical change in pitch, tone, and volume.

Examples of this are vibrato (cyclical change in pitch), wah (cyclical change in tone), and tremolo or auto-pan (cyclical change in volume).

## Filter settings P3: Edit-Filter

The filter allows you to diminish or emphasize specified frequency areas of the multisample selected for the oscillator.

**The tone of the sound will depend significantly on the filter settings.**

TRITON Extreme provides Filter 1 for OSC1 and Filter 2 for OSC2. For each of these filters, you can select from two types (**Low Pass Resonance or Low Pass & High Pass**). Filter 2 can be used if “**Oscillator Mode**” is set to **Double**.

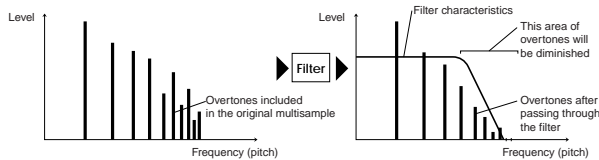

### Filter1 page

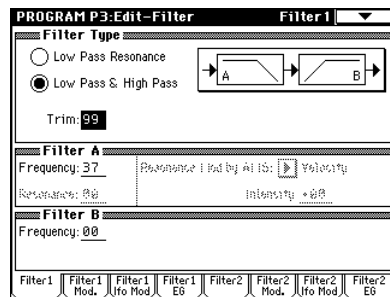

### Filter Type, Filter A, Filter B

Selects the type of filter, and specify the “**Frequency**” (cut-off frequency) and “**Resonance**” (resonance level).

- **Low Pass Resonance** (24 dB/oct low pass filter with resonance): Make settings for filter A.
- **Low Pass & High Pass** (12 dB/oct low pass filter and 12 dB/oct high pass filter in series connection): Make low pass filter settings in filter A, and high pass filter settings in filter B.

### ● Filter Type

#### Low pass filter

This is the most common type of filter, which allows the low frequency range to pass and cuts the high frequency range. When the overtones of the high range are cut, a bright sound will become darker (more mellow). 24 dB/oct and 12 dB/oct refer to the steepness of the cut. 24 dB/oct means that the gain will decrease 24 dB in one octave (i.e., as the frequency doubles). A 12 dB/oct filter would decrease the gain 12 dB in one octave. The 24 dB/oct filter produces a steeper cut.

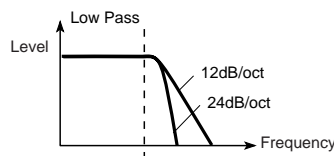

### High pass filter

This type of filter allows the high frequency range to pass and cuts the low frequency range. Use this when you wish to make the sound thinner. However if the cutoff frequency (Frequency) is raised excessively high, the volume will become very low.

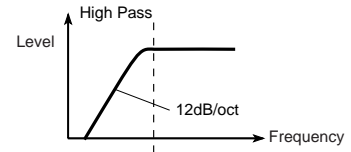

### Resonance

When “**Resonance**” is set to a higher value, the overtones in the region of the cutoff frequency will be boosted as shown in the diagram below, giving a distinctive character to the sound.

When resonance is applied

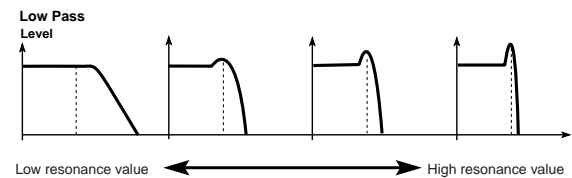

### Filter1 Mod. page

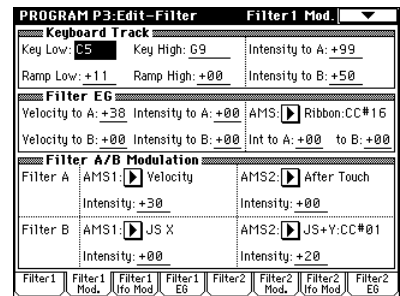

Controllers and the filter EG can be used to modulate the filter cutoff frequency that was specified in the Filter1 page. By using a controller to vary the tone or by using an EG to create time-varying changes, you can add a rich variety of tonal change to the sound.

### Keyboard Track

This varies the cutoff frequency according to the position of the key on the keyboard that you play.

- When “**Ramp Low**” is set to a positive (+) value, the cutoff frequency will rise as you play lower on the keyboard, making the sound brighter. When set to a negative (-) value, the cutoff frequency will fall as you play lower on the keyboard, making the sound darker.
- When “**Ramp High**” is set to a positive (+) value, the cutoff frequency will rise as you play higher on the keyboard, making the sound brighter. When set to a negative (-) value, the cutoff frequency will fall as you play higher on the keyboard, making the sound darker.
- “**Intensity to A**” and “**Intensity to B**” adjust the effect that keyboard tracking will have on filters A and B (PG p.18).

## Filter EG

Adjusts the effect produced by the filter EG, whose settings are made in the EG page.

- Use the “**Velocity to A**” and “**Velocity to B**” settings to specify the effect of velocity on the filter EG.
- Use the “**Intensity to A**” and “**Intensity to B**” settings to specify the depth of the filter EG.
- “**Into A (AMS Int. to A)**” and “**Into B (AMS Int. to B)**” adjust the effect that AMS will have on the filter EG depth.  
These three settings will determine the depth of the tonal change produced by the filter EG.

## Filter A/B Modulation

Set this when you wish to produce tonal change by using controllers etc. to vary the cutoff frequency.

## Filter1 LFO Mod. page

Indicates settings that allow the LFO to produce cyclic changes in tone (a “wah” effect).

“**Intensity to A (LFO Int. to A)**” and “**Intensity to B (LFO Int. to B)**” specify by how much the LFO will change the tone.

“**JS-Y Intensity to A**” and “**JS-Y Intensity to B**” specify the depth of the wah effect that will be produced by the LFO when the joystick of TRITON Extreme is moved toward yourself, or when CC#2 is received.

“**Intensity to A (LFO1 AMS Int.to A)**” and “**Intensity to B (LFO1 AMS Int. to B)**” specify the depth of the wah effect that will be produced by the LFO when “**AMS (LFO1 AMS)**” is used. For example if “**AMS (LFO1 AMS)**” is set to **After Touch**, applying pressure to the keyboard of the TRITON Extreme, will produce a wah effect.

## Filter1 EG page

Indicates settings for the filter EG, which controls time-variant changes in tone. Make settings for the EG here, and set the depth of its effect in the Filter1 Mod. page *Filter EG* parameter (PG p.20).

### ● Filter EG and Amplifier EG

When the Filter EG changes the cutoff frequency, the tone will change. However depending on the volume changes produced by the Amplifier EG, this can be heard in different ways. For example by changing the speed at which the tone and volume begin (attack) or decay, you can significantly vary the character of the tonal change. It is a good idea to adjust the changes of both the Filter EG (tone) and the Amplifier EG (volume) as you proceed with editing. (PG “Amp1 EG page”)

## Amplifier settings P4: Edit-Amp

These settings affect the volume. Here you can adjust the way in which the Amp EG and LFO produce time-varying and cyclic changes in volume, and how the controllers etc. will affect the volume.

Amp1 applies to OSC1, and Amp2 applies to OSC2. Amp2 can be used if “**Oscillator Mode**” is set to **Double**.

For example, the volume of a piano note begins at a high volume the instant you play the note, and then decreases gradually. The volume of an organ note remains constant as long as you continue pressing the key. The volume of a note on a violin or wind instrument can be varied during the note by the musician (i.e., by regulating the amount of pressure on the bow or the force of the breath).

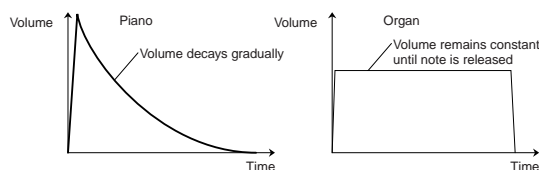

## Amp1 Level/Pan page

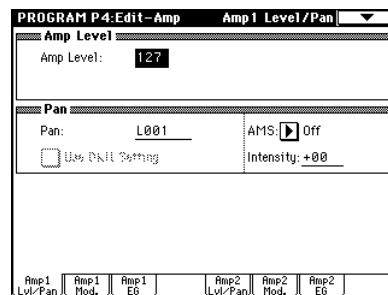

### Amp Level

Adjusts the volume of the sound that has passed through the oscillator, filter, and amp.

### Pan

Specifies the pan (stereo position) after the signal has passed through the oscillator, filter, and amp. Normally you will set this to **C064**. If “**Oscillator Mode**” is **Double** and you wish to create a sense of stereo, set the Amp1 Level/Pan page and Amp2 Level/Pan page parameter “**Pan**” to left and right for oscillators 1 and 2 respectively. With a setting of **Random**, the pan will change randomly each time you play a note on TRITON Extreme, producing an interesting effect.

### AMS (Pan AMS), Intensity

“**Intensity**” specifies the depth of the panning effect that will occur when “**AMS (Pan AMS)**” is in use.

If you set “**AMS (Pan AMS)**” to **Note Number**, the pan will change according to the keyboard position at which you play a note on a TRITON Extreme. With a setting of **LFO1** or **2**, the sound will sweep from side to side (auto pan). Other settings allow you to move the oscillator pan by operating a controller.

### Use DKit Setting

This is valid when “**Oscillator Mode**” is set to **Drums**. If this is **checked**, the pan location specified by the Drum Kit for each drum sound will be used. If this is **unchecked**, all drum sounds will sound at the same location. Preload and GM drum kits are set to stereo settings. Normally you will leave this checked.



## Amp1 Mod. page

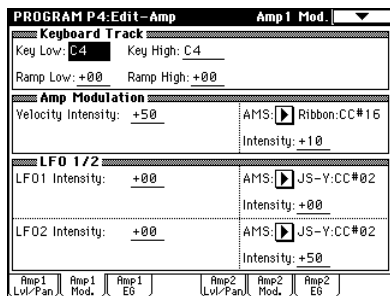

### Keyboard Track

This lets you vary the volume relative to the position of the key you are playing on the keyboard.

- When “**Ramp Low**” has a positive (+) value, the volume will increase as you play lower on the keyboard. With a negative (-) value, the volume will decrease as you play lower on the keyboard.
- When “**Ramp High**” has a positive (+) value, the volume will increase as you play higher on the keyboard. With a negative (-) value, the volume will decrease as you play higher on the keyboard.

### Amp Modulation

“**Velocity Intensity**” is used by most programs to decrease the volume of softly played notes and increase the volume of strongly played notes, and the Amp Modulation parameter adjusts the depth of this control. Normally you will set Amp Modulation to positive (+) values. As this setting is increased, there will be greater volume difference between softly played and strongly played notes.

### LFO1/2

Specifies how the LFO’s will produce cyclic changes in volume (tremolo effect).

The volume will be affected by the LFO(s) for which you set an “**LFO1 Intensity**”, “**LFO2 Intensity**” value.

“**Intensity (AMS Intensity)**” adjusts the depth by which the tremolo effect produced by the LFO will be affected when you assign an “**AMS (LFO1 AMS, LFO2 AMS)**.” For example if you set “**AMS**” to **JS-Y: #02**, tremolo will be applied when you move the joystick of TRITON Extreme toward yourself, or when CC#02 is received.

## Amp1 EG page

Here you can make settings for the amp EG, which changes the volume over time.

Every instrument has its own characteristic curve of volume change. This is part of what gives each instrument its identifiable character. Conversely, by applying a strings-type Amp EG curve to an organ-type multisample, you can produce a sound with a character unlike a typical organ.

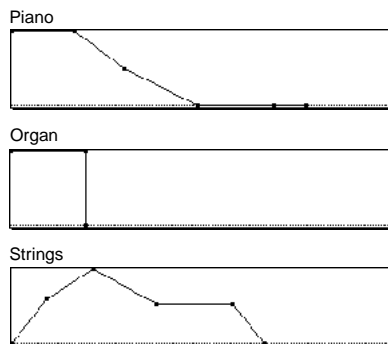

## LFO settings

### P5: Edit-Common LFO

For each oscillator, you can use two LFO (Low Frequency Oscillator) units: LFO1 and LFO2. You are free to select the type of each LFO and set its speed.

The depth of the LFO1 and LFO2 that you specify here is adjusted by the settings of the P2: Edit-Pitch, P3: Edit-Filter and P4: Edit-Amp pages.

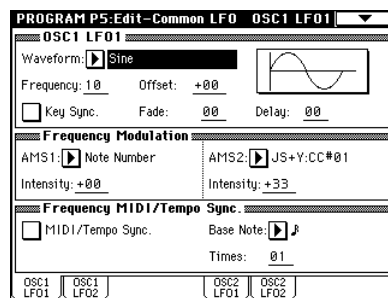

### OSC1 LFO1, OSC1 LFO2, OSC2 LFO1, OSC2 LFO2

“**Waveform**” selects the type of LFO. You can choose from a variety of waveforms, including standard waveforms such as **Triangle**, **Saw**, **Square**, and **Sine**, as well as **Step** or **Random PG** waveforms that produce a sample-and-hold effect (see PG p.26).

You can create a wide variety of effects by adjusting the “**Offset**,” “**Fade**,” and “**Delay**” settings, and by changing the sign (+/-) of the “**Intensity**” setting in the P2: Edit-Pitch, P3: Edit-Filter and P4: Edit-Amp pages. “**Frequency**” specifies the speed of the LFO.

### Frequency Modulation

“**AMS**” can be used to vary the LFO speed. This lets you change the LFO speed by operating a controller, or by the EG or Keyboard Track settings.

### Frequency MIDI/Tempo Sync.

If “**MIDI/Tempo Sync**” is checked, the “**Frequency**” setting will be ignored, and the LFO will synchronize to the tempo of the sequencer and arpeggiator. This lets you produce vibrato, wah, auto-pan, or tremolo effects that remain synchronized to the playback speed of the sequencer or arpeggiator, even if you adjust this playback speed.

---

.....

## Arpeggiator settings

### P7: Edit-Arpeggiator

Here you can make arpeggiator settings (p.94).

.....

## Insert Effect settings

### P8: Edit-Insert Effect

Here you can select insert effects and make settings for them. You can also specify the oscillator routing (the signal sent to the insert effects, master effects, and independent outputs) (p.104).

.....

## Master Effect and Valve Force settings

### P9: Edit-Master Effect

Here you can select master effects and make settings for them. The master EQ is also set here (p.105, 109).

.....

## More about Alternate Modulation

**Alternate Modulation** is a type of modulation that can be used to control various aspects of the sound.

**AMS (Alternate Modulation Source)** refers to any of the numerous sources that can provide alternate modulation, and includes controllers that you operate physically such as the joystick and realtime controllers, incoming MIDI data, as well as modulators such as the EG or LFO.

Since TRITON Extreme allows you to apply modulation to a modulator, this type of control is referred to as “alternate modulation.”

**Intensity** is a parameter that sets the degree (speed or depth) to which AMS will control alternate modulation.

Combinations of modulations that are frequently used in synthesizer performance (such as using the joystick to vary the pitch) are also provided as special parameters separate from alternate modulation.

TRITON Extreme provides 29 types of alternate modulation.

In single mode you can use 29 alternate modulation destinations of 29 types, and in double mode you can use 55 alternate modulation destinations of 29 types.

There are 42 AMS sources. (However depending on the type of modulation, some sources cannot be selected.)

For details on alternate modulation and AMS, refer to PG p.271.

---

## Suggestions on using alternate modulation

When making settings for alternate modulation, think of the effect that you wish to produce, what type of modulation will be necessary to produce that effect, and what parameter of the oscillator, filter, or amplifier needs to be controlled. Then select a source (“AMS”) and set the “**Intensity**.” If you proceed logically in this way, you will achieve the desired effect.

For example if you want to “control a guitar-like sound so that it appears to be approaching feedback when the joystick is moved away,” you will make settings so that the joystick controls filter modulation or the resonance level.

.....

## Auto Song Setup function

This function automatically applies the settings of the current program to a song.

If inspiration for a phrase or song strikes you while you’re playing a program or combination, you can use this function to start recording immediately.

Hold down the [ENTER] key and press the SEQUENCER [REC/WRITE] key. The “Setup to Record” dialog box will open and ask “Are you sure?”. Press “OK”. You will automatically enter Sequencer mode, and will be in the record-ready state. Press the [START/STOP] key to start the sequencer and begin recording.

# Playing and editing combinations

## (Combination Mode)

### Combination structure

When the TRITON Extreme is shipped from the factory, it contains 1,280 combinations. You can create your own original combinations by editing these factory-set combinations, or by initializing a combination and starting “from scratch.”

You can play a combination and resample your performance, or sample an external audio source while listening to the sound of a combination.

Each of the rewritable banks A–E and H–N contain 128 combinations (total 1,536). When shipped, banks A–D and H–M contain preloaded combinations.

Combination banks

Bank	Combi. No.	Explanation
A...D, H...M	000...127	Preloaded combinations
E	000...127	User (initial) combinations EXB-MOSS combinations
N	000...127	User (initial) combinations

For details on the factory-set combinations, refer to “VNL.”

P0: Play is where you select and play combinations. Here you can also make changes to the contents of each timbre, adjust the volume and pan, and make simple adjustments to the arpeggiator settings.

In the P1: Edit-Prog./Mixer–P9: Edit-Master FX pages you can modify the sound by editing the various parameters of the combination you selected in P0: Play.

Combination mode page structure

Page	Explanation
P0: Play	Select a combination; select a program for each timbre; set the status, pan, and level; select and set the arpeggio pattern, make settings for sampling.
P1: Edit-program/ Mixer	Select a program for each timbre, and set pan and level. (These are common to the parameters in P0, and can be edited from either page.)
P2: Edit-Trk Param	Set various parameters for each timbre, such as MIDI, OSC, Pitch etc.
P3: Edit-MIDI Filter	MIDI transmission/reception filter settings for each timbre.
P4: Edit-Zone/Ctrl	Key zone and velocity zone settings for each timbre. Make controller settings. If the separately sold EXB-MOSS option is installed, set related parameters.
P5:	---
P6:	---
P7: Edit- Arpeggiator	Arpeggiator settings. (These are common to the parameters in P0, and can be edited from either page.)
P8: Edit-Insert FX	Select insertion effects and make settings. Specify the timbre routing (send levels to the insertion effects, master effects, and independent outputs).
P9: Edit-Master FX	Select master effects and make settings. Make settings for the master EQ and Valve Force.

For details on how to access each mode and page, refer to “Basic operation” (p.13).

If the EXB-MOSS option is installed, bank F programs will be available for you to select as a timbre in the combination. For details on the parameters of bank F programs, refer to the EXB-MOSS owner’s manual.

You can perform sampling/resampling in Combination mode (p.80). You can also apply the TRITON Extreme’s effects to an external audio input, for a wide range of possibilities. (p.107, 111)

Combination structure and corresponding pages

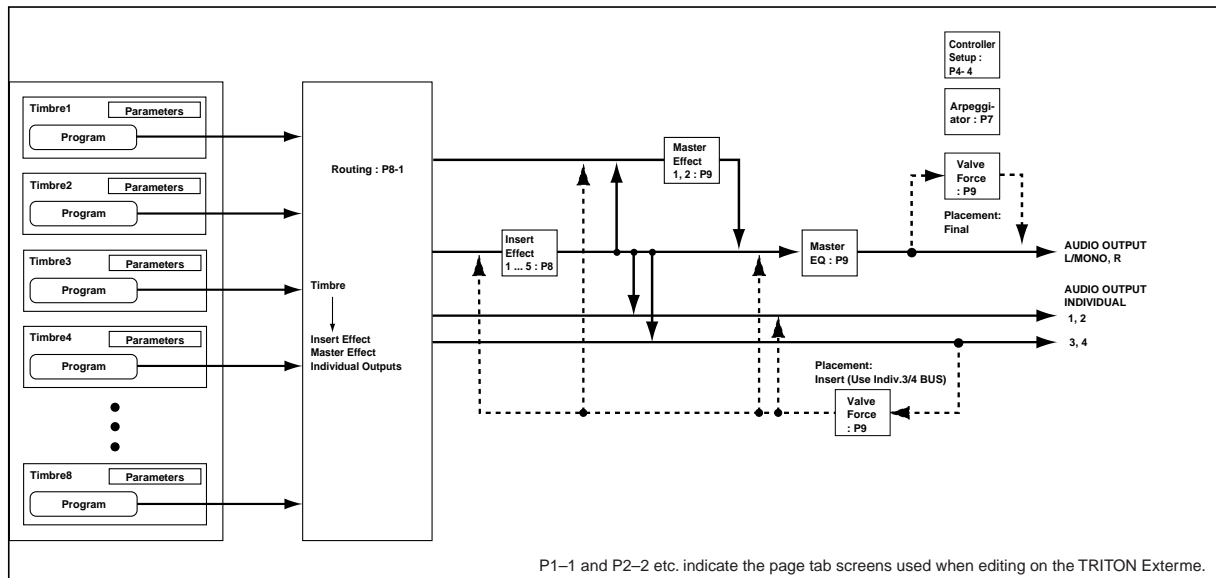

P1-1 and P2-2 etc. indicate the page tab screens used when editing on the TRITON Extreme.

## Playing a combination PO: Play

Here you can select and play combinations. You can select the program for each timbre 1–8 and set its status, pan, and level. You can also make settings for the arpeggiator, external audio input, and sampling.

### Selecting a combination

You can select a combination in any of the following three ways.

- **From the TRITON Extreme**  
Selecting by bank/combination number  
Selecting by combination category  
Selecting by using 10's Hold
- **From a connected foot switch**
- **By receiving MIDI program changes**

### Selecting a combination on the TRITON Extreme

Selecting by bank/combination number

- ① **Make sure that “Combination Select” is selected.**  
If it is not, select the COMBINATION P0: Play page and press “Combination Select” to highlight it.

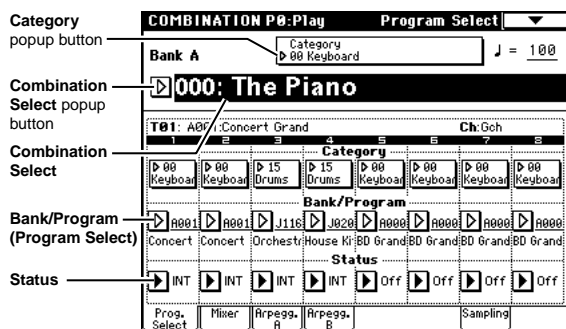

- ② **Use the VALUE controllers to select the combination number that you want to play.**  
You can use any of the following methods.
  - Turn the [VALUE] dial.
  - Use the [△][▽] keys.
  - Use numeric keys [0]–[9] to specify a number, and press the [ENTER] key.
- ③ **Press a BANK [A]–[E] or [H]–[N] key to select a bank.**  
By switching banks you can select combinations from other banks. (The key will light, and the upper left of the LCD screen will indicate the selected bank.)  
For example to select bank [B], press the BANK [B] key. (The [B] key lights, and the upper left of the LCD screen indicates Bank B.)

#### Selecting a combination by bank

When you press the “Combination Select” popup button, a list of the combinations in each bank will appear, allowing you to choose one of these combinations. (Refer to the corresponding example for programs on p.20.)

#### Selecting a combination by category

When you press the Category popup button, a list of combination categories such as keyboard, organ, bass, or drums will appear, allowing you to select a combination from a specified category. With the factory settings, the combinations are organized into sixteen categories. (Refer to the corresponding example for programs on p.20.)

#### Using 10's HOLD when selecting a combination

When you press the [./10's HOLD] key to turn on the 10's HOLD function (the LCD screen will indicate  $\overline{10's}$  Hold), the ten's digit of the combination number will be held, and you will be able to switch combinations simply by pressing a single numeric key. In this case only the one's place of the number will change. You can use the [△][▽] keys to switch the ten's place. (Refer to the corresponding example for programs on p.21.)

#### Selecting a combination using a footswitch

You can assign the Combination Up/Down function to an on/off type foot switch (such as the optional PS-1) connected to the rear panel ASSIGNABLE SWITCH jack, and use it to switch combinations. (Refer to p.90)

#### Selecting a combination from an external MIDI device

You can transmit a MIDI program change message from an external MIDI device to the TRITON Extreme to switch combinations. (Refer to PG p.290)

For details on the factory-set combinations, refer to the VNL.

### Using controllers to modify the sound

You can use the joystick, ribbon controller, SW1, SW2, Realtime Controls [1]–[4], [VALUE] slider, keyboard, and a foot pedal/switch to control the sound.

Refer to the corresponding explanation for programs on p.21.

### Easy combination editing

#### Selecting a program for each timbre 1–8 (Program Select tab)

Switching the program assigned to each timbre 1–8 will change the sound of the combination.

There are three ways to switch programs. For details on each procedure, refer to the appropriate page of explanations.

- **Selecting a program from the TRITON Extreme**  
by bank/program number  
by program category
- **Selecting a program by receiving a MIDI program change**  
MIDI program changes cannot switch programs for a Timbre whose “Status” is set to other than INT.  
For details on the factory-set program names, refer to the VNL.

#### Status

This specifies the status of MIDI and the internal tone generator for each timbre 1–8. Normally, you will set this to INT if you want the TRITON Extreme's internal tone generator to sound. Set this to Off for timbres you are not using. If the status is set to Off, EXT, or EX2, that timbre will not sound. The EXT and EX2 settings allow the timbre to control a connected external MIDI device. (Refer to QS p.8, PG p.38)

#### Mixer tab

Here you can adjust the pan and level for each timbre 1–8. (Refer to QS p.9, PG p.40)

---

## Easy arpeggiator editing

### Arpeggio Play A/Arpeggio Play B tabs

- **You can switch arpeggiators A and B on/off independently.**  
To turn both arpeggiators on/off, use the ARPEGGIATOR [ON/OFF] key.  
The arpeggiator will operate only on timbres to which arpeggiator A or B is assigned.
- **The ARPEGGIATOR [TEMPO], [GATE], and [VELOCITY] knobs control the tempo, duration, and strength of the arpeggiated notes.** (☞ QS p.11)

---

## Combination editing

You can edit the preloaded combinations (banks A–D, H–M) with which the TRITON Extreme is shipped, or start with an initialized combination (banks E, N) to create your own original combination.

You can perform simple editing even in the P0: Play page, but the P1: Edit-Program/Mixer–P9: Edit-Master FX pages let you perform more detailed editing.

**note** Original programs using sample waveforms/multi-samples you sampled on the TRITON Extreme (or loaded into memory via Media mode) can also be used in a combination.

**note** If a program being edited in Program mode is used in a combination, it will sound according to the settings being edited.

**!** If you wish to save an edited combination in internal memory, you must write it. (☞ p.114)  
You can write combinations to the 1,536 combination memory areas (internal memory) of banks A–E and H–N. You can also save and manage combinations on various types of media. (☞ p.117)

---

## Suggestions for editing procedure

First use P1: Edit-Program/Mixer to select the program for each timbre, and then use P4: Edit-Zone/Ctrl to specify the range in which each program will sound (layer, split, velocity switch, etc.). Then adjust the volume of each timbre, and set various other parameters.

To add finishing touches to the sound, you can assign insert effect settings (in P8: Edit-Insert FX) and master effect, master EQ and Valve Force settings (in P9: Edit-Master FX) that are different from the effect settings of Program mode. In addition, you can make arpeggiator settings (in P7: Edit-Arp.) and controller settings (in P4: Edit-Zone/Ctrl) to create the finished combination.

**note** By using the page menu command “Solo Selected Timbre”, you can listen to the selected timbre only. This is a convenient way to audition the individual sounds of timbres that are layered. (☞ PG p.39)

---

## Layer, split, and velocity switch

Within a combination, you can use key position and velocity to determine which program will sound.

The programs assigned to each timbre can sound in three ways: as part of a **layer**, a **split**, or a **velocity switch**. A combination can be set to use any one of these methods, or to use two or more of these methods.

## Layer

Layer refers to settings which cause two or more programs to sound simultaneously when a note is played.

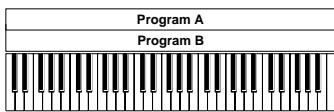

Layer:  
Two or more programs sound simultaneously.

## Split

Split refers to settings which cause different programs to sound on different areas of the keyboard.

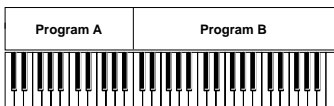

Split:  
Different programs will sound in different areas of the keyboard.

## Velocity switch

Velocity Switch refers to settings which cause different programs to sound depending on the velocity (keyboard playing dynamics).

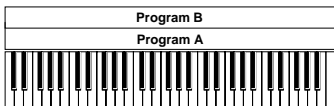

Strong ↑ Keyboard playing dynamics  
Soft ↓ dynamics  
Velocity Switch:  
Keyboard playing dynamics (velocity) switches between different programs.

On TRITON Extreme, you can use a different program for each of up to eight timbres, and combine two or more of the above methods to create even more complex setups.

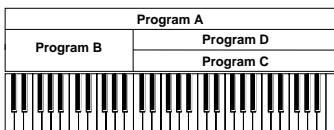

Strong ↑ Keyboard playing dynamics  
Soft ↓ dynamics  
Example:  
B and C/D are split. In the lower keyboard range, A and B are layered. In the higher keyboard range, C and D are switched by velocity and layered with A.

As an additional possibility, you can set the slope for a key zone or velocity zone so that the volume diminishes gradually. This lets you change a split into a keyboard crossfade, or a velocity switch into a velocity crossfade.

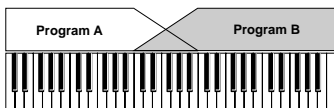

Keyboard X-Fade (keyboard crossfade):  
As you play from low notes to high notes, the volume of A will fade out, and the volume of B will fade in.

## The Compare function

When one of the P1–P9 pages is selected, you can press the [COMPARE] key (the key will light) to recall the sound that was last written before editing. As you are editing a combi, you can use the [COMPARE] key to listen to the previously saved version (as it was before you began editing). Pressing [COMPARE] again (the light goes dark) returns you to the version you are editing. If you continue editing when the [COMPARE] key is lit, the key will go dark, and the current setting will now be the sound that is recalled when the [COMPARE] key is dark.

## Timbre 1–8 program, pan and volume P1: Edit-Program/Mixer

Here you can assign programs to each timbre 1–8, and set the pan and volume for each one.

**note** These settings can also be made in the Program Select and Mixer pages of P0: Play.

## Edit-Program/Mixer page

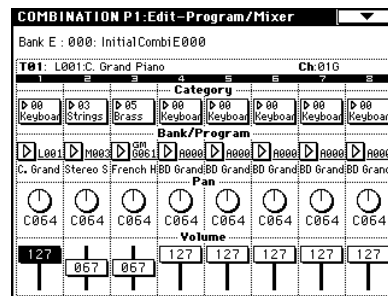

### Category, Program Select (Bank/Program)

Assigns a program to each timbre.

**note** When the “Bank/Timbre Program” select menu is displayed, you can select programs by bank. When the “Category/Timbre Program” select menu is displayed, you can select programs from the 16 categories. (p.32)

**note** You can also use the BANK [A]–[N] keys to select the bank of the program.

**MIDI** If you wish to select programs by receiving MIDI program changes, do so in P0: Play.

### Pan

Specifies the panning (stereo position) for each timbre. A setting of **C064** will reproduce the oscillator pan setting of the program. Adjusting this parameter will move the sound to left or right while preserving the pan relationship between the oscillators. A setting of **L001** is far left, and **R127** is far right.

### Volume

Adjusts the volume of each timbre.

Create the overall sound by adjusting the volume balance between timbres. The “Volume” setting is an important aspect of creating the sound, and this setting will have a significant effect on the overall impression produced by the Combination.

Settings for status, MIDI channel, and pitch parameters  
**P2: Edit-Trk Param**

**MIDI Ch page**

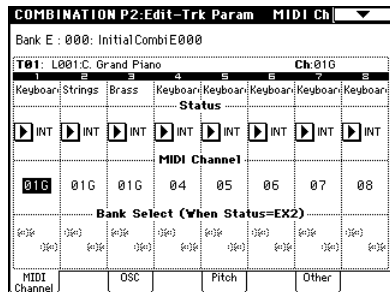

**Status**

Here you can specify the MIDI status of the internal tone generator assigned to each timbre. Normally when playing the internal tone generator of TRITON Extreme, you will set this to **INT**. Set this to **Off** for timbres that you are not using. With settings of Off, EXT, or EX2, TRITON Extreme will not sound. With settings of EXT or EX2, you can control an external tone generator connected via MIDI. (PG p.38, 43)

**MIDI Channel**

Timbres that you wish to play from TRITON Extreme’s keyboard must be set to the global MIDI channel. Your playing on the keyboard is transmitted on the global MIDI channel, and will sound any timbre that matches this channel. Normally you will set this to **Gch**. When this is set to **Gch**, the MIDI channel of the timbre will always match the global MIDI channel, even if you change the global MIDI channel.

On some preloaded combinations that use the arpeggiator, timbres assigned to the arpeggiator may not have a “Status” of INT and “MIDI Ch” of Gch. The reason for this is that these settings are for timbres that sound only when the arpeggiator is on. This is a very useful technique for creating combinations that use the arpeggiator. Refer to “Arpeggiator settings in Combination and Sequencer modes” (PG p.96), and study the relationship between arpeggiator assignments, “Status,” and “MIDI Channel.”

**Bank Select (when status=EX2)**

This setting is valid when “Status” is set to **EX2**. It specifies that Bank Select messages will be transmitted from TRITON Extreme.

**OSC page**

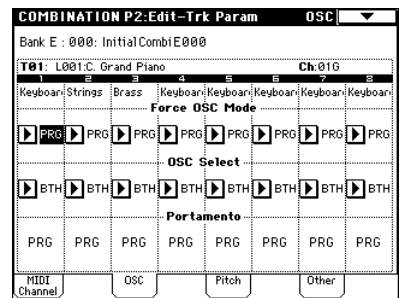

**Force OSC Mode**

Normally you will set this to **PRG** (the oscillator will play as set by the program settings). If you wish to force a polyphonic program to sound monophonically in this combination, without re-writing the program itself, set this either to **MN** (Mono) or **LGT** (Legato). Conversely, set this to **Poly** if you wish to force a monophonic program to play polyphonically (PG p.43).

**OSC Select**

Normally you will set this to **BTH** (Both). If the timbre is using a program whose “Oscillator Mode” is **Double**, and you want only OSC1 or OSC2 (not both) to sound, set this to **OSC1** (only OSC1 will sound) or **OSC2** (only OSC2 will sound).

**Portamento**

Normally you will set this to **PRG**. If you want to override the portamento setting specified in the program assigned to the timbre to be forced off, set this parameter to **Off**. Conversely, if you want to force the portamento to be on, or to change the portamento time, set this to a value of **001–127** to specify the portamento time.

**Pitch page**

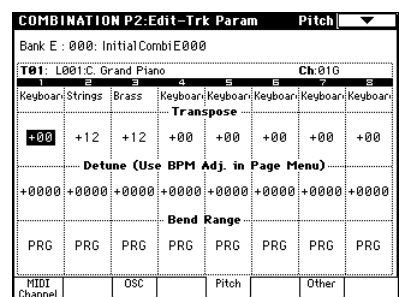

**Transpose, Detune (BPM Adjust)**

These parameters adjust the pitch of the timbre.

- In a layer-type combination, you can set two or more timbres to the same program, and create a richer sound by using “Transpose” to shift their pitch apart by an octave or by using “Detune” to create a slight difference in pitch between the two.
- In split-type combinations, you can use “Transpose” to shift the pitch (in semitone units) of the programs specified for each key zone.
- If you wish to change the playback pitch of a drum program, use “Detune.” If you change the “Transpose” setting, the relationship between notes and drum sounds will change.

● Adjusting the BPM of multisamples or samples created in Sampling mode

If a timbre's program uses multisamples or samples that you created in Sampling mode (or loaded in Media mode) at a specific BPM value, you can use the page menu command "Detune BPM Adjust" to call up a new BPM value. This changes the BPM by adjusting the playback pitch. (PG p.44)

Other page

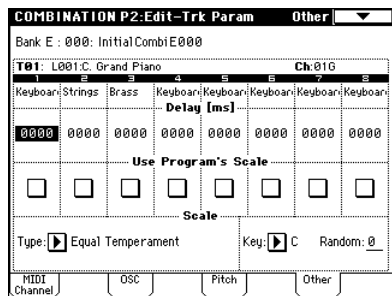

Delay [ms]

Specifies the amount of time before the program assigned to each timbre will sound. Specifies the time from when you play the keyboard until the program will sound. If you select **KeyOff** for this parameter, the timbre will sound when the note is released.

Use Program's Scale, Scale

Specifies the scale for each timbre. If you check "Use Program's Scale," the scale specified by the program will be used. Timbres for which this is not checked will use the **Scale** setting.



MIDI filter settings  
P3: Edit-MIDI Filter

For each MIDI Filter item, you can specify whether or not the corresponding MIDI message will be transmitted and received. The **checked** items will be transmitted and received.

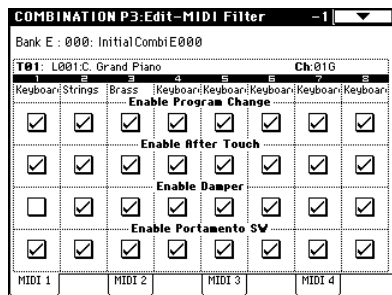

⚠ MIDI filter does not turn the function itself on/off, but specifies whether or not that MIDI message will be transmitted and received. For example if portamento is on, portamento will be applied to the sound of TRITON Extreme even if "Portamento SW CC#65" is unchecked.

For example if you selected a bass program for timbre 1 and a piano program for timbre 2 to create a split-type combination, you could make the following settings so that pressing the connected damper pedal would apply the damper effect only to the piano program of timbre 2.

○ Set the P3: Edit-MIDI Filter-1 "Enable Damper" parameter

Timbre 1 "Enable Damper": unchecked

Timbre 2 "Enable Damper": checked



Layer, split, and velocity switch settings/Controller settings  
P4: Edit-Zone/Ctrl

Key Zone page (Key zone settings)

Indicates settings such as layer, split, and keyboard crossfade.

Specifies the range of notes that will be sounded by each timbre. Each area that sounds a timbre is referred to as a **Key Zone**. By setting key zones, you can create a combination in which different programs sound in different areas of the keyboard.

By combining key zones specified for each timbre, you can create **layered** or **split** combinations.

The upper and lower limits for the key zone of each timbre are set by the "Top Key" and "Bottom Key" respectively.

For example in the following diagram, timbres 1-3 are set to create a layered and split combination. This is specified by the key zone settings.

Timbres 2 and 3 create a layer. Timbre 1 and timbres 2/3 are split between the B3 and C4 note numbers.

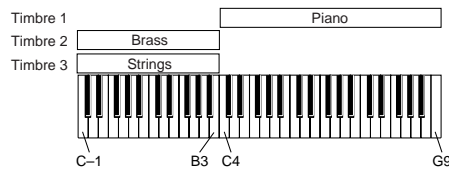

As an example here, we will explain how to create a combination like the one shown above.

- ① In the P0: Play, Program Select page or the P1: Edit-Program/Mixer page, use the "Program Select" area to select the program that will be used for each timbre 1-3.
  - Select a piano program for timbre 1.
  - Select a brass program for timbre 2.
  - Select a strings program for timbre 3.
- ② In the MIDI Ch page of P2: Edit-Trk Param, set "Status" to INT for all the timbres that you wish to use, and set "MIDI Channel" to either Gch or to match the global MIDI channel (a "G" will be displayed after the channel number).
- ③ In the Key Zone page of P4: Edit-Zone/Ctrl, set "Top Key" and "Bottom Key."
  - Set timbre 1 to a "Top Key" of G9 and a "Bottom Key" of C4.
  - Set timbres 2 and 3 to a "Top Key" of B3 and a "Bottom Key" of C-1.



You can also enter these values by holding down the [ENTER] key and playing a note on the keyboard.

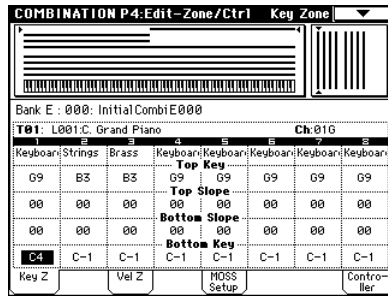

### Key Zone Slope

Here you can specify the range of keys over which the original volume will be reached, starting at the top key and bottom key.

In the example above, you could set the "Bottom Key" of timbre 1 to G3, and set the "Top Key" of timbre 2 to G4, so that these two timbres overlap. Next if you set the "Bottom Slope" of timbre 1 to 12, and set the "Top Slope" of timbre 2 to 12 the sound will change gradually, instead of changing suddenly between B3 and C4.

### Vel Zone page (Velocity zone settings)

Here you can make settings for velocity switching and velocity crossfading.

For each timbre, you can specify a range of velocities for which it will sound. The range of velocities for which a timbre will sound is called a **Velocity Zone**. By setting a velocity zone, you can set up a timbre which will be sounded only by notes played within a certain range of velocities, and not by notes played outside this Velocity Zone.

By combining timbres that have differing velocity zone settings, you can create **velocity switched** combinations.

The upper and lower limits of the velocity zone of each timbre are determined by the "Top Velocity" and "Bottom Velocity" respectively.

The following diagram shows an example of a velocity switched combination in velocity will switch between timbres 1 and 2 to play different programs. Such combinations are created by setting the velocity zone.

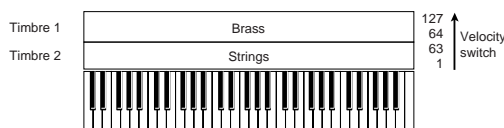

As an example, we will explain how to create a combination like the one shown above.

- ① In the P0: Play, Program Select page or the P1: Edit-Program/Mixer, Prog page, use the "Program Select" area to select the program that will be used for each timbre 1 and 2.  
Select a brass program for timbre 1.  
Select a strings program for timbre 2.
- ② In the MIDI Ch page of P2: Edit-Trk Param, set "Status" to INT for all the timbres that you wish to use, and set "MIDI Channel" to either Gch or to match the global MIDI channel (a "G" will be displayed after the channel number).
- ③ In P4: Edit-Zone/Ctrl, Vel Zone page, set the "Top Velocity" and "Bottom Velocity."

Set timbre 1 to a "Top Velocity" of 127 and a "Bottom Velocity" of 64.

Set timbre 2 to a "Top Velocity" of 63 and a "Bottom Velocity" of 1.

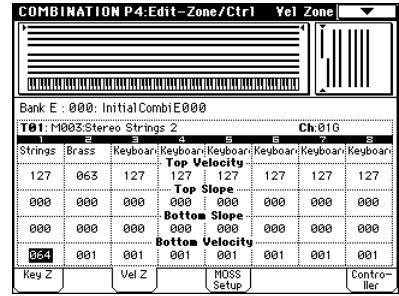

### Velocity Zone Slope

Here you can specify the range of values over which the original volume will be reached, starting from the top velocity and bottom velocity.

In the case of the above example, you could set the velocity zones of the two timbres so that they partially overlap, and set the "Top Slope" and "Bottom Slope" so that the sound changes gradually, instead of changing suddenly between velocity values of 63 and 64.

### Control page (Controller settings)

For each combination, you can specify the functions of the B-mode functions of REALTIME CONTROLS knobs [1]–[4], and the [SW1] and [SW2.] (p.129, PG p.48, 279, 280)

## Arpeggiator settings

### P7: Edit-Arp.

Indicates settings for the arpeggiator (p.96).

## Insert Effect settings

### P8: Edit-Insert FX

Indicates the insert effects, and allows you to adjust their settings.

Specifies the routing for each timbre (i.e., how it is sent to the insert effect, master effects, and individual outputs). (p.105)

## Master Effect and Valve Force settings

### P9: Edit-Master FX

Indicates the master effects, and allows you to adjust their settings. Here you can also make master EQ and Valve Force settings (p.106).



## Auto Song Setup function

This function automatically applies the settings of the current combination to a new song.

If inspiration for a phrase or song strikes you while you're playing a combination, you can use this function to start recording immediately.

Hold down the [ENTER] key and press the SEQUENCER [REC/WRITE] key. The "Setup to Record" dialog box will open and ask "Are you sure?". Press "OK". You will automatically enter Sequencer mode, and will be in the record-ready state. Press the [START/STOP] key to start the sequencer and begin recording.

# Producing songs (Sequencer mode)

TRITON Extreme contains a 16-track MIDI sequencer. The sequencer acts as a hub, integrating TRITON Extreme's numerous functions.

⚡ When you turn off the power, the settings made in Sequencer mode and the song data, cue list data, and any user pattern data that you recorded will not be backed up. If you wish to keep this data, you must save it on media before turning off the power, or perform a MIDI data dump to save the data on an external data filer etc.

If you wish to save the programs, track parameters, effects, and arpeggiator function settings etc. selected for a song as a template song, use the page menu command "Save Template Song."

Immediately after the power is turned on, TRITON Extreme will not contain any cue list data or song data, so if you wish to playback a song on the sequencer, you must first load data from media or receive a MIDI data dump from a MIDI filer (see p.121, PG p.163, 176)

## Features of the sequencer

- The sequencer lets you record a **maximum of 200,000 events** (note data etc.), up to **200** songs, and as many as **999** measures per song.
- Up to **20 cue lists** can be created. A cue list is an arrangement of up to 99 songs that will be played as a chain. You can specify the number of times that each song will repeat. A cue list can also be converted into a single song.
- The **arpeggiator function** can be used during playback or recording.
- The **RPPR (Realtime Pattern Play/Recording) function** can be used during playback or recording.
- Sixteen different **template songs** are built-in, and contain program and effect settings suitable for various musical styles. Up to sixteen original templates that you create can be saved as user template songs.
- Five **stereo insert effects**, two **master effects**, **stereo master EQ**, and a **Valve Force** can be used for each song.
- Timing resolution is a maximum of  $\downarrow/192$ .
- Sixteen tracks are provided for MIDI data, and a master track contains time signature and tempo data that controls the playback.
- A **track play loop** function lets you loop specified measures independently for each track.
- 150 preset patterns ideal for drum tracks are built in. In addition, you can create up to 100 user patterns for each song. These patterns can be used as musical data within a song, or can be played by the RPPR function.
- Various methods of recording are supported, including **realtime recording** in which your performance on the keyboard and controllers (including MIDI control events, MIDI exclusive messages) is recorded just as you play, and **step recording** in which the timing, length, and velocity of each note can be specified in the LCD as you input the pitches from the keyboard.
- The musical data and control events that you recorded can be **edited** in various ways (including event editing and many other edit commands).
- Exclusive messages (including XG and GS format data) received from an external MIDI device, or parameter changes you create by editing track param-

eters, can now be recorded in realtime on any track. You can also use the page menu command "Put Effect Setting (MIDI Exclusive) to Track" to record effect parameter settings into the desired location.

During playback, you can send this data to an external MIDI device or use it to control song track parameters or effect parameters. Standard MIDI Files (SMF) containing system exclusive messages can be loaded in from disk, preserving the exclusive data.

- "Tone Adjust" parameter let you make temporary adjustments to the sound of the program used by a track, while leaving the original program unchanged. While creating a song, you can use this capability to make changes in realtime by (for example) softening the tone of the bass sound or sharpening the attack of the strings without having to return to Program mode and edit the program itself.
- When the "Status" of a track is set to INT or BTH, an external sequencer can be used to play TRITON Extreme as a multi-timbral tone generator. When the "Status" of a track is set to BTH, EXT, or EXT2, the sequencer of TRITON Extreme can play external tone generators.
- Playback can be synchronized with an external MIDI device.
- TRITON Extreme's **AMS (Alternate Modulation)** capability lets you use control changes for realtime control of the parameters of the programs used in a program. Its **MIDI Sync** abilities let you synchronize the LFO speed to changes in the tempo.
- **Dmod (Dynamic Modulation)** functionality lets you control effect parameters in realtime. You can also use **MIDI Sync** to synchronize the LFO speed or delay time to changes in the tempo.
- You can assign names not only to the song, but also to each pattern and track.
- Combination and Program settings can be copied to a song.
- Sequencer data such as a song or cue list that you create can be saved in TRITON Extreme's native format, or transmitted as a MIDI data dump.
- A song you created can be converted into SMF (Standard MIDI File) data. SMF songs can also be loaded.
- The "PLAY/MUTE/REC" and "SOLO On/Off" let you instantly play/mute any desired track on the fly.
- You can rewind or fast-forward while listening to the sound.
- The [LOCATE] key lets you move quickly to a desired location.
- Multisamples you create can be played back together with internal programs in Sequencer mode. The Time Slice function of Sampling mode lets you divide a rhythm loop sample and create performance data that corresponds to the divided samples. In Sequencer mode you can play this performance data, and adjust the playback tempo without affecting the pitch of the rhythm loop sample. You can also exchange the note numbers of the data, or modify the timing to freely re-create new rhythm loops.
- The TRITON Extreme provides an **In-Track Sampling** function which lets you sample an external audio source while the song plays back, and will automatically create note data to trigger that sample at the appropriate point during the playback of the track.
- When you've created a song, you can resample it to media and turn it into an original audio CD by using Media mode to burn the song to a CD-R/RW drive connected to the USB A connector.

## The structure of Sequencer mode

Sequencer mode is structured as follows.

### Songs

A song consists of MIDI tracks 1–16, a master track, song parameters such as the song name, effect, arpeggiator and RPPR parameters, and 100 user patterns.

A maximum of 200 such songs can be created on TRITON Extreme.

MIDI tracks 1–16 and the master track each consist of **setup parameters** located at the start location, and **musical data** within the track.

#### Setup parameters

##### MIDI tracks 1–16

Bank/Program No.\*, PLAY/MUTE/REC, Pan\*, Volume\*, Track Play Loop, Loop Start Measure, Loop End Measure, Play Intro, Status, MIDI Channel, Bank Select (When Status=EX2), Force OSC Mode, OSC Select, Portamento\*, Transpose\*\*, Detune\*\*, Bend Range\*\*, Delay, Use Program's Scale, MIDI Filter, Key Zone, Velocity Zone, Track Name, Arpeggiator Assign, IFX/Indiv.Out BUS Select, Send1(MFX1)\*, Send2(MFX2)\*

##### Master track

Time signature\*, Tempo\*

#### Musical data

##### MIDI tracks 1–16

Note On/Off, Program Change (including Bank Select), Pitch Bend, After Touch (Poly After), Control Change, Pattern No., System Exclusive

- \* When you change the setting during realtime-recording, this will be recorded as musical data. This allows the starting settings to be modified during the playback.

\*\* Musical data (MIDI RPN data) can be used to change the starting settings during playback. For details on control changes and RPN, refer to PG p.285, 293.

**note** Of the above parameters, those that can be edited during realtime recording can be recorded as exclusive data.

### Patterns

There are two types of patterns: preset patterns and user patterns.

- **Preset patterns:** Patterns suitable for drum tracks are preset in internal memory, and can be selected for any song.
- **User patterns:** Each song can have up to 100 patterns. When using a pattern in a different song, use the Utility menu commands “Copy Pattern” or “Copy From Song” etc. to copy the pattern. The pattern length can be specified in units of a measure.

Each pattern consists of musical data for one track. It is not possible to create patterns that contain multiple tracks. These patterns can be used as track musical data by being **placed in a track** (page menu command “Put to Track”) or **copied to a track** (page menu command “Copy to Track”). Alternatively, you can use a pattern with the **RPPR function of a song**.

### Cue List

A **cue list** allows you to playback multiple songs in succession. The TRITON Extreme allows you to create 20 cue lists. Each cue list allows you to connect a maximum of 99 songs in any order, and to specify the number of times that each song will repeat.

The page menu command “Convert to Song” lets you convert the two or more songs in a cue list into a single song. This allows you to use a cue list to create the backing, then convert the cue list into a song and add solo phrases on unused tracks.

### Sequencer structure and corresponding pages

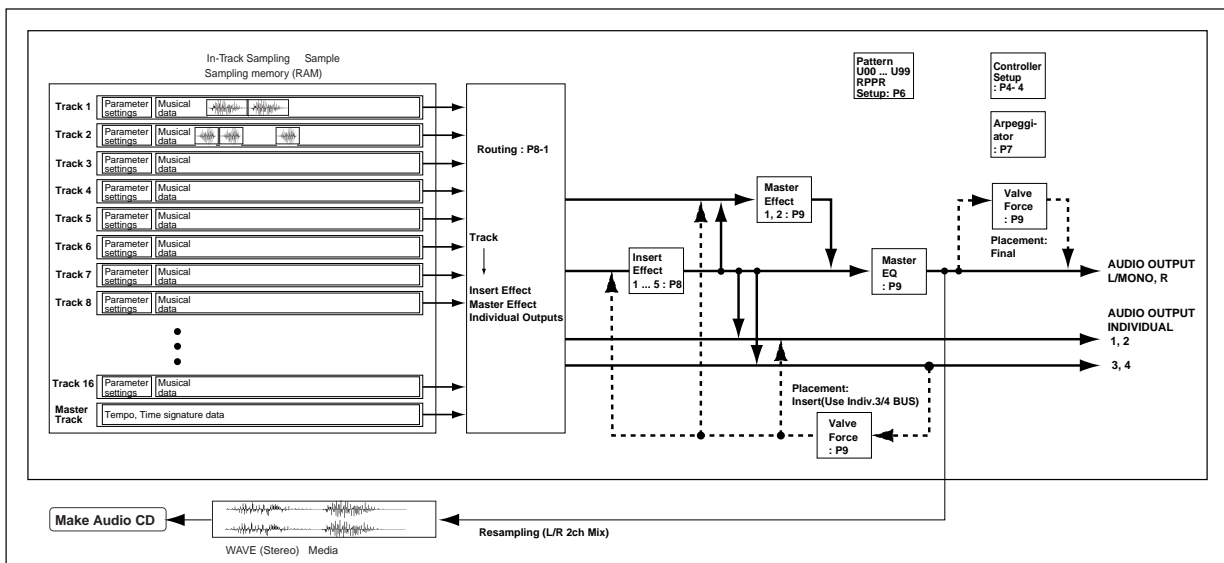

## Sequencer mode page structure

Page	Explanation
P0: Play/REC	Play/record songs, and make associated settings. Select the program for each track. Pan and level settings. Settings for sampling.
P1: Cue List	Play, create, and make settings for cue lists.
P2: Trk Param	Parameter settings for each track of a song. MIDI, OSC, Pitch, etc.
P3: MIDI Filter	MIDI message transmission/reception filter settings for each track of a song.
P4: Zone/Ctrl	Key Zone and Velocity Zone settings for each track of a song. Controller settings. If the separately sold EXB-MOSS expansion is installed, settings for related parameters.
P5: Track Edit	Edit musical data for song tracks. Specify track names. Tone settings for the program of each track.
P6: Pattern/RPPR	Record and edit patterns for a song. Specify pattern names. RPPR function settings for a song.
P7: Arpeggiator	Arpeggiator settings.
P8: Insert Effect	Select and make settings for insert effects. Set the routing, insert effects, master effects, and individual output send amounts for each track of the song.
P9: Master Effect	Select and make settings for the master effects. Master EQ and Valve Force settings.

**note** For details on how to access each mode and page, refer to “Basic operation” (p.13).

**note** If the separately sold EXB-MOSS option is installed, bank F programs can also be used in Sequencer mode. For details on the parameters of bank F programs, refer to the EXB-MOSS owner’s manual.

**MIDI** The MIDI transmit/receive settings for each track are made in “MIDI Channel” (P2: Edit-Trk Param, MIDI Ch page). Insert effects, master effects, and Valve Force settings are controlled on the “Ctrl Ch” (P8, P9).

**note** Sampling or resampling can be performed in Sequencer mode (p.80). You can also apply the TRITON Extreme’s effects to an external audio input source, for a wide range of possibilities. (p.107, 111)

## Preparations for recording

**⚠** Before you begin recording, make sure that the memory protect setting in Global mode is turned off. (p.90)

### Creating a Song

Before we can begin this example, we need to create an empty song where we can record. First, press the [SEQ] key to enter Sequencer mode. Next, press the “Song Select” popup button to the left of the Song number and name (S000: NEW SONG). Press the number corresponding to the first unnamed song. A dialog box will appear.



Press OK to create the new song (or press Cancel to exit).

## Track settings

Since we’re going to record a new song in this example, we will start by explaining how to assign a program to each MIDI track, and make basic settings such as volume.

**note** By loading a template song, you can easily make appropriate settings for various styles of music.

### ① Assign a program to each MIDI track.

In the Sequencer P0: Play/REC, Program T01-08/T09-16 page, use “Program Select” to assign a program to each MIDI track.

At this time you can press the “Category” popup and select programs by category.

You can copy settings from a combination or program (p.58).

**note** When assigning a program, you can use “Track Select” to select the track for which you are making assignments, and try playing the sound.

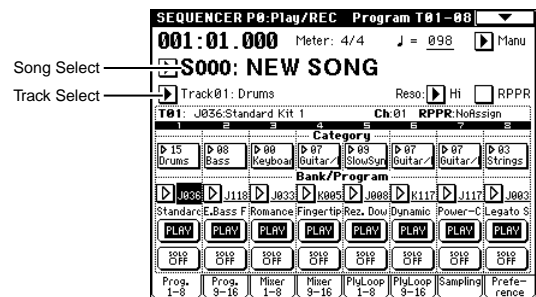

### ② Set the pan and volume of each MIDI track.

In the Sequencer P0: Play/REC, Mixer T01-08/T09-16 page, “Pan” sets the pan of each track, and “Volume” sets the volume of each track.



### ③ Specify the tone generator and MIDI channel that will be played by each MIDI track.

In the Sequencer P2: Trk Param, MIDI Ch T01-08/T09-16 page, “Status” specifies whether each track will sound the internal tone generator or an external tone generator. “MIDI Channel” specifies the MIDI channel for each track.

If the track “Status” is set to INT, playing the track data or operating the TRITON Extreme’s keyboard or controllers will cause the TRITON Extreme’s internal tone generator to be played.

If “Status” is set to EXT, EX2, or BTH, playing the track data or operating the TRITON Extreme’s keyboard or controllers will cause an external tone generator to be sounded and controlled. (The MIDI channel of the external tone generator must be set to match the “MIDI Channel” of TRITON Extreme tracks that are set to EXT, EX2 or BTH.)

If “Status” is set to BTH, both the external tone generator and the TRITON Extreme’s own tone generator will be sounded and controlled.

If you are using the TRITON Extreme's Sequencer mode as a 16-track multi-timbral tone generator, set this parameter to INT or BTH. (☞ "Status" PG p.72) In general, you should set "MIDI Channel" to different channels 1-16 for each track. Tracks that are sent to the same MIDI channel will sound simultaneously when either is recorded or played.

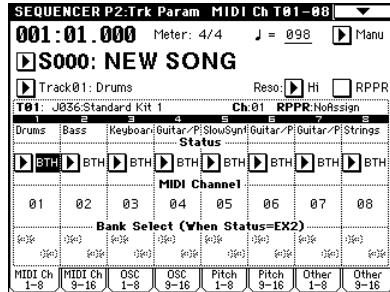

- ④ **Adjust the effect settings.**  
Make settings for each effect in Sequencer P8: Insert Effect and P9: Master Effect. (☞ p.105, PG p.95, 98)
- ⑤ **Set the tempo and time signature.**  
Make these settings in Sequencer P0: Play/REC. "J (Tempo)" sets the tempo, and "Meter" sets the time signature. (☞ PG p.55)
- ⑥ **As necessary, set "Reso" to specify the quantization resolution.** (☞ PG p.57)
- ⑦ **Make other settings as necessary.**  
As necessary, make arpeggiator settings (Sequencer P7: Arpeggiator), MIDI filter settings (Sequencer P3: MIDI Filter) and Valve Force (Sequencer P9: Master Effect). (☞ PG p.55-102)

When you are finished making these settings, the basic setup is complete. Record as described in "Recording methods" and following sections.

**note** You can use the Tone Adjust page (Sequencer P5: Track Edit, Tone 1.2-5.6) to make adjustments to each program as appropriate for your song, for example by making the bass a bit more mellow, or by speeding up the attack of the strings. This lets you adjust the sound and keep those changes as part of the song data without having to move back to Program mode to edit and write the settings.

**[LOCATE] settings**

By pressing the [LOCATE] key you can move to a specified location.

The location is specified by the Utility menu command "Set Location." You can also hold down the [ENTER] key and press the [LOCATE] key to set the location even during playback (☞ PG p.61).

When you select a song, the "LOCATE" setting will automatically be set to 001:01.000.

Normally you will leave this set to 001:01.000., to return you to the beginning of the song.

**Monitoring just a specific track/Muting just a specific track (Solo/Mute functions)**

The TRITON Extreme provides a Solo function that lets you listen to only specific tracks, and a Mute function that can silence specific tracks. These functions can be used in various ways. For example you can intentionally mute or solo specific tracks, or listen only to the rhythm section of the previously-recorded tracks while you record new tracks. Let's try out the Mute and Solo functions.

- ① **Load a song.**  
As described on QS p.2, load the demo songs, and select any song.
- ② **Access the Sequencer P0: Play/REC, Program T01-08/T09-16 page.**  
Press the SEQUENCER [START/STOP] key.
- ③ **Press track 1 "PLAY/MUTE/REC."**  
The display will change from "PLAY" to "MUTE," and the playback of track 1 will no longer be heard. In this way, the "mute" function allows you to silence a specified track until the track is un-muted.



- Press track 2 "PLAY/MUTE/REC."**  
The display will change, and the playback of track 2 will also be muted.



**To cancel muting, press "PLAY/MUTE/REC" once again.**

- ④ **Press track 1 "SOLO ON/OFF."**  
The display will change from "SOLO OFF" to "SOLO ON," and this time, only the performance of track 1 will be heard. To play back only a specified track by itself in this way is known as "soling" the track (turning Solo on).



**note** If both Mute and Solo are used, the Solo function will be given priority.

- Press track 2 "SOLO ON/OFF."**  
The display will change, and only the playback of tracks 1 and 2 will be heard.



**To switch Solo off, press "SOLO ON/OFF" once again. Press "SOLO ON/OFF" for both tracks 1 and 2.**  
The display will change, and the playback of tracks 1 and 2 will be muted. If the Solo function is turned off for all tracks, playback will be according to the "PLAY/MUTE/REC" settings.

**note** By using the page menu command "Solo Selected Track," you can listen to the sound of only the selected track. This is convenient when you want to set track parameters or to make effect settings. (☞ PG p.58)

## Recording methods

This section describes the ways in which you can record on the TRITON Extreme.

### Recording a track

There are two ways to record to a **MIDI track**: **realtime recording** and **step recording**. You can choose from six types of realtime recording.

On **MIDI tracks** you can edit the recorded data in various ways. You can use **Event Editing** to insert data, and perform Track Edit operations such as **Create Control data** to insert data such as pitch bend, aftertouch, and control change.

### Recording a pattern

There are two ways to record a pattern: **realtime recording** and **step recording**. For realtime recording, only one recording type (loop) is available.

In addition, you can use **event edit** operations to modify data that has been recorded or to insert data.

The page menu command “**Get From Track**” can be used to take musical data from a desired area of a track, and use it as the musical data for a pattern. Conversely, the page menu commands “**Put to Track**” and “**Copy to Track**” can be used to place or to copy the musical data of a pattern in a track.

### Realtime recording on a MIDI track

This is a method of recording in which your playing on the keyboard and your operations of controllers such as the joystick are recorded in realtime.

This method of recording is normally used one track at a time, and is called **single track recording**.

As an alternative, **multitrack recording** allows you to simultaneously record multiple channels of data onto multiple tracks. This is the method you will use when using the RPPR function and the arpeggiator function to record multiple tracks of musical data at once, or when you playback existing sequence data on an external sequencer and record it onto TRITON Extreme's sequencer in realtime.

○ These settings are made in **Sequencer P0: Play/REC, Preference page “Recording Setup.”**

#### • Overwrite

With this method, the musical data previously recorded on a track is overwritten by the newly recorded data. When you perform overwrite recording on a previously-recorded track, its musical data will be deleted and replaced by the newly recorded data. Normally you will use this method to record, and then modify the results by using other types of realtime recording or event editing.

① Use “**Track Select**” to select the track that you want to record.

② Set the “**Recording Mode**” to **Over Write**.

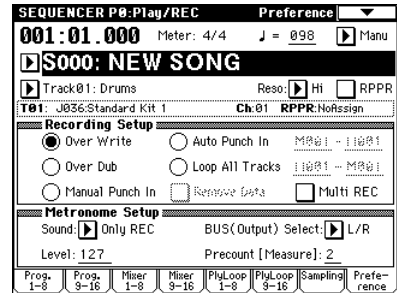

③ In “**Location**,” specify the location at which you wish to begin recording.

④ Press the **SEQUENCER [REC/WRITE]** key, and then press the **SEQUENCER [START/STOP]** key. If the “**Metronome Setup**” is still set to the default settings, the metronome will sound for a two-measure pre-count, and then recording will begin. Play the keyboard and move controllers such as the joystick to record your performance.

⑤ **When you finish playing, press the SEQUENCER [START/STOP] key.** Recording will end, and the location will return to the point at which you begin recording. If you press the [PAUSE] key instead of the SEQUENCER [START/STOP] key, recording will pause. When you press the [PAUSE] once again, recording will resume. When you are finished, press the SEQUENCER [START/STOP] key to stop recording.

#### • Overdub

With this method, the newly recorded musical data is added to the existing data. When you perform overdub recording on a previously-recorded track, the newly recorded data will be added to the previously-recorded data. It is best to select this mode if you will be recording additional control data, recording a drum pattern, or recording the tempo in the master track. With this mode, data can be added without erasing the existing performance data.

① Use “**Track Select**” to select the track that you want to record.

② Set the “**Recording Mode**” to **Over Dub**.

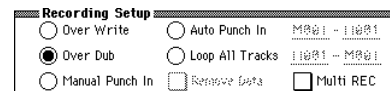

③ **For the rest of the procedure, refer to steps ③–⑤ of “Overwrite.”**

#### • Manual punch-in

While the song is playing, you can press the **SEQUENCER [REC/WRITE]** key or a connected pedal switch at the desired location to start or stop recording. With this method, the musical data previously on the track is overwritten by the newly recorded data.

① Use “**Track Select**” to select the track that you want to record.

② Set the “**Recording Mode**” to **Manual Punch In**.

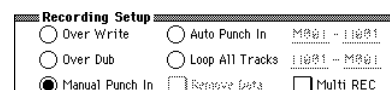

- ③ In “Location,” specify a location several measures earlier than the point at which you wish to begin recording.
- ④ Press the SEQUENCER [START/STOP] key. Playback will begin.
- ⑤ At the point at which you wish to begin recording, press the SEQUENCER [REC/WRITE] key. Recording will begin. Play the keyboard and operate controllers such as the joystick to record your performance.
- ⑥ When you finish recording, press the SEQUENCER [REC/WRITE] key. Recording will end (playback will continue).

**note** Instead of pressing the SEQUENCER [REC/WRITE] key in steps ⑤ and ⑥, you can use a foot switch connected to the ASSIGNABLE SWITCH jack. Set the Global P2: Controller page “Foot Switch Assign” to Song Punch In/Out (see p.90).

- ⑦ Press the SEQUENCER [START/STOP] key. Playback will stop, and you will return to the location that you specified in step ③.

#### • Auto punch-in

First you must specify the area that will be re-recorded. Then recording will occur automatically at the specified area. With this method, the musical data previously on the track is overwritten by the newly recorded data.

- ① Use “Track Select” to select the track that you want to record.
- ② Set the “Recording Mode” to Auto Punch In.

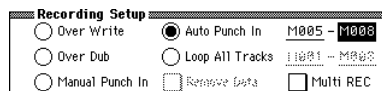

- ③ In “M (Auto Punch In Start Measure), “M (Auto Punch In End Measure)” specify the area that you wish to record. For example if you specify M005–M008, recording will occur only from measure 5 to measure 8.
- ④ In “Location,” specify a location several measures earlier than the point at which you wish to begin recording.
- ⑤ Press the SEQUENCER [REC/WRITE] key, and then press the SEQUENCER [START/STOP] key. Playback will begin. When you reach the starting location you specified in step ③, recording will begin. Play the keyboard and operate controllers such as the joystick to record your performance. When you reach the ending location you specified in step ③, recording will end. (Playback will continue.)
- ⑥ Press the SEQUENCER [START/STOP] key. Playback will stop, and you will return to the location you specified in step ④.

#### • Loop All Tracks

This method lets you continue recording as you add musical data. The specified region can be recorded repeatedly. This is ideal when recording drum phrases, etc.

- ① Use “Track Select” to select the track that you want to record.
- ② Set the “Recording Mode” to Loop All Tracks. If “Multi REC” is checked, it will not be possible to select Loop All Tracks.

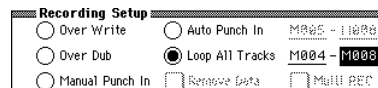

- ③ In “M (Loop Start Measure), “M (Loop End Measure)” specify the area that you wish to record. For example if you specify M004–M008, recording will occur repeatedly (as a loop) from measure 4 to measure 8.
- ④ In “Location,” specify a location several measures earlier than the point at which you wish to begin recording.
- ⑤ Press the SEQUENCER [REC/WRITE] key, and then press the SEQUENCER [START/STOP] key. Playback will begin. When you reach the starting location you specified in step ③, recording will begin. Play the keyboard and operate controllers such as the joystick to record your performance. When you reach the ending location you specified in step ③, you will return to the starting location, and continue recording. The musical data that is loop-recorded will be added to the previously-recorded data.
- ⑥ You can also erase specific data even while you continue loop recording. If you press the SEQUENCER [REC/WRITE] key during loop recording, all musical will be removed from the currently selected track as long as you continue pressing the key.

By checking the “Remove Data” check box you can erase only the specified data. During loop recording, press the note that you wish to delete, and only the data of that note number will be deleted from the keyboard as long as you continue pressing that note.

Similarly, bender data will be deleted as long as you tilt the joystick in the X (horizontal) direction, and after touch data will be deleted as long as you apply pressure to the keyboard.

When you are once again ready to record musical data, uncheck the “Remove Data” check box.

- ⑦ Press the SEQUENCER [START/STOP] key. Playback will end, and you will return to the recording start location that you specified in step ④. If Loop All Tracks is selected, normal playback will be looped as well.

#### • Multi (multitrack recording)

Multitrack recording allows you to simultaneously record onto multiple tracks, each with a different channel. This method can be used with overwrite, overdub, manual punch-in, and auto punch-in recording.

#### Using the arpeggiator to record multiple tracks simultaneously

A multi-track performance using the arpeggiator function can be recorded using multi recording.



When simultaneously recording multiple tracks using the RPPR function

You can use multitrack recording to simultaneously record the playback of multiple tracks that are being triggered by the RPPR function. For the procedure, refer to “Realtime-recording an RPPR performance” (☞p.56).

When simultaneously recording multiple tracks of MIDI data from an external sequencer.

- 1 **Make sure that the TRITON Extreme’s MIDI IN and the external sequencer’s MIDI OUT are connected by a MIDI cable.**

If they are not connected, turn off the power, make the connection, and then turn the power back on again. (☞PG p.288)

- 2 **Set the MIDI Clock (Global P1: MIDI page “MIDI Clock”) to External MIDI, so that TRITON Extreme will synchronize to the MIDI clock of the external sequencer.**

Make sure that “Receive Ext. Realtime Commands” is checked.

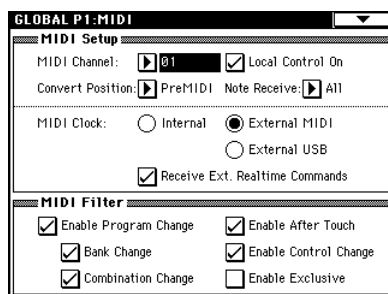

- 3 **Create a new song, and in the Sequencer P0: Play/REC, Preference page, check the “Multi REC” check box. Set the “Recording Mode” to Over Write.**

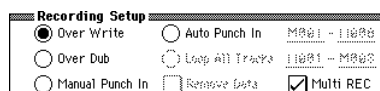

- 4 **Select the P0: Play/REC, Program T01–08/T09–16 page.**

For the tracks that you are not recording, set “PLAY/MUTE/REC” to PLAY or MUTE.

- 5 **In P2: Trk Param, MIDI Ch page “MIDI Channel,” specify the MIDI channel for each track.**

Set the MIDI channel of each external sequencer track to match the MIDI channel of each TRITON Extreme track. Data of the corresponding channel will be recorded on each TRITON Extreme track.

Make sure that “Status” is set either to INT or BTH.

- 6 **Press the [LOCATE] key to set the location to 001:01.000.**

- 7 **Press the SEQUENCER [REC/WRITE] key to enter recording-standby mode.**

- 8 **Start the external sequencer.**

The TRITON Extreme’s sequencer will receive the MIDI Start message transmitted by the external sequencer, and will automatically begin recording.

- 9 **When the song ends, stop the external sequencer.**

TRITON Extreme’s sequencer will receive the MIDI Stop message transmitted by the external sequencer, and will automatically stop recording. You can also press the SEQUENCER [START/STOP] key on TRITON Extreme itself to stop recording.

- 10 **Playback.**

In the Global P1: MIDI page, set “MIDI Clock” to Internal.

Set “Tempo Mode” to Auto.

When you press the SEQUENCER [START/STOP] key, playback will begin.

- note** If the correct sounds do not play immediately after playback is started, you may be able to solve the problem by using the page menu command “Event Edit” (Sequencer P5: Track Edit) to edit the Program Change data.

## Step recording

This is a method of recording where you specify the note timing, note length, and velocity etc. in the LCD screen, and use the keyboard to input the pitches. (☞QS p.27, PG p.78)

Only note-on/off data can be recorded with this method.

## Event Edit and Create Control Data

Note data is the only type of data that can be recorded in step recording. However there are ways to record other types of data, aside from the realtime mode. You can use the Event Edit and Create Control Data functions. Event Edit is intended as a way to edit previously-recorded data, but you can also use it to modify program numbers or insert control changes.

Create Control Data is a function that lets you create and insert controller data that changes smoothly between two specified values over the specified length of time. This is used to pitch bend, after touch, and control change data etc.

## Recording exclusive events

Exclusive messages received from an external MIDI device or the parameter changes produced when you edit a track parameter or effect parameter can be realtime-recorded on any track. You can adjust the realtime controllers, the arpeggiator, make changes to the program volume/pan/mute settings, and adjust the tone – all in realtime.

During playback, the exclusive messages you recorded will control the track parameters and effect parameters of the song, and can be sent to external MIDI devices.

**note** You can use the page menu command “Put Effect Setting to Track” to insert an exclusive event containing the parameter settings for an insert effect or master effect into the desired location of a track, so that these settings will automatically switch during playback.

GM, XG, and GS exclusive messages can be recorded on a track, but the TRITON Extreme’s tone generator will not respond to these messages.

## Recording internal parameter changes

As an example, here’s how to record internal parameter changes using the preset template song “Acid Jazz.”

In this example, we’ll use an empty track to record parameter changes for the insert effects (IFX1, IFX2) assigned to track 1 (drums).

In order to record system exclusive messages, the Global P1: MIDI, MIDI Filter setting “Enable Exclusive” must be checked. Go to Global mode and make sure that this parameter is checked.

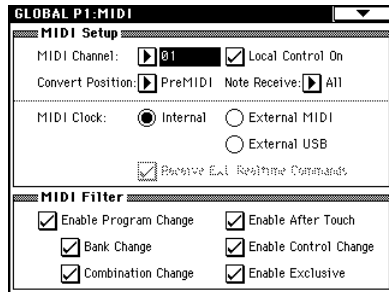

① Use the page menu command “Load Template Song” to load Acid Jazz. In the dialog box, check the “Copy Pattern to Track too?” setting, and copy a pattern of about 16 measures. (PG p.24)

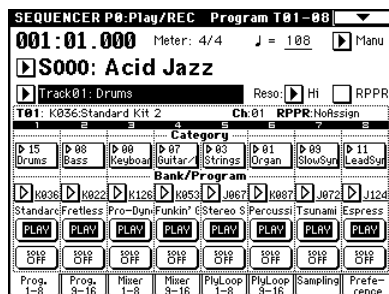

② Move to Sequencer mode, use “Track Select” to select Track 09, and begin recording. For this example, select an empty track.

**note** If you want to record onto a track that already contains data, set the “Recording Setup” parameter “Recording Mode” to Over Dub (PG p.43).

③ At the appropriate time while recording, adjust the parameter(s) that you want to realtime-record.

For example, you might use the Sequencer P8: Insert Effect, Insert FX page to adjust the IFX1 and IFX2 effects, or use the P5: Track Edit, Tone Adjust page to adjust the sounds in realtime.

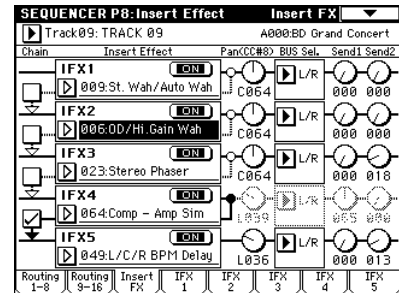

**note** For details on the parameters that you can realtime-record, refer to PG p.101.

④ Stop recording.

**note** Exclusive messages are always recorded on the current track selected by “Track Select.” In this example, they are recorded on track 9.

**note** In the event edit screen you can view the recorded exclusive events and their location. Exclusive events are displayed as “EXCL”.

To view these events, go to the Sequencer P5: Track Edit page, and select the page menu command “Event Edit.” Then in the Set Event Filters dialog box, check Exclusive and press the OK button.

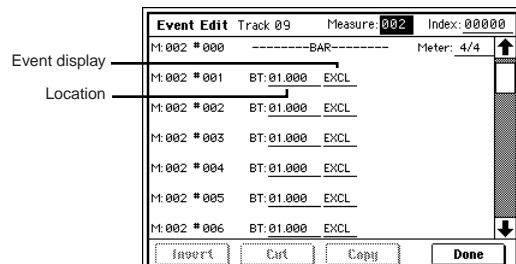

Exclusive events cannot be changed to a different type of event. Nor can other events be changed into exclusive events.

⑤ If you go to the page (e.g., Sequencer P8: Insert Effect) that shows the parameters you adjusted in realtime, you can watch the recorded changes be reproduced while the song plays back.

Exclusive messages that can be realtime-recorded  
The following exclusive messages can be realtime recorded.

- Exclusive messages received from an external MIDI device
- Parameter changes in Sequencer mode (PG p.101)
- Master Volume universal exclusive messages assigned to the foot pedal or a knob

### Using “Put Effect Setting to Track” to switch effects

The page menu command “Put Effect Setting to Track” places effect settings into a track as exclusive events. As an example, we will use the preset template song “Acid Jazz” to explain how to use the “Put Effect Setting to Track” page menu command. In this example we will switch the insert effect for Track 03: Elec.Piano from 023: Stereo Phaser to 020: Stereo Flanger at the beginning of measure 9. We will explain two ways in which you can do this: method 1) and method 2).

**⚠** This command works by inserting MIDI parameter change system exclusive messages directly into a sequencer track. Because this requires a number of messages to be read and processed, it can take a little time for the effect to change. You may find it necessary to “anticipate” where you want the effect change to take place and insert the change slightly earlier. Also, notes that are already sounding as the transition takes place may not play smoothly.

**⚠** Only effect type and effect parameter events can be inserted. You must use realtime recording to record effect on/off settings or bus settings.

#### 1. Inserting effect settings at the beginning of the song and at a specified measure

For the insert effect (IFX3) used by track 3, we will use 023: Stereo Phaser for measures 1 through 8 (as specified by the template song) and then switch to 020: Stereo Flanger for measures 9 and following by using the page menu command “Put Effect Setting to Track” to insert MIDI parameter change system exclusive messages.

- ① Enter Sequencer mode, and use “Song Select” to choose song S000.
- ② Use the page menu command “Load Template Song” to load Acid Jazz.

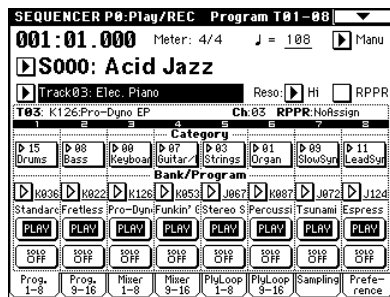

- ③ Use “Track Select” to select Track 03: Elec.Piano, and record a performance as desired. (☞ QS p.26)
- ④ In Sequencer P8: Insert Effect, choose page menu command “Put Effect Setting to Track” to open the dialog box.

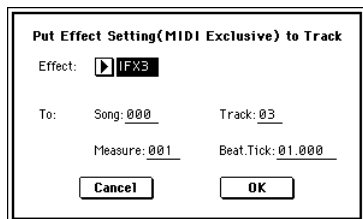

- ⑤ Specify the effect for which you will insert an exclusive message, and specify the location at which it will be inserted.

“Effect”: IFX3  
 To: “Song”: 000  
 “Track”: 03  
 “Measure”: 001  
 “Beat.Tick”: 01.000

- ⑥ Press the OK button.
- ⑦ Specify the effect that you will use for measure 9 and the measures that follow.

In the Sequencer P8: Insert Effect, Insert FX page, set IFX3 to 020: Stereo Flanger.

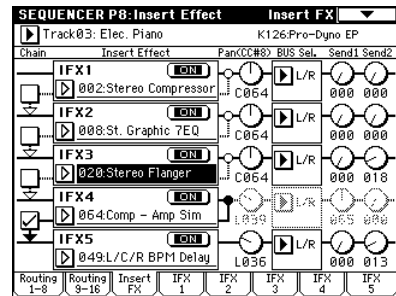

- ⑧ In the Sequencer P8: Insert Effect, IFX3 page, set the parameters as desired.

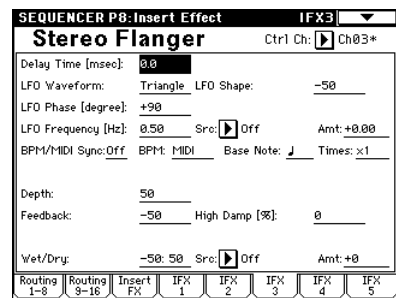

- ⑨ In the Sequencer P8: Insert effect, Insert FX page, choose the page menu command “Put Effect Setting to Track” to open the dialog box.

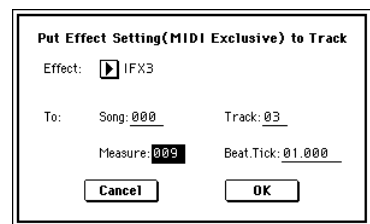

- ⑩ Specify the effect for which you will insert an exclusive message, and specify the location at which it will be inserted.

“Effect”: IFX3  
 To: “Song”: 000  
 “Track”: 03  
 “Measure”: 009  
 “Beat.Tick”: 01.000

- ⑪ Press the OK button.  
 Now when you play back the song, the track 3 effect will switch to 020: Stereo Flanger from measure 9.

- 12 If you press the [COMPARE] key (the key will light) and play back, you will hear the state of the track prior to executing “Put Effect Setting to Track.” Use the [COMPARE] key when you want to make a before-and-after comparison of the track.

- 13 In the Sequencer P5: Track Edit page, set “Track Select” to Track03. Then choose the page menu command “Event Edit” to access the event edit screen. (In the Set Event Filters dialog box, check the “Exclusive” setting.) Notice that a MIDI parameter change system exclusive message is inserted at the beginning and at measure 9 of track 3.

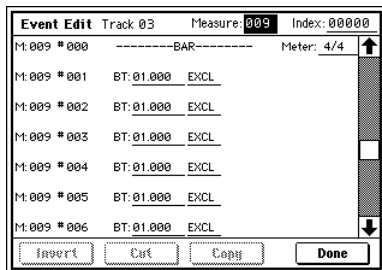
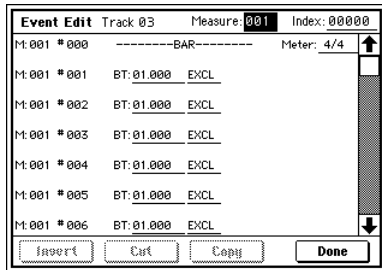

- 2. Using the effect specified by the song itself from the beginning of the song, and inserting the effect settings from another song at the middle of the song For the insert effect (IFX3) used by track 3, we will use 023: Stereo Phaser (specified by the template song) from the beginning of the song, and insert MIDI parameter change system exclusive messages at measure 9 to switch to the 020: Stereo Flanger settings from another song.

- 1 Enter Sequencer mode, and use “Song Select” to select song S000.
- 2 Use the page menu command “Load Template Song” to load Acid Jazz.

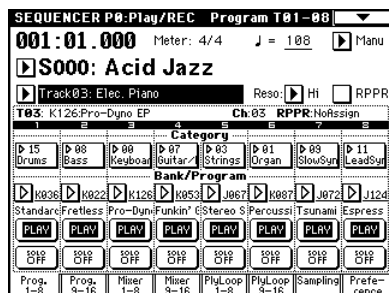

- 3 In “Track Select,” select Track 03: Elec.Piano, and record a performance as desired. (See QS p.26)
- 4 Make the effect settings for the second half of the song in another (copied) song.
  - 1) Create song S001.
  - 2) Use the page menu command “Copy From Song” to copy Song 000 as the copy-source. (See PG p.58 “Copy From Song”)
- 5 In song 001, make the effect settings that you want to use at measure 9. In the Sequencer P8: Insert Effect, Insert FX page, select 020: Stereo Flanger for IFX3.

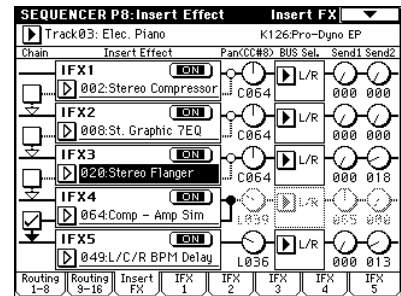

- 6 In the Sequencer P8: Insert Effect, IFX3 page, make the desired parameter settings.

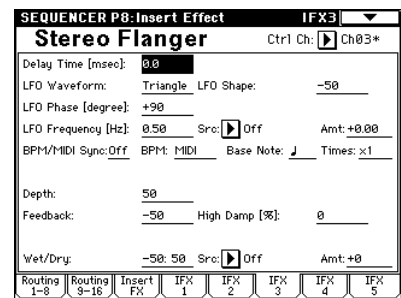

- 7 Choose “Put Effect Setting to Track” to open the dialog box.

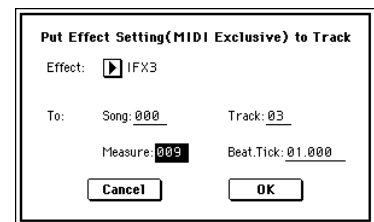

- 8 Insert the effect settings from song 001 into song 000.
  - “Effect”: IFX3
  - To: “Song”: 000
  - “Track”: 03
  - “Measure”: 009
  - “Beat.Tick”: 01.000

⑨ **Press the OK button.**

Now when you select song 000 and play it back, the track 3 effect will switch to 020: Stereo Flanger from measure 9.

⑩ **Using the [COMPARE] key, you can listen to the previous version, before you performed the “Put Effect Setting to Track” operation.**

**note** Processing the data placed in a track by the “Put Effect Setting to Track” command may take a little bit of time. As your song becomes filled with more and more data, it may take longer to complete the effect change. When listening to the playback in step ⑨, if you notice the effect change does not take place smoothly at the desired location, use the [COMPARE] key (lit) to return to the previous state and try the operation again. This time, change the “Beat.Tick:” settings so that the change takes place a little bit (40 - 100 “Ticks”) earlier or later in the song.

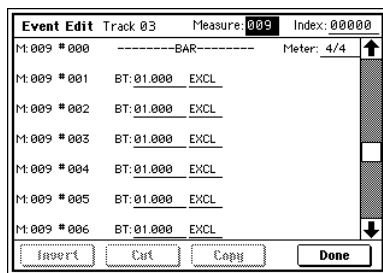

## Realtime-recording to a pattern

Here’s how you can use realtime recording to create a pattern. User patterns can be accessed by the RPPR function in the same way as preset patterns, and can be **copied** to or **placed** in a song. Playback data from a track can also be copied to a pattern.

When realtime-recording a pattern, a pattern of the specified number of measures will playback repeatedly, allowing you to continue adding musical data to it.

- ① **Create a new song, and as described in “Preparations for recording,” set the track to the program that will be used by the pattern.** (p.41)
- ② **Access the Sequencer P6: Pattern/RPPR, Pattern Edit page.**

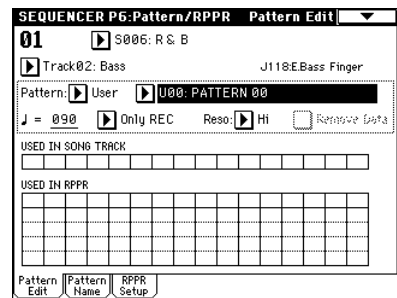

- ③ **Use “Track Select” to select the track that you will use to record the pattern.**  
The pattern will sound with the program and other settings of the selected track.
- ④ **Set “Pattern (Pattern Bank)” to User, and set “Pattern Select” to U00.**  
User patterns U00-U99 can be created for each song.
- ⑤ **Select the page menu command “Pattern Parameter”.**  
A dialog box will appear.

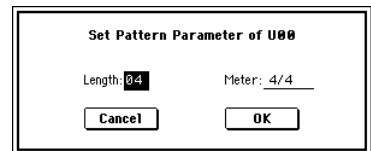

- ⑥ **Set the number of measures in the pattern to a “Length” of 04 (four measures), and set “Meter” to a time signature of 4/4. Press the OK button.**
- ⑦ **As necessary, set “Resolution” to apply realtime quantization.**
- ⑧ **Begin realtime recording.**  
You can record in the same way as you did when recording tracks with Loop All Tracks. (p.44)

**Press the SEQUENCER [REC/WRITE] key, and then press the SEQUENCER [START/STOP] key.**

After the pre-count, pattern recording will begin. Play the keyboard and operate the joystick and other controllers to record your performance.

When you reach the end of the pattern, the sequencer will return to the beginning of the pattern and continue recording. If you continue recording, the newly recorded data will be added to the previously-recorded data.

- ⑨ If you want to delete specific data while you continue pattern recording, you can press the SEQUENCER [REC/WRITE] key or check the “Remove Data” check box.

For details refer to step ⑥ of “Loop All Tracks” (p.44).

- ⑩ Press the SEQUENCER [START/STOP] key to stop recording.

If you made a mistake or decide to re-record, press the SEQUENCER [START/STOP] key to stop recording, and press the [COMPARE] key. Then begin the pattern recording procedure again as in step 8.

## Control data in pattern recording

To record control data in a pattern, you should restore the control data to its normal value within the pattern. If you fail to restore the normal value, unnecessary control data may remain in a “stuck” position when you place the pattern in a song or use the RPPR function to play the pattern. However, the following control data will be automatically reset to the following values when the song or RPPR function finishes playing the pattern, or when playback is halted.

Controller	Reset value
Modulation 1 (CC#01)	00 (zero)
Modulation 2 (CC#02)	00 (zero)
Expression (CC#11)	127 (max)
Ribbon controller (CC#16)	64 (center)
Damper switch (CC#64)	00 (zero)
Sostenuto switch (CC#66)	00 (zero)
Soft switch (CC#67)	00 (zero)
EG sustain level (CC#70)	64 (center)
Resonance level (CC#71)	64 (center)
EG release time (CC#72)	64 (center)
EG attack time (CC#73)	64 (center)
Low pass filter cutoff (CC#74)	64 (center)
EG decay time (CC#75)	64 (center)
LFO1 speed (CC#76)	64 (center)
LFO1 depth (pitch) (CC#77)	64 (center)
LFO1 delay (CC#78)	64 (center)
Filter EG intensity (CC#79)	64 (center)
SW1 modulation (CC#80)	00 (zero)
SW2 modulation (CC#81)	00 (zero)
Channel after touch	00 (zero)
Pitch bender	00 (zero)

## Using the arpeggiator for pattern recording

If the arpeggiator is set to operate for the track that is selected for “Track Select,” you can turn on the ARPEGGIATOR [ON/OFF] key and record the performance of the arpeggiator into the pattern.

For details on arpeggiator settings, refer to p.96 and PG p.93.

## Song editing methods

A variety of editing operations can be performed on a song.

### Song editing

In addition to copying and renaming a song, other operations such as Delete can be performed from the Utility menu commands in pages such as Sequencer P0: Play/REC (PG p.58).

### Track editing

You can move/insert/delete individual events of data such as the notes and control changes in a MIDI track, and copy/move/insert/delete specified measures or tracks. Use the Sequencer P5: Track Edit, Track Edit page menu commands to perform these editing operations. (PG p.79).

### Pattern editing

Using the page menu commands of the Sequencer P6: Pattern/RPPR, Pattern page, you can use event editing to modify the recorded data or insert new data, and execute commands to delete, copy, or bounce patterns (PG p.89).

**note** The explanations in the sections that follow are based on an example of editing a song. Create a song of several measures as described in QS p.24. We will describe various examples of editing operations on the song you create, and will then assemble songs in a cue list.

The subsequent explanation assumes that the song you created is loaded into S000.

## 1. Copying a song

Here’s how to copy a song. This is convenient when you want to create different variations based on a song.

- ① Create a new song.

Access the Sequencer P0: Play/REC, Program T01–08 page.

Choose “Song Select,” use the numeric keys to input the song number that you want to newly create, and press the [ENTER] key. (For example, press the [1] key and then the [ENTER] key.)

A dialog box will appear.



Decide on the number of measures, input the number in “Set Length,” and press the OK button.



A new song will be created. Next we will copy the song settings and playback data of another song into this newly created song.

- 2 Select the page menu command “Copy From Song.”



A dialog box will appear. Select the song that you want to copy (i.e., the copy source). If you select All, all song settings and playback data will be copied from that song. If you select Without Track/Pattern Events, settings other than Play Loop and RPPR will be copied. For this example, select All.

Press the OK button to execute the copy.

- 3 As described in steps 1 and 2, create one more new song (S002), and copy song S000 to it.

## 2. Naming a song

Here’s how to assign a name to a song you created.

- 1 Choose “Song Select,” to select a song. For this example, select song 002.
- 2 In the Sequencer P0: Play/REC, Program T01–08 page, select the page menu command “Rename Song.”

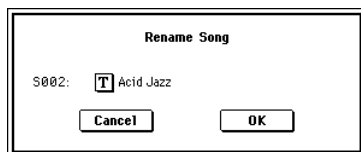

A dialog box will appear. Press the text edit button to access the text dialog box.

Press the Clear button, and input **CHORUS** (⌘p.115). When you are finished inputting the name, press the OK button.

Press the OK button once again to execute the Rename operation.

- 3 As described in steps 1 and 2, assign a name of **INTRO** to S000, and **VERSE** to S001.

## 3. Setting the number of measures in the song

Here’s how to specify the number of measures in the song. By default, this is set to **64 measures**. If you realtime-record for more measures than this, the song length will be the amount of measures you have recorded.

- 1 Select song **S000: INTRO**.
- 2 Select the Sequencer P5: Track Edit, Track Edit page. In the P5: Track Edit page, press the [MENU] key to access the page jump page. Press the P5: Track Edit.

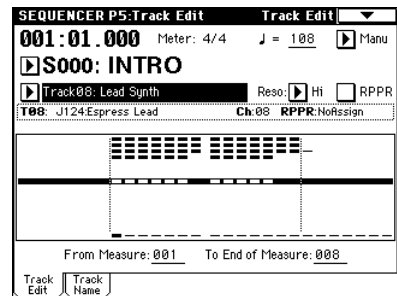

- 3 Access the page menu. This contains various commands for editing tracks and measures.

Press the “Set Song Length.”

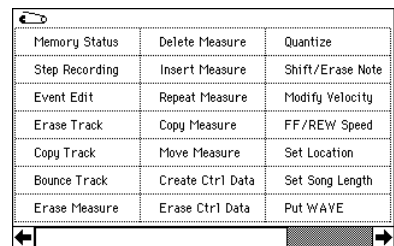

A dialog box will appear.



Input the number of measures for the song. For this example, select **008** (8 measures) and press the OK button.

The performance data from measures 1–8 will remain, and the data of subsequent measures will be deleted. When you press the SEQUENCER [START/STOP] key to play the song, playback will stop at the end of the 8th measure.

- ⚠ If you are using Track Play Loop, check whether the measures specified for “Loop Start Measure” and “Loop End Measure” would be deleted. If they would be deleted, use “Move Measure” (⌘PG p.83) etc. to move the data into the playback area before you execute this operation.

④ **Mute tracks.**

Press the [EXIT] key to select P0: Play/REC, and access the Program T01-08/T09-16 page. Mute all tracks other than tracks 3 and 4. When you play back, you will hear only the electric piano and guitar performances.

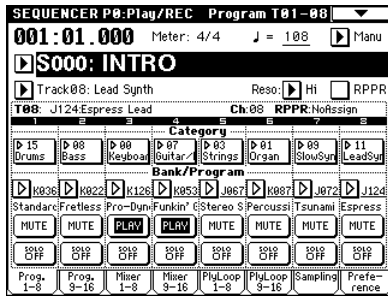

- ⑤ As described in steps ①-④, set song S001: VERSE to 008 (8 measures), making it an eight measure song. Then mute all tracks other than tracks 1-3. When you play back, you will hear only the drums, bass, and electric piano.
- ⑥ As described in steps ①-④, set song S002: CHORUS to 008 (8 measures), making it an eight measure song.

## 4. Changing the key (transposing/modulating)

Here's how to change the key of a song.

- ① Select song S002: CHORUS.
- ② Select the Sequencer P5: Track Edit page.
- ③ Use "Track Select" to select T02 as the track whose pitch will be changed.
- ④ Specify the measures for which the key will be changed. Select "From Measure," and use the VALUE controllers to set this to 001. Next select "To End of Measure," and specify 008.

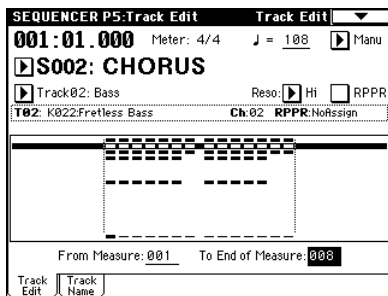

- ⑤ Select the page menu command "Shift/Erase Note." A dialog box will appear. If you did not specify the range of measures in step ④, set "From Measure" - "To Measure" to specify the range that will be edited.

Turn on the Replace radio button, and set "Shift Note" to +003. (PG p.84)

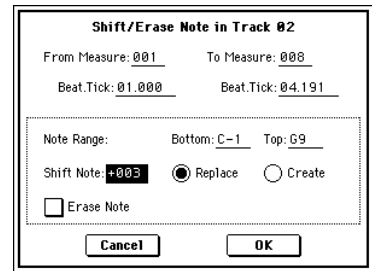

Press the OK button. The pitch of track 2 will be raised three semitones.

- ⑥ Use the same procedure to raise the pitch three semitones for each track on which performance data is recorded. However, do not change the key of track 1 which uses a drum kit.
- ⚠ If you change the key of a track that is using a drum kit, the relationship between the notes and the instruments of the drum kit will be shifted, and the sequence will not play the correct rhythm instruments.



# Creating and playing a Cue List

A cue list allows you to play multiple songs in succession. For example you can create a separate song for each portion (introduction, melody A, melody B, chorus, and ending) of a composition, and use the cue list to specify the order of each portion and the number of times that it will be repeated to complete the song. If you want to change the structure of the song, the cue list lets you do so in an efficient way.

You can also use this as a jukebox function that will play-back completed songs in the order you specify.

Step	Song	Repeat
01	S000: Intro	02
02	S001: A	02
03	S002: B	01
04	S003: Chorus	02
05	S001: A	02
06	S002: B	01
07	S003: Chorus	02
08	S001: A (Solo)	01
09	S003: Chorus	03
10	S004: Ending	02

Intro	Intro	A	A	B	Chorus
Chorus	A	A	B	Chorus	Chorus
A(Solo)	Chorus	Chorus	Chorus	Ending	Ending

## 1. Creating a cue list

Each unit in a cue list is called a “step,” and each step contains a song number and the number of repeats.

Here we will use a cue list to combine the previously-created songs S000: INTRO, S001: VERSE, and S002: CHORUS.

### ① Select Sequencer P1: Cue List.

With the default settings, song S000 will be selected for “Step” 01, and End will be selected for “Step” 02.

### ② Add a song to the Step area.

Select the “Song” for Step 02, and press the **Insert** button. A song will be added to step 02. Use the VALUE controller to select S001: VERSE.

In the same way, select the Step 03 “Song,” and press the **Insert** button to add a song to Step 03. Set this to S002: CHORUS.

If you press **Cut** button, the selected step will be deleted. If you press the **Insert** button, the deleted step will be inserted.

If you press the **Copy** button, the selected step will be copied. If you press the **Insert** button, the copied step will be inserted.

### ③ Set the last step to End.

If you set this to Continue to Step01, the cue list will play back repeatedly.

④ In “Repeat,” specify the number of times that the song for that step will be repeated. For this example, set Step 02 S001: VERSE to 02.

⑤ Specify whether effect settings will also be switched when the song at each step is played back. If you want to effect settings to change, check the “FX” check box.

For this example, check the “FX” check box for Step 01, which loads the effects.

⑥ To play back at the tempo that was specified for each song, set “Tempo Mode” to Auto.

If this is set to Manu (Manual), playback will use the tempo specified by “J =”.

⑦ When you press the SEQUENCER [START/STOP] key, playback will begin from the step that is specified as the “Current Step.”

• “Step”: The arrow will indicate the currently playing step. ▶ indicates the currently selected “Step.” If you set “Current Step” while stopped, the display will change.

• “M\*\*\*\*”: Indicates the starting measure of that step.

• “Meter”: Indicates the currently-playing time signature. This cannot be changed.

• The name of a cue list can be specified by the “Rename Cue List” page menu command.

• When you play the keyboard, the program of the track selected by “Track Select” will sound. If a different program is selected for each song, the program specified for the currently playing song will sound.

### ● What to do when playing back a cue list and the songs do not transition smoothly

If the effect settings differ between songs, and depending on the playback data within the song, there may be cases in which there is a time lag between songs during playback. Also, the playback data at the transition between songs may not play at the correct timing. In such cases, use “Convert to Song” to convert the cue list into a single song. When you play back this song, there will be no time lag at the transition, and the data will play at the correct timing.

If the effect settings differ between songs, and you want to smooth the transition between songs, check “FX” for Step 01. This way, the effect settings will be made before playback begins, and there will be no time lag when cue list

playback is started or when switching from song to song. Although it will not be possible to change effect types within the cue list, you can use dynamic modulation or MIDI control changes such as Effect Control to control the effects within the cue list, for example applying reverb more deeply on certain songs, or raising the LFO speed for a specific song. We recommend this method if you will be using a cue list to construct the song.

When you execute the page menu command “Convert to Song”, the effect settings of the “Step” 01 song will be specified for the song that results from the conversion.

Even if “FX” is not checked, there may be cases in which a time lag in the transition between songs, depending on the musical data of the song. Also, there may be cases in which the musical data is not played at the correct timing at the transition between songs. If this occurs, you can edit the musical data of the song, or convert the cue list to a song for playback. If you use “Convert to Song” to convert the cue list to a song, there will be no time lag during playback at the transition between songs, and the musical data will be played at the correct timing.

### ● Creating multiple songs for use in a cue list

If you want to create multiple songs for use in a cue list, it is a good idea to make the various necessary settings (program and other settings for each track, effect settings, etc.) for one song (e.g., S000), and then use the page menu command “Copy From Song” in SEQ 1.1 etc. to copy it to other songs so that the settings will be consistent.



After your cue list is finished and you convert it into a song, the track settings (program, pan, volume, etc.) of each step will be converted into playback data and will be reproduced, but if the MIDI channel settings from song to song do not match, it may not be possible to convert the playback state of the cue list into a song.

### ● Using a foot switch to switch the Step

You can use a foot switch to switch the Step. If you set “Repeat” to FS, a foot switch connected to the ASSIGNABLE SWITCH jack will control the timing at which the song stops repeating. Set “Foot Switch Assign” (Global P2: Controller page) to Cue Repeat Control.

## 2. Converting a cue list into a song

Although it is not possible to record additional material onto tracks in a cue list, you can convert a cue list to a song, and then record solos etc. on vacant tracks. You will also need to convert a cue list to a song if you wish to save it on a media as SMF data.

- ① **Select the page menu command “Convert to Song”.**  
A dialog box will appear.
- ② **In “To Song,” specify the destination song number for the converted data.**

The cue list name will automatically be assigned as the song name of the converted data. (For details and cautions regarding “Convert to Song,” refer to PG p.70.)

If you select a new song as the conversion destination, it is not necessary to specify “Set Length” in the dialog box that appears. The number of measures in the converted song will be used. Press the OK button, and the Convert Cue List dialog box will appear.

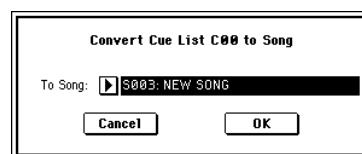

- ③ **Press the OK button.**

The cue list will be converted into a song. Access the P0: Play/REC page, select the song number that you specified as the conversion destination, and check the results.

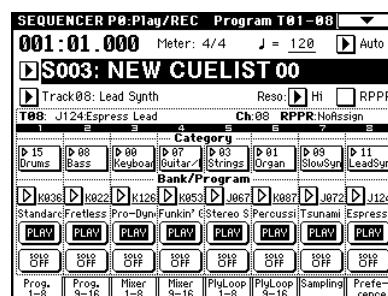

## Creating and recording RPPR (Realtime Pattern Play/Record)

This section explains how to assign a pattern to RPPR, and how to play and record. (☞ QS p.3 “Performing with the RPPR function”)

### Creating RPPR data

- ① Create a new song. (☞ p.50)
- ② Specify the program for each track.  
For this example we will use a template song. Use the Utility menu command “Load Template Song” to load P14: Hip Hop/Rap. It is not necessary to copy the patterns. (☞ QS p.24)
- ③ Select the Sequencer P6: Pattern/RPPR, RPPR Setup page.  
In this page, the RPPR function is automatically turned on.

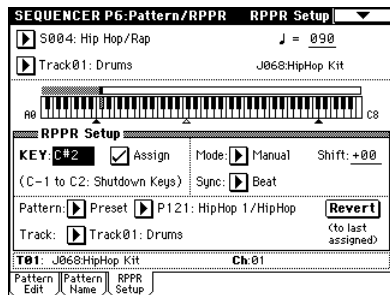

- ④ Use “KEY” to select the key to which the pattern will be assigned.  
Select C#2. This can also be selected by holding down the [ENTER] key and playing a note.  
C2 and lower keys are used to stop playback, and cannot be assigned.
- ⑤ Check the “Assign” check box.
- ⑥ Set Pattern Bank to the Preset pattern type, and set “Pattern Select” to pattern P121: HipHop 1/HipHop.
- ⑦ Set “Track” to Track01: Drums.  
The selected pattern will be played according to the settings (program, etc.) of the track you select here.
- ⑧ Assign patterns to other keys.  
For “KEY,” press the [△] key to select D2. Press the Revert button.  
The settings for “Assign,” “Pattern (Pattern Bank),” “Pattern Select,” and “Track” will be set to the values that were specified earlier (in steps ⑤–⑦).

Choose “Pattern Select,” and press the [△] key to select P122: HipHop 2/HipHop.

**note** By using “Revert” in this way, you can work efficiently when the patterns to be assigned have consecutive or nearby numbers, or use the same track.

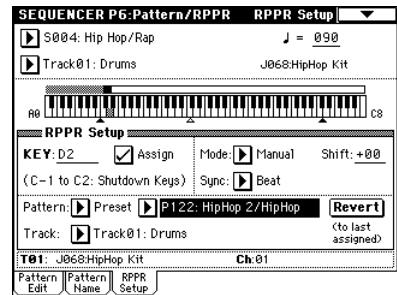

Use the above method to assign several patterns from the range of P123: HipHop 3/HipHop–P135: HipHop 15/HipHop.

- ⑨ Press the C#2 key.  
The assigned pattern will play.

Take your finger off the C#2 key, and press the D2 key.  
The pattern will change, and playback will begin. At this time, the pattern operation will depend on the “Sync” and “Mode” setting.

Set “KEY” to C#2, and set “Sync” to Measure. Make the same setting for D2.

Now press the notes consecutively. Notice that the patterns operate in a different way.

With the “Measure” setting, patterns will be handled in one-measure units. The second and subsequent patterns will start in sync with the end of previously played pattern.

If you change the “Mode” setting to Once, the entire pattern will playback to the end even if you release your finger from the keyboard immediately.

**note** To stop playback, either press the same key once again, or press the C2 or lower key.

For details on “Sync,” “Mode,” and “Shift,” refer to PG p.92.

The assigned keys will be shown as a keyboard graphic in the LCD screen.

**note** Unassigned keys can be used for normal keyboard performance. Use “Track Select” to select the track that will be played from the keyboard. For example you might assign backing patterns such as drums and bass to the C#2–B2 keys and use these keys to control pattern playback, and use keys C3 and above to play solos in realtime. It is a good idea to keep the assigned keys together in this way.

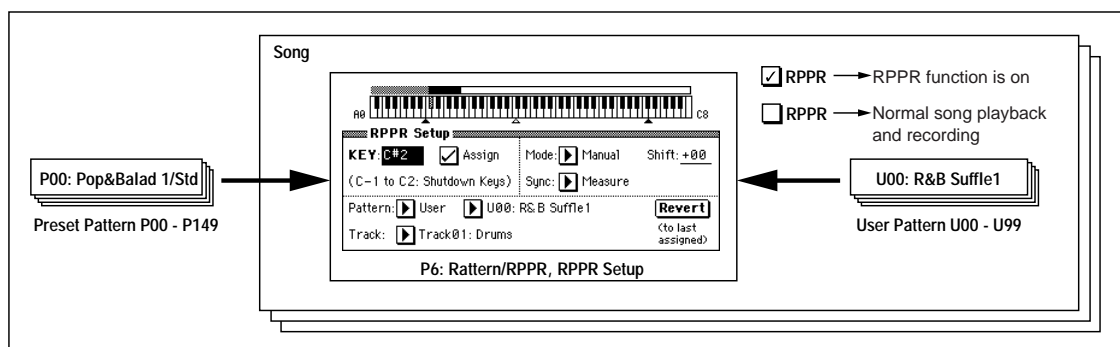

## RPPR playback

Let's use the RPPR you created to perform in the Sequencer P0: Play/REC page.

- 1 Select Sequencer P0: Play/REC.
- 2 Check the "RPPR" check box.  
The RPPR function will be turned on. Set the on/off for each song.

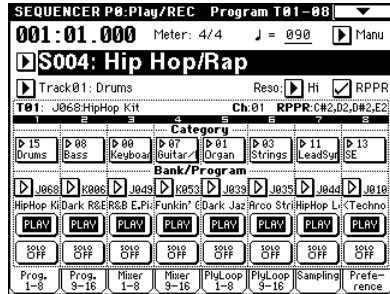

- 3 Play the keyboard, and patterns will begin playing according to the RPPR settings.
  - Pattern playback for a key with a "Sync" setting of Beat or Measure will sync to the playback of the first pattern. (PG p.92 "Sync")
  - If you are playing the pattern in synchronization (when "Sync" is Beat, Measure, or SEQ), the pattern will start accurately if you play the note slightly earlier than the timing of the beat or measure. Even if you play the note slightly later than the beat or measure (but no later than a 32nd note), it will be considered to have started at the beat or measure, and the beginning of the pattern will be compressed so that the remainder of the playback will be correct.

**MIDI** If you wish to trigger the RPPR function from an external MIDI device, use the MIDI channel that is selected for "Track Select."

- 4 To turn off the RPPR function, uncheck the RPPR check box.

### Play RPPR while a song plays back

RPPR can be played in synchronization with the playback of a song.

Pattern playback for a key with a "Sync" setting of SEQ will synchronize to the playback of the song. (PG p.92 "Sync")

Start the song playback, and then press the key. The pattern playback will start in synchronization with the measures of the song.

**⚠** Synchronization will be lost if you use the [REW] or [FF] keys while a song is playing.

**note** If you want RPPR pattern playback to begin at the moment that song playback begins, it is a good idea to insert an empty measure containing no musical data before the song playback begins.

**note** If the song is stopped, the pattern will synchronize to the timing of the arpeggiator function.

## Realtime-recording an RPPR performance

An RPPR performance can be recorded in realtime. If you are using only one track (Track01: Drums) as in "Creating and recording RPPR" (p.55), set "Track Select" to Track01: Drums, and use single track recording in which only one track will be recorded.

Even if RPPR uses only one track, use multi-track recording if you will be selecting another track in "Track Select" and recording its performance at the same time. You should also select multi-track recording if you created the RPPR data using multiple tracks rather than just a single track, and want to simultaneously record the performance of multiple tracks.

**note** The RPPR pattern will be recorded as performance data on the tracks used by the pattern.

Here we will explain how you can simultaneously record a performance that uses both RPPR and the arpeggiator.

- 1 For each RPPR pattern, set "Sync" to SEQ.  
With a setting of SEQ, patterns played by the RPPR function while the sequencer is playing or recording will start in synchronization with the measures of the sequencer.

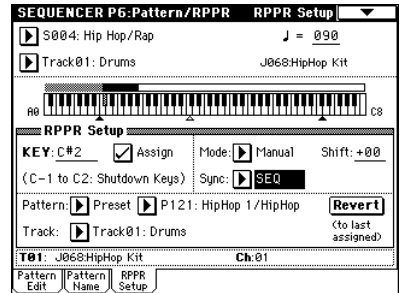

- 2 We will use the arpeggiator to play the bass pattern. Follow these settings.

Set "Track Select" to Track02: Bass. Select the Sequencer P7: Arpeggiator, Setup T01-08 page, and set the track 2 "Arpeggiator Assign" to A. (Make sure that A is checked for "Arpeggiator Run.")



Select the Sequencer P7: Arpeggiator, Arpeggiator A page, and set "Pattern" to U038 (A/B).



Set “Gate” and “Velocity” to Step.

Do not check “Key Sync.”

Press the ARPEGGIATOR [ON/OFF] key. (The key will light.)

- ③ In the Sequencer P0: Play/REC, Preference page, check the “Multi REC” check box.



If “Recording Mode” is set to Loop All Tracks,” it will not be possible to select Multi REC. Set the “Recording Mode” to Over Write.

- ④ Select the P0: Play/REC, Program T01–08 page.  
For all tracks, the “PLAY/MUTE/REC” indication will show REC.  
The track played by RPPR will be recorded simultaneously with the track played by the arpeggiator. Set “PLAY/MUTE/REC” to PLAY or MUTE for all tracks other than tracks 1 and 2, which we will be recording.  
Make sure that “Track Select” is set to Track02: Bass.  
Your keyboard playing on keys not assigned to the RPPR function can be recorded on the track specified by “Track Select.”

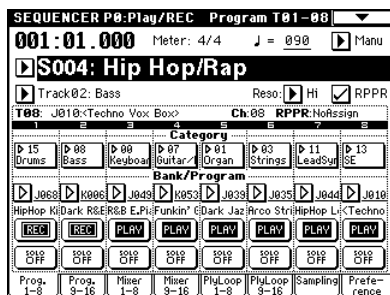

- ⑤ Make sure that the “RPPR” check box is checked.
- ⑥ Press the [LOCATE] key to set the location to 001:01.000.
- ⑦ Press the SEQUENCER [REC/WRITE] key, and then press the SEQUENCER [START/STOP] key.

Press a key that plays an RPPR pattern, and one or more keys that play the arpeggiator.

If you press a key during the pre-count before recording, the pattern playback and arpeggio performance will begin simultaneously when recording begins, and will be recorded.

Record the RPPR pattern playback and arpeggio performance.

- ⚠ When recording the playback of patterns triggered by RPPR, the timing of the recorded events may be slightly skewed. If this occurs, try setting “Reso” (Realtime Quantize Resolution) to a setting other than Hi.

- ⑧ When you are finished performing, press the SEQUENCER [START/STOP] key.  
Recording will end, and the sequencer will return to the location at which recording began.  
If you made a mistake during your performance or would like to re-record, you can use the Compare function (press the [COMPARE] key) to re-record as many times as you wish.
- ⑨ If you want to record other tracks, un-check the “Multi REC” or “RPPR” check boxes as necessary.  
In step ③, uncheck the “Multi REC” check box to defeat multi-track recording.  
In step ⑤, uncheck the “RPPR” check box to turn off the RPPR function.

## Recording the sound of a combination or program

Here's how you can easily copy the settings of a combination or program, and then record.

There are two ways to do this. While playing in Program or Combination mode, you can use the Auto Song Setup function to automatically set up a song using the current settings of the program or combination. Or, you can use the page menu command in Sequencer mode to copy the settings of a program or combination create the sequencer setup.

### Auto Song Setup function

The explanation of the Auto Song Setup function given here follows the procedure from Combination mode.

- 1 Enter Combination mode.

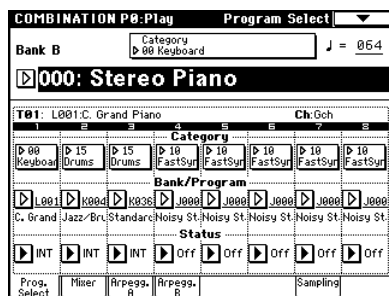

- 2 If you change any of the settings in the combination. Such as volume, panning, effect routings and arpeggiator setting (including Arpeggiator On/Off) you must first save the edited settings using "Update Combination" or "Write Combination."

- 3 The combination (or program) must be saved with the Arpeggiator On/Off set to On in order for the "Auto Adjust Arp settings for Multi REC" (see step 4) to work properly.

- 3 Hold down the [ENTER] key and press the SEQUENCER [REC/WRITE] key. The "Setup to Record" dialog box will appear.



- 4 Press the OK button to perform the Auto Song Setup. The TRITON Extreme will automatically switch to Sequencer mode, and the combination's settings will be applied to a new song. The new song will be the first unused song.
- 5 You will automatically enter record-ready mode, and the metronome will begin sounding according to the settings in Sequencer mode 0-8: Preference. (PG p.68 "0-8b: Metronome Setup")
- 6 Press the [START/STOP] key, and realtime recording will begin.

When you're finished recording, press the [START/STOP] key once again.

(PG p.43 "Realtime recording on a MIDI track")

Settings that are automatically copied from the combination  
The settings that will be automatically copied will be the same settings as if you had executed the page menu command "Copy From Combi" (PG p.58) and had made the following settings in the dialog box.

- "with Effects" checked
- "To" set to Track 1 to 8
- "Auto Adjust Arp setting for Multi REC" checked

Settings that are automatically copied from the program  
The settings that will be automatically copied will be the same settings as if you had executed the page menu command "Copy From Program" (PG p.39) and had made the following settings in the dialog box.

- "with Effects" checked
- "with Arpeggiator" checked
- "To" set to Track 01
- "Arpeggiator" set to A

### Copy From Program/Copy From Combi (Sequencer mode page menu commands)

Here's how to use the Copy From Program/Copy From Combi page menu commands in Sequencer mode.

**note** Make sure that the global MIDI channel (Global P1: MIDI, "MIDI Channel") is set to 01.

- 1 Create a new song. (PG p.50)



- 2 Execute the page menu command "Copy From Program" or "Copy From Combi." A dialog box will appear.

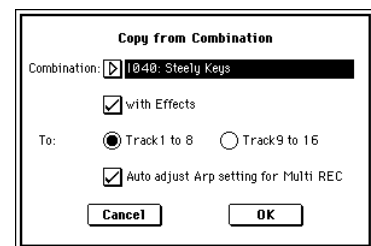

Select the program or combination that you want to copy (i.e., the copy source).

For this example, press the COMBI BANK [I] key, then press numeric keys [4], [0], and finally press the [ENTER] key. I040: Steely Keys will be selected. We will copy the effect settings of the combination as well, so check the "With Effects" check box.

Since we want to copy the settings of the combination's eight timbres to tracks 1-8, select **Track 1 to 8**.

If you have selected Track 1 to 8, you will be able to select "Auto adjust Arp setting for Multi REC." If you check this check box, the MIDI channel etc. of some of the tracks will automatically be adjusted to ensure that the same sound as was used during recording will be reproduced by the playback when you perform multi-track recording with the arpeggiator turned on.

⚡ When using the “Copy From Program” page menu command, the dialog box will be different. You can specify any track as the copy destination, and “Auto adjust Arp setting for Multi REC” will be replaced by a simple “with Arpeggiator” check-box.

⚡ Depending on the combination settings, it may be necessary to make additional changes to the track settings.

**note** In order to use the “Auto adjust Arp setting for Multi REC” function, the combination to be copied must have been written to memory with the ARPEGGIATOR [ON/OFF] key turned on.

**Press the OK button to execute the copy.**

Notice that when you execute this command, the “PLAY/REC/MUTE” setting of each track will be set automatically.

In the Sequencer P0: Play/REC, Preference page, the “Multi REC” check box will be checked.



If you are using the arpeggiator, press the ARPEGGIATOR [ON/OFF] key to turn it off, and then turn it on again.

③ **Begin recording.**

**Press the [LOCATE] key to set the location to 001:01.000.**

**Press the SEQUENCER [REC/WRITE] key, and then press the SEQUENCER [START/STOP] key.**

If you play a B3 note or lower during the pre-count before recording, the arpeggio pattern will start from the beginning at the moment that recording begins. Record your performance.

④ **When you are finished performing, press the SEQUENCER [START/STOP] key.**

If you made a mistake or want to re-record, you can use the Compare function (press the [COMPARE] key) to re-record as many times as you want. (The “Multi-REC” check box will be unchecked when you use Compare, so you will need to check it again.)

## Caution and other functions in Sequencer mode

### TRITON Extreme song data and its compatibility

The following two types of song data can be loaded from Media into TRITON Extreme’s sequencer.

• **Song data saved in TRITON Extreme’s own format**  
This data is only for this instrument.

However, it is partially compatible with the TRITON STUDIO, TRITON-Rack and TRITON/TRITONpro/TRITONproX (see PG p.309).

Since the performance will be faithfully reproduced, including detailed settings of this instrument, you should use this format to save song data that is intended for playback on this instrument.

• **Standard MIDI Files**

This format is not able to provide a totally faithful reproduction of the performance on TRITON Extreme in the way that TRITON Extreme’s own format does (although there will be no problem for normal playback), but does provide compatibility with other SMF-compatible devices.

To load or save song data etc., use Media mode. (see p.117, 121, PG p.181, 189)

• **Data including exclusive events**

Exclusive messages (including XG or GS data) received from an external MIDI device, and parameter changes produced by editing track parameters (see PG p.101) can now be recorded in realtime on the desired track. You can also use the page menu command “Put Effect Setting to Track” to place insert effect or master effect parameter settings as exclusive events in the desired location of a track.

⚡ Recorded GM, XG, or GS exclusive messages do not affect the TRITON Extreme when they are played back.

Since the recorded data is embedded in the song data as exclusive events, it can be saved or loaded to/from media in the same way as before. Exclusive messages can also be saved and loaded as SMF (Standard MIDI File) data (“Load Standard MIDI File,” “Save Song as Standard MIDI File”). This means that you can save recorded exclusive events as SMF data, or convert exclusive messages from an SMF file into song data.

## The Compare function

When you perform realtime recording, step recording, or track editing, this function allows you to make before-and-after comparisons.

- ⚡ If you continue editing when the [COMPARE] key is lit, the key will go dark. This now becomes the musical data that will be selected when the [COMPARE] key is dark. Any previous unsaved edits will be lost.

### Operations for which Compare is available

- **Recording to a track**
- **Track Edit**  
All commands except for the Utility menu commands “Memory Status” and “Rename Track” of the Sequencer P5: Track Edit page.
- **Recording to a pattern**
- **Pattern Edit**  
All commands except for the page menu commands “Memory Status,” “Rename Pattern,” “FF/REW Speed,” and “Rename Track” of the Pattern/Sequencer P6: RPPR, Pattern Edit page.
- **Song Edit**  
Sequencer P0–P4 and P7–P9 pages: Page menu commands “Delete Song” and “Copy From Song”  
Sequencer P1: Cue List page: Page menu commands “Convert to Song” and “Copy Song”
- **After in-track sampling**  
The Compare operation will also apply to the multi-samples and samples that were sampled with the “Convert to” item Seq.Event checked in “Select Bank & Sample No.” (PG p.63). This means that if you want to re-do your sampling, you can press the [COMPARE] key to return the multisample and samples to the state prior to sampling, and unwanted samples will not remain.

- ⚡ The program will not be affected by the Compare, and will not return to its prior state.

In general, track and pattern event data can not be returned to its original state.

Comparing song parameters is possible only during song editing (when executing a page menu command).

### Operations for which Compare is not available

- **Editing song parameters**
- **Page menu commands other than those listed above (in Operations for which Compare is available)**

## Memory Protect

Before you record a track or pattern, or edit the musical data, you will need to turn off the memory protect setting in Global mode. (PG p.90)

## About MIDI

### Track status “status”

You can specify whether the TRITON Extreme’s sequencer will sound the internal tone generator or an external tone generator.

When Track Status “**Status**” (P2: Trk Param, MIDI Ch T01–08/T09–16) is set to **INT**, operating TRITON Extreme’s keyboard and controllers will sound and control TRITON Extreme’s own tone generator.

When “**Status**” is set to **EXT**, **EX2** or **BTH**, operating TRITON Extreme’s keyboard and controllers will sound and control the external tone generator. (The MIDI channel of the external tone generator must match the “MIDI Channel” of the track that is set to EXT, EX2 or BTH.) With a setting of BTH, both the external tone generator and TRITON Extreme’s tone generator will sound and be controlled.

1	2	3	4	5	6	7	8
Drums	Bass	Keyboard	Guitar/Pi	SlowSyn	Guitar/Pi	Guitar/Pi	Strings
Status							
▶ INT	▶ INT	▶ INT	▶ INT	▶ EXT	▶ EX2	▶ BTH	▶ INT
MIDI Channel							
01	02	03	04	05	06	07	08
Bank Select (When Status=EX2)							
Ⓜ	Ⓜ	Ⓜ	Ⓜ	Ⓜ	000	Ⓜ	Ⓜ

If you wish to use the Sequencer mode of the instrument as a 16-track multi-timbral tone generator, select INT or BTH. (PG p.72)

### Synchronizing the sequencer with an external MIDI device

The record/playback tempo of TRITON Extreme’s sequencer can be synchronized to an external MIDI device such as a sequencer or rhythm machine (PG p.296).



# Sampling (Open Sampling System)

## Features of sampling on the TRITON Extreme

- The TRITON Extreme features our **Open Sampling System** that lets you use sampling/resampling not only in Sampling mode but also in Program, Combination, and Sequencer modes, with functionality optimized for the specific mode that you are currently in.
- You can perform 48 kHz 16-bit linear mono or stereo sampling.
- The TRITON Extreme is shipped with 16 Mbytes of sample memory (RAM). When you sample, the data is written into this sample memory (RAM) or to media. (For details on the types of media you can use, refer to p.137.)

The 16 Mbyte **sample memory (RAM)** allows approximately 2 minutes 54 seconds of mono sampling (or approximately 1 minute 27 seconds of stereo sampling). By installing 72-pin SIMM boards, you can expand sample memory to a maximum of 96 Mbytes (three 32 Mbyte SIMM boards; replacing the factory-installed 16 Mbyte SIMM with a 32 Mbyte SIMM). With the sample memory maxed out, the total sampling time is 17 minutes 28 seconds of mono sampling (approximately 8 minutes 44 seconds in stereo). However, because the TRITON Extreme RAM is addressed as six individual 16 Mbyte banks, the maximum length for any individual sample remains approximately 2 minutes 54 seconds (mono) or approximately 1 minute 27 seconds (stereo). Samples you record into sample memory (RAM) can be used as tone generator waveforms. However, this data will be lost when the TRITON Extreme's power is turned off, so you must save any sample data that you want to keep.

The **Media** lets you record up to 80 minutes as a single sample file in either mono or stereo (monaural: approximately 440 Mbytes, stereo: approximately 879 Mbytes). This will create a WAVE file.

If a sample (WAVE file) that was sampled to the media is loaded into sample memory (RAM), it can be used as a tone generator waveform. A sample (WAVE file) of up to 16 Mbytes (mono) or 32 Mbytes (stereo) (if sample memory has been expanded to 32 Mbytes or greater) can be loaded into sample memory (RAM).

You can create an audio CD by writing Wave files to a CD-R/RW drive connected to the USB A connector.

- A maximum of 1,000 multisamples and 4,000 samples can be created.
- In Media mode, you can load multisample/sample data from various types of media.
- Korg format or Akai (S1000/3000 samples, mapped multisamples only) format sample data, and AIFF or WAVE format sample data can be loaded. (Once data has been loaded into the TRITON Extreme, it will all be treated as Korg format sample data.)

Sample data created on the TRITON Extreme can be exported (output) as an AIFF or WAVE format sample file.

- The external audio source that you are sampling can be processed by the five insertion effect to apply effects such as a compressor or EQ. The LFO frequency or delay time of the effect can be specified as a BPM value, which is highly effective when sampling phrase loops etc. (In Sampling mode, only the insert effects can be used. In Program, Combination, and Sequencer modes, the master effects can also be used.)
- You can apply Valve Force to the external audio source you are sampling.
- Sampling can be initiated by the SAMPLING [START/STOP] key, note-on, threshold, or the SEQUENCER [START/STOP] key. (The available methods will depend on the mode.) Threshold allows you to initiate sampling when the input signal exceeds the threshold level you specify. In Sampling mode, you can also specify a pre-trigger setting.
- The analog audio inputs support mic and line level signals. Digital audio input via S/P DIF IN supports the 48 kHz sample rate.
- You can digitally sample (i.e., "rip") audio data from an audio CD in a CD-R/RW drive connected to the USB A connector.
- Sampled data can be converted automatically (or manually, using an easy operation) into a program and used with the TRITON Extreme's HI synthesis system. (In Sampling mode, use "Convert MS To Program." In Program, Combination, or Sequencer mode, use "Select Bank & Smp No.") Once a multisample/sample has been converted into a program, you can make filter, amp, and effect settings and play it as a program. Such a program can also be used in Combination mode or Sequencer mode. Samples you record can also be used as drum samples in a drum kit.

### Sampling in Program, Combination, and Sequencer modes

- A performance in Program, Combination, or Sequencer modes can be resampled internally, with all audio remaining in digital form. This lets you resample a performance that uses the TRITON Extreme's filters, effects, arpeggiator, and sequencer etc.
- External audio sources from the various input jacks can be sampled. A performance played on the TRITON Extreme can be mixed with the external audio source and sampled, or you can sample just the external audio source while monitoring the performance played on the TRITON Extreme. The master effects can also be applied to the signal being sampled.
- In Sequencer mode when you sample an external audio source while listening to the playback of the song, note data will be automatically created in the track. This "In-Track Sampling" function lets you sample vocals or guitar while you play the sequencer – just as if you were recording on a multi-track recorder.
- Song playback in Sequencer mode can be resampled to media. You can use Media mode to edit the song order, and burn your songs to an audio CD in a CD-R/RW drive connected to the USB A connector.

## Editing in Sampling mode

- In Sampling mode, the sample data you sampled or loaded from various media (including WAVE and AIFF formats) can be assigned to an index (zone) to create a multisample.
- The waveform can be viewed in the LCD screen, and edited by a variety of waveform editing commands that include rate convert (down-sampling) and reverse playback.
- Start, loop start, and end addresses can be specified in units of a single sample. Loop tune, reverse playback, and loop lock functions are also supported.
- The **Use Zero** function automatically searches for zero-cross points, making it easy to find the beginning or end of the waveform, or locations that will not produce noise when the sample is played back.
- The grid function displays a BPM-based grid on the waveform display, helping you to create loops or make waveform edits that match the desired BPM.
- Each multisample allows you to create up to 128 indices. Each index consists of a sample assignment, a key zone, an original key, a playback pitch, and settings such as level.
- The “Keyboard & Index” display lets you edit a multisample while viewing the assignments and zones of each sample.
- Sample names and multisample names of up to 16 characters can be assigned. Sample names and multisample names can also be viewed in Media mode (PG p.177 “Translation”).
- The **Time Slice** function automatically detects the attack portions of a kick or snare etc. in a rhythm loop sample (a looped pattern of drums etc.), and divides it into separate rhythm instrument sounds. A pattern corresponding to the divided samples is created automatically, so that you can immediately use the Sequencer mode RPPR function to play the pattern and adjust the tempo without changing the pitch. You can also do things such as adjusting the pitch of only the snare, replacing it with a different sample, or changing the playback timing on the sequencer, in this way creating a new rhythm loop based on the rhythm loop you started with. (Stereo samples are supported.)
- The **Time Stretch** function lets you modify the tempo without changing the pitch of a sample. You can select either Sustaining (suitable for sustain-type instruments such as strings or vocals), or Slice (suitable for rhythm loops on decay-type instruments such as drums). Stereo samples are supported.
- The **Crossfade Loop** function is an important looping tool that helps smooth out irregularities in long loops which contain complex material. By executing Crossfade Loop, you can eliminate this problem and create natural-sounding loops.
- The **Link** (with Crossfade) function allows you to join two samples into a single sample. You can also crossfade the overlapping portion of the samples at this time, so that the volume changes gradually, producing a natural-sounding transition.
- The BPM Adjust function (playback pitch adjust) lets you adjust the playback pitch of each index so that the loop frequency matches the desired BPM value.
- You can use resampling (auto) to automatically apply effects to a sample and create a new sample.

## How Sampling mode is organized

This section describes how sampling on the TRITON Extreme is organized. (See the lower diagram on the following page)

### Sampling frequency and bit resolution

As shown in the diagram, sampling reads the level of the analog signal at fixed intervals along the time axis, and stores the levels in memory as digital data.

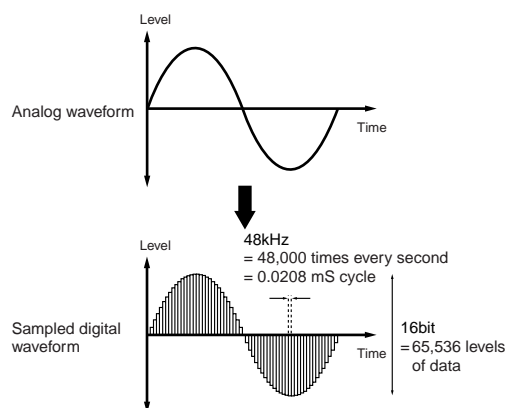

The “fixed intervals” mentioned above are generally expressed as the “sampling frequency.” 48 kHz (kilohertz) means that sampling is performed 48,000 times each second, and that the interval is  $1 \text{ (second)} / 48,000 \text{ (times)} =$  approximately 0.00002083 (seconds) = approximately 0.02083 mS (millisecond).

The higher the sampling frequency is, the closer to the original analog signal the waveform in memory will be.

Each level is read, and converted into digital data. The accuracy at this time is determined by the bit resolution. This process converts an analog signal with infinite resolution into a digital signal with finite resolution. With 16 bit resolution, each level is indicated in 65,536 steps (the sixteenth power of two).

The greater the bit resolution is, the closer to the original analog signal the waveform in memory will be.

48 kHz 16 bit sampling is the same quality as in audio devices such as DAT. A CD uses 44.1 kHz 16 bit sampling, which is a slightly lower sampling frequency.

# Samples and Multisamples

## Samples

The data that is recorded (sampled) into internal memory or loaded from a file is referred to as a sample or sample file. Samples consist of the actual waveform data, and parameters that specify how the data will be played back, such as Start, Loop Start, and End Address. Samples can be used in multisamples and drum kits.

The TRITON Extreme can hold a maximum of 4,000 samples in its internal memory.

**note** The TRITON Extreme can share a single waveform among multiple samples. This allows you to create multiple samples with different playback addresses from the same waveform without wasting internal memory. For example, suppose that you have waveform data that records a voice saying “One-Two-Three.” This single piece of waveform data could be shared by three samples, with the playback of sample A producing “One-Two-Three,” sample B producing “One-Two,” and sample C producing “Two-Three.” (PG p.108).

## Multisamples

A multisample consists of settings that make one or more samples sound in different areas of the keyboard. A multisample consists of between one and 128 “indexes.” Each index contains parameters that specify the sample that will playback, the zone in which it will playback, the original pitch key, the playback pitch, and level etc.

### Using multisamples

When sampling an instrument that is able to produce a wide range of pitches, such as a piano, recording just one sample and applying it (playing it back) over the entire pitch range will not produce a natural-sounding result. By using a multisample you can record separate samples for each pitch range, and assign these samples to their respec-

tive pitch ranges to avoid any unnatural sounds during playback.

All of the instrumental sounds in the TRITON Extreme’s internal preset ROM multisamples are constructed in this way. For example, you might record one sample per octave, and assign each of these samples to an index (key-board area).

By assigning multiple samples such as phrase samples or rhythm loops to a multisample and arranging them across the keyboard, you can play multiple samples simultaneously. Since a different phrase could be assigned to each key, you can perform just as though you were using a pad-type sampler. Alternatively, these samples could be assigned at one-octave intervals, and played as phrase variations with different playback pitches.

The TRITON Extreme can hold a maximum of 1,000 multisamples in its internal memory.

A multisample can be selected as the oscillator for a program, and played as a program. In a combination, they can be combined with preset programs, and used in a multi. They can be used with the arpeggiator to produce interesting results (for example, by using the arpeggiator to automatically play sound effects or spoken samples).

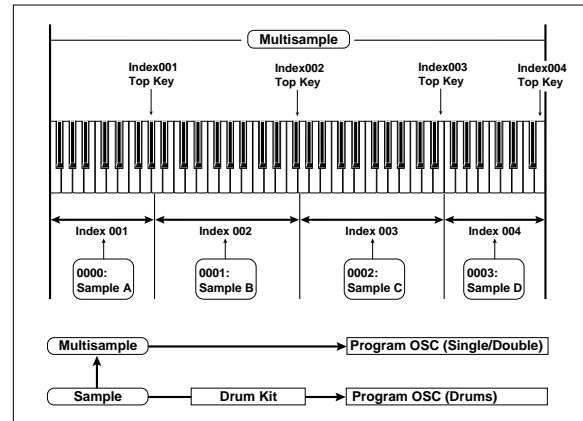

Conceptual diagram of the Open Sampling System

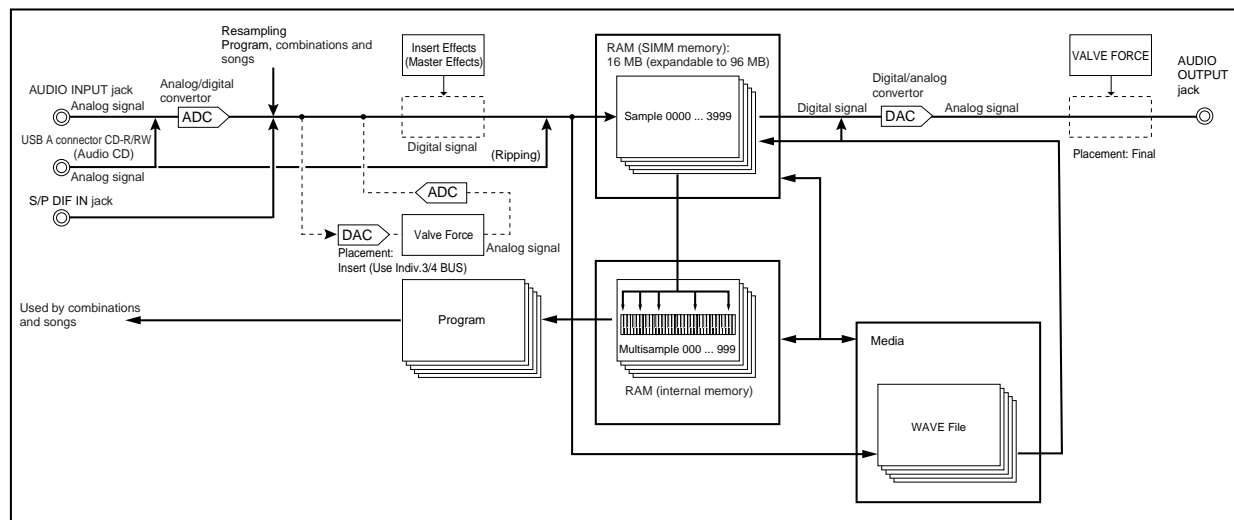

## Preparations for sampling

**Note** The multisample and sample data in the sample memory (RAM) is not backed up when the power is turned off. If you wish to keep this data, you must save it onto a media before turning off the power.

When the power is first turned on, memory will not contain any multisample or sample data. You must first load previously-saved data before you can playback or edit any sample data (see p.121).

### 1. Connecting an input device and making Input settings

#### Connecting an input device

Here's how to connect an external audio source. On the TRITON Extreme you can input audio signals to the AUDIO INPUT 1 and 2 jacks, or the S/P DIF IN jack.

#### ① Connect the audio source that you want to input.

- **Input from the AUDIO INPUT 1 and 2 jacks**  
Connect a mic, guitar, or CD player etc. to the rear panel AUDIO INPUT 1 and 2 jacks. Set the AUDIO INPUT [MIC/LINE] switch as appropriate for the device you are inputting. If a mic is connected, set this to the MIC position. If a guitar or analog audio device is connected, set this to the LINE position.

**Note** Guitars with active pickups can be input directly. However if your guitar has a passive-type pickup (i.e., without a built-in preamp), the mismatch in impedance levels will make it difficult to sample at an appropriate level. Such instruments should be routed through a preamp or effect unit before they are connected.

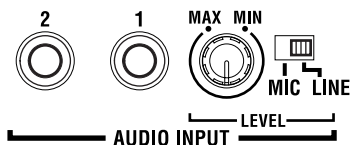

- **Input from the S/P DIF IN jack**  
Connect the optical digital output jack of your DAT etc. to the rear panel S/P DIF IN jack.

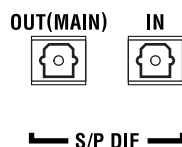

**Note** If you want to input from the S/P DIF IN jack, set the Global mode "System Clock" to S/P DIF. (see PG p.158)

#### Input settings

One set of *Input* settings are maintained by Sampling mode, and a different set of Input settings are shared by Combination, Program, Sequencer, Song Play, and Media mode. This latter set is saved as Global mode parameters. Normally you will set these in Global mode; however, these same settings can also be made from the other modes.

These settings can be made in the following pages.

Mode	Page
Sampling	Sampling P0: Recording, Input/Setup
Combination, Program, Sequencer, Song Play, Media	Combination P0: Play, Sampling
	Program P0: Play, Sampling
	Sequencer P0: Play/REC, Sampling
	Global P0: Basic Setup, Input/Sampling
	Media, Play Audio CD

**Note** Sampling can be performed in Sampling, Combination, Program, and Sequencer modes.

#### ② Select the page for making Input settings.

As an example, here's how to make settings in Sampling mode and in Program mode.

#### • Sampling mode

Press the [SAMPLING] key to enter Sampling mode. Press the Input Setup tab to access the P0: Recording, Input/Setup page.

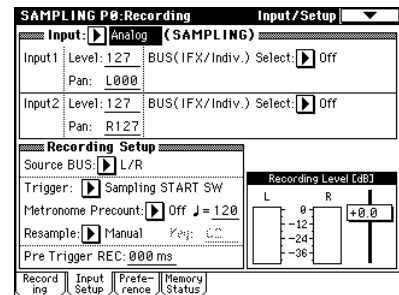

#### • Program mode

Press the [PROG] key to enter Program mode. Press the Sampling tab to access the P0: Play, Sampling page.

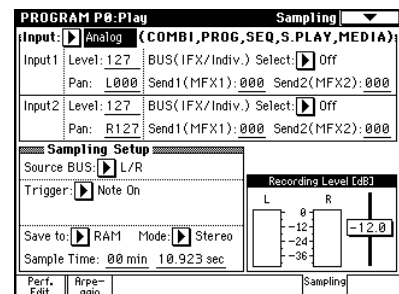

#### ③ Use "Input" to select the input source.

If you want to sample the input connected to the AUDIO INPUT 1 and 2 jacks, set "Input" to Analog. If you want to sample the signal being input via the S/P DIF IN jack, set "Input" to S/P DIF.

**Note** If "Input" is set to S/P DIF, an "Obey Copyright Rules" dialog box will appear. Carefully read "About copyright" (see QS p.iii), and if you accept the terms, press the OK button to continue with settings. If you do not accept the terms, press the Cancel button to cancel the setting.



**Note** For the best sound quality, adjust the level as high as possible without making the "ADC OVERLOAD !!" warning appear.

- ④ For *Input1* and *Input2*, set “BUS (IFX/Indiv.) Select” to specify the destination to which the external audio signal you selected in “Input” will be sent.

L/R: Send to the L/R bus.

IFX1–IFX5: Send to the corresponding insert effect.

1, 2, 3(Tube), 4(Tube), 1/2, 3/4(Tube): Send to the jINDIVIDUAL 1–4, 1/2, or 3/4 bus(es).

Use “Level” to adjust the signal level. Normally you will set this to 127. Use “Pan” to specify the stereo position.

In the Input section (COMBI, PROG, SEQ, S.PLAY, MEDIA) you can specify the send levels “Send1 (MFX1)” and “Send2 (MFX2)” to master effects 1 and 2. These settings can be made if “BUS (IFX/Indiv.) Select” is L/R or Off.

- “Send1 (MFX1)” and “Send2 (MFX2)” cannot be set in Sampling mode.

- The input from the AUDIO INPUT 1 jack is set by *Input1*, and the input from the AUDIO INPUT 2 jack is set by *Input2*.
- The L channel of the input from the S/P DIF IN jack is set by *Input1*, and the R channel is set by *Input2*.

**Example:**

Send the signal from the AUDIO INPUT 1 jack in mono to the L/R bus

*Input1* “BUS (IFX/Indiv.) Select” L/R, “Level” 127, “Pan” L000

**Example:**

Send the signal from the AUDIO INPUT 1 and 2 jacks in stereo to the L/R bus

*Input1* “BUS (IFX/Indiv.) Select” L/R, “Level” 127, “Pan” L000

*Input2* “BUS (IFX/Indiv.) Select” L/R, “Level” 127, “Pan” R127

- When “BUS (IFX/Indiv.) Select” is changed from Off to L/R or IFX, please be aware that the volume level of the AUDIO OUT L/MONO and R jacks and the headphones may rise excessively.

**note** An easy way to make these settings is to use the Auto Sampling Setup “REC Audio Input” function. You can do this in Sampling P0: Recording or in Program P0: Play, Sampling.

## 2. Setting the recording level (Recording Level [dB])

- ① **Produce sound at the volume that you want to record.** If you are inputting via the AUDIO INPUT 1 and 2 jacks, gradually turn the [LEVEL] knob from the MIN position toward MAX. Set the level immediately below the point where the display indicates “ADC OVERLOAD !!” (AD converter input overload).

**note** The best audio quality will be obtained at a level immediately below the point where “ADC OVERLOAD !!” is displayed (i.e., the highest level that does not produce an overload).

- ② **Press the SAMPLING [REC] key.** Produce sound at the volume that you want to record. Watch the level meters to check the input volume.

Use the “Recording Level” slider to adjust the recording level.

- When the output volume will not change at this time, but your adjustment will affect the data that will be sampled.

If “CLIP!!” is displayed, lower the “Recording Level” (located at the right of the display) to an appropriate level.

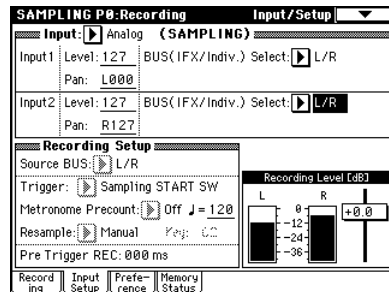

We recommend that you set the “Recording Level” as shown below, depending on whether you are sampling only an external input source, or resampling the playback of a song or a performance played on a program, combination, or sample.

At this time you can also set “Auto +12 dB On” (p.67) so that the recorded sample will play back at an appropriate level.

**When sampling only an external input source:**

“Recording Level”: +0.0 (dB)  
 “Auto +12 dB On”: off (unchecked)

**When resampling** (sampling the playback of a song, or your keyboard performance using a program, combination, or sample) or

**When simultaneously resampling and sampling an external audio source:**

“Recording Level”: -12.0 (dB)  
 “Auto +12 dB On”: on (checked)

(p.67 “The recording level and “Auto +12 dB On””)

- ③ **When you have finished making adjustments, press the SAMPLING [REC] key.**

## 3. Specifying the recording method (Recording Setup/Sampling Setup)

- ① **In “Source BUS,” select the source that you want to sample.**

The sound being sent to the bus you select here will be sampled.

L/R: The sound being sent to the L/R bus will be sampled.

Indiv.1/2: The sound being sent to the Individual 1, 2 bus will be sampled.

For examples of these settings, refer to the various examples of sampling. (p.67, 70, 75, 82, 83, QS p.19, 22)

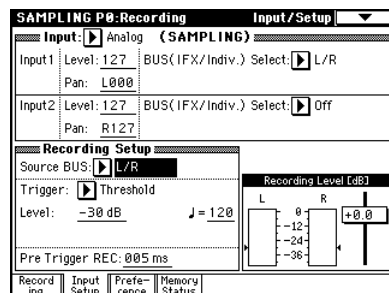

- ② Use “Trigger” to specify how sampling will begin. The available trigger methods will differ depending on the mode.

**Sampling mode:**

Sampling START SW, Note On, Threshold

**Program, Combination modes:**

Sampling START SW, Note On

**Sequencer mode:**

Sampling START SW, Note On, Threshold, Sequencer START SW

Here we will describe the Sampling START SW and Note On that can be used in all modes. For details on trigger methods suitable for various purposes, refer to the various examples of sampling on p.80, 82, 83, QS p.18, 22 or PG p.5, 41, 63, and 115.

**Sampling START SW:** When you press the SAMPLING [REC] key, you will enter sampling-standby mode, and sampling will begin when you press the SAMPLING [START/STOP] key.

**Note On:** When you press the SAMPLING [REC] key and then the SAMPLING [START/STOP] key, you will enter sampling-standby mode, and sampling will begin when you play the keyboard.

#### 4. Making settings for the sample to be recorded (REC Sample Setup/Sampling Setup)

Next we will specify the location into which the data will be sampled, select mono or stereo sampling, and specify the sampling time.

REC Sample Setup settings are made in Sampling mode, and Sampling Setup settings are made in Combination, Program, or Sequencer mode. These settings are maintained independently for each mode.

Use the following pages to set them.

Mode	Page
Sampling	Sampling P0: Recording, Recording
Combination	Combination P0: Play, Sampling
Program	Program P0: Play, Sampling
Sequencer	Sequencer P0: Play/REC, Sampling

- **Sampling mode**

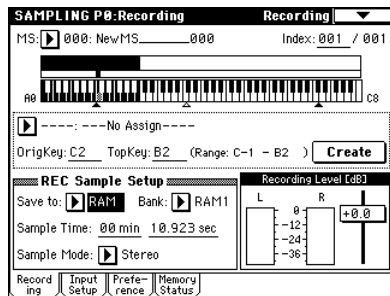

- **Program mode**

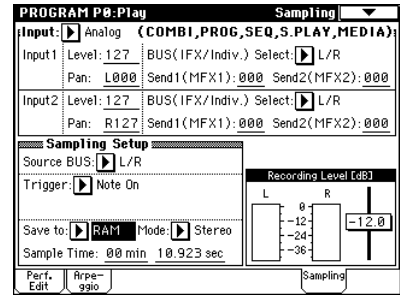

- ① Use “Save to” to specify the location into which the data will be sampled.

**RAM:** The sample will be written into sample memory (RAM).

If you select RAM, you can also specify the writing-destination RAM bank.

In Sampling mode, this is specified by “Bank.”

In other modes, this is specified by the page menu command “Select Bank & Smpl No.”

When you select “Select Bank & Smpl No.,” the following dialog box will appear.

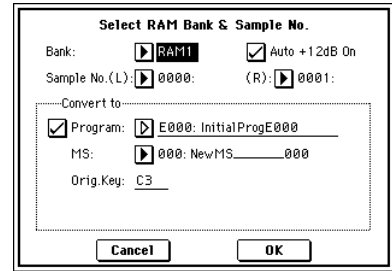

Specify the “Bank” in this dialog box.

“Sample No.” specifies the writing-destination sample number. If “Sample Mode” is set to Stereo, specify L and R.

If you check “Program” in the “Convert to” area, the sample will automatically be converted to a program immediately after the sample has been written into RAM. This is convenient when you want to hear the sampled sound immediately.

At the right, use “Program” and “MS” to specify the program number and multisample number of the program that will be created by the conversion.

Use “Orig.Key” to specify the key that will play the sample at its original pitch. “Orig.Key” will increment by one after you sample, so that the next sample you record will be assigned to the next higher note.

Press the OK button to finalize the settings.

**note** Set the “Auto +12 dB On” parameter. If you check “Auto +12 dB On,” the sample playback level will automatically be increased by +12 dB after sampling. (☞“The recording level and “Auto +12 dB On””)

In Sampling mode, you can set this parameter in the P0: Recording, Preference page.

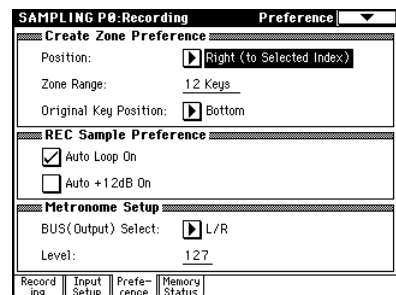

In Program, Combination, and Sequencer modes, you can set this parameter using the Sampling page menu command “Select Bank & Smpl. No.”.

**MEDIA:** The sample will be written to the media.

If you select MEDIA, you can also select the writing-destination drive.

In all modes, this is specified by the page menu command “Select Directory.”

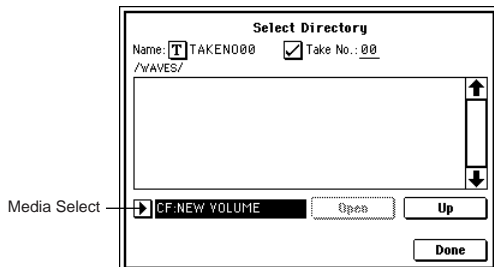

In the “Media Select” field, select the drive. Use the Open and Up buttons to move between levels of the directory hierarchy to select the desired directory. Press the Done button to finalize the settings.

**note** If you sampled to the media as a WAVE file, the “Auto +12 dB On” setting will be ignored. The playback level of the WAVE file is set by “WAVE File Play Level” (PG p.158).

② In “Sample Time,” specify the length of time that you want to sample.

This can be set in units of minutes and seconds.

If you are sampling to **RAM** (sample memory), you can sample a maximum of approximately 2 minutes 54 seconds in mono, or approximately 1 minute 27 seconds in stereo.

If you are sampling to **MEDIA**, you can sample a maximum of 80 minutes in either mono or stereo (mono: approximately 440 Mbytes, stereo: approximately 879 Mbytes).

③ Set “Sample Mode” to specify whether a mono or a stereo file will be created.

**L-Mono:** The sound of the internal L channel will be sampled in mono.

**R-Mono:** The sound of the internal R channel will be sampled in mono.

**Stereo:** The sound of the internal L and R channels will be sampled in stereo.

### The recording level and “Auto +12 dB On”

When you resample the playback of a song, or your keyboard performance using a program, combination, or sample, or if you mix your performance with an external audio source and sample the result, you should normally set “Recording Level” to -12.0 (dB). If you resample at -12.0 (dB), the sample data will be recorded at the optimum level, but the playback level will be lower than the level during sampling (if “+12 dB” is off). In such cases, you can check “Auto +12 dB On” when you resample, so that “+12 dB” (Sampling mode Loop Edit page) will automatically be turned on, and the recorded sample will play back at the same level at during resampling.

When you sample an external audio source, you should normally set “Recording Level” to +0.0 (dB). The sample data will be recorded at the optimum level. If you sample with “Auto +12 dB On” turned off at this time, “+12 dB” (Sampling mode Loop Edit page) will be off, and the sample will play back at the same level at which it was sampled.

When the power is turned on, “Recording Level” and “Auto +12 dB On” will default to the following settings.

#### Program, Combination, Sequencer modes

“Recording Level”: -12.0 (dB), “Auto +12 dB On”: on

#### Sampling mode

“Recording Level”: +0.0 (dB), “Auto +12 dB On”: off  
These settings assume that you will mainly be resampling in Program, Combination, and Sequencer modes (listed above), and performing conventional sampling in Sampling mode (listed below).

### Optimizing the sample memory (RAM)

If RAM has been specified as the destination to which data will be written during sampling, you can specify that sample memory (RAM) be automatically optimized after the data is written. When optimization is performed, unused areas that are occupying memory space will be reorganized to increase the available free space. In the Global mode P0: Basic Setup, Input/Sampling page, you can check “Auto Optimize RAM” so that RAM will automatically be optimized when sampling ends. In this case, you will always be able to sample without any wasted RAM area, but the sound will stop for a time when sampling ends. If a song is being played back in Sequencer mode, the playback will stop.

If you are playing back a song, or if you are repeatedly recording multiple samples in various locations while listening to audio input from a CD etc., you can sample with “Auto Optimize RAM” unchecked, and then execute the page menu command “Optimize RAM” (found in the Sampling page of Program, Combination, or Sequencer modes, and in P0–P4 of Sampling mode) to optimize the RAM when the remaining amount of memory begins to decrease. The remaining amount of sample memory (RAM) can be checked in Sampling mode P0: Memory Status.

### Examples of sampling settings

○ Resampling only the sound of the TRITON Extreme (e.g., arpeggiator and/or keyboard performance)

“Input”: Analog

Input1 “BUS Select”: Off

Input2 “BUS Select”: Off

“Source BUS”: L/R

“Recording Level”: -12.0

“Auto +12dB On”: On (checked) PG p.6, 64

○ Resampling the sound of the TRITON Extreme (arpeggiator and/or keyboard performance) together with the input sound from the AUDIO INPUT 1 jack

“Input”: Analog

Input1 “BUS Select”: L/R, “Pan”: C064 or as desired

Input2 “BUS Select”: Off

“Source BUS”: L/R

“Recording Level”: -12.0

“Auto +12dB On”: On (checked) PG p.6, 64

- **Sampling only the stereo input sound from the AUDIO INPUT 1 and 2 jacks while you listen to the sound of the TRITON Extreme (arpeggiator etc.)**

“Input”: Analog

Input1 “BUS Select”: 1/2, “Pan”: L000

Input2 “BUS Select”: 1/2, “Pan”: R127

“Source BUS”: Indiv.1/2

“Recording Level”: 0.0

“Auto +12dB On”: Off (unchecked) PG p.6, 64

In this case, the sound that is input to AUDIO INPUT 1 and 2 will be output only to AUDIO OUTPUT (INDIVIDUAL) 1 and 2.

### Using the metronome

It is convenient to use the metronome when you want to play a program or combination at a specific tempo and sample your performance.

To access the metronome settings, use the Program or Combination P0: Play, Sampling page menu command “Metronome Setup.” We recommend that you set “BUS (OUTPUT) Select” to either 3 or 4, and connect the (INDIVIDUAL) 3 or 4 jack to your mixer so that the metronome can be monitored via your mixer.

### Automatically setting-up for the desired sampling method (Auto Sampling Setup)

In each mode, Auto Sampling Setup automatically makes the appropriate settings for the sampling-related parameters so you don’t have to perform steps 1–4 described above. For example in Program mode you can use this to make the necessary settings for resampling your playing on a program, or to make settings for sampling only an external audio source while you monitor your playing on a program. However, these automatic settings assume typical situations, so you’ll need to adjust the parameters to meet your situation.

This function is available in the following pages.

Mode	Page
Sampling	Sampling P0: Recording
Combination	Combination P0: Play, Sampling
Program	Program P0: Play, Sampling
Sequencer	Sequencer P0: Play/REC, Sampling

For examples of the settings, refer to p.80, 82, 83, QS p.18, 22. For a detailed explanation, refer to PG p.7, 42, 64, 112.

## Sampling and editing in Sampling mode

In Sampling mode, you can record samples, and edit sample data that you sampled or loaded from media (including WAVE and AIFF formats). You can also assign the edited samples to indexes (zones) to create a multisample.

Sampling mode page structure

Page	Explanation
P0: Recording	Record samples. Select the sample or multisample to record, make various recording settings and AUDIO INPUT settings. View the memory status.
P1: Sample Edit	Perform waveform editing etc. on samples that were sampled or loaded in Media mode.
P2: Loop Edit	Set sample playback parameters: Start, Loop Start, End Address, Loop on/off, and Reverse on/off. Editing operations such as Time Slice and Time Stretch.
P3: Multisample	Edit multisamples. Set and edit the sample assignments, zone, and original key etc.
P4: Controller Setup	Controller settings.
P5: Audio CD	Audio CD playback and ripping.
P6:	---
P7:	---
P8: Insert Effect	Select and make settings for insert effects.
P9: Valve Force	Valve Force settings.

**note** For details on how to access each mode and page, refer to “Basic operation” (PG p.13).

**note** Sampling can be performed in any page P0–P8 of Sampling mode by using the [REC/WRITE] key and the [START/STOP] key. Recording-related settings such as input level are made by the parameters of P0: Recording, and these settings are valid for the other pages as well.

**note** The selected multisample or sample can be played from the keyboard in any page, allowing you to hear the results of your editing in each page.

For an example of sampling, refer to QS p.18–.

On the following page we will explain sampling operations that are specific to Sampling mode, and how to edit a multisample or sample.



## Creating multisample indexes and sampling

Here's how to create indexes for a multisample, and how to assign a sample to each index.

- 1 Select the **P0: Recording, Recording page**.

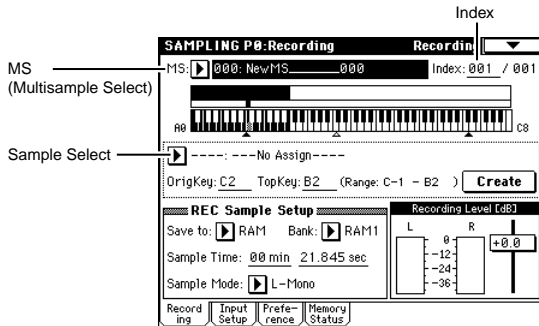

- 2 Select **"MS (Multisample Select),"** and create a multisample.

To create a new multisample, press the "MS (Multisample Select)" popup button. Then press a Multisample No. in the list for which no name has been entered, or use the numeric keys [0]–[9] to input a number and then press the [ENTER] key.

A dialog box will appear.

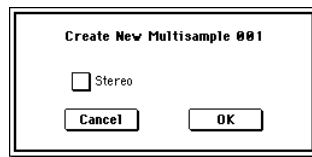

If you want to create a stereo multisample, check the "Stereo" box, and press the OK button.

If you want to create a monaural multisample, uncheck the "Stereo" box, and press the OK button.

- 3 Press the **Create** button to create an index.

Immediately after the power is turned on, the "Index" will be indicated as **001/001**. This means that there is only one index.

The range that is highlighted in the keyboard & Index is the range of the selected index.

Press the Create button several times. Each time you press it, an index will be created. The keyboard display will indicate the zone and original key location of each index.

**note** The index that is created when you press the Create button will be created according to the P0: Recording, Preference page *Create Zone Preference* settings. (These settings can also be made in P3: Multisample, Preference page *Create Zone Preference*. [PG p.116, 137](#))

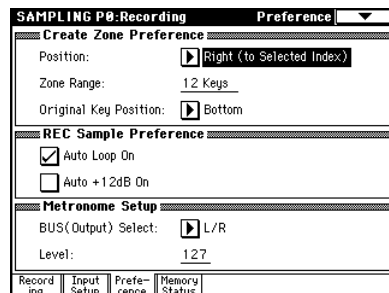

Immediately after the power is turned on, "Position" will be **Right** (to selected index), "Zone Range" will be **12 Keys**, and "Original Key Position" will be **Bottom**, so that indexes will be created as shown below.



**note** If you set "Zone Range" to **1 Key**, an index will be created for each note of the keyboard. It is convenient to use 1 Key when you wish to sample numerous takes in succession, such as when recording phrases or rhythm loops.



- 4 Select **"Index."**  
"Index" can also be selected by holding down the [ENTER] key and playing a note on keyboard. For this example, select 001.

- 5 Assign a sample to the "Index."

If sample memory (RAM) already contains samples, use "Sample Select" to select the sample and assign it.

If you want to record a new sample, you can sample it now.

The sample you record will be automatically assigned to the index you selected in step 4.

The assigned sample will sound when you play the keyboard in the range of the index to which the sample is assigned.

- 6 Repeat steps 4 and 5 to assign a sample to each index.

**note** The number and order of the indexes in a multisample, the range of each index, and the original key position can be freely changed later if desired. ("Multisample editing" [p.77](#))

### Creating multiple samples

In the example procedure described above, several indexes were created (by pressing the Create button several times), and then samples were assigned to each "Index."

As an alternative method, it is also possible to create one index, sample into it, and then repeat these two steps.

- 1 Press the **Create** button once to create an index.
- 2 Record a sample.  
The recorded sample will automatically be assigned to the index you created in step 1.
- 3 Repeat steps 1 and 2.  
This is an efficient way to record multiple samples. ([QS p.20](#))

## Applying an insert effect to a sample and resampling it

The process of applying an insert effect etc. to a sampled sound and then sampling it once again is called “resampling.”

- ① In the P0: Recording, Recording page, assign the sample that you want to resample to “Sample Select.” When the power is first turned on, the assigned sample will be set to “Orig.Key” C2.
- ② Press the page menu button, and choose “Auto Sampling Setup” from the menu. A dialog box will appear.
- ③ Choose “Auto Resample through IFX,” and select the effect that you want to use.

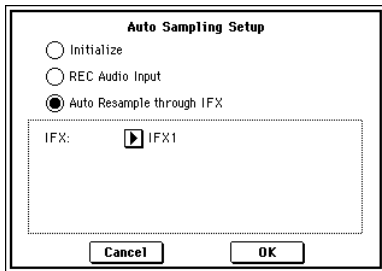

- ④ Press the OK button to execute the command. Sampling settings will be made automatically.

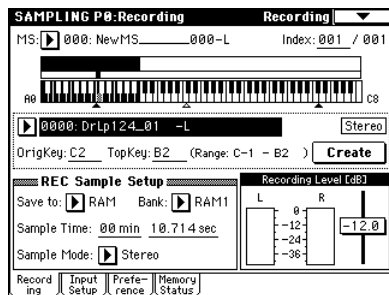
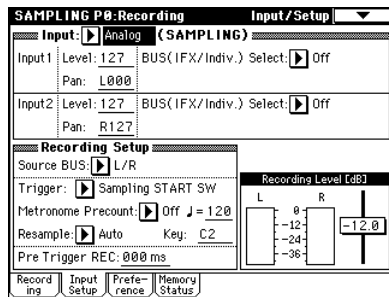

**note** Let’s take a look at the settings that were made automatically.

**Input 1 “BUS (IFX/Indiv.) Select”:** Off  
**Input 2 “BUS (IFX/Indiv.) Select”:** Off  
 Input from the INPUT 1, 2 jacks is turned off.  
**“Source BUS”:** L/R

The sound sent to the L/R will be sampled.

**“Trigger”:** Sampling START SW

After you’ve pressed the SAMPLING [REC] key to enter sampling-ready mode, resampling will begin when you press the SAMPLING [START/STOP] key.

**“Resample”:** Auto

The sample assigned to the index will be resampled automatically.

**“Key”:** C2

Use “Key” to specify the sample that will be resampled.

**“Recording Level”:** –12.0

This is the default setting for resampling.

**“Save to”:** RAM

The data will be written to sample memory (RAM).

**“Sampling Mode”:** Stereo

The sound of the internal L/R channels will be sampled in stereo.

**“Auto +12dB On”:** On

The “+12 dB” setting will automatically be turned on for the samples you record.

**“BUS (IFX) Select”:** IFX1

The output of the sample will be sent to IFX1. (step 6)

⚠ Be aware that if you change the “BUS” setting from Off to L/R or IFX1–5, the volume level sent to the AUDIO OUT L/MONO and R jacks and the headphones will rise excessively.

- ⑤ In P2: Loop Edit, check the “+12 dB” setting.

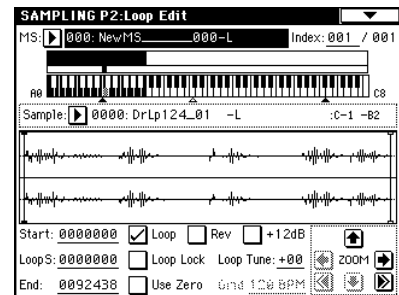

By making the following settings, you will be able to resample at the optimal level.

**If “+12 dB” is not checked:**

“Recording Level”:

“Recording Level”:

“Auto +12 dB On”:

“Auto +12 dB On”:

“Auto +12 dB On”:

“Auto +12 dB On”:

“Auto +12 dB On”:

“Auto +12 dB On”:

“Auto +12 dB On”:

“Auto +12 dB On”:

- ⑥ In the P8: Insert Effect, Routing page, you can see that

“BUS (IFX) Select” is set to IFX1.

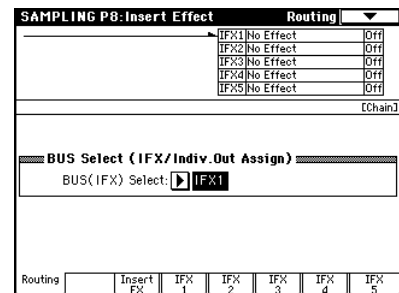

- ⑦ In the **P8: Insert Effect, Insert FX** page, set “IFX1” to **052: Reverb Hall**, and turn “IFX On/Off” **ON**.

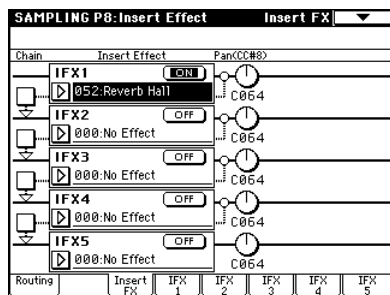

Press the **C2** key, and verify that reverb is applied.

- ⑧ Press the **SAMPLING [REC]** key, and then the **SAMPLING [START/STOP]** key.

The sample assigned to **C2** will play automatically, and resampling will begin.

When the sample finishes playing, resampling will end.

The sample that was created by resampling will automatically be assigned to “Sample Select.”

- ⑨ Press the **C2** key, and verify that reverb is applied.

**Note** In Sampling mode, the **P8: Insert Effect, Routing** page “BUS (IFX) Select” parameter will automatically be set to L/R when resampling ends. This prevents an insert effect from being applied in duplicate when you monitor the results of resampling through an insert effect.

If you want to apply an insert effect once again, reselect IFX1.

**note** As an alternative to automatically resampling as described above (“Resample” Auto), you can simply sample the sounds that you play from the keyboard (“Resample” Manual).

In “Sample Select,” assign the sample that you will resample, and set “Resample” to Manual. Set “Trigger” to Note On, and set “Sample Mode” to Stereo as desired. Then set the bus and effect as described in steps ② and ⑦, press the **SAMPLING [REC]** and then the **[START/STOP]** key, and then press the **C2** key to start resampling. When you want to stop resampling, press the **SAMPLING [START/STOP]** key.

## Ripping

Data from an audio CD in a CD-ROM or CD-R/RW drive connected to the USB A connector can be loaded into the TRITON Extreme as sample data. You can do this in either of two ways; you can play back the audio CD and capture the sound via the AUDIO INPUT, or you can load (“rip”) it directly as digital data.

**Note** If you are using a CD-ROM or CD-R/RW drive connected to the USB A connector, use an audio cable to connect the audio output of your drive to the TRITON Extreme’s AUDIO INPUT 1, 2 jacks. If you’re using a drive that does not have audio output jacks or a headphone jack, you won’t be able to monitor the sound.

### Ripping digital data from an audio CD as a sample

Here’s how digital data from an audio CD track can be captured as a sample.

- ① Insert an audio CD into the USB A connector CD-ROM or CD-R/RW drive. (PG p.325)
- ② In the Sampling mode **P0: Recording, Input/Setup** page, make Input settings so that you can monitor the audio that you want to rip.

“Input”: Analog

Input1 “BUS (IFX/Indiv.) Select” L/R, “Level” 127, “Pan” L000

Input2 “BUS (IFX/Indiv.) Select” L/R, “Level” 127, “Pan” R127

**note** Ripping will not be affected by these inputs.

- ③ Access the Sampling mode **P5: Audio CD, Ripping** page.
- ④ In “Media” (media select), select the drive that contains the audio CD, and use “Track” to select the track that you want to rip.

Raise the “Volume.”

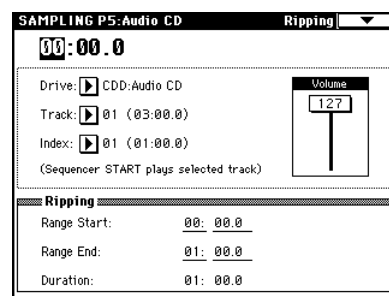

- ⑤ Press the **SEQUENCER [START/STOP]** key to play back the audio CD track.
- ⑥ During playback, press the **[ENTER]** key at the points where you want ripping to begin and end. This will set “Range Start” and “Range End.” If you press the **[ENTER]** key three or more times, “Range Start” and “Range End” will respectively be set to the next-to-last point at which you pressed the key, and the last point at which you pressed the key.

**note** You can use the method described above when the edit cell is located at other than “Range Start” or “Range End.”

If the edit cell is located at “Range Start” or “Range End,” the setting will be reset each time you press the **[ENTER]** key.

**note** If the edit cell is located at “Range Start” or “Range End,” this region will play back.

When you finish making settings, press the SEQUENCER [START/STOP] key to stop playback of the audio CD.

- ⑦ **Verify the region that will be ripped.**  
Select either “Region Start” or “Region End” (the display will be highlighted), and press the SEQUENCER [START/STOP] key. The CD will play from “Range Start” to “Range End” and then stop.

**note** If you want to adjust the location, use the VALUE controllers to modify the “Range Start” or “Range End” settings, or move the cursor to a parameter other than “Range Start” and “Range End” and repeat step ⑤ to make the setting once again.  
If you want to move the track playback start location to the beginning of the track, press the [LOCATE] key.

- ⑧ **When you have finished setting “Range Start” and “Range End,” select the page menu command “Destination.”**

A dialog box will appear.  
Specify the destination to which the ripped sample will be written.

Select **RAM** if you want to rip the sample into sample memory (RAM). In this case, you can also set Sample No. (L), (R) to specify the sample number that will be written. Normally you can leave this unchanged.

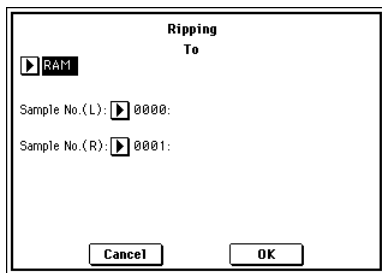

Select **MEDIA** if you want to rip the sample to media. Use drive select to select the drive, and use the Open and Up buttons to select the directory in which the data will be saved. Also specify a name for the WAVE file that will be saved.

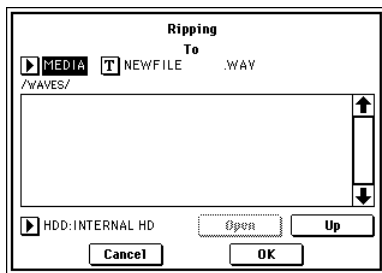

- ⑨ **Press the OK button to execute ripping, or press the Cancel button to cancel without executing.**

**▲** When you press the OK button, the “Obey Copyright Rules” dialog box will appear.  
Carefully read “About copyright” (Ⓜ QS p.iii), and if you consent to the terms, press the OK button to begin ripping. If you do not consent to the terms, press the **Cancel** button to cancel the operation.



### Reading the analog audio output of an audio CD into a sample

Here’s how analog audio data from an audio CD track can be loaded into a sample.

In the same way as when inputting the output of your CD player to the TRITON Extreme’s AUDIO IN 1, 2 jacks, use audio cables to connect the audio output of the CD-ROM or CD-R/RW drive connected to the USB A connector to the TRITON Extreme’s AUDIO INPUT 1, 2.

You can use the TRITON Extreme’s SEQUENCER [START/STOP] key etc. to control operations such as playback and stop on your CD-ROM or CD-R/RW drive.

- ① **Use audio cables to connect the audio outputs of your CD-ROM or CD-R/RW drive (connected to the USB A connector) to AUDIO INPUT 1, 2 of the TRITON Extreme.**
- ② **Insert an audio CD.**
- ③ **Access the Sampling mode P5: Audio CD, Ripping page.**
- ④ **Use “Media” (media select) to select the drive that contains the audio CD, and use “Track” to select the track that you want to read.  
Raise the “Volume.”**

**▲** Some USB A connector CD-ROM or CD-R/RW drives cannot be controlled in this way, so this setting may not affect the volume.

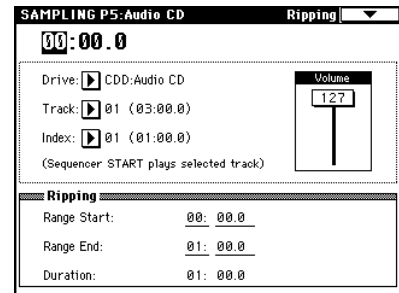

- ⑤ **In the P0: Recording, Input/Setup page, make Input settings as follows.**

“Input” Analog  
*Input1* “Level” 127, “Pan” L000, “BUS Select” L/R  
*Input2* “Level” 127, “Pan” R127, “BUS Select” L/R

- ⑥ **Specify the recording method in Recording Setup.**

“Source BUS” L/R  
“Trigger” Sampling START SW  
Sampling will start when you press the SAMPLING [START/STOP] key.  
“Resampling” Manual

- ⑦ **In REC Sampling Setup, make settings for the sample that will be recorded.**

“Save to” RAM: if you want to write the sample into sample memory (RAM)  
“Save to” MEDIA: if you want to write the sample to media  
“Sample Mode” Stereo  
“Sample Time” maximum

⑧ **Adjust the recording level.**

Press the SAMPLING [REC] key.

When you press the SEQUENCER [START/STOP] key to play back the audio CD, the level meter will indicate the volume that will be sampled. If the display indicates “ADC OVERLOAD !,” adjust the “Volume” in the P5: Audio CD, Ripping page.

🔊 You can also adjust the level from the volume control of your USB drive or the [LEVEL] knob located on the rear panel of the TRITON Extreme.

If the display indicates “CLIP!,” use the VALUE controllers to lower the “Recording Level” slider below +0.0 until an appropriate level is reached.

When you finish making adjustments, press the SEQUENCER [START/STOP] key to stop playback of the audio CD. Press the [LOCATE] key to return the location to the beginning of the track.

Press the SAMPLING [REC] key once again.

⑨ **Execute sampling.**

Press the SAMPLING [REC] key.

Press the SEQUENCER [START/STOP] key to start playback of the audio CD track.

At a point slightly earlier than where you want to sample, press the SAMPLING [START/STOP] key to begin sampling.

At the point where you want to stop sampling, press the SAMPLING [START/STOP] key to stop sampling.

## Loop settings

Using the default settings after the TRITON Extreme is first turned on, the sounds you sample will automatically be looped (P0: Recording, Preference page “Auto Loop On” On)

To edit the loop and other playback address settings for the sample, use the P2: Loop Edit page.

① **Select the sample for which you wish to make loop settings.**

To select the sample, use the “Sample Select” or “Index” parameters of P2: Loop Edit page or of the P0: Recording, Recording page. (Ⓝp.69)

🔊 If you use “Sample Select” to select the sample, be aware that the assignment to the index will also change.

② **In the P2: Loop Edit page, use the “Loop” check box to turn loop playback on/off for the sample.**

Looping will be turned on if the box is checked.

This will operate between the addresses you specify in step ③.

**Loop On:** Start→End→LoopS→End→ (LoopS→End is repeated)

**Loop Off:** Start→End

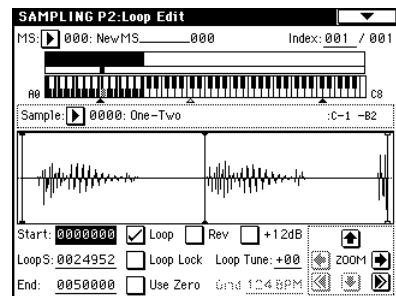

To play the sample, press the key to which the sample is assigned (the key range that is highlighted in “Keyboard & Index”).

📌 **note** A sample waveform that was sampled with “Sample Mode” set to Stereo will be displayed in two levels. The upper level is the L channel, and the lower level is the R channel.

③ **Specify the start address in “Start,” the loop start address in “LoopS (Loop Start),” and the end address in “End.”**

Select “Start” (highlighted), and use the [VALUE] dial or other VALUE controllers to modify the value. The corresponding vertical line will move. Set “LoopS (Loop Start)” and “End” in the same way. In the example shown below, “Start” is set immediately before the first waveform, “LoopS (Loop Start)” is set immediately before the second waveform, and “End” is set as desired.

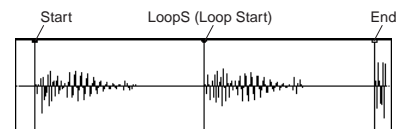

📌 **note** By using the ZOOM button you can change the range that is displayed. When “S (Start)” is highlighted, zoom will be performed from the start address.

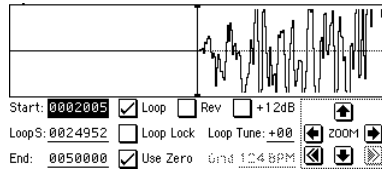

**note** If the “Use Zero” check box is checked, only those addresses where the waveform data crosses the zero level will be found automatically when searching, and can be set. This lets you easily make address settings where noise is less likely to occur when looping.

- ④ If necessary, use the page menu command “Truncate” to delete unwanted data that falls outside the start (or loop start) and end addresses.

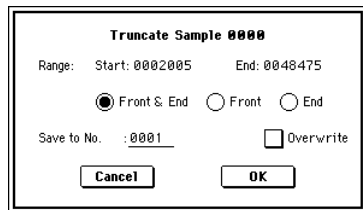

Set the parameters, and press the OK button to execute the operation. (PG p.119)

⚠ For cautions on the “Save to No.” and “Overwrite” check boxes, refer to “About “Overwrite”” (PG p.119).

### The grid display

The page menu command “Grid” overlays the waveform display with a grid based on the BPM tempo value. This makes it easy to make loop settings that are synchronized to the tempo.

**note** In the same way, the grid display can also be used in P1: Sample Edit page. The grid can help you to edit the waveform in sync with the tempo.

- ① Select the page menu command “Grid”. The following dialog box will appear.

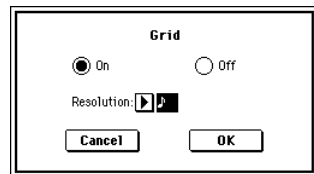

Turn “Grid” On, set the desired “Resolution,” and press the OK button. Dotted grid lines will appear.

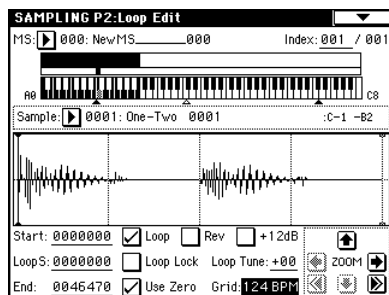

- ② Set “Grid” to the desired BPM tempo value.

**note** In P0: Input Setup, you can use the tap tempo function to set the tempo. Press the [ENTER] key several times while the sample plays, and the corresponding tempo will be set for “Metronome Precount.” Setting “Grid” to this value will make it easy to set the BPM setting.

- ③ Set the end address so that it coincides with a dotted line of the grid.

This will cause the loop interval to be the same length as the BPM value.

The grid display will be based at “LoopS (Loop Start)” if looping is on. If looping is off, the grid will be based at “Start.”

- ④ To hide the grid display, select the page menu command “Grid”, uncheck “Grid,” and press the OK button.

**note** The grid is displayed according to the playback pitch of the base key (the key shown in gray in the “Keyboard & Index” area).

You can select the base key by holding down the [ENTER] key and playing a note on the keyboard.

### Sampling and looping a drum phrase

Here’s how you can sample a drum phrase (or similar phrase) from an audio CD, and loop the playback. You will need to provide a drum rhythm loop sample. Initially, it is a good idea to begin with a rhythm loop sample that has a fairly simple beat.

As an example, we will sample one measure of a 140 BPM drum phrase in a 4/4 time signature. In this example we will use a CD player. For details on how you can digitally sample or “rip” from the USB A connector CD-ROM or CD-R/RW, refer to p.71.

**note** This explanation assumes that you are starting from the default state immediately after power-on.

If necessary, create a new multisample before you begin this procedure. (PG p.69)

- ① Connect the AUDIO INPUT 1, 2 jacks on the rear panel to the LINE OUT L and R jacks of your CD player.

Set the AUDIO INPUT [MIC/LINE] switch to the LINE position, and set the [LEVEL] knob near the center.

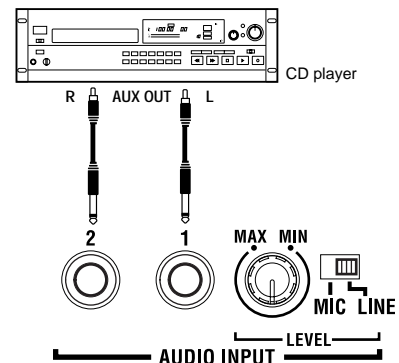

- ② Press the [SAMPLING] key.

You will enter Sampling mode. Make sure that the Sampling P0: Recording page is displayed. In this example, choose the Input/Setup page.

**note** If this is not displayed, press the [EXIT] key and then press the InputSetup tab.

- ③ Press the page menu button, and choose “Auto Sampling Setup” from the menu. The dialog box will appear.

④ Choose “REC Audio Input.”

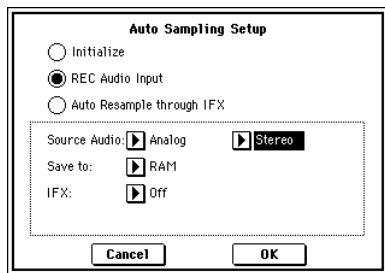

- ⑤ **Make the following settings for REC Audio Input.**  
 Set “Source Audio” to **Analog**. The external audio input source (the analog audio output of an instrument or other device connected to the INPUT 1, 2 jacks) will be sampled.  
 Set “Mono-1/Mono-2/Stereo” to **Stereo**. The input from the INPUT 1, 2 jacks will be sent to the internal L,R channels, and sampled in stereo.  
 Set “Save to” to **RAM**. The sampled data will be written to sample memory (RAM).  
 Set “IFX” to **Off**. Insert effects will not be applied while sampling.
- ⑥ **Press the OK button to execute the command.**  
 Preparations for sampling are now completed.

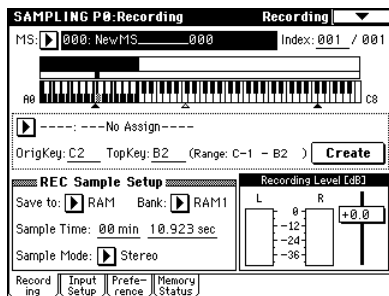
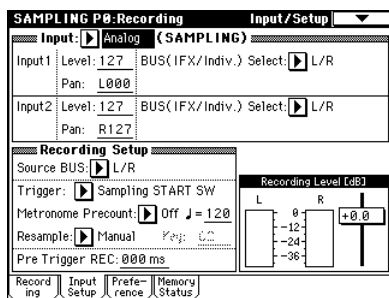

**note** Let’s check the settings that were made.  
 Input 1 “Level”: 127, “Pan”: L000  
 “BUS (IFX/Indiv.) Select”: L/R  
 Input 1 “Level”: 127, “Pan”: R127  
 “BUS (IFX/Indiv.) Select”: L/R  
 These settings specify the input level from the INPUT 1, 2 jacks, the panning, and select the L/R bus as the destination.  
 “Source BUS”: L/R  
 The sound sent to the L/R bus will be sampled.  
 “Trigger”: Sampling START SW  
 After you press the SAMPLING [REC] key to enter sampling-ready mode, recording will begin when you press the SAMPLING [START/STOP] key.  
 “Recording Level”: +0.0  
 This is the default setting for recording an external input.  
 “Save to”: RAM  
 The sampled data will be written to sample memory (RAM).

“Mode”: Stereo

The sound of the internal L/R channels will be sampled in stereo.

**note** When you change the Bus setting from Off to L/R or IFX, the volume level of the AUDIO OUT L/MONO and R jacks or the headphone volume may rise abruptly. Please use caution.

- ⑦ **Play back the audio source that you want to record.**  
 If the display indicates “ADC OVERLOAD !!” (AD converter input overload!), lower the level by turning the rear panel [LEVEL] knob to an appropriate position. Alternatively, lower the level of the output source.

**note** The best audio quality will be obtained at a level slightly lower than when the “ADC OVERLOAD !!” indication appears (i.e., the highest level that does not cause an input overload).

- ⑧ **Press the SAMPLING [REC] key.**  
 The level meter allows you to check the volume of the input.

If the display indicates “CLIP!,” use the VALUE controller to lower the “Recording Level” slider (located in the right of the display) from the +0.0 position to an appropriate level.

- ⑨ **When you have finished making adjustments, once again press the SAMPLING [REC] key. Also stop the playback of your audio source.**

- ⑩ **Press the SAMPLING [REC] key to enter recording-ready mode.**

- ⑪ **Play back your audio source. At the moment you want to start sampling, press the SAMPLING [START/STOP] key.**  
 Sampling will start.

**note** It is a good idea to allow a bit of extra time before you start and after you stop sampling.

- ⑫ **At the moment that you wish to stop sampling, press the SAMPLING [START/STOP] key.**  
 Sampling will stop.  
 A 140 BPM drum phrase has now been sampled. The sample will automatically be assigned to “Sample (Sample select).”

**note** Sampling will stop automatically if the remaining amount of memory reaches zero.

- ⑬ **Listen to the sound that was sampled.**  
 You can play the “OrigKey” note to hear the sound that was sampled.

**note** After you have verified the sound, assign a name to the sample (p.115) (e.g., LOOP1-140 BPM). Up to 14 characters can be input as the name of a stereo sample (the two characters -L and -R at the end are fixed). When you assign a name to either the L or R channel, the other sample will be named automatically.

- ⑭ **Press the [MENU] key to access the page jump menu, and press P2: Loop Edit.**  
 The P2: Loop Edit page will appear. Make settings to delete the unwanted portions at the beginning and end of the sample, to ensure a natural-sounding loop transition.

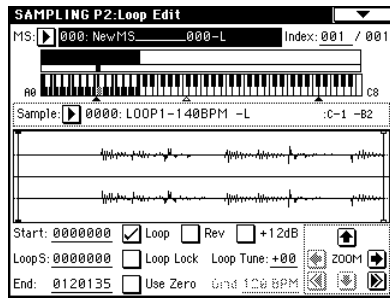

- 15 Notice that **0000: LOOP1-140BPM-L** is selected for “Sample (Sample Select),” and that the sample waveform data is displayed.

The selected sample is a stereo sample. The L and R waveforms will be shown in the upper and lower parts of the sample waveform display.

- 16 Use “Start” to set the start address, “LoopS (Loop Start)” to set the loop start address, and “End” to set the end address.

The sample will sound as follows.

When looping is on: S → E → LoopS → E → (continue repeating LoopS → E)

When looping is off: S → E

Select “Start” (highlighted), and use the [VALUE] dial etc. to specify the location at which the sample will begin sounding. The vertical line in the display will move accordingly.

**note** If necessary, you can press the **ZOOM** buttons to expand or shrink the waveform display. Zoom will expand or contract the display beginning at the “Start,” “LoopS (Loop Start),” or “End” point that is selected.

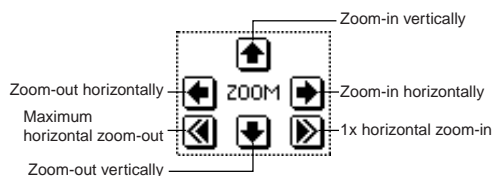

If you check “Use Zero,” locations where the waveform is at zero will automatically be found and selected when you use the [VALUE] dial etc. to set “Start,” “LoopS (Loop Start),” or “End” points. This makes it easy to set these points to addresses that will not produce clicks or noise in the loop.

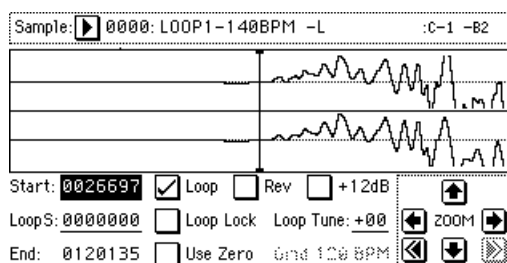

For this example, set “LoopS (Loop Start)” and “Start” to the same value.

**note** If desired, you can make a dotted vertical line appear in the sample waveform display to indicate the BPM. If you use this function with waveforms that have a specific BPM, it will be easier to make accurate settings for “End.”

- 17 Select the page menu command “Grid” to access the dialog box.

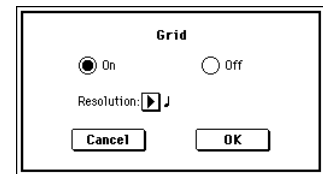

Check “Grid,” set “Resolution” to ♩, and press the **OK** button.

Set “Grid” to **140**. With these settings, vertical dotted lines will be displayed at 140 BPM quarter note intervals.

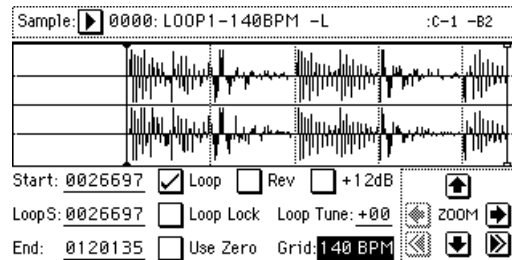

Set “End.”

When “Loop” is On, the dotted vertical “Grid” lines will start at “LoopS (Loop Start).” If you want to set “End” at the end of one 4/4 measure, the fourth vertical line from the “LoopS (Loop Start)” line will be the end of the first measure. Place “End” at this vertical line.

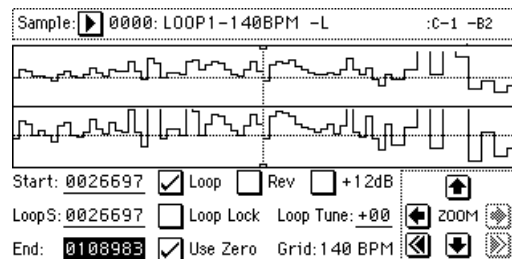

- 18 Use “Truncate” to delete the unwanted data that is outside of the start (or loop start) and end addresses. Select the page menu command “Truncate” to access the dialog box.

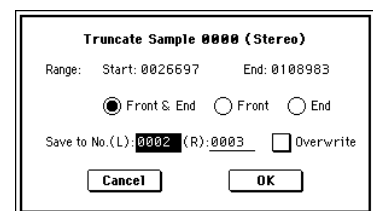

Select the **Front & End** radio button.

In this example, we will not change the settings of the “Save to No.” and “Overwrite” check boxes, so press the **OK** button to execute. When you execute the operation, the truncated samples 0002: LOOP1-140B0002-L and 0003: LOOP1-140B0002-R will be automatically assigned to Index 1.

**note** Please refer to “A note on saving samples” (p.77) for a cautionary note regarding the “Save to No.” and “Overwrite” check boxes.



## Sample (waveform data) editing

Editing the waveform data of the sample is done in P1: Sample Edit. You can use commands such as cut, copy, and normalize to edit the waveform data.

- 1 **Select the sample that you wish to edit.**  
Use “Sample Select” or “Index” in the P1: Sample Edit page or the P0: Recording, Recording page to select the sample. (p.69)
- 2 **Select the P1: Sample Edit page.**

 If you use “Sample Select” to select the sample, be aware that the index assignment will also change.

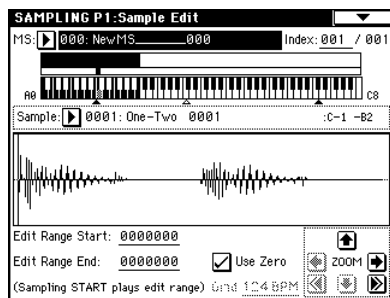

The waveform data of the currently selected sample will be displayed.

**note** Sample waveforms that were recorded with a “Sampling Mode” of Stereo will be shown in two lines. The upper line is the L channel waveform, and the lower line is the R channel waveform.

- 3 **Use “Edit Range Start” and “Edit Range End” to specify the range that you wish to edit.**  
The selected range will be highlighted.

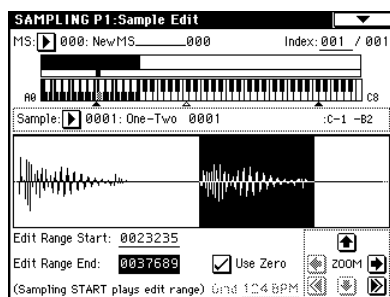

If you wish to hear the sound of the selected range, press the SAMPLING [START/STOP] key. The selected range will play back at the pitch of the base key (the key shown in gray on the keyboard display). You can select the base key by holding down the [ENTER] key and playing a note on keyboard.

When you play a key to which the sample is assigned (the highlighted range of the keyboard displayed in “Keyboard & Index”), the sample will be played back according to its loop settings.

**note** The procedure for using the ZOOM and “Use Zero” check boxes is the same as for P2: Loop Edit.

- 4 **From the list of page menu, select the desired editing command. Make the appropriate settings in the dialog box, and press the OK button to execute.**

For details on each command (p.119).

### • A note on saving samples

In the dialog boxes of some page menu, there is a “Save to No.” setting that lets you specify the sample number to which the edited sample will be saved. At this time, a vacant sample number will be selected automatically, so you will change the setting only if you want to specify the save destination number.

If you check “Overwrite” in the dialog box of the command, the data prior to editing will be deleted, and will be overwritten by the edited data. Normally, you will execute the Write operation without checking this, so that the unedited data is preserved. When you are completely finished with your editing, you can use the page menu command “Delete Sample” to delete unneeded samples.

 In Sampling mode, there is no Compare function that lets you compare the data before and after editing. If you wish to preserve the unedited state of the multisample or sample, use “Copy Sample” or “Copy MS” (p.108, 109) to copy the sample or multisample before you begin editing.

For some page menu commands in P1: Sample Edit or P2: Loop Edit, you can execute without checking the “Overwrite” setting in the dialog box, so that the sample data previous to editing will be preserved.

## Multisample editing

Editing a multisample is accomplished with a number of operations i.e. creating indexes for the multisample and assigning a sample to each index, editing operations such as deleting, copying, and inserting indexes, and detailed settings such as sample level and pitch for each index. Multisample editing is performed in P3: Multisample.

**note** Basic settings such as creating indexes and assigning samples can also be made in the P0: Recording, Recording page.

### Editing the indices

To change the number or order of the indexes, use the Insert, Cut, Copy, and Create buttons.

- 1 **Select the P3: Multisample.**

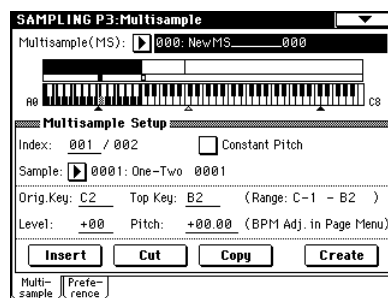

- 2 **Use “Multisample (MS)” to select the multisample that you wish to edit.**

3 **Select the “Index.”**  
You can also select an index by holding down the [ENTER] key and playing a note on the keyboard.

- 4 **Press the buttons to modify the number or order of the indices, and edit them.**

To delete the selected index, press the Cut button. The Insert button is used in conjunction with the Cut and Copy buttons. The contents of the index that was Cut or Copied will be inserted.

The Create button has the same function as the Create button in P0: Recording (“Creating multisample indexes and sampling” [PG p.69](#)).

### Modifying the settings of an index

- ① **Make the settings described in steps ①–③ of “Editing the indexes.”**
- ② **Set parameters for the selected index.** ([PG p.135](#))
  - Changing the “Top Key” will change the upper limit of the zone. Simultaneously, the lower limit of the next-numbered index will also change.
  - If you check “Constant Pitch,” all notes in the index zone will sound the sample at its original pitch.
  - “Pitch” adjusts the sample pitch for each index. You can use the “Pitch BPM Adjust” page menu command to set the loop interval to a desired BPM value ([PG p.136](#)).

### Converting a multisample to a program

In pages P0: Recording–P4: Controller Setup, you can select and execute the “Convert MS To Program” page menu command. When you execute this command, the settings of the currently selected multisample will be converted into a program. In Program mode you can make filter, amp and effect settings etc., and play the sample as a program. The resulting program can be used in a combination or song.

For details on the “Convert MS To Program” page menu command ([PG p.110](#)).

#### ● Using samples in a drum kit

A sample you created in Sampling mode can be used as one of the instruments in a drum kit. In the Global P5: Drum Kit, Sample Setup page and Low Sample page, set “Drumsample Bank” to RAM, and use “Drumsample” to select the sample that you created.

### Using Time Slice to divide a sample, and playing it in Sequencer mode

Time Slice is a function that detects the attack of the kick or snare etc. in a rhythm loop sample (a sample consisting of a looped pattern of drums etc.), and automatically divides it into separate instrumental sounds. Each of the divided instrumental sounds is made into a sample of its own, and then automatically expanded into a multisample and program. Pattern playback data for the Sequencer mode using the divided samples is also created automatically.

The time-slices sample can be used in the following ways by the song of Sequencer mode.

- Multiple rhythm loop samples of differing tempo can be matched to the same tempo without changing their pitch.
- You can change the tempo in realtime without affecting the pitch.

As an example, we will describe how a rhythm loop sample can be time-sliced in Sampling mode, and then how the rhythm loop sample can be played in Sequencer mode.

You will need to provide rhythm loop samples of drums etc. You can either record these on the TRITON Extreme, or load them in Media mode. Initially, you should try this using a one-measure pattern in 4/4 time with a fairly simple beat, and record the pattern as a mono rhythm loop sample.

For this example, we will use a 120 BPM rhythm loop sample.

- ① **Select “Sample Select” 120 BPM rhythm loop sample.**

**note** Play back the sample, and verify that the beats that you want to loop are played cleanly. If they are not played cleanly, make the appropriate settings for the start address “Start” and end address “End,” and execute the page menu command “Truncate” ([PG p.74, 76](#)).

- ② **Access the P2: Loop Edit page.**

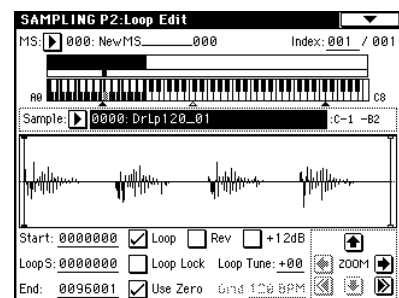

- ③ **Select the page menu command “Time Slice.”**  
The Set Sample Tempo dialog box will appear.

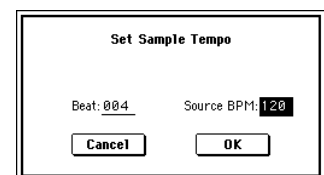

- ④ **Specify the number of quarter-note beats in the sample, and its tempo.**

If you know the BPM, set “Source BPM.”

If you do not know the BPM, set “Beat” and the BPM will be calculated automatically. Since in this example we know the beat, set “Source BPM” to 120.

⑤ **Press the OK button.**

The sample will automatically be sliced, and a dialog box will appear.

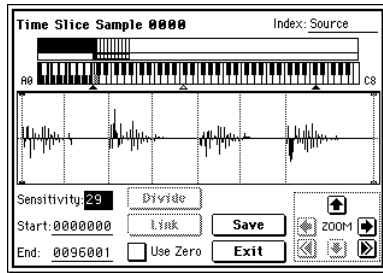

When you play the keyboard, C2 will play the original sample (Source), and D2 and subsequent keys will play the divided samples.

While listening to each divided sample, adjust “Sensitivity” so that each drum strike or other rhythm instrument sound is divided into its own sample. In some cases, it may not be possible to slice the sample cleanly even if you adjust “Sensitivity.” If the attack of the next sound is included in the end of the preceding sample, or if one sample contains two notes, you will need to edit the samples.

**note** If you want to edit, hold down the [ENTER] key and select the “Index” that is assigned to the note that you want to edit. (This portion of the waveform display will be highlighted.) Then you can make adjustments by adjusting “Start” or “End,” and by using Divide to separate or Link to combine. (PG p.128)

⑥ **Press the Save button.**

The Save Samples & MS dialog box will appear. Here you can save the time-sliced samples and the multisample.

At this time, set the items in the *Save With* area to specify the conversion destination for the program that will use the samples and multisample, and for the performance data (track or pattern) that will be used in Sequencer mode to “recreate” the rhythm loop sample.

- **If you want to create the performance data in a track**  
Turn “Program” and “Seq.Event” On (checked)  
Program: E101  
Track: On  
Song: 000, Track: 01, Meter: 4/4  
Start Measure: 001, Time: 008

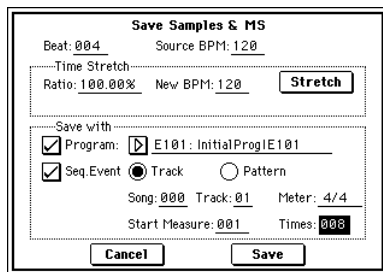

**Press the Save button to save the data.**

You will return to the dialog box of step ⑤.

- **If you want to create the performance data in a pattern**

In order to audition the performance data as it would be if created as a pattern, press the Save button once again to access the Save Samples & MS dialog box.

Turn “Program” and “Seq.Event” On (checked)

Program: E102

Pattern: On

Song: 001, Pattern: U00, Meter: 4/4

RPPR: On (checked), Key: C#2, Track: 01

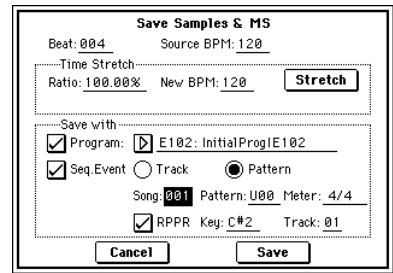

**Press the Save button to save the data.**

You will return to the dialog box of step ⑤.

- ⑦ **Press the Exit button to return to the screen of step ②.**
- ⑧ **Press the [SEQ] key to enter Sequencer mode, and select 000 for “Song Select.”**



The following song data has been set/created automatically as you specified in step ⑥.

- P0: Play/REC page  
Song: 000, Meter: 4/4, Tempo: 120
- P0: Play/REC, Program T01-08 page  
Track01 Program: E101
- P5: Track Edit, Track Edit page  
Track01: track data: 8 measures (D2-)

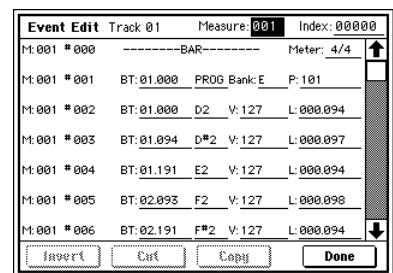

**Press the SEQUENCER [START/STOP] key to start playback.**

As an example, set “J (Tempo)” to 100. Notice that the pitch does not change when you play back at a different tempo.

**note** If the beat of the original rhythm loop sample is not reproduced correctly when you change the tempo, or if obtrusive noise is heard, this is because the sample was not sliced appropriately in step ⑤. The way in which the percussion instrument sounds were divided will have a major impact on the quality of the playback when the tempo is changed. You will need to adjust the way in which the samples are divided in step ⑤.

**note** The silence between samples may become obtrusive if you play back at a slower tempo, or noise may occur between samples if you play back at a faster tempo. To avoid such problems, you can set Stretch “New BPM” or “Ratio” in step ⑥ to the tempo at which you want to play back, and execute time stretch to adjust the length of each sample. (PG p.130 ⑨)

⑨ In “Song Select,” choose 001.



The following song data has been set/created automatically as you specified in step ⑥.

- P0: Play/REC page  
Song: 001, Meter: 4/4, Tempo: 120, RPPR: On
- P0: Play/REC, Program T01-08 page  
Track01 Program: E102
- P6: Pattern/RPPR, RPPR Setup page  
Key: C#2, Assign: On,  
Pattern: User, U00, Track: Track01  
Pattern data: 1 measure (D2-)

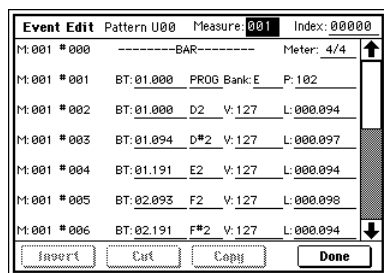
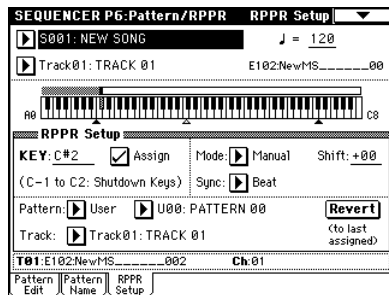

In the P6: Pattern/RPPR, Pattern Edit page, press the SEQUENCER [START/STOP] key to start playback of pattern U00.

When you press the C#2 key in the P6: Pattern/RPPR, RPPR Setup page, the RPPR function will start playing pattern U00.

In the same way as in step ⑧, changing the playback tempo will not affect the pitch.

## Sampling in Program, Combination, or Sequencer modes

External audio sources can be sampled from the various input jacks in Program, Combination, and Sequencer modes as well.

A performance in the above modes can also be internally resampled in digital form. You can resample a performance that uses the TRITON Extreme's full range of features (filters, effects, arpeggiator, and sequencer).

You can also sample the TRITON Extreme's performance together with audio from an external input source, or monitor the performance of the TRITON Extreme's arpeggiator and sequencer etc. while you sample only the external audio from the input jacks.

In Sequencer mode, you can sample external audio while listening to a song play back, and automatically create note data in the track that will play the sample when the track is played back. This allows you to sample vocals or guitar while the sequencer runs, just as though you were using a multitrack recorder. (This function is called “In-Track Sampling.”)

For examples of sampling in Program and Combination modes, refer to QS p.22. The sampling procedure in Combination mode is the same as in Program mode.

### Sample an arpeggiated drum phrase together with an externally-input guitar

Here's how you can resample an arpeggiated performance together with an external audio input source.

In this example, we will explain how a guitar connected to the AUDIO INPUT jack can be played along to a drum pattern played by the TRITON Extreme, and how both can be sampled together.

**note** Sampling can be performed in a similar way in Combination and Sequencer modes as well as in Program mode.

**note** In this example we will send the external audio input source to INDIVIDUAL 1, so if you want to monitor the sound being sampled, connect AUDIO OUTPUT (MAIN) L/MONO, R, and (INDIVIDUAL) 1 to your mixer, and use headphones etc. to monitor the output of the mixer.

- ① Press the [PROG] key to enter Program mode, and select the K020: Processed Kit program.
- ② Turn on the arpeggiator (ARPEGGIATOR [ON/OFF] key is lit), and play the keyboard to make sure that a drum phrase is sounded. Press the Arpeggio tab, and make sure that “Latch” is checked. Also adjust the arpeggiator tempo “J” as desired.
- ③ Press the ARPEGGIATOR [ON/OFF] key to turn off the arpeggiator.

- ④ **Connect your guitar to the rear panel AUDIO INPUT 1 jack.**  
Set the AUDIO INPUT [MIC/LINE] switch to the **LINE** position, and set the [LEVEL] knob to approximately the **center position**.

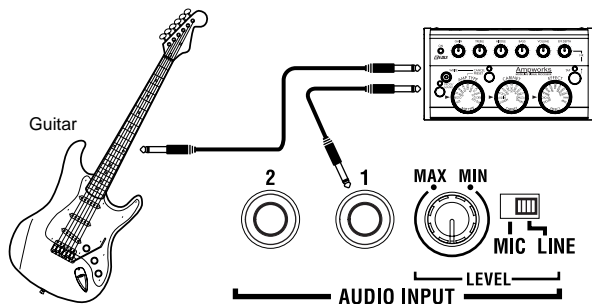

- ⚠ If you are using a guitar with passive pickups (i.e., without an internal pre-amp), the mismatch of impedance levels will make it difficult to sample at an appropriate level. You should route the signal from the guitar through a pre-amp or effect unit.

- ⑤ **Use “Auto Sampling Setup” to make settings.**  
We’ll start by making settings to sample a drum phrase. Make settings as described in “Resampling an arpeggiated phrase in Program mode” (p.22), steps 3–9.

- ⑥ **Modify the settings so that the input signal from the AUDIO INPUT 1 jack will be sent to the L channel.**  
Input 1 “Level”: 127, “Pan”: as desired  
“BUS (IFX/Indiv.) Select”: L/R

- ⑦ **Specify how recording will be initiated.**  
For this example, make settings so that recording will begin after a metronome count-in.

“Trigger”: Sampling START SW  
Sampling will begin when you press the SAMPLING [START/STOP] key.

“Metronome Precount”: 4  
After you press the SAMPLING [REC] key to enter record-ready mode and then press the SAMPLING [START/STOP] key, recording will begin after a four-measure count-in.

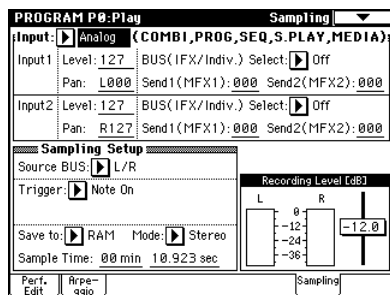

- ⑧ **Play your guitar at the volume that you will be recording.**  
If the display indicates “ADC OVERLOAD !!” (AD converter input overload), turn the rear panel [LEVEL] knob toward MIN to adjust the level appropriately.

- ⚠ The best audio quality will be obtained at the highest possible level that does not cause an overload; i.e., a level that is slightly below the point where “ADC OVERLOAD !!” is displayed.

- ⑨ **Press the SAMPLING [REC] key.**  
Play your guitar, and the level meter will indicate the volume at which the guitar will be sampled.  
Press the ARPEGGIATOR [ON/OFF] key to turn it on, play the keyboard to start the arpeggio, and play your guitar while adjusting the final volume.

Adjust the recording level as necessary, using the “Recording Level” slider located at the right of the display.

- ⚠ If the balance between instruments is not to your liking, use the [LEVEL] knob or the performance editor “Amp Level” to adjust the balance.

- ⑩ **When you have finished making adjustments, press the SAMPLING [REC] key.**  
Press the ARPEGGIATOR [ON/OFF] key to turn off the arpeggiator.

- ⑪ **Press the ARPEGGIATOR [ON/OFF] key to turn it on, and then press the SAMPLING [REC] key to enter record-ready mode.**  
When you press the SAMPLING [START/STOP] key, a count-down will begin. **Play the keyboard during the count-down.**

**After a four-beat count-down,** recording will start. **Play your guitar.** The arpeggiator will also start after the count-down.

- ⑫ **Press the SAMPLING [START/STOP] key to stop recording.**

- ⑬ **Press the ARPEGGIATOR [ON/OFF] key to turn it off.**

- ⑭ **Listen to the sound that was sampled.**  
Press the Perf.Edit tab to select the P0: Play, Performance Edit page, and select the convert-destination program.

## Record an external audio input source while a song plays, and create event data at the same time (In-Track Sampling function)

As an example, here's how the sound of a guitar connected to the AUDIO INPUT 1 jack can be added to a song you created.

**note** In this example we will send the external audio input source to INDIVIDUAL 1, so if you want to monitor the sound being sampled, connect AUDIO OUTPUT (MAIN) L/MONO, R, and (INDIVIDUAL) 1 to your mixer, and use headphones etc. to monitor the output of the mixer.

- ① **In Sequencer mode, select the song to which you want to add the guitar sound.**  
You can either create a song, or use Media mode to load a previously-created song.
- ② **Connect your guitar to the rear panel AUDIO INPUT 1 jack.**  
Set the AUDIO INPUT [MIC/LINE] switch to the LINE position, and set the [LEVEL] knob near the center position.
- ⚡ If you connect a passive-type guitar (without an internal preamp), the impedance mismatch will make it difficult to sample at an appropriate level. This type of guitar should be sent through a preamp or effect processor.
- ③ **Access the Sequencer P0: Play/REC, Sampling page.**
- ④ **Press the page menu button, and choose "Auto Sampling Setup" from the menu.**  
The dialog box will appear.
- ⑤ **Choose "In-Track Sampling."**

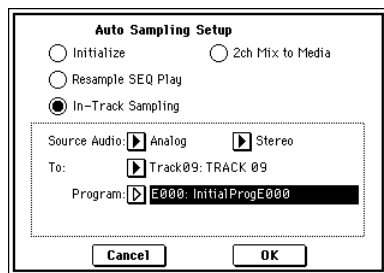

- ⑥ **Make the following settings for "In-Track Sampling."**  
Set **"Source Audio"** to **Analog**. The external audio input source (the analog audio output of an instrument or other device connected to the INPUT 1, 2 jacks) will be sampled.  
Set **"Mono-1/Mono-2/Stereo"** to **Stereo**. The sound will be sampled in stereo.  
Set **"To"** to the track you want to use for In-Track Sampling. A MIDI note for triggering the sample will be recorded in the track you specify.  
Set **"Program"** to the convert-destination program number. When sampling is completed, a new multi-sample will be automatically created, converted to a program, and assigned as the program for the track.

- ⑦ **Press the OK button to execute the command.**  
Preparations for In-Track Sampling are now completed.

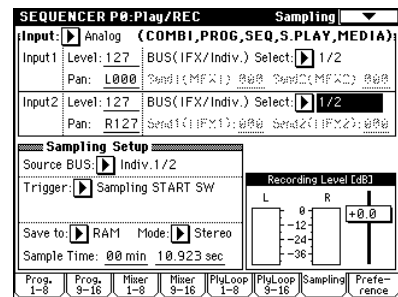

- note** Let's take a look at the settings that were made.  
Input 1 **"Level": 127, "Pan": L000**  
**"BUS (IFX/Indiv.) Select": 1/2**

These settings specify the input level from the INPUT 1 jack and the panning, and select the 1/2 bus as the destination.

**"Source BUS": Indiv 1/2**

The sound sent to the 1/2 bus will be sampled.

**"Trigger": Sampling START SW**

After you press the SAMPLING [REC] key to enter sampling-ready mode, recording will begin when you press the SAMPLING [START/STOP] key.

**"Recording Level": +0.0**

This is the default setting for recording an external input.

**"Save to": RAM**

The sampled data will be written to sample memory (RAM).

**"Mode": Stereo**

The sound of the internal L/R channels will be sampled in stereo.

- ⚡ Be aware that if you change the "BUS" setting from Off to L/R or IFX1-5, the volume level sent to the AUDIO OUT L/MONO, R jacks and to the headphones may rise excessively.

- ⑧ **For this example, change the settings as follows.**  
**"Pan": C64**  
**"Trigger": Threshold, "Level": as desired**  
**"Sample Time": as desired**

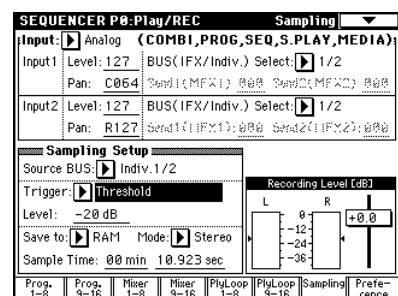

- ⑨ **Set the recording level.**  
Play your guitar at the volume at which you will record.  
If the display indicates **"ADC OVERLOAD !!"** (AD converter input overload), adjust the rear panel [LEVEL] knob toward MIN until the level is appropriate.

**Press the SAMPLING [REC] key.**

When you play your guitar, the level meter will indicate the volume at which the guitar will be sampled.

If the display indicates **"CLIP!!,"** use the VALUE controllers to lower the "Recording Level" slider (in the

right of the display) below +0.0 to an appropriate level. This adjustment will not affect the output volume, but will affect the data that will be sampled.

**When you have finished making adjustments, press the SAMPLING [REC] key.**

⑩ **Begin sampling.**

Press the SAMPLING [REC] key, and then the SAMPLING [START/STOP] key to enter recording-standby mode.

Press the [LOCATE] key to reset the song playback location to the beginning of the song, and press the SEQUENCER [START/STOP] key to play back.

If you want to verify the location, press the Prog.9-16 tab to access the Program T09-16 page.

**Begin playing at the point where you want to record.** Sampling will begin when the Threshold “Level” volume is exceeded.

⑪ **At the point where you want to stop sampling, press the SEQUENCER [START/STOP] key.**

Song playback and sampling will end.

Sampling will also stop if the specified “Sample Time” is reached.

Event data and a program will be assigned to the track you specified in “Select Bank & Smp1 No.”

⑫ **Press the [LOCATE] key to return to the beginning of the song, and press the SEQUENCER [START/STOP] key. Notice that the sampled audio is played back along with the song.**

**note** For details on how the Compare function works for In-Track Sampling, refer to p.60.

## Resampling a song to create a Wave file

Here’s how you can resample your song to media.

**note** A Wave file you resampled to media can be burned to a CD-R/RW drive connected to the USB A connector to create an audio CD, refer to p.123.

**note** For details on the types of media you can use, refer to p.137.

① **In Sequencer mode, select the song from which you want to create a WAVE file.**

Either create a song, or use Media mode to load a previously-created song.

**⚠** A maximum of 80 minutes for either mono or stereo can be written to media in one sampling operation (mono: approximately 440 Mbytes, stereo: approximately 879 Mbytes).

② **Access the Sequencer P0: Play/REC, Sampling page.**

③ **Press the page menu button, and choose “Auto Sampling Setup” from the menu.**

A dialog box will appear.

④ **Choose “2ch Mix to Media.”**

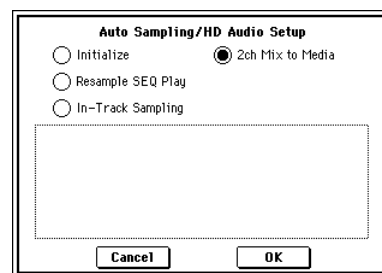

⑤ **Press the OK button to execute the command.**

Preparations for In-Track Sampling are now complete.

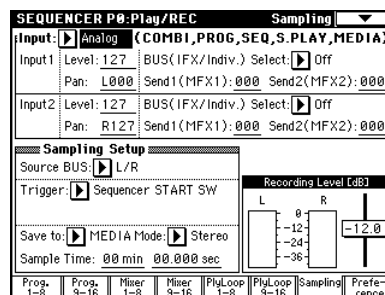

**note** Let’s take a look at the settings that were made.

Input 1 “BUS (IFX/Indiv.) Select”: Off

Input 2 “BUS (IFX/Indiv.) Select”: Off

Nothing will be input from the INPUT 1, 2 jacks.

“Source BUS”: L/R

The sound sent to the L/R bus will be sampled.

“Trigger”: Sequencer START SW

After you press the SAMPLING [REC] key and the [START/STOP] key to enter record-ready mode, recording will begin when you press the sequencer [START/STOP] key.

“Recording Level”: -12.0

This is the default setting for resampling.

“Save to”: MEDIA

The resampled data will be written to media.

“Mode”: Stereo

The sound of the internal L/R channels will be sampled in stereo.

- ⑥ **Select the page menu command “Select Directory,” and specify the destination to which the WAVE file will be written.**

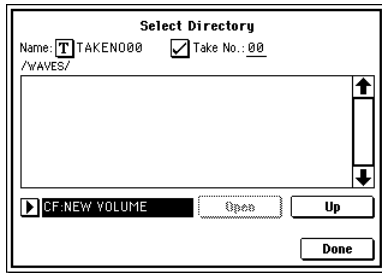

Use media select and the Open and Up buttons to select the directory in which the WAVE file will be saved.

If you want to create a new directory, access the Media mode Utility page, and execute the page menu command “Create Directory.”

Press the text edit button to access the text edit dialog box, and input a filename (up to six characters). Leave “Take No.” checked. The number at the right of “Take No.” will be input as the last two characters of the filename.

This number will increment each time you sample, ensuring that the filename will not be the same even if you sample repeatedly.

After you have made the settings, press the **Done button** to close the dialog box.

- ⑦ **Set “Sample Time” to the length that you want to sample.**  
Set this to a length slightly greater than the length of the song.
- ⑧ **Set the recording level.**  
Press the SAMPLING [REC] key.

 It will take between several seconds to nearly a minute from the moment you press the SAMPLING [REC] key until the TRITON Extreme enters standby mode (i.e., until the SAMPLING [REC] key changes from blinking to lit). This time is required in order to allocate sufficient space on the media.

Press the SEQUENCER [START/STOP] key to play back the song, and adjust the resampling volume while you watch the level meters.

If the level meter indication is too low, use the VALUE controller to raise the level from -12.0 as far as possible without causing the “CLIP!!” indicator to appear. The output volume will not change at this time, but your adjustment will affect the data that will be sampled. (p.67)

**note** The power-on default setting is -12.0 dB. At the -12.0 dB setting, CLIP!! will not appear even if the song is played back at the maximum level.

When you finish making adjustments, press the SAMPLING [REC] key.  
Press the SEQUENCER [START/STOP] key to stop the song playback. Then press the [LOCATE] key.

- ⑨ **Start sampling.**  
Press the SAMPLING [REC] key and then the SAMPLING [START/STOP] key to enter recording-standby mode.  
Press the SEQUENCER [START/STOP] key to play back the song. Sampling will begin at the same time.
- ⑩ **When the song finishes playing back, press the SAMPLING [START/STOP] key to stop sampling.**  
Use the page menu command “Select Directory” to verify that the WAVE file was created. Select the file and press the SAMPLING [START/STOP] key to listen to the sound that was sampled.

**note** The pickup level of a WAVE file is specified by the “WAVE File Play Level” (PG p.158).



# SMF (Standard MIDI File) playback

In Song Play mode you can load and play Standard MIDI File (SMF) data directly from media. If you're playing SMF data, using Song Play mode will provide a higher degree of reproducibility than using Sequencer mode to play the data.

**note** For details on the types of media you can use, refer to p.137.

## How Song Play mode is structured

Song Play mode is structured as follows.

This mode consists of tracks 1–16, song parameters such as song name etc., effects, and the arpeggiator.

Song Play mode page structure

Page	Explanation
P0: Program/Mix	Play SMF data and make settings. Specify the program, pan, and level for each track.
P1: Track	Make MIDI and scale settings for each track. If the separately sold EXB-MOSS option is installed, set related parameters.
P2: Controller Setup	Controller settings.
P3: Select Directory/ Jukebox	Select the directory that contains the desired SMF, and select the playback order of SMF files. Create jukebox lists.
P4:	---
P5:	---
P6:	---
P7: Arpeggiator	Arpeggiator settings
P8: Insert Effect	Select and make settings for insert effects. Make settings for the routing, insertion effects, master effects, and individual output assignments of each track in the song.
P9: Master Effect	Select and make settings for the master effects. Master EQ and Valve Force settings.

**note** For details on how to access each mode and page, refer to "Basic operation" (PG p.13).

**!** If the separately sold EXB-MOSS is installed, the special bank F can be used in Song Play mode as well. For details on the bank F parameters, refer to the EXB-MOSS owner's manual.

**!** The parameter settings of Song Play mode are not backed up when the power is turned off. If you wish to save the program, track parameter, and effect settings of the song, use the page menu command "Save Template Song" to save them.

### ● About Standard MIDI Files (SMF)

Song Play mode will play SMF Format 0 or Format 1 data. Only files with an extension of .MID are recognized as SMF by the TRITON Extreme.

### ● About MIDI

#### Track status settings in Song Play mode

You can select whether the musical data played by a track, or the data produced by operating the TRITON Extreme's keyboard and controllers will sound the TRITON Extreme's internal tone generator, and/or will sound an external tone generator.

When the "Status" of a track is set to INT, the data played back by that track and the data produced by operating the keyboard or controllers of the TRITON Extreme will play and control the TRITON Extreme's internal tone generator. When the "Status" of a track is set to EXT or BTH, the data played back by that track and the data produced by operating the keyboard or controllers of the TRITON Extreme will play and control an external tone generator. (The MIDI channel of the external tone generator must match the "MIDI channel" of the TRITON Extreme track that is set to EXT or BTH.) With a setting of BTH, the external tone generator and the TRITON Extreme's own tone generator will be played and controlled simultaneously. (PG p.146)



#### Synchronization with external devices

In Song Play mode, the TRITON Extreme will be the master (the controlling device) regardless of the MIDI Clock setting (Global P1: MIDI "MIDI Clock").

### ● Effects and Valve Force

You can use the TRITON Extreme's insert effects, master effects, and Valve Force in the same way as in Sequencer mode. (PG p.105, 107, 110, 111, PG p.151)

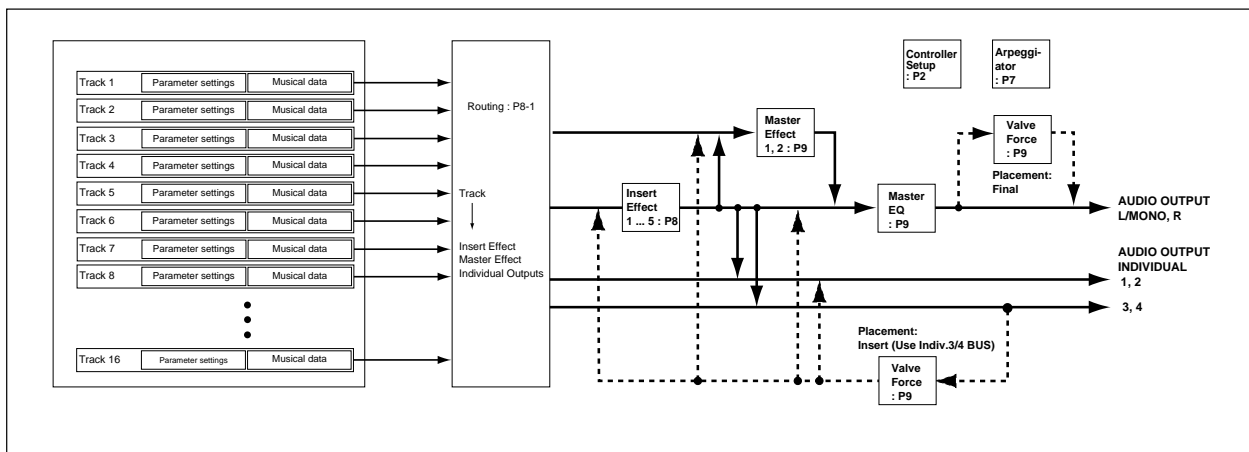

## Playing SMF data

### Direct playback from media

When you wish to playback SMF data that is compatible with the GM/GS/XG standards, set “**Bank Map**” (Global P0: Basic Setup, System Preference page) to **GM(2)**.

If you want to play back from media inserted in the TRITON Extreme’s CF card slot, you must turn off the power before inserting the media.

- Press the [S.PLAY] key to enter Song Play mode.
- Press the [EXIT] key to display the P0: Prog/Mix page.
- Make sure that the media containing the SMF data can be detected.

If there is no SMF data in the media, or if there is no SMF data in the currently selected directory, no filename will be displayed (as shown below).



To move to a directory that contains SMF data, press the [MENU] key, and then press “P3: Select Directory” to display P3: Select Directory.

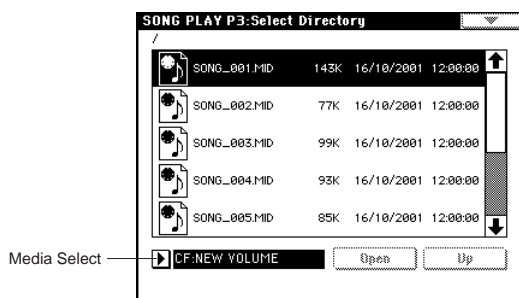

Use “Media Select” to choose the drive containing the data you want to play. Then use the Open button and Up button to move between directories to find the desired SMF.

When the SMF file (make sure that the extension is .SMF) appears in the LCD screen, press the [EXIT] key, and move to P0: Prog/Mix.

“File Select” will show the SMF filenames.

**note** If no jukebox list has been created, no filenames will be displayed if the “**Jukebox**” check box is checked. Uncheck the “Jukebox” check box.

- Press the “File Select” popup button. From the file list, choose the filename that you wish to play back.



- Press the SEQUENCER [START/STOP] key. Playback will begin. At this time, all songs displayed in the “File Select” popup button will playback consecutively (if “Auto Start” is checked).
- Press the SEQUENCER [START/STOP] key once again to stop playback.

### Starting/stopping playback for each song

In the P0: Prog/Mix, Preference page, uncheck “Chain to next file” or “Auto Start,” and press the SEQUENCER [START/STOP] key. Playback will begin, and will stop when each song ends. For details on these settings (PG p.145).

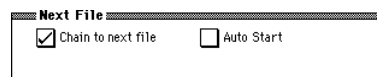

### Mute/Solo function

In P0: Prog/Mix, the Program T01-08 and T09-16 pages provide **PLAY/MUTE** buttons and **SOLO ON/OFF** buttons that allow you to play and mute tracks 1-16 in the same way as in Sequencer mode.

You can use these when you wish to mute the melody track and play the part yourself on the keyboard (“minus-one play”), or when you wish to audition a track (PG p.88).

You can use the “Solo Selected Track” page menu command to audition only the currently selected track. This provides a convenient way to hear the parameter settings and effect settings of a track (PG p.58, 144).

## Playback using the Jukebox function

The TRITON Extreme provides a Jukebox function that can be used to playback SMF data. This function allows you to specify the order in which files in the same directory will be played.

**⚠** Any jukebox list you create will be erased when the power is turned off, and cannot be recovered. If you wish to keep your jukebox list, refer to the section “Saving a Jukebox list,” and save it onto media.

## Playing back in the order of the jukebox list

- 1 Press the [EXIT] key to display the P0: Prog/Mix page.
- 2 Check the “Jukebox” check box.

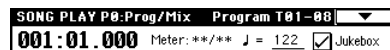

- 3 Select P3: Jukebox.

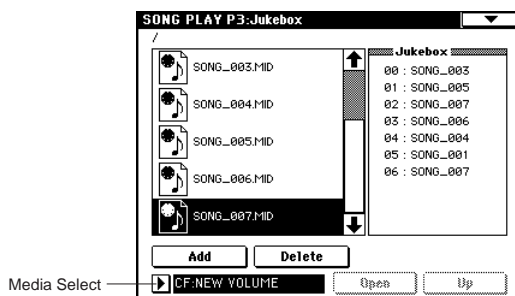

Press the media select popup button, and select the drive that contains the data that you want to play back.

- 4 Use the scroll bar to display the SMF (filename extension .MID) that will be played first, and select that file.
- 5 Press the Add button.  
The filename you specified in step 4 will appear in the Jukebox list.
- 6 Select the file that will be played second, and press the Add button.  
Add files to the Jukebox list in the order that they will be played. A maximum of 100 files (00–99) can be registered in the Jukebox list.  
To delete a file from the Jukebox list, press the Delete button.
- 7 Press the [EXIT] key to display P0: Prog/Mix.
- 8 Press the SEQUENCER [START/STOP] key.  
The files will playback in the order in which they were registered.
- 9 Press the SEQUENCER [START/STOP] key once again to stop playback.

**⚠** Only files in the same directory can be registered in a jukebox list.  
If you perform the following operations while creating a jukebox list, the jukebox list will be lost.

- Change the directory
- Exchanging the media
- Change drives

## Saving a Jukebox list

### Saving procedure

- 1 Use the procedure described above to create a jukebox list.
- 2 If you want to save the jukebox list on the media, use the P3: Jukebox drive select button to select the drive on which you want to save the data.
- 3 In P3: Jukebox, select the “Save Jukebox List” page menu command.

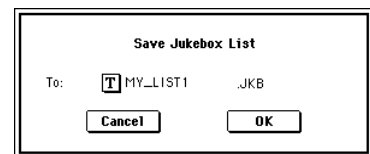

- 4 Use the text edit button to enter a name for the jukebox list (see p.115).
- 5 Press the OK button.  
The jukebox list will be saved to the media.

### Loading procedure

- 1 In the Jukebox page, select a jukebox list (filename extension .JKB).
- 2 Press the “Load Jukebox List” page menu command.  
The jukebox list will be loaded into the TRITON Extreme.

.....

## Playing along with SMF data

### Minus-one play

You can enjoy “minus-one” play by playing back SMF data, muting a specific part, and playing that part yourself.

- ① **Playback the SMF data, identify the track whose part you wish to play, and stop playback** (☞ p.86).
- ② **In P0: Prog/Mix, select the Prog. 1–8 tab or Prog. 9–16 tab.**
- ③ **Use “Play Track Select” to select the track for the part that you want to play from the keyboard.**  
When you play the keyboard, the program of the selected track will be heard.

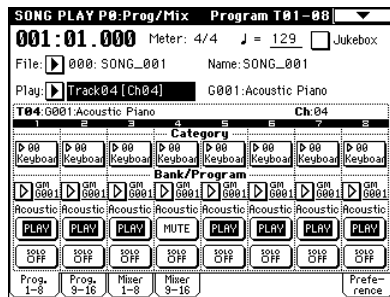

- ④ **Press the “PLAY/MUTE” button to set the track selected in step ③ to MUTE.**  
If you want the musical data of the track to playback in addition to your own playing on the keyboard, set “Play/Mute” to PLAY.
- ⑤ **Press the SEQUENCER [START/STOP] key to begin playback, and play along on the keyboard with the song.**

### Arpeggiator

You can use the arpeggiator for your keyboard performance (☞ p.96, PG p.149).

# Settings for the entire TRITON Extreme

(Global mode)

## How Global mode is structured

In Global mode you can make overall settings that apply to the entire TRITON Extreme, such as master tune, key transpose, effect global switch, global MIDI channel, and system clock.

In addition, you can create user drum kits, user arpeggio patterns, and scales, make settings for the damper pedal and assignable foot switches/pedals, and specify category names for programs and combinations.

Song Play mode page structure

Page	Explanation
P0: Basic Setup	Basic settings for the entire TRITON Extreme. Audio input settings for use outside of Sampling mode.
P1: MIDI	MIDI-related settings for the entire TRITON Extreme.
P2: Controller	Controller settings for the pedals etc. connected to the rear panel.
P3: User Scale	User registered scale settings. Specify 16 octave scales, and one all-note scale.
P4: Category Name	Edit category names for programs and combinations.
P5: Drum Kit	Edit drum kits.
P6: User Arpeggio	Edit user arpeggio patterns.
P7:	---
P8:	---
P9:	---

**note** For details on how to access each mode and page, refer to “Basic operation” (p.13).

The edits you perform in Global mode will be preserved until the power is turned off, but will not be preserved after the power is turned off unless you first save your settings. Three types of data are handled in Global mode: user drum kit settings (Global P5), user arpeggio pattern settings (Global P6), and all other global settings (Global P0–P4). Each of these can be written into their respective memory area. This data can also be saved to various types of media in Media mode. (p.116, 117)

Global mode does not provide a “Compare” function.

## Basic Setup

## P0: Basic Setup

### Basic Page

### Tuning to another instrument/Transposing

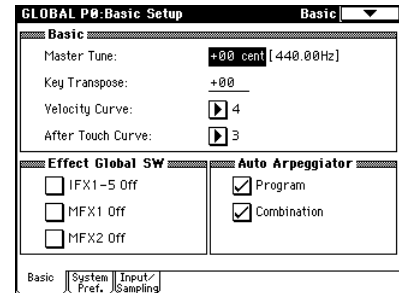

“**Master Tune**” adjusts the overall pitch. Edit this setting when you are playing the TRITON Extreme with other instruments, or when playing along with music on CD or tape. You can adjust the pitch in a range of  $\pm 50$  cents (one semitone = 100 cents).

“**Key Transpose**” shifts the pitch in semitone steps. Edit this setting when you want to transpose the sound of the entire TRITON Extreme. You can adjust the transposition in a range of  $\pm 1$  octave.

### Adjusting the way in which velocity or after touch will affect the volume or tone

You can adjust the way in which changes in velocity or after touch will affect the volume or tone. By changing this, you can (for example) make the volume of the notes more consistent even when they are played with varying velocities (dynamics). Each curve has its own character, so you can select the curve that is appropriate for your own playing dynamics, playing style, and the effect that you wish to obtain (PG p.155).

“**Velocity Curve**” selects the velocity curve, and “**After Touch Curve**” selects the aftertouch curve.

### Bypassing the effects

You can bypass the insert effects and master effects for the entire TRITON Extreme. For example if you’ve connected the TRITON Extreme’s outputs to an external mixer and are using an external effect processor to apply reverb or chorus to the sound along with other audio sources, you can turn off the TRITON Extreme’s master effects. If the *Effect Global SW* “**IFX 1–5 Off**,” “**MFX1 Off**,” and “**MFX2 Off**” items are **checked**, the insert effects, master effect 1, and master effect 2 will respectively be bypassed.

## Linking the arpeggiator to programs and combinations

You can specify whether the arpeggiator settings written into a program or combination will also be selected when you select a program or combination, or whether the current arpeggiator settings will be retained even if you switch programs or combinations.

When shipped from the factory, the former setting is selected. Choose the latter setting if you want to keep the same arpeggio pattern running while you switch only the program or combination.

If the *Auto Arpeggiator* “**Program**” or “**Combination**” box is **checked**, the arpeggio settings will also change when you select a program or combination respectively.

## System Preference page

### Recalling the last-selected mode and page at power-on

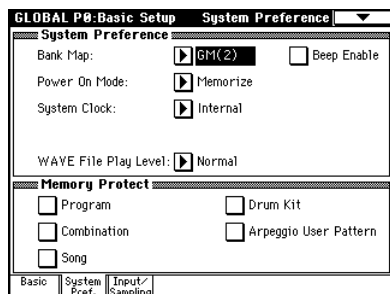

The state of TRITON Extreme when the power is turned on will depend on the setting of “**Power On Mode**”. If “Power On Mode” is **Reset** (factory setting), TRITON Extreme will automatically select the Combination mode P0: Play.

If “Power On Mode” is **Memorize**, TRITON Extreme will power on using the same mode and page that were last selected when the power was turned off.

The **Memorize** setting will remember the mode and page that were last selected, the combination number that was last selected in Combination mode, and the program number that was last selected in Program mode. If another mode is selected when the power is turned on, you can press the [COMBI] key or [PROG] key to select the P0: Play page with the last-selected combination number or program number.

### Sounding a beep when you press the LCD screen

If the “**Beep Enable**” check box is checked, a beep will sound when you press an object in the LCD screen. Uncheck this item if you don’t want a beep to sound.

### Protecting the memory

If one or more of the *Memory Protect* check boxes are checked, operations such as writing, loading, or song recording will be prohibited for the corresponding type of memory.

## Input/Sampling page

### Making audio input settings for other than Sampling mode

☞ Refer to p.107 and PG p.159.

## MIDI-related settings P1: MIDI

### MIDI Setup, MIDI Filter

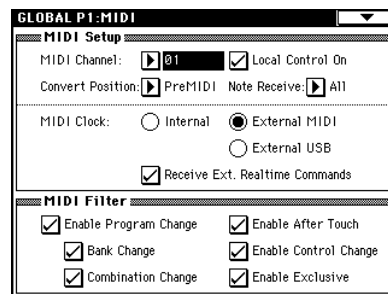

☞ Refer to PG p.161.

## Pedal and other controller settings P2: Controller

### Specifying the function of the ASSIGNABLE Switch and ASSIGNABLE Pedal

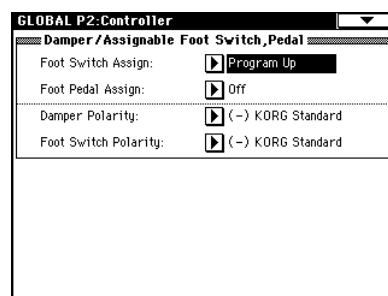

Sets the function of an assignable switch such as the optional Korg PS-1 connected to the **ASSIGNABLE SWITCH** jack.

- **This is set by “Foot Switch Assign.”**

This switch can act as a source for alternate modulation or effect dynamic modulation, or switch portamento on/off, control the sostenuto effect, turn the soft pedal effect on/off, turn the arpeggiator on/off, select programs or combinations (up/down), start/stop the sequencer, punch-in/out on the sequencer, or be a trigger and tap tempo to advance the cue list step (☞ PG p.281).

You can specify the function that will be performed by an assignable pedal (the optional XVP-10 or EXP-2) connected to the **ASSIGNABLE PEDAL** jack.

- **This is set by “Foot Pedal Assign.”**

This pedal can be used to control master volume, alternate modulation or effect dynamic modulation, portamento

pitch change speed, volume, the pan following an insert effect, pan, volume, or send levels to the master effects (PG p.282).

**note** You can use this as a source for alternate modulation or effect dynamic modulation, and use it to control program parameters or effect parameters. In this case, set “Foot Switch Assign” to Foot SW (CC#82), and “Foot Pedal Assign” to Foot Pedal (CC#04).

Here we will show how to make settings that allow an assignable switch to change programs or combinations.

- ① Press the “Foot Switch Assign” popup button, and press either Program Up or Program Down. Program Up will cause the next higher program number to be selected each time you press the foot switch. Program Down will cause the next lower program number to be selected each time you press the foot switch.
- ② Set the “Foot Switch Polarity” to the polarity of the foot switch you have connected. If you have connected a Korg PS-1 pedal switch, set this to (-) KORG Standard. If the polarity is not set correctly, the pedal will not function appropriately.
- ③ Either press the [PROG] key to enter Program P0: Play, or press the [COMBI] key to enter Combination P0: Play. When you press the foot switch, the program/combination will change.

## Creating original scales

### P3: User Scale

Creating a scale and assigning it to a program etc.

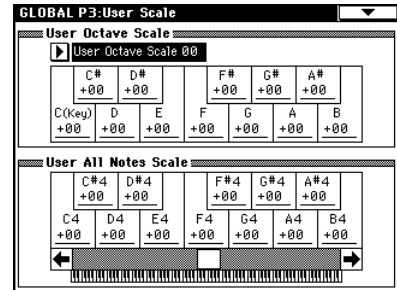

You can create your own original scales. You can create sixteen different **User Octave Scales** in which the pitch of each note of the octave is repeated for all octaves, and one **User All Note Scale** in which the pitch of each of the 128 notes can be specified independently.

By adjusting the pitch of each key in the range of  $\pm 99$ , you can raise or lower it by as much as approximately one semitone relative to the normal pitch.

The user scales you create here can be used by specifying the scale for a program, for each timbre of a combination, or for each track of a song (Sequencer/Song Play).

These settings are made by the *Scale* “Use Prog’s Scale” parameters in the following pages.

Program mode	Program P1: Edit-Basic, Program Basic
Combination mode	Combination P2: Edit-Trk Param, Other
Sequencer mode	Sequencer P2: Trk Param, Other
Song Play mode	Song Play P1: Track, Status/Scale

Here is how to set the scale type for each timbre in Sequencer mode.

- ① Create a user octave scale or a user all notes scale. Select a key, and use the VALUE controller to adjust the pitch. The range of  $\pm 99$  raises or lowers the pitch approximately one semitone above or below the standard pitch.

**note** You can also select a key by holding down the [ENTER] key and playing the desired note on the keyboard.

**note** You can copy one of the preset scales and edit it to create an original scale. Execute the page menu command “Copy Scale.”

- ② Press the [SEQ] key to enter Sequencer mode.
- ③ After pressing the [MENU] key, press the P2: Trk Param.
- ④ Press the Other 1–8 tab or Other 9–16 tab to select the Sequencer P2: Trk Param, Other page.
- ⑤ If you wish the program assigned to a track to use the scale saved with that individual program check the “Use Program’s Scale” check box for that track. Tracks that are not checked will use the scale specified by Scale “Type (Song’s Scale).”
- ⑥ Set “Type (Song’s Scale)” to select the scale for the currently selected song.

## Drum kit settings P5: Drum Kit

### What is a drum kit?

A drum kit assigns a different drum sample (PCM waveform data for drum sounds) to each note.

If you set a program's oscillator (specified by "Oscillator Mode") to Drums, the program will use a drum kit instead of a multisample.

The TRITON Extreme has 144 drum kit memory areas. When shipped from the factory, some of the 000 (A/B)–045 (I) and 128 (User)–131 (User) areas contain preloaded drum kits suitable for various musical styles.

144 (GM)–152 (GM) contain nine different preset drum kits that are compatible with the GM2 sound map. (For details on the factory-set drum kits, refer to "VNL".)

In the Global P5: Drum Kit page you can create your own original drum kit by changing the drum sample assigned to each key of a drum kit, and adjusting the pitch and level of each assigned drum sample. You can also create original drum kits using sample waveforms that you sampled on the TRITON Extreme or loaded into sample memory (RAM) in Media mode.

A drum kit that you edited or created can be written into one of the user drum kit memory areas 000 (A/B)–143 (User). Drum kits can also be saved to various types of media in Media mode.

### ● Multisample programs and drum kit programs

There are two types of programs: those whose oscillator uses a multisample, and those whose oscillator uses a drum kit.

This selection is made by the Program P1: Edit-Basic, Program Basic page "Oscillator Mode" setting. To use a multisample for the program, set "Oscillator Mode" to **Single** or **Double**. To use a drum kit, set "Oscillator Mode" to **Drums**.

### ● About program parameters

Just as the character and effect processing of a melodic instrument such as piano, organ, trumpet, or strings is fundamentally different from that of percussion instruments such as drums or timpani, the program parameter structure of a multisample program ("Oscillator Mode" = **Single** or **Double**) is fundamentally different from that of a drum kit program ("Oscillator Mode" = **Drums**).

The program parameters of a multisample specify filter and amp settings etc. appropriate for a multisample. For this reason, it is difficult to convert such a program for use with a drum kit. Thus if you wish to edit a drum kit, you should first use Program mode to select a program that uses a drum kit ("Oscillator Mode" = **Drums**), and then move to the Global P5: Drum Kit page.

### Editing a drum kit

Here's the procedure for editing a drum kit.

- 🔧 Before editing a drum kit, uncheck the Memory Protect (p.90).

- ① In Program P0: Play, select the program that you wish to use while editing the drum kit

Select a drum kit program from the preload programs etc. If the drum kit that you will be editing is already being used by a program, select that program. Otherwise, assign the drum kit you wish to edit to the program in the Program P1: Edit-Basic, OSC Basic page (In the separate "VNL," programs that use a drum kit are marked by a "d" symbol.)

- 🔧 Set "Octave" (Program P1: Edit-Basic, OSC Basic page) to +0 [8']. With a setting other than +0 [8'], the relationship between the keys and the sounds will be incorrect.

- 🔧 The effects will sound using the settings of the last-selected program.

- 🔧 When you edit a drum kit, all programs that use that drum kit will be affected.

- ② Access the Sample Setup page of Global P5: Drum Kit.

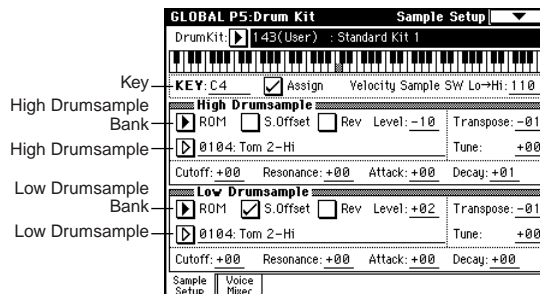

- ③ In "Drum Kit," select the drum kit that you wish to edit.

If necessary, use the page menu command "Copy Drum Kit" to copy settings from a preload drum kit or a GM drum kit.

- 🔧 GM drum kits 144 (GM) – 152 (GM) cannot be selected here. (It is not possible to edit or write a GM drum kit.) If you wish to modify the settings of one of the drum kits 144 (GM) – 152 (GM), you can use "Copy Drum Kit" to copy it to 000 (A/B) – 143 (User), and then edit the copy.

- ④ Use "Key" to select the note number that you wish to edit.

The drum sample parameters for the selected note number will be displayed in the *High Drumsample*, *Low Drumsample*, and *Voice/Mixer* pages.

To select a note number, you can use the VALUE controllers, or you can hold down the [ENTER] key and press a note on the keyboard.

- ⑤ Use the "Assign" check box to specify whether a drum sample will be assigned to the note number.

If this is checked, a drum sample will be assigned to that note number. Normally you will check this. If this is not checked, no drum sample will be assigned to that note number. That note number will sound the drum sample assigned at its right, but a semitone lower. Use this setting when you want only to change the pitch, such as with tom or cymbal sounds.

- note** If you uncheck the "Assign" check box so that the drum sample at the right will be played at a pitch one semitone lower, access the Program P2: Edit-Pitch, OSC1 Pitch Mod. page, and set "Pitch Slope" to +1.0 before you enter Global mode.



- ⑥ Use “High Drumsample Bank,” “High Drumsample,” “Low Drumsample Bank,” and “Low Drumsample” to specify the drum sample that will be assigned to this note number.

If you have selected a Low Drumsample, use “Velocity Sample SW Lo→Hi” to specify how velocity will switch between the High Drumsample and Low Drumsample. (☞p.7)

If you set “High/Low Drumsample Bank” to ROM, you’ll be able to select ROM drum samples. If you set it to RAM, you’ll be able to select samples you sampled on the TRITON Extreme or loaded in Media mode.

**note** About the ROM drum samples

The TRITON Extreme contains 1,175 different drum samples in ROM. When you press the popup button, you will be able to select ROM drum samples from 15 categories. (☞For a list of the drum sample names, refer to “VNL”)

- ⑦ Use “Velocity Sample SW Lo→Hi” to specify how velocity will switch between drumsamples.

The drumsample that sounds when you perform will depend on the velocity (keyboard playing strength) of the incoming note. This is called velocity drumsample switching.

If you set this to 001, only the High Drumsample will sound.

☞ This is the same type of function as the Velocity Multisample Switching in a program. (“High Multisample and Low Multisample” ☞p.24)

- ⑧ Set the parameters of the drumsamples that you assigned.

Set the parameters for the High Drumsample and Low Drumsample.

You can set parameters such as volume level (“Level”), pitch (“Transpose,” “Tune”), and tone (“Cutoff,” “Resonance”). (☞For details on each parameter, refer to PG p.168.)

- ⑨ As necessary, repeat steps ④–⑧ to set drumsample parameters for each note number.

If you wish to use the settings of another “KEY,” select the page menu command “Copy Key Setup”.

- ⑩ Select the Voice/Mixer page in Global P5: Drum Kit.

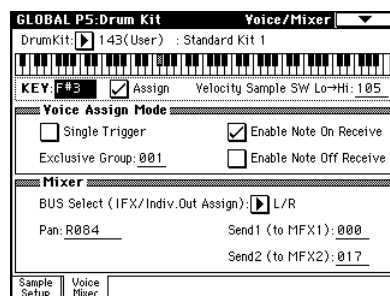

- ⑪ Set the “Exclusive Group.”

The “Exclusive Group” setting is used when you wish to group drumsamples of the same type.

For example if the note number assigned to an open hi-hat drumsample and a closed hi-hat drumsample are set to the same exclusive group number, the open hi-hat and closed hi-hat can not be sounded simultaneously, ensuring that the hi-hat performance will sound natural.

- ⑫ Use “BUS Select” to specify the output routing.

Set this when you wish to send the output of the drumsample assigned to each note number to its own insert effect or AUDIO OUTPUT (INDIVIDUAL) jack 1–4.

For example you might send all snare sounds to IFX1, all kick sounds to IFX2, and the remaining sounds to L/R. You can also specify 1, 2, 3, 4, 1/2, or 3/4 so that specific drum samples will be sent to the AUDIO OUTPUT (INDIVIDUAL) 1–4 jacks.

The settings you make here are used if “Use DKit Setting” (Program P8: Edit-Inert Effect, Routing page) is checked for the program that uses this drum kit. (☞PG p.30, 207)

- ⑬ Use “Pan” to specify the stereo output position.

The setting you make here is valid if the “Use DKit Setting” is checked (Program P4: Edit-Amp., Amp1 Level/Pan page) for the program that uses this drum kit (☞PG p.23).

- ⑭ Use “Send1(MFX1)” and “Send2(MFX2)” to set the send levels to the master effects.

The settings you make here are valid if the “Use DKit Setting” is checked (Program P8: Edit-Insert Effect, Routing page) for the program that uses this drum kit.

- ⑮ Use the page menu command “Write Drum Kits” to save the data.

If you wish to change the name of the drum kit before you save it, use the page menu command “Rename Drum Kit” (☞p.115, 116).

⚠ If you turn off the power before writing the data into memory, your edits will be lost (“Memory in Global mode” ☞p.116).

⚠ When you play the keyboard in Global mode, the TRITON Extreme will sound as in the previous mode in which you were previously. Be aware that if you moved from Sampling mode to Global mode in a state where the sample memory (RAM) contained no data (such as immediately after the power is turned on), playing the keyboard will not produce sound.

⚠ When you move from Sequencer to Global mode, playing the keyboard will sound the program or arpeggiator that corresponds to the global MIDI channel (set in Global P1).

⚠ The settings that you edit in Global mode are preserved as long as the power remains on, but will be lost if not written to memory before the power is turned off. The data handled in Global mode can be classified into three types: user drum kit settings (Global P5), user arpeggio pattern settings (Global P6), and all other global settings (Global P0–P4). Each of these three types of data can be written into the memory area. This data can also be saved to various types of media in Media mode. (☞p.116, 117)

⚠ Global mode does not provide a Compare function that lets you make before-and-after comparisons of your editing. Before editing user drum kits, or user arpeggio patterns, you may wish to use “Copy Drum Kit” or “Copy Arpeggio Pattern” to copy the user drum kit or user arpeggio pattern to an unused number.

# Arpeggiator settings

## P7: Edit-Arpeggiator

This chapter describes the procedure for making arpeggiator settings in each mode.

### Arpeggiator settings for a program

#### Arpeggiator on/off

Pressing the ARPEGGIATOR [ON/OFF] key will turn the arpeggiator on or off. When on, the ARPEGGIATOR [ON/OFF] key will light. When you play the keyboard, an arpeggio will play according to the selected arpeggio pattern.

**note** The on/off setting is stored when the program is written.

#### Arpeggiator settings

- 1 Select the Program P7: Edit-Arpeggiator, Arpeg. Setup page.

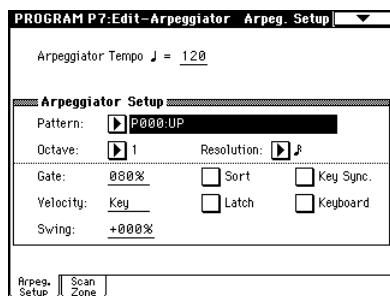

- 2 Use "♩ (Tempo)" to set the tempo.

You can adjust the tempo by rotating ARPEGGIATOR [TEMPO] knob. The LED will blink at the specified tempo.

**MIDI** If "MIDI Clock" (Global P1: MIDI) is set to **External MIDI** or **External USB**, the display will indicate "♩ = EXT." This setting lets you synchronize the tempo with an external MIDI device. In this case, it will not be possible to change the tempo on the TRITON Extreme.

- 3 In "Pattern," select the arpeggio pattern.

You can select from preset arpeggio patterns P000–P004 and user arpeggio patterns U000 (A/B)–U506 (User).

The way in which the pattern is played will depend on settings such as "Octave" and "Sort." P000–P004 in the following diagrams show how the arpeggio will be played when "Octave" is set to 1, and "Sort" is checked. P004: RANDOM is only one possibility.

#### P000: UP

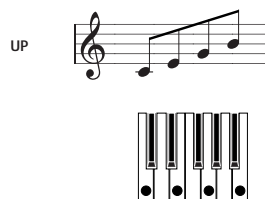

#### P001: DOWN

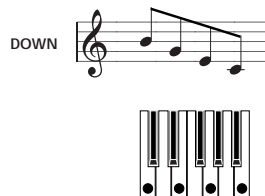

#### P002: ALT1

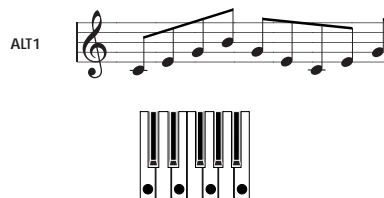

#### P003: ALT2

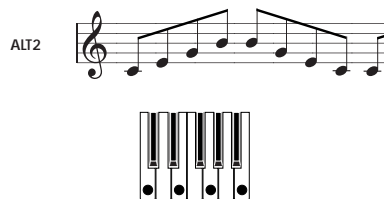

#### P004: RANDOM

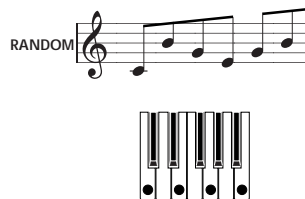

#### U000 (A/B)–U199 (A/B)

With the factory settings, various arpeggio patterns are preloaded. These include a variety of patterns such as drum or bass phrases, or guitar or keyboard backing riffs (Ⓜ VNL).

#### U200 (H) – U506 (User)

When the TRITON Extreme is shipped from the factory, arpeggio patterns are preloaded in some of these memories (Ⓜ VNL).

④ **Adjust the settings of the various parameters.**

“**Octave**”: Selects the octave range in which the arpeggio will be played.

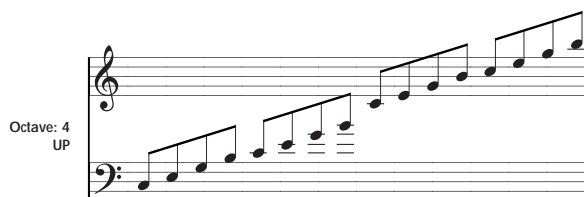

⚠ If a user arpeggio pattern is selected, the “Octave Motion” setting (Global P6: Arpeggio, Pattern Setup page) will affect the way in which the arpeggio is played.

“**Resolution**”: Specifies the timing value of the arpeggio notes over a range of  $\frac{1}{3}$  -  $\frac{1}{2}$ .

“**Gate**”: Specifies the length (gate time) of each note in the arpeggio. If a user arpeggio pattern is selected, you can set this to **Step**. In this case, the value of the “Gate” setting for each step (Global P6: User Arpeggio, Pattern Edit page) will be used.

⚠ This value will be in effect when the ARPEGGIATOR [GATE] knob is in the center position (12 o’clock). Be sure that the knob is in the center position when you make this setting.

“**Velocity**”: Specifies the velocity of the notes in the arpeggio. If this is set to **Key**, the velocity with which you actually played each note will be used. If a user arpeggio pattern is selected, you can set this to **Step**. In this case, the value of the “Vel” setting for each step (Global P6: User Arpeggio, Pattern Edit page) will be used.

⚠ This value will be in effect when the ARPEGGIATOR [VELOCITY] knob is in the center position (12 o’clock). Be sure that the knob is in the center position when you make this setting.

**note** When a preload user arpeggio pattern is selected, setting the “Gate” or “Velocity” to **Step** will add a sense of groove to the arpeggio pattern.

“**Swing**”: This adjusts the timing of the even-numbered notes in the arpeggio (counting from the first note), to give the pattern a sense of “swing.”

“**Sort**”: If this is **checked**, the arpeggio will be sounded in order of pitch, regardless of the order in which notes were played on keyboard (On). If this is **unchecked**, the arpeggio will be sounded in the order in which the notes were played on keyboard (Off).

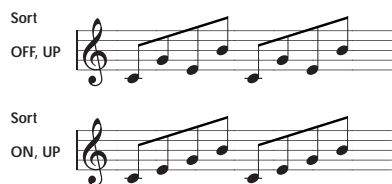

“**Latch**”: If this is **checked**, the arpeggio will continue playing even after you take your hand off the keyboard. If this is **unchecked**, the arpeggio will stop playing when you take your hand off the keyboard.

“**Key Sync.**”: If this is **checked**, the arpeggio pattern will start from the beginning when you play a note after having released all notes. This setting is suitable when you are playing in realtime, and want the arpeggio to start at the beginning of the measure. If this is **unchecked**, the arpeggio pattern will always be synchronized to the tempo of the MIDI clock. For details on synchronization, refer to “Synchronizing the arpeggiator” (p.102).

“**Keyboard**”: If this is **checked**, the notes you play on the keyboard will be heard as well as the arpeggiated notes. If this is **unchecked**, only the arpeggiated notes will be heard.

The same setting can be made by editing the parameter of the same name (or abbreviation) in the Program P0: Play, Arpeggio page.

**note** You can use the page menu command “Copy Arpeggiator” to copy arpeggiator settings from another program or combination (p.29).

⑤ **In the Scan Zone page, specify the range in which the arpeggiator will operate.**

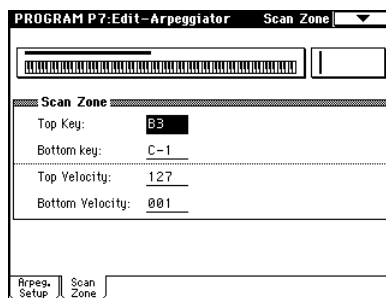

“**Bottom Key**,” “**Top Key**”: The arpeggiator will operate when you play keys within the specified range. Keys outside of this range can be played in the normal manner, and will not be affected by the arpeggiator on/off.

**note** For example if you set “Pattern” to P000: UP, check “Latch,” set “Top Key” to B3, and “Bottom Key” to C-1, playing a note B3 or lower will trigger the arpeggiator. Since “Latch” is on, the arpeggio will continue even after you release the keys. You can use the C4 and higher keys to play conventionally along with the arpeggio sounded by the B3 and lower keys. To change the arpeggio, play keys in the range of B3 and below.

“**Bottom Velocity**” “**Top Velocity**”: The arpeggiator will operate when you play notes with a velocity (playing strength) that is within the specified range. Notes played with a velocity outside this range will be sounded normally, without regard to the arpeggiator on/off.

⑥ **If you wish to save the edited program settings to internal memory, turn off memory protect in Global mode, and write the program (p.115, 116).**

**Linking the arpeggiator to a program**

If you want the arpeggiator settings written in a program to be selected when that program is selected, check **Program** for “Auto Arpeggiator” (Global P0: Basic Setup, Basic page).

## Arpeggiator settings in Combination and Sequencer modes

In Combination, Sequencer and Song Play modes, the TRITON Extreme provides **dual arpeggiator** functionality that lets you use two arpeggio patterns simultaneously. The settings in each of these modes are made in the similar way.

As an example, the following explanation shows how to make settings in Combination mode. For a detailed explanation and example settings (PG p.50, 93, 149).

The dual arpeggiator functionality lets you do the following things.

- Assign an arpeggiator for each timbre. Choose from **Off**, (arpeggiator) **A**, or (arpeggiator) **B**. step ⑤
- Independently specify whether **A** and **B** will operate. step ⑥
- Select an arpeggio pattern and set parameters independently for **A** and **B**. step ⑦
- Make Scan Zone page settings so that you can use keyboard range or playing velocity to switch between normal playing and arpeggiated playing, or to switch between arpeggiators **A** and **B**. step ⑧
- Make settings for timbres that will be silent when the arpeggiator is Off, and will sound only when the arpeggiator is On. step ⑩

### Arpeggiator on/off

Each time you press the ARPEGGIATOR [ON/OFF] key, the arpeggiator will be switched on or off. When on, the ARPEGGIATOR [ON/OFF] key will light. The selected arpeggio pattern will begin when you play the keyboard. The on/off setting is saved when the combination is written into memory.

- ⚡ If “Assign” is Off or “Arpeggiator Run” is not checked, the arpeggiator will not operate even if this key is on.

### Arpeggiator settings

- ① **Select Combination P1: Edit-Program/Mixer page.**  
Select programs for the timbres that you wish to use. For this example, select any desired program for timbres 1–4.
- ② **Select Combination P2: Edit-Trk Param, MIDI Ch page.**  
For the timbres that you will be using, set “Status” to INT, and set “MIDI Channel” to Gch or to the global MIDI channel (set in Global P1: MIDI “MIDI Channel”).  
For this example, set timbres 1–4 to a “Status” of INT, and timbres 5–8 to a “Status” of Off. Set the “MIDI Channel” of timbres 1–4 to Gch.

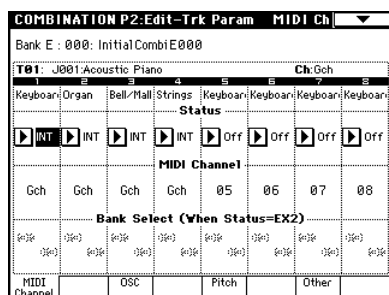

- ③ **Select Combination P7: Edit-Arp., Setup page.**

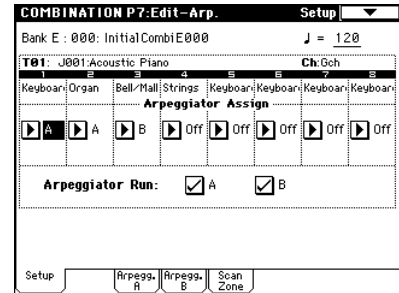

- ④ **Set “J (Temp)” to specify the tempo.**  
This is the same as for a program (p.94). However, the tempo is shared by both arpeggiators **A** and **B**.
- ⑤ **Make “Arpeggiator Assign” settings.**  
Assign arpeggiator **A** or **B** to the desired timbres. Each timbre will be played by the arpeggiator that has been assigned to it.
- ⑥ **Make “Arpeggiator Run” settings.**  
Check the arpeggiator(s) that you want to operate. The arpeggiator(s) checked here will run when the ARPEGGIATOR [ON/OFF] key is turned on.  
With the settings shown in the LCD screen for steps ② and ③, turning the ARPEGGIATOR [ON/OFF] key on will cause arpeggiator **A** to operate for timbres 1 and 2, and arpeggiator **B** to operate for timbre 3. When the ARPEGGIATOR [ON/OFF] key is turned off, timbres 1–4 will sound as a layer.  
If all timbres “Assign” are Off, or if “Arpeggiator Run” **A** or **B** is unchecked, the arpeggiator will not function.
- ⑦ **In the Arpeggiator A and Arpeggiator B pages, set the parameters for arpeggiators A and B.**  
The parameters for **A** and **B** are the same as for a program (p.94).
- ⑧ **In the Scan Zone A/B page, specify the range in which arpeggiators A and B will operate.**  
The parameters for **A** and **B** are the same as for a program (p.94).  
You can use keyboard ranges or playing velocity to operate the arpeggiator, or to switch between arpeggiators **A** and **B**. By using the Combination P4: Edit-Zone/ Ctrl, Key Zone page, and Vel Zone page to set keyboard ranges and velocity ranges in conjunction with each other, you can create even more variations.
- ⑨ **If you wish to save the edited combination settings in internal memory, turn off memory protect in Global mode, and write the combination.** (p.114, 115).
- ⑩ **The “Status,” “MIDI Channel” and “Assign” settings shown in the LCD screen of steps ② and ③ can be made so that certain timbres will sound only when the arpeggiator is On, and will be silent when the arpeggiator is Off.**

## Combination D062: Old Vox Organ

Although this is a somewhat sophisticated editing technique, we will describe the settings of one of the preset combinations as an example.

Select combination D062: Old Vox Organ, press the ARPEGGIATOR [ON/OFF] key to turn it on, and play.

Before you play, make sure that the global MIDI channel (Global P1: MIDI "MIDI Channel") is set to **01**.

- Arpeggiator **A** is assigned to **T** (timbre) **7** and **8**. When you play the keyboard, the arpeggio pattern **U396(User): Dr-Jump Up DnB** will sound only the **T7** program **J068: HipHop Kit**.
- The arpeggio pattern uses **Fixed Note** mode, which is suitable for playing drums from the arpeggiator (**Global P6: User Arpeggio, Pattern Setup page "Arpeggio Tone Mode" Fixed Note**).  
With this setting, the arpeggio pattern will always play the specified pitches regardless of the note numbers received from the keyboard. (PG p.171)
- The **A** "Bottom Key" and "Top Key" (Combination P7: Edit-Arp., Scan Zone A/B page) are set so that arpeggiator **A** will operate only for notes **B3** and lower.
- Arpeggiator **A** is also assigned to **T8**, but this is so that the **T7** program **J068: HipHop Kit** will sound only when the arpeggiator is on.

Notice the timbre settings for T7 and T8

	Status	MIDI Channel	Assign
T7	INT	02	A
T8	Off	Gch	A

- If the arpeggiator is off, playing the keyboard will sound the timbre(s) that are set to **Gch** or to the global MIDI channel (in this case, **01**). Since the "MIDI Channel" of **T7** is set to **02**, it will not sound. **T8** is set to **Gch**, but since "**Status**" is **Off** it will not sound.
- Any MIDI channel that is assigned to a timbre will trigger the arpeggiator. In this case, these will be "**MIDI Channel**" **02** and **Gch** (global MIDI channel). When the arpeggiator is on, playing the keyboard will trigger arpeggiator **A** which is assigned to **T8 (Gch)**. **T7** will be sounded by arpeggiator **A**. Since the "**Status**" of **T8** is **Off**, it will not sound.
- Since the "**Status**" of **T8** is **Off**, it will not sound, regardless of whether the arpeggiator is on or off. It is a dummy timbre that causes **T7** to sound only when the arpeggiator is on.

## Combination J056: "In The Pocket"

Select and play combination J056: "In The Pocket."

Before you play, make sure that the global MIDI channel (Global P1: MIDI "MIDI Channel") is set to **01**.

- Arpeggiator **A** is assigned to **T7** and **T8**, and arpeggiator **B** is assigned to **T5**. When you play the keyboard, the **T7** program **J068: HipHop Kit** will be sounded by the arpeggio pattern **U444(User): Dr-In The Pocket**. The **T5** program **M034: Chord Trigger** will be sounded by the arpeggio pattern **U123(A/B): Syn-Echo**.
- The **B** "Bottom Key" and "Top Key" (Combination P7: Edit-Arp., Scan Zone page) are set so that arpeggiators **B** will operate only for the **G3** note and above.
- Arpeggiator **B** is assigned to **T8** as well, but this setting is so that the **T7** program **J068: HipHop Kit** will sound only when the arpeggiator is on. Refer to the preceding section "Combination D062: Old Vox Organ."

### Linking the arpeggiator to the combination

If you want the arpeggiator settings of a combination to become active when that combination is selected, **check** Combination for "Auto Arpeggiator" (Global P0: Basic Setup, Basic page).

## Creating an user arpeggio pattern

### About user arpeggio patterns

The patterns that can be selected on the TRITON Extreme's arpeggiator are called "arpeggio patterns." There are two types of arpeggio patterns: preset arpeggio patterns and user arpeggio patterns.

#### Preset arpeggio patterns:

There are five patterns; **UP**, **DOWN**, **ALT1**, **ALT2**, and **RANDOM**.

The operation of these patterns is fixed, and cannot be edited.

#### User arpeggio patterns:

There are 507 patterns - **U000(A/B)**–**U506(User)** - which can develop chords or phrases in a wide variety of ways, based on the pitches that you play on the keyboard or the timing at which you play them.

In Global P6: User Arpeggio, Pattern setup you can modify these user arpeggio patterns, or create a new user arpeggio pattern from an initialized condition. Edited user arpeggio patterns can be written to internal memory areas **U000(A/B)**–**U506(User)** (see p.116).

In Media mode, user arpeggio patterns can also saved to media.

### Editing a user arpeggio pattern

⚠ If you want to edit a user arpeggio pattern, you must first make sure that memory protect is unchecked. (see p.115)

If you enter this mode from the Program mode, your editing will apply to the arpeggio pattern specified for the selected program.

- ① In Program mode, select a program for which the arpeggio pattern you wish to edit is selected, or a program that you wish to use as a basis for editing the arpeggio pattern.
- ② Press the **ARPEGGIATOR [ON/OFF]** key to turn the arpeggiator on (the key will light). Even if you moved to Global mode from a program in which the arpeggiator was turned off, you can use the **ARPEGGIATOR [ON/OFF]** key to turn it on.
- ③ Select the **Global P6: User Arpeggio, Pattern Setup** page.



- ④ "Arpeggiator Select" will automatically be set to A when you move here from Program mode.

- ⑤ In "Pattern," select the arpeggio pattern that you wish to edit.

For this example, select an empty user arpeggio pattern.

⚠ If a blank pattern is selected, playing the keyboard will not start an arpeggio. Although preset arpeggio patterns **P000**–**P004** can be selected, they cannot be edited.

⚠ When you edit a user arpeggio pattern, the changes will have an effect anytime that this pattern is used in Program, Combination, Song or Song Play modes.

- ⑥ In "Length," specify the length of the pattern. After the pattern has played for the length specified, it will return to the beginning. This setting can also be changed during or after editing. For this example, set it to **08**.

**note** For the preload arpeggio patterns **U000(A/B)**–**U488(User)**, simply changing the "Length" can significantly change the character of the pattern. Try changing the length and listening to the result.

- ⑦ Make settings for the "♩ (Tempo)," "Resolution," "Octave," "Sort," "Latch," "Key Sync.," and "Keyboard" parameters.

These are program parameters, but can be set from here as well.

⚠ If after moving here from Program mode, you modify these parameters and wish to keep your changes, return to Program mode and write the program. These parameters are not saved by "Write Arpeggio Pattern."

For this example, make the settings shown in the LCD screen on step ③.

- ⑧ In *Arpeggio Pattern Setup*, specify how the arpeggio will be developed. These settings can be changed during or after editing (see PG p.171).

- ⑨ Select the **Pattern Edit** page.

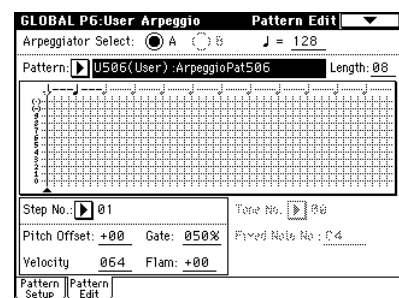

A pattern consists of **Steps** and **Tones**.

- **Step:** A user arpeggio pattern can have a maximum of 48 steps. The arpeggiator will play from the first step, in steps equal to the timing value specified by "Resolution." The vertical lines of the grid shown in the center of the LCD screen indicate the steps. Use "Step No." to select the step. For each step, specify "Pitch Offset," "Gate," "Velocity" and "Flam."

- **Tone:** At each step, a chord consisting of up to 12 tones (Tone No. 00–11) can be sounded.

To input tones, select “Step No.” and then use numeric keys [0]–[9], [-], and [./10’s HOLD] to input tones. The “Tone No.” corresponds to the [0]–[9], [-], and [./10’s HOLD] keys as shown below. Each time you press a [0]–[9], [-], or [./HOLD] key, the corresponding tone will be turned on/off. The horizontal lines of the grid shown in the center of the LCD screen indicate the tones.

**Tone00–09:** [0]–[9] keys

**Tone10:** [-] key

**Tone11:** [./10’s HOLD] key

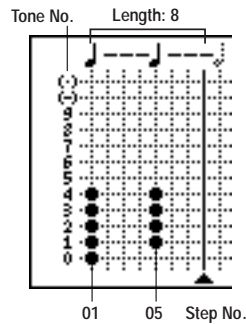

### Creating an example pattern

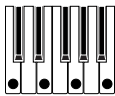

- ① Set “Step No.” to 01, and press the [0] key.
- ② Set “Step No.” to 02, and press the [1] key.
- ③ Set “Step No.” to 03, and press the [2] key.
- ④ Set “Step No.” to 04, and press the [1] key.
- ⑤ Set “Step No.” to 05, and press the [3] key.
- ⑥ Set “Step No.” to 06, and press the [1] key.
- ⑦ Set “Step No.” to 07, and press the [2] key.
- ⑧ Set “Step No.” to 08, and press the [1] key.

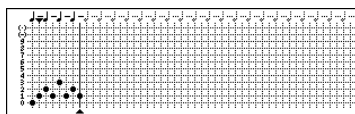

- ⑨ When you play the keyboard as shown in the illustration, the arpeggiator will begin playing. **Tone 0** corresponds to the pitch of the lowest key of chord you play on the keyboard. (If “Sort” is unchecked, it will correspond to the pitch of the first note you play.)
- ⑩ For steps 01–08, make settings for “Pitch Offset,” “Gate,” “Velocity,” and “Flam.”  
**“Pitch Offset”:** This offsets the pitch of the arpeggio note in semitones up or down. You can input the same tone for each step, and change the “Pitch Offset” value for each to create a melody using a single tone. (See “Melody pattern”)  
**“Gate”:** Specifies the length of the arpeggio note for each step. With a setting of **Legato**, the note will continue sounding either until the next note of the same tone or until the end of the pattern. With a setting of **Off**, the note will not sound.

**“Velocity”:** Specifies the strength of the note. With a setting of **Key**, the note will sound at the strength with which it was actually played.

- The “Gate” and “Velocity” settings you make here will be valid if the “Gate” and “Velocity” parameters (Program P7: Edit-Arpeggiator, Arpeg. Setup page) of the program selected in Program mode are set to **Step**. If these parameters have a setting other than **Step**, the “Gate” and “Velocity” that were specified for each individual step will be ignored, and all notes of the arpeggio will sound according to the settings in Program P7: Edit-Arpeggiator. Be sure to verify the settings of the program.

- Set the “Gate” and “Velocity” by using the ARPEGGIATOR [GATE] and [VELOCITY] knobs to the center position (12 o’clock).

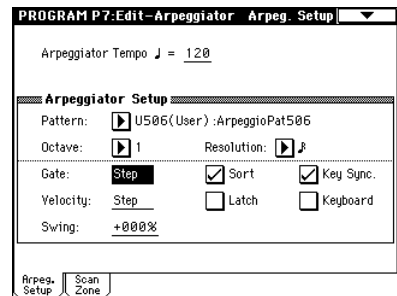

- ⑪ To change the user arpeggio pattern name, use the “Rename Arpeggio Pattern” page menu command. (See p.115)
- ⑫ If you wish to save the edited user arpeggio pattern to internal memory, be sure to Write the user arpeggio pattern. (See p.116)  
If you turn off the power without writing, the edited contents will be lost.
- ⑬ If you wish to save the state of the program at the same time, return to Program mode and write the program. (See p.114)

### Other examples of creating a user arpeggio pattern

#### Melody pattern



- ① Set “Step No.” to 01, and press the [0] key. Set “Pitch Offset” to +00.
- ② Set “Step No.” to 02, and press the [0] key. Set “Pitch Offset” to +10.
- ③ Set “Step No.” to 03, and press the [0] key. Set “Pitch Offset” to +00.
- ④ Set “Step No.” to 04, and press the [0] key. Set “Pitch Offset” to +00.
- ⑤ Set “Step No.” to 05, and press the [0] key. Set “Pitch Offset” to +12.
- ⑥ For “Step No.” 06, do not enter a tone.

- ⑦ Set "Step No." to 07, and press the [0] key. Set "Pitch Offset" to +00.
- ⑧ Set "Step No." to 08, and press the [0] key. Set "Pitch Offset" to -02.

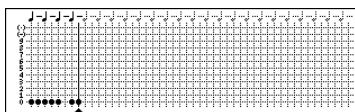

### Chordal pattern



- ① Set "Step No." to 01, and press the [0] key. Set "Gate" to Legato.
- ② For "Step No." 02, do not enter a tone.
- ③ Set "Step No." to 03, and press the [1], [2], [3], [4] keys.
- ④ Set "Step No." to 04, and press the [1], [2], [3], [4] keys.
- ⑤ For "Step No." 05, do not enter a tone.
- ⑥ Set "Step No." to 06, and press the [1], [2], [3], [4] keys. Set "Gate" to Legato.
- ⑦ For "Step No." 07, do not enter a tone.
- ⑧ Set "Step No." to 08, and press the [1], [2], [3], [4] keys.

**note** To simulate the timing nuances of a strummed guitar chord, select "Flam." In Program mode, select an acoustic guitar program, and choose the user arpeggio pattern that you created here. In the Arpeg. Setup page of Program P7: Edit-Arpeggiator, set "Gate" to Step.

Then return to the Global P6: User Arpeggio, Pattern Edit page. For odd-numbered steps, set "Flam" to a positive (+) value. For even-numbered steps, set "Flam" to a negative (-) value.

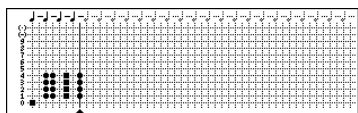

### Drum pattern

You can use the arpeggiator to play a rhythm pattern by using "Fixed Note" with a drum program.

- ① In Program mode, select a drum kit program. For this example, select the preset program J036: Standard Kit 1.
- ② In Global P6: User Arpeggio, select the Pattern Setup page, and make Arpeggio Pattern Setup settings. "Arpeggio Tone Mode": Set this to Fixed Note. This will cause the tone to always sound at the specified pitch. "Fixed Note Mode": If you set this to Trigger All Tones, playing a single note on the keyboard will sound all tones.

If you set this to **Trigger As Played**, the tones will be sounded according to the notes you play on the keyboard (PG p.171).

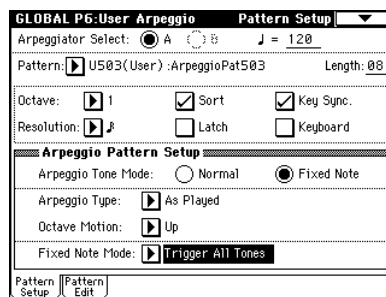

- ③ Select the Pattern Edit page.

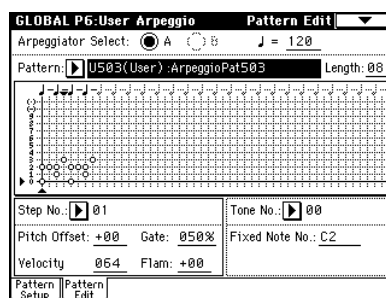

Let's input the following rhythm pattern.

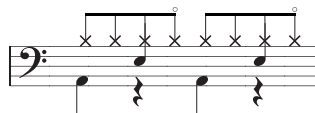

- ④ Make settings for "Tone No." and "Fixed Note No." Select "Tone No.," and set "Fixed Note No." to the note number that will be sounded by that tone. For each horizontal line (Tone) in the screen, you will specify the drumsample (note number) of the drum kit. Each **Tone** will be displayed as a small circle.

For this example, set "Tone No." and "Fixed Note No." as follows.

Tone No.	Fixed Note No.
00	C2 (kick)
01	F2 (snare)
02	F#3 (closed hi-hat)
03	A#3 (open hi-hat)

The drumsamples that correspond to each note number will differ depending on the drum kit. It is convenient to audition the drum sounds from the keyboard, and then input "Fixed Note No." by holding down the [ENTER] key and playing the desired key.

- ⑤ Input the kick (Tone00). Set "Step No." to 01, and press the [0] key. Then set "Step No." to 05, and press the [0] key.
- ⑥ Input the snare (Tone01). Set "Step No." to 03, and press the [1] key. Then set "Step No." to 07, and press the [1] key.
- ⑦ Input the closed hi-hat (Tone02). Set "Step No." to 01, 02, 03, 05, 06, and 07, and press the [2] key for each.



## ⑧ Input the open hi-hat (Tone03).

Set “Step No.” to 04, and press the [3] key. Then set “Step No.” to 08, and press the [3] key.

If “Fixed Note Mode” is set to **Trigger All Tones**, playing a single note on the keyboard will cause the rhythm pattern to play.

If “Fixed Note Mode” is set to **Trigger As Played**, playing a single note on the keyboard will cause only the kick (Tone00) to play.

Playing two notes on the keyboard will cause only the kick (Tone00) and snare (Tone01) to play. In this way, the number of keys that you play will be played by the same number of tones.

## ⑨ Set the parameters for each step.

Use “Velocity” etc. to add accents to the rhythm pattern.

 The “Gate” and “Velocity” settings you make here will be valid if the “Gate” and “Velocity” parameters (Program P7: Edit-Arpeggiator, Arpeg. Setup page) of the program selected in Program mode are set to **Step**. If these parameters have a setting other than **Step**, the “Gate” and “Velocity” that were specified for each individual step will be ignored, and the notes of the arpeggio will be sounded according to the settings of the Program P7: Edit-Arpeggiator, Arpeg. Setup page. Check the settings of the program.

 Set the “Gate” and “Velocity” by using the ARPEGGIATOR [GATE] and [VELOCITY] knobs to the center position (12 o'clock).

## Dual arpeggiator editing

Here we will use a combination as an example in our explanation.

The same procedure applies when editing an arpeggio pattern in Sequencer and Song Play modes.

If you have entered this mode from the Combination mode, the arpeggio pattern selected by the combination will be affected by your editing.

### ① In Combination mode, select a combination that uses the arpeggio pattern you wish to edit.

For this example, select a combination to which both arpeggiators A and B are assigned.

### ② Press the ARPEGGIATOR [ON/OFF] key to turn on the arpeggiator (the key will light).

Even if the arpeggiator had been turned off when you moved here, you can use the ARPEGGIATOR [ON/OFF] key to turn it on. However, if “Arpeggiator Run” A or B are not checked, and if “Arpeggiator Assign,” is set to off, then the arpeggiator will not operate.

### ③ Select the Global P6: User Arpeggio, Pattern Setup page.

### ④ If you moved here from Combination mode, use the “Arpeggio Select” A and B to select the arpeggiator that you wish to edit.

If this is A, your editing will apply to the parameters and user arpeggio pattern of arpeggiator A.

If this is B, your editing will apply to the parameters and user arpeggio pattern of arpeggiator B.

### ⑤ Switch between arpeggiators A and B, and edit their respective user arpeggio patterns.

If you wish to stop one of the arpeggiators, return to Combination mode, and in Combination P0: Play, select the Arpeggio Play A or the Arpeggio Play B page and uncheck the “Arpeggiator Run” check box.

### ⑥ To modify the name of a user arpeggio pattern, use the Utility “Rename Arpeggio Pattern.” (p.115)

### ⑦ If you wish to save the edited user arpeggio pattern in internal memory, you must write the user arpeggio pattern.

In this case, both user arpeggio patterns will be written simultaneously. If you turn off the power without writing, the edited contents will be lost (p.116).

### ⑧ If you wish to save the state of the combination at the same time, return to Combination mode and write the combination. (p.114)

**note** When editing a user arpeggio pattern, pay attention to the global MIDI channel, the channel of each track, and the arpeggiator assignments, and make sure that the arpeggiator you are hearing is the pattern that you wish to edit.

 If you moved here from Sampling mode, the arpeggiator will not turn on. Nor will it be possible to edit arpeggio patterns.

---

## Synchronizing the arpeggiator

The note timing of the arpeggiator will differ depending on the state of the arpeggiator “**Key Sync.**” check box. If this is **checked**, the arpeggiator will operate at the timing of the first note-on you play from a state in which all keys are released.

If this is **unchecked**, the arpeggiator will operate in synchronization with the internal or external MIDI clock.

The paragraphs below explain how synchronization occurs when the “**Key Sync.**” check box is **unchecked**. (However, synchronization with Song Start and with the MIDI realtime command Start message are exceptions to this.)

## Synchronization between arpeggiators A and B

In Combination, Sequencer and Song Play modes, two arpeggiators can operate simultaneously. In this case, if you start an arpeggiator (whose “**Key Sync.**” is **unchecked**) while the other arpeggiator is already running, the arpeggiator you started will synchronize to the “♩ (Tempo)” based on the timing of the already-running arpeggiator.

**note** If “**Key Sync.**” is checked, A and B will each operate on their own timing.

## Synchronization between the arpeggiators and sequencer in Sequencer or Song Play mode

### When song playback is stopped

- The arpeggiator will synchronize to the “♩ (Tempo)” based on the timing of the internal MIDI clock.
- In Sequencer mode when an RPPR pattern is playing, the arpeggiator will synchronize to the beats of that pattern.
- In Sequencer mode if you want RPPR pattern playback to be synchronized to the currently-running arpeggiator, set “**Sync**” to **SEQ** (Sequencer P6:Pattern/RPPR, RPPR Setup page). The pattern playback will synchronize to the “♩ (Tempo)” timing of the arpeggiator.

### When a song is being played or recorded

- The arpeggiator will synchronize to the beats based on the timing of the song.

### Synchronization with Song Start

- When the arpeggiator is on (the ARPEGGIATOR [ON/OFF] key is on) and running, receiving a Song Start message will reset the arpeggiator to the beginning of the pattern. (This has no relation to the “**Key Sync.**” setting.)
- In Sequencer mode when the “**Key Sync.**” setting is unchecked and the ARPEGGIATOR [ON/OFF] key is on, starting the arpeggiator by pressing notes during the pre-count before recording will cause the arpeggiator to start (and be recorded) from the beginning of the arpeggio pattern at the moment that recording begins.

---

## Synchronization with an external sequencer in Program, Combination, or Sequencer modes

In Program, Combination, and Sequencer modes when “♩ (Tempo)” is **EXT** (Global P1: MIDI “**MIDI Clock**” set to **External MIDI** or **External USB**), the TRITON Extreme will synchronize to MIDI Clock and Start messages received from an external MIDI sequencer (or similar device) connected by a MIDI cable.

### Synchronization to external MIDI clock

- The arpeggiator will synchronize to the “♩ (Tempo)” based on the timing of the external MIDI clock.

### Synchronization to the MIDI Start message

- When the arpeggiator is on and operating, receiving a MIDI Start message will cause the arpeggiator to reset to the beginning of the pattern. (This has no relation to the “**Key Sync.**” setting.)

 In Song Play mode, the TRITON Extreme will not synchronize to an external MIDI clock.

# Effect and Valve Force settings

The effect section of the TRITON Extreme provides five **insert effects**, two **master effects**, one **master EQ** (stereo 3-band EQ), and a **mixer** that controls the routing of these components.

You can choose from 102 types of full-digital effects for each insert effect, and from 89 types for each master effect. The effects are categorized as follows.

## Categories of the 102 effect types

001–015	Filter and dynamics effects, such as EQ and compressor
016–031	Phase modulation effects, such as chorus and phaser
032–040	Other modulation and pitch-shift effects such as rotary speaker and pitch shifter
041–051	Early reflection and delay effects
052–057	Reverb effects
058–089	Mono + mono chain effects that internally connect two mono effects in series
090–102	Double-size effects

You can select effects **000–089** for IFX1, 2, 3, 4, 5, MFX1, and MFX2.

You can select effects **090–102** for IFX2, 3, or 4. This is because these are double-size effects which require twice as much processing as the other effects.

## Effects in each mode

In **Program mode**, insert effects can be used as part of the sound-creating process, in the same way that the output sound of the oscillator (OSC) is processed by the filter and amp to create the final sound. Then the master effects can be used to apply spatial-type effects such as reverb. The stereo 3-band master EQ is located immediately before the OUTPUT (MAIN) L/MONO and R outputs and is used to make final adjustments in tone. These settings can be made independently for each program.

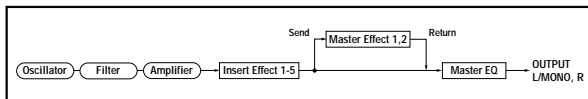

In **Combination mode**, **Sequencer mode**, and **Song Play mode**, insert effects can be used to help create the sound of each timbre/track. The master effects are used to apply overall spatial processing, and the master EQ is used to make overall adjustments in tone.

You can make these settings independently for each combination in Combination mode, independently for each song in Sequencer mode, and in Song Play mode for the entire mode.

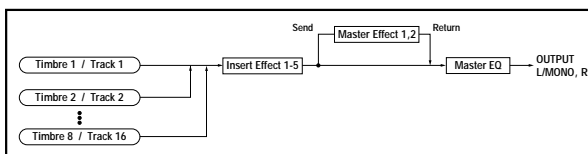

In **Sampling mode**, you can sample while applying insert effects to the audio coming in via AUDIO INPUT 1, 2, or S/P DIF IN jacks. Settings in Sampling mode are made in **Input (SAMPLING)** (Sampling P0: Input/Setup). These settings are valid only for Sampling mode.

You can also sample while applying an insert effect to the samples assigned to a multisample.

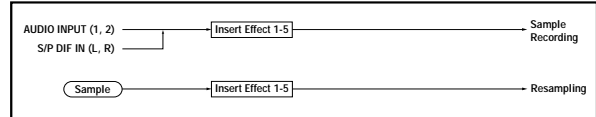

The external input from the **AUDIO INPUT 1, 2**, or **S/P DIF IN** jacks is also valid in modes other than Sampling mode. In Program, Combination, Sequencer, and Song Play modes, you can use the insert effects, master effects, and master EQ. Settings for external signal input via the AUDIO INPUT 1, 2, and S/P DIF IN can be made in **"Input (COMBI, PROG, SEQ, S.PLAY, MEDIA)"** (set in Global P0: 0–3a or in the corresponding mode).

In these modes, the external input sound from each jack can be processed by the TRITON Extreme's effects and sampled, or the TRITON Extreme can be used as a 4-in (AUDIO INPUT 1, 2, and S/P DIF IN L, R) 6-out effect processor. The TRITON Extreme can also be used as a vocoder effect (093: Vocoder) that uses external mic input to control internal sounds.

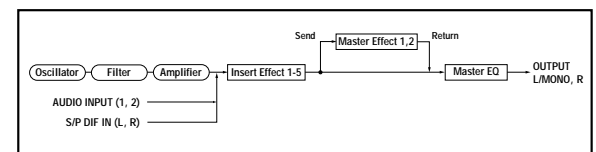

⚠ When effects are applied to the external input sound from the AUDIO INPUT 1, 2, and S/P DIF IN jacks, certain effect types or parameter settings may cause oscillation to occur. If this occurs, adjust the input level, output level, or effect parameters. Please be aware of this particularly when using an effect that has a high gain.

## Routing settings and effect settings

The insert effects, master effects, and master EQ have the same structure in all modes, but the routing settings will determine how the oscillators of a program or the timbres of a combination or track of a song will be sent to each insert effect or master effect. In the pages that follow, we will explain how you can make routing settings and effect settings in each mode.

### Effect settings for a program

#### Routing

- 1 In Program P8: Edit-Insert Effect, select the Routing page.

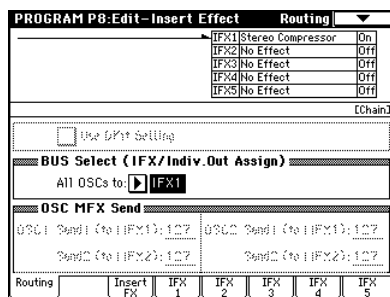

- 2 Use “BUS Select (IFX/Indiv.Out Assign) to specify the bus (insertion effect) to which the output of the oscillator will be sent.  
**L/R:** Send the output to the L/R bus. Instead, it is sent to AUDIO OUTPUT (MAIN) L/MONO and R after the Master EQ.  
**IFX1–5:** The signal is sent to Insert Effects IFX 1, 2, 3, 4, 5.  
**1, 2, 3(Tube), 4(Tube), 1/2, 3/4(Tube):** The signal is sent to AUDIO OUTPUT (INDIVIDUAL) 1, 2, 3(Tube), 4(Tube) (p.109).  
**Off:** The output will not be sent to the L/R bus, IFX1–5 buses, or 1–4(Tube) buses. Choose the Off setting if you want to connect the oscillator output to a master effect in series. Use “Send 1 (to MFX1)” and “Send 2 (to MFX2)” to adjust the send level.
- 3 **OSC MFX Send** specifies the send level from each oscillator to the master effects.  
 This can be set only when “BUS Select (IFX/Indiv.Out Assign)” is either L/R or Off.  
 If “BUS Select (IFX/Indiv.Out Assign)” is set to IFX1–5, the send level to the master effects is set by “Send 1” and “Send 2” (Insert FX page) after the signal passes through the insert effects.

#### Insert effects

- 4 Select the Insert FX page.

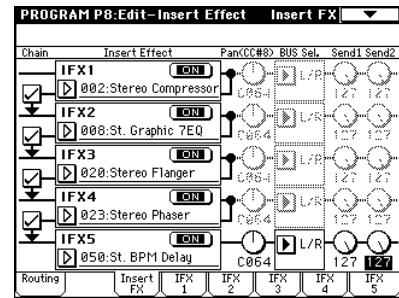

- 5 For IFX1–5, select the effect type for each insert effect.

**note** When you press the popup button, all effects will be displayed, organized into six categories. Use the pages located at the left to select a category, and select an effect from that category on the LCD screen.

**note** You can select effects 000–089 for IFX1, 2, 3, 4, 5, MFX1 and MFX2. You can select the double-size effects 090–102 for IFX2, IFX3, or IFX4.

**note** You can use the “Copy Insert Effect” page menu command to copy effect settings from another program etc. Also, you can use “Swap Insert Effect” to exchange (for example) IFX1 and IFX5.

- 6 Press the ON/OFF button to turn on the insert effect.  
 Each time you press the button, the insert effect will be switched on/off. When OFF, the result will be the same as when 000: No Effect is selected. The input sound will be output without change.
- 7 Make “Chain” settings.  
 If the “Chain” check box is checked, the insert effect will be connected in series. Since the output of the oscillator is being sent to IFX1 in 1, making settings as shown in the diagram 4 would connect all five insertion effects IFX1 → IFX2 → IFX3 → IFX4 → IFX5 in series, so that these effects would be inserted into the output of the oscillator.
- 8 Make settings for “Pan (CC#8),” “BUS Sel. (BUS Select),” “Send 1,” and “Send 2” for the sound after it has passed through the insert effects.  
 If the “Chain” check box is checked, the settings that follow the last IFX will be used.  
**“Pan”:** Sets the pan. This is valid only when BUS Sel. is L/R.  
**“BUS Sel.” (BUS Select):** Specifies the output destination. Normally you will set this to L/R. If you wish to send the sound that has passed through the insert effects to AUDIO OUTPUT (INDIVIDUAL) 1–4, select 1–4(Tube), 1/2, or 3/4(Tube). For details on 3(Tube), 4(Tube), or 3/4(Tube), refer to p.109.  
**“Send 1,” “Send 2”:** Sets the send levels to the master effects. For this example, set this to 127.
- 9 Select the IFX1–5 pages, and set the parameters for each of the selected effects.  
 For details on the parameters of each effect (p.217–).

## Master effects

The input levels to the master effects are set by the “Send 1, 2” levels (step ③ or ⑧). If “Send 1, 2” are zero, the master effects will not apply. “Send 1” corresponds to MFX1, and “Send 2” corresponds to MFX2.

- ⑩ In Program P9: Edit-Master Effect, select the Master FX page.

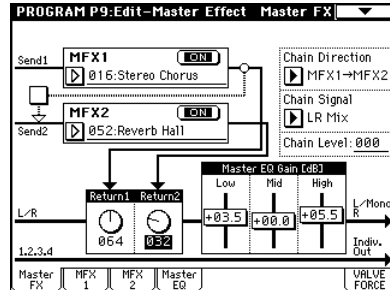

- ⑪ In MFX1 and MFX2, select the type of each master effect.

The procedure is the same as when selecting an insertion effect (step ⑤).

- ⚠ The master effects cannot use double-size effects.
  - ⚠ The master effects are mono-in/stereo-out. Even if a stereo-input effect is selected, it will function as mono input.
- ⑫ Press the ON/OFF button to turn on the master effect. Each time you press the button, the master effect will be switched on/off. When OFF, the output of the master effect will be muted.
  - ⑬ Use “Return 1” and “Return 2” to adjust the output levels of the master effects.

**note** For each effect, the Wet value of the “Wet/Dry” parameter is the output level at the effect. The return value is multiplied with this (“Return” = 127 will be x1.0) to determine the actual output level of the master effect.

- ⑭ Select the MFX1 and MFX2 pages, and set the parameters for each selected effect.

For details on the parameters of each effect (step PG p.217-).

## Master EQ

- ⑮ Use the stereo 3-band master EQ to make final equalizing adjustments just prior to the sound being sent to the AUDIO OUTPUT L/MONO and R jacks. Move the slider for each band to make adjustments. You can select the Master EQ page, and adjust the band frequency of the master EQ (step PG p.269).

## Effect settings in Combination, Song, and Song Play modes

In Combination, Sequencer, and Song Play modes, you can specify the routing of each timbre/track to the insert effects and master effects. These settings are made in the same way in each of these modes. We will be using the example of Combination mode in our explanation here.

## Routing

- ① In Combination P8: Edit-Insert FX, select the Routing page.

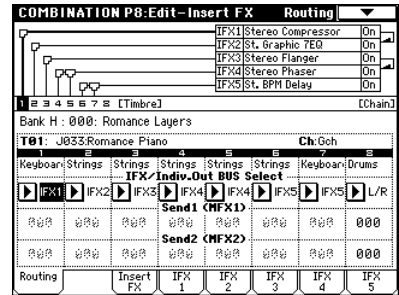

- ② Select “IFX/Indiv.Out BUS Select.” Here you can specify the bus (insert effect) to which the output of each timbre will be sent. The routing, insert effects, and chain settings are shown graphically in the upper part of the display screen. In this example, T01 (timbre 1) uses IFX1 and 2, T02 uses IFX2, T03 uses IFX3 and 4, T02 and T05 use IFX4, and T06 and T07 use IFX5. Selection of each effect type, the on/off setting, and chain settings are made in the Insert Effect page.
- ③ “Send1,” “Send2” specifies the send level from each timbre to the master effects.

This can be set only if “IFX/Indiv.Out BUS Select” is set to L/R or Off.

- ⚠ The actual send level is determined by multiplying this by the “Send 1” or “Send 2” settings for oscillators 1 and 2 within the program selected by the timbre. If the program parameter “Send 1” or “Send 2” is set to 0, the resulting level will still be 0 even if you raise this send level.

If “IFX/Indiv.Out BUS Select” is set to IFX1-5, the send levels to the master effects are set by “Send 1” and “Send 2” (Insert FX page) following the insert effects.

## Insert effects

Select an effect for IFX1–IFX5, and set “Pan (CC#8),” “BUS Sel. (BUS Select),” “Send 1” and “Send 2” for the signal that has passed through each insert effect. If the “Chain” check box is checked, the settings that follow the last IFX in the chain will be used. “Send 1” and “Send 2” adjust the amount of master effect that is applied to the signal that has passed through the IFX.

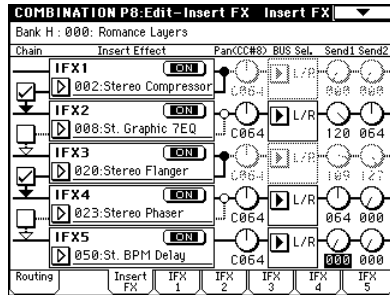

You can edit these settings in the same way as for a program (p.104), but you can use MIDI to control dynamic modulation (Dmod), post-IFX pan (CC#8), Send1, and Send2. This is particularly useful in Sequencer mode. An “\*” is shown at the right of Ch01–16 for channel numbers whose track is routed to IFX. If multiple tracks with different MIDI channel settings are routed to an IFX, this setting specifies the channel that will control the effect.

## Master effects

### Master EQ

These settings can be made in the same way as in “Effect settings for a program” (p.105).

You can use the “Ctrl Ch.” to control these effects; dynamic modulation (Dmod) on the specified MIDI channel will control the master effects or master EQ.

## Effect settings in Sampling mode

In Sampling mode, an external audio source connected to the AUDIO INPUT 1, 2, or S/P DIF IN jacks can be sampled with insert effects applied. You can also apply an insert effect to the samples assigned to a multisample, and resample the result.

## Routing

- 1 Use “Input (SAMPLING)” to specify the external audio input, and set the Sampling P0: Recording, Input/Setup page “BUS (IFX/Indiv.) Select” parameter to specify the bus (i.e., the insert effect) to which the signal will be sent. (p.21)

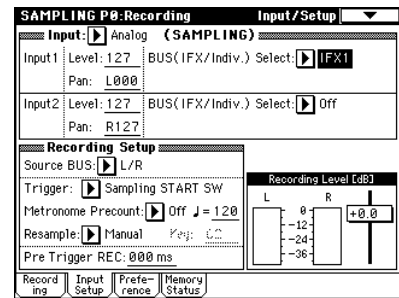

**note** The Input settings allow you to input simultaneously from each input source.

The bus (the insert effect) to which the samples assigned to the multisample will be sent is specified by the Sampling P8: Insert Effect, Routing page “BUS Select (Indiv.Out Assign)” parameter.

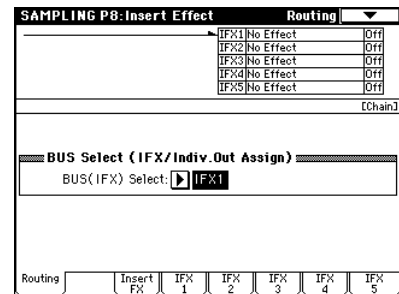

## Insert effects

Select an effect for IFX1–IFX5, and set “Pan (CC#8)” for the signal that has passed through each insertion effect. If the “Chain” check box is checked, the settings that follow the last IFX in the chain will be used.

## Master effects

### Master EQ

The master effects and master EQ cannot be used in Sampling mode.

## AUDIO INPUT effect settings

In Program, Combination, Sequencer, Song Play, and Media modes, you can apply the TRITON Extreme's effects to an external audio source connected to the AUDIO INPUT 1, 2, or S/P DIF IN jacks. In these modes you can use the insert effects, master effects, and master EQ. Use "Input (COMBI, PROG, SEQ, S.PLAY, MEDIA)" to make settings for the external input from the AUDIO INPUT 1, 2, and S/P DIF IN jacks. Normally you will make these settings in the Global mode P0: Basic Setup, Input/Sampling page, but you can also make them from Combination, Program, Sequencer, or Media modes. In these modes, you can apply the TRITON Extreme's effects to the external audio signals from each jack and sample the result, or use the TRITON Extreme as a 4-in (AUDIO INPUT 1, 2, S/P DIF IN L, R) 6-out effect processor. You can also use TRITON Extreme to as a vocoder (093: Vocoder) in which internal sounds are controlled by an external mic input.

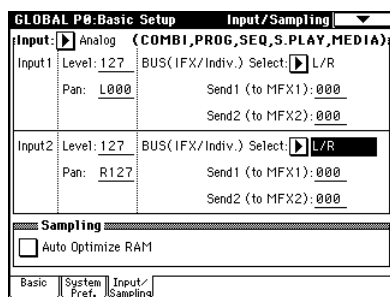

## Routing

In Program, Combination, Sequencer, Song Play, and Media modes (i.e., in other than Sampling mode), the routing of the external audio input signals from the various jacks is specified by "BUS (IFX/Indiv.) Select."

- ① Use "Input (COMBI, PROG, SEQ, S.PLAY, MEDIA)" to select the source that you want to input.

This setting can be made in any of the following pages. If you want to save the edited settings into internal memory, you must write them. Use the Global mode page menu command "Write Global Setting" to write your settings.

Program, Combination	P0: Play, Sampling page
Sequencer	P0: Play, Sampling page
Global	P0: Basic Setup, Input/Sampling page
Media	Play Audio CD page

**note** Input-related settings are shared between all of the above modes. For each input source that you select in "Input (COMBI, PROG, SEQ, S.PLAY, MEDIA)," a routing can be specified independently. If desired, you may input simultaneously from all input sources.

- 🔍 If you want to make these settings in Global mode, move to Global mode from the mode (other than Sampling mode) in which you will be inputting the external audio signals. If you move from Sampling mode to Global mode, the *Input (SAMPLING)* settings of Sampling mode will be maintained, and it will not be possible to view the settings of this page. These settings are ignored in Sampling mode. Audio input settings for Sampling mode are made in a similar way, in Sampling P0: Recording, Input/Setup page *Input (SAMPLING)*.

- 🔍 When you apply effects to external input signals from the AUDIO IN 1, 2, and S/P DIF IN inputs, oscillation may be heard depending on the type of effect and the parameter settings of the effect. If this occurs, adjust the input level, output level, and effect parameters. Particular care should be taken when using high-gain effects.

- ② Set the parameters for *Input1* and *2*. *Input1* and *2* correspond to the following inputs.

Analog	AUDIO INPUT	1 2	Input1 Input2
S/P DIF	S/P DIF	Lch Rch	Input1 Input2

**"Level"**: Sets the level of the input signal that you selected in "Input (COMBI, PROG, SEQ, S.PLAY, MEDIA)." Normally you will set this to 127. If the sound is distorted even though you lower this setting significantly, it is possible that the sound is distorting before the AD converter. Adjust the [LEVEL] knob or the output level of the external audio source.

**"Pan"**: Sets the pan of the input signal that you selected in "Input." When inputting a stereo audio source, you will normally set *Input1* to L000, and *Input2* to R127 (or *Input1* to R127 and *Input2* to L000). When inputting a mono audio source, you will normally set this to C064.

**"BUS (IFX/Indiv.) Select"**: In the same way as when making settings for the oscillator(s) of a program, Specifies the bus to which each external audio input will be sent. (p.104)

**"Send1 (to MFX1)," "Send2 (to MFX2)"**: In the same way as when making settings for the oscillator(s) of a program, sets the master effect send levels for each external audio input. This can be set only if "BUS (IFX/Indiv.) Select" is set to L/R or Off. (p.105)

If "BUS (IFX/Indiv.) Select" is set to IFX1-5, the master effect send levels are set by the "Send1" and "Send2" parameters following the insert effect (in each Insert FX page).

- 🔍 If "BUS (IFX/Indiv.) Select" has a setting other than Off, and you raise the "Level" value, the external audio source will be input to the TRITON Extreme. At this time if audio cables are connected to the rear panel AUDIO INPUT 1 and 2 jacks, noise may be input to the TRITON Extreme via the AD converter even if no audio input is actually present, and depending on the settings, may be output from AUDIO OUTPUT L/R, 1, 2, 3, or 4. If you will not be using an external audio source, but are using only the internal sounds of a program, combination, or song, set "BUS (IFX/Indiv.) Select" to Off, or set "Level" to 0.

Similarly, if you will not be using the S/P DIF IN jack, set these inputs to "BUS (IFX/Indiv.) Select" Off, or set their "Level" to 0.

If no audio cables are connected to the rear panel AUDIO INPUT 1 and 2 jacks, the data that is input to the TRITON Extreme from the AD converter will be set to zero, and no noise will be output.

## About dynamic modulation (Dmod)

Dynamic modulation (Dmod) is a function that lets you use MIDI messages or the TRITON Extreme's controllers to control specific effect parameters in realtime. BPM/MIDI Sync is another function that controls effect parameters, and is used to synchronize the LFO speed of modulation-type effects or the delay time etc. of delay-type effects to the tempo of the arpeggiator or an external sequencer. For details on each of these functions, refer to PG p.276, 278.

### Setting example:

We will show how you can use dynamic modulation to control an effect parameter in realtime.

- ① As described in the procedure for “Effect settings for a program” (p.104), set “IFX1” to 049: L/C/R BPM Delay. Verify that a delay sound is being output.
- ② Access the Program P8: Edit-Insert Effect, IFX1 page.

Using Dmod to change the delay level by moving the joystick away from yourself

- ③ Set “Input Level Dmod” to +100.
- ④ Set “Src” to JS+Y: CC#01. The delay sound will disappear. The input level to the effect can be controlled by the joystick. As you move the joystick away from yourself, the delay sound will gradually increase.

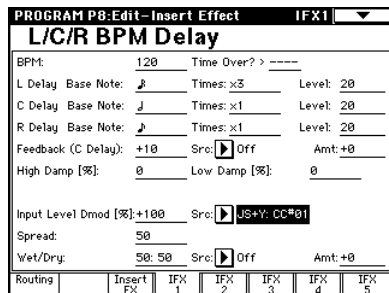

Using Dmod to modify the feedback level from [SW1] key

- ⑤ In P1: Edit-Basic, select the Controller Setup page, and set the function of “SW1” to SW1 Mod.: CC#80 (Toggle).
- ⑥ Return to P8. Set “Feedback Src” to SW 1: CC#80.

- ⑦ Set “Amt” to +30.

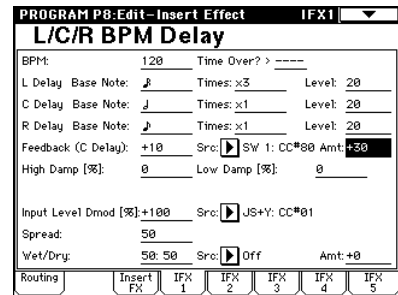

When you (move the joystick away from yourself and) press the [SW1] key, the feedback level will increase, and the delay sound will continue for a longer time. The “Amt” setting specifies the feedback level that will be in effect when the [SW1] key is pressed. If “Amt” is set to -10, pressing the SW1 key will reduce the feedback level to 0.

Using the BPM/MIDI Sync. function to synchronize the delay time to arpeggiator tempo changes.

- ⑧ Set “BPM” to MIDI.
- ⑨ For L, C, and R, set “Delay Base Note” and “Times” as desired.

For this example, set “Delay Base Note” to ♩ and “Times” to x1 so that the effect will be easily understandable. The delay time will repeat at an interval of 8th note.

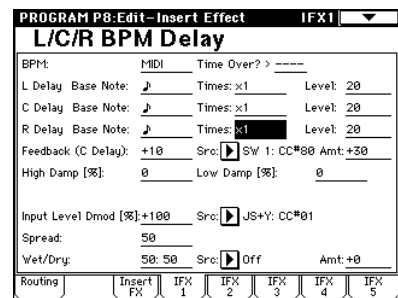

- ⑩ Rotate the [TEMPO] knob, and the delay time will change. When you (push the joystick away from yourself and) press the [SW] key, the feedback level will rise, and the delays will become longer.
- ⑪ When you turn on the ARPEGGIATOR [ON/OFF] switch, the arpeggiator will begin playing. Select any desired arpeggio pattern. When you rotate the [TEMPO] knob, the delay time will change in synchronization with the changing tempo of the arpeggio.

⚠ If you rotate the [TEMPO] knob to change the tempo while the delay is sounding, noise may occur in the delay sound. This is because the delay sound becomes discontinuous, and is not a malfunction.

**MIDI** For some effects, you can synchronize the LFO frequency to the tempo. Set the effect parameters “BPM/MIDI Sync” to On, and “BPM” to MIDI. For details refer to PG p.278.



## Valve Force settings

Valve Force is an analog circuit that uses a 12AU7 (ECC82) vacuum tube. It uses a single vacuum tube to deliver stereo-in/stereo-out operation.

By generating the rich overtones and smooth distortion that are typical of vacuum tubes, Valve Force produces natural depth and a fat, driven tone. Valve Force also includes a low-frequency enhancing “ultra boost” circuit.

You can apply Valve Force to the final stage of a program, combination, song, or sample playback to add rich overtones and smooth distortion, or use insert effects and master effects (except for sample playback) in conjunction with Valve Force to create your sound.

### Valve Force settings for a program

- 1 Press the Valve Force [ON/OFF] key to turn Valve Force on. (The key will light.)

### Placement

- 2 Access the Program P9: Edit-Master Effect, VALVE page.
- 3 Use “Placement” to specify where you want to place the Valve Force circuit.

If you set “Placement” to **Final**, the Valve Force circuit will be placed after conversion to an analog signal by the Main Output L/R output DAC (Digital Analog Converter). After passing through Valve Force, the signal will be output to AUDIO OUTPUT L/MONO, R and from the headphone jack.

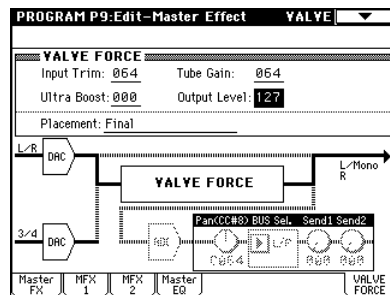

If you set “Placement” to **Insert (User 3/4 BUS)**, Valve Force will be placed after conversion to an analog signal by the Indiv. Output 3/4 output DAC (Digital Analog Converter). Bus 3/4 will be the input to Valve Force, and will simultaneously be output from Individual 3/4.

After passing through Valve Force, the signal will be converted back into digital form by the ADC (Analog Digital Converter), and sent to the insert effects, master effects, L/R, Individual 1/2, and 3/4 buses as specified by the “Pan (CC#8)” “BUS Select,” “Send1,” and “Send2” settings.

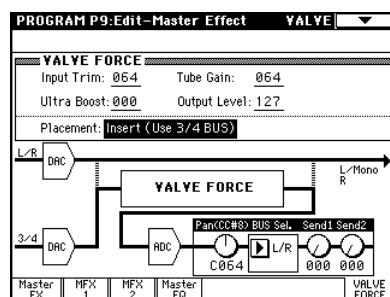

### In/Out

You can't use Valve Force on the L/R output from S/P DIF, nor when resampling the L/R output in the various modes.

- 4 Specify the input/output destination for Valve Force.

If “Placement” = **Final**:

Valve Force will be inserted as the final stage of the L/R output.

If “Placement” = **Insert (Use 3/4 BUS)**:

If you want to send the output of oscillator 1,2 to Valve Force, set “BUS Select (IFX/Indiv.Out Assign)” to 3/4(Tube), 3(Tube), or 4(Tube).

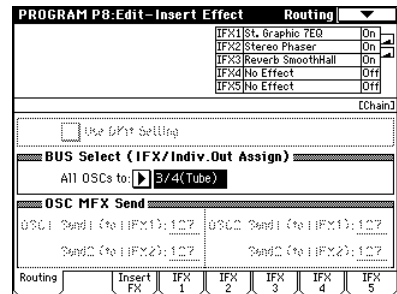

If you want to send the signal through an insert effect and then into Valve Force, set “BUS Select (IFX/Indiv.Out Assign)” to the insert effect, and set the post-IFX “BUS Sel.” to 3/4(Tube), 3(Tube), or 4(Tube).

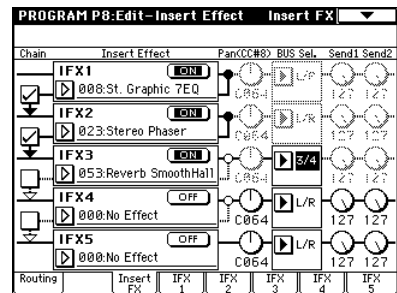

The output from Valve Force is assigned by the Program P9: Edit-Master Effect, VALVE page “BUS Sel.,” “Send1,” and “Send2” settings.

Use “BUS Sel.” to send the signal to the L/R bus, insert effect IFX1–5 bus, or 1, 2 bus. “Send1” and “Send2” adjust the send levels to the master effects.

### Adjusting the Valve Force settings

- 5 Adjust the Valve Force settings.

Select VALVE FORCE as the control function for the front panel REALTIME CONTROLS knobs, or use the Program P9: Edit-Master Effect, VALVE page to adjust the settings.

**Input Trim:** adjusts the input level to Valve Force

**Ultra Boost:** adjusts the mix level to the ultra-boost circuit located at the beginning of Valve Force

**Tube Gain:** adjusts the vacuum tube gain

**Output Level:** adjusts the output level of Valve Force

Depending on the sound you are using, you may hear noise if you turn the Valve Force knobs or edit Valve Force parameters while sound is being produced.

## Valve Force settings for Combination, Song, and Song Play modes

In Combination, Sequencer, and Song Play modes, you can set “Placement” to Final or Insert (User 3/4 BUS) just as for a program.

If you want to apply Valve Force to a specific timbre or track, set “Placement” to Insert (Use 3/4 BUS). The procedure is the same for making settings in Combination, Sequencer, and Song Play modes. As an example here, we will describe the procedure for Combination mode.

- 1 Press the **VALVE FORCE [ON/OFF]** key to turn Valve Force on. (The key will light.)

### Placement

- 2 Access the **Combination P9: Edit-Master FX, VALVE** page.
- 3 Use “Placement” to specify where the Valve Force circuit will be placed.  
Refer to step ③ in the procedure on p.109.

### In/Out

 You can't use Valve Force on the L/R output from S/P DIF, nor when resampling the L/R output in the various modes.

- 4 Specify the input/output destination for Valve Force.

If “Placement” = Final:

Valve Force will be placed at the final stage of the L/R output.

If “Placement” = Insert (Use 3/4 BUS):

If you want to send the output of each timbre (Combination)/track (Sequencer, Song Play) to Valve Force, set “BUS Select” to 3/4(Tube), 3(Tube), or 4(Tube). You can send more than one timbre/track to Valve Force.

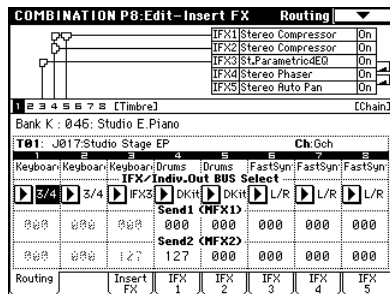

If you want to send the signal through an insert effect and then to Valve Force, set the Routing page “BUS Select” to the insert effect, and set the post-IFX “BUS Sel.” to 3/4(Tube), 3(Tube), or 4(Tube).

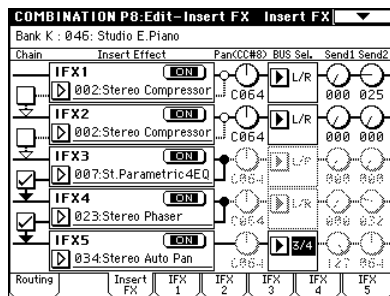

The output from Valve Force is assigned by the Combination P9: Edit-Master FX, VALVE page parameters “BUS Sel.”, “Send1,” and “Send2.”

Use “BUS Sel.” to send the signal to the L/R bus, insert effect IFX1–5 buses, or 1, 2 buses. Use “Send1” and “Send2” to adjust the send levels to the master effects.

### Adjusting the Valve Force settings

- 5 Adjust the Valve Force settings.  
Refer to step ⑤ on p.109.

## Valve Force settings in Sampling mode

In Sampling mode you can apply Valve Force to an external audio source connected to the AUDIO INPUT 1, 2 or S/P DIF IN jacks, and sample the result. You can also apply Valve Force to the samples assigned to a multisample, and resample the result.

- 1 Press the **VALVE FORCE [ON/OFF]** key to turn Valve Force on. (The key will light.)

### Placement

- 2 Access the **Sampling P9: VALVE FORCE** page.
- 3 Use “Placement” to specify the placement of the Valve Force circuit.  
Refer to step ③ of p.109.

### In/Out

 You can't use Valve Force on the L/R output from S/P DIF, nor when resampling the L/R output in the various modes.

- 4 Specify the input/output destination for Valve Force.

If “Placement” = Final:

Valve Force will be placed at the final stage of the L/R output. Use this setting if you want to apply Valve Force to the sound of a multisample.

Set “BUS (IFX) Select” (P8: Insert Effect, Routing page) to L/R or IFX1–IFX5. If you use IFX1–IFX5, set the post-IFX “BUS Sel.” (P8: Insert Effect, Insert FX page) to L/R.

If “Placement” = Insert (Use 3/4 BUS):

If you want the external audio source from the AUDIO INPUT 1, 2, or S/P DIF IN jacks to be input to Valve Force, set “BUS (IFX/Indiv.) Select” to 3/4(Tube), 3(Tube), or 4(Tube).

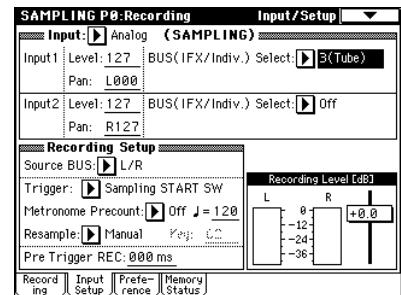

If you want to route the sound through an insert effect and then into Valve Force, set the post-IFX “BUS Sel.” to 3/4(Tube), 3(Tube), or 4(Tube).

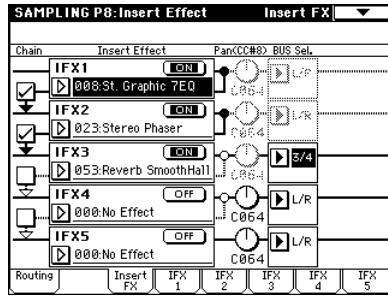

Use “BUS Sel.” to assign the output of Valve Force. You can send the output to the L/R bus, the insert effect IFX1–IFX5 bus, or the 1, 2 buses.

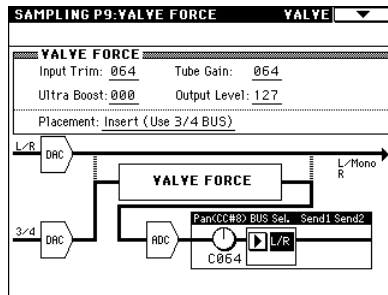

- ⑤ If you want to sample the sound that has passed through Valve Force, set “Source BUS” to the final output bus of the Valve Force signal. You can sample the signal if you’ve set “Placement” to Insert (Use 3/4 BUS).

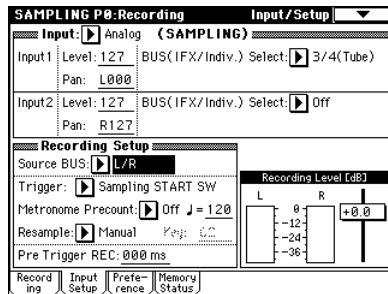

### Adjusting the Valve Force settings, and sampling

- ⑥ Adjust the Valve Force settings, and sample the result. For the sampling procedure, refer to QS p.21.

### Resampling the output of Valve Force

If you want to send a multisample through Valve Force and resample the result, refer to the example of applying an insert effect (p.70).

In step ⑥ (p.70), set “BUS (IFX) Select” to 3(Tube), 4(Tube), or 3/4(Tube), and then resample.

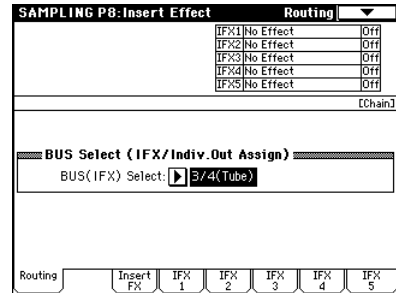

### Valve Force settings for AUDIO INPUT

In Program, Combination, Sequencer, Song Play, and Media modes, you can send an external audio input from the AUDIO INPUT 1, 2, or S/P DIF IN jacks through Valve Force and output the result. This is specified by the “Input (COMBI, PROG, SEQ, S.PLAY, MEDIA)”;

the setting is common to each of these modes (p.107, step ①).

- As an example here, we will explain the settings for Program mode.
- ① Press the VALVE FORCE [ON/OFF] key to turn Valve Force on. (The key will light.)

### Placement

- ② Access the Program P9: Master Effect, VALVE page.
- ③ Use “Placement” to specify the placement of the Valve Force circuit. (p.109, step ③)

### In/Out

You can't use Valve Force on the L/R output from S/P DIF, nor when resampling the L/R output in the various modes.

- ④ Specify the input/output destination for the Valve Force circuit.

#### If “Placement” = Final:

The external audio source input to the L/R bus will be sent through Valve Force at the final stage of the L/R output.

Set “BUS (IFX/Indiv.) Select” to L/R or IFX1–IFX5. If you use IFX1–IFX5, set the post-IFX “BUS Sel.” (inset FX page) to L/R.

**If “Placement” = Insert (Use 3/4 BUS):**

If you want to send the external audio source to Valve Force, set “**BUS (IFX/Indiv.) Select**” to **3/4(Tube)**, **3(Tube)**, or **4(Tube)**.

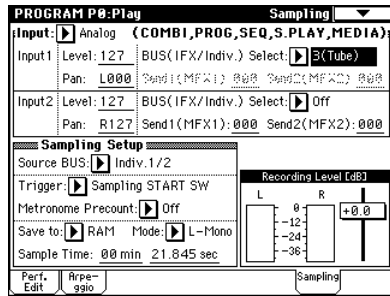

If you want to send the signal through an insert effect and then into Valve Force, set “**BUS(IFX/Indiv.) Select**” to the insert effect, and set the post-IFX “**BUS Sel.**” (Insert FX page) to **3/4(Tube)**, **3(Tube)**, or **4(Tube)**. The Valve Force output is assigned by “**BUS Sel.**”, “**Send1**,” and “**Send2**” (Valve Force page). Use “**BUS Sel.**” to send the signal to the L/R bus, insert effect IFX1–IFX5 bus, or 1, 2 bus. “**Send1**” and “**Send2**” adjust the send levels to the master effects.

# Loading and saving data, creating audio CDs, and editing Wave files (Media mode, etc.)

## Types of data that can be saved

You can save data by writing it to internal memory, saving it to media, or sending it as a MIDI data dump.

**note** In addition to these methods, data stored on media in the CF card slot can be saved to your computer. You can also use Wave files to create an audio CD that can be played in a CD player.

### Writing to internal memory

The following types of edited data can be written into the internal memory.

- **Program**  
Programs 000–127 in banks A–F, H–N  
(However, bank F is available only if the EXB-MOSS option is installed.)
- **Combination**  
Combinations 000–127 in banks A–E, H–N
- **Global settings**  
(Global P0: Basic Setup–P4: Category Name)
- **User drum kits** 000 (A/B)–143 (User)
- **User arpeggio patterns** U000 (A/B)–U506 (User)
- **User template songs** U00–U15  
Song settings such as the song name and tempo, track settings (p.40), arpeggiator settings, and effect settings can be saved (written) to internal memory. However, the musical data for song tracks and patterns are not saved to internal memory. Furthermore, settings that govern how the musical data is played back such as “Meter,” “Metronome,” “PLAY/MUTE,” “Track Play Loop (including Start/End measure),” and RPPR settings will not be saved either. Use the Sequencer mode page menu command “Save Template Song” to write this data (PG p.60).

**⚠** If multisamples or samples from the RAM bank are used in the Multisample or Drum Kit of a program, you should be aware that these multisamples or samples cannot be written into memory. This means that if you turn the power of and then on once again, programs or combinations that use such multisamples or samples will not sound as intended. To reproduce such programs or combinations, the necessary multisamples or samples must be saved on media, and then reloaded.

**⚠** Data that you edit in Sequencer, Song Play, or Sampling cannot be saved in internal memory by the Write operation.

### Saving to various types of media

The following data can be saved to various types of media.

- **.PCG file:**  
Programs, combinations, global settings, user drum kits, user arpeggio patterns (The data that was checked in the check boxes of the Save dialog box will be saved.)
- **.SNG file:** Song and cue list data
- **.KSC, .KMP, .KSF files:**  
Lists of sample and multisamples (.KSC file), multisamples (.KMP file), samples (.KSF file).

- **.MID file:**  
Saves a Sequencer mode song in Standard MIDI File (SMF) format.
- **.EXL file:**  
System exclusive data from an external device that was saved on the TRITON Extreme (This allows the TRITON Extreme to be used as a data filer.)
- **.JKB file:**  
Jukebox lists are saved in Song Play mode (p.87). All other types of file are saved in Media mode.
- **.WAV and .AIF files:**  
A sample you recorded can be exported (written) as a WAVE file or AIFF file.
- **.KCD file:**  
Audio track list

### MIDI data dump

The following types of data can be transmitted as a MIDI data dump and saved on an external data filer or other device.

- **Programs, combinations, global settings, user drum kits, and user arpeggio patterns**
- **Songs, cue lists**

**note** For details on MIDI data dump, refer to PG p.163.

### About preloaded data and preset data

“Preloaded data” refers to the data that is loaded in the TRITON Extreme when it is shipped from the factory. You are free to rewrite this data, and with the exception of the demo songs, the data will be written to the location listed in “Writing to internal memory.” All of this data is stored in the TRITON Extreme’s ROM.

- Program banks A–D, H–M: 000–127  
N: 000–063
- Combination banks A–D, H–M: 000–127
- User drum kits 000 (A/B)–045 (I), 128 (User)–131 (User)
- User arpeggio patterns U000 (A/B)–U488 (User)
- Demo songs S000–S002

Preset data is data that cannot be rewritten by the Write operation. This includes the following data.

- Program banks G, g(1)–g(9), g(d): 001–128
- Preset drum kits 144 (GM)–152 (GM)
- Preset arpeggio patterns P000–P004
- Preset template songs P00–P15
- Preset patterns P000–P149

## Writing to internal memory

### Writing a program or combination

The programs or combinations that you create by using the Performance Editor or by editing parameters in the various Edit pages can be saved in the internal memory of the TRITON Extreme. This action is referred to as “writing a program” or “writing a combination.” If you want your edited data to be preserved after the power is turned off, you must write it.

There are two ways to write a program or combination.

- ⚠ Before you write data into memory, you must turn off the memory protect setting in Global mode. (☞ “Memory protect”)
- ⚠ A combination does not contain the actual program data for each timbre, but simply remembers the number of the program used by each timbre. If you edit a program that is used by a combination, or exchange it with a different program number, the sound of the combination will also change.

### Using a page menu command to write

- ① **Select the page menu command “Write Program” or “Write Combination.”**  
The Write Program/Write Combination dialog box will appear.

**note** You can also access the same dialog box by holding down the [ENTER] key and pressing the [0] key.

The screen shown is for Program mode

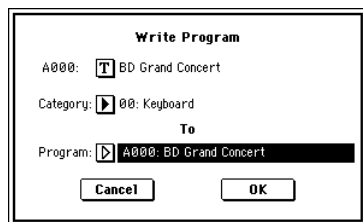

- ② **Check the program/combination name displayed in the upper line (the writing source).**
- ③ **If you wish to change the name of the program/combination, press the text edit button.**  
The text dialog box will appear. Input the name of the program/combination. ☞ “Assigning a name (Rename)”  
After you have input the name, press the OK button to return to the Write Program/Write Combination dialog box.
- ④ **In “Category,” specify the category of the program/combination.**  
In the case of a program, the category you specify here will be used when you select a program by category in Program P0: Play “Category” (Category/Program Select). Program categories can also be used when selecting programs in Combination P0: Play, in P1: Edit-Program/Mixer “Category” (Category/Timbre Program Select), or in Sequencer P0: Play/REC “Category” (Category/Track Program Select).  
In the case of a combination, the category you specify here will be used when you select a combination by category in Combination P0: Play “Category” (Category/Combination Select).

- ⑤ **Use “To” to specify the bank and number of the writing destination program/combination.**  
Use the VALUE controllers or the BANK keys to make your selection.
- ⑥ **To execute the Write operation, press the OK button. To cancel without executing press the Cancel button.**  
When you press the OK button, the display will ask “Are you sure?” When you press the OK button once again, the data will be written.

### Using the (SEQUENCER) [REC/WRITE] key to write

This method can only be used to re-write (update) the selected program/combination number.

- ① **Press the SEQUENCER [REC/WRITE] key.**  
The following Update Program/Update Combination dialog box will appear.

The screen shown is for Program mode

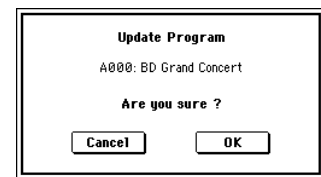

- ② **To write the data, press the OK button. To cancel without writing, press the Cancel button.**

### About the Edit Buffer

When you select a program or combination in Program P0: Play and Combination P0: Play, the program or combination data is called into the “edit buffer.”  
When you modify the parameters in P0: Play or in the Edit pages P1–P9 of Program mode or Combination mode, the changes you make will affect the data in the edit buffer. If you wish to save this modified data into internal memory, you must perform the Write operation.  
When you perform the Write operation, the data in the edit buffer is written to the specified program number or combination number of the specified bank.  
If you select another program or combination without writing, the data of the newly selected program or combination will be called into the edit buffer, and your changes will be lost.

- ⚠ When you press the [COMPARE] key in Program mode or Combination mode, the data from memory (i.e., the contents that were written into memory) will be temporarily called into the edit buffer. This allows you to compare the settings you are editing with the original un-edited settings.

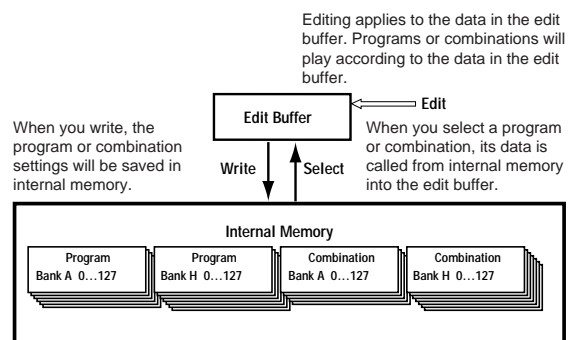

## Assigning a name (Rename)

You can modify the name of an edited program, combination, song, drum kit, user arpeggio pattern, multisample or sample etc..

You can also modify the category names for programs and combinations.

These renaming operations can be performed in the following pages.

Program	Program P0...9 page menu command: Write Program
Combination	Combination P0...9 page menu command: Write Combination
Song	Sequencer P0, 2...4, 7 page menu command: Rename Song
Cue List	Sequencer P1 page menu command: Rename Cue List
Track	Sequencer P5: Track Name
Pattern	Sequencer P6: Pattern Name
Multisample	Sampling P0...4 page menu command: Rename MS
Sample	Sampling P0...4 page menu command: Rename Sample
Drum Kit	Global P5 page menu command: Rename Drum Kit
User arpeggio pattern	Global P6 page menu command: Rename Arpeggio Pattern
Program category	Global P4: Program Cat.
Combination category	Global P4: Combination Cat.
File	Media Save: Save All...Save Audio CD Track List, Utility page menu command: Rename

As an example, here's how to input "Extreme01" in step ③ of "Using the page menu command Write."

- ① Press the text edit button **T** to open the text edit dialog box.
- ② Press the Clear button.  
Press the **Shift** button to switch to uppercase characters, and press E.  
Press the **Shift** button once again to switch to lowercase characters, and press the characters **x, t, r, e, m, e, 0, 1**.
- ③ Press the OK button to close the dialog box.  
If you don't need to make any corrections, press the **OK** button to close Write Program.

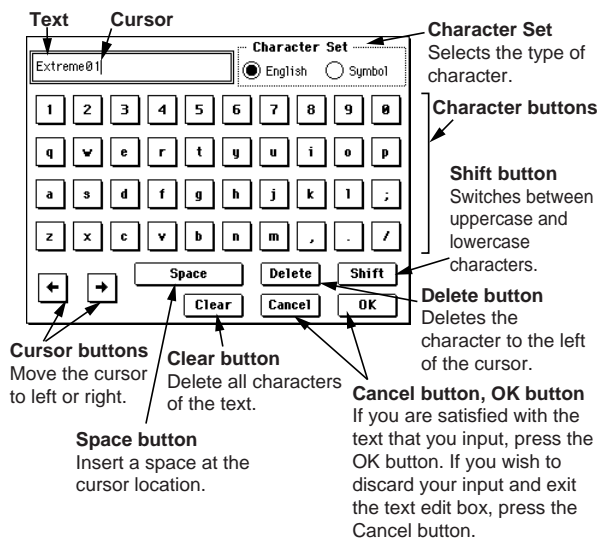

## Memory protect

To prevent programs, combinations, songs, user drum kits, and user arpeggio patterns from being overwritten accidentally, the TRITON Extreme provides a Memory Protect setting that prohibits writing to memory.

Before you save edited data or load data from media, use the following procedure to turn the memory protect off (uncheck the appropriate check box).

You must also turn memory protect off before loading the above data from media or via a MIDI data dump, or before recording in Sequencer mode.

- ① Press the **[GLOBAL]** key to enter Global mode.
- ② After pressing the **[MENU]** key, press either **P0: Basic Setup** or the **[0]** key.
- ③ Press the **System Pref. tab**.  
The System Preference page will appear.

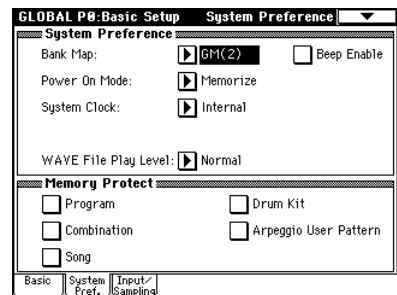

- ④ Press the "Memory Protect" check box for the type of data you wish to write to internal memory, so that the box is unchecked. When the box is unchecked, Memory Protect is off, and data of this type may be written to internal memory.

## Writing global settings, user drum kits, and user arpeggio patterns

The settings you edit in Global mode can be written into internal memory. This is done using the operations **Write Global Setting**, **Write User Drum Kits**, and **Write User Arpeggio Patterns**. If you wish to use these edited settings after you turn the power off, be sure to write the data first.

There are two ways to write global settings, user drum kits, and user arpeggio patterns.

- ⚠ Before you write a user drum kit or user arpeggio pattern, the Global mode memory protect setting must be turned off (☞ “Memory protect”).
- ⚠ The user arpeggio pattern parameter settings “Tempo,” “Pattern,” “Octave,” “Resolution,” “Sort,” “Latch,” “Key Sync,” and “Keyboard” are set independently in the Program, Combination, and Song modes. These settings are not saved when you perform the Write operation described here. If you have edited these parameters in Program or Combination mode you must return to that mode to write them.

### Using a page menu command to write

- ① To write global settings (the various settings in Global P0-P4), press the page menu command “Write Global Setting” in Global P0-P4.

The Write Global Setting dialog box will appear.



To write user drum kits, press the page menu command “Write Drum Kits” in Global P5.

The Write Drum Kits dialog box will appear.



To write user arpeggio patterns, press the page menu command “Write Arpeggio Patterns” in Global P6.

The Write Arpeggio Patterns dialog box will appear.

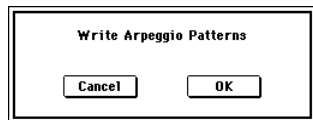

**note** The same dialog box will also appear if, in each of the above pages, you hold down the [ENTER] key and press the [0] key.

- ② To execute the Write operation, press the OK button. To cancel, press the Cancel button. When you press the OK button, the display will ask “Are you sure?” Press the OK button once again to write the data.

## Using the (SEQUENCER) [REC/WRITE] key to write

- ① In the following pages, press the SEQUENCER [REC/WRITE] key.

A dialog box will appear.

**Global settings:** Global P0-P4  
**User drum kits:** Global P5  
**User arpeggio patterns:** Global P6

The example shown is for Update Arpeggio Patterns



- ② To execute the Write operation, press the OK button. To cancel, press the Cancel button.

### Memory in Global mode

When the power is turned on, the Global mode data is called from internal memory into the Global mode memory area. Then when you modify the parameters in Global mode, the data in the memory area will be modified. If you wish to save this modified data in internal memory, you must Write it.

When you write, the data in the memory area will be written into the global settings, drum kits, and arpeggio patterns of internal memory.

If you turn off the power without writing, the modified data in the memory area will be lost.

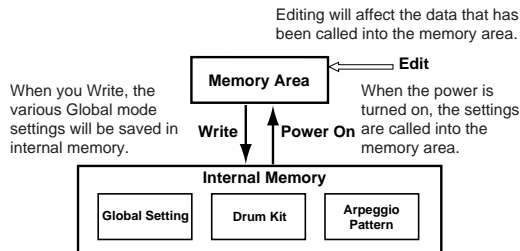

## The pages of Media mode

Media mode page structure

Page	Explanation
Load	Load the selected file or directory into internal memory.
Save	Save data from internal memory to media such as a media.
Utility	Rename, copy, or delete a disk or file, create new directories, and set the date and time.
Make Audio CD	Write Wave files to an audio CD.
Play Audio CD	Play back an audio CD.
Edit WAVE	Edit Wave files stored in media.
Media Information	View information for the selected media.

**note** For details on how to access each mode and page, refer to “Basic operation” (☞ p.13).



## ..... Saving on media      Media, Save

For details on the data that can be saved on storage media. (“Types of data that can be saved” p.113).

The Media mode Save page is where you save data to media.

**⚠** Song data and cue lists in the TRITON Extreme’s Sequencer mode, as well as multisamples and samples cannot be written into internal memory. This data will disappear when the power is turned off. If you want to keep this data, save it to the media described below.

You can also save other types of data to media. When you’ve come up with settings you like, it’s a good idea to save them, so that even if you subsequently edit those settings, you’ll always be able to reload the previous settings if desired.

### Media you can use for saving and loading

#### A card inserted in the CF card slot

- **CompactFlash** (Type I, Type II)  
Only power supply voltage +5V is supported; 16 Mbyte–1 Gbyte
- **Microdrive** Only power supply voltage +5V is supported  
1 Gbyte

#### External USB storage media

- **Hard disk**
- **Removable disk**  
Hard disks and removable disks in MS-DOS format FAT16 or FAT32 are supported.  
Capacity recognized: FAT32: up to 2 terabytes = 2,000 Gbytes  
FAT16: up to 4 Gbytes
- **CD-R/RW**  
This supports UDF format. UDF format CD-R/RW discs can be written or read. (Packet writing is supported p.330).  
You can also record/play CD-DA (audio CD), and load ISO 9660 (level 1) format data.  
For details on connecting a device to the USB A or B connector, refer to PG p.325.

**⚠** These types of media are not included. You will need to purchase them separately. Refer to p.137.

### Setting up media

- ① **If you are using a CompactFlash or Microdrive card, insert it into the TRITON Extreme’s CF card slot.**  
For details on handling CompactFlash and Microdrive media, refer to p.125.
- ⚠** You must turn off the power before inserting media into the CF card slot. Failing to do so may cause your data to be damaged.
- ⚠** Be sure to insert the media in the correct orientation. Press the media all the way into the CF card slot.

**If you are using a USB hard disk, removable disk, or CD-R/RW drive, use a USB cable to connect your device’s USB connector to the TRITON Extreme’s USB A connector.**

**note** The TRITON Extreme’s USB A/B connectors support hot-plugging; you can connect or disconnect the USB cable while the power is on. However in order to do so, your USB device must also support hot-plugging.

- ② **Turn on the power.**
- ⚠** Do not insert or remove CF slot media while the power is on. Doing so may cause the stored data to be damaged.
- ③ **If you are using a USB hard disk, removable disk, or CD-R/RW drive, turn on the power of your USB device and use a USB cable to connect it to the TRITON Extreme’s USB A connector.**

**note** The above step assumes that your USB device supports hot-plugging. If you are using a device that does not support hot-plugging, connect it with the power turned off. Then turn on the power, and execute the Utility page menu command “Scan USB Device.”

**⚠** While the TRITON Extreme is accessing the USB device, do not connect another USB device or disconnect the connected device. Doing so may damage your data.

- ④ **Press the [MEDIA] key to enter Media mode.**

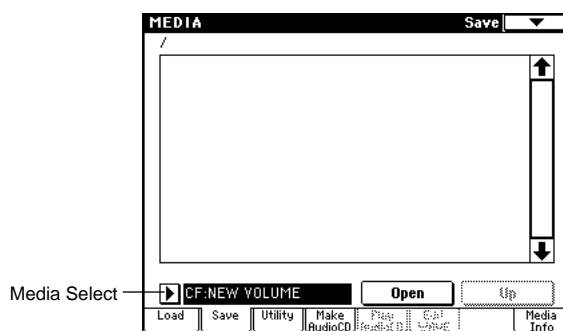

- ⑤ **Use “Media Select” to select your media.**
- note** If you are using a removable disk, insert the media. After you exchange media in your USB device, press the LCD screen to make the TRITON Extreme detect the media. When the media has been detected, the LCD screen will display information about the media.
- ⑥ **If the media needs to be formatted, execute the Format operation.**  
Media requiring formatting is indicated as Unformatted in “Media Select.”  
For details on the formatting procedure, refer to p.119.

### How to save data

You can save the various types of data listed in “Saving to various types of media” (p.113), but as an example here we will save the following data. As an example, we will explain how to save the following data.

- Internal memory programs, combinations, global settings, user drum kits, user arpeggio patterns
- Songs, cue lists
- Multisamples and samples created in Sampling mode etc.

**⚠** If you save this data to low-capacity media, you may need more than one disk.

- ① Prepare the media on which you want to save the data.  
(☞ “Setting up media”)
  - ② Press the [MEDIA] key to enter Media mode.
  - ③ Press the Save tab to access the Save page.
  - ④ Press “Media Select” to select the save-destination media.
  - ⑤ If the media contains directories, select the directory in which you want to save the data.  
Press the Open button to move to a lower level, or press the Up button to move to an upper level.
- note** If you are saving data on high-capacity media, we recommend that you create directories to organize the media into sections.  
To create a new directory, move to the level at which you want to create the directory, and execute the Utility page menu command “Create Directory.”
- ⑥ Press the page menu button to access the page menu, and press “Save All.”  
“Save All” will save .PCG, .SNG, and .KSC files.

Hide unknown file	Save to Std MIDI File
Translation	Save Exclusive
Save All	Export Smpl as AIF/WAY
Save PCG & SEQ	Save Audio CD Track List
Save PCG	
Save SEQ	
Save Sampling Data	

A dialog box will appear. The contents, settings, and operations for the dialog box will depend on the type of data that you are saving.

- ⑦ Press the text edit button and input a filename for the file you want to save. (☞ p.115)
- ⑧ Press each Selection button to access the dialog box, and use the check boxes to uncheck any items that you do not need to save.

In order to accurately reproduce the data you created, we recommend that you check all of the boxes.

- ⑨ Press the OK button to execute the Save operation.  
**If the data fits on one volume of media**  
The data will be saved on the specified media, and you will return to the Save page.

**If the data does not fit on one volume of media**  
The “No space available on medium” dialog box will appear.

Press the **OK** button and the file will be divided and saved to multiple volumes of media (for the Save procedure ☞ PG p.187). If you don't want to divide the file, press the **Cancel** button, and re-save it to larger-capacity media.

- ⑩ **When saving ends and you return to the Save page, the LCD screen will show the file that was saved.**  
The data will be saved to the media, and you will return to the Save page.  
The amount of time required will depend on the amount of data.

If a file with the same name already exists on the media, you will be asked whether you want to overwrite. If you wish to overwrite, press the OK button. If you wish to save without overwriting, press the Cancel button, re-do the operation from step ⑥, and rename the data in step ⑦ before saving it.

The LCD screen will show the files that were saved.  
The various types of data are saved as the following files.

**.PCG file**

Programs, combinations, user drum kits, user arpeggio patterns, and global settings that were saved in internal memory

**.SNG file**

Sequencer songs and cue lists

**.KSC file**

A file which lists the multisamples and samples used

**Directory**

A directory containing the multisamples (.KMP files) and samples (.KSF files) that are listed in the .KSC file

- note** When using “Save All,” “Save PCG & SNG,” and “Save PCG” to save combinations, you should also remember to save the programs used by each timbre (and the drum kits used by the programs) and user arpeggio patterns at the same time.  
Similarly when saving programs, you should also remember to save the drum kits and user arpeggio patterns used by the programs.

- note** If your programs or drum kits use multisamples and samples that were created in on TRITON Extreme, we recommend that you use “Save All” to save the data. When you use “Save PCG” or “Save Sampling Data” to individually save a program or drum kit, or a multisample or sample that you created, we recommend that you save them under the same filename in the same directory. When you use “Load PCG” to load a .PCG file, the identically-named .KSC file will also be loaded so that the correct multisamples/samples will correspond automatically.

---

## Using the TRITON Extreme as a data filer

The TRITON Extreme can receive MIDI exclusive data sent by an external device, and save this data to media. (This is referred to as Data Filer functionality.) Execute the page menu command “Save Exclusive.” (PG p.189)

.....

## File copying, deleting, and formatting (Media, Utility)

In the Media mode Utility page you can rename, copy, or create new files on media. You can also format or optimize media. In this page you can also transfer data between a computer connected to the USB B connector and media inserted in the TRITON Extreme's CF card slot.

---

### Formatting media

Here's how to format media.

Newly purchased media or media that has been used by another device cannot be used “as is”; you must format the media before you can use it with the TRITON Extreme.

⚠ When you format, all data saved on that media will be erased. If you had used a computer etc. to set up that drive so that it can be used as multiple drives (partitions), this data will also be erased. Be sure to double-check before you format.

⚠ After formatting, it is not possible to press the [COMPARE] key to return to the previous state.

① **Make sure that the media you want to format is inserted.**

(p.117 “Setting up media”)

② **Press the [MEDIA] key to enter Media mode.**

③ **Press the Utility tab to select the Utility page.**

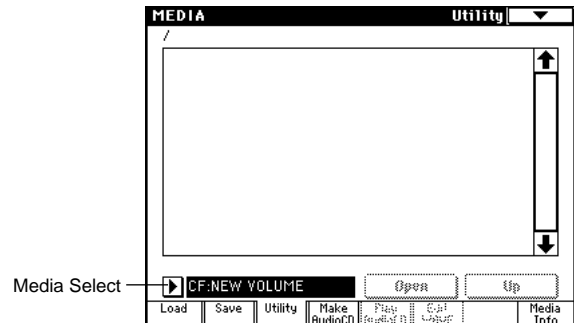

④ **Press “Media Select,” and choose the media that you want to format.**

⑤ **Press the page menu button to access the page menu, and press “Format” to open the dialog box.**

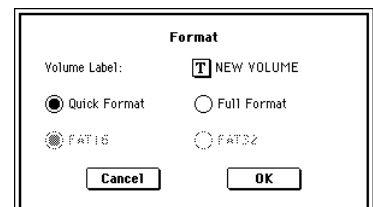

⑥ **In “Volume Label,” use the text edit button to access the text input dialog box, and specify the volume label.**

The previously-specified volume label will be displayed. If no volume label had been specified for the media, or if a non-DOS media was inserted, this will indicate “NEW VOLUME.”

⑦ **Specify the initialization format.**

**Quick Format:** Normally you should use Quick Format to initialize the media.

Select this if the media has already been physically formatted, or if you want to format media that has been UDF-formatted by the TRITON Extreme.

**note** Since only the system area of the media need be formatted, this will require less time.

**Full Format:** Select this when formatting media that has not been physically formatted, or media (CD-RW) that has not been UDF-formatted.

⚡ Normally, it is not necessary to perform a Full Format on media that has been physically formatted at 512 bytes/block. Execute the Quick Format for such media.

**note** You will normally select Full Format for CD-RW media etc. that has not been UDF-formatted. If an error message of "Media not formatted" appears, execute Full Format.

Depending on the capacity of the media, executing Full Format may require a substantial length of time.

**note** Some USB devices don't support the Full Format operation. For details, refer to the owner's manual for your device.

⑧ **Specify the file system.**

**FAT16** can format a maximum of 4 Gbyte. If you are using media larger than 4 Gbyte, use **FAT32** format to format it.

**note** Use **FAT16** to format CompactFlash or Microdrive media of 4 Gbyte or less.

⑨ **Press the OK button to format, or press the Cancel button if you decide to cancel.**

When you press the OK button, a message will ask you for confirmation. Press the OK button once again to execute the Format operation.

⚡ You must format a CD-R/RW disc before you can use it for packet-writing.

You do not need to format a CD-R/RW disc that you will use to create an audio CD. If a CD-R/RW disc has previously been used by another device, you must format it.

⚡ You must use the TRITON Extreme to format the media. The TRITON Extreme will not correctly recognize media that has been formatted by another device.

## Setting the calendar function

Here's how to set the date and time for the TRITON Extreme's internal calendar. The date and time are recorded when you save data. Use the page menu command "Set Date/Time" (Media, Utility page) to make these settings.

**note** You will need make these settings after you purchase the TRITON Extreme, and after you replace the calendar backup battery.

① **In the 0-3: Utility page, select the page menu command "Set Date/Time."**

The following dialog box will appear.

The screenshot shows a dialog box titled "Set Date/Time". It contains six input fields: "Year:" with the value "2003", "Month:" with "09", "Day:" with "15", "Hour:" with "07", "Minute:" with "00", and "Second:" with "00". At the bottom of the dialog box, there are two buttons: "Cancel" and "OK".

② **Use the VALUE controllers to set "Year," "Month," "Day," "Hour," "Minute," and "Second" to the correct year, month, day, hour, minute, and second.**

③ **Press the OK button.**

⚡ If the calendar backup battery runs low, a message of "Battery voltage for calendar IC" will appear in the LCD screen. If the calendar backup battery runs down completely, the calendar will be initialized, and the date and time will not be recorded correctly.

**note** You can replace the calendar backup battery by yourself. Refer to PG p.324 for details.

## Saving data from CF card slot media to your computer

You can use your computer to access media inserted in the CF card slot, and save the data to your computer's hard disk, or copy Wave files or other data from your computer's hard disk to the media in the CF card slot. Execute the Utility page menu command "USB Storage Mode."

**note** For details on the procedure and on the requirements for your computer, refer to PG p.193, 325.

## Loading data Media, Load

The types of data that can be loaded from media are shown in the diagram below. (For details on each type of data, refer to PG p.177)

The Media mode Load page lets you load data from media.

**note** Refer to p.137 for details on the types of media from which you can load media.

### Loading data

#### Loading .PCG, .SNG, and .KSC files

As an example here, we will explain how to load a song. We'll assume that this song uses edited programs and programs that use multisamples you sampled. In such cases, it is best to load "all data."

When loading programs, combinations, songs, user drum kits, or user arpeggio patterns, you must make sure that the Global mode memory protect setting is unchecked. (p.115)

When you load a .PCG file, the data in the TRITON Extreme's internal memory will be overwritten by the data of the .PCG file (programs, combinations, drum kits, user arpeggio patterns, global settings). If you want to keep the data that is currently in internal memory, use "Save All" to save it before you proceed.

- ① **Make sure that the media is ready for you to load data.**  
(Refer to p.117 "Setting up media")
- ② **Press the [MEDIA] key to enter Media mode.**

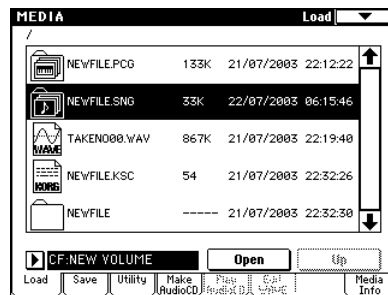

- ③ **Press the Load tab to select the Load page.**
- ④ **Press "Media Select" and select the media from which you want to load.**

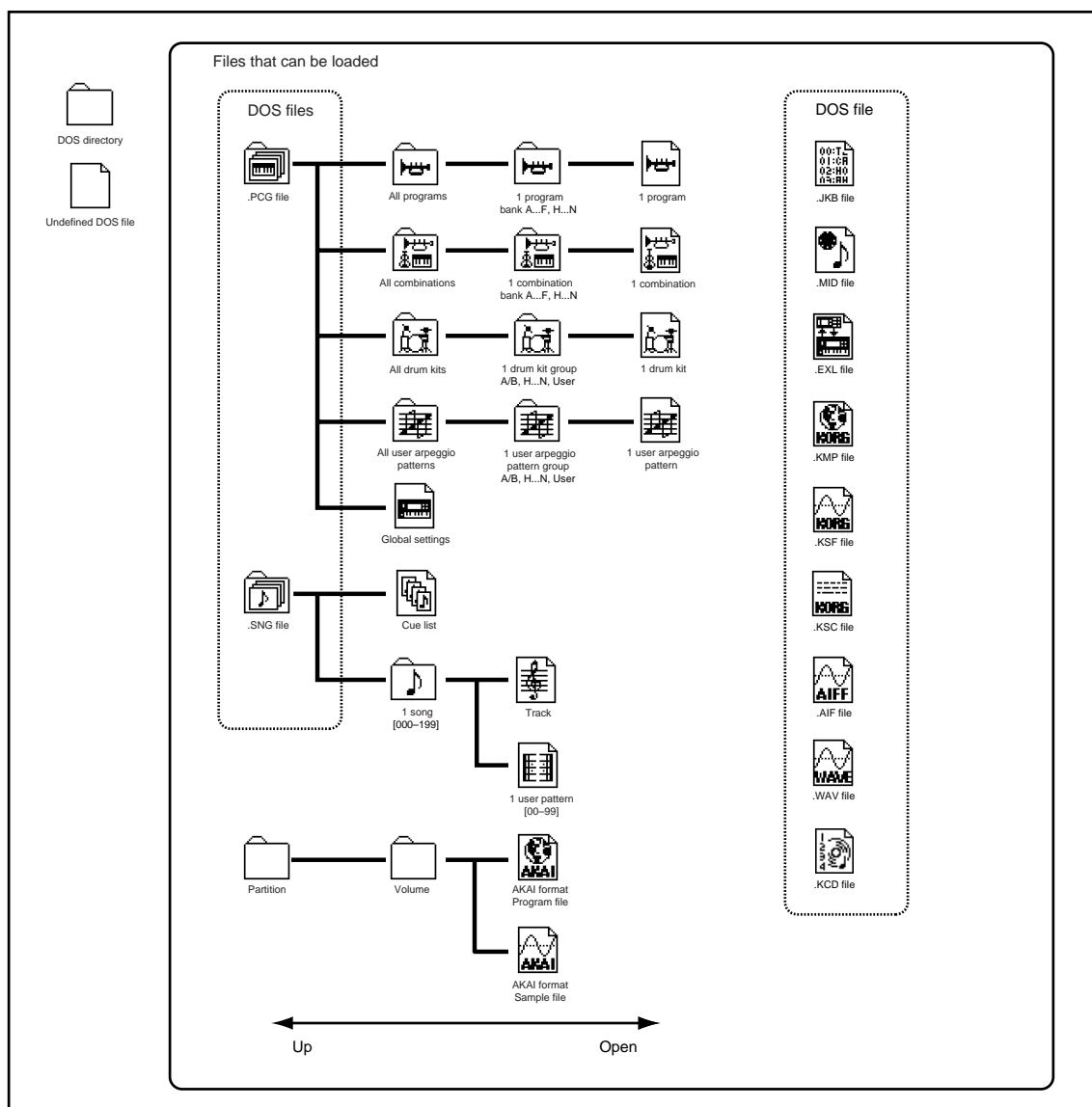

- ⑤ **Navigate to the directory that contains the file you want to load, and select the .SNG file.**

Press the Open button to move to a lower level, or press the Up button to move to a higher level. The selected .SNG file will be highlighted.

- ⑥ **Press the page menu button to access the page menu, and choose “Load Selected.”**

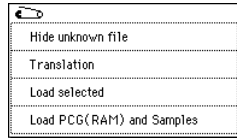

A dialog box will appear.

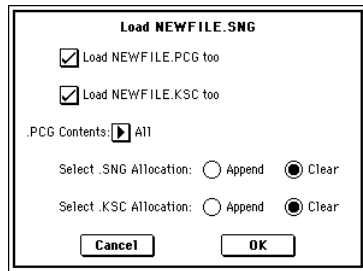

**note** The contents and settings of the dialog box will differ depending on the type of file that you are loading.

- ⑦ **Check the “Load \*\*\*\*\*.PCG too” check box.**

When you execute loading, the .PCG file will be loaded along with the .SNG file.

**Check the “Load \*\*\*\*\*.KSC too” check box.**

When you execute loading, the .KSC file will be loaded along with the .SNG file.

**Use “.PCG Contents” to specify the data that you want to load.**

If you want to load all the data in the .PCG file, select All.

**Use “Select .SNG Allocation” to specify the destination to which the song data will be loaded.**

“Append” will load the song into the song number that follows the song(s) currently existing in internal memory, without leaving a vacant number.

“Clear” will erase all songs and the cue list from internal memory, and load the songs into the numbers from which they were saved.

**Use “Select .KSC Allocation” to specify where the multisamples and samples will be loaded.**

“Append” will load the data into the next available vacant numbers following the multisamples and samples that are already in sample memory (RAM).

“Clear” will erase all multisamples and samples from sample memory (RAM), and load the data in the same configuration with which it was saved.

- ⑧ **Press the OK button to execute loading.**

Never remove the media while data is being loaded.

## Loading individual banks from a .PCG file

- ① **Select the .PCG file containing the data you want to load, and choose the page menu command “Load Selected.”**

Refer to steps ①–④ of “Loading .PCG, .SNG, and .KSC files,” select the .PCG file in step ⑤.

- ② **Press the page menu button to open the page menu, and choose “Load Selected.”**

You can load individual banks by using “.PCG Contents” in the dialog box to select the load-source bank, and “To” to select the load-destination bank.

When you execute loading, only the programs, combinations, drum kits, and user arpeggio pattern data of the selected bank will be loaded into the load-destination bank you specify. Global setting data will not be loaded.

If you set “.PCG Contents” to Bank A, and “To” to Bank A, data will be loaded as follows.

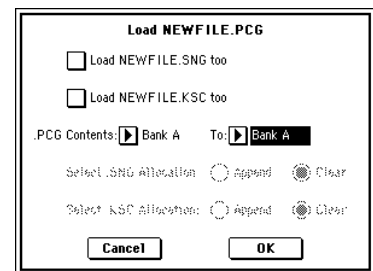

### Programs

- Bank A: loaded into bank A

### Combinations

- Bank A: loaded into bank A

### Drum Kits

- 000–015 (A/B): loaded into bank A/B

### Arpeggio Patterns

- 000–199 (A/B): loaded into bank A/B

When data is loaded into a bank that is different than its original bank, the data (bank, program, pattern, and kit numbers, etc.) will automatically be reconfigured so that after loading, the various types of data will correspond correctly in each mode.

The following data will also be reconfigured automatically if you have checked “Load .SNG too” (so that song data is loaded at the same time), the following data will also be reconfigured automatically in order to ensure that the song data plays back correctly.

- The bank of each program used by combinations
- The pattern number of each user arpeggio pattern used by the combinations/programs/songs
- The kit number of the drum kit used by each program
- The bank of the program used by each track of the song
- If the song contains track/pattern events, the program banks within these events

## Loading data by individual item or bank

The TRITON Extreme lets you load programs and combinations individually or by individual banks. Drum kits and arpeggio patterns can also be loaded individually or as a group.

This is a convenient way to rearrange combinations in the order in which you will use them during a live performance.

- ⚠ Be aware that if you change the order of programs, the sounds played by combinations may also be affected. (p.133)

As an example here, we will explain how a combination saved in bank D can be loaded into E000.

- 1) Move to the “Bank D” directory, and select the combination that you want to load. (.PCG file/Combinations/Bank D/)

The procedure is as follows.

- 1) Perform steps ①–⑤ described above, press the .PCG file containing the data you want to load (it will be highlighted), and press the Open button.
- 2) Press “Combinations” to highlight it, and press the Open button.
- 3) Press “Bank D” to highlight it, and press the Open button.
- 4) Press the scroll bar to find the combination you want to load, and highlight it in the display. Alternatively, you could select any file, since the desired file can be selected later from the dialog box.

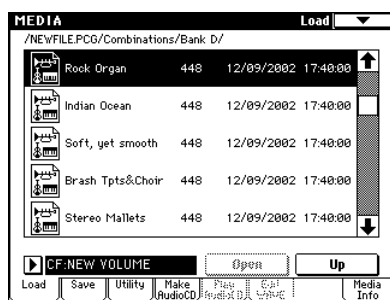

- ⚠ When you press the keyboard of the TRITON Extreme, the selected combination will sound. However, the internal programs will be used as the program of each timbre.

- 2) Press the page menu button and select the “Load Selected” page menu command.

The dialog box will appear.

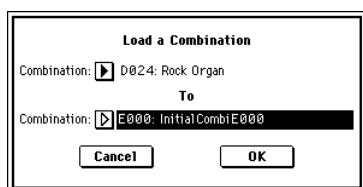

- 3) Use the “Combination” (upper line) to select the load-source combination, and use “(To) Combination” (lower line) to specify the destination combination. For this example, select E000: InitialCombiE000.
- 4) Press the OK button to execute loading; the loaded combination will be assigned to E000.

## Use sampled Wave files to create an audio CD and play it: Media, Make Audio CD, Play Audio CD

Songs you resampled in Sequencer mode (p.83) or other Wave files can be arranged in any order you like and burned to CD located in a CD-R/RW drive connected to the USB A port to create an original audio CD.

- ⚠ Make sure that both media are detected by the TRITON Extreme.

- ⚠ When writing data to CD-R/RW media, the media containing the Wave files must have free space equal in size to the Wave files you are writing. Before you execute this operation, make sure that the drive containing the Wave files contains enough free space.

- ⚠ When writing Wave files to a USB CD-R/RW drive to create an audio CD, we recommend that you use a drive that supports Just Link. Other drives are usable only at single-speed (1x) writing. Depending on the performance of your drive, there may be cases in which writing is not possible.

- 1) Access the Media mode Make Audio CD page.

In the default state, the WAVE File area will show only “====End====.”

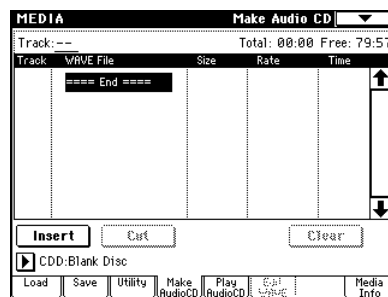

- 2) To the track list, add the WAVE files that you want to write to the CD.

Select “====End====” (it will be highlighted), and press the Insert button.

The Insert Track dialog box will appear.

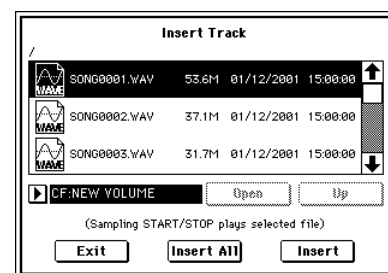

Use media select and the Open and Up buttons to access the directory that contains the WAVE file, and select the WAVE file that you want to add to the list.

If you want to audition the file, you can press the SAMPLING [START/STOP] key to play back the sample.

- ⚠ If you have selected a WAVE file with a sampling frequency other than 44.1 kHz or 48 kHz, it will not be possible to press the Insert button.
- ⚠ WAVE files at a sampling frequency of 48 kHz will be converted to 44.1 kHz when they are written to an audio CD (when you execute “Write to CD”).

To add the file, press the **Insert** button.

You can continue adding files until you press the **Exit** button. The files will be added to the track list in the order in which you selected them. If you want to add all the WAVE files in the directory, press the **Insert All** button.

When you have finished adding files to the list, press the **Exit** button to close the dialog box.

Notice that the WAVE files have been added to the track list.

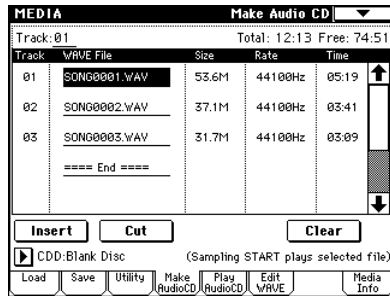

In this page as well, you can select a WAVE file and press the SAMPLING [START/STOP] key to play back the sample.

To add other WAVE files to the track list, press the **Insert** button once again.

If you want to add another track, select the WAVE file that follows the track you want to add. If you want to add the track to the end of the track list, select "====End====." Then press the **Insert** button.

To delete a WAVE file from the track list, select the WAVE file that you want to delete, and press the **Cut** button.

Subsequent tracks will be moved forward in the list.

**note** For details on editing operations such as **Clear** and **Swap Track**, refer to PG p.195.

③ **Insert a blank CD-R or CD-RW disk into the drive.** In the **Make Audio CD** page, use "Media Select" to select your CD-R/RW drive. The CD-R/RW drive is shown as "CDD: Blank Disc."

⚠ An audio CD cannot be created on a disc that contains data other than audio (e.g., files). In this case, it will not be possible to select the page menu commands "Write to CD" or "Finalize Audio CD."

**note** Even when the recommended CD-R/RW media is used, some audio CD players may be unable to play back the disc. Also, since some audio CD players are unable to play back CD-RW media, we recommend that you use CD-R media.

④ **Select the page menu command "Write to CD" to access the dialog box, and specify how the CD will be written.**

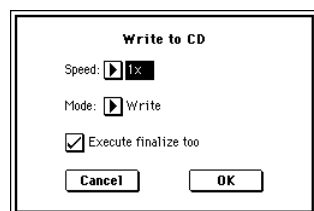

Use "Speed" to set the writing speed. This will indicate the speeds supported by the CD-R/RW drive you are using.

In this example, set "Speed" to 1x.

⚠ Be aware that if you use a faster writing speed in a slower system, writing errors will occur.

Use "Mode" to specify the writing method.

**note** Depending on the drive you are using, it may not be possible to write at the specified speed. We recommend that the first time you write, you select **Test** to perform a writing test in order to determine the speed capabilities of your drive. **Test** will not write data to the CD-R/RW media, but will perform all other processing just as when data is actually written. If an error occurs, the display will indicate "Error in writing to medium."

Press the **OK** button to execute the writing test.

After verifying that data can be written correctly at the specified speed, select **Write**.

"Execute finalize too" specifies whether Finalization will be executed after the audio tracks have been written to the CD-R/RW media. If finalization has been executed, the disc can be played back on a CD player, but it will no longer be possible to add more tracks.

**note** If you only want to execute finalization, execute "Finalize Audio CD."

⑤ **When you are ready to write to the CD-R/RW media, or to execute a writing test, press the OK button. To cancel without executing, press the Cancel button.**

⚠ When you press the **OK** button, the "Obey Copyright Rules" dialog box will appear.

Carefully read "About copyright" (see QS p.iii). If you accept the terms, press the **OK** button to write to the CD or to perform the test. If you do not accept the terms, press the **Cancel** button to cancel the operation.



⚠ In order to avoid causing errors, do not subject the drive to physical shock or vibration while CD-R/RW media is being written.

⑥ **An audio CD to which audio tracks have been written and which has been finalized can be played in the Play Audio CD page, allowing you to hear the CD you have created.**

Press the **Play Audio CD** tab to access the **Play Audio CD** page.

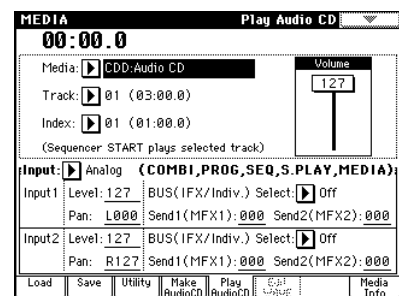



In “Drive,” select your CD-R/RW drive. “Drive” will indicate **Audio CD**.

Make the following settings to allow monitoring.

“Input”: Analog

*Input1* “BUS (IFX/Indiv.) Select” L/R, “Level” 127, “Pan” L000

*Input2* “BUS (IFX/Indiv.) Select” L/R, “Level ”127, “Pan” R127

“Volume” 127

Use “Track” to select the track, and press the SEQUENCER [START/STOP] key to begin playback.

 If you’re using a drive that does not have audio output jacks or a headphone jack, you won’t be able to monitor the sound.

### Saving a track list that you have completed or partially edited

 The track list will be lost when the power is turned off. If you want to keep this data, you must save it.

- ① **In the Save page, select the directory in which you want to save the track list.**
- ② **Select the page menu command “Save Audio CD Track List” to access the dialog box.**
- ③ **Press the OK button to save the data, or press the Cancel button to cancel without saving.**

## Editing a Wave file: Media, Edit WAVE

You can edit Wave files stored on media.

This is a convenient way to edit large files to a size that can be loaded into the TRITON Extreme’s sample memory (RAM).

- **In the Load, Save, Utility, or Make Audio CD page, select the Wave file you want to edit and then access this Edit WAVE page.**

**note** You cannot edit a Wave file that exceeds 230,400,000 samples (80 minutes at a 48 kHz sample rate).

**note** The sample rates of Wave files that can be edited are the same as the sample rates supported for KSF files. (PG p.317)

## Viewing information about media: Media, Media Info

You can view information about the media selected by “Media Select.” You can also mount a device connected to the USB A connector. (PG p.203)

## Handling CompactFlash and Microdrive media

Immediately after use, CompactFlash or Microdrive media may be at a high temperature. Before removing the media, power-off the TRITON Extreme and allow the temperature to cool down.

CompactFlash and Microdrive media are precision devices. Do not bend them, subject them to excessive force or shock, or drop them. Microdrives in particular are prone to damage from vibration; handle them with care. Do not use or store these types of media in locations of extremely high or low temperature, in direct sunlight, in a closed automobile, near heating equipment, or in locations of excessive humidity or dust.

Avoid using or storing these types of media in locations where there may be strong static electricity or electrical noise.

Be careful not to let dust or dirt adhere to the terminals of the CompactFlash or Microdrive media. If the terminals should become soiled, wipe them lightly with a dry cloth. When not using media, protect it from static electricity by keeping it in the protective case that came with it. Keep media out of reach of infants or children, since they may place it in their mouth and possibly choke on it or swallow it.

Carefully read the instructions included with the media.





# Restoring the factory settings

The preload data stored in the TRITON Extreme can restore all the programs, combinations, drum kits, user arpeggio patterns, and global settings to their original factory settings. The original demo songs can also be re-loaded at any time using this same method.

This is done by re-loading the preload data stored within the TRITON Extreme.

 Before you load the preload data, go to the Global mode P0: Basic Setup, System Preference page, and uncheck the “Memory Protect” settings for the data that you want to load. If you execute this operation with these settings checked, a message of “Memory Protected” will appear, and the data will not be loaded.

 Never turn off the power while the data is being loaded.

 When you load a .PCG file, the data in the TRITON Extreme’s internal memory will be overwritten by the data of the .PCG file (programs, combinations, drum kits, user arpeggio patterns, global settings). If you want to keep the data that is currently in internal memory, use “Save All” or “Save PCG” to save it before you continue.

## Restoring the factory settings

- ① **Access the Global mode P0: Basic Setup, Basic page.**  
Press the [GLOBAL] key to enter Global mode. If the Global P0: Basic Setup, Basic page is not shown, press the [EXIT] key and then press the Basic tab.
- ② **Press the page menu button, and choose “Load Preload/Demo Data.”**

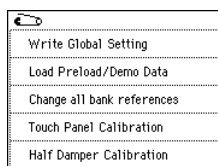

A dialog box will appear.

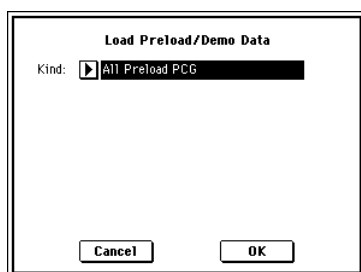

- ③ **In the “Kind” field, select All Preload PCG.**

**note** If you execute All (Preload PCG and Demo Song), the following data will be loaded. If you execute, All Preload PCG, the Demo Song data will not be loaded.

- ④ **Press the OK button to execute the load operation. If you decide not to execute, press the Cancel button.**

When you press the OK button, a dialog box will ask you for confirmation. Press the **OK button** to execute loading.

**note** From the powered-off state, you can automatically perform the “All (Preload PCG and Demo Data)” operation by turning on the power while holding down the [MENU] key and [EXIT] key. (A message of “Now writing internal memory” will appear while the data is being loaded.)

### If the EXB-MOSS is not installed

Preload data will be loaded into the following banks  
Program: Bank A, B, C, D, H, I, J, K, L, M, N (000–63)  
Combination: Bank A, B, C, D, H, I, J, K, L, M  
Drum Kit: 000(A/B) – 045(I), 128(User) – 131(User)  
Arpeggio Pattern: U000(A/B) – U488(User)  
Global Setting  
Demo Song: S000–S002

### If the EXB-MOSS is installed

Preload data will be loaded into the following banks  
Program: Bank A, B, C, D, F\*, H, I, J, K, L, M, N (000–63)  
Combination: Bank A, B, C, D, E\*, H, I, J, K, L, M  
Drum Kit: 000(A/B) – 045(I), 128(User) – 131(User)  
Arpeggio Pattern: U000(A/B) – U488(User)  
Global Setting  
Demo Song: S000–S003\*

Data for the EXB-MOSS will be loaded into Program Bank F000–127, Combination Bank E000–063, and song S003.

 Demo song data will be erased when the power is turned off.

## Loading the EXB-MOSS data

After installing the EXB-MOSS, you will need to load the data for it. The TRITON Extreme contains preload data and demo song data for the EXB-MOSS.

There are two ways to do this; you can load all of the TRITON Extreme's preload data, or you can load the minimum amount of data while erasing as little as possible of the current data. If you load all data, all of the preload data will be erased, but you'll need to perform only a single load operation. If you load only the minimum data, the rest of your current data will be preserved, but you'll need to perform several load operations.

### Loading all data

- 1 Execute loading as described in "Restoring the factory settings."

If you are loading for the first time, you'll probably want to set "Kind" to All (Preload PCG and Demo Song) so that the song data is loaded as well.

If the EXB-MOSS is installed, data for the EXB-MOSS will be loaded automatically.

- 2 After you've executed the load operation, use Sequencer mode to listen to the EXB-MOSS demo song.

**note** For details on the data that is loaded, refer to the preceding page.

### Loading only the minimum data

- 1 Perform steps 1 and 2 described in "Restoring the factory settings" to access the "Load Preload/Demo Data" dialog box.
- 2 Specify the "Kind" and bank. Set "Kind": Program, and "Bank": F To F (see the illustration)

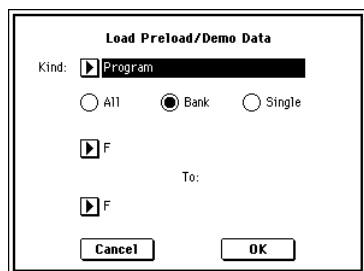

**note** EXB-MOSS programs can be loaded only into Bank F.

- 3 Press the OK button to execute loading. If you decide to cancel, press the Cancel button.

When you press the OK button, a dialog box will ask you for confirmation. Press the OK button to execute loading.

- 4 As described in steps 1–3, load three more sets of data with "Kind" and the bank set as follows.

"Kind": Program, "Bank": J To J

"Kind": Program, "Bank": K To K

"Kind": Drum Kit, "Bank": A/B To A/B

"Kind": Arpeggio Pattern, "Bank": A/B To A/B

"Kind": Combination, "Bank": E To E

**note** EXB-MOSS combinations are created using EXB-MOSS programs together with preload program banks J and K. This is why you need to load preload program banks J and K.

**note** The preload combination data for the EXB-MOSS is stored in Bank E, and will be available only if the EXB-MOSS is installed.

- 5 If you want load the demo song data, access the Load Preload/Demo Data dialog box, set "Kind" to All Demo Songs, and press the OK button to load the data.

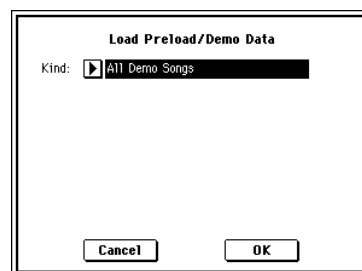

**note** Since this method will load the following data, the data of these banks will be overwritten.

Program: Bank J, K, F

Combination: Bank E (000–063)

Drum Kit: 000 (A/B)–015 (A/B)

Arpeggio Pattern: U000 (A/B)–U199 (A/B)

Demo Songs: S000–S003

**note** The EXB-MOSS data will be loaded into Program Bank F000–127 and Combination Bank E000–063.

# Other functions

## Setting the function of [SW1] and [SW2]

You can specify the function of the [SW1] and [SW2] keys (☞PG p.279).

The function of the [SW1] and [SW2] keys can be specified independently for each program, each combination, and each song. These functions can also be set independently for the entire mode in Sampling mode and Song Play mode.

You can specify the function that will be performed by the [SW1] and [SW2] keys, and can also select between **Toggle** (when the function will be switched on/off each time the [SW1] or [SW2] key is pressed) and **Momentary** (when the function will be on only while you continue holding the [SW1] or [SW2] key).

These settings are made by **Panel Switch Assign** in the following pages.

Program	P1: Edit-Basic, Controller Setup
Combination	P4: Edit-Zone/Ctrl, Control
Song	P4: Zone/Ctrl, Controller Setup
Sampling mode	P4: Controller Setup
Song Play mode	P2: Controller Setup

An example of settings in a program

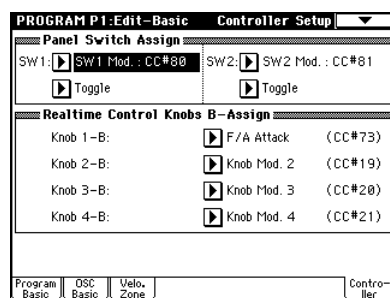

**note** When you write a program or combination, the on/off status of the [SW1] and [SW2] keys is memorized.

**note** You can use these keys as alternate modulation or effect dynamic modulation sources, and control program parameters or effect parameters. In this case, you will normally select SW1 Mod.:CC#80 and SW2 Mod.:CC#81.

For an example in which the [SW1] key is specified as an effect dynamic modulation source for a program and used to control an effect, refer to p.108.

**note** If you wish to keep these settings after the power is turned off, you must save them (☞p.114). However, the settings of Sampling mode cannot be saved.

## Setting the B-mode functions of REALTIME CONTROLS [1]–[4]

You can specify the B-mode functions of REALTIME CONTROLS knobs [1]–[4] (☞PG p.280).

The B-mode functions can be specified independently for each program, each combination, and each song. These functions can also be set independently for the entire mode in Sampling mode and Song Play mode.

These settings are made in **Realtime Control Knobs B-Assign** of the respective page. (☞“Specifying the function of [SW1] and [SW2]”)

**note** You can use these knobs as sources for alternate modulation or effect dynamic modulation, and control program parameters or effect parameters. In this case, you will normally select Knob Mod.1:CC#17, Knob Mod.2:CC#19, Knob Mod.3:CC#20, and Knob Mod.4:CC#21.

Here is an example of how knob [1] can be used to control the filter and amp EG attack of a program.

- ① Press the [PROG] key to enter Program mode.
- ② After pressing the [MENU] key, and press the P1: Edit-Basic.
- ③ Press the Controller tab.
- ④ Press the **Realtime Control Knob B-Assign** “Knob 1-B” popup button, and select F/A Attack.
- ⑤ Press the [REALTIME CONTROLS] key to select B-mode, and rotate knob [1]. The EG attack of the filter and amp will change.

**note** If you wish to keep these settings after the power is turned off, you must save them (☞p.114). However, the settings of Sampling mode cannot be saved.

## Adjusting the contrast (brightness) of the LCD screen

Use the rear panel contrast knob to make adjustments.

---

## Using tap tempo control

In Program, Combination, Sequencer, and Song Play modes, you can use the tap tempo function to control the arpeggiator tempo. In Sequencer and Song Play modes you can use this method to control the song tempo. During playback, lightly press the [ENTER] key several times at the desired tempo. The tempo will follow your tapping in realtime. This is a convenient way to match the tempo in realtime to the beat of a different source.

As an example, here's the procedure for using tap tempo to set the speed of the arpeggiator.

① **In Program mode or Combination mode, start the arpeggiator running.**  
Turn on the ARPEGGIATOR [ON/OFF] key, and play the keyboard. If you check "Latch" (P0: Play, Arpeggiator page), the arpeggiator will keep running even if you take your hand off the keyboard.

② **Lightly press the [ENTER] key several times at the desired tempo.**  
Notice that the "♩=" in the upper right of the LCD screen will change to indicate the tempo at which you press the [ENTER] key.

If you press the [ENTER] key at slightly shorter intervals, the playback tempo will become correspondingly faster.

🔍 You can use tap tempo control whenever the [TEMPO] knob can be operated. For example in Sequencer mode, tap tempo control will not be available if you are playing a song whose "Tempo Mode" setting (PG p.56) is set to Auto.

**note** You can also use a foot switch connected to the ASSIGNABLE FOOT SWITCH jack to control the tap tempo function. (p.90, PG p.281)

---

## Shortcuts

[MENU] key + numeric keys [0]–[9]  
• Accesses the pages within a mode

[ENTER] key + numeric keys [0]–[9]  
• Accesses the page menu commands in each page (up to ten items)

[ENTER] key + [REC/WRITE] key  
• Accesses the Song Setup function. In Program or Combination mode you can press this combination of keys to automatically assign the settings of the program or combination to a song in Sequencer mode, and then enter record-ready mode.

[ENTER] key + keyboard  
• Inputs note number values or velocity values  
• Selects "KEY" in Global P5: Drum Kit, Sequencer P6: Pattern/RPPR, RPPR Setup page  
• Selects base key and index in Sampling mode

[ENTER] key + [LOCATE] key  
• In Sequencer mode and Song Play mode, sets the current location as the "Location" (equivalent to the "Set Location" page menu command)

**From the powered-off state, turn on the power while holding down the [MENU] key and [EXIT] key**  
• Automatically executes "Load All (Preload PCG and Demo Songs)." (A message of "Now writing into internal memory" will appear in the LCD screen while the data is being loaded.)

**From the powered-off state, turn on the power while holding down the [MENU] key and [9] key (Warning! This operation will cause all user data saved to the internal memory to be lost)**

• Initializes the TRITON Extreme, and writes data into internal memory. (A message of "Now writing into internal memory" will appear in the LCD screen while the data is being loaded.)

After initialization, you will need to load the preload data. Execute the Global mode page menu command "Load Preload/Demo Data" to load the data. (p.127)

# Appendices

## Troubleshooting

If you experience problems, refer to the relevant item and take the appropriate measures.

### Power supply

Power does not turn on

- Is the power cable connected to an outlet? [p.16](#)
- Is the [POWER] switch turned on?
- Turn on the rear panel [POWER] switch. [p.18](#)

### LCD screen

The power is turned on, but nothing is shown in the LCD screen.

The TRITON Extreme functions normally when you play the keyboard or perform other operations.

- Use the rear panel [Contrast adjustment] knob to adjust the contrast of the LCD screen. [p.7](#)

The power is turned on, but the LCD screen does not display normally, or an error message is displayed. There is no sound when you play the keyboard, and the TRITON Extreme does not function normally.

- This type of problem may occur if a data writing operation to internal memory was not completed correctly, for example if the power of the TRITON Extreme was turned off while a program or other data was being written. If this occurs, use the following procedure to initialize the TRITON Extreme's internal memory.
  - ① Turn off the power.
  - ② Hold down the [MENU] key and the [9] key, and turn on the power.  
The TRITON Extreme will be initialized, and data will be written into internal memory. While the data is being written, the LCD screen will indicate "Now writing into internal memory."  
After initialization, all user data will be empty, and you will need to re-load the preload data. Execute the Global mode page menu command "Load Preload/Demo Data" to load the data. [p.127](#)

Can't operate the LCD screen correctly

- In Global P0: Basic Setup, execute the "Touch Panel Calibration" page menu command to adjust the sensitivity of the touch panel. [PG p.157](#)
- If it is not possible to select this command from the page menu, enter Global mode P0 (press the [MENU] key, and then press the [0] or [EXIT] key to access this), and then hold down the [ENTER] key and press numeric key [3] to display the dialog box.

Can't switch modes or pages

- Are you recording or playing a song?
- Are you sampling?
- Are you playing a CD?
- Are you playing a WAVE file?

In Combination, Sequencer, or Song Play modes, can't edit the value of Timbre/Track parameters such as "MIDI Channel" or "Status"

- Some parameters cannot be edited during a "note-on" condition; i.e., while a note is held down on the keyboard, or while the damper pedal is held down.
- Are you using a damper pedal with a polarity that does not match the "Damper Polarity" setting (Global P2: Controller)?
- In some cases, this problem can be solved by executing the page menu command "Half Damper Calibration" (Global P0: Basic Setup).

No beep is sounded when you touch the LCD screen

- Check the "Beep Enable" check box (Global P0: Basic Setup, System Preference). [p.90](#)

### Audio input and output

No sound

- Are connections made correctly to your amp, mixer, or headphones? [p.15](#)
- Is the connected amp or mixer powered-on, and is its volume raised?
- Is Local Control turned on?  
→ In Global P1: MIDI, check the "Local Control On" check box. [PG p.161](#)
- Is the [VOLUME] slider raised? [p.3](#)
- If there is no sound from the OUTPUT (INDIVIDUAL) 1-4 jacks, make sure that "BUS Select" or "BUS Select" following the insert effect is set to 1, 2, 3(Tube), 4(Tube), 1/2, or 3/4(Tube). [p.104](#)
- If specific tracks in Sequencer mode or Song Play mode do not sound, Make sure that the PLAY/MUTE/REC button or PLAY/MUTE button is set to PLAY. [p.42, 88](#)
- Make sure that the "Status" is INT or BTH. [p.32, 41](#)
- Are the *Key Zone* and *Velocity Zone* set so that sound will be produced when you play? [PG p.13, 47, 76](#)

Notes do not stop

- In Program P1: Edit Basic, select the Program Basic page, make sure that the "Hold" check box is unchecked. [PG p.10](#)
- In Global P2: Controller, make sure that "Damper Polarity" or "Foot Switch Polarity" is set correctly. [PG p.165](#)

Can't input sound

- Are the appropriate sources connected to the AUDIO INPUT 1, 2 jacks, the S/P DIF IN jack? [p.64](#)
- If there is no sound in Sampling mode, check that "Input," "Level," and "BUS (IFX/Indiv.) Select" are set correctly in the Sampling P0: Recording, Input/Setup page. [p.64](#)

- If there is no sound in Program, Combination, Sequencer, Song Play, and Media modes, check that “Input,” “Level,” and “BUS (IFX/Indiv.) Select” are set correctly in Global P0: Basic Setup, Input/Sampling page; or in the P0: Sampling pages of Program, Combination, or Sequencer modes; or in the Media mode Play Audio CD page. [PG p.64](#)
- If you are inputting sound to the AUDIO INPUT 1 and 2 jacks, make sure that the AUDIO INPUT [LEVEL] knob is raised. [PG p.65](#)
- If you are inputting sound to the AUDIO INPUT 1 and 2 jacks, is the [MIC/LINE] switch set appropriately? [PG p.64](#)
- If you are inputting the external source into the S/P DIF IN jack, is “System Clock” set to S/P DIF? [PG p.158](#)
- Is an unsupported format being input from the S/P DIF IN jack?
  - Please connect an instrument or digital audio device that is compatible with CP-1201 or S/P DIF.
- Is the correct sampling frequency being input from the S/P DIF IN jack?
  - Sampling frequencies of 48 kHz can be input. If you input an unsupported sampling frequency, noise will occur or a message of “S/P DIF Clock Error!” will be displayed.

 If “System Clock” is set to S/P DIF, and you want to switch the sampling frequency being input to the S/P DIF IN jack from 96 kHz to 48 kHz or from 48 kHz to 96 kHz, you must first make sure that the TRITON Extreme is not accessing data. You must also avoid touching the TRITON Extreme. Be especially careful not to switch the sampling frequency being input to the S/P DIF IN jack while the TRITON Extreme is accessing data (i.e., while sampling, or while loading/saving media, sample memory, or internal memory). You must also avoid switching the S/P DIF IN jack input during such times.

- Digital audio input is sometimes not heard for two or three seconds.

#### Can't hear an audio CD in a USB CD-R/RW drive connected to AUDIO INPUT

- Make sure that you have selected the Media mode Play Audio CD page or Sampling mode.
- Make sure that the audio outputs of your USB CD-R/RW drive are connected to the AUDIO INPUT jacks. If your drive does not have output jacks, you won't be able to monitor the sound. [PG p.64](#)
- Is the CD output being correctly input?
  - If you want to listen to the audio CD playback in the Media mode Play Audio CD page, set “Input (COMBI, PROG, SEQ, S.PLAY, MEDIA)” to Analog, and make the appropriate settings for “Level” and “BUS (IFX/Indiv.) Select.” If you want to listen to the audio CD playback in Sampling mode, make these settings in “Input (SAMPLING).” [PG p.64](#)
- Is the “Volume” slider raised? (Media mode Play Audio CD page, Sampling P5: Audio CD, Ripping page) [PG p.139, 197](#)

- Has the CD been finalized?
  - A CD-R/RW disc that you wrote using the Media mode Make Audio CD page cannot be played in the Media mode Play Audio CD page or in Sampling mode unless you have finalized the disc. Execute the page menu command “Finalize Audio CD” to finalize the disc. [PG p.197](#)

#### Excessive noise or distortion in the audio input or in the sampled sound

- If you are inputting to the AUDIO INPUT 1 and 2 jacks, are the AUDIO INPUT [LEVEL] knob and “Recording Level” setting appropriate?
  - If “Recording Level” indicates “ADC OVERLOAD !,” adjust the [LEVEL] knob. If “CLIP!!” is displayed, adjust the “Recording Level” slider. Adjusting the “Recording Level” will not affect the level of the output sound, but will affect the level that is sampled. While watching the level meter, adjust “Recording Level” as high as possible without allowing “CLIP!!” to appear. [PG p.65](#)
- If you are inputting to the S/P DIF IN jack, are the level of the output device and the “Recording Level” set appropriately?
  - If “CLIP!!” appears, adjust the “Recording Level” slider.
- Is the system clock set correctly?
  - If cyclic click noise is occurring, check that you have selected the “System Clock” that is being input. [PG p.158](#)

#### Noise or oscillation is heard

- When using an effect on the external audio source being input from AUDIO INPUT 1 and 2, oscillation may occur depending on the type of effect or on the parameter settings. Please adjust the input level, output level, and effect parameters. You need to be particularly careful when using a high-gain effect.
- After a sample edit has been executed, or after a stereo sample has been recorded, a small noise may be heard. This has no effect on the audio data that was edited or sampled.
- When using the BPM/MIDI Sync function to control the delay time of an effect, noise may occur in the delay sound. This noise is due to discontinuities in the delay sound, and is not a malfunction.
- Some effects such as 015: St.Analog Record generate noise intentionally. It is also possible to create oscillation using a 24 dB/oct LPF filter with resonance. These are not malfunctions.
- If you use Valve Force with “Placement” set to Insert, make sure that the Valve Force output destination (“BUS Sel.”) is not set to a bus or insert effect located at an earlier stage, since this would cause a feedback loop. ([PG p.35, 54, 99, 141](#))
- Depending on the sound you are using, you may hear noise if you turn the Valve Force knobs or edit Valve Force parameters while sound is being produced. This is because the level changes in steps; it is not a malfunction.



---

## Program, Combination

### Settings for oscillator 2 are not displayed

- Make sure that the “Oscillator Mode” (Program P1: Program Basic) parameter is set to Double. [PG p.9](#)

### A combination does not play correctly after you load data

- In the dialog box when you saved the data, did you check the items that you wanted to save? [PG p.187](#)
- Are the bank/numbers of the programs used by the combination the same as when the combination was created?

---

## Song

### A song does not play correctly after you load data

- In the dialog box when you saved the data, did you check the items that you wanted to save? [PG p.187](#)
- Are the programs used by the song the same as when the song was created?
  - When saving the song, it is best to use “Save All” or “Save PCG & SEQ” so that the programs are saved together with the song. Then when loading, load both the .PCG and the .SEQ data. [PG p.177, 187](#)
- Have you loaded the multisamples and samples used by the program?
- Does the demo song “S001: WinterVariations” not play correctly?
  - This song uses the preloaded User Octave Scale 15. In Global P0: Basic Setup, execute the “Load Preload/Demo data” page menu command to select the “Global Setting.” [QS p.2, PG p.157](#)

### Playback does not start when you press the SEQUENCER [START/STOP] key in Sequencer mode

- Is the “MIDI Clock” (Global P1: MIDI) set to Internal? [PG p.162](#)

### Can't record in Sequencer mode

- Is the Memory Protect “Song” check box (Global P0) unchecked? [PG p.159](#)
- Is the “MIDI Clock” (Global P1: MIDI) set to Internal? [PG p.162](#)

### The arpeggiator settings that were copied from a combination using “Copy From Combi” cannot be recorded in the same way as when they were played

- Have you checked “Multi REC”? (Sequencer P0: Play/REC, Preference) [PG p.67](#)
- Depending on the settings of the combination, it may be necessary to adjust settings such as “Track Select,” “MIDI Channel,” “Status,” and “Arpeggiator Assign.” [PG p.59](#)
  - In the Copy from Combi dialog box, check the “Auto adjust Arp setting for Multi REC” option before you execute the copy. This will cause the settings to be adjusted automatically. [p.58](#)
  - The settings that are made automatically by “Auto adjust Arp setting for Multi REC” will be executed according to the ARPEGGIATOR [ON/OFF] key setting of the combination. If you want to turn on the arpeggiator in Sequencer mode and record the performance of a combination, make sure that the ARPEGGIATOR [ON/OFF] key is turned on for the combination when you write it in Combination mode.

Then execute the “Copy From Combi.” [p.58](#)

### RPPR does not start

- Is the Sequencer P0: Play/REC “RPPR” setting checked? [p.56](#)
- Are “Assign,” “Pattern Select,” and “Track” set correctly? [p.55, PG p.91](#)
- If the “MIDI Clock” (Global P1: MIDI) parameter set to Internal? [PG p.162](#)

### Can't record exclusive data

- Is “Enable Exclusive” (Global P1: MIDI) checked? [p.46](#)

### In Song Play mode, a GM/GS/XG-compatible SMF is not played correctly

- Execute “GM Initialize” to initialize the settings. [PG p.144](#)
- Is “Bank Map” set to GM(2)? [PG p.158](#)
- Is “Status” set to INT? [PG p.146](#)

---

## Sampling

### Can't sample

- Is sample memory (RAM) installed? [p.18](#)
  - If you are sampling to media, have you selected media to which sampling is possible? [p.137, PG p.7, 112](#)
  - Are the audio input settings correct?
    - Refer to “Audio input and output – Can't input sound” [p.131](#)
  - Is there free space in memory? [PG p.117, 203](#)
    - If you are sampling to sample memory (RAM), select a different memory bank. [PG p.6, 41, 64, 106](#)
    - If you are sampling to hard disk, select a different hard disk. [PG p.7, 41, 64, 112](#)
    - Delete unneeded samples. [PG p.108](#)
    - Save samples you want to keep, and then delete them. [PG p.108, 188](#)
  - Is the “Trigger” setting correct? [PG p.5, 41, 63, 115](#)
  - In Sampling mode if you are resampling with “Resample” set to Auto, has the sample to be resampled been assigned to the keyboard, and selected for “Key”? [p.70, PG p.113](#)
  - Is the “Source BUS” setting correct?
    - If you want to listen to the performance of the internal tone generator while sampling only the external input sound (i.e., when using the In-Track Sampling function), you will normally set this to Indiv.1/2. For other types of sampling or resampling, set this to L/R. [p.65, PG p.4, 41, 63, 115](#)
  - If a message of “Buffer underrun error occurred” is displayed frequently when you are sampling to hard disk, execute the page menu command “Check Medium” (Media, Utility page) to find and correct any errors on the selected MS-DOS format media. [PG p.193](#)
- ### A stereo sample can't be played in stereo
- Is the multisample stereo?
    - Execute the page menu command “MS Mono To Stereo” to convert the multisample to stereo. [PG p.110](#)
  - Is the sample name assigned correctly? [PG p.106](#)

---

### Volume of a recorded sample is too low/too high

- A sample that you resampled with “Recording Level” set at approximately -12.0 (dB) plays back at a lower volume than the volume at which you resampled it.
  - Did you turn on the “Auto +12 dB On” setting when you resampled? ☞p.67
  - If you resampled with “Auto +12 dB On” turned off, turn on “+12 dB” (Sampling mode Loop Edit page) for that sample.
- The playback volume of a sample is different than the volume at which it was resampled or sampled.
  - If the sample playback is louder, did you set “Recording Level” above +0.0? If it is lower, did you set “Recording Level” below +0.0?  
The “Recording Level” setting affects the level of the sample data that is recorded, but it is not possible to monitor that level.
  - If the sample playback is louder, is “Auto +12 dB On” turned on? If the playback is softer, is this setting turned off?
  - If you resampled the playback of a song or your playback performance using a program, combination, or sample, or combined your performance with an external audio source and sampled the result, did you set “Recording Level” to approximately -12.0 dB and turn on the “Auto +12 dB On” setting? ☞p.67
  - If you sampled only an external audio source, did you set “Recording Level” to approximately +0.0, and turn off “Auto +12 dB On”? ☞p.67

### Song or CD playback stops temporarily when you sample

- Is “Auto Optimize RAM” checked?
  - If this is checked, RAM will be optimized automatically when sampling ends, meaning that the sound will stop when sampling ends. If a song is being played in Sequencer mode or if a CD is being played back, the playback will stop.

### There is a time lag after you press the SAMPLING [REC] key until you enter sampling-standby mode

- The length of time until you enter sampling-standby mode will depend on the state of the free space on the media (i.e., whether the free space is continuous or fragmented).  
When sampling to the media, pressing the SAMPLING [REC] key will cause the amount of space specified by “Sample Time” to be allocated within the media.
  - You should set “Sample Time” slightly longer than the length that you will actually sample, and avoid specifying an excessively long sample time.

---

## Drum kits

### The pitch of a drum sample does not change

- You have left the “Assign” check box unchecked, and want to play the drum sample at the adjacent right a semitone lower, but the pitch does not change.
  - If you have selected a drum program in Program mode, and then want to edit the drum kit in Global mode, go to the Program P2: Edit-Pitch, OSC1 Pitch Mod. page and set “Pitch Slope” to +1.0 before you enter Global mode.

---

## Arpeggiator

### Arpeggiator does not start

- Is the ARPEGGIATOR [ON/OFF] key turned on (lit)?
- If the arpeggiator does not start for a combination or song, make sure that “Arpeggiator Run” is checked, and that an arpeggiator is selected for “Assign.” ☞p.96, PG p.49, 93, 149
- Is the “MIDI Clock” (Global P1: MIDI) parameter set to Internal? ☞PG p.162
- If the ARPEGGIATOR [ON/OFF] key does not respond in Global P6: User Arpeggio, you may have moved here from Sampling mode or Media mode.

---

## Effects

### Effects are not applied

- Have you selected effect program 000?
    - Select an effect other than 000: No Effect for “IFX1-5” or “MFX 1, 2.”
  - Are the “IFX 1-5 Off,” “MFX1 Off,” or “MFX2 Off” (Global P0: Basic page) settings checked? ☞p.89
  - If you are in Combination, Sequencer, and Song Play, and master effects are not applied when you raise the “Send1” or “Send2” of the timbre/track, does “Return 1” or “Return 2” from the master effect need to be raised? ☞p.105  
Alternatively, has “Send 1” or “Send 2” for each oscillator of the program used by the timbre/track been lowered? ☞p.105
- note** The actual send level is determined by multiplying the send setting of each oscillator in the program with the send setting of the timbre/track.
- Have you routed the output to an insert effect? ☞p.104, 105

---

## MIDI

The TRITON Extreme does not respond to incoming MIDI data

- Are all MIDI cables connected correctly? [PG p.288](#)
- Is the MIDI data being received on the channel on which it is being transmitted? [PG p.289](#)

The TRITON Extreme does not respond correctly to incoming MIDI data

- Are the Global P1: MIDI settings “Enable Program Change,” “Enable Bank Change,” “Enable Control Change,” and “Enable AfterTouch” each checked? [PG p.162](#)
- If you wish to receive MIDI exclusive messages, is the “Enable Exclusive” (Global P1: MIDI) item checked? [PG p.162](#)
- Does the TRITON Extreme support the types of messages that are being sent to it? [PG p.289](#)

---

## Media

### CompactFlash or Microdrive in the CF card slot

Can't format the CompactFlash or Microdrive

- Does the media meet the requirements for use on the TRITON Extreme? [p.137](#)
- Is the media inserted correctly?

Can't save/load data on the CompactFlash or Microdrive

- Is the media inserted correctly?
- Has the media been formatted?

### External USB device

An external USB-connected drive is not recognized

- Has the drive been formatted? [p.119](#)
- Is the external device connected correctly? [PG p.325](#)
- Did you power-on the USB device before powering-on the TRITON Extreme?
- Use the page menu command “Scan USB device” (Media, Media Information) to re-mount the USB device.

When saving data to an external hard disk, the “Error in writing to medium” message appears frequently

- Execute the page menu command “Check Medium” (Media, Utility page) to detect and correct errors on the selected MS-DOS format media. [PG p.192](#)

## CD-R/RW

Can't write

- Was the drive subjected to physical shock or vibration while data is being written?  
If you are unable to save data such as PCG or SNG files, has the disc been formatted?  
If you are writing audio tracks to create an audio CD, it is not necessary to format the disc.
- Are you using a drive that supports JustLink? With other drives, only single-speed writing is possible. Writing is not possible if your drive won't let you select single-speed writing. Depending on the performance of your drive, there may be cases in which even single-speed writing is not possible. In addition, if you're using a USB hub and writing from a USB hard disk to a USB CD-RW drive, writing may not be possible with a drive that doesn't support JustLink.
- Are you using the recommended media for your drive?
- If you are writing from an USB drive to CD-R/RW, it is possible that the transfer speed is insufficient.  
→ Writing may be successful if you lower the writing speed. [PG p.196](#)  
→ In some cases, you may be able to succeed by first copying the data from the USB drive to the CF card slot media, and then executing the Write operation from the CF card slot media.
- In some cases, a certain length of time may be required before the data begins to be saved. When first saving data on high-capacity media (e.g., the first time after powering-on the TRITON Extreme that you save in Media mode or execute sampling to media in Sampling mode), some time will be required to allocate free area.
- Are you using blank media?  
→ If using CD-R, please use new media. If using CD-RW, use the page menu command “Erase CD-RW” (Media, Make Audio CD) to erase the contents of the media before you execute Save.

A CD-R/RW saved on the TRITON Extreme is not recognized by an external device.

- A CD-R/RW saved or copied on the TRITON Extreme using packet writing is not recognized on a computer.  
→ If you install a UDF version 1.5 compatible UDF reader or packet writing software on your computer, it will be possible to recognize the disc. [PG p.330](#)  
→ In the case of a CD-R, it may be possible to make the disc be recognized by executing the page menu command “Convert to ISO9660 Format” (Media, Utility page) to convert the disc to ISO9660 format. However depending on the state in which the disc was saved, it may be converted into ISO9660 level 3 format, and may still not be recognized. In this case if you install ISO9660 level 3 compatible reader software or packet writing software on your computer, it will be possible to recognize the disc. [PG p.330](#)
- A CD-R/RW that was saved or copied on the TRITON Extreme using packet writing is not recognized by the TRITON/TRITON pro/TRITON proX/TRITON-Rack.  
→ These models do not support UDF version 1.5, and therefore will not recognize such a disc.

---

→ In the case of a CD-R, it may be possible to make the disc be recognized by executing the page menu command “Convert to ISO9660 Format” (Media, Utility page) to convert the disc to ISO9660 format. However depending on the state in which the disc was saved, it may be converted into ISO9660 level 3 format, and may still not be recognized. [PG p.330](#)

#### Can't write audio tracks

Additional writing is not possible on a CD-R/RW disc that has been finalized.

#### Can't play back the disc on an audio CD player

Did you finalize the disc?

→ If you want to finalize the disc after writing additional data, check the “Execute finalize too” check box when executing the page menu command “Write to CD” (Media, Make Audio CD), so that the disc will be finalized. [p.124, PG p.196](#)

→ If you only want to finalize the disc, select the page menu command “Finalize Audio CD” (Media, Make Audio CD), and press the OK button to finalize the disc. [PG p.196](#)

Are you using CD-R media?

→ Since some CD players are unable to play CD-RW media, we recommend that you use CD-R media.

Have you tried using a different type of media?

→ Some CD-R/RW media cannot be played by some CD players. You may be able to play back successfully by using a different type (brand) of CD-R/RW media.

---

## WAVE files

### Playback level of the WAVE file is too high

Set “WAVE File Play Level” to Normal. You should usually set “WAVE file Play Level” at Normal, and set it to High (+12 dB) only if the S/P DIF output is too low. With the High (+12 dB) setting, the output from AUDIO OUTPUT L (MONO), R, and HEADPHONES will be louder. [PG p.158](#)

### WAVE file playback level is louder/softer than the RAM samples

Adjust the “WAVE File Play Level.” You should usually set “WAVE File Play Level” to Normal, and use the “High (+12 dB)” setting only if the WAVE file playback volume is lower than the playback of the RAM samples. You should also use the “High (+12 dB)” setting if the S/P DIF output is not loud enough.

### Can't preview

Is the WAVE file format supported?

→ Select a WAVE file of a supported format. [PG p.176, 195, 315](#)

---

## Other

Saved files or sampled WAVE files have an incorrect date/time.

→ Use the page menu command “Set Date/Time” (Media, Utility page) to set the current date and time. [p.120](#)

---

## Included CD-ROM

### Can't install the driver

Is the USB cable connected correctly?

Is the CD-ROM inserted in your CD drive?

→ Make sure that the CD-ROM is inserted correctly.

Could the lens of your CD drive be dirty?

→ Use a commercially-available lens cleaner to clean the lens.

Are you attempting to install from a network CD drive?

→ This software cannot be installed from a network-connected CD drive.

Are you able to use USB?

→ If you are using Windows XP, go to [Control Panel] → [System], and select the [Hardware] tab. In [Device Manager], check the settings for Universal Serial Bus Controller and USB Root Hub.

Has the TRITON Extreme been detected as an unknown device?

→ If you are using Windows XP, go to [Control Panel] → [System], select the [Hardware] tab, and check [Device Manager]. If the TRITON Extreme has not been detected correctly, it will be displayed in “Other devices” or “Unknown devices.” Reconnect the USB cable; if the TRITON Extreme is again displayed as an “Unknown device,” the computer has failed to detect it correctly. Delete the “Unknown device” entry, and reinstall the driver. [PG p.326](#)

### Your software does not respond to the TRITON Extreme

Is the USB cable connected correctly?

Did you install the driver?

Has your computer detected the connected TRITON Extreme?

→ If you are using Windows XP, go to Control Panel → “Sounds and Audio Devices Properties” and click the Hardware tab.

If you are using Mac OS X, go to Macintosh HD → Application folder → Utility folder → “Audio MIDI Settings,” select the “MIDI Devices” tab, and check that the TRITON Extreme has been detected.

 Some computers may not recognize the microCONTROL because of their hardware configuration.

Check the TRITON Extreme's assignments and USB-MIDI port settings.

The connected device or software may not support the messages you are transmitting. Refer to the owner's manual of the connected device or software to verify that it responds to the messages you are transmitting.

## Media that can be used with the TRITON Extreme

### Types of media that can used with the TRITON Extreme (as of July 2003)

#### Media inserted in the TRITON Extreme's CF card slot

- CF: CompactFlash (Type I, Type II)  
Power supply voltage 5V only is supported; 16 Mbyte-1 Gbyte
- MD: Microdrive  
Power supply voltage 5V only is supported; 1 Gbyte

#### External USB storage media

- HD: hard disk
- RM: removable disk (Magneto-Optical)  
MS-DOS format FAT16 and FAT32 are supported for HD and RM.  
Capacity recognized: FAT32: up to 2 Tbytes = 2,000 Gbytes  
FAT16: up to 4 Gbytes
- CDR (CD-R/RW)  
UDF format is supported. UDF format CD-R/RW can be written and read. (Packet writing support <sup>PG</sup> p.330)  
CD-DA (audio data) can be recorded/played, and ISO9660 (level 1) format can be loaded.

**note** Requirements for external USB storage media that can be recognized by the TRITON Extreme are described on PG p.325.

**note** For details on connecting the USB A/B connectors, refer to PG p.325.

### Operations that the TRITON Extreme can perform on media

- **Save/Load (Media mode)**  
Internal memory and sample memory (RAM) data can be saved/loaded. For details on the files that can be saved or loaded, refer to the table on PG p.175. Loading or saving a divided file is supported for media connected to the USB A connector.
- **Sampling/resampling (Program, Combination, Sequencer, Sampling modes)**  
If "Save to" = MEDIA, sampled/resampled Wave files will be written to media.
- **Wave file playback (Sequencer, Media modes)**  
Wave files can be played.
- **Wave file editing (Media mode)**  
Wave files can be edited.
- **SMF direct playback (Song Play mode)**  
SMF can be played back directly from media.
- **Audio CD creation (Media mode)**  
A CD-R/RW drive can be used to create an audio CD from Wave files. Writing may not be possible depending on the media on which the Wave files are saved.
- **Data transfer to/from a computer (Media mode)**  
Data from CompactFlash media inserted in the TRITON Extreme's CF card slot can be saved to the computer, or data from the computer can be loaded to the CompactFlash media.
- **Convert to ISO9660 Format (Media mode)**  
UDF format CD-R media can be converted to ISO9660 format.

**note** If you have any questions regarding the media that can be used, please contact your local Korg distributor. You may also check the Korg website (<http://www.korg.com/downloads>).

Function \ Media	Built-in: MD (Micro drive)	Built-in: CF (Flash Memory)	USB A: HD (Hard Disk)	USB A: RM (Removable Media)	USB A: CD-R/RW (Packet Write)	USB A: CD-R/RW (ISO9660)
Save/Load	●	●	●	●	●	▲ *2
Sampling/Resampling	●	▲ *1	×	×	×	-
WAVE File Play	●	●	×	×	×	×
Edit Wave	●	●	●	×	×	×
SMF direct play	●	●	●	●	●	●
Make Audio CD	● (from)	● (from)	● (from)	● (from)	● (to)	● (from)
USB Storage	●	●	×	×	×	×
Convert to ISO9660 Format	-	-	-	-	● (to)	-

● : possible

× : not possible

- : not applicable

▲ : partial support

\*1: Writing may not be possible for some media

\*2: Only loading is possible

USB A: CD-DA (audio CD) can be ripped in Sampling mode.

# Specifications and options

## Specifications

<b>System</b>	HI (Hyper Integrated) synthesis system	
<b>Tone generator</b>	Polyphony	60 voices (60 oscillators)/Maximum 120 voices (120 oscillators)* in single mode *: ¶p.12
		30 voices (60 oscillators)/Maximum 60 voices (120 oscillators)* in double mode *: ¶p.12
	Filters	24 dB/oct LPF with resonance 12 dB/oct LPF + HPF
	Alternate modulation function	
<b>Keyboard</b>	88 keys (RH2)*, 76 keys, 61 keys * The 88 keys model features an RH2 (Real Weighted Hammer Action 2) keyboard, which provides a differing key weight in each of four keyboard ranges, just as on a grand piano.	
<b>Waveform memory</b>	160 Mbytes PCM ROM (962 multisamples, 1,175 drumsamples)	
	16 Mbytes user sampling RAM (SIMM) (expandable to a maximum of 96 Mbytes)	
<b>Combinations/ Programs</b>	1,536 user memory combinations (1,280 preload)	
	1,536 user memory programs (128 more when EXB-MOSS is installed) (1,344 preload)	
	256 + 9 drum ROM programs (GM2 sound map compatible)	
<b>Sampling</b>	48 kHz, 16 bit linear	
	RAM: Maximum sample data memory capacity 96 Mbytes (when SIMM modules are installed). Maximum size of one sample file is 16 Mbytes, allowing approximately 2 minutes 54 seconds of mono, or 1 minute 27 seconds of stereo sampling. If memory is expanded to 96 Mbytes, a maximum of six such sample files can be created.	
	MEDIA: One sample file (either mono or stereo) can be a maximum of approximately 80 minutes; occupying approximately 440 Mbytes for mono, or approximately 879 Mbytes for stereo.	
	* Sampling to MEDIA requires separately sold media (¶p.137).	
	4,000 samples, 1,000 multisamples (128 indexes for each multisample)	
	Record/playback/rip CD-DA (audio CD)	
	Able to load AIFF, WAVE, AKAI (S1000/3000), Korg format sample data can be loaded Sample data can be exported in AIFF or WAVE formats	
<b>Drum Kits</b>	144 user drum kits (50 preload)	
	9 ROM GM drum kits (GM2 sound map compatible)	
<b>Effect section</b>	5 insert effects (stereo in/out),	
	2 master effects (mono in/stereo out), 1 master EQ (3-band stereo), all usable simultaneously	
	102 effect types (available for insert effects or master effects)	
	Effect dynamic modulation function	
<b>Valve Force</b>	Valve Force circuit (Ultra Boost circuit + 12AU7 vacuum tube): Input Trim, Ultra Boost, Tube Gain, Output Level (analog) Placement: usable either as Final or Insert	
<b>Dual polyphonic arpeggiator</b>	Use two arpeggiators simultaneously (Combination, Sequencer, Song Play modes)	
	5 preset arpeggio patterns	
	507 user arpeggio patterns (489 preload)	
<b>Sequencer</b>	16 timbres, 16 tracks + 1 master track	
	Maximum capacity: 200,000 notes	
	Resolution ♩/192	
	200 songs, 20 cue lists, 150 preset patterns, 100 user patterns (for each song)	
	In-Track Sampling function (see Sampling "RAM")	
	16 preset/16 user template songs	
	Supports TRITON format and SMF (formats 0 and 1)	
	RPPR (Realtime Pattern Play/Recording) function (One set is available for each one song) Auto Song Setup function	
<b>Song play</b>	16 timbres, 16 tracks	
	SMF (formats 0 and 1) supported	
<b>Media</b>	Load, save, utility Audio CD writing/playback, Wave file editing	
	USB storage function (allows a computer to manipulate data on media inserted in the CF card slot), Data filer function (save/load MIDI exclusive data)	
	CD-ROM/R/RW (read and write UDF format CD-R/RW, record and play CD-DA, load ISO9660 level 1 data) supported	
<b>Modes</b>	Combination, Program, Sequencer, Sampling, Song Play, Global, Media	
<b>Controllers</b>	Joystick, ribbon controller, [SW1]/[SW2] keys, REALTIME CONTROLS knobs [1]–[4] and A/B/VALVE FORCE mode key, [VALVE FORCE ON/OFF] key, [VALUE] slider, ARPEGGIATOR [TEMPO], [GATE], [VELOCITY] knobs and [ON/OFF] key	

<b>User interface</b>	TouchView graphical user interface (320 × 240 pixel LCD display)	
	[VOLUME] slider	
	Mode keys	[COMBI], [PROG], [SEQ], [SAMPLING], [S.PLAY], [GLOBAL], [MEDIA]
	Value controllers	[VALUE] slider, [VALUE] dial, [△] [▽] keys, numeric keys ([0]...[9], [-], [./10's HOLD], [ENTER])
	[MENU] key, [EXIT] key, [COMPARE] key	
	BANK keys	[A], [B], [C], [D], [E], [F], [G], [H], [I], [J], [K], [L], [M], [N]
	SEQUENCER keys	[PAUSE], [REW], [FF], [LOCATE], [REC/WRITE], [START/STOP]
<b>Audio outputs</b>	AUDIO OUTPUT (MAIN) L/MONO, R AUDIO OUTPUT (INDIVIDUAL) 1, 2, 3, 4	Output impedance 1.1 [kΩ] (L/MONO is 550 [Ω] for mono) Maximum output level +13.5 [dBu] or greater Load impedance 100 [kΩ] or greater
	AUDIO OUTPUT HEADPHONE	Output impedance 33 [Ω] Maximum output level 22 [mW] Load impedance 33 [Ω]
	S/P DIF	Connector: optical, Format: 24-bit S/P DIF (IEC60958, EIAJ CP-1201), Sample rate: 48 kHz
<b>Audio inputs</b>	AUDIO INPUT 1, 2 LEVEL [MIC/LINE] switch, [LEVEL] knob	Input impedance 10 [kΩ] Nominal level LINE: +4 [dBu] @ [LEVEL] knob= min. -30 [dBu] @ [LEVEL] knob= max. MIC: -17 [dBu] @ [LEVEL] knob= min. -52 [dBu] @ [LEVEL] knob= max. Maximum level LINE: +14 [dBu] @ [LEVEL] knob= min. MIC: -20 [dBu] @ [LEVEL] knob= max. -7 [dBu] @ [LEVEL] knob= min. -43 [dBu] @ [LEVEL] knob= max. Source impedance 600 [Ω]
	S/P DIF	Connector: optical, Format: 24-bit S/P DIF (IEC60958, EIAJ CP-1201), Sample rate: 48 kHz
<b>Control inputs</b>	DAMPER (half-damper supported), ASSIGNABLE SWITCH/PEDAL	
<b>USB</b>	USB A (to Device), USB B (to Host) connector: Supports USB specification version 1.1 Support for Full speed (12 Mbps) and Low speed (1.5 Mbps) USB Mass Storage Class specification compliance: Interface Class 8 (Mass Storage), Interface Subclass 2(SFF8020i), 5(SFF8070i), 6 (SCSI), Bulk transfer support: Interface Protocol [0x50h] (Bulk Only)	
<b>Other</b>	MIDI IN, OUT, THRU, LCD contrast knob, CF card slot, AC power inlet, power switch, Calendar backup battery	
<b>Support for options</b>	EXB-MOSS 72 pin SIMM memory slots × 3 (for user sample memory)	
<b>Dimensions (W × D × H)</b>	88Keys: 1452 × 420 × 144 (mm) Inches: 57.17" × 16.54" × 5.67", 76Keys: 1316 × 360 × 117 (mm) Inches: 51.81" × 14.17" × 4.61", 61Keys: 1109 × 360 × 117 (mm) Inches: 43.66" × 14.17" × 4.61"	
<b>Weight</b>	88 Keys: 28.5 kg/62.83lbs., 76 Keys: 16.9 kg/37.26lbs., 61 Keys: 14.4 kg/31.75lbs.	
<b>Power supply</b>	AC Local Voltage	
<b>Power consumption</b>	38 W	
<b>Included items</b>	Power cable, CD-ROM (TNECD-D00)	

## Options

Expansion boards	EXB-MOSS (DSP Synthesizer Board)
Expression/volume pedal	XVP-10
Foot controller	EXP-2
Damper pedal	DS-1H
Pedal switch	PS-1
Other	MIDI cable

\* Appearance and specifications of this product are subject to change without notice. (January/04)

## System requirements for computer connection

### Windows

#### Supported OS

When using USB Storage: Microsoft Windows 98/Me/2000 SP3 or later/XP

\* For Windows 98/Me, a USB driver for Windows 98 is required.

When using USB MIDI: Microsoft Windows XP

#### Supported computers

A computer with USB port that meets the requirements of the above operating systems

### Macintosh

#### Supported OS

When using USB storage: Mac OS 9.0.4 or later, Mac OS X 10.0 or later

When using USB MIDI: Mac OS X 10.2 or later

#### Supported computers

Apple Macintosh with USB port that meets the requirements of the above operating systems

TRITON Extreme MIDI Implementation Chart

Function		Transmitted	Recognized	Remarks
Basic Channel	Default	1 – 16	1 – 16	Memorized
	Changed	1 – 16	1 – 16	
Mode	Memorized Messages Altered	× *****	3 ×	
Note Number:	True Voice	0 – 127 *****	0 – 127 0 – 127	Sequencer and Arpeggiator data can transmit all note numbers 0–127
Velocity	Note On Note Off	○ 9n, V=1 – 127 ×	○ 9n, V=1 – 127 ×	
Aftertouch	Polyphonic (Key)	○	○	Polyphonic aftertouch transmitted only as sequence data *A
	Monophonic (Channel)	○	○	
Pitch Bend		○	○	*C
Control Change	0, 32	○	○	Bank Select (MSB, LSB) *P
	1, 2, 16, 18	○	○	Joystick (+Y, -Y), Ribbon, Slider *C
	4, 5, 7, 8, 10	○	○	Pedal, Portamento Time, Volume, IFX pan, Pan *C
	11, 12, 13	○	○	Expression, Effect Control 1/2 *C
	64, 65, 66, 67	○	○	Damper, Portamento Sw., Sostenuto, Soft *C
	70 – 79	○	○	Sound (Realtime Controls 1–4A: 74, 71, 79, 72) *C
	80, 81, 82, 83	○	○	Switch 1, 2, Foot Switch, Controller *C
	93, 91, 92, 94, 95	○	○	Send 1, 2, Effect ON/OFF (IFXs, MFX1, MFX2) *C
	6, 38	○	○	Data Entry (MSB, LSB) *C
	96, 97	×	○	Data Increment, Decrement *C
	98, 99	○	○	NRPN (LSB, MSB) *C, *2
	100, 101	×	○	RPN (LSB, MSB) *C, *3
	0 – 95	○	○	Realtime Controls knobs 1–4 B-assign *C
	0 – 101	○	○	Sequencer data (receive) *C
120, 121	×	○	All Sound Off, Reset All Controllers *C	
Program Change	Variable Range	○ 0 – 127 *****	○ 0 – 127 0 – 127	*P
System Exclusive		○	○	*E*4
System Common	Song Position	○	○	When cue list is selected, corresponds to cue list *1
	Song Select Tune	○ 0 – 127 ×	○ 0 – 127 ×	When cue list is selected, corresponds to cue lists 0–19 *1
System Real Time	Clock	○	○	*1
	Command	○	○	*1
Aux Messages	Local On/Off	×	○	
	All Notes Off	×	○ 123 – 127	
	Active Sense	○	○	
	Reset	×	×	

Notes \*P, \*A, \*C, \*E: Transmitted/received when Global P1: MIDI Filter (Program Change, After Touch, Control Change, Exclusive) is Enable, respectively.  
 \*1: When Global mode P1: MIDI Clock is Internal, transmitted but not received. The opposite for External MIDI or USB.  
 \*2: LSB, MSB = 02, 00: Arp. (Arpeggiator) ON/OFF, 0A,00: Arp. Gate, 0B, 00: Arp. Velocity, 10, 00: V.F. (Valve Force) ON/OFF, 11, 00: V.F. Input Trim, 12, 00: V.F. Ultra Boost, 13, 00: V.F. Tube Gain, 14, 00: V.F. Output Level  
 \*3: LSB,MSB=00,00: Pitch bend range, 01,00: Fine tune, 02,00: Coarse tune  
 \*4: In addition to Korg exclusive messages, Inquiry, GM System On, Master Volume, Master Balance, Master Fine Tune, and Master Coarse Tune are supported.

Mode 1: OMNI ON, POLY      Mode 2: OMNI ON, MONO      ○ : Yes  
 Mode 3: OMNI OFF, POLY      Mode 4: OMNI OFF, MONO      × : No



# Index

## Numerics

10's Hold **4, 13, 21, 32**  
24 dB/oct low pass filter with resonance **27**

## A

After Touch **22**  
Alternate Modulation **30**  
Amp  
  Amp EG **29**  
  Amp Level **28**  
  Amp Mod. **29**  
  Keyboard Track **29**  
  LFO **29**  
Amp EG **29**  
Amplifier **23, 28**  
AMS (Alternate Modulation Source) **26, 28, 30**  
Arpeggiator **2, 5, 23, 30, 33, 37, 50, 56, 80, 88, 90, 94, 96, 130, 134**  
ASSIGNABLE PEDAL **7, 16, 23, 90**  
ASSIGNABLE SWITCH **7, 16, 23, 44, 54, 90**  
Audio CD **5, 71, 72, 74, 123, 136**  
AUDIO INPUT **6, 16, 64, 103, 107, 111, 132**  
Audio input/output  
  Analog **6, 16, 64**  
  Digital **6, 16, 64**  
Auto +12 dB On **67**  
Auto punch-in **44**  
Auto Song Setup **30, 38, 58**  
Auto-pan **26, 28, 29**

## B

Bank **4, 14, 122**  
  Combination **31, 32, 34, 35**  
  Program **19, 20, 24**  
  Sampling **66**  
BANK key **4**  
Base key **77, 130**  
Beep **90, 131**  
Bit resolution **62**  
BPM **36, 76, 78, 108**  
BUS Select **6, 67, 72, 93, 104, 105, 106, 109, 110**

## C

Calendar function **120**  
Cancel button **9**  
Category **8, 20, 24, 32, 34, 41, 93, 104, 114**

CD-R/RW **117, 123, 135**  
Check box **9**  
Combination **10, 13, 31, 64, 96, 103, 105, 110, 114, 133**  
CompactFlash **125**  
Compare **14, 23, 34, 60**  
[COMPARE] key **14**  
Connection **15**  
Controller **21, 37, 50, 60**  
Copy **11, 46, 50, 53, 58, 119, 120**  
Create Control Data **45**  
Cue List **40, 53**  
Current page **8**  
Cutoff frequency **27**

## D

DAMPER **7, 16, 23, 36**  
Damper Pedal **16, 23, 36, 131**  
Data dump **113**  
Delete  
  Specific data **44, 50**  
Demo song **127**  
Dialog **9**  
DIGITAL OUT **6**  
Dmod **108**  
Drum Kit **25, 28, 78, 92, 116, 134**  
Drum sample **93, 134**  
Dual arpeggiator **101**  
Dynamic modulation **108**

## E

Edit Buffer **114**  
Edit cell **8, 13**  
Effect **1, 103**  
EG **26, 28, 29**  
Event Edit **45**  
EXB-MOSS **18, 128**  
Exclusive Group **93**  
[EXIT] key **4**  
.EXL file **113**  
External sequencer **45, 102**

## F

Factory settings **127**  
Filter **1, 23, 27**  
  Filter EG **28**  
  Filter LFO Mod. **28**  
  Filter Mod. **27**  
  Keyboard Track **27**  
Foot Pedal **16, 23**  
Foot Switch **16, 23**  
  Cue List, Switch the Step **54**  
  Manual punch-in **43**

Program/Combination will change **91**

Format **120, 135**

## G

Global **11, 13, 89, 93, 98, 116**  
GM(2) **86**  
GM/GS/XG **133**  
Grid **74**

## H

Headphone **6, 16**  
HI (Hyper Integrated) synthesis system **1**

## I

Index **69, 77**  
(INDIVIDUAL) 1, 2, 3, 4 **6, 16, 68, 80, 82, 93, 104, 131**  
Insert Effect (IFX) **30, 37, 70, 93, 103, 104, 106**  
In-Track Sampling **60, 82**

## J

Joystick **3, 21, 28**  
  Lock function **22**  
  Pitch bend **26**  
Jukebox **87**  
Jukebox list **87**

## K

Key Zone **35**  
Keyboard & Index **69, 73, 74, 77**  
Keyboard crossfade **34**  
Keyboard input **14**  
Keyboard Track **27, 29**  
Keyboard, Arpeggiator **95**  
.KMP **113, 118**  
.KSC **113, 118**  
.KSF **113, 118**

## L

L/MONO, R jacks **6, 16**  
Layer **34, 36**  
LCD screen **4, 8**  
  Contrast **7, 129, 131**  
Level  
  AUDIO INPUT **6**  
  Drum Kit **92**  
  Multisample **25**  
LFO **26, 28, 29, 108**

- Load
  - Demo song 127
  - EXB-MOSS 128
  - Factory settings 127
  - File 121
  - Jukebox List 87
  - Template Song 47
- LOCATE 5, 42, 130
- Lock function 22
- Loop
  - Sample 73, 74
- Loop All Track 44
- Low Pass & High Pass 27
- Low pass filter 27
- Low Pass Resonance 27
  
- M**
- Manual punch-in 43
- Master Effect (MFX) 30, 37, 105, 106
- Master EQ (MEQ) 105, 106
- Media 11, 13, 67, 86, 113, 116, 135
- Memory protect 115
- [MENU] key 4, 13
- Metronome 43, 58, 68, 81
- [MIC/LINE] switch 6, 64, 74, 81
- Microdrive 125
- .MID 113
- MIDI 7, 17, 45, 60, 85, 135
  - MIDI Channel 19, 35, 41
  - MIDI clock 102
  - MIDI filter 36
- Minus-one play 88
- Mode 4, 10, 13
- Monitor 6, 16, 42, 68, 71, 80, 125, 134
- Monophonic 24, 35
- Multi (multitrack recording) 44
- Multisample 1, 24, 63, 69, 78, 92
- Mute 42, 86
  
- N**
- Note Number 23
  
- O**
- OK button 9
- Open Sampling System 2
- Option 17, 139
- Oscillator 12, 23, 24
- Oscillator Mode 12, 24, 25
- Overdub 43
- Overwrite 43
  
- P**
- Page 8, 13
- Page jump menu 9, 13
- Page menu button 9
- Page menu command 9
- Pan
  - AUDIO INPUT 107
  - Combination 34
  - Program 26, 28, 29, 104
  - Sampling 75
  - Sequencer 41
- Parameter 13
- Pattern
  - Arpeggio pattern 94, 98
  - Pattern, Sequencer 40, 43, 49, 50, 55, 78
- .PCG 113, 118
- Performance Editor 23
- Pin 8
- Pitch 89
  - Combination 35
  - Drum kit 92, 134
  - Program 23, 26
  - Sampling 66, 78
  - Scale 91
- Polyphonic 24, 35
- Polyphony 12
- Popup button 8, 14
- Popup menu 8, 14
- Portamento 26, 35, 36
- Power 6, 16, 18
  - Recalling the last-selected mode 90
- Preload data 113
- Program 10, 19, 64, 90, 91, 92, 94, 103, 104, 109, 114
  - Combination 32, 34
  - Sampling 78
  - Sequencer 41, 58
  
- Q**
- Quantize 42, 49
  
- R**
- Radio button 9
- REALTIME CONTROLS 3, 22, 39, 129
- Realtime Quantize 49
- Realtime recording
  - Pattern 49
  - Track 43
- [REC] key 5, 65, 66
- [REC/WRITE] key 5, 43, 114, 116
- Recording Level 65, 67, 132, 134
- Rename 115
- Resampling 67, 70, 83
- Resonance 27, 93
- Ribbon controller 3, 21
  - Lock function 22
  - Pitch bend 26
- Routing 93, 104, 105, 106, 107
- RPPR 55, 79
  - Create 55
  - Play 56
  - Realtime-recording 56
  
- S**
- Sample 36, 61, 63, 70, 71, 77
- Sample memory (RAM) 2, 18, 66, 67
- Sample memory (RAM) slot cover 6
- Sampling 2, 5, 11, 13, 62, 64, 68, 80, 103, 106, 110
- Sampling frequency 7, 62, 123, 132
- Save 113, 117
  - Data filer 119
  - Jukebox list 87
  - Media 117
  - Track list 125
- Scale 36, 91
- Scroll bar 8
- Send
  - AUDIO INPUT 107
  - Combination, Sequencer, Song Play 105
  - Drum kit 93
  - Program 104
- Sequencer 5, 11, 13, 39, 40, 61, 64, 78, 80, 102, 103, 105, 110
- Shortcut 130
- SIMM 18
- .SNG file 113, 118
- Solo 42, 86
- Song 39, 40, 85
  - Convert a cue list 54
  - Copy 50
  - Create a Wave file 83
  - Edit 50
  - In-Track Sampling 82
  - Naming 51
  - Save 117
  - Setting the number of measures 51
- Song Play 11, 13, 64, 102, 103, 105, 110, 133
- S/P DIF 6, 16, 64, 107, 131
- Specifications 138
- Split 34, 35
- Standard MIDI File (SMF) 39, 59, 85
- Status 35, 60, 85
- Step
  - Cue List 53
  - User arpeggio pattern 98
- Step recording 45
- Step, Arpeggiator 99
- [SW1], [SW2] 3, 21, 108, 129
- Synchronize 45, 60, 85, 102

---

## T

Tab **9, 13**  
Tap tempo **7, 74, 90, 130**  
Template song **39, 113**  
Tempo **5, 29, 33, 42, 53, 60, 74, 78, 94, 96, 108**  
Text edit button **9, 114**  
Timbre **34**  
Time signature **39, 42, 49, 53, 74, 78**  
Toggle button **9**  
Tone **22, 23, 27**  
    User arpeggio pattern **99**  
Tone Generator **12**  
Tone, Arpeggiator **99**  
TouchView **2**  
Track **43**  
    Musical data **40, 79**  
    Setup parameters **40**  
    Track edit **50**  
Track list **123**  
Transpose **35, 89**  
Tremolo **26, 29**  
Tuning **89**

## U

Use DKit Setting **28**  
Use Zero **77**  
User arpeggio pattern **98**  
User pattern **40, 49**  
User Scale **91**  
User template song **113**

## V

VALUE controller **4, 14**  
[VALUE] dial **4**  
[VALUE] slider **4, 22**  
Valve Force **3, 109**  
Velocity **22, 25, 130**  
    Arpeggiator **95**  
    Velocity crossfade **34**  
    Velocity Curve **89**  
    Velocity drumsample switching **93**  
    Velocity multisample switching **24**  
    Velocity switch **34, 36**  
    Velocity Zone **37**  
Velocity Sample SW Lo→Hi **93**  
Vibrato **21, 26, 29**  
Volume **3, 18, 19, 23, 25, 28, 34, 41, 65, 71**  
    Combination **34**  
    Sequencer **41**  
[VOLUME] slider **3**

## W

Wah **21, 26, 28, 29**  
Write **5, 90, 113**  
    Arpeggiator **96, 98**  
    Global settings, User drum kits,  
    User arpeggio patterns **116**  
    Program, Combination **114**  
    SW1, SW2 **21**  
    User template song **113**

## Z

Zero-cross **62, 74**  
ZOOM button **76**

### **IMPORTANT NOTICE TO CONSUMERS**

This product has been manufactured according to strict specifications and voltage requirements that are applicable in the country in which it is intended that this product should be used. If you have purchased this product via the internet, through mail order, and/or via a telephone sale, you must verify that this product is intended to be used in the country in which you reside.

**WARNING:** Use of this product in any country other than that for which it is intended could be dangerous and could invalidate the manufacturer's or distributor's warranty.

Please also retain your receipt as proof of purchase otherwise your product may be disqualified from the manufacturer's or distributor's warranty.

**KORG** KORG INC.

15 - 12, Shimotakaido 1 - chome, Suginami-ku, Tokyo, Japan.