

Bugera

THE SOUL OF VALVES

**6262/6262-212/6260/6260-212
User Manual**

en

Important safety instructions



CAUTION: High voltage! Risk of death! High voltages of up to 500 V DC may be present inside the casing for long periods after being disconnected from the mains. To avoid lethal electric shock, do not open the casing. There are no user-serviceable components inside. Refer all maintenance to qualified service personnel. Remove the mains cable when the unit is not in use.

WARNING: To eliminate the risk of fire and electric shock, do not expose this unit to rain or moisture and splashing or dripping liquid, which might enter the device. Do not place any objects filled with liquid, such as vases, on the unit.



This symbol, wherever it appears, alerts you to the presence of uninsulated dangerous voltage inside the enclosure—voltage that may be sufficient to constitute a risk of shock.



This symbol, wherever it appears, alerts you to important operating and maintenance instructions in the accompanying literature. Please read the manual.

- 1) Read these instructions.
- 2) Keep these instructions.
- 3) Heed all warnings.
- 4) Follow all instructions.
- 5) Do not use this apparatus near water.
- 6) Clean only with dry cloth.
- 7) Do not block any ventilation openings. Install in accordance with the manufacturer's instructions.
- 8) Do not install near any heat sources such as radiators, heat registers, stoves, or other apparatus (including amplifiers) that produce heat.
- 9) Do not defeat the safety purpose of the polarized or grounding-type plug. A polarized plug has two blades with one wider than the other. A grounding type plug has two blades and a third grounding prong. The wide blade or the third prong are provided for your safety. If the provided plug does not fit into your outlet, consult an electrician for replacement of the obsolete outlet.
- 10) Protect the power cord from being walked on or pinched particularly at plugs, convenience receptacles, and the point where they exit from the apparatus.
- 11) The apparatus shall be connected to a MAINS socket outlet with a protective earthing connection.
- 12) Where the MAINS plug or an appliance coupler is used as the disconnect device, the disconnect device shall remain readily operable.
- 13) Only use attachments/accessories specified by the manufacturer.
- 14) Use only with the cart, stand, tripod, bracket, or table specified by the manufacturer, or sold with the apparatus. When a cart is used, use caution when moving the cart/apparatus combination to avoid injury from tip-over.



- 15) Unplug this apparatus during lightning storms or when unused for long periods of time.
- 16) Refer all servicing to qualified service personnel. Servicing is required when the apparatus has been damaged in any way, such as power supply cord or plug is damaged, liquid has been spilled or objects have fallen into the apparatus, the apparatus has been exposed to rain or moisture, does not operate normally, or has been dropped.
- 17) CAUTION - These service instructions are for use by qualified service personnel only. To reduce the risk of electric shock do not perform any servicing other than that contained in the operation instructions unless you are qualified to do so.
- 18) CAUTION! During use, the valves get very hot and high surface temperatures may be reached at the rear of this unit. To avoid burning yourself, make all connections while the unit is still cold.

Table of contents

Introduction	4
Before you get started.....	4
Online registration.....	4
Control elements	5
Front panel.....	5
Rear panel.....	6
Footswitch.....	6
Inside the BUGERA.....	7
Wiring the BUGERA	8
Audio connections	9
Specifications	10
Warranty	11

CAUTION!

- **Please note that high volume levels may cause permanent damage to your hearing and/or your loudspeakers. Turn all LEVEL controls to the left before switching on the unit. Be sure to keep the volume at an appropriate level.**

Introduction

Congratulations! By purchasing the BUGERA, you have chosen a state-of-the-art valve amplifier.

This 120-Watt full-valve amp offers you 2 full-fledged channels with 3 tone controls, a separate switchable Effects Loop plus integrated Reverb, a Crunch function on the Clean channel and much more. This way you're in full control and can get down to the nitty-gritty—your music! Discover the killer sound of the BUGERA and be inspired by its versatility. Whatever style you play, this monster amp gives you the full valve power that you require.

Before you get started

Your product was carefully packed at the factory to ensure safe transport. Nevertheless, if the box is damaged inspect the unit immediately for signs of damage.

- **If the unit is damaged please do NOT return it to us, but notify your dealer and the shipping company immediately; otherwise, claims for damage or replacement may not be granted.**
- **Always use the original box to prevent damage during storage or transport.**
- **Make sure that children cannot play unsupervised with the unit or its packaging.**
- **Please ensure proper disposal of all packing materials.**

Ensure adequate air supply and to avoid overheating do not place the unit near radiators etc.

- **Please make sure that all devices are properly grounded. For your own safety, never remove or disable the ground conductors from the devices or on the power cords. The unit must always be connected to the mains outlet with a protective grounding connection.**
- **The tone quality may diminish within the range of powerful radio broadcasting stations and high-frequency sources. Increase the distance between the transmitter and the unit, and use shielded cables for all connections.**

Online registration

Please do remember to register your new BUGERA equipment right after your purchase by visiting www.bugera-amps.com and kindly read the terms and conditions of our warranty carefully.

Should your BUGERA product malfunction, our goal is to have it repaired as quickly as possible. To arrange for warranty service, please contact the retailer from whom the equipment was purchased. Should your BUGERA dealer not be located in your vicinity, you may directly contact the BEHRINGER company nearest to you. This contact information is included in the original equipment packaging (Global Contact Information/European Contact Information). Should your country not be listed, please contact our exclusive distributor BEHRINGER Singapore (BEHRINGER Holdings (Pte) Ltd., 1 Kim Seng Promenade #08-08, Great World City West Tower, Singapore 237994, Tel.: +65 6845 1800, Fax: +65 6214 0275).

Registering your purchase and equipment with us helps us process your repair claims quicker and more efficiently.

Thank you for your cooperation!

Control elements

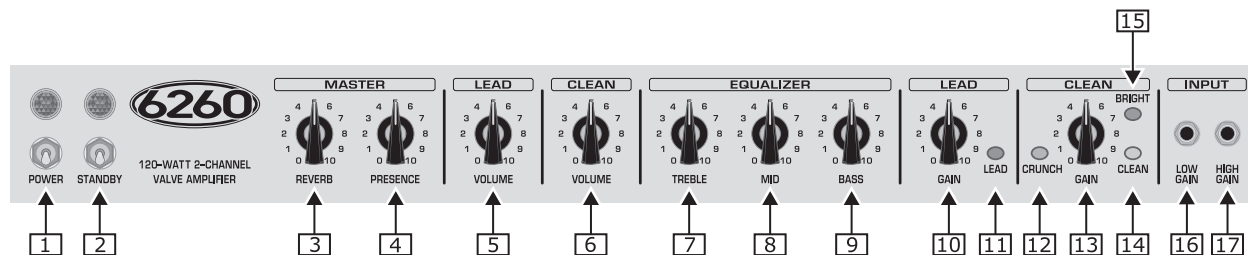

Front panel of the BUGERA 6260

Front panel

- 1 The **POWER** switch is used to turn the power of the BUGERA amplifier on and off.
- 2 The **STANDBY** switch allows you to place the amp in STANDBY mode. This way the amp is idle, but the operational temperature of the valves is maintained (POWER switch turned on).
- 3 The **REVERB** control determines the amount of the built-in reverb effect. The 6262 (and 6262-212) features individual REVERB controls for the LEAD and CLEAN channels. The supplied footswitch lets you activate the REVERB effect (see Chapter „Footswitch“).
- 4 The **PRESENCE** control modifies the amp’s damping factor at high frequencies. This is used to fine-tune the high-frequency range of the speaker cabinet. The 6262 (or 6262-212) features individual PRESENCE controls for the LEAD and CLEAN channels.
- 5 This is the **VOLUME** control that lets you adjust the volume level of the LEAD channel.
- 6 This is the **VOLUME** control that lets you adjust the volume level of the CLEAN channel.
- 7 The passive **TREBLE** control adjusts the upper frequency range. The 6262 (and 6262-212) features separate TREBLE controls for the LEAD and CLEAN channels.
- 8 The passive **MID** control adjusts the middle frequency range. The 6262 (and 6262-212) features separate MID controls for the LEAD and CLEAN channels.
- 9 The passive **BASS** control adjusts the lower frequency range. The 6262 (and 6262-212) features separate BASS controls for the LEAD and CLEAN channels.
- 10 This **GAIN** control specifies the input level of the LEAD channel. Turn the control to the right to increase the preamplifier’s distortion and sustain.
- 11 The **LEAD** switch activates the LEAD channel (switch glows red).
- 12 The **CRUNCH** switch activates the gain boost on the CLEAN channel (switch glows yellow). This way the CLEAN channel can be used as a second LEAD channel.
- 13 This **GAIN** control specifies the input level of the CLEAN channel. Turn the control to the right to increase the preamplifier’s distortion and sustain.
- 14 The **CLEAN** switch activates the CLEAN channel (switch glows green).
- 15 The **BRIGHT** switch activates an extra boost in the high-frequency range (+6 dB at 2 kHz) which only affects the CLEAN channel.
- 16 The **LOW GAIN** input is used for instruments with an extremely high output level that could distort the HIGH GAIN input (only 6260 and 6260-212).
- 17 The **HIGH GAIN** input (6262 and 6262-212: **INPUT**) is 6 dB louder than the LOW GAIN input and is used for most electric guitars.

- Please note that extremely high **GAIN** settings in conjunction with extremely high **VOLUME** settings can make the combo models vibrate mechanically. This may occur when played at extremely high volume levels, which is seldom done. Should this be the case, adjust the **GAIN** and **VOLUME** settings so that the problem does not recur.
- You can also activate both channels with the supplied footswitch. Refer to „Footswitch“ for details.
- The **HIGH GAIN** and **LOW GAIN** connectors have identical sensitivity when used at the same time (both with **LOW GAIN** sensitivity).

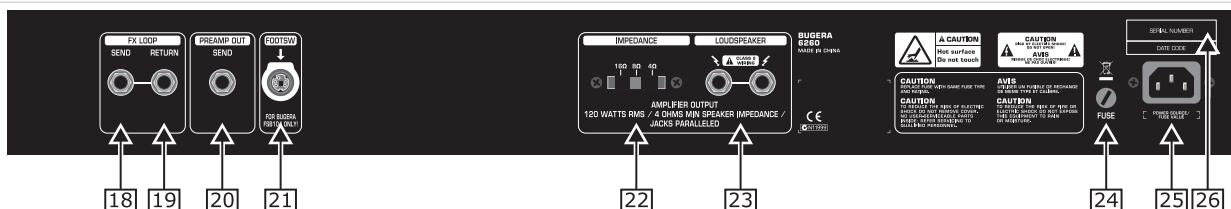

Rear panel of the BUGERA 6260

Rear panel



CAUTION!

Hot! Risk of injury! During use, the valves get very hot and high surface temperatures may be reached at the rear of this unit. Avoid touching the controls and connectors on the rear panel during use. To avoid accidental contact with hot surfaces, place the rear panel so that it faces a wall.

- 18 The **SEND** output is used to connect a shielded ¼" mono jack cable to the input of an external effects unit.
- 19 The **RETURN** input is used to connect a shielded ¼" mono jack cable to the output of an external effects unit.
- 20 The **PREAMP OUT SEND** output takes the preamp signal of the amp in order to feed the signal to a second amplifier and loudspeaker combination, for example.
- 21 The 7-pin **FOOTSW**(itch) connector is provided to connect to the supplied BUGERA FSB104A footswitch. Please be sure to connect the cables before switching on the amplifier. Refer to „Footswitch“ for details.
- 22 The **IMPEDANCE** switch lets you specify the loudspeaker impedance. Always apply the value that is identical to the impedance of the used speaker cabinet. When connecting two cabinets with the same impedance, the switch should be set to half the value of one of the cabinets. For example, two 16-Ohm cabinets would require an 8-Ohm setting, while two 8-Ohm cabinets need to be set to the minimum impedance of 4 Ohms. Please also read „Wiring the BUGERA“.
- 23 Both the paralleled **LOUDSPEAKER** outputs (¼" mono jacks) are used to connect the speaker cabinet(s). The minimum impedance is 4 Ohms. The IMPEDANCE switch should always be set to match the impedance of the used speaker cabinet.
- 24 The **FUSE** is found in the fuse holder. If the fuse is blown, it needs to be replaced with a fuse of the same kind by all means. Otherwise, the unit could seriously be damaged, in which case the warranty is void. If the fuse is blown repeatedly, you should take the unit to a qualified service technician. **WARNING: ONLY REPLACE THE FUSE WHEN THE MAINS CABLE HAS BEEN DISCONNECTED!**
- 25 The **IEC MAINS** connector is used to connect the mains cable that has the appropriate voltage ratings for your country (included). At all times, make the connections to the amplifier before plugging the cable into a power outlet.
- 26 This is the **SERIAL NUMBER** of the amplifier.

Footswitch

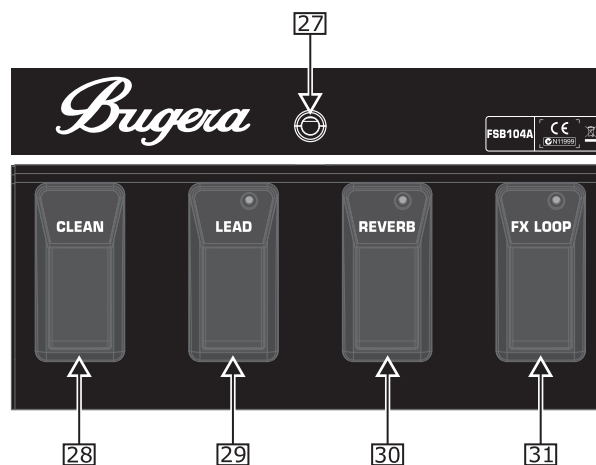

Footswitch BUGERA FSB104A

- 27 The 7-pin **DIN** connector is provided to connect the footswitch cable (included). Then, the cable is connected to the FOOTSW(itch) connector of the BUGERA amplifier. Be sure to make a connection before switching on the amplifier.
- 28 The **CLEAN** switch activates the CLEAN/CRUNCH channel.
- 29 The **LEAD** switch activates the LEAD channel. Its LED illuminates when the channel is active.
- 30 The **REVERB** switch activates the REVERB effect. Its LED illuminates when the effect is active.
- 31 The **FX LOOP** switch activates the FX LOOP function. Its LED illuminates when the FX LOOP is active.

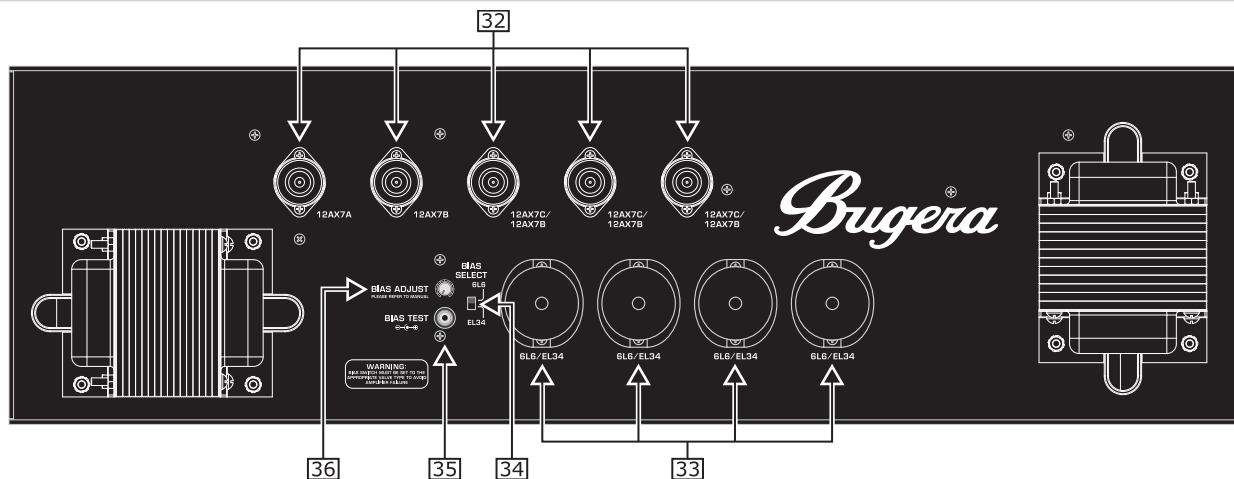

Inside the BUGERA 6260

Inside the BUGERA



DANGER!

High voltage! Risk of death!

High voltages of up to 500 V DC may be present inside the casing for long periods after being disconnected from the mains. To avoid lethal electric shock, do not open the casing. There are no user-serviceable components inside. Refer all maintenance to qualified service personnel. Remove the mains cable when the unit is not in use.



The parts inside the amplifier operate at high voltages and high temperatures. To avoid damage and injury that results from fire or electric shock, do not drop or spill anything into the unit's casing.

Remove the backside of the amplifier's casing to get to the valves and the control elements.

32 These are the sockets for the **12AX7A/B/C** preamp valves.

33 These are the sockets for the **6L6** and **EL34** power amp valves. Please take care that the **BIAS SELECT** switch (**34**) is set correctly. The BUGERA amp is supplied with 6L6GC power amp valves when it leaves the factory.

34 The **BIAS SELECT** switch allows the amplifier to optimally adapt to the used valves (6L6 or EL34).

35 The **BIAS TEST** connector lets you connect a voltmeter in order to measure the power amp valves (bias adjustment). Make sure that the voltmeter is set to direct current (DC).



36 The **BIAS ADJUST** control is used to make the bias-adjustment.

➤ Replacing the power amp valves also requires bias adjustment. You should always use sets of four matched valves. The valves of the BUGERA Series are ideal for this purpose.



CAUTION: WE HIGHLY RECOMMEND THAT BIAS ADJUSTMENTS BE CARRIED OUT BY QUALIFIED PERSONNEL!

Wiring the BUGERA



CAUTION!

Hot! Risk of injury! During use, the valves will get very hot and high surface temperatures may be reached at the rear of this unit. To avoid burning yourself, make all connections while the unit is still cold.

The BUGERA amplifier has two paralleled LOUDSPEAKER outputs which are used to connect one or two speaker cabinets.

If you only connect one speaker cabinet, be sure that the IMPEDANCE switch is set to match the impedance of the connected cabinet.

If you want to connect two speaker cabinets, both cabinets should have to the same impedance. Be sure to have set the IMPEDANCE switch correctly. In this case, set it to half the value of one of the cabinets. When using two 16-Ohm cabinets, the switch therefore needs to be set to 8 Ohms; and with two 8-Ohm cabinets, set it to the minimum impedance of 4 Ohms.

CAUTION: The loudspeakers in the combos are connected in series. This results in an impedance of 16 Ohms.

Speaker cabinets	IMPEDANCE switch		
	16 Ω	8 Ω	4 Ω
1 x 16 Ω	✓		
1 x 8 Ω		✓	
1 x 4 Ω			✓
2 x 16 Ω		✓	
2 x 8 Ω			✓

Impedances

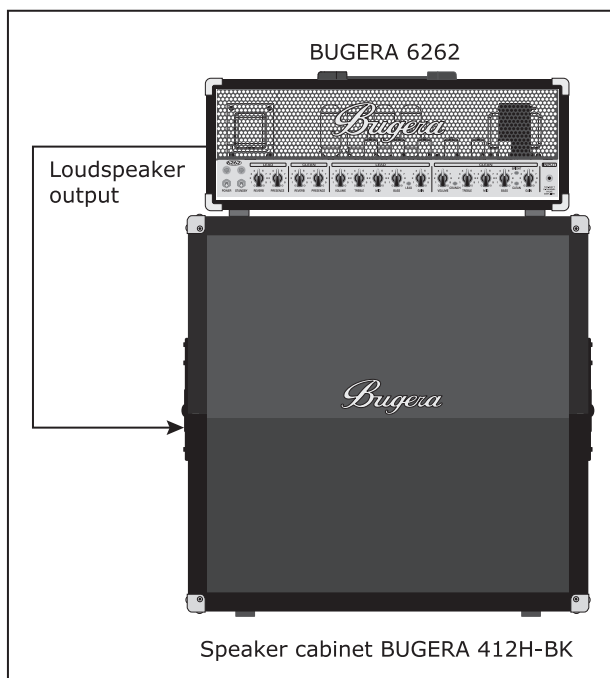

BUGERA head with a speaker cabinet

The following figure shows a setup of the 6262-212 together with an external effects unit connected over the FX LOOP. And the PREAMP OUT is connected to the line input of a mixer in order to send the signal to a recording device. In addition, the speaker signal of the BUGERA is picked up by a microphone and is fed to the microphone input of the mixer. This way you get a second guitar signal which then can be amplified by a PA system and/or can be recorded as well.

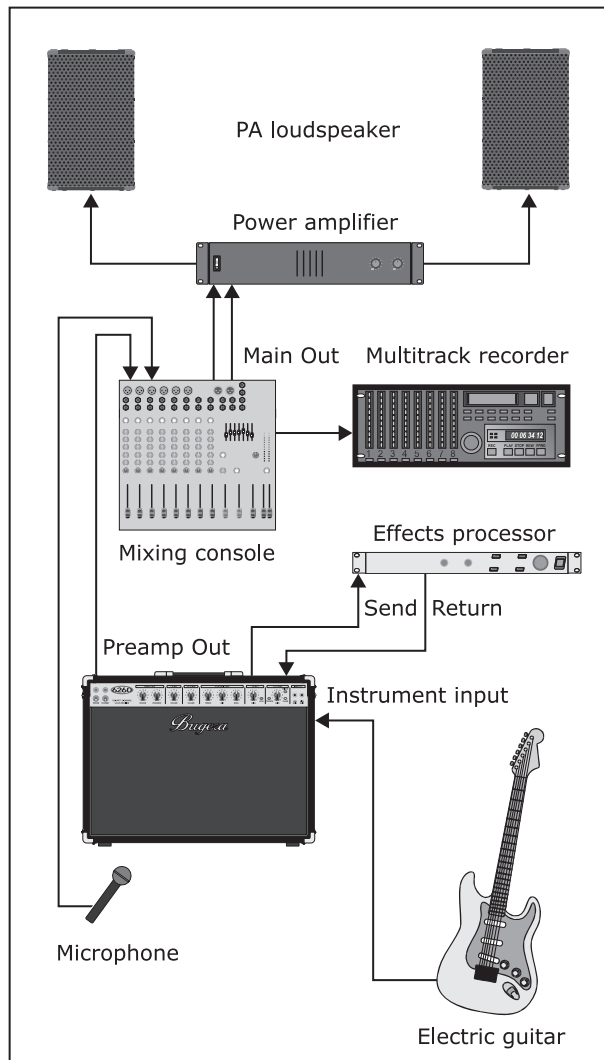

Live setup with a BUGERA combo

Audio connections

The inputs and outputs of the BUGERA amplifier use mono jack connectors.

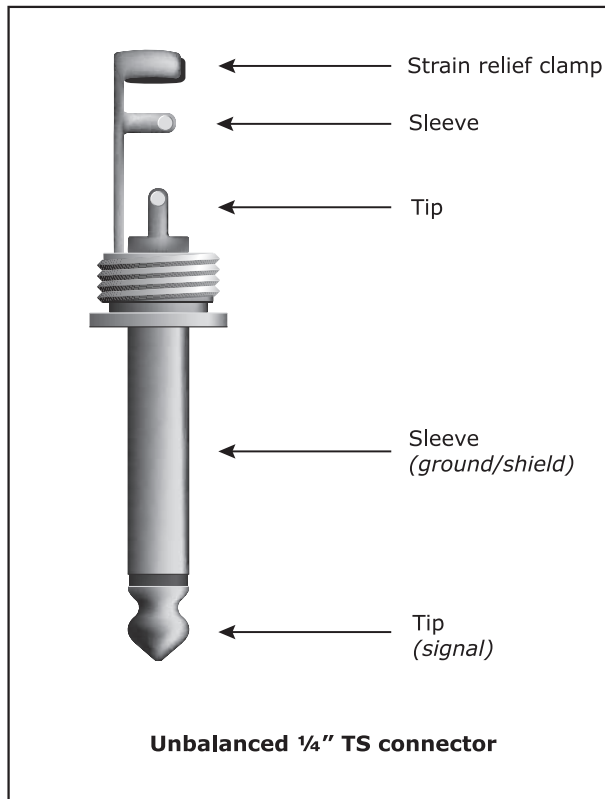

1/4" mono jack connector

Specifications

PREAMP SECTION

Valves

Type	1 x 12AX7A 1 x 12AX7B 3 x 12AX7C (6260 and 6260-212) 4 x 12AX7C (6262 and 6262-212)
------	----------------------------------------------------------------------------------------------

Preamp high-gain input

Impedance	470 k Ω
-----------	----------------

Clean channel

Nominal input level	-34 dBV
Min. input level	-50 dBV
Max. input level	0 dBV

Lead channel

Nominal input level	-80 dBV
Min. input level	-92 dBV

Preamp low-gain input (only 6260 and 6260-212)

Impedance	44 k Ω
All levels attenuated by	+6 dB

Effects send

Impedance	47 k Ω or higher
Nominal output level	-10 dBV

Effects return

Impedance	470 k Ω
Min. input sensitivity	-10 dBV

Preamp output

Impedance	47 k Ω or higher
Nominal output level	+10 dBV

POWER AMPLIFIER SECTION

Valves

Type	4 x 6L6GC
------	-----------

Output power

Peak power	120 W / 16, 8, 4 Ω
------------	---------------------------

Loudspeaker connectors

Type	¼" mono jack connectors, unbalanced
Load impedance	4 Ω / 8 Ω / 16 Ω switchable

Internal loudspeakers (only 6262-212 and 6260-212)

Type	2 x 12" BUGERA, 12G70J8
Impedance	8 Ω
Power	70 W (IEC)
Total impedance	16 Ω (series connection)

POWER SUPPLY

Power consumption	Max. 350 W
Fuse	T 3.15 A H 250 V (100 – 120 V \sim , 50/60 Hz) T 1.6 A H 250 V (220 – 240 V \sim , 50/60 Hz)
Mains connection	Standard IEC receptacle

DIMENSIONS/WEIGHT

6260

Dimensions (H x W x D)	Approx. 9 25/32" x 27" x 9 11/16" (249 mm x 687.3 mm x 246 mm)
Weight	Approx. 47 lbs (21.5 kg)

6260-212

Dimensions (H x W x D)	Approx. 20 13/32" x 27" x 9 3/4" (518.46 mm x 687.3 mm x 247.65 mm)
Weight	Approx. 63 lbs (28.5 kg)

6262

Dimensions (H x W x D)	Approx. 9 25/32" x 27" x 9 11/16" (249 mm x 687.3 mm x 246 mm)
Weight	Approx. 47 lbs (21.5 kg)

6262-212

Dimensions (H x W x D)	Approx. 20 13/32" x 27" x 9 3/4" (518.46 mm x 687.3 mm x 247.65 mm)
Weight	Approx. 63 lbs (28.5 kg)

We are constantly striving to maintain the highest professional standards. As a result of these efforts, modifications may be made from time to time to existing products without prior notice. Specifications and appearance may differ from those listed or illustrated.

Warranty

§ 1 Other warranty rights and national law

1. This warranty does not exclude or limit the buyer's statutory rights provided by national law, in particular, any such rights against the seller that arise from a legally effective purchase contract.
2. The warranty regulations mentioned herein are applicable unless they constitute an infringement of national warranty law.

§ 2 Online registration

Please do remember to register your new BUGERA equipment right after your purchase by visiting <http://www.bugera-amps.com> and kindly read the terms and conditions of our warranty carefully. Registering your purchase and equipment with us helps us process your repair claims quicker and more efficiently. Thank you for your cooperation!

§ 3 Warranty

1. BEHRINGER warrants the mechanical and electronic components of this product to be free of defects in material and workmanship for a period of one (1) year* from the original date of purchase, in accordance with the warranty regulations described below. If the product shows any defects within the specified warranty period that are not excluded from this warranty as described under § 6, BEHRINGER shall, at its discretion, either replace the product by providing a new or reconditioned product or repair the product using suitable new or reconditioned parts. In the case that other parts are used which constitute an improvement, BEHRINGER may, at its discretion, charge the customer for the additional cost of these parts. In case BEHRINGER decides to replace the product, this warranty shall apply to the replacement product for the remaining initial warranty period, i.e. one year* from the date of purchase of the initial product.
2. If the warranty claim proves to be justified, the product will be returned to the user freight prepaid.
3. Warranty claims other than those indicated above are expressly excluded.

§ 4 Limited warranty valves and meters

Where applicable, BEHRINGER warrants the valves or meters contained in the product to be free from defects in material and workmanship for a period of ninety (90) days from date of purchase, PROVIDED however, that this limited warranty is extended only to the original retail purchaser. This limited warranty is also subject to the conditions, exclusions and limitations hereinafter set forth.

§ 5 Return authorization number

1. To obtain warranty service, the buyer (or his authorized dealer) must call BEHRINGER as exclusive distributor of BUGERA products (see enclosed list) during normal business hours BEFORE returning the product. All inquiries must be accompanied by a description of the problem. The buyer or his authorized dealer will receive a return authorization number.
2. Subsequently, the product must be returned in its original shipping carton, together with the return authorization number. The return shipment address will be indicated by BEHRINGER.
3. Shipments without freight prepaid will not be accepted.

§ 6 Warranty regulations

1. Warranty services will be furnished only if the product is accompanied by a copy of the original retail dealer's invoice. Any product deemed eligible for repair or replacement under the terms of this warranty will be repaired or replaced.
2. If the product needs to be modified or adapted in order to comply with applicable technical or safety standards on a national or local level, in any country which is not the country for which the product was originally developed and manufactured, this modification/adaptation shall not be considered a defect in materials or workmanship. The warranty does not cover any such modification/adaptation, irrespective of whether it was carried out properly or not. Under the terms of this warranty, BEHRINGER shall not be held responsible for any cost resulting from such a modification/adaptation.
3. Free inspections and maintenance/repair work are expressly excluded from this warranty, in particular, if caused by improper handling of the product by the user. This also applies to defects caused by normal wear and tear, in particular, of faders, crossfaders, potentiometers, keys/buttons, tubes, guitar strings, illuminants and similar parts.
4. Damage/defects caused by the following conditions are not covered by this warranty:
 - improper handling, neglect or failure to operate the unit in compliance with the instructions given in BEHRINGER user or service manuals.
 - connection or operation of the unit in any way that does not comply with the technical or safety regulations applicable in the country where the product is used.
 - damage/defects caused by force majeure or any other condition that is beyond the control of BEHRINGER.
5. Any repair or opening of the unit carried out by unauthorized personnel (user included) will void the warranty.
6. If an inspection of the product by BEHRINGER shows that the defect in question is not covered by the warranty, the inspection costs are payable by the customer.
7. Products which do not meet the terms of this warranty will be repaired exclusively at the buyer's expense. BEHRINGER will inform the buyer of any such circumstance. If the buyer fails to submit a written repair order within 6 weeks after notification, BEHRINGER will return the unit. Costs for freight and packing will be invoiced separately C.O.D. When the buyer has sent in a written repair order such costs will also be invoiced separately.

§ 7 Warranty transferability

This warranty is extended exclusively to the original buyer (customer of retail dealer) and is not transferable to anyone who may subsequently purchase this product.

§ 8 Claim for damages

Failure of BEHRINGER to provide proper warranty service shall not entitle the buyer to claim (consequential) damages. In no event shall the liability of BEHRINGER exceed the invoiced value of the product.

* Customers in the European Union please contact BEHRINGER Germany Support for further details.

Technical specifications and appearance are subject to change without notice. The information contained herein is correct at the time of printing. All trademarks (except BUGERA, the BUGERA logo, and THE SOUL OF VALVES) mentioned belong to their respective owners, and such use neither constitutes a claim of the trademarks by RED CHIP COMPANY LTD nor affiliation of the trademark owners with RED CHIP COMPANY LTD. RED CHIP COMPANY LTD accepts no liability for any loss which may be suffered by any person who relies either wholly or in part upon any description, photograph or statement contained herein. Colors and specifications may vary slightly from product. Our Products are sold through authorized dealers only. This manual is copyrighted. No part of this manual may be reproduced or transmitted in any form or by any means, electronic or mechanical, including photocopying and recording of any kind, for any purpose, without the express written permission of RED CHIP COMPANY LTD. BUGERA-products are distributed exclusively by the BEHRINGER Group of companies globally, and specifically by BEHRINGER International GmbH in the European Union.

ALL RIGHTS RESERVED.
(c) 2007 RED CHIP COMPANY LTD.
Trident Chambers, Wickhams Cay, P.O. Box 146,
Road Town, Tortola, British Virgin Islands.