

BOSE[®]

L1[™] Model II System with ToneMatch[™] port

Owner's Guide

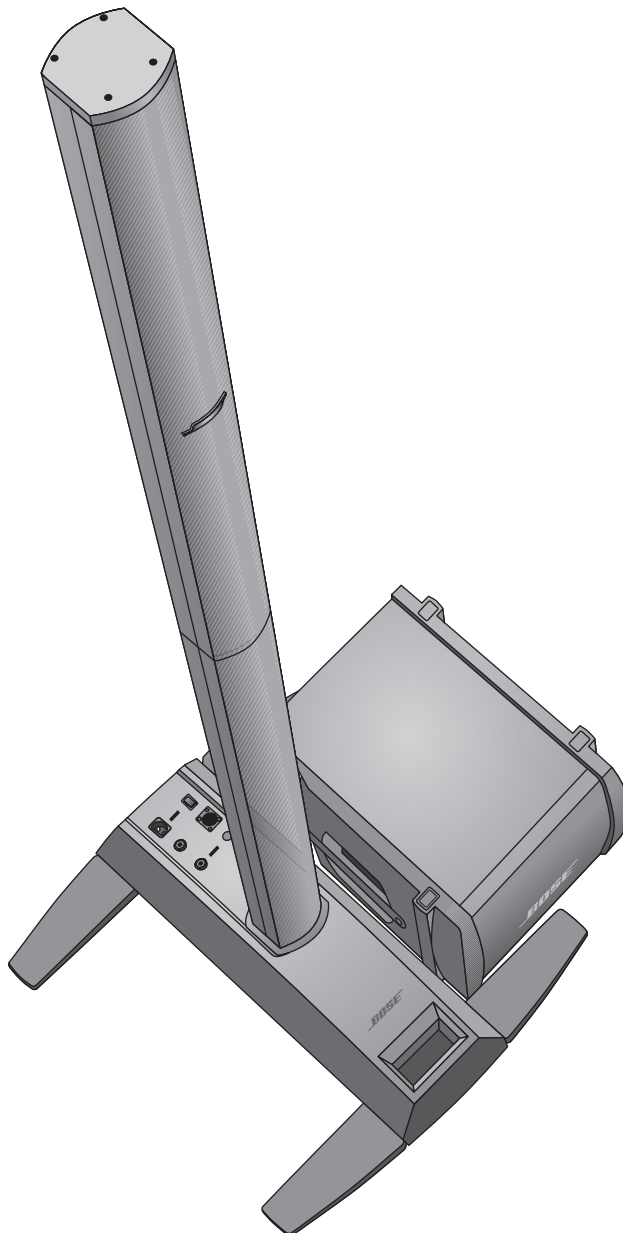



SAFETY INFORMATION



Please read this owner's guide

Please take the time to follow the instructions in this owner's guide carefully. It will help you set up and operate your system properly and enjoy its advanced features. Please save this owner's guide for future reference.

 **WARNING:** To reduce the risk of fire or electrical shock, do not expose the system to rain or moisture.

 **WARNING:** To reduce the risk of electric shock, do not disassemble this system unless you are qualified. Refer servicing to qualified service personnel.

	CAUTION RISK OF ELECTRICAL SHOCK DO NOT OPEN	
CAUTION: TO REDUCE THE RISK OF ELECTRIC SHOCK, DO NOT REMOVE COVER (OR BACK). NO USER-SERVICABLE PARTS INSIDE. REFER SERVICING TO QUALIFIED PERSONNEL.		

	AVIS RISQUE DE CHOC ÉLECTRIQUE NE PAS OUVRIR	
ATTENTION : POUR RÉDUIRE LE RISQUE DE DÉCHARGE ÉLECTRIQUE, NE RETIREZ PAS LE COUVERCLE (OU L'ARRIÈRE). IL NE SE TROUVE À L'INTÉRIEUR AUCUNE PIÈCE POUVANT ÊTRE RÉPARÉE PAR L'USAGER. S'ADRESSER À UN RÉPARATEUR COMPÉTENT.		

 The lightning flash with arrowhead symbol within an equilateral triangle alerts the user to the presence of uninsulated, dangerous voltage within the system enclosure that may be of sufficient magnitude to constitute a risk of electrical shock.

 The exclamation point within an equilateral triangle, as marked on the system, is intended to alert the user to the presence of important operating and maintenance instructions in this owner's guide.

 **CAUTION:** This product shall be connected to a mains socket outlet with a protective earthing connection.

 **CAUTION:** Make no modifications to the system or accessories. Unauthorized alterations may compromise safety, regulatory compliance, and system performance.

 **CAUTION:** No naked flame sources, such as lighted candles, should be placed on the apparatus.

 **CAUTION:** Where the mains plug is used as the disconnect device, such disconnect device shall remain readily operable.

 **Note:** The product must be used indoors. It is neither designed nor tested for use outdoors, in recreation vehicles, or on boats.

 This product conforms to the EMC Directive 89/336/EEC and to the Low Voltage Directive 73/23/EEC. The complete Declaration of Conformity can be found at www.Bose.com/static/compliance/index.html.

IMPORTANT SAFETY INSTRUCTIONS

1. Read these instructions.
2. Keep these instructions.
3. Heed all warnings.
4. Follow all instructions.
5. Do not use this apparatus near water.
6. Clean only with a dry cloth.
7. Do not block any ventilation openings. Install in accordance with the manufacturer's instructions.
8. Do not install near any heat sources, such as radiators, heat registers, stoves, or other apparatus (including amplifiers) that produce heat.
9. Do not defeat the safety purpose of the polarized or grounding-type plug. A polarized plug has two blades with one wider than the other. A grounding-type plug has two blades and a third grounding prong. The wider blade or third prong is provided for your safety. If the provided plug does not fit into your outlet, consult an electrician for replacement of the obsolete outlet.
10. Protect the power cord from being walked on or pinched, particularly at plugs, convenience receptacles, and the point where they exit from the apparatus.
11. Only use attachments/accessories specified by the manufacturer.
12. Use only with the cart, stand, tripod, bracket, or table specified by the manufacturer or sold with the apparatus. When a cart is used, use caution when moving the cart/apparatus combination to avoid injury from tip-over. 
13. Unplug this apparatus during lightning storms or when unused for long periods of time.
14. Refer all servicing to qualified service personnel. Servicing is required when the apparatus has been damaged in any way, such as power-supply cord or plug is damaged, liquid has been spilled or objects have fallen into the apparatus, the apparatus has been exposed to rain or moisture, does not operate normally, or has been dropped.
15. To prevent risk of fire or electric shock, avoid overloading wall outlets, extension cords, or integral convenience receptacles.
16. Do not let objects or liquids enter the product – as they may touch dangerous voltage points or short-circuit parts that could result in a fire or electric shock.
17. See product enclosure bottom for safety-related markings.
18. Use proper power sources – Plug the product into a proper power source, as described in the operating instructions or as marked on the product.
19. Apparatus shall not be exposed to dripping or splashing, and no objects filled with liquids, such as vases, shall be placed on the apparatus.

Information about products that generate electrical noise

This equipment has been tested and found to comply with the limits for a Class A digital device, pursuant to Part 15 of the FCC rules. These limits are designed to provide reasonable protection against harmful interference in a commercial environment. This equipment generates, uses, and can radiate radio frequency energy and, if not installed and used in accordance with the instructions, may cause harmful interference to radio communications. Operation of this equipment in a residential area is likely to cause harmful interference, in which case the user will be required to correct the interference at his own expense.

This product complies with the Canadian ICES-003 Class A specifications.

SIKKERHEDSINFORMATION

Læs denne brugervejledning

Tag dig tid til at følge denne brugervejledning omhyggeligt. Hermed får du hjælp til at installere og betjene systemet korrekt, så du kan drage nytte af alle dets avancerede funktioner. Gem din brugervejledning til fremtidig brug.

- ADVARSEL:** Systemet må ikke udsættes for regn eller fugtighed af hensyn til risikoen for brand eller elektrisk stød.
- ADVARSEL:** Skil ikke systemet ad, med mindre du er kvalificeret hertil af hensyn til risikoen for elektrisk stød. Overlad serviceringen til kvalificeret servicepersonale. De FORSIGTIG-mærker, der er vist her, er placeret på systemets kabinetter.

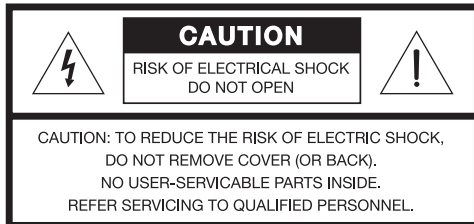

En ligebenet trekant med et lyn med pilehoved gør brugeren opmærksom på, at der i systemets kabinet kan være uisoleret farlig spænding, der kan være så kraftig, at der er risiko for elektrisk stød.



En ligebenet trekant med et udråbstegn, som markeret på systemet, skal henlede brugerens opmærksomhed på vigtige betjenings- og vedligeholdelsesinstruktioner i denne brugervejledning.

- FORSIGTIG:** Dette produkt skal tilsluttes en stikkontakt med en beskyttende jordforbindelse.
- FORSIGTIG:** Undlad at foretage ændringer i systemet eller tilbehøret. Uautoriserede ændringer kan sætte sikkerheden, overholdelse af lovbestemmelser samt systemets ydeevne over styr.
- FORSIGTIG:** Der må ikke anbringes åben ild, f.eks. tændte stearinlys, på apparatet.
- FORSIGTIG:** Hvis netstikket anvendes som afbryder, skal denne afbryder være let at betjene.
- Bemærk!:** Dette produkt skal anvendes inden døre. Det er hverken designet eller testet til udendørs brug i fritidskøretøjer eller i lystbåde.







Dette produkt opfylder EØF-direktiv 89/336/EEC og Lavspændings-direktiv 73/23/EEC. Den fulde overensstemmelseserklæring finder du på adressen <http://www.bose.com/static/compliance/index.html>.

Bitte lesen Sie diese Bedienungsanleitung aufmerksam durch.

Beachten Sie sorgfältig die Hinweise in dieser Anleitung. Sie unterstützt Sie beim Aufbau und ordnungsgemäßen Betrieb des Systems und seiner modernen Funktionen. Bewahren Sie die Bedienungsanleitung zum späteren Nachschlagen auf.

- ⚠️ WARNUNG:** Um Brände und Stromschläge zu vermeiden, darf dieses Gerät weder Regen noch Feuchtigkeit ausgesetzt werden.
- ⚠️ WARNUNG:** Um Stromschläge zu vermeiden, darf dieses Gerät nur von qualifiziertem Personal zerlegt werden. Wenden Sie sich bei allen Reparatur- und Wartungsarbeiten nur an qualifiziertes Kundendienstpersonal.

	CAUTION RISK OF ELECTRICAL SHOCK DO NOT OPEN	
CAUTION: TO REDUCE THE RISK OF ELECTRIC SHOCK, DO NOT REMOVE COVER (OR BACK). NO USER-SERVICABLE PARTS INSIDE. REFER SERVICING TO QUALIFIED PERSONNEL.		

	VORSICHT STROMSCHLAGGEFAHR NICHT ÖFFNEN	
VORSICHT! ZUR VERMEIDUNG VON ELEKTRISCHEM SCHLAG DIE GEHÄUSEVORDER- ODER -RÜCKSEITE NICHT ABNEHMEN. GERÄT ENTHÄLT KEINE VOM BENUTZER ZU WARTENDEN TEILE. WARTUNG NUR VON QUALIFIZIERTEM SERVICEPERSONAL VORNEHMEN LASSEN.		



Das mit einer Pfeilspitze versehene Blitzsymbol in einem gleichseitigen Dreieck weist den Benutzer auf nicht isolierte, gefährliche elektrische Spannung innerhalb des Systemgehäuses hin. Es besteht die Gefahr von Stromschlägen!



Das Ausrufezeichen innerhalb des gleichseitigen Dreiecks macht den Anwender auf wichtige Bedienungs- und Wartungsanweisungen in diesem Benutzerhandbuch aufmerksam.

- ⚠️ ACHTUNG:** Dieses Produkt muss an eine Steckdose mit Erdungsschutz angeschlossen werden.
- ⚠️ ACHTUNG:** Nehmen Sie keine Veränderungen am System oder am Zubehör vor. Nicht autorisierte Veränderungen können die Sicherheit, die Erfüllung von Richtlinien und die Systemleistung beeinträchtigen.
- ⚠️ ACHTUNG:** Stellen Sie keine offenen Flammen wie brennende Kerzen auf das Gerät.
- ⚠️ ACHTUNG:** Falls zur Trennung des Geräts von der Stromversorgung der Netzstecker verwendet wird, muss sichergestellt sein, dass Sie jederzeit auf den Stecker zugreifen können.
- 🎵 Hinweis:** Das Gerät ist nicht zum Einsatz im Freien geeignet. Verwenden Sie das Gerät nur innerhalb von Gebäuden und nicht in Campingfahrzeugen, auf Booten o. ä.

CE Das Gerät entspricht der EMV-Richtlinie 89/336/EWG und der Niederspannungs-Richtlinie 73/23/EWG. Die vollständige Konformitätserklärung finden Sie unter www.bose.com/static/compliance/index.html.

INFORMACIÓN DE SEGURIDAD

Lea esta guía del usuario

Dedique el tiempo que sea necesario para seguir el contenido de esta guía del usuario cuidadosamente. Le ayudará a configurar y utilizar correctamente el sistema y a disfrutar de todas sus funciones avanzadas. Guarde la guía del usuario para utilizarla como material de referencia en el futuro.

⚠️ ADVERTENCIA: Con el fin de reducir el riesgo de descargas eléctricas, no exponga el sistema a la lluvia o la humedad.

⚠️ ADVERTENCIA: Para reducir el riesgo de descargas eléctricas, no desmonte el sistema si no es usted un técnico cualificado. Las reparaciones debe llevarlas a cabo personal cualificado.



 El símbolo de un relámpago con una flecha dentro de un triángulo equilátero indica al usuario que la carcasa del sistema puede contener elementos de voltaje sin aislar de magnitud suficiente para constituir un riesgo de descarga eléctrica.

 El signo de exclamación dentro de un triángulo equilátero avisa al usuario de la existencia de instrucciones de funcionamiento y de mantenimiento importantes en esta guía del usuario.

⚠️ PRECAUCIÓN: Este producto se debe conectar a una toma de la red eléctrica con una conexión de tierra que sirva de protección.

⚠️ PRECAUCIÓN: No realice modificaciones en el sistema o los accesorios. Las alteraciones no autorizadas pueden comprometer aspectos de seguridad, cumplimiento normativo y rendimiento del sistema.

⚠️ PRECAUCIÓN: No coloque sobre el aparato ninguna llama viva, como, por ejemplo, una vela.

⚠️ PRECAUCIÓN: Si se utiliza la clavija de red o el conector del aparato como dispositivo de desconexión, deberá poder utilizarse fácilmente.

🎵 Nota: Este producto debe utilizarse en espacios interiores. No está diseñado ni se ha probado para uso al aire libre o en embarcaciones.



CE Este producto cumple con la directiva sobre compatibilidad electromagnética 89/336/EEC y la directiva sobre límites de tensión 73/23/EEC. Podrá encontrar la declaración de conformidad completa en www.bose.com/static/compliance/index.html.



Veillez lire cette notice d'utilisation

Prenez le temps de lire attentivement les instructions de cette notice d'utilisation. Elles vous seront précieuses pour installer et utiliser correctement votre système et vous aideront à tirer le meilleur parti de sa technologie. Conservez cette notice d'utilisation pour référence ultérieure.

AVERTISSEMENT : Afin de limiter les risques d'incendie ou d'électrocution, n'exposez pas l'appareil à la pluie ou à l'humidité.

AVERTISSEMENT : Afin de limiter les risques d'électrocution, ne démontez pas ce système à moins de disposer des qualifications requises. Adressez-vous à un réparateur qualifié. Les marquages de SÉCURITÉ présentés sur cette page sont situés sur les boîtiers de votre système.

	CAUTION RISK OF ELECTRICAL SHOCK DO NOT OPEN	
CAUTION: TO REDUCE THE RISK OF ELECTRIC SHOCK, DO NOT REMOVE COVER (OR BACK). NO USER-SERVICABLE PARTS INSIDE. REFER SERVICING TO QUALIFIED PERSONNEL.		

	AVIS RISQUE DE CHOC ÉLECTRIQUE NE PAS OUVRIR	
ATTENTION : POUR RÉDUIRE LE RISQUE DE DÉCHARGE ÉLECTRIQUE, NE RETIREZ PAS LE COUVERCLE (OU L'ARRIÈRE). IL NE SE TROUVE À L'INTÉRIEUR AUCUNE PIÈCE POUVANT ÊTRE RÉPARÉE PAR L'USAGER. S'ADRESSER À UN RÉPARATEUR COMPÉTENT.		



Le symbole représentant un éclair avec une flèche à l'intérieur d'un triangle équilatéral est utilisé pour prévenir l'utilisateur de la présence d'une tension électrique dangereuse non isolée à l'intérieur de l'appareil. Cette tension est d'un niveau suffisamment élevé pour représenter un risque d'électrocution.



Le symbole représentant un point d'exclamation à l'intérieur d'un triangle équilatéral, tel qu'il figure sur le système, signale à l'utilisateur la présence d'instructions importantes relatives au fonctionnement et à l'entretien de l'appareil dans cette notice d'installation.

ATTENTION : Cet appareil doit être connecté à une prise électrique dotée d'une mise à la terre.

ATTENTION : N'apportez aucune modification au système ou aux accessoires. Toute modification non autorisée peut compromettre votre sécurité, le respect des réglementations et les performances.

ATTENTION : Ne placez jamais d'objets enflammés, tels que des bougies allumées, sur l'appareil.

ATTENTION : Lorsque la fiche d'alimentation est utilisée comme dispositif de débranchement de l'appareil, elle doit rester facilement accessible.

Remarque : Cet appareil doit être utilisé à l'intérieur. Il n'a pas été conçu ni testé pour une utilisation en extérieur, dans des véhicules ou sur des bateaux.



Ce produit est conforme à la directive CEM 89/336/CEE et à la directive sur les basses tensions 73/23/CEE. La déclaration complète de conformité est disponible sur le site Web www.bose.com/static/compliance/index.html.

INFORMAZIONI SULLA SICUREZZA

Legga questa guida per l'utente

Segua scrupolosamente le istruzioni riportate in questa guida, che consentono di configurare e utilizzare correttamente il sistema e sfruttare appieno tutte le funzionalità avanzate di cui dispone. Conservi la guida per l'utente quale riferimento per il futuro.

AVVERTENZA: per ridurre il rischio di incendio o di scosse elettriche, il sistema non deve essere esposto a pioggia o umidità.

AVVERTENZA: per ridurre il rischio di scosse elettriche, il sistema deve essere smontato solo da una persona qualificata. Si affidi a personale qualificato per tutti gli interventi di assistenza. Questi segnali di ATTENZIONE sono presenti sulle superfici esterne del sistema.

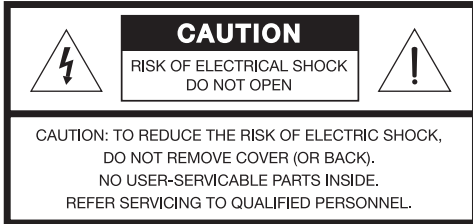

Il simbolo del fulmine con la punta a freccia all'interno di un triangolo equilatero mette in guardia l'utente contro tensioni pericolose non isolate all'interno del telaio del sistema, di entità tale da presentare un potenziale pericolo di scossa elettrica.



Il simbolo del punto esclamativo racchiuso all'interno di un triangolo equilatero, che appare sul sistema, rimanda l'utente alla lettura delle importanti istruzioni di uso e manutenzione contenute in questo manuale.

ATTENZIONE: questo prodotto deve essere collegato a una presa di corrente dotata di un impianto protettivo di messa a terra.

ATTENZIONE: non apportare modifiche al sistema o agli accessori, in quanto le modifiche non autorizzate possono compromettere la sicurezza, la conformità alle norme e le prestazioni del sistema.

ATTENZIONE: non collochi sull'apparecchio candele accese o altre sorgenti di fiamme libere.

ATTENZIONE: a spina dell'alimentazione deve essere raggiungibile facilmente e rapidamente se è utilizzata come dispositivo di spegnimento.

Nota: questo prodotto è destinato all'utilizzo in ambienti interni. Non è stato progettato né collaudato per l'uso in ambienti esterni, camper o imbarcazioni.



Questo prodotto è conforme alla Direttiva 89/336/CEE sulla compatibilità elettromagnetica e alla Direttiva 73/23/CEE sui dispositivi a bassa tensione. La dichiarazione di conformità completa è disponibile all'indirizzo www.bose.com/static/compliance/index.html.

De gebruikershandleiding doorlezen

Neem a.u.b. de tijd om de instructies in deze gebruikershandleiding zorgvuldig door te nemen. Op deze manier kunt u uw systeem correct installeren en bedienen en genieten van alle geavanceerde functies. Bewaar uw gebruikershandleiding voor toekomstig gebruik.

- WAARSCHUWING:** Ter voorkoming van brand en elektrische schokken mag het systeem niet aan regen of vocht worden blootgesteld.
- WAARSCHUWING:** Demonteer dit systeem niet tenzij u hiervoor gekwalificeerd bent om de kans op elektrische schokken te vermijden. Laat onderhoud en service over aan gekwalificeerd onderhoudspersoneel. De waarschuwingen die hier worden getoond bevinden zich op de behuizingen van uw systeem.

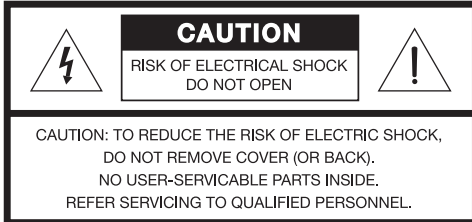

De bliksemschicht met een pijl in een driehoek waarschuwt de gebruiker voor de aanwezigheid van gevaarlijke niet-geïsoleerde spanning in de systeembehuizing, waardoor er kans op elektrische schokken bestaat.



Het uitroepteken in de driehoek dat is afgebeeld op het systeem maakt de gebruiker attent op belangrijke bedienings- en onderhoudsinstructies in deze gebruikershandleiding.

- WAARSCHUWING:** Dit product moet worden aangesloten op een geaard stopcontact.
 - WAARSCHUWING:** Voer zelf geen wijzigingen door aan het systeem of de accessoires. Ongeoorloofde wijzigingen kunnen de veiligheid, de naleving van reglementen en de prestaties van het systeem in gevaar brengen.
 - WAARSCHUWING:** Er mogen geen open vlammen zoals aangestoken kaarsen op het apparaat worden geplaatst.
 - WAARSCHUWING:** Daar waar de netstekker als uitschakelingsapparaat wordt gebruikt, dient een dergelijk apparaat gereed te zijn voor bediening.
- Opmerking:** Dit product moet binnenshuis worden gebruikt. Het is niet ontwikkeld of getest voor gebruik buitenshuis, in recreatievoertuigen of op boten.



Dit product voldoet aan de EMC-richtlijn 89/336/EEC en bepalingen van de richtlijn inzake lage spanning 73/23/EEC. De volledige conformiteitsverklaring kunt u vinden op www.bose.com/static/compliance/index.html.

SÄKERHETSINFORMATION

Läs denna användarhandbok

Ta dig tid att göra som det står i användarhandboken. Den hjälper dig att installera och använda systemet på rätt sätt och utnyttja de avancerade funktionerna. Spara användarhandboken för framtida bruk.

⚠ VARNING: Minska risken för brand eller elektriska stötar genom att inte utsätta systemet för regn eller fukt.

⚠ VARNING: Minska risken för brand eller elektriska stötar genom att inte montera isär systemet såvida du inte är kvalificerad för detta. Låt underhåll utföras av kvalificerad servicepersonal. VARNINGS-märkena som visas här finns på systemets höljen.

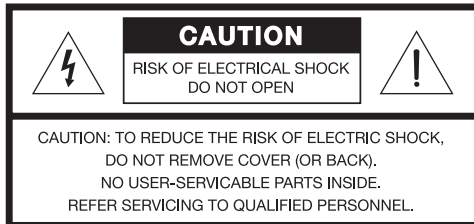

Blixten med pilhuvudssymbolen i en likbent triangel uppmärksammar användaren på att det finns oisolerad farlig spänning i systemet som kan vara tillräckligt stark för att innebära risk för elektriska stötar.



Utropstecknet i en triangel som finns på systemet är avsedd att uppmärksamma användaren på att det finns viktiga användnings- och underhållsanvisningar i den här användarhandboken.

⚠ VARNING: Den här produkten ska anslutas till ett skyddsjordat eluttag.

⚠ VARNING: Ändra inte systemet eller tillbehören på något sätt. Otillåtna ändringar kan äventyra säkerheten, efterlevandet av bestämmelser samt systemets prestanda.

⚠ VARNING: Ingen öppen eld, t.ex. tända stearinljus, får placeras på apparaten.

⚠ VARNING: När huvuduttaget används för frånkoppling måste frånkopplingen fortfarande kunna användas.

🎵 Obs!: Produkten får endast användas inomhus. Den är varken utformad eller testad för användning utomhus, i fritidsfordon eller marina miljöer.



Denna produkt uppfyller EMC-föreskriften i EU-direktiv 89/336/EEC och lågspänningsföreskriften i EU-direktiv 73/23/EEC. Den kompletta konformitetsdeklarationen finns på www.bose.com/static/compliance/index.html.

INTRODUCTION 4

- Welcome 4
- Features and benefits 4
- Product overview 5
- Connections and controls 6

SYSTEM SETUP 7

- Parts list 7
- Positioning your system 8
- Setting up the L1™ model II power stand 9
- Assembling the L1 model II Cylindrical Radiator® loudspeaker 9
- Connecting to AC power 10
- Connecting the B1 bass module 11
- Adding a T1 ToneMatch™ audio engine (optional) 12
- Adding a second B1 bass module (optional) 13
- Adding a PackLite® power amplifier model A1 (optional) 14

OPERATING INFORMATION 15

- Setting the analog input level 15
- Using a T1 ToneMatch™ audio engine and an analog input source 15
- User scenarios 15
 - Single musician 15
 - Multiple musicians 16
 - Full band 17
 - DJ events 18

CARE AND MAINTENANCE 19

- Caring for your product 19
 - Cleaning 19
 - Getting service 19
- Troubleshooting 19
- Limited Warranty and Registration 21
- Accessories 21
- Technical Information 21
 - Mechanical 21
 - Electrical 21
 - Audio Input/Output 21

INTRODUCTION

Welcome

Thank you for purchasing the Bose® L1™ model II system with ToneMatch™ port. Based on a revolutionary new technology, this system brings the benefits of an intimate acoustic concert to amplified performance.

This owner's guide provides detailed setup and operating instructions for your L1™ model II system and explains how to connect equipment to it.

For additional information on using this system, including tips, techniques, and frequently asked questions, please visit www.Bose.com/musicians on the Internet.

Features and benefits

- **You control the sound** – Just as in an unamplified performance, you control the sound. You will no longer wonder how you sound to your fellow musicians or to your audience because you will hear what they hear.
- **Quick and easy setup** – The L1 model II system is easy to carry and can be set up in minutes, not hours. This frees you from the time-consuming and often frustrating effort required to properly set up conventional sound equipment.
- **Dramatically improved performance** – Compared to using conventional equipment, performance and enjoyment dramatically improve because the struggle to hear yourself and the other musicians is diminished.
- **Creates excitement and emotion** – Enhanced performance of the musicians creates the kind of excitement and emotion that is valued by music lovers.
- **You hear what the audience hears** – For the first time, musicians hear what their audiences hear and thus, are less likely to play at uncomfortable sound levels.
- **The music is naturally dynamic** – The softest to the most intense passages can be heard and enjoyed.
- **Improves your appearance** – There is less equipment on the stage and more room.
- **Sound reproduction unlike before** – Audience members report that the clarity and excitement that come from hearing the accurate reproduction of sound from each instrument, and from hearing the sound of each instrument in its position on stage (as opposed to mono or even stereo mix of all instruments), is unlike anything they have heard before in an amplified performance.

Product overview

The L1™ model II system – with ToneMatch™ port consists of the L1 model II power stand, the L1 model II Cylindrical Radiator® loudspeaker, and a B1 bass module. The L1 model II system comes with a padded carrying bag for each of its parts.

To expand your system and enhance performance, you can add:

- A second B1 bass module for bass guitar, kick drum, or organ. Each power stand can power up to two B1 bass modules.
- A T1 ToneMatch audio engine for digital signal processing, additional inputs and user-interface control.
- A PackLite® power amplifier model A1 for adding up to two more B1 bass modules to your system.

For a complete list of optional equipment and accessories, please visit: www.Bose.com/musicians.

Figure 1

L1 model II system and optional equipment

L1 model II system with ToneMatch port

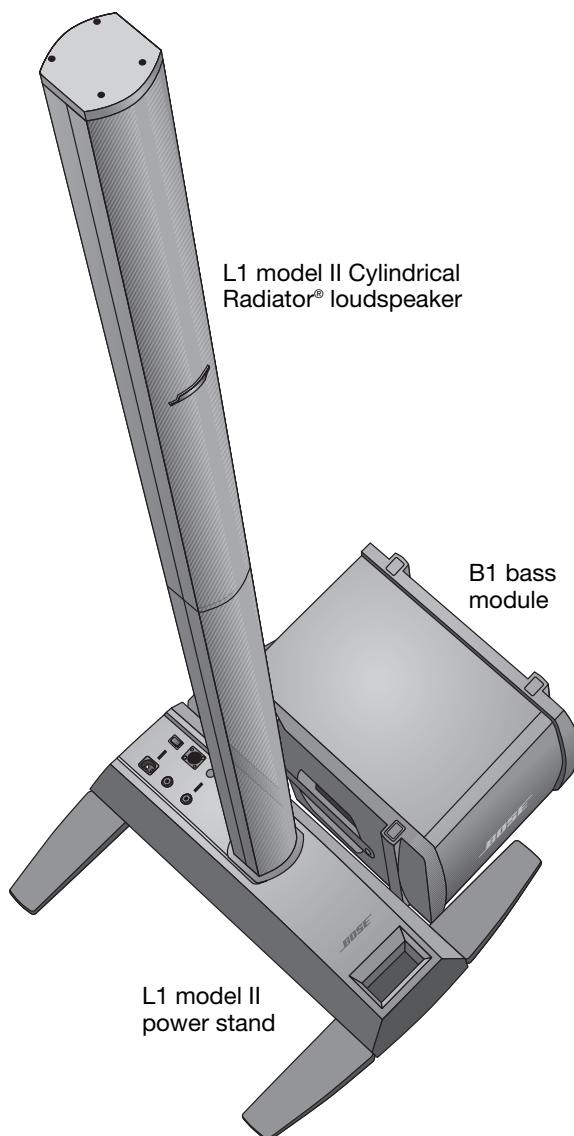

Optional equipment

T1 ToneMatch audio engine

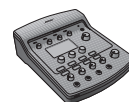

Additional B1 bass module

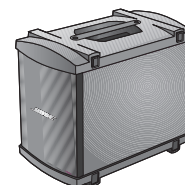

PackLite power amplifier model A1

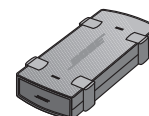

Connections and controls

The top panel of the power stand provides system connectors and controls (Figure 2).

Figure 2



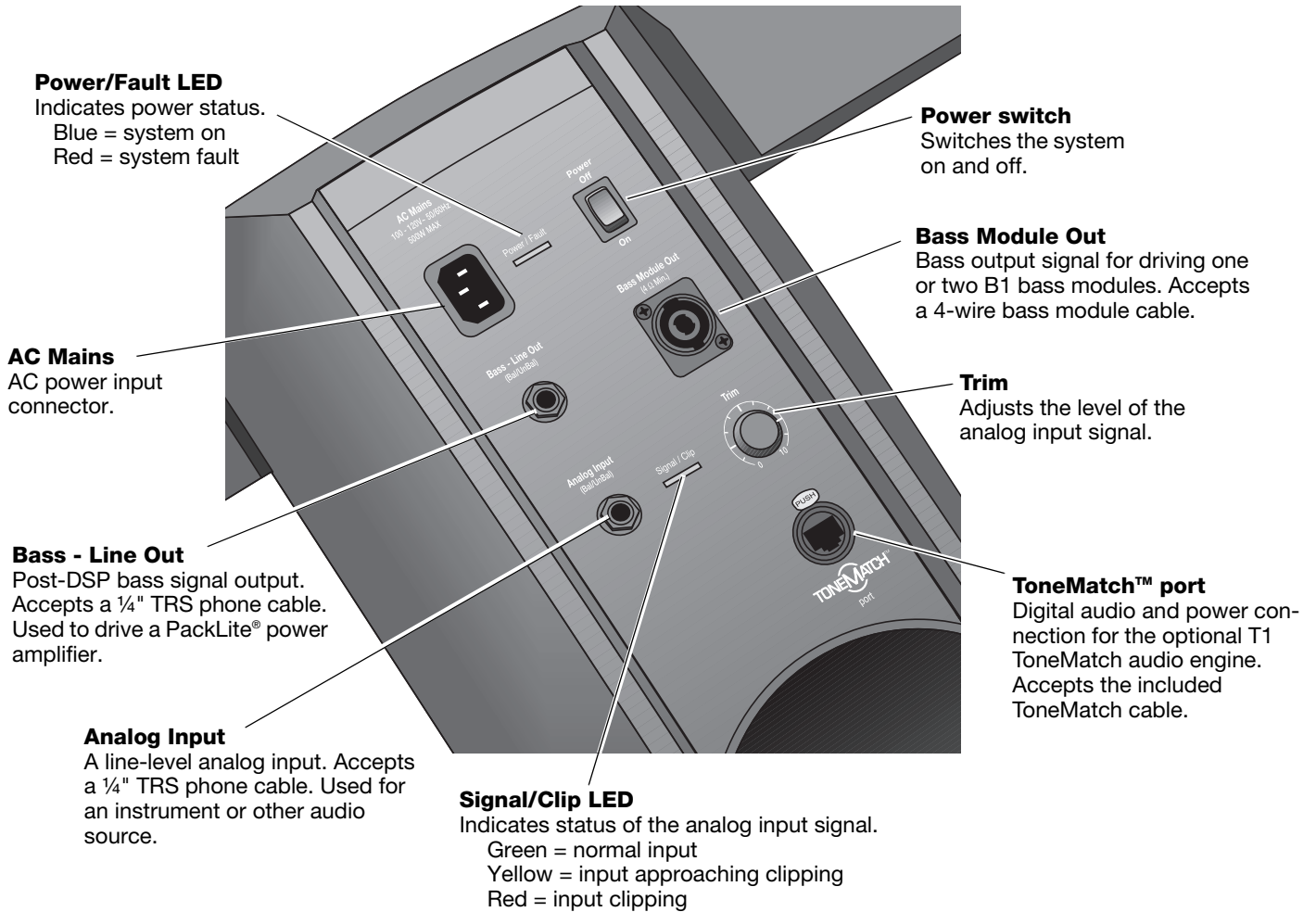





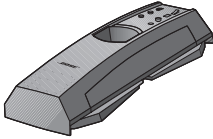
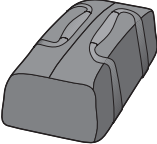

Power stand top panel

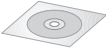

Parts list

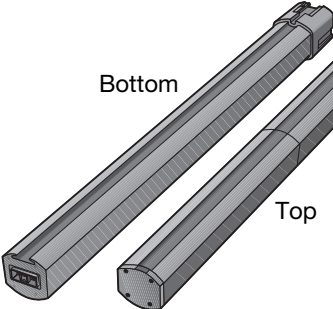
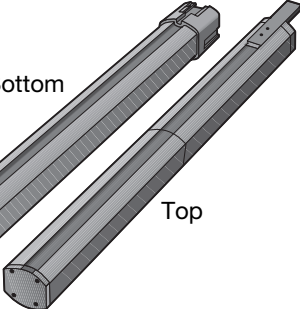
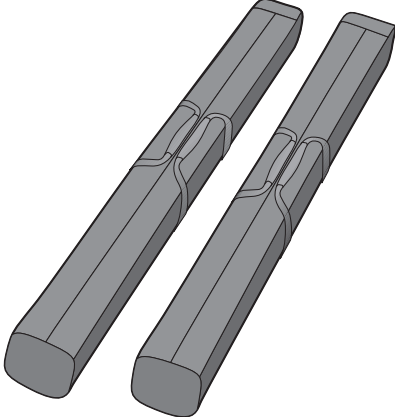
The L1™ model II system is shipped in three cartons. Carefully unpack the cartons and check that you have all the items listed on this page.

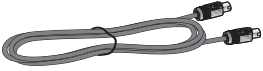
WARNING: To avoid danger of suffocation, keep the plastic bags out of the reach of children.

Power stand carton	Cylindrical Radiator® carton	B1 bass module carton
<p>L1 model II power stand</p>  <p>Carrying bag</p>  <p>AC power cord</p>  <p>Demonstration CD</p>  <p>Quick setup guide</p>  <p>Owner's guide</p>  <p>Product registration card</p> 	<p>L1 model II Cylindrical Radiator® loudspeaker</p> <p>Bottom</p>  <p>Top</p>  <p>Carrying bags</p> 	<p>B1 bass module</p>  <p>Carrying case</p>  <p>Bass module cable (blue 4-wire)</p>  <p>B1 bass module owner's guide</p> 

Serial numbers and product registration

Now is a good time to record the serial numbers of your system here and on your product registration card. You can register your product online at www.Bose.com/register or call (800) 905-1044. Failure to do so will not affect your warranty rights.

L1 model II power stand _____

L1 model II Cylindrical Radiator® loudspeaker _____

B1 bass module _____

Positioning your system

Placing the power stand in the right location is an important part of setting up this product. Determining the best location for your performance depends on several things.

- Size of staging area
- Number of performers
- Shared system (adding a T1 ToneMatch™ audio engine and multiple instruments)

The following guidelines should get you started in setting up for a concert or show.

- Set up your system in the rear area of the performance stage.
- If possible, position your system behind the performer(s).
- If you are part of a group, avoid crowding together on stage. Allow some distance, ideally 7-8 feet (2.1-2.4 m), between you and the L1™ model II system and another performer. This allows the sound to wrap around performers and reflect off adjacent surfaces of the room, creating a more pleasing room-filling sound.

Figure 3

Placement recommendations

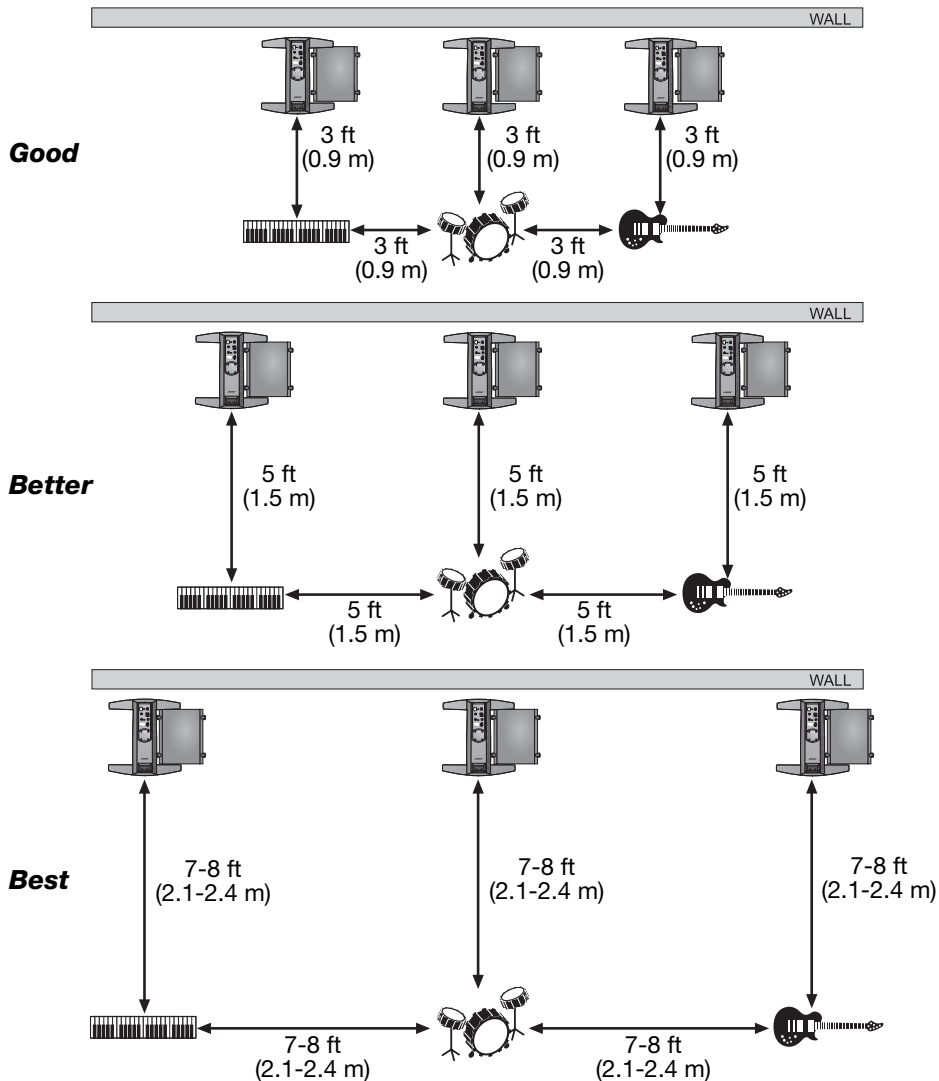

Setting up the L1™ model II power stand

1. Holding the power stand vertically on the foot (Figure 4A), grasp one leg and swing it out as far as it will go. Notice that the other legs swing out automatically. **The legs must be fully open before you can plug the L1™ bottom section into the power stand.**
2. Lay the power stand flat on the floor in the desired position (Figure 4B).

Figure 4

Putting the power stand on the floor

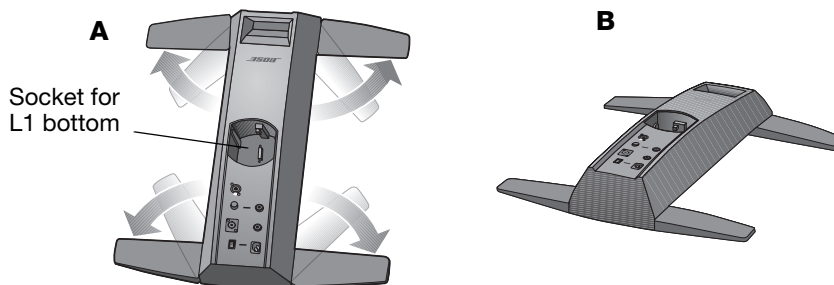

WARNING: DO NOT move the completely assembled system as a unit. This could result in personal injury and/or damage to the product. Position the power stand on the floor in the chosen location before assembling the system.

Assembling the L1 model II Cylindrical Radiator® loudspeaker

This procedure tells you how to set up the loudspeaker sections in the power stand. If you plan to mount the T1 ToneMatch™ audio engine on the L1 model II system, see “Adding a T1 ToneMatch™ audio engine (optional)” on page 12 before installing the top section of the loudspeaker.

1. Hold the L1 bottom so that the grille faces front and plug it into the power stand (Figure 5A). Be sure to fully insert it into the socket to assure stability and a good connection.
2. Align the bayonet on the L1 top with the channel on the back of the L1 bottom, and lower the L1 top onto the L1 bottom until it is flush (Figure 5B).

Figure 5

Setting up the L1 model II Cylindrical Radiator® loudspeaker top and bottom

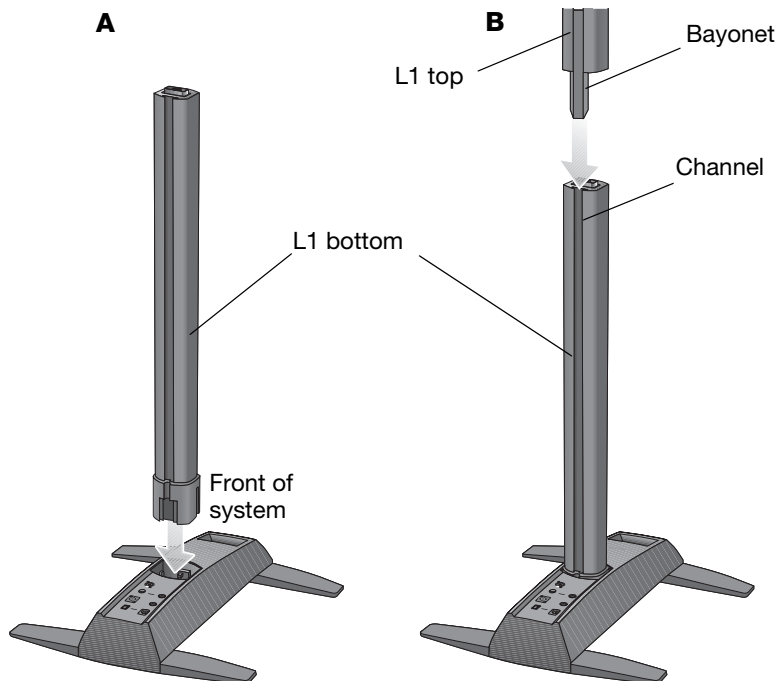

Connecting to AC power

1. Make sure the power switch is off.
2. Plug one end of the AC power cord into the **AC Mains** connector on the power stand.
3. Plug the other end into a live AC (mains) receptacle (Figure 6).

Figure 6

Power connections

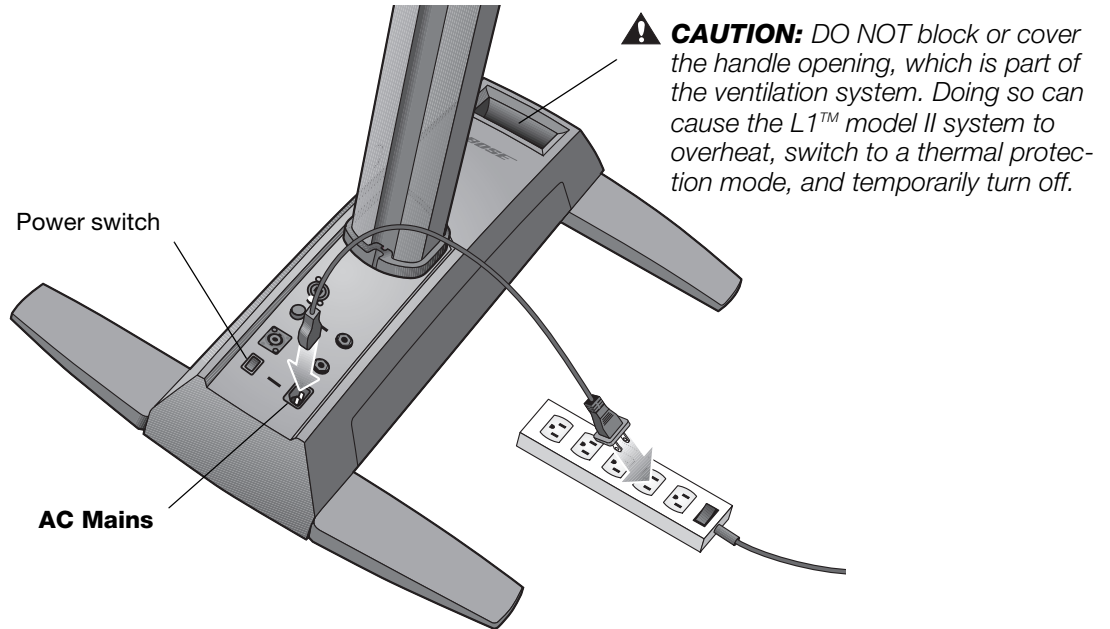

CAUTION: Bose recommends using a quality surge suppressor on all electronic equipment. Voltage variations and spikes can damage electronic components in any system. A quality suppressor, which can eliminate the vast majority of failures attributed to surges, may be purchased at electronics stores.

Connecting the B1 bass module

You can place the B1 bass module either vertically or horizontally on the floor. It fits neatly between the legs of the power stand.

1. Plug one end of the B1 bass module cable into one of the B1 connectors. Rotate the plug clockwise to lock it in place. You should hear a soft click as it locks.
2. Plug the other end of the cable into the **Bass Module Out** connector on the power stand. Rotate the plug clockwise to lock it.

🎵 **Note:** To disconnect a B1 cable, slide back the metal tab on the body of the plug, rotate the plug counterclockwise, and pull it out of the connector.

Figure 7

B1 bass module

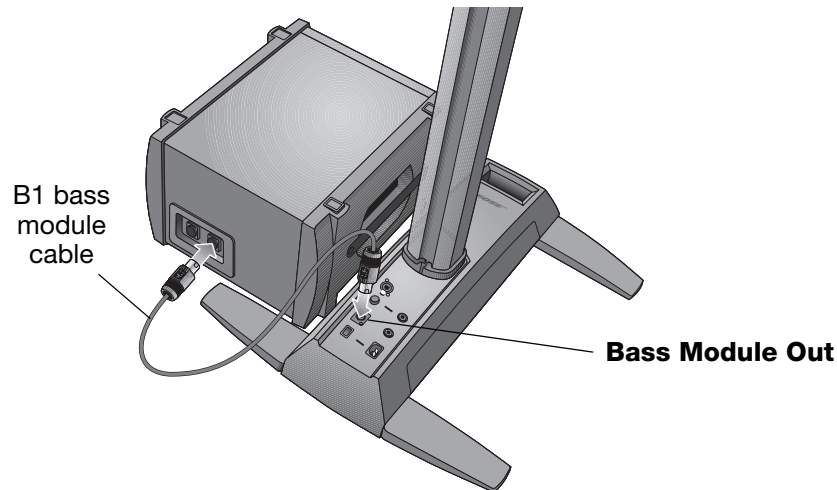

⚠️ CAUTIONS:

- DO NOT connect a B1 bass module to two power stands at the same time.
- DO NOT connect any bass module other than the B1 to the power stand.
- DO NOT substitute the supplied cable with a 2-wire speaker cable. Use only the supplied B1 bass module 4-wire cable to connect the B1 bass module to the power stand. The power stand uses the signals on two of the wires to automatically sense how many B1 bass modules are connected.

Adding a T1 ToneMatch™ audio engine (optional)

The T1 ToneMatch™ audio engine provides additional input/output capabilities to your system, plus digital signal processing to customize the way you sound. The audio engine comes with hardware for mounting it on the left or right side of the L1™ model II Cylindrical Radiator® loudspeaker.

🎵 **Note:** The audio engine mounts on the bottom section of the loudspeaker and requires removal of the top section before starting this procedure.

1. Slide the carriage into the channel on the rear of the L1 bottom and turn the knob clockwise to lock it in place (Figure 8).
2. Insert the mounting bar into the slot in the carriage and push it downward.
3. Place the T1 on the mounting bar as shown.
4. Plug one end of the ToneMatch cable (supplied with the audio engine) into the ToneMatch output port (M) on the T1.
5. Using the hook and loop strap, secure the cable to the carriage.
6. Plug the other end of the cable into the ToneMatch port on the power stand.

Figure 8

Mounting the T1

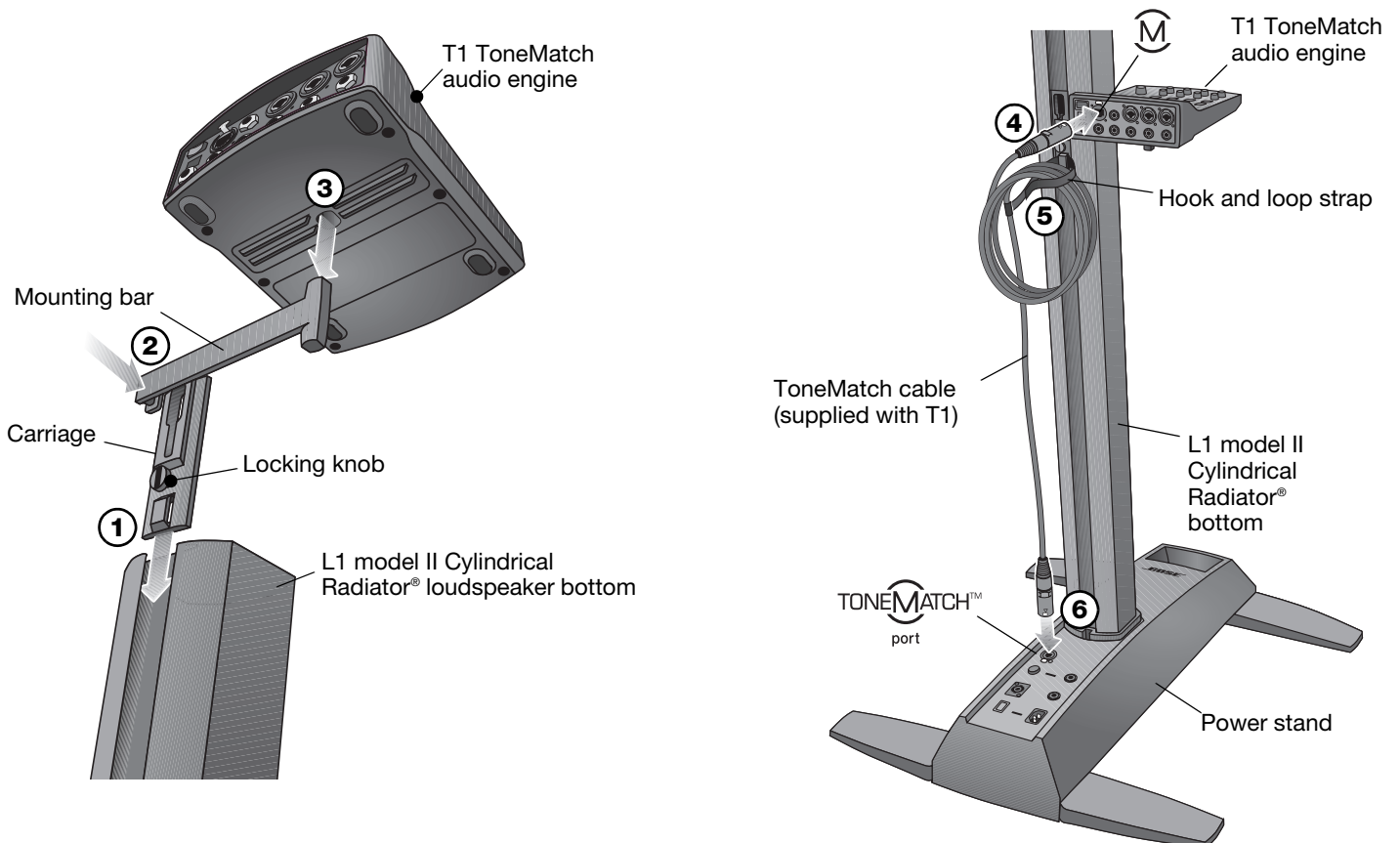

Adding a second B1 bass module (optional)

The bass module output of the power stand can adequately drive one or two B1 bass modules. When placed horizontally, the modules are stackable (Figure 9).

One or two additional B1 modules can be added with the use of a PackLite® power amplifier. Refer to “Adding a PackLite® power amplifier model A1 (optional)” on page 14.

⚠ CAUTION: Do not connect more than two B1 bass modules to the **Bass Module Out** connector on the power stand. Driving more than two B1 bass modules from this output improperly loads the amplifier in the power stand, resulting in less than full system performance.

1. Connect the first B1 to the **Bass Module Out** connector on the power stand.
2. Plug one end of the second B1 cable into the unused connector of the first B1. Plug the other end of the cable into one of the connectors of the second B1.

Figure 9

Installation of two B1 bass modules

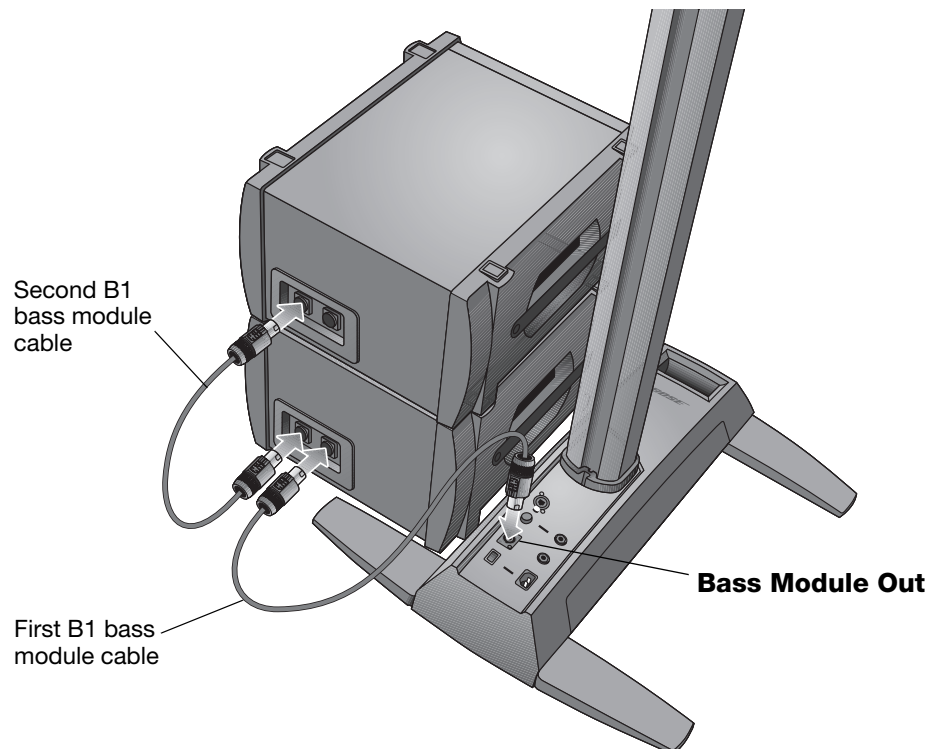

Adding a PackLite® power amplifier model A1 (optional)

Using a PackLite® power amplifier model A1 allows you to add one or two additional B1 modules to your system. Refer to the A1 owner's guide for detailed operating instructions.

1. Make sure the A1 amplifier power switch is OFF.
2. Plug one end of the supplied ¼" TRS cable into the **Bass - Line Out** connector on the power stand. Plug the other end into the **INPUT** connector on the A1 amplifier.
3. Connect a B1 bass module cable from the **OUTPUT** connector on the A1 to a B1 bass module. If desired, connect a second B1 to the first B1.
4. Plug one end of the AC power cord into the A1 amplifier and plug the other end into an AC (mains) outlet.
5. Switch the A1 power switch to ON (I).

Figure 10

Connecting the A1 amplifier to the power stand

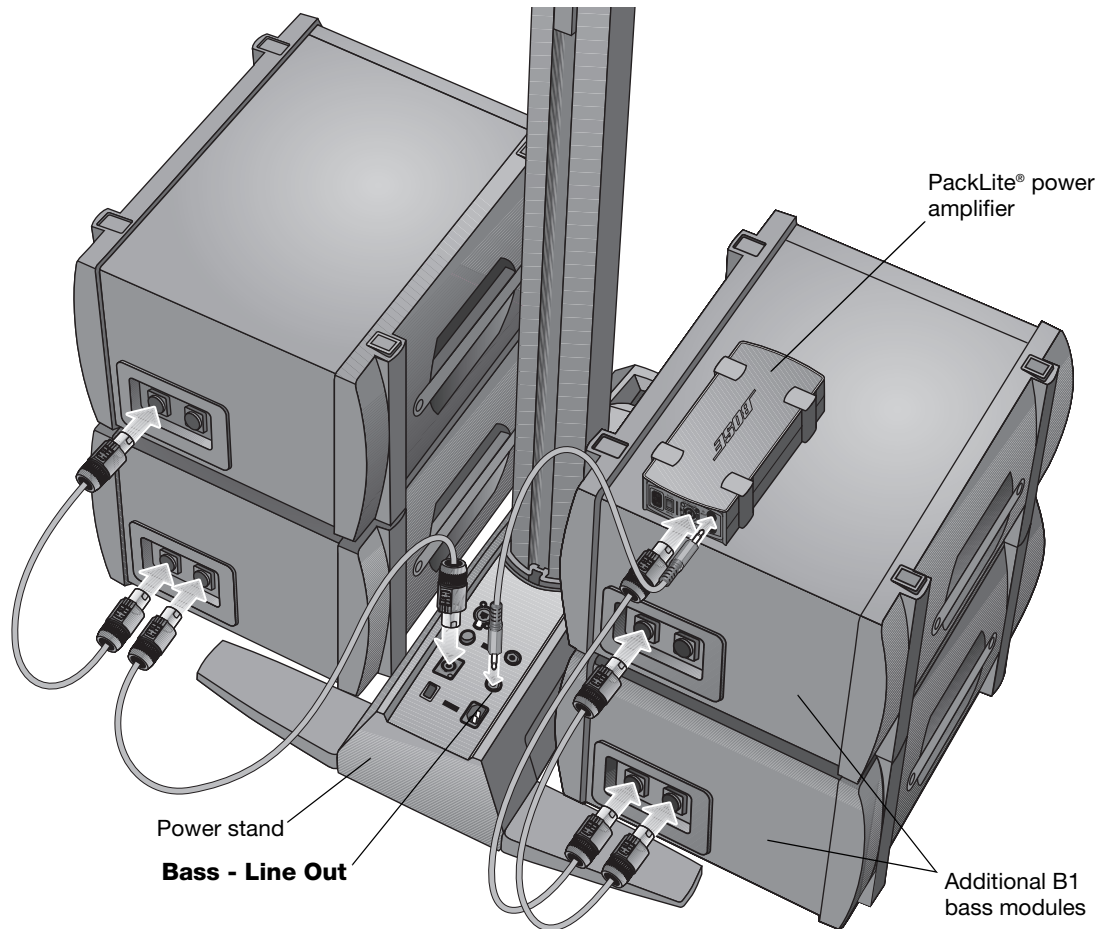

CAUTION: DO NOT stack more than four B1 modules in a column.

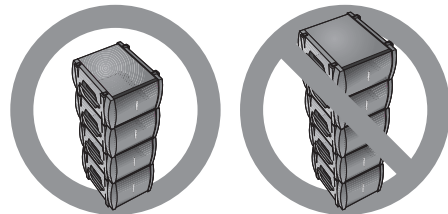

Setting the analog input level

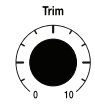

When connecting an audio source to the **Analog Input**, follow these steps to adjust the input **Trim** control.

1. Set the **Trim** control on the power stand to the 0 (zero) position.
2. Connect the audio source to the **Analog Input**.
3. Adjust the volume of the audio source to the desired level.
4. While playing the source, increase the **Trim** level until the **Signal/Clip** indicator glows green or yellow.
5. If the **Signal/Clip** indicator glows red, decrease the **Trim** level so that it glows only green or yellow.

Using a T1 ToneMatch™ audio engine and an analog input source

The L1™ model II system can operate with both a T1 ToneMatch™ audio engine and an analog audio source connected to the power stand. However, keep in mind that the volume level of the audio engine and the analog audio source is adjusted independently.

- The power stand **Trim** control only affects the volume level of the analog audio source connected to the **Analog Input**. Therefore, the **Signal/Clip** indicator indicates the status only of the analog input signal.
- The T1 ToneMatch audio engine has a **Trim** control and signal/clip indicator for each input, a **Volume** control for each output channel, and a **Master** volume control that adjusts the level of the ToneMatch output sent to the power stand. These controls have no effect on the signal fed to the **Analog Input**.

User scenarios

There are many ways to set up and use this system with and without the T1 ToneMatch audio engine. The following pages show examples of some typical user scenarios. When using the T1 ToneMatch audio engine, refer to its owner's guide for more information on setup and operation.

Single musician

A solo musician might play a single instrument through the L1 model II system (Figure 11). A solo musician also might play an instrument and use a microphone for vocals (Figure 12 on page 16).

Figure 11

Single L1 model II system with keyboard

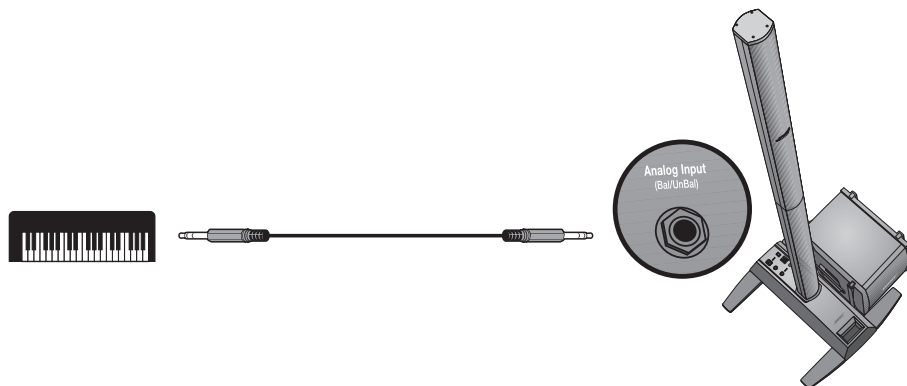
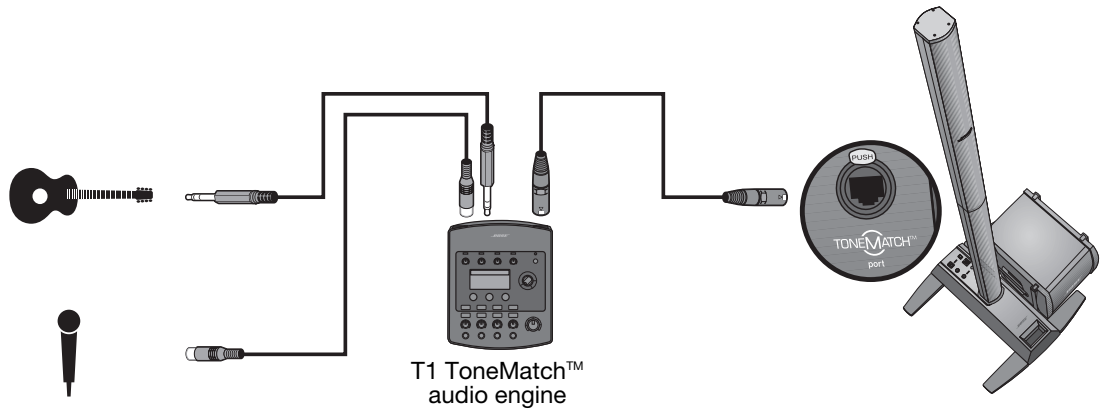

Figure 12

Single L1™ model II system with guitar and microphone



Multiple musicians

In this scenario, a keyboard-guitar duo sings and plays through a single T1 ToneMatch audio engine and an L1 model II system.

Figure 13

Single L1 model II system with multiple instruments and T1 ToneMatch audio engine

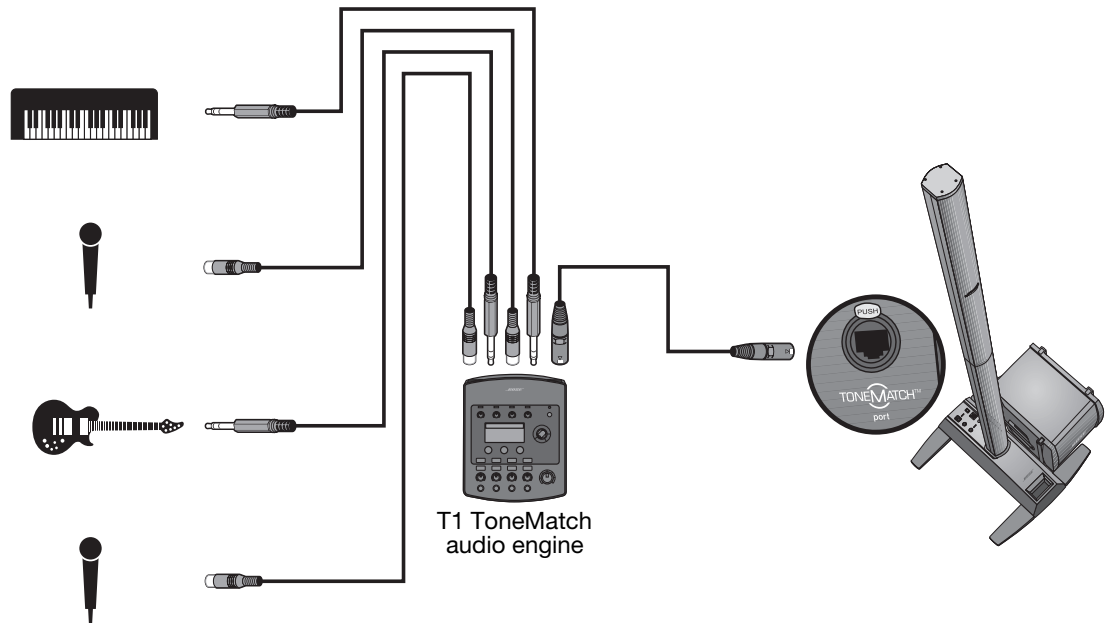

Full band

A full band scenario is built around multiple T1 ToneMatch™ audio engines and L1™ model II systems. Each musician plays and sings through a single T1 ToneMatch audio engine and L1 model II system.

Figure 14

Multiple L1 model II systems, each with a T1 ToneMatch audio engine

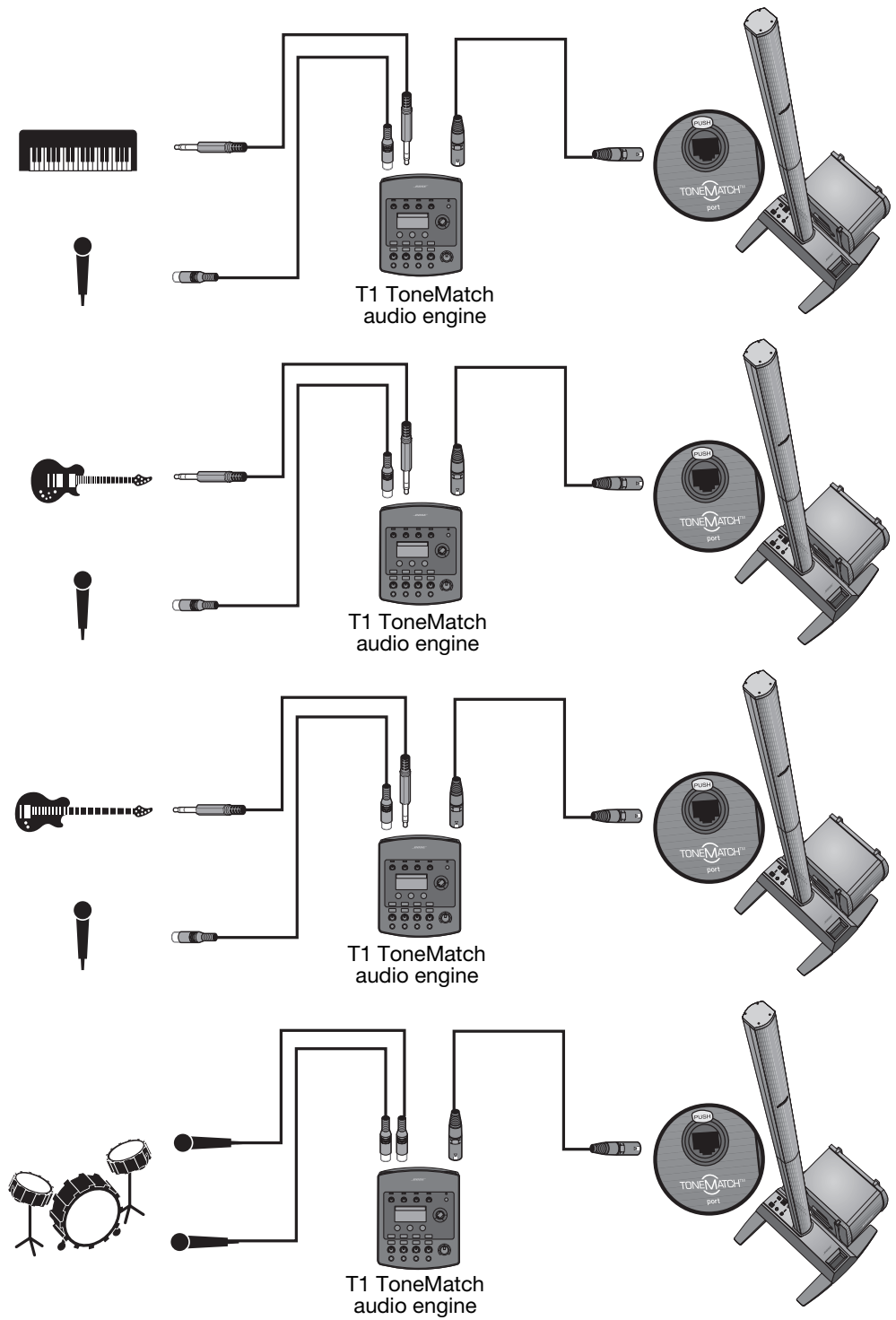

DJ events

DJs use many types of input sources (CD player, turntable, MP3 player, etc.) plugged into a mixer. In this scenario, two mixer outputs can be fed into two L1™ model II systems for stereo sound.

Figure 15

Two L1 model II systems, a mixer, and input devices

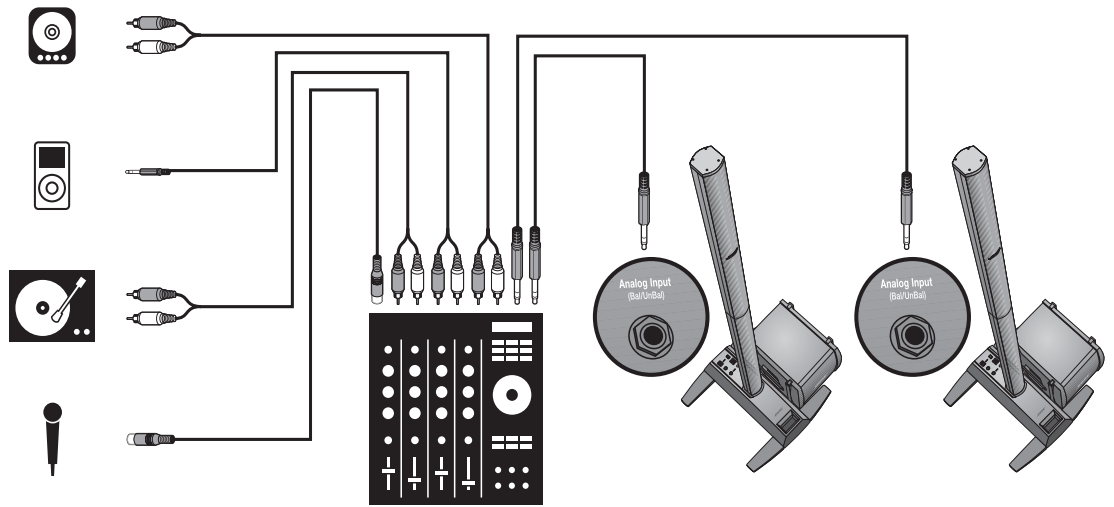

Caring for your product

Cleaning

- Clean the product enclosures using only a soft, dry cloth.
- Do not use any solvents, chemicals, or cleaning solutions containing alcohol, ammonia, or abrasives.
- Do not use any sprays near the product or allow liquids to spill into any openings.
- If necessary, you may carefully vacuum the grille of the L1™ model II Cylindrical Radiator® loudspeaker.

Getting service

For additional help in solving problems, contact Bose® Live Music Customer Service Product and Technical Support Team at (877) 335-2673 or visit our support area online at www.Bose.com/musicians.

Troubleshooting

If you experience problems while using this product, try the following solutions. If you still can't solve the problem, please call the Bose Live Music Product and Technical Support Team direct at (877) 335-2673 to arrange for service.

Recommended troubleshooting tools

- Portable voltmeter
- Cable tester
- AC outlet tester
- XLR and ¼" phone plug cables
- B1 bass module 4-wire cable
- Spare AC power cord

Problem	What to do
System is plugged in, power switch is on, but power LED is off	<ul style="list-style-type: none"> • Make sure you have power at the AC outlet. Try operating a lamp or other equipment from the same AC outlet or test the outlet using an AC outlet tester. • Make sure the power stand's power cord plug is fully inserted into the AC outlet.
Power LED is on (green), but no sound	<ul style="list-style-type: none"> • Make sure volume control is turned up on your instrument. • Make sure the Trim level control is turned up on the power stand. • Make sure your instrument is plugged into the Analog Input jack. • Connect your instrument to the power stand using a different cable. • Plug your instrument into a different amplifier to make sure the instrument is working.
Power LED is red while the power stand is on	<ul style="list-style-type: none"> • Please call Bose Live Music Customer Support at (877) 335-2673 for assistance.
House circuit breaker keeps tripping	<ul style="list-style-type: none"> • If more than one power stand is plugged into the same AC circuit, stagger the turn-on times. Each power stand has an inrush current of about 32 amps when turned on. • If you have more than three power stands plugged into a single 15 amp circuit, move some systems to another AC circuit. Each power stand can draw 5 amps or more when playing at high volumes for long periods of time.

CARE AND MAINTENANCE

Problem	What to do
With nothing plugged into the power stand, a slight <i>hum</i> or <i>buzz</i> is heard	<ul style="list-style-type: none"> • Using an AC outlet tester, test the AC outlet that the power stand is plugged into for reversed or open (hot, neutral, and/or ground) contacts. • If using an extension cord, make sure that the cord is also tested as above.
B1 bass module is plugged in, but no bass audio is heard	<ul style="list-style-type: none"> • Make sure you are using the included 4-wire B1 bass module cable. • Make sure the B1 bass module cable is plugged into the Bass Module Out connector and the cable plug is fully engaged in the connector. • Try a different 4-wire cable. • If available, try a different B1 bass module.
B1 bass module sounds out of balance with the system	<ul style="list-style-type: none"> • Make sure you are using the B1 bass module 4-wire cable included with the B1 bass module package. • Make sure that the B1 bass module grille is facing forward toward the musicians and audience.
No mid/high sounds heard from the L1™ model II Cylindrical Radiator® loudspeaker	<ul style="list-style-type: none"> • Make sure the L1 model II Cylindrical Radiator® loudspeaker top and bottom are firmly seated in their connectors. • Make sure connections are not bent or broken. • Try cleaning the contacts on the loudspeaker top and bottom with electronic contact spray cleaner.
Instrument or audio source sounds distorted	<ul style="list-style-type: none"> • Make sure the Signal/Clip LED is not constantly red. If it is, lower the trim level. • Try a different source or instrument. • Try your source or instrument on another power stand.
Third-party-powered subwoofer sounds poor when connected to the Bass - Line Out connector on the power stand	<ul style="list-style-type: none"> • Unplug any B1 bass modules that may be connected to the power stand. • The signal from the Bass - Line Out may be too high for the powered subwoofer; try attenuating the signal using commercially available direct boxes or in-line pad devices. • Try different connections to the third-party-powered subwoofer, such as balanced or unbalanced cabling and/or a direct box. • Check that the gain and input controls on the third-party-powered subwoofer are set appropriately. • If using a powered subwoofer with an adjustable crossover, set the crossover to 180Hz.
B1 bass modules powered by a third-party power amplifier and connected to the Bass - Line Out connector sounds poor	<ul style="list-style-type: none"> • Ensure that at least two B1 bass modules are directly connected to the Bass Module Out connector on the power stand using a B1 bass module 4-wire cable. • Check the gain settings on the third-party power amplifier. The volume level of the B1 bass modules powered by the power stand should be similar to the bass modules powered by the external amplifier.
Microphone is encountering feedback	<ul style="list-style-type: none"> • Orient the microphone so that it is not pointing directly at its respective L1 model II Cylindrical Radiator® loudspeaker. • Try a different microphone. • Try a different position for the loudspeaker and/or vocalist on stage. • Increase the distance from the loudspeaker to the microphone. • If using a vocal effects processor, make sure it is not contributing to the feedback problem.

Limited Warranty and Registration

Your product is covered by a limited transferable warranty. Details of the warranty are provided with your product. Register your products online at www.Bose.com/register or call (800) 905-1044. Failure to do so will not affect your warranty rights.

Accessories

Visit www.Bose.com/musicians, or call (800) 905-0886 for accessory information.

Technical Information

Mechanical

	Dimensions	Weight
L1™ model II power stand:	5"H x 10"W x 27"D (12.8 cm x 26.2 cm x 69.2 cm)	23.7 lb (10.7 kg)
L1 model II Cylindrical Radiator® loudspeaker top:	43½"H x 3½"W x 4"D (11.1 cm x 9.0 cm x 10.5 cm)	16.3 lb (7.4 kg)
L1 model II Cylindrical Radiator® loudspeaker bottom:	43½"H x 3½"W x 4"D (11.1 cm x 9.0 cm x 10.5 cm)	17.4 lb (7.9 kg)
B1 bass module:	15"H x 10¼"W x 17¾"D (38.0 cm x 26.0 cm x 45.0 cm)	25.1 lb (11.4 kg)

Electrical

- AC power rating:
100-120V ~ 50/60Hz 500W (USA/Canada); 220-240V ~ 50/60Hz 500W (Europe)
- Peak inrush current:
32A @ 120V ~ 60Hz (USA/Canada); 61A @ 230V ~ 50Hz (Europe)

Impedance

L1™ model II Cylindrical Radiator® loudspeaker:	4Ω
B1 bass module:	8Ω

Audio Input/Output

- T1 ToneMatch™ port: DC output/data input Ethercon/RJ45 connector for a T1 ToneMatch audio engine
- Analog Input: Line-level input channel for ¼" TRS phone plug
- Bass - Line Out: -4dBu (nominal), +9dBu (max.) (balanced TRS connection)
-10dBu (nominal), +3dBu (max.) (unbalanced TS connection)
- Bass Module Out: Neutrik NL4 output for one or two B1 bass modules







303153

BOSE[®]
Better sound through research[®]

©2007 Bose Corporation, The Mountain,
Framingham, MA 01701-9168 USA
303153 AM Rev.00 N10I

www.Bose.com/musicians