

# KEYBOARD AMP / PA SYSTEM KX1200

## User's Manual

Version 1.0 May 2001

ENGLISH



**BEHRINGER**



INSTRUMENT AMPLIFICATION

## SAFETY INSTRUCTIONS

**CAUTION:** To reduce the risk of electrical shock, do not remove the cover (or back). No user serviceable parts inside; refer servicing to qualified personnel.



**WARNING:** To reduce the risk of fire or electrical shock, do not expose this appliance to rain or moisture.



This symbol, wherever it appears, alerts you to the presence of uninsulated dangerous voltage inside the enclosure – voltage that may be sufficient to constitute a risk of shock.



This symbol, wherever it appears, alerts you to important operating and maintenance instructions in the accompanying literature. Read the manual.

### DETAILED SAFETY INSTRUCTIONS:

All the safety and operation instructions should be read before the appliance is operated.

#### **Retain Instructions:**

The safety and operating instructions should be retained for future reference.

#### **Heed Warnings:**

All warnings on the appliance and in the operating instructions should be adhered to.

#### **Follow instructions:**

All operation and user instructions should be followed.

#### **Water and Moisture:**

The appliance should not be used near water (e.g. near a bathtub, washbowl, kitchen sink, laundry tub, in a wet basement, or near a swimming pool etc.).

#### **Ventilation:**

The appliance should be situated so that its location or position does not interfere with its proper ventilation. For example, the appliance should not be situated on a bed, sofa rug, or similar surface that may block the ventilation openings: or placed in a built-in installation, such as a bookcase or cabinet that may impede the flow of air through the ventilation openings.

#### **Heat:**

The appliance should be situated away from heat sources such as radiators, heat registers, stoves, or other appliances (including amplifiers) that produce heat.

#### **Power Source:**

The appliance should be connected to a power supply only of the type described in the operating instructions or as marked on the appliance.

#### **Grounding or Polarization:**

Precautions should be taken so that the grounding or polarization means of an appliance is not defeated.

#### **Power-Cord Protection:**

Power supply cords should be routed so that they are not likely to be walked on or pinched by items placed upon or against them, paying particular attention to cords and plugs, convenience receptacles and the point where they exit from the appliance.

#### **Cleaning:**

The appliance should be cleaned only as recommended by the manufacturer.

#### **Non-use Periods:**

The power cord of the appliance should be unplugged from the outlet when left unused for a long period of time.

#### **Object and Liquid Entry:**

Care should be taken so that objects do not fall and liquids are not spilled into the enclosure through openings.

#### **Damage Requiring Service:**

The appliance should be serviced by qualified service personnel when:

- the power supply cord or the plug has been damaged; or
- objects have fallen, or liquid has been spilled into the appliance; or
- the appliance has been exposed to rain; or
- the appliance does not appear to operate normally or exhibits a marked change in performance; or
- the appliance has been dropped, or the enclosure damaged.

#### **Servicing:**

The user should not attempt to service the appliance beyond that which is described in the Operating Instructions. All other servicing should be referred to qualified service personnel.

## FOREWORD

Dear Customer,

Welcome to the team of KX1200 users and thank you very much for expressing your confidence in BEHRINGER products by purchasing this keyboard amplifier.

It is one of my most pleasant tasks to write this letter to you, because it is the culmination of many months of hard work delivered by our engineering team to reach a very ambitious goal: to present you with an excellent keyboard amplifier that gives you a maximum of flexibility and performance with its unique sound character and comprehensive set of functions. The task of designing our new KX1200 certainly meant a great deal of responsibility, which we assumed by focusing on you, the discerning user and musician. It also meant a lot of work and night shifts to accomplish this goal. But it was fun, too. Developing a product usually brings a lot of people together, and what a great feeling it is when everybody who participated in such a project can be proud of what we've achieved.

It is our philosophy to share our joy with you, because you are the most important member of the BEHRINGER family. With your highly competent suggestions for new products you've greatly contributed to shaping our company and making it successful. In return, we guarantee you uncompromising quality as well as excellent technical and audio properties at an extremely affordable price (manufactured under ISO9000 certified management system). All of this will enable you to fully unfold your creativity without being hampered by budget constraints.

We are often asked how we can make it possible to produce such high-grade devices at such unbelievably low prices. The answer is quite simple: it's you, our customers! Many satisfied customers mean large sales volumes enabling us to get better conditions of purchase for components, etc. Isn't it only fair to pass this benefit back to you? Because we know that your success is our success, too!

I would like to thank all people whose help on "Project KX1200" has made it all possible. Everybody has made very personal contributions, starting from the designers of the unit, via the many staff members in our company to you, the users of BEHRINGER products.

My friends, it's been worth the trouble!

Thank you very much,

A handwritten signature in black ink, appearing to read 'U. Behringer', with a long horizontal flourish extending to the right.

Uli Behringer

# KEYBOARD AMP/PA SYSTEM

Ultra-flexible 120-Watt, 4-channel keyboard amplifier with effects path and microphone input

- ▲ Powerful 120-Watt (RMS) keyboard amplifier with built-in 3-way bass reflex cabinet
- ▲ Special custom-made 15" woofer, 5" midrange speaker plus tweeter
- ▲ 4-channel operation with line inputs and dedicated volume controls
- ▲ Effects/monitor path on all 4 channels
- ▲ Additional XLR input on channel 1 for microphone connection
- ▲ Tape input for line-level signals (e.g. CD player, drum computer)
- ▲ Tape output for recording and live applications
- ▲ Balanced direct output on XLR connector for easy connection to a mixing console
- ▲ Main Output for connection of additional power amps
- ▲ Active 4-band EQ with that excellent sound
- ▲ Short-circuit-proof and "indestructible" power amp with 2-stage fan
- ▲ Master Volume control and stereo headphones output
- ▲ Extremely rugged construction ensures long life even under the most demanding conditions
- ▲ Generously dimensioned power supply for excellent pulse response
- ▲ Manufactured under ISO9000 certified management system

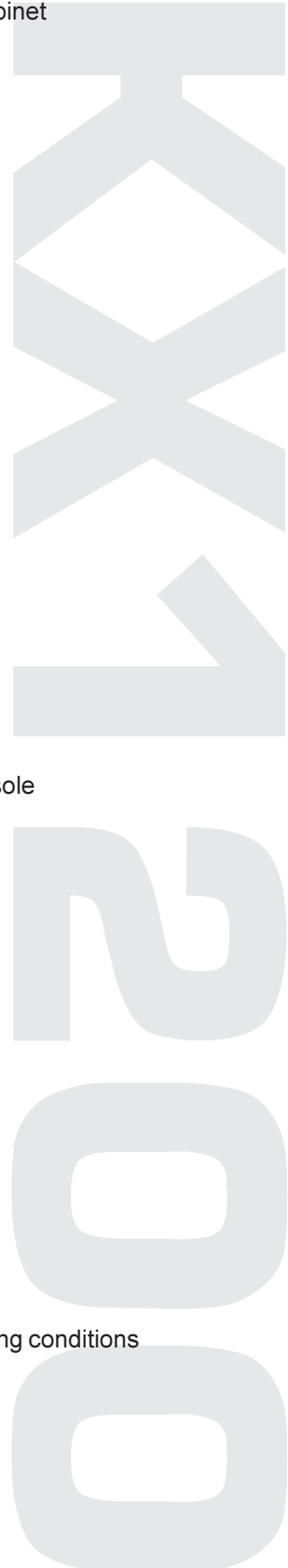

---

# TABLE OF CONTENTS

<b>1. INTRODUCTION .....</b>	<b>5</b>
1.1 Before you begin .....	6
1.2 Control elements .....	6
1.2.1 Front panel .....	6
1.2.2 Rear panel .....	7
<b>2. WIRING EXAMPLES .....</b>	<b>8</b>
2.1 Standard keyboard set-up with external drum computer and effects device .....	8
2.2 Expanded P.A. set-up with four instruments, microphone and connection to a recording console .....	8
<b>3. AUDIO CONNECTIONS .....</b>	<b>9</b>
<b>4. SPECIFICATIONS .....</b>	<b>11</b>
<b>5. WARRANTY .....</b>	<b>12</b>

## 1. INTRODUCTION

Let's be honest: as a keyboard player you're one of those musicians who carry around so much equipment that you never know how to get things connected properly, aren't you? And probably the other guys in your band do keep complaining about your alone using half of the channels on the mixing console, don't they?

We knew that. And that's why we designed the KX1200. Not only is this all-purpose amplifier the ideal tool to amplify your keyboards, but it also forms a perfect base for building a small-scale P.A. system. But first things first...

BEHRINGER is an audio engineering company that has been successfully developing professional products for studio and live applications for many years now. Our range of products includes microphones and a variety of 19" devices (compressors, enhancers, gates, tube processors, headphone amps, digital effects devices, DI boxes, etc.) as well as monitoring and P.A. speakers plus professional live and recording consoles. We have bundled our entire technical know-how and experience in your KX1200.

What are the features that a keyboard amplifier should have? Well, let's take a look at your gear. You surely have a couple of keyboard instruments and expanders, which you'd like to connect to one and the same amp – at the same time. No problem with the KX1200. After all, it features four separate channels. Probably, you also have an effects device to give that beloved organ sound the finishing touch. Here, too, your KX1200 is well equipped in that it features a separate effects path, i.e. each of the four channels can have its own effect intensity.

What about your voice? Wouldn't you like to sing at least some of the songs you composed? We knew you would. That's why we equipped the KX1200 with an input for your microphone.

Well, and finally your drum computer and CD player loaded with sampling CD's: simply connect them to the tape input. And your headphones? Well, no need to ask...

Now we've come full circle: last time you rehearsed with your band, you occupied six channels plus effect path on the console; now you only need one amp occupying just one console channel. Your co-musicians will be grateful for that! And by the way: basically, the guitar or bass player in your band could also use your KX1200, as long as you don't need all four channels for your keyboards equipment.

No later than now it becomes clear that your KX1200 is anything but a "conventional" keyboard amp, doesn't it?

## 1.1 Before you begin

Your KX1200 was carefully packed in the factory and the packaging is designed to protect the unit from rough handling. Nevertheless, we recommend that you carefully examine the packaging and its contents for any signs of physical damage, which may have occurred during transit.

 **If the unit is damaged, please do not return it to BEHRINGER, but notify your dealer and the shipping company immediately, otherwise claims for damage or replacement may not be granted. Shipping claims must be made by the consignee.**

Be sure that there is enough air space around the unit for cooling and please do not place the KX1200 on high-temperature devices such as power amps or radiators, etc. to avoid overheating.

 **Before you connect the KX1200 to the mains, please make sure that your local voltage matches the voltage required by the unit:**

The fuse holder on the female mains connector has 3 triangular markings, with two of these triangles opposing each other. The KX1200 is set to the operating voltage printed next to these markers and can be set to another voltage by turning the fuse holder by 180°. **CAUTION: This instruction does not apply to export models exclusively designed, e.g. for 115-V operation!**

Please use the enclosed power cord to connect the unit to the mains. The cord complies with all applicable safety standards.

 **Please note that all units must be grounded properly. For your own safety, you should never remove any ground connectors from electrical devices or power cords or render them inoperative.**

 **Please note that extreme output volumes can lead to permanent hearing damage. Turn down the VOLUME control before you switch on the unit. Be sure to use appropriate volume levels.**

## 1.2 Control elements

### 1.2.1 Front panel

Your BEHRINGER KX1200 has four identical channels, and each of these channels has two controls. Since all channels are identical, the following descriptions refer to one of them only.

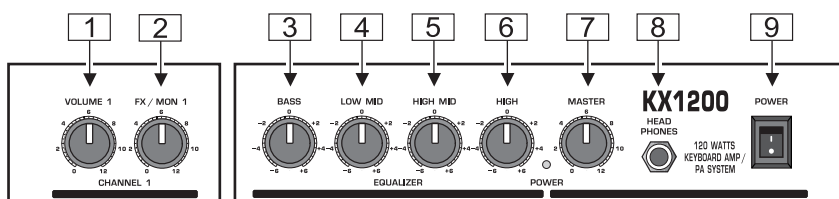







Fig. 1.1: KX1200 front panel

-  Use the *VOLUME* control to adjust the channel volume.
-  The *FX/MON* control determines the channel's effect intensity or monitor volume.
-  **Basically, the *VOLUME* controls of channels 1 through 4 work like a “gain” control, i.e. you can use these channels to connect any type of conventional keyboard or string instrument, and adapt the input sensitivity with the *VOLUME* controls.**
-  The *BASS* control allows you to boost/cut the bass frequencies.
-  The *LOW MID* control governs the low midrange frequencies.
-  Use the *HIGH MID* control to adjust the upper midrange frequencies.

- 6 The *HIGH* control allows you to boost/cut the treble frequency range.
- 7 Use the *MASTER* control to determine the KX1200's overall volume level.
- 8 The stereo 1/4" *HEADPHONES* jack allows you to monitor the amp's audio signal with a pair of commercially available headphones. Connecting the headphones will mute the built-in speakers.
- 9 Use the *POWER* switch to switch your KX1200 on or off. The *POWER LED* located between the *HIGH* and *MASTER* controls lights up when the unit is switched on.

### 1.2.2 Rear panel

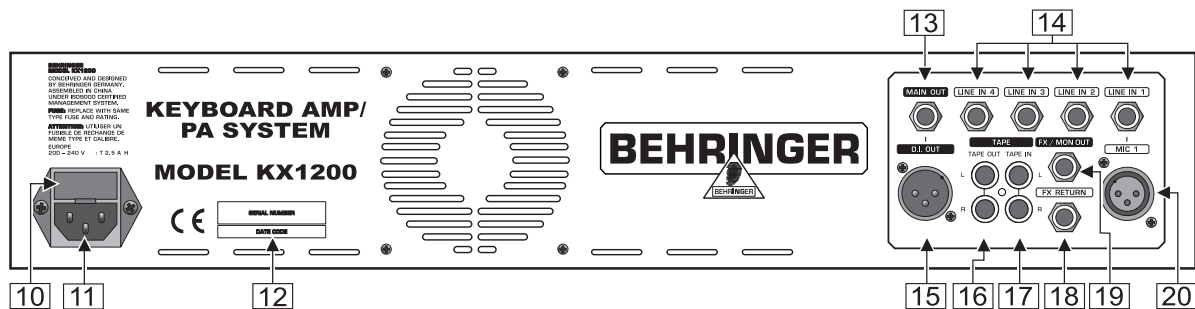





Fig. 1.2: Rear panel connectors

- 10 **FUSE HOLDER / VOLTAGE SELECTOR.** Please make sure that your local voltage matches the voltage indicated on the unit, before you attempt to connect and operate the KX1200. Blown fuses may only be replaced by fuses of the same type and rating. Some models allow for inserting the fuse holder in two different positions, in order to switch over from 230-V to 115-V operation, and vice versa. Please note that for 115-V operation outside Europe, you need to use a fuse of a higher rating.
- 11 Use the enclosed power cord to connect the unit to the mains.
- 12 **SERIAL NUMBER.** Please take the time to fill out and return the warranty card within 14 days after the date of purchase, so as to be entitled to benefit from our extended warranty. Or use our online registration option available on the World Wide Web at [www.behringer.com](http://www.behringer.com).
- 13 The *MAIN OUT* allows you to connect the KX1200 to an external amplifier.
-  **Use the *MAIN OUT* to connect the KX1200 to a mixing console, unless the console has balanced inputs. In this case, you should always use the *D.I.* output of your KX1200.**
- 14 *LINE 1 - 4:* These 1/4" TRS inputs are used to connect line-level instruments.
- 15 The balanced *D.I. OUT* (XLR) allows you to connect the KX1200 to the input of a mixing console.
- 16 The *TAPE OUT* connector (RCA) supplies the audio signal of your KX1200, for example to send it to a recording machine.
- 17 The *TAPE IN* connector (RCA) allows you to connect an external signal source such as a drum computer or other machine providing audio playbacks.
- 18 Connect the *FX RETURN* to the output of an external effects device.
-  **The *FX RETURN* can also be used to feed in the output signal from an external amplifier.**
- 19 Connect the *FX/MON OUT* to the input of an external effects device.
-  **The *FX/MON OUT* can also be used as a monitor output. Use the *FX/MON* controls 1 through 4 to adjust the volume levels of the connected instruments as part of the monitor mix.**
- 20 The *MIC 1* input (XLR) allows you to connect a microphone.
-  **Use channel 1 to connect either a microphone or a line-level signal, but never both at the same time!**



## 2. WIRING EXAMPLES

### 2.1 Standard keyboard set-up with external drum computer and effects device

The standard set-up allows you to connect your entire keyboard equipment. Instead of the drum computer you could also use some sort of playback provided, for example, by a tape deck or CD player.

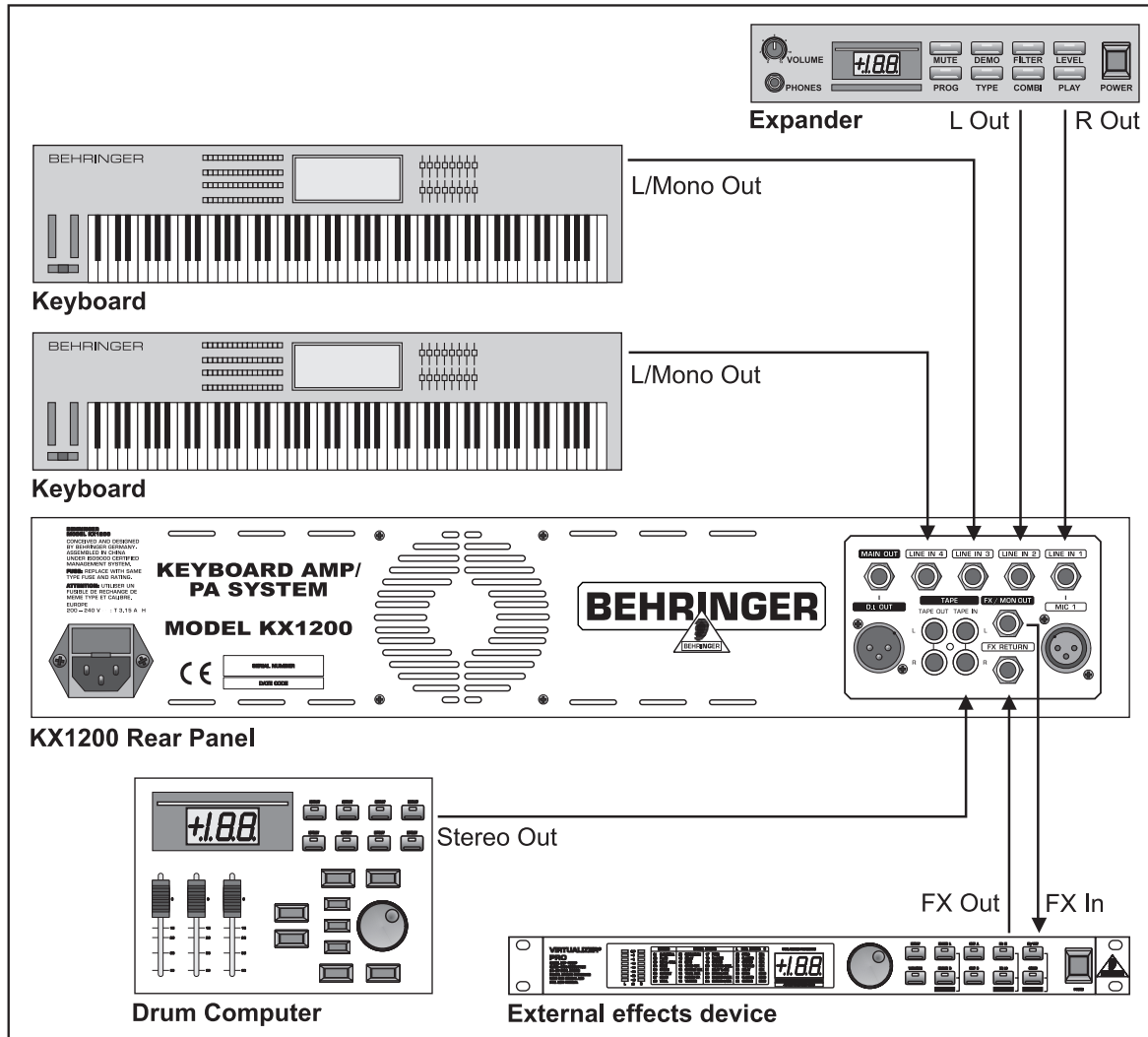

Fig. 2.1: Standard set-up

### 2.2 Expanded P.A. set-up with four instruments, microphone and connection to a recording console

For small gigs or rehearsals with a band we recommend using the wiring scheme below, which expands the standard set-up described above.

**⚠️ Please remember to connect either a microphone or a line-level signal to channel 1, but never both at the same time!**

**⚠️ When you wish to connect an electric guitar, we recommend that you process the signal before with a guitar preamp that features a speaker simulation circuit. Otherwise, the guitar sound will suffer from excess presence in the treble range. The outputs of guitar preamps are usually equipped with a speaker simulation circuit.**



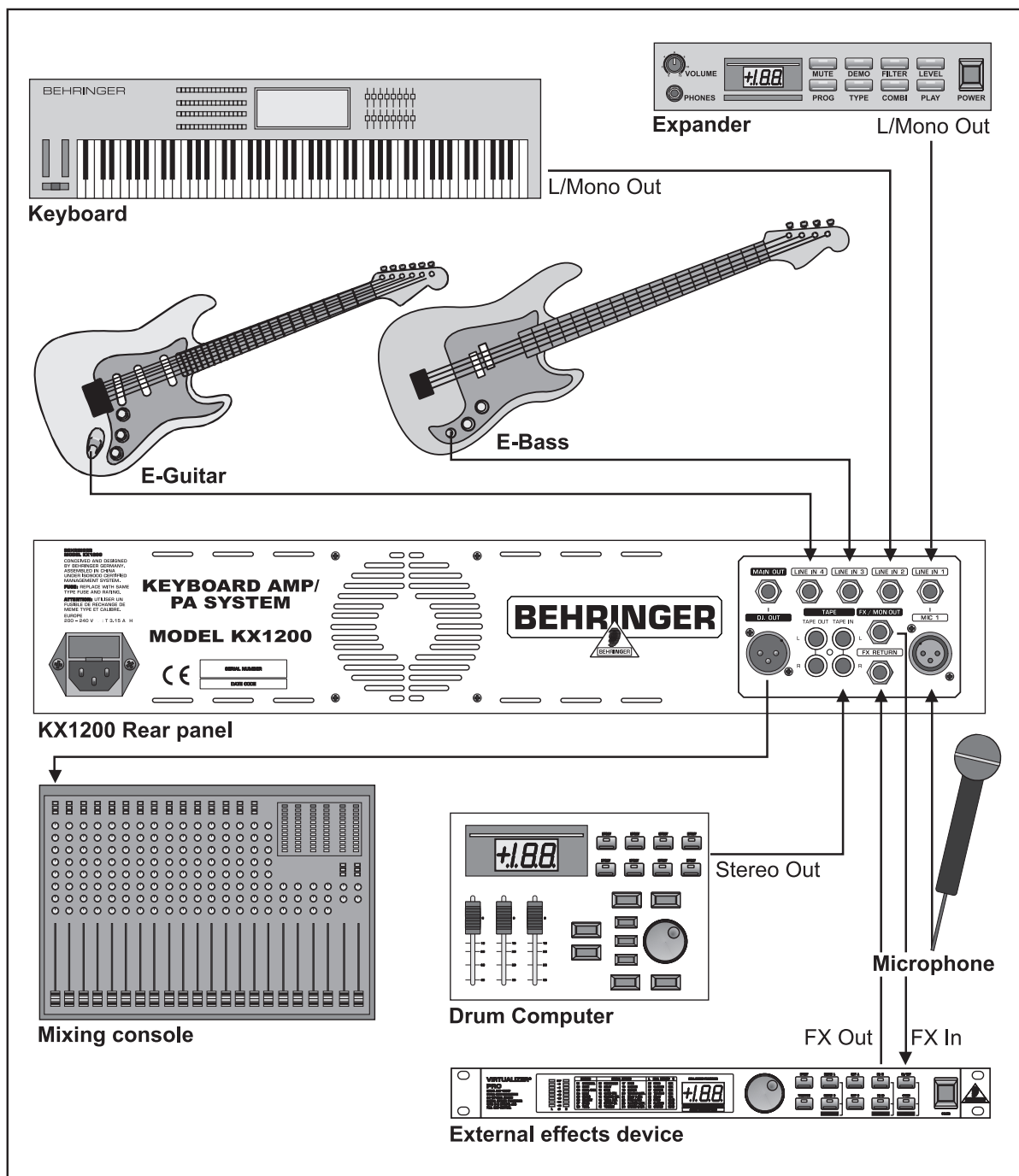

Fig. 2.2: Expanded set-up

### 3. AUDIO CONNECTIONS

The 1/4" jack inputs/outputs of your BEHRINGER KX1200 are on balanced mono jacks – except for the LINE IN-connectors (TRS) and the stereo headphones connector. The DIRECT OUT and microphone input are on balanced XLR connectors. The tape inputs/outputs are on cinch connectors.

 **Please ensure that only qualified personnel install and operate the KX1200. During installation and operation the user must have sufficient electrical contact to earth, otherwise electrostatic charges might affect the operation of the unit.**

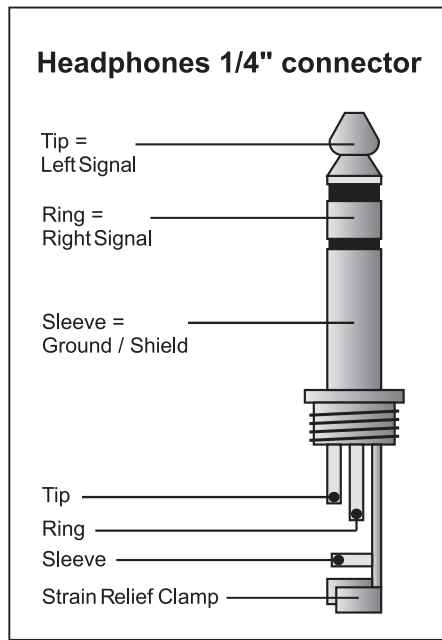

Fig. 3.1: Wiring of a stereo headphones 1/4" plug

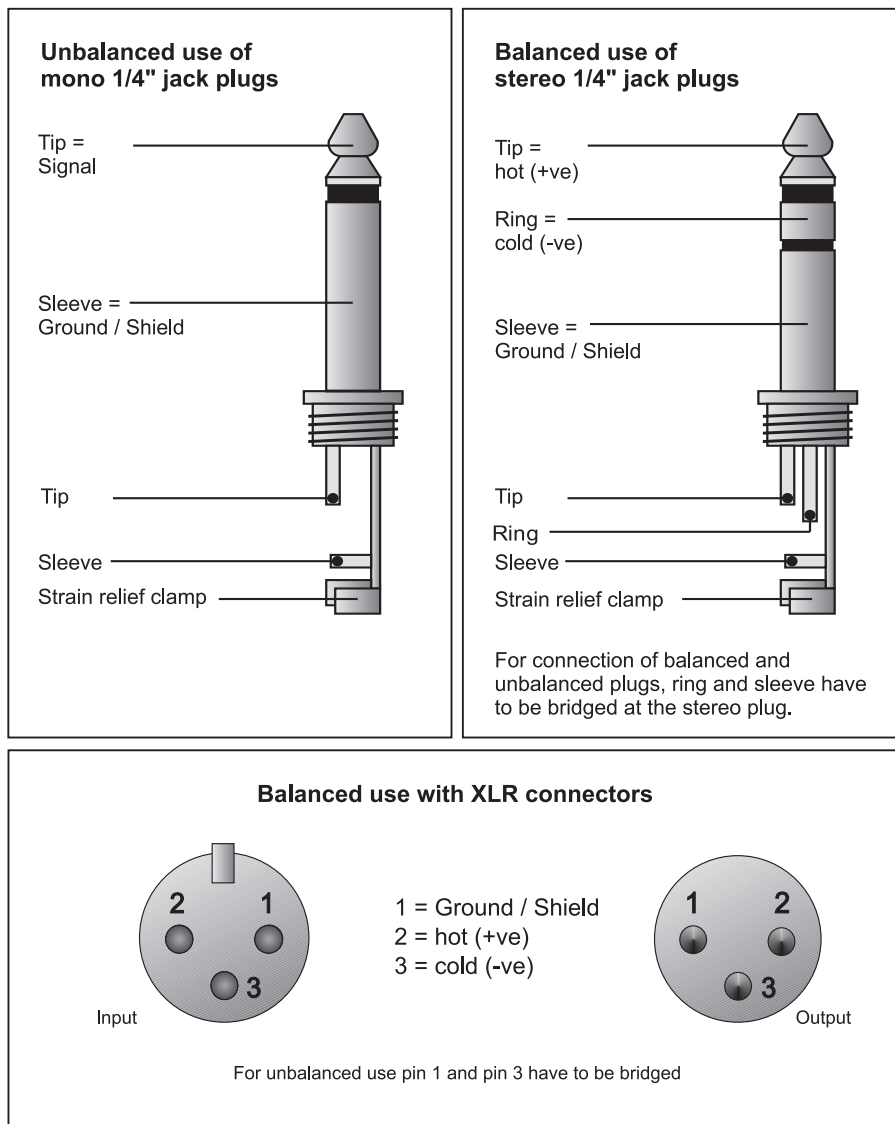

Fig. 3.2: Different plug types

## 4. SPECIFICATIONS

### AUDIO INPUTS

Line In 1 - 4	1/4" TRS
Input impedance	approx. 30 k $\Omega$ balanced
FX Return	1/4" stereo jack
Input impedance	approx. 20 k $\Omega$ unbalanced
Tape In	RCA connector
Input impedance	approx. 30 k $\Omega$ unbalanced
Mic 1	XLR connector
Input impedance	approx. 2 k $\Omega$ balanced

### AUDIO OUTPUTS

Headphones connector	1/4" stereo jack
Main Out	1/4" stereo jack
Output impedance	approx. 100 $\Omega$ unbalanced
D.I. Out	XLR connector
Output impedance	approx. 100 $\Omega$ balanced
FX/Mon Out	1/4" stereo jack
Output impedance	approx. 100 $\Omega$ unbalanced
Tape Out	RCA connector
Output impedance	< 10 k $\Omega$ unbalanced

### SYSTEM SPECIFICATIONS

Power amp output	120 Watts into 4 $\Omega$
------------------	---------------------------

### WOOFER

Type	15B 120A4
Impedance	4 $\Omega$
Power handling	150 W

### HIGH MIDRANGE SPEAKER

Type	5M 120A8
Impedance	8 $\Omega$
Power handling	120 W

### TWEETER

Type	Piezo
------	-------

### POWER SUPPLY

Mains voltages	U.S./Canada	120 V $\sim$ , 60 Hz
	U.K./Australia	240 V $\sim$ , 50 Hz
	Europe	230 V $\sim$ , 50 Hz
	General export model	100 - 120 V $\sim$ , 200 - 240 V $\sim$ , 50 - 60 Hz
Power consumption	160 W	
Fuse	100 - 120 V $\sim$ : <b>T 5 A H</b>	
	200 - 240 V $\sim$ : <b>T 2.5 A H</b>	
Mains connection	Standard IEC receptacle	

### PHYSICAL/WEIGHT

Dimensions (H * W * D)	approx. 27 5/8" (700 mm) * 21 1/4" (540 mm) * 11 3/4" (300 mm)
Weight	approx. 24 kg

BEHRINGER is constantly striving to maintain the highest professional standards. As a result of these efforts, modifications may be made from time to time to existing products without prior notice. Specifications and appearance may differ from those listed or illustrated.

## 5. WARRANTY

### § 1 WARRANTY CARD/ONLINE REGISTRATION

To be protected by the extended warranty, the buyer must complete and return the enclosed warranty card within 14 days of the date of purchase to BEHRINGER Spezielle Studiotechnik GmbH, in accordance with the conditions stipulated in § 3. Failure to return the card in due time (date as per postmark) will void any extended warranty claims.

Based on the conditions herein, the buyer may also choose to use the online registration option via the Internet ([www.behringer.com](http://www.behringer.com) or [www.behringer.de](http://www.behringer.de)).

### § 2 WARRANTY

1. BEHRINGER (BEHRINGER Spezielle Studiotechnik GmbH including all BEHRINGER subsidiaries listed on the enclosed page, except BEHRINGER Japan) warrants the mechanical and electronic components of this product to be free of defects in material and workmanship for a period of one (1) year from the original date of purchase, in accordance with the warranty regulations described below. If the product shows any defects within the specified warranty period that are not due to normal wear and tear and/or improper handling by the user, BEHRINGER shall, at its sole discretion, either repair or replace the product.

2. If the warranty claim proves to be justified, the product will be returned to the user freight prepaid.

3. Warranty claims other than those indicated above are expressly excluded.

### § 3 RETURN AUTHORIZATION NUMBER

1. To obtain warranty service, the buyer (or his authorized dealer) must call BEHRINGER (see enclosed list) during normal business hours **BEFORE** returning the product. All inquiries must be accompanied by a description of the problem. BEHRINGER will then issue a return authorization number.

2. Subsequently, the product must be returned in its original shipping carton, together with the return authorization number to the address indicated by BEHRINGER.

3. Shipments without freight prepaid will not be accepted.

### § 4 WARRANTY REGULATIONS

1. Warranty services will be furnished only if the product is accompanied by a copy of the original retail dealer's invoice. Any product deemed eligible for repair or replacement by BEHRINGER under the terms of this warranty will be repaired or replaced within 30 days of receipt of the product at BEHRINGER.

2. If the product needs to be modified or adapted in order to comply with applicable technical or safety standards on a national or local level, in any country which is not the country for which the product was originally developed and manufactured, this modification/adaptation shall not be considered a defect in materials or workmanship. The warranty does not cover any such modification/adaptation, irrespective of whether it was carried out properly or not. Under the terms of this warranty, BEHRINGER shall not be held responsible for any cost resulting from such a modification/adaptation.

3. Free inspections and maintenance/repair work are expressly excluded from this warranty, in particular, if caused by improper handling of the product by the user.

This also applies to defects caused by normal wear and tear, in particular, of faders, potentiometers, keys/buttons and similar parts.

4. Damages/defects caused by the following conditions are not covered by this warranty:

- ▲ misuse, neglect or failure to operate the unit in compliance with the instructions given in BEHRINGER user or service manuals.

- ▲ connection or operation of the unit in any way that does not comply with the technical or safety regulations applicable in the country where the product is used.

- ▲ damages/defects caused by force majeure or any other condition that is beyond the control of BEHRINGER.

5. Any repair or opening of the unit carried out by unauthorized personnel (user included) will void the warranty.

6. If an inspection of the product by BEHRINGER shows that the defect in question is not covered by the warranty, the inspection costs are payable by the customer.

7. Products which do not meet the terms of this warranty will be repaired exclusively at the buyer's expense. BEHRINGER will inform the buyer of any such circumstance. If the buyer fails to submit a written repair order within 6 weeks after notification, BEHRINGER will return the unit C.O.D. with a separate invoice for freight and packing. Such costs will also be invoiced separately when the buyer has sent in a written repair order.

### § 5 WARRANTY TRANSFERABILITY

This warranty is extended exclusively to the original buyer (customer of retail dealer) and is not transferable to anyone who may subsequently purchase this product. No other person (retail dealer, etc.) shall be entitled to give any warranty promise on behalf of BEHRINGER.

### § 6 CLAIM FOR DAMAGES

Failure of BEHRINGER to provide proper warranty service shall not entitle the buyer to claim (consequential) damages. In no event shall the liability of BEHRINGER exceed the invoiced value of the product.

### § 7 OTHER WARRANTY RIGHTS AND NATIONAL LAW

1. This warranty does not exclude or limit the buyer's statutory rights provided by national law, in particular, any such rights against the seller that arise from a legally effective purchase contract.

2. The warranty regulations mentioned herein are applicable unless they constitute an infringement of national warranty law.

---

The information contained in this manual is subject to change without notice. No part of this manual may be reproduced or transmitted in any form or by any means, electronic or mechanical, including photocopying and recording of any kind, for any purpose, without the express written permission of BEHRINGER Spezielle Studiotechnik GmbH.

BEHRINGER is a registered trademark. ALL RIGHTS RESERVED.

© 2001 BEHRINGER Spezielle Studiotechnik GmbH.

BEHRINGER Spezielle Studiotechnik GmbH, Hanns-Martin-Schleyer-Str. 36-38, 47877 Willich-Münchheide II, Germany

Tel. +49 (0) 21 54 / 92 06-0, Fax +49 (0) 21 54 / 92 06-30

---