

B300

User's Manual

Version 1.2 July 2002

ENGLISH



www.behringer.com

SAFETY INSTRUCTIONS

CAUTION: To reduce the risk of electrical shock, do not remove the cover (or back). No user serviceable parts inside; refer servicing to qualified personnel.

WARNING: To reduce the risk of fire or electrical shock, do not expose this appliance to rain or moisture.



This symbol, wherever it appears, alerts you to the presence of uninsulated dangerous voltage inside the enclosure – voltage that may be sufficient to constitute a risk of shock.



This symbol, wherever it appears, alerts you to important operating and maintenance instructions in the accompanying literature. Read the manual.

DETAILED SAFETY INSTRUCTIONS:

All the safety and operation instructions should be read before the appliance is operated.

Retain Instructions:

The safety and operating instructions should be retained for future reference.

Heed Warnings:

All warnings on the appliance and in the operating instructions should be adhered to.

Follow instructions:

All operation and user instructions should be followed.

Water and Moisture:

The appliance should not be used near water (e.g. near a bathtub, washbowl, kitchen sink, laundry tub, in a wet basement, or near a swimming pool etc.).

Ventilation:

The appliance should be situated so that its location or position does not interfere with its proper ventilation. For example, the appliance should not be situated on a bed, sofa rug, or similar surface that may block the ventilation openings: or placed in a built-in installation, such as a bookcase or cabinet that may impede the flow of air through the ventilation openings.

Heat:

The appliance should be situated away from heat sources such as radiators, heat registers, stoves, or other appliances (including amplifiers) that produce heat.

Power Source:

The appliance should be connected to a power supply only of the type described in the operating instructions or as marked on the appliance.

Grounding or Polarization:

Precautions should be taken so that the grounding or polarization means of an appliance is not defeated.

Power-Cord Protection:

Power supply cords should be routed so that they are not likely to be walked on or pinched by items placed upon or against them, paying particular attention to cords and plugs, convenience receptacles and the point where they exit from the appliance.

Cleaning:

The appliance should be cleaned only as recommended by the manufacturer.

Non-use Periods:

The power cord of the appliance should be unplugged from the outlet when left unused for a long period of time.

Object and Liquid Entry:

Care should be taken so that objects do not fall and liquids are not spilled into the enclosure through openings.

Damage Requiring Service:

The appliance should be serviced by qualified service personnel when:

- the power supply cord or the plug has been damaged; or
- objects have fallen, or liquid has been spilled into the appliance; or
- the appliance has been exposed to rain; or
- the appliance does not appear to operate normally or exhibits a marked change in performance; or
- the appliance has been dropped, or the enclosure damaged.

Servicing:

The user should not attempt to service the appliance beyond that which is described in the Operating Instructions. All other servicing should be referred to qualified service personnel.

Caution! Please note the following instructions pertaining to the “flying” operation of your speaker cabinet:

The operation of your speaker cabinet as part of a flown system is at your own risk! Make sure that speaker cabinets are set up and “flown” by qualified personnel only, using dedicated equipment and the original parts and components delivered with the unit. **Be sure to observe the local safety regulations applicable in your country.** BEHRINGER company (BEHRINGER Spezielle Studiotechnik GmbH including the BEHRINGER companies listed on the enclosed “Service Information” sheet) assumes no liability for any damage or personal injury resulting from improper use or operation of the product!

Check the speaker cabinet for damages before using it as part of a flown system. If you detect any cracks, deformations, corrosion, defective or missing parts, the speaker cabinet may not be used! **If the hanging fixtures show any signs of damage, they must be replaced immediately!**

The speaker cabinet was designed exclusively to carry its own weight when operated as part of a flown system. **Please note that it is not permitted to attach any additional weights or charges to the speaker cabinet!**

Make sure that the speaker cabinet is not exposed to moisture during outdoor use, and that it cannot be “shaken” by gusts of wind.

Check the floor:

Always check the floor for stability before you set up the speaker cabinet. Vibrating floors (e.g. elements/components on the stage) do not provide reliable support for speaker stacks. So, always set up your speakers on a solid and even support.

Make sure that speaker cabinets are set up properly:

Set up your speaker cabinet at a distance to dance floors or other audience areas, so as to avoid that somebody can knock over a speaker stack.

FOREWORD

Dear Customer,

Welcome to the team of B300 users and thank you very much for expressing your confidence in BEHRINGER products by purchasing this fully active loudspeaker system. It is one of my most pleasant tasks to write this letter to you, because it is the culmination of many months of hard work delivered by our engineering team to reach a very ambitious goal: presenting you with an out-of-the-ordinary loudspeaker system that can be used for any kind of sound reinforcement application. The task of designing our new B300 certainly meant a great deal of responsibility, which we assumed by focusing on you, the discerning user and musician. It also meant a lot of work and night shifts to accomplish this goal. But it was fun, too. Developing a product usually brings a lot of people together, and what a great feeling it is when everybody who participated in such a project can be proud of what we've achieved.

It is our philosophy to share our joy with you, because you are the most important member of the BEHRINGER family. With your highly competent suggestions for new products you've greatly contributed to shaping our company and making it successful. In return, we guarantee you uncompromising quality (manufactured under ISO9000 certified management system) as well as excellent technical and audio properties at an extremely affordable price. All of this will enable you to fully unfold your creativity without being hampered by budget constraints.

We are often asked how we can make it to produce such high-grade devices at such unbelievably low prices. The answer is quite simple: it's you, our customers! Many satisfied customers means large sales volumes enabling us to get better conditions of purchase for components, etc. Isn't it only fair to pass this benefit back to you? Because we know that your success is our success, too!

I would like to thank all people whose help on "Project B300" has made it all possible. Everybody has made very personal contributions, starting from the designers of the unit via the many staff members in our company to you, the users of BEHRINGER products.

My friends, it's been worth the trouble!

Thank you very much,

A handwritten signature in black ink, appearing to read 'U. Behringer', with a long horizontal flourish extending to the right.

Uli Behringer

B300

Fully Active 2-Way Loudspeaker System with Integrated EQ and Mic Preamp

- ▲ 2-way bi-amping for excellent sound reproduction
 - ▲ Two integrated high-power amps for low and high frequency ranges delivering a total of 300 Watts
 - ▲ High-efficiency components for extremely high sound pressure levels and ultra-low distortion
 - ▲ Extensive phase and time correction ensures perfect system alignment
 - ▲ Innovative Reflex Cooling System for automatic convection-type cooling
 - ▲ Extremely rugged, low-resonance plastic enclosure
 - ▲ Special design allows for flying operation
 - ▲ High-efficiency 1.25" compression driver with titanium dome for excellent high-frequency reproduction
 - ▲ 15" long-throw woofer with high-power magnet
 - ▲ Integrated 2-band equalizer and on-board crossover network with integrated limiter ensures speaker protection
 - ▲ Balanced audio inputs on XLR and ¼" TRS connectors
 - ▲ High-quality microphone preamplifier allows for direct connection of dynamic microphones
 - ▲ Signals can be looped through to drive additional B300's
 - ▲ Clearly visible power and overload LED's on front and rear panel for optimal operational control
 - ▲ Integrated suspension points and socket for pole or stand mounting
 - ▲ Manufactured under ISO9000 certified management system
- 

TABLE OF CONTENTS

1. INTRODUCTION	6
1.1 The concept	6
1.2 Before you begin	6
1.2.1 Mains voltage	6
1.3 Control elements	7
2. SETTING UP THE B300	8
2.1 Tweeter	8
2.2 How to avoid feedback	8
2.3 Flying operation of the B300	9
3. CONNECTIONS	9
3.1 Mains connection	9
3.2 Audio connections	9
3.2.1 Audio connections to a mixing console	9
3.2.2 Direct audio connection to a microphone	9
3.2.3 Direct audio connection to a stereo signal source	9
4. LEVEL SETTING	10
5. APPLICATIONS	11
5.1 Presentations	11
5.2 P.A. systems	11
5.3 Monitoring application	11
6. SPECIFICATIONS	12
7. WARRANTY	13

CAUTION!

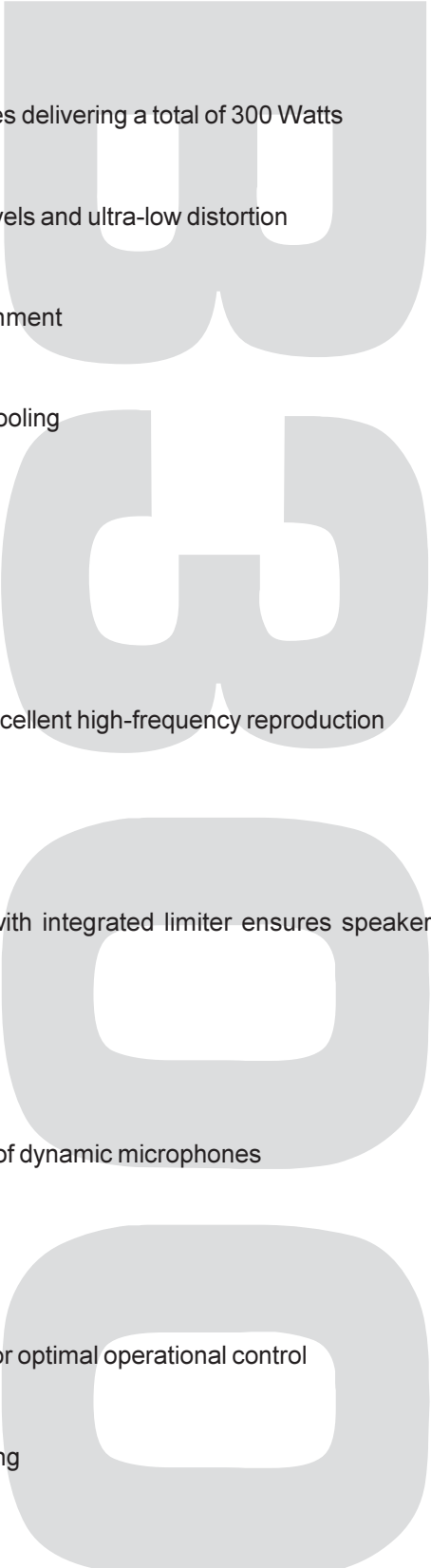

Please note that extreme output volumes can lead to permanent hearing damage. Turn down the **VOLUME** control before you switch on the unit. Be sure to use appropriate volume levels.

1. INTRODUCTION

Congratulations! With our new BEHRINGER B300 you purchased an absolutely reliable and versatile active loudspeaker system. You now own an audio tool that gives you an undistorted and well balanced reproduction of your program material, be it for presentations, P.A. system or monitoring applications. Despite its built-in high-power stages, the B300 is compact enough to be handled with ease. It combines the benefits of easy and fast installation and handling with absolutely pro-level features. And the use of matching components (preamps, crossovers, power amps, speakers) gives you the freedom to use your B300 in a great variety of applications.

 **This manual first describes the terminology used, so that you can fully understand the B300 and its functions. Please read the manual carefully and keep it for future reference.**

1.1 The concept

The B300 is equipped with two separate power amps for the woofer and tweeter ranges. With 175 and 50 watts respectively, these amps have lots of power reserves. The effective operating range of the 15" woofer has been expanded towards the bottom end by means of a special bass reflex system. The tweeter installed in the B300 ensures an extremely fine signal resolution in the treble range. To optimize its efficiency we upgraded the tweeter with a specially designed horn. A built-in musical limiter makes sure that both speakers are protected reliably against overloading.

The philosophy behind BEHRINGER products guarantees a no-compromise circuit design and employs the best choice of components. Additionally, the B300 is manufactured in compliance with a ISO9000 certified management system.

1.2 Before you begin

Your B300 was carefully packed in the factory and the packaging is designed to protect the unit from rough handling. Nevertheless, we recommend that you carefully examine the packaging and its contents for any signs of physical damage, which may have occurred during transit.

 **If the unit is damaged, please do not return it to BEHRINGER, but notify your dealer and the shipping company immediately, otherwise claims for damage or replacement may not be granted. Shipping claims must be made by the consignee.**

The B300 must be placed on a flat and stable surface or a commercially available speaker stand. Be sure that there is enough air space around the unit for cooling and please do not place the B300 on high-temperature devices such as power amps or radiators, etc. to avoid overheating.

 **Please note that all units must be grounded properly. For your own safety, you should never remove any ground connectors from electrical devices or power cords or render them inoperative.**

1.2.1 Mains voltage

Before you connect the B300 to the mains, please make sure that your local voltage matches the voltage required by the unit! The fuse holder on the female mains connector has 3 triangular markers, with two of these triangles opposing each other. The B300 is set to the operating voltage printed next to these markers and can be set to another voltage by turning the fuse holder by 180°. **CAUTION: This instruction does not apply to export models exclusively designed, e.g. for 115 V operation!**

Please use the enclosed power cord to connect the unit to the mains. The cord complies with all applicable safety standards.

1.3 Control elements

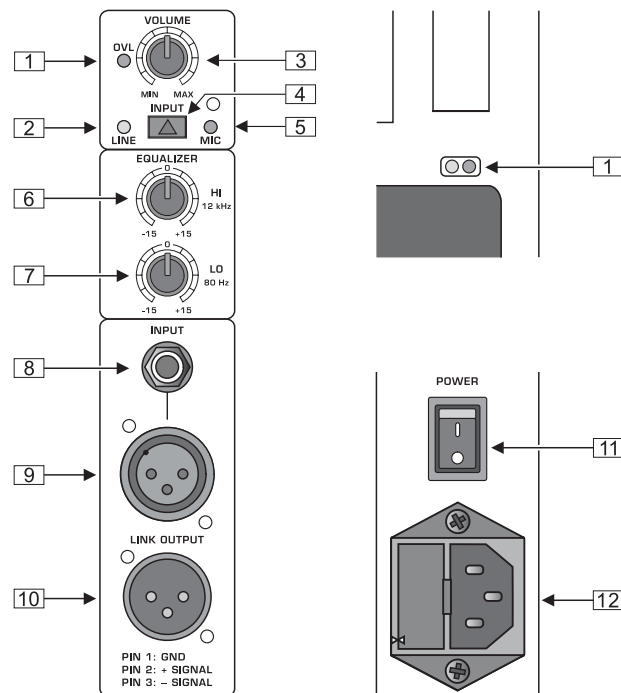

Fig. 1.1: Rear panel control and connecting elements of the B300

- 1 The OVL LED (= overload) lights up as soon as any one of the built-in protections has been activated. For improved control a second overload LED is installed on the front panel of the speaker cabinet.
- 2 The LINE LED lights up when the input sensitivity of the B300 has been set to LINE level with switch 4. **When you have a mixing console or any other playback device (e.g. CD player) connected, be sure to set this switch always to LINE level!**
- 3 The VOLUME control governs the overall volume level of your B300.
- 4 The INPUT switch changes the input sensitivity from line to microphone level, and vice versa.
- 5 The MIC LED lights up when the input sensitivity of the B300 is set to microphone level.
- 6 Use the HI control to adjust the high-frequency range of the built-in equalizer.
- 7 Use the LO control to adjust the low-frequency range of the built-in equalizer.
- 8 This stereo 1/4" TRS connector is the input for the signal source. You can also connect a microphone (in this case, switch 4 must be set to "MIC"!)
- 9 This XLR connector is a balanced input for the signal source. You can also connect a microphone (in this case, switch 4 must be set to "MIC"!)
- 10 The LINK OUTPUT is directly connected to the inputs of the B300 and provides a one-to-one copy of the input signal, for example, to loop the signal through to the input of another device (e.g. a second B300).
- 11 Use the POWER switch to put the B300 into operation.
- 12 FUSE HOLDER/VOLTAGE SELECTOR and MAINS CONNECTOR. Please make sure that your local voltage matches the voltage indicated on the unit, before you attempt to connect and operate the B300. Blown fuses may only be replaced by fuses of the same type and rating. Some models allow for inserting the fuse holder in two different positions, in order to switch over from 230 V to 115 V operation, and vice versa (see chapter 1.2.1). Please note that for 115 V operation outside Europe, you need a fuse of a higher rating.



The serial number of your B300 is printed on the rear panel. Please take the time to fill out and return the warranty card within 14 days after the date of purchase, so as to be entitled to benefit from our extended warranty. Or use our online registration option available on the Internet at www.behringer.com.

2. SETTING UP THE B300

The sound of your B300 largely depends on the room acoustics. Please observe the following hints to get the most out of your B300.

2.1 Tweeter

High frequencies are the very part of the audio spectrum that ensures a clear sound and speech intelligibility. Although these frequencies can be located most easily, they are also the first to be blocked acoustically. We therefore recommend that you set up your speakers on speaker stands, so that the tweeter radiates its signals slightly above the heads of the audience. This will ensure both an optimum dispersion of the high-frequency content and a considerably improved speech intelligibility.

2.2 How to avoid feedback

Always place the microphones (viewed from the audience) behind the B300, never in front of it:

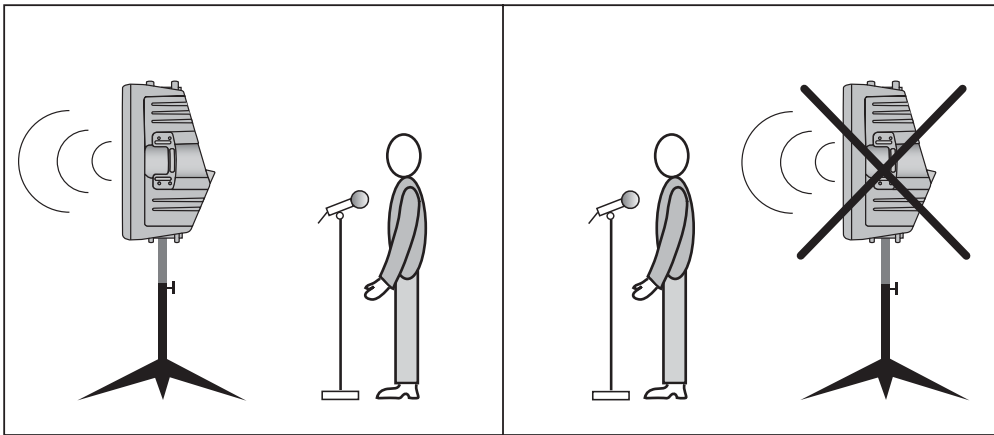

Fig. 2.1: Dos and don'ts of speaker positioning

Use professional floor monitors (e.g. BEHRINGER EUROLIVE F1220 or F1520), so that the musicians on stage can hear themselves. You can also use your B300 as a monitor speaker, because it can also be set up at an angle (as shown below), which depends on the microphone(s) used. When microphones with a cardioid polar pattern are used, the B300 must be positioned as shown below (right, center speaker). When you use a microphone with a hyper-cardioid polar pattern, you can place either one or two B300's at an angle of 45° on the microphone axis (as shown by the shaded speaker boxes to the left and right of the microphone).

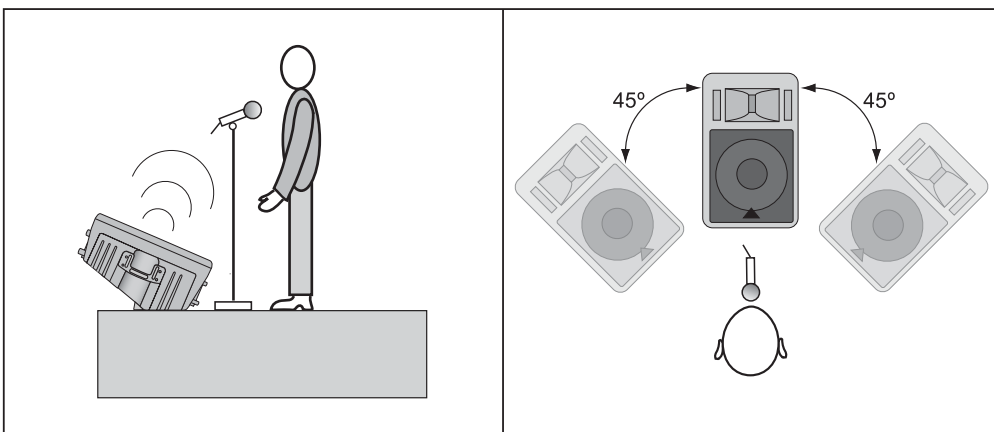



Fig. 2.2: B300 as a monitor speaker

2.3 Flying operation of the B300

A special fixture designed by BEHRINGER allows the flying operation of your B300. Safe and reliable flying of speakers requires some know-how and expertise. So, please make sure that your B300 will be set up by qualified personnel only. BEHRINGER assumes no liability for any damage or personal injury resulting from improper operation of your loudspeakers!

Use the fixture on the top side of the B300 to fly the speaker. On the rear of the cabinet, you will find a second fixture which—if fastened to the rigging system—allows you to adjust the tilt angle of the speaker cabinet.

 **If your B300 shows any signs of damage, it must be repaired using original BEHRINGER parts before it can be used for flying operation. Make sure that no persons are passing by underneath the speaker while it is attached to the rigging system. What is more, the cabinet should never be flown in areas that can be entered by the audience. Please read our safety precautions!**

3. CONNECTIONS

3.1 Mains connection

Use the enclosed power cord to connect your B300 to the mains. To avoid ground loops, both speaker and mixing console should be fed from the same outlet.

3.2 Audio connections

 **Always use either the XLR or the 1/4" TRS input of your B300, and adjust the input sensitivity with switch [4]. Never use both inputs at the same time!**

3.2.1 Audio connections to a mixing console

The standard application of the B300 is the direct connection of two speakers to one mixing console. Connect the inputs of each B300 to one Main Output of your console. The inputs of the B300 are on balanced XLR and 1/4" TRS connectors. To avoid interference and hum, we recommend that you use balanced XLR or 1/4" TRS cables.

When the two loudspeakers have been connected as described above, turn down their VOLUME controls to zero, then switch on the speakers using the POWER switch [11].

3.2.2 Direct audio connection to a microphone

Owing to the built-in microphone preamp you can also directly connect a dynamic microphone using the XLR connector of your B300. Set the INPUT switch [4] to "MIC".

 **Set the INPUT switch to "MIC" only when you connect a microphone; otherwise, you will overload the B300.**

Optionally, you can connect a second B300 to the LINK OUTPUT of the first. Once the speakers are connected to each other, turn down their VOLUME controls to zero, then switch on the speakers.

3.2.3 Direct audio connection to a stereo signal source

Two B300's can be used to play back a stereo signal source, e.g. a CD player. In this case, each B300 must be connected to one output of the signal source.

Here, too, you should turn down all VOLUME controls before you switch on the speakers.

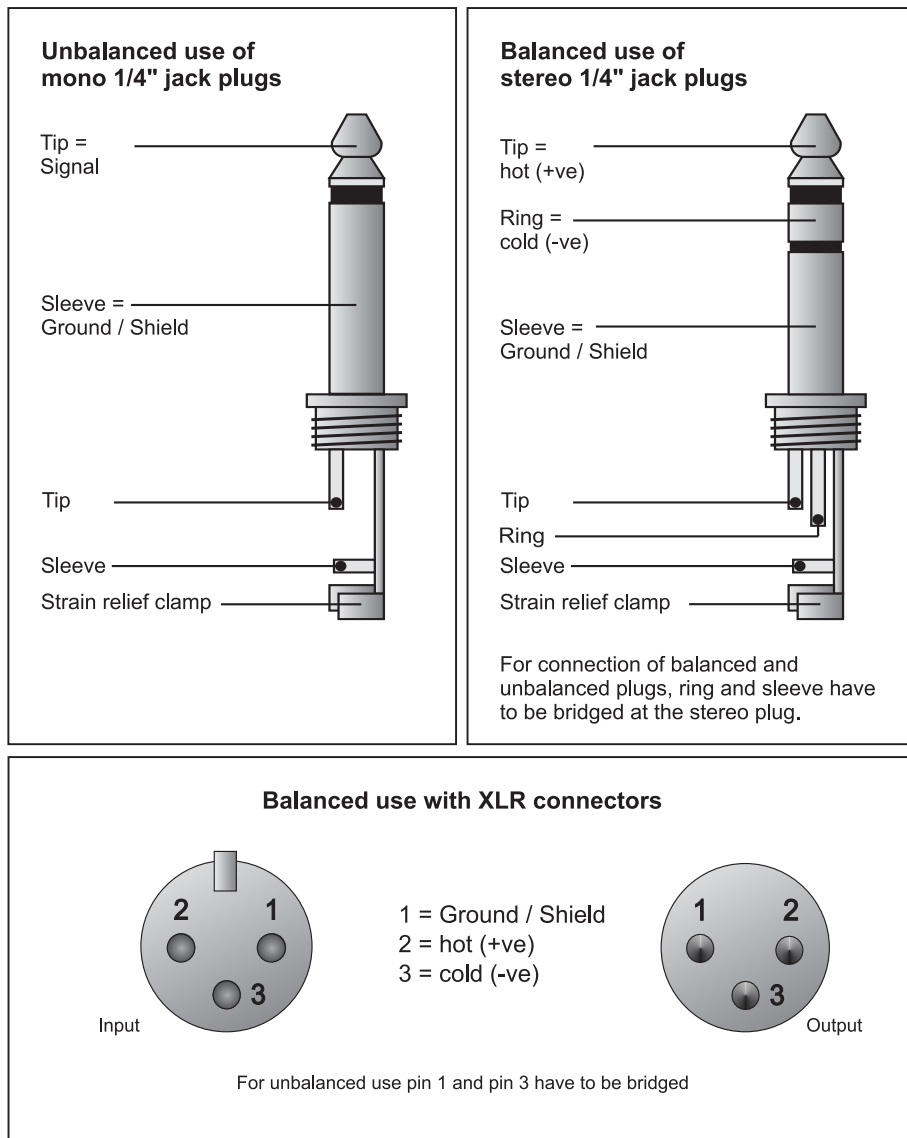

Fig. 3.1: Different plug types

4. LEVEL SETTING

Please set the levels as follows:

- ▲ Turn the master volume control on your mixing console until it provides a level of 0 dB, or
- ▲ Raise the output level of the stereo signal source (if equipped with a volume control), so that there is *no* overloading, or
- ▲ Speak into the microphone connected.

Now, turn up the VOLUME control of your B300. The overload LED (OVL) 1 helps you control the level. The LED lights up as soon as one of the internal protections has been activated due to an overload condition. For optimum control the B300 has a second overload LED on its front panel. The OVL LED may light up with signal peaks, but it should never light all the time.

If the amplifiers built into the B300 are muted temporarily, this is an indication that the speaker is being overloaded. In this case, you should reduce the output level of the mixing console or turn down the VOLUME control 3 of your B300.

5. APPLICATIONS

5.1 Presentations

Owing to the built-in microphone preamp you only need a B300 and a dynamic microphone to set up a straightforward sound reinforcement system. Mount the B300 on a speaker stand for optimum presentation and intelligibility of announcements. If one B300 is not enough, you can of course use a second or even more loudspeakers. How to wire them is shown in chapter 3.2.2.

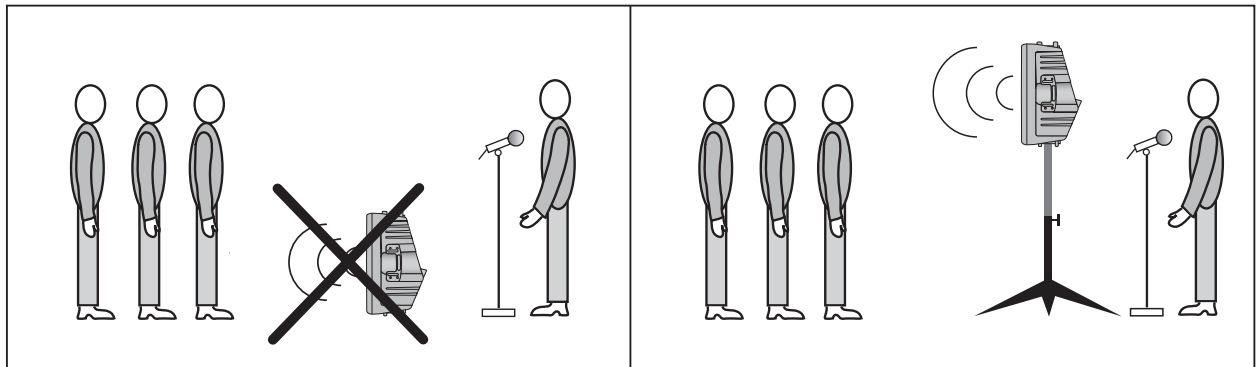

Fig. 5.1: Stand-mounted B300 used for presentations

5.2 P.A. systems

P.A. is short for “public address” and includes all applications that involve a larger audience. Such a system can be composed, for example, of the elements described in chapter 3.2.1. In this case, you would connect microphones, playback devices, effects, etc. to your mixing console.

To increase the sound pressure level, simply add some speakers on each side of the stereo basis. For instance, you could use two B300’s on each side and place them next to or on top of each other. The cutouts in the cabinets guarantee safe stacking.

In this application you would use the LINK OUTPUT to connect one B300 to the XLR input of the second on the same stereo side.

👉 With several B300’s connected to each other, their input impedance will be reduced by half (two B300’s), or to one third (three B300’s), etc. Always use the output impedance of the mixing console as a basis for your calculations!

5.3 Monitoring application

In contrast to P.A. speakers, stage monitors are used to radiate the sound directly to one specific performer. When the performer uses a microphone, it is often difficult to set up the monitor speaker, because the distance between B300 and microphone tends to be very short, which can lead to feedback problems. To avoid this effect, both microphone and monitor speaker must be placed carefully. Some hints on this can be found in chapter 2.2.

In a monitoring application, the B300 is provided with the monitor or aux output signal from a mixing console. If you wish to use further B300’s, you can loop through the audio signal using the LINK OUTPUT on each B300. Sound and volume of each B300 can be controlled with the help of the controls **3** (VOLUME), **6** (HI) and **7** (LO).

👉 If you encounter persistent feedback problems, consider using our proven BEHRINGER FEEDBACK DESTROYER PRO DSP1124P for line-level signals. For signals with line or microphone level we recommend our BEHRINGER SHARK DSP110.

6. SPECIFICATIONS

SPEAKER COMPLEMENT

High-performance woofer 15P200A3

Diameter	15" (385 mm)
Sensitivity	98 dB @ 1 W / 1 m
Impedance	3 ohms
Power (RMS / music)	200 W / 400 W

Tweeter compression driver 34P30A8

Diameter	1.25" (34 mm)
Sensitivity (with horn)	105 dB @ 1 W / 1 m
Impedance	8 ohms
Power (RMS)	30 W / 2 kHz @ 12 dB/oct.

Horn (dispersion angle) 100° x 40°

AMPLIFIERS

Woofer range

Power (RMS)	175 W @ 3 ohms / 0.1% THD
Power (Peak)	230 W

Tweeter range

Power (RMS)	50 W @ 8 ohms / 0.1% THD
Power (Peak)	70 W

Limiter

opto-controlled

AUDIO INPUTS

XLR connector	(servo-balanced)
1/4" TRS	(servo-balanced)
Input resistance	20 kohms
Sensitivity (line)	-4 dB to +18 dB
(mic)	-24 dB to -4 dB

AUDIO OUTPUT

XLR connector

SYSTEM DATA

Frequency range	50 Hz to 18 kHz
Crossover frequency	2 kHz (12 dB / 24 dB)
Bass reflex alignment	6 th order
Max. SPL	124 dB @ 1 m

POWER SUPPLY

Mains voltage	U.S./Canada	120 V ~, 60 Hz
	U.K./Australia	240 V ~, 50 Hz
	Europe	230 V ~, 50 Hz
	General export model	100 - 120 V ~, 200 - 240 V ~, 50 - 60 Hz
Power consumption	300 W max.	
Fuse	100 - 120 V ~:	T 6,3 A H
	200 - 240 V ~:	T 3,15 A H
Mains connection	Standard IEC connector	

PHYSICAL

Dimensions (H x W x D)	approx. 28" (710 mm) x 18" (457 mm) x 16 3/4" (425 mm)
Weight	approx. 31 kg

BEHRINGER is constantly striving to maintain the highest professional standards. As a result of these efforts, modifications may be made from time to time to existing products without further notice. Specifications and appearance may differ from those listed or shown.

7. WARRANTY

§ 1 WARRANTY CARD/ONLINE REGISTRATION

To be protected by the extended warranty, the buyer must complete and return the enclosed warranty card within 14 days of the date of purchase to BEHRINGER Spezielle Studiotechnik GmbH, in accordance with the conditions stipulated in § 3. Failure to return the card in due time (date as per postmark) will void any extended warranty claims. Based on the conditions herein, the buyer may also choose to use the online registration option via the Internet (www.behringer.com or www.behringer.de).

§ 2 WARRANTY

1. BEHRINGER (BEHRINGER Spezielle Studiotechnik GmbH including all BEHRINGER subsidiaries listed on the enclosed page, except BEHRINGER Japan) warrants the mechanical and electronic components of this product to be free of defects in material and workmanship for a period of one (1) year* from the original date of purchase, in accordance with the warranty regulations described below. If the product shows any defects within the specified warranty period that are not excluded from this warranty as described under § 3 and 4, BEHRINGER shall, at its discretion, either replace or repair the product using suitable new or reconditioned parts. In the case that other parts are used which constitute an improvement, BEHRINGER may, at its discretion, charge the customer for the additional cost of these parts.

2. If the warranty claim proves to be justified, the product will be returned to the user freight prepaid.

3. Warranty claims other than those indicated above are expressly excluded.

§ 3 RETURN AUTHORIZATION NUMBER

1. To obtain warranty service, the buyer (or his authorized dealer) must call BEHRINGER (see enclosed list) during normal business hours **BEFORE** returning the product. All inquiries must be accompanied by a description of the problem. BEHRINGER will then issue a return authorization number.

2. Subsequently, the product must be returned in its original shipping carton, together with the return authorization number to the address indicated by BEHRINGER.

3. Shipments without freight prepaid will not be accepted.

§ 4 WARRANTY REGULATIONS

1. Warranty services will be furnished only if the product is accompanied by a copy of the original retail dealer's invoice. Any product deemed eligible for repair or replacement by BEHRINGER under the terms of this warranty will be repaired or replaced within 30 days of receipt of the product at BEHRINGER.

2. If the product needs to be modified or adapted in order to comply with applicable technical or safety standards on a national or local level, in any country which is not the country for which the product was originally developed and manufactured, this modification/adaptation shall not be considered a defect in materials or workmanship. The warranty does not cover any such modification/adaptation, irrespective of whether it was carried out properly or not. Under the terms of this warranty, BEHRINGER shall not be held responsible for any cost resulting from such a modification/adaptation.

3. Free inspections and maintenance/repair work are expressly excluded from this warranty, in particular, if caused by improper handling of the product by the user. This also applies to defects caused by normal wear and tear, in particular, of faders, potentiometers, keys/buttons and similar parts.

4. Damages/defects caused by the following conditions are not covered by this warranty:

- ▲ improper handling, neglect or failure to operate the unit in compliance with the instructions given in BEHRINGER user or service manuals.
- ▲ connection or operation of the unit in any way that does not comply with the technical or safety regulations applicable in the country where the product is used.
- ▲ damages/defects caused by force majeure or any other condition that is beyond the control of BEHRINGER.

5. Any repair or opening of the unit carried out by unauthorized personnel (user included) will void the warranty.

6. If an inspection of the product by BEHRINGER shows that the defect in question is not covered by the warranty, the inspection costs are payable by the customer.

7. Products which do not meet the terms of this warranty will be repaired exclusively at the buyer's expense. BEHRINGER will inform the buyer of any such circumstance. If the buyer fails to submit a written repair order within 6 weeks after notification, BEHRINGER will return the unit C.O.D. with a separate invoice for freight and packing. Such costs will also be invoiced separately when the buyer has sent in a written repair order.

§ 5 WARRANTY TRANSFERABILITY

This warranty is extended exclusively to the original buyer (customer of retail dealer) and is not transferable to anyone who may subsequently purchase this product. No other person (retail dealer, etc.) shall be entitled to give any warranty promise on behalf of BEHRINGER.

§ 6 CLAIM FOR DAMAGES

Failure of BEHRINGER to provide proper warranty service shall not entitle the buyer to claim (consequential) damages. In no event shall the liability of BEHRINGER exceed the invoiced value of the product.

§ 7 OTHER WARRANTY RIGHTS AND NATIONAL LAW

1. This warranty does not exclude or limit the buyer's statutory rights provided by national law, in particular, any such rights against the seller that arise from a legally effective purchase contract.

2. The warranty regulations mentioned herein are applicable unless they constitute an infringement of national warranty law.

* Customers in the European Union please contact BEHRINGER Germany Support for further details.

The information contained in this manual is subject to change without notice. No part of this manual may be reproduced or transmitted in any form or by any means, electronic or mechanical, including photocopying and recording of any kind, for any purpose, without the express written permission of BEHRINGER Spezielle Studiotechnik GmbH.

BEHRINGER, EUROLIVE, FEEDBACK DESTROYER and SHARK are registered trademarks. ALL RIGHTS RESERVED.

© 2002 BEHRINGER Spezielle Studiotechnik GmbH.

BEHRINGER Spezielle Studiotechnik GmbH, Hanns-Martin-Schleyer-Str. 36-38, 47877 Willich-Münchheide II, Germany

Tel. +49 (0) 21 54 / 92 06-0, Fax +49 (0) 21 54 / 92 06-30