

362SW

**User Guide
and
Reference
Manual**

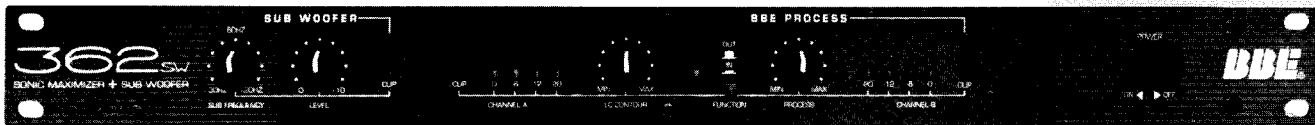

Sonic Maximizer + Sub-woofer Filter...

BBE[®]
Sound, Inc.

Important Safeguards



WARNING

To prevent fire or shock hazard, do not expose the unit to rain or moisture.

ATTENTION: RISQUE DE CHOC ELECTRIC- NE PAS OUVRIR.



The lightning flash with arrowhead symbol, within an equilateral triangle, is intended to alert the user to the presence of uninsulated "dangerous voltage" within the product's enclosure that may be of sufficient magnitude to constitute a risk of electric shock to persons.



The exclamation point, within a equilateral triangle is intended to alert the user to the presence of important operating and maintenance (servicing) instructions in the literature accompanying the appliance.

For your protection, please read these safety instructions completely before operating the appliance, and keep this manual for future reference.

Carefully observe all warnings, precautions and instructions on the appliance and described in the operating instructions supplied with the appliance.

INSTALLATION

Water and Moisture - Do not install the appliance near water: for example, near a bathtub, washbowl, kitchen sink, laundry tub, in a wet basement, or near a swimming pool.

Heat - Do not install the appliance near sources of heat such as radiators, heat registers, stoves, or other appliances that produce heat.

Ventilation - Situate the product so its location or position does not interfere with its proper ventilation. For example, you should not place the product on a bed, sofa, rug, or similar surface that might block the vent openings, or placed in a built-in installation, such as a bookcase or cabinet that might impede the flow of air through the ventilation openings.

Wall or Ceiling Mounting - If your appliance can be mounted to a wall or ceiling, mount it only as recommended.

USE

Power Source - Connect the appliance to a power supply only of the type described in the operating instructions or as marked on the appliance.

Grounding or Polarization - Do not defeat the grounding or polarization feature of the AC power cord. If your AC receptacle will not accept the power cord plug, contact your electrician to install a proper AC receptacle.

AC Receptacle - Check to make sure that the AC receptacle holds the power cord plug firmly and securely. If the power cord plug is loose, contact your electrician to replace the defective and unsafe AC

Power-Cord Protection - Route the power cord so that it is not likely to be walked on or pinched by having objects placed on it, paying particular attention to the plugs, receptacles, and the point where the cord exits from the appliance.

When not in use - Unplug the power cord of the appliance from the outlet when left unused for a long period of time. To disconnect the cord, pull it out by grasping the plug. Never pull the plug out by the cord.

Foreign Objects - Be careful that foreign objects and liquids do not enter the enclosure through openings.

SERVICE

Unplug the appliance from the wall outlet and consult qualified service personnel when:

- the power cord or the plug has been damaged.
- a solid object or liquid has fallen into the cabinet.

- the appliance has been exposed to rain or moisture.
- the appliance does not appear to operate normally or exhibits a marked change in performance.
- the appliance has been dropped, or the enclosure damaged.

Do not attempt to service the appliance beyond that described in the operating instructions. For all other servicing, refer to qualified service personnel **only**.

Welcome

Congratulations on your purchase of the BBE 362SW Sonic Maximizer + Sub-woofer Filter - a two channel signal processor that will benefit any sound reproduction system. You now own a very unique signal processing tool with no equal in the audio world. We're confident that with your purchase of the BBE 362SW, you will find its rugged construction and careful electronic design a welcome addition to your sonic arsenal.

This book is divided into two main parts: the User Guide and the Reference Manual. The User Guide will help you to effectively use the BBE process and sub-woofer filter. In this section you'll find complete instructions regarding the controls and connections, along with some application notes and diagrams. In the Reference Manual, we've included specifications, a calibration procedure, and all of the related technical information regarding Service, Warranty and Maintenance for your product.

Thank you for your purchase, and for the trust that you've placed in BBE. We are committed to bringing you the finest products, with useful and unique features, to solve your audio needs. If you have any comments or questions about this product that are not answered in this book, please feel free to call us at (714) 897-6766 - we're always glad to be of service.

User Guide Contents

Important Message	inside cover
Welcome	1
The BBE Process Explained	2
Product Description	3
Controls and Connections	4-5
Application Notes / Diagrams	6-8

Reference Manual Contents

Specifications	9
Warranty	10
Maintenance & Service	11
Calibration Procedures	12-13
Schematic Diagrams	14-17

The BBE Process Explained

What is BBE? (some big words to describe the mysteries of our little black box)

Loudspeakers have difficulty dealing with the electronic signals supplied by an amplifier. These difficulties cause such major phase and amplitude distortion that the sound reproduced by a speaker differs significantly from the sound produced by the original source.

In the past, these problems proved unsolvable and were thus delegated to a position of secondary importance in audio system design. However, phase and amplitude integrity is essential to accurate sound reproduction. Research shows that the information which the listener translates into the recognizable characteristics of a live performance are intimately tied into complex time and amplitude relationships. These relationships define a sound's "sound".

When these complex relationships pass through a speaker, the proper order is lost. The listener perceives this loss of sound integrity in the reproduced sound as "muddy" and "smeared".

BBE Sound, Inc. conducted extensive studies of numerous speaker systems over a ten year period. With this knowledge, it became possible to identify the characteristics of an ideal speaker and to distill the corrections necessary to return the fundamental and harmonic frequency structures to their correct order. While there are differences among various speaker designs in the magnitude of their correction, the overall pattern of correction needed is remarkably consistent.

The BBE process is so unique that 42 patents have been awarded by the U.S. Patent Office.

How does BBE work? (a mildly technical expose - for those that need to know)

The BBE Process imparts a predetermined phase correction to the high frequencies where most harmonic information exists. This is done by breaking the signal into three sub-bands or groups:

- a.) LOWs (20Hz-150Hz)
- b.) MIDs (150Hz-1200Hz)
- c.) HIGHs (1200Hz-20kHz).

The low group is delayed about 2.5 ms (milliseconds) via a delay within the passive low pass filter. The front panel LO CONTOUR control allows for either a flat response or a boost at 50Hz. The mid-range group is delayed only about 0.5ms and passes through an active band-pass filter while the high frequency group is passed through a VCA (Voltage Controlled Amplifier). The high group is used as a point of reference to make dynamic amplitude corrections to the high frequencies.

The RMS average loudness detectors continuously monitor both the mid-range and high frequencies to compare the relative harmonic content levels of the two bands and apply the appropriate amount of control voltage to the VCA, thereby determining the amount of high frequency harmonic content present at the final output of the BBE processor.

Product Description

The BBE 362SW is an intelligent audio processor and a sub-woofer filter network combined into one unit. The true beauty of the BBE 362SW is in its ease of set-up and operation. The BBE 362SW is a ganged dual channel, single rack space device for use in -10dBu unbalanced line level applications.

The BBE portions of the BBE 362SW consist of a Function switch, Lo Contour control, Process control and a pair of clip lights. The Function switch is for comparing the processed sound to the direct sound. The Lo Contour control is for adjusting the level of phase corrected low frequencies in the program material. The Process control is for adjusting the level of the phase corrected high frequencies in the program material. Each channel output is monitored by a clipping circuit which turns on a LED when the output level is at 3dB below true clipping.

The Sub-woofer Filter portion of the BBE 362SW consists of a Sub-woofer Frequency control and a Sub-woofer Level control. The phase corrected low frequency information from both channels is summed together and directed through an 18dB/octave filter network. The Sub-woofer Frequency control adjusts this filter, and has a selectable range from 30hz to 120hz. By simply adjusting the Frequency control you can set the filter's frequency point of the Sub-woofer circuit. For example, if you set the Frequency control to 40hz - then only the information below 40hz will be sent to the Sub-woofer Output jack. The Sub-woofer Level control adjusts the output level of the sub-woofer circuit. The level is adjustable from fully off to a gain of 6dB.

Front Panel Controls

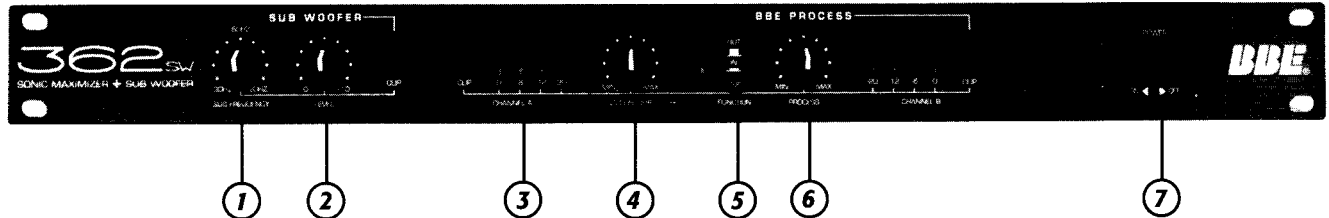

- 1. SUB-WOOFER FREQUENCY:** The phase corrected low frequency information from both channels is summed together and directed through an 18dB/octave filter network. The Sub-woofer Frequency control adjusts this filter, and has a selectable range from 30hz to 120hz. By simply adjusting the Frequency control you can set the filter's frequency point of the Sub-woofer circuit. For example, if you set the Frequency control to 40hz - then only the information below 40hz will be sent to the Sub-woofer Output jack.
- 2. SUB-WOOFER LEVEL:** This control adjusts the output level of the sub-woofer circuit. The level is adjustable from fully off to a gain of 6dB.
- 3. CLIP LEDs:** These LEDs indicate when the output of the BBE 362SW is 3dB below true clipping.
- 4. LO CONTOUR:** Each channel shares a common Lo Contour control that regulates the amount of phase corrected bass frequencies.
- 5. BBE FUNCTION:** This push button switch allows for quick comparison of the processed and unprocessed sound. When the switch is pushed in, the process is on and the indicator LED is green. When the switch is out, the process is off and the indicator LED is red.
- 6. PROCESS:** Each channel shares a common Process control that regulates the amount of phase corrected treble frequencies.
- 7. POWER:** This switch controls the primary power to the BBE 362SW.

Rear Panel Connections

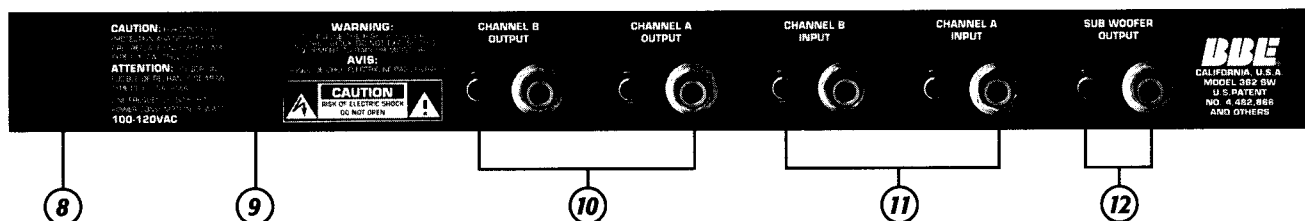

8. **AC POWER CORD:** Plugs into AC power receptacle. U.S. Model, 100-120Vac, 50/60Hz. All other models, 200-240Vac, 50/60Hz.
9. **FUSE:** Turn cap on fuse holder counterclockwise to remove fuse. (Note: For U.S. Model, replace with 250Vac, 1/2A Fastblow type fuse. For all other models, replace with 250Vac, .125A Fastblow type fuse.)
10. **UNBALANCED FULL RANGE OUTPUTS:** Each channel is equipped with a 1/4" phone jack and an RCA jack - each sends a low impedance line level output, and can deliver up to a +16dBu into 1K Ohms.
11. **UNBALANCED INPUTS:** Each channel is equipped with a 1/4" phone jack and an RCA jack that accepts a high impedance unbalanced line level input with an average of -10dBu. (Note: +16dBu is the maximum input before clipping.)
12. **UNBALANCED SUB-WOOFER OUTPUTS:** The Sub-woofer output is equipped with a 1/4" phone jack and an RCA jack - each sends a low impedance line level output.

Application Notes

Benefits of a Sub-Woofer System

First, let's define sub-woofer: a sub-woofer is a specially designed speaker system that reproduces ultra-low frequencies only. You may have heard these systems called "subs", or a "sub bin" - but why are they important? In a standard "full-range" speaker enclosure, the components inside are required to reproduce the entire range of sound, from bass to midrange to highs, all in the same "box". In large applications, and in high-power applications, the resulting sound can be muddy, garbled and lacking punch. With a sub-woofer system, the sound is routed through a filter (like the BBE 362sw) where the sound is divided into two "bands". The mids and highs go to the main power amp and then to the regular "full-range" speaker cabinets, while the lows (bass) are sent to a separate power amp and then to the specially designed "sub-woofer" speaker cabinets. The resulting sound is more defined, punchier, and capable of remaining loud and clear in most any application. You'll find the BBE 362SW the perfect solution for maximizing your sonic needs (!) as well as controlling that all important sub-woofer punch.

Things to Remember

The BBE 362SW is designed to work with -10dBu levels. This is suitable for most semi-pro mixers, P.A. consoles, home recording systems, or D.J. equipment. The BBE 362SW drives load impedances down to 1K Ohm and supplies a maximum output level of +16dBu. Plugging a guitar or other high impedance device into the BBE 362SW will not work properly as its input impedance is 50K Ohms.

Set-Up

The BBE 362SW is connected into the chain in series with the signal path the same way a graphic EQ or limiter would be connected. The output of a mixer, pre-amp, or other sound source feeds the input of the BBE 362SW. Setting up the BBE 362SW as an aux. send device like a reverb is not recommended as the processed effect is not fully realized when summed in parallel with the original audio source.

WARNING !

To prevent possible speaker or amplifier damage, always power-up peripheral devices first, wait 10 seconds, and then turn on the power amplifier. Turn off power amplifier first, then power down peripheral devices.

Application Diagram (A)

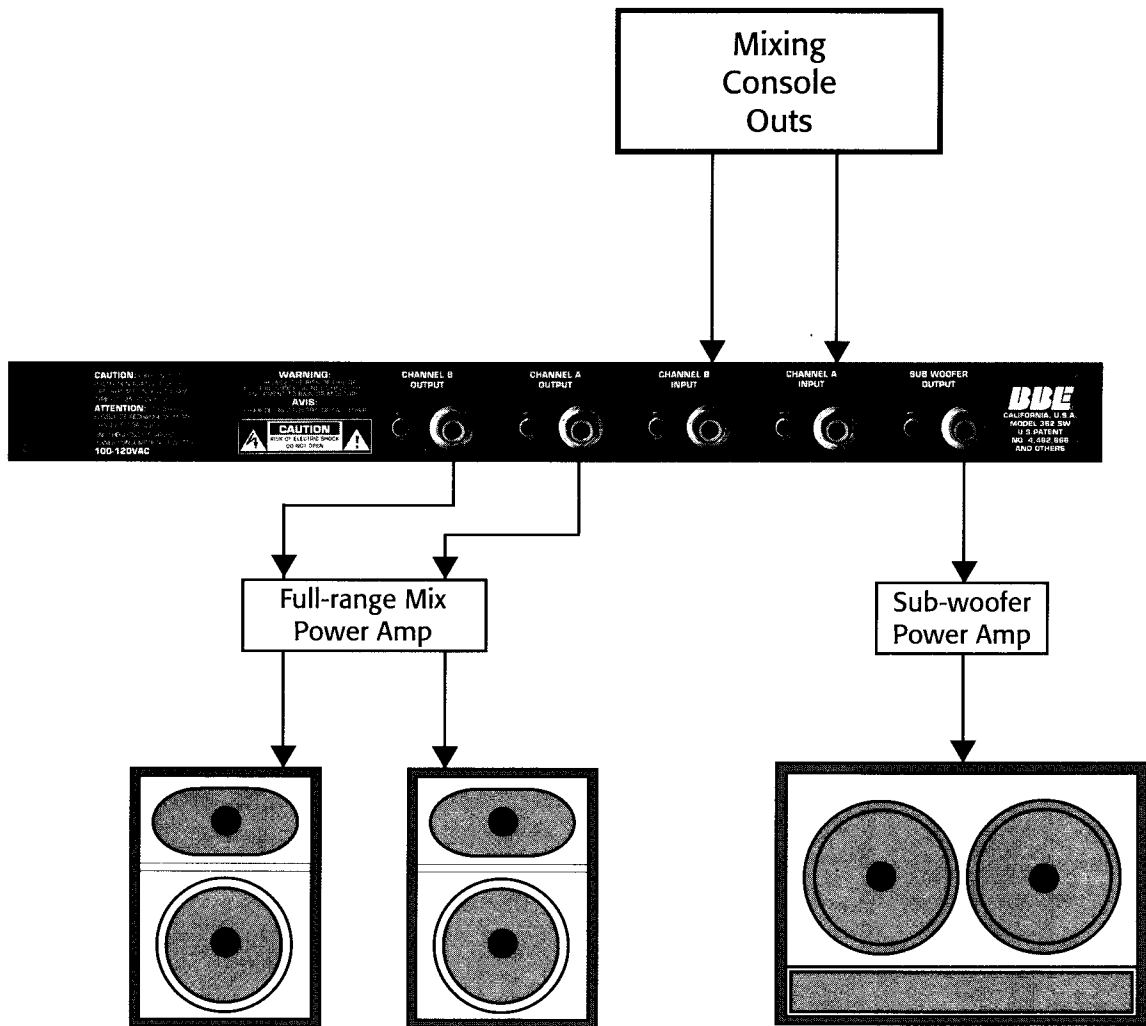

Application Diagram (B)

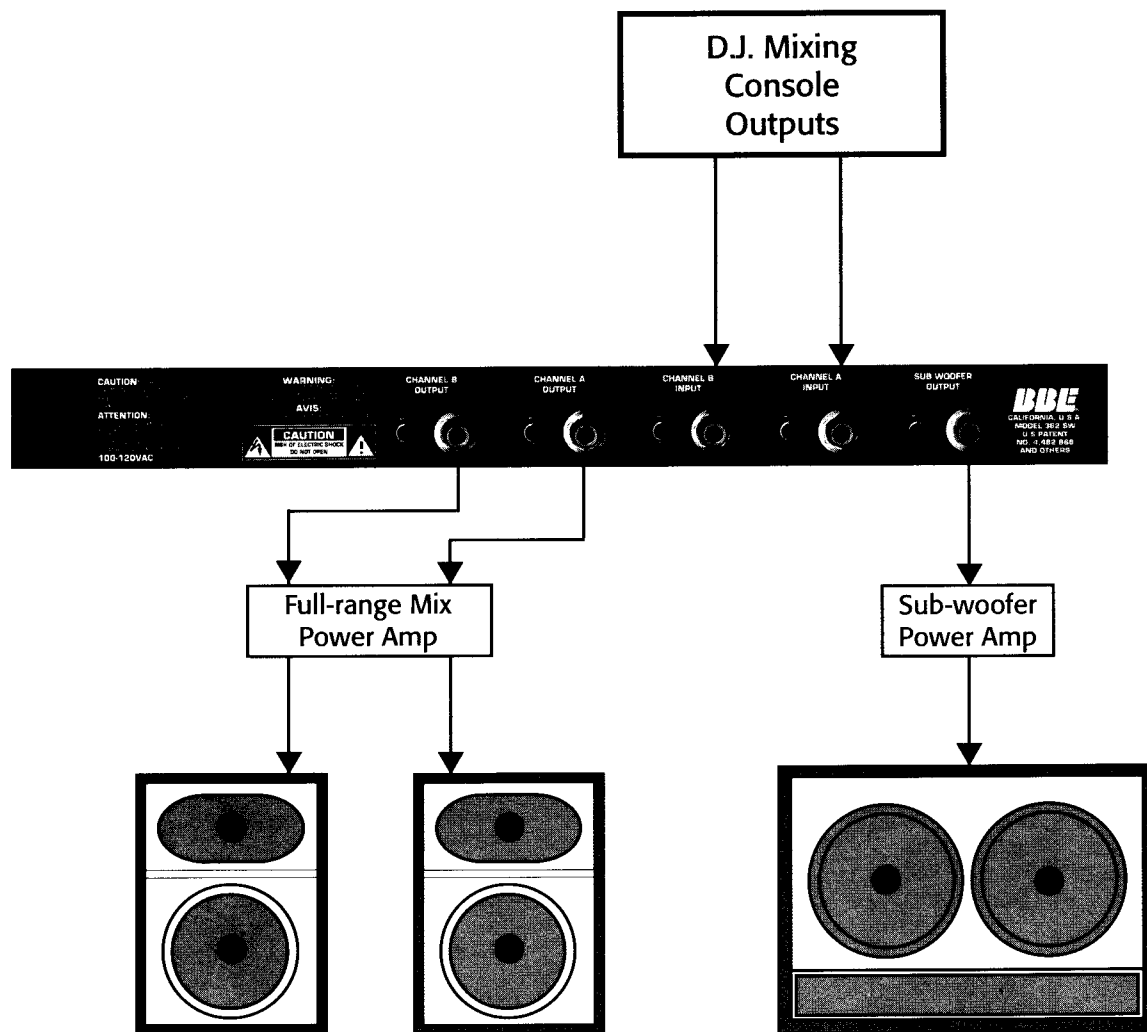

BBE 362sw

Sonic Maximizer + Sub-woofer filter

Reference Section

BBE 362SW Specifications

Frequency Response

Bypass 5hz to 30kHz
Process program controlled
Signal to Noise Ratio 108dB process in
120dB process out

Total Harmonic Distortion

in Process mode less than 0.1%@-10dBu level

Input Characteristics

Input Impedance 50k Ohms
Nominal Input Level -10dBu

Output Characteristics

Minimum Load Impedance
for full output level 1k Ohm
Nominal Output Level -10dBu
Maximum Output Level +20dBu

Power Requirements

U.S. Model 100-120Vac, 50/60Hz, 10 Watts
All Other Models 200-240 Vac, 50/60Hz, 10 Watts

AC Line Fuse protected
..... U.S. Model: 250Vac / 1/2A Fastblow type fuse
..... All Others: 250Vac / .125A Fastblow type fuse

Terminations / Connectors

-Rear Panel 1/4" Phone jacks / RCA Jacks

Dimensions Standard 1U single rack space
..... 1 3/4"H x 19"W x 5 3/4"D

Weight 4 1/2 lbs. (2.5kgs)

Note: 0dBu = 0.775 Vrms

Note: Due to continuing product improvement, specifications and design are subject to change without notice.

Warranty Information

Warranty registration of the unit to BBE Sound, Inc. is not necessary. It is strongly recommended that you retain a copy of the bill of sale (receipt) for future reference and warranty claims.

IT IS THE SOLE RESPONSIBILITY OF THE END USER TO PROVIDE THE BILL OF SALE OR OTHER MEANS OF PROOF OF PURCHASE TO VALIDATE THE WARRANTY IF WARRANTY SERVICE IS REQUESTED.

The BBE 362SW is warranted against defects in material and workmanship for a period of five (5) years from date of purchase from BBE Sound, Inc. or from an authorized dealer. During this period, we will repair units free of charge providing that they are shipped prepaid to:

BBE Sound, Inc.
5381 Production Drive
Huntington Beach, CA 92649

We will pay return UPS shipping charges within the USA. All charges related to non-UPS shipping, including customs clearance, will be billed. The warranty will be honored for the longer or either 90 days from the date of any service, or the remainder of the original 5 Year factory warranty.

This warranty will be considered null and void by BBE Sound, Inc. if any of the following is found:

1. The equipment has been physically damaged.
2. The equipment shows signs of abuse.
3. The equipment has been electronically damaged by improper connection or attempted repair by the customer or a third party.
4. The equipment has been modified without authorization.
5. The bill of sale indicates that the purchase date of the equipment is not within the warranty period.

All non-warranty repairs are warranted for a period of 90 days from the date of service.

BBE Sound, Inc. is NOT LIABLE FOR CONSEQUENTIAL DAMAGES. Should the unit fail to operate for any reason, our sole obligation is to repair it as described above. DO NOT RETURN ANY PRODUCT TO THE ABOVE ADDRESS WITHOUT PRIOR INSTRUCTION AND A RETURN AUTHORIZATION ISSUED BY BBE SOUND, INC.

Service and Maintenance Info

Maintenance

Maintenance of the BBE 362SW is limited to proper cleaning of the unit with mild household cleaner such as Formula 409 or Windex. The chassis and cover are steel finished with a durable polyurethane paint, while the front panel is an anodized aluminum extrusion.

There are no user replaceable parts and the unit should not be opened for any reason unless you are a qualified technician. Calibration should be performed if parts are replaced or if a performance check-out indicates a problem with calibration. Long term use has shown that over the life of this unit there is little or no drift of the components in the BBE 362SW which would cause a change in calibration. A very conservative design philosophy has resulted in a piece of equipment which runs very cool and should give years of trouble-free service.

Service

We recommend that if at all possible, a BBE 362SW which requires service be sent to our facility in Huntington Beach, California. We request that a "Return Authorization" be issued by the dealer from whom you purchased the unit. If this is not possible, please call BBE Sound, Inc. directly (714)897-6766, to obtain a "Return Authorization". Please include a copy of the bill of sale (receipt) with the unit when it is shipped to BBE Sound, Inc. so that the service can be expedited.

Calibration Procedure

**Note: This unit was calibrated at the factory.
This procedure is for qualified service personnel only.**

Initial Settings:

1. Sub Frequency control VR4, Sub Woofer Level control VR3, BBE Process control VR2, LO Contour VR1 to minimum. (fully counterclockwise)
2. Power Switch on and BBE Function Switch in (Process On).

Power Supply Test:

1. With DVM set to D.C. volts, measure the positive end of C37. You should read less than +30 VDC.
2. With DVM set to D.C. volts, measure the negative end of C39. You should read less than -30 VDC.

BBE Process Test:

1. Input a 5kHz signal @ -10dBu into channel A [B] input
2. Measure the channel A [B] output with the DVM set to A.C. volts.
3. With process control at minimum (fully C.C.W.), DVM should read -10.5dBu (+/- 0.5dBu).
4. With process control at maximum (fully C.W.), DVM should read -2dBu (+/- 0.5dBu).

Lo Contour Test:

1. Input a 50Hz signal @ -10dBu into channel A [B] input.
2. Measure the channel A [B] output with the DVM set to A.C. volts.
3. With Lo Contour control at minimum (fully C.C.W.), DVM should read -10dBu (+/- 0.5dBu).
4. With Lo Contour control at maximum (fully C.W.), DVM should read -1.5dBu (+/- 0.5dBu).

Bypass Test:

1. Input a 500Hz signal at -10dBu into channel A [B] input.
2. Measure the channel A [B] output with the DVM set to A.C. volts.
3. With the Process in, the DVM should read -11dBu (+/- 0.5dBu) and the Process LED should illuminate green.
4. With the Process out, the DVM should read -10.5dBu (+/- 0.5dBu) and the Process LED should illuminate red.

Calibration Procedure (continued)

Channel Clip Indicator Test:

1. Input a 500Hz signal @ +15dBu into the channel A [B] input.
2. Verify that the channel A [B] clip indicator is on and that all of the level indicators are on.
3. Change signal input level to +13dBu and verify that the channel A [B] clip indicator turns off while leaving the level indicators on.

Sub Woofer Test:

1. Input a 50Hz signal @ -10dBu into channel A [B] input.
2. Measure the sub woofer output with the DVM set to A.C. volts.
3. With the SUB Frequency control and the SUB Woofer Level control at minimum (fully C.C.W.), DVM should read less than -70dBu.
4. With SUB Woofer Level control at maximum (fully C.W.), DVM should read -9.0dBu (+/- 0.5dBu).
5. With SUB Frequency control at maximum (fully C.W.), DVM should read -4.0dBu (+/- 0.5dBu).

Sub Woofer Clip Indicator Test:

1. Input a 50Hz signal @ +9dBu into the channel A [B] input.
2. Verify that the SUB Woofer clip indicator is on.
3. Change signal input level to +6dBu and verify that the SUB Woofer clip indicator turns off.

**** End of Test ****

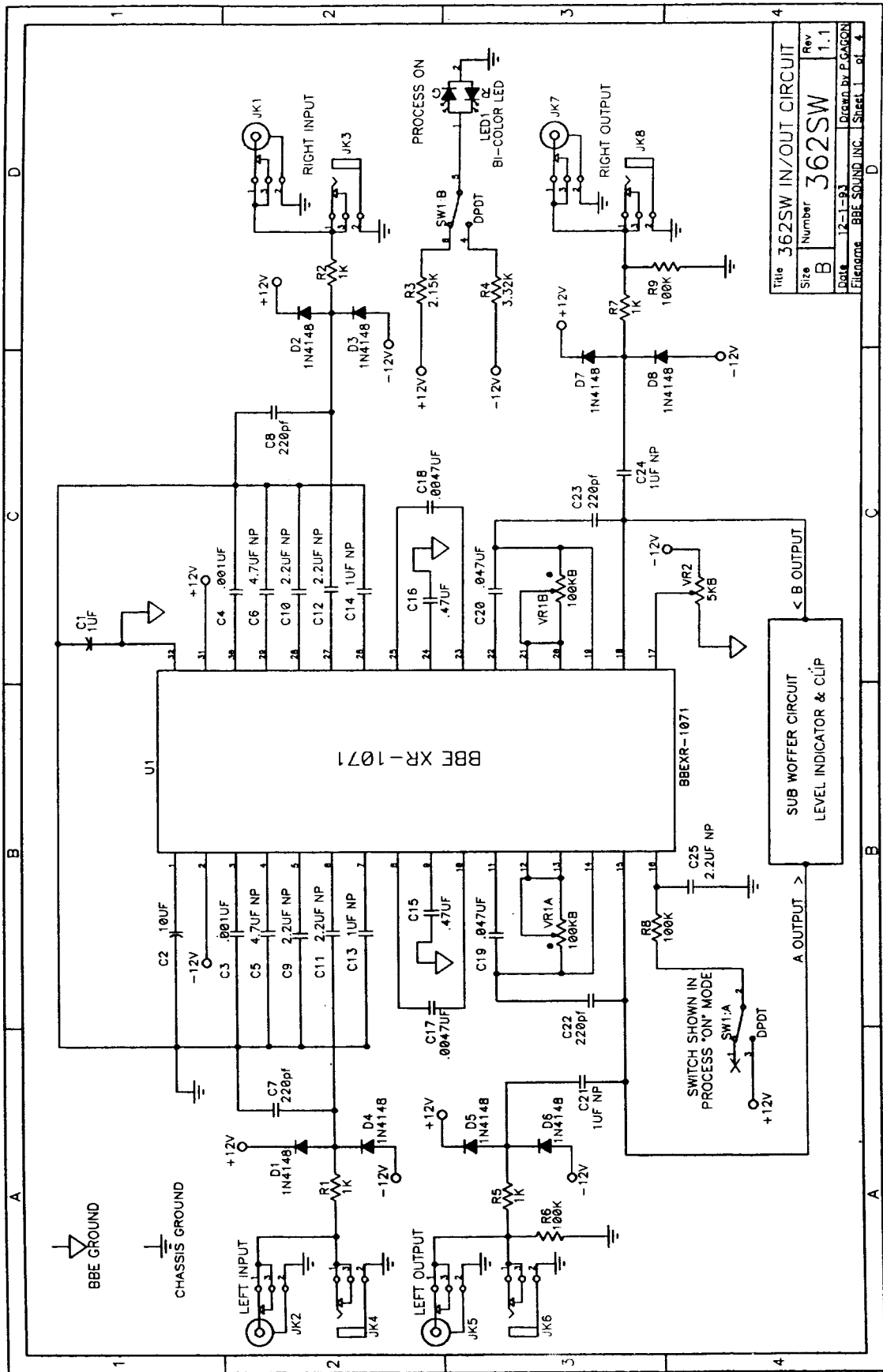

Title 362SW IN/OUT CIRCUIT	
Size B	Number 362SW
Date 12-1-93	Rev 1.1
Designed by P. GAGON	
Filename BBE SOUND INC. Sheet 1 of 4	

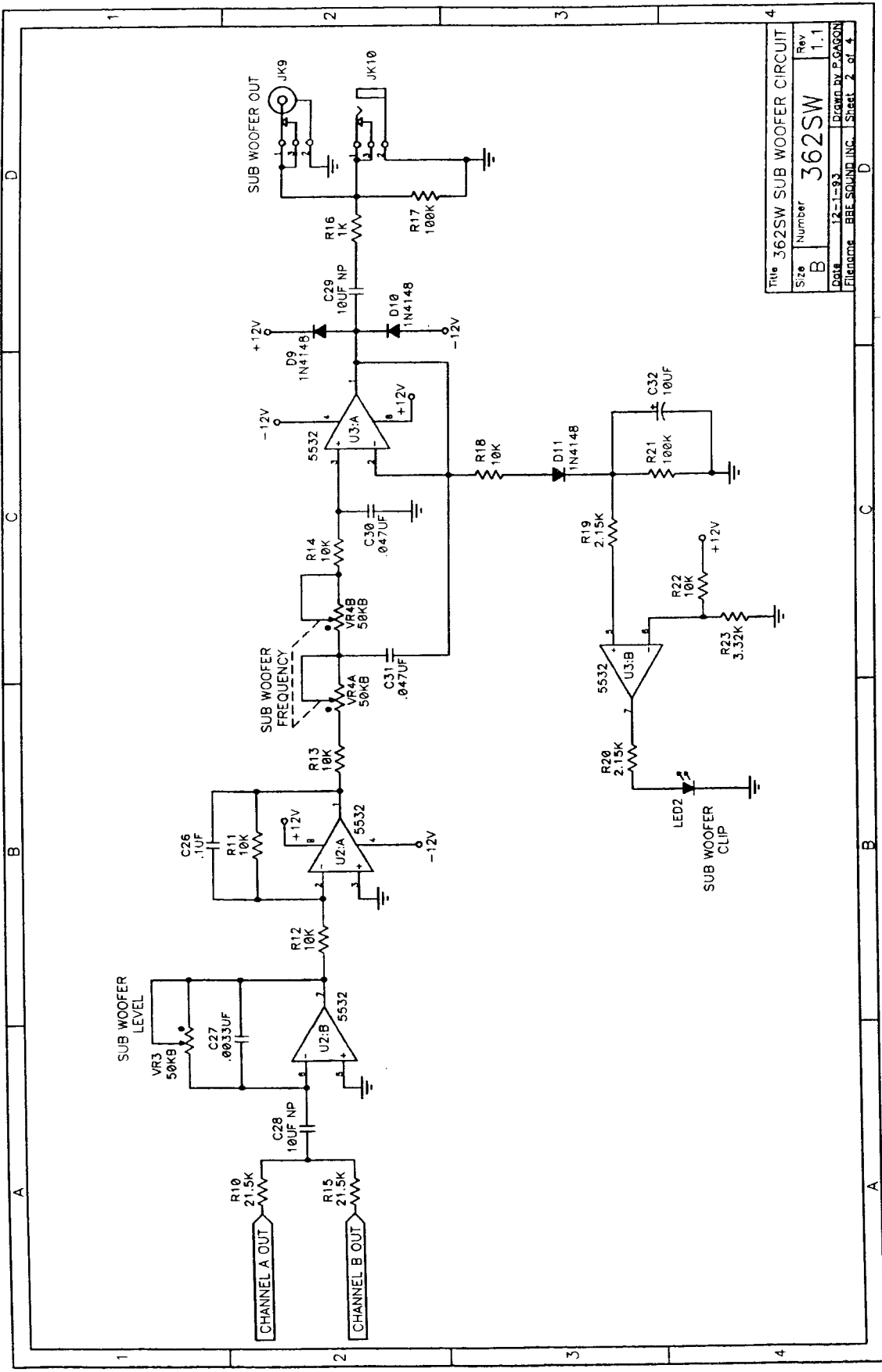

Title 362SW SUB WOOFER CIRCUIT		Rev	1.1
Size	B	Number	362SW
Date	12-1-93	Drawn by	P. GAGON
Filename	BBE_SOUND_INC	Sheet	2 of 4

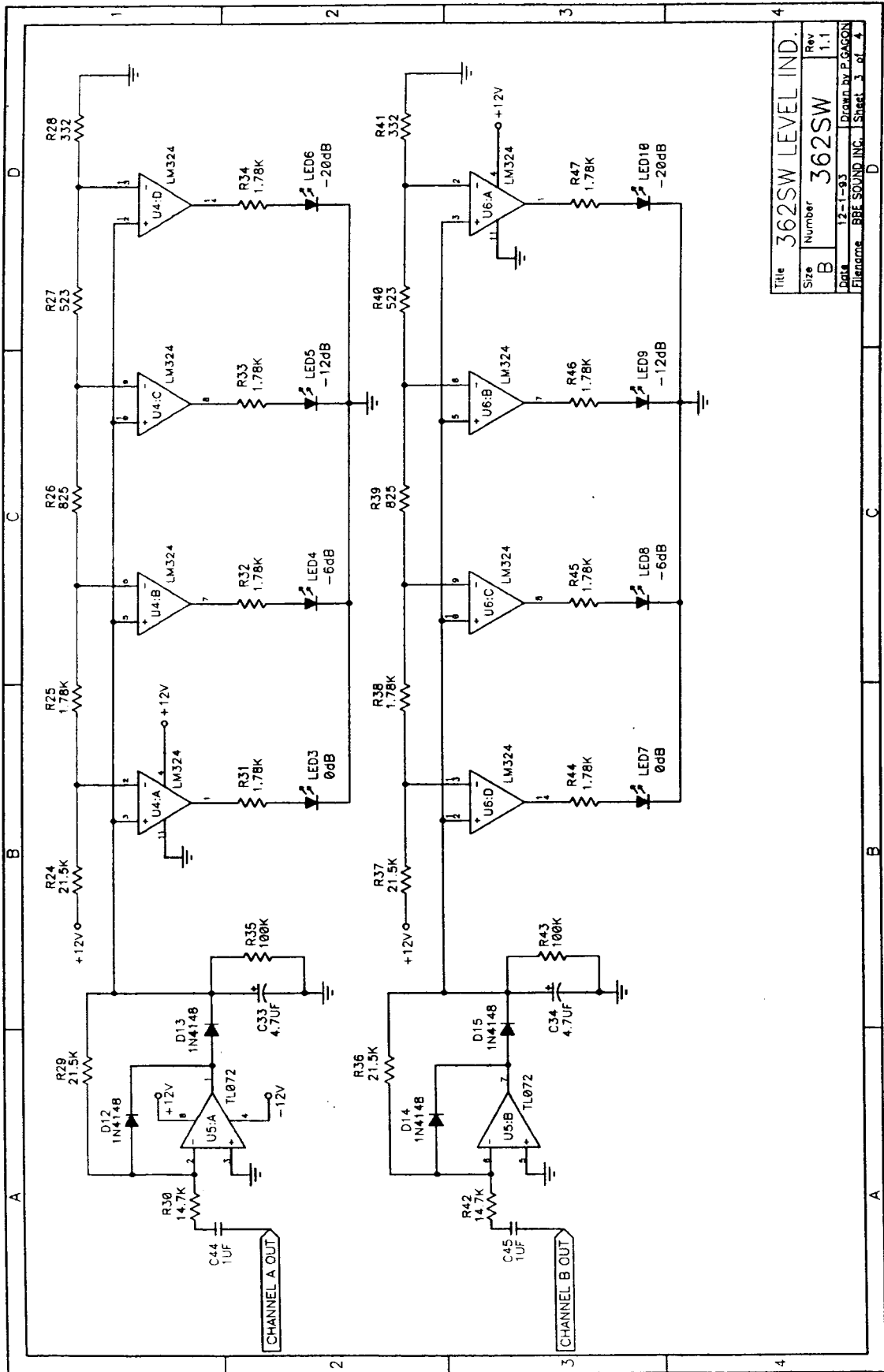

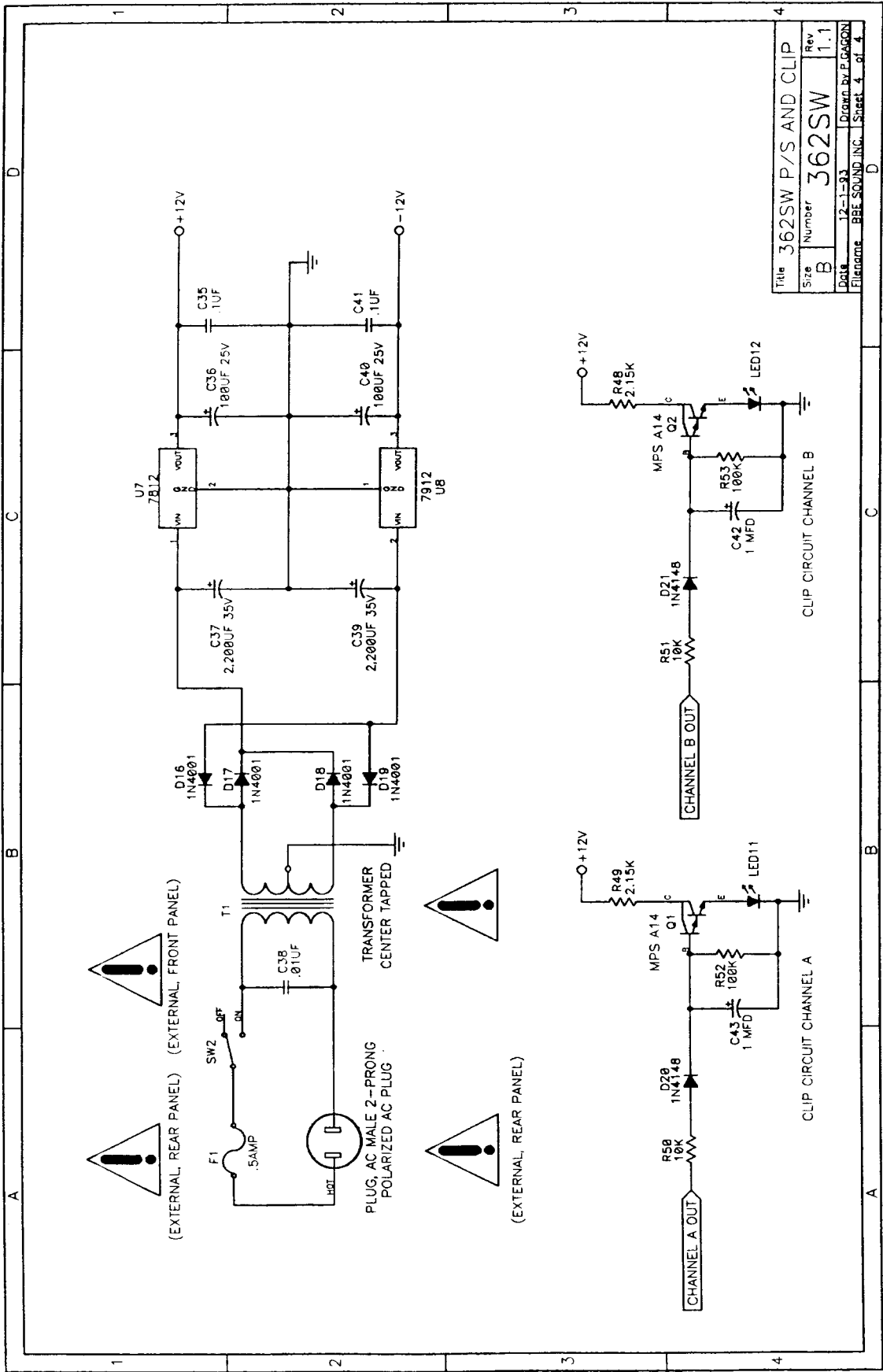

Title 362SW P/S AND CLIP	
Size B	Number 362SW
Date 12-1-83	Rev 1.1
Drawn by P. BAGDON	
Filename BSE SOUND INC. Sheet 3 of 4	



BBE[®]
Sound Inc.

5381 Production Drive
Huntington Beach, CA 92649
714-897-6766 • FAX 714-896-0736

www.bbесound.com

covered by U.S. Patent 4,482,866 and other U.S. and foreign patents pending.
BBE is the registered trademark of BBE Sound, Inc.