

M-AUDIO

Studiophile™

BX8a Deluxe

English
User Guide

Introduction

Thank you for choosing the Studiophile Series BX8a Deluxe bi-amplified studio near-field monitor speakers. M-Audio is well known for digital audio interface technology, digital converters, audio preamps and mixers. Now, after extensive research and development, M-Audio is proud to present the Studiophile BX8a Deluxe.

The BX8a Deluxe was designed and tested by veteran audio engineers to meet your needs in a studio monitoring environment. It is focused on the functional goal of delivering pure, original sound without any additional coloration. The BX8a Deluxe monitor is self-powered, directly accepting a line-level signal from a variety of sources.

The Studiophile BX8a Deluxe is designed to overcome all the limitations of conventional studio reference monitors within the digital audio environment. This system delivers a wide-range frequency response by employing two extraordinary drivers and unique crossover technology licensed by M-Audio. It boasts a stable and balanced low-mid frequency response along with a defined mid and high-frequency response as well. Both drivers are magnetically shielded for desktop music production.

For pro engineers at commercial studios to home studio owners, the Studiophile BX8a Deluxe sets a new affordable standard in studio monitoring.

What's in the Box?

Your Studiophile BX8a Deluxe box contains:

- Two BX8a Deluxe speakers
- Two detachable AC power cords
- This manual

Studiophile BX8a Deluxe Features

1. Woofer

The woofer unit is 8 inches in diameter with a magnetically shielded Kevlar cone, high-temperature voice coil and damped rubber surround. It is designed to deliver balanced mid and low-frequency response. M-Audio's new BX8a Deluxe employs Kevlar for low-frequency driver construction. The same material used in bullet-proof vests, Kevlar's high resilience makes it ideal for use in speaker cones—although it is typically reserved for monitors with higher price tags than the BX8a Deluxe. Needless to say, Kevlar represents a significant improvement over the polypropylene and paper used in most monitors at this price.

2. Tweeter

By employing a specially developed 1-1/4 inch silk dome with magnetic shielding, the tweeter can deliver distortion-free original sound and offer an extremely natural response. Its design minimizes reaction time by using a specially shaped silk dome for excellent delivery, and also minimizes resonance by adapting a unique internal damping technology.

3. Sub-Frequency Port

The air vent hole in the rear panel is called a Sub-Frequency Vent Port and is designed to allow the discharge of extremely low frequencies occurring below 30Hz.

4. Enclosure

Like the other components, the BX8a's enclosure has an important role in shaping the overall sonic response. In order to provide more stable performance, the BX8a's enclosure employs a special high acoustic efficiency MDF and unique interior reinforcement designed to absorb vibration and impact generated under extreme conditions. The custom design on the front panel will aid in diffraction and will benefit stereo imaging.

5. Network and Power Amplifiers

The active crossover network and power amplifiers for the BX8a Deluxe are specially designed for its woofer and tweeter. The network properly distributes low, mid, and high frequencies to the driver components in order to reduce distortion and loss of sound, thus achieving a naturally balanced sound.

In order to generate powerful, ultra-crisp sound, there are two separate power amplifiers inside the BX8a Deluxe for driving the woofer and tweeter separately in a high-end bi-amp structure. The power delivered to the woofer driver at a low-rated distortion is 70W, and 60W is also delivered to the tweeter.

Front and Rear Panel Features

Rear Panel Features



1. **XLR INPUT:** This jack accepts XLR input connections with either balanced or unbalanced wiring. The input wiring of an XLR connector should be as follows:

- XLR PIN 1 signal ground (shield)
- XLR PIN 2 signal positive (+)
- XLR PIN 3 signal negative (-)

2. **TRS INPUT:** This jack accepts 1/4" connections with either balanced or unbalanced wiring. For balanced wiring, a three-conductor TRS plug is necessary. The input wiring of a TRS connector should be as follows:

- TRS TIP signal positive (+)
- TRS RING signal negative (-)
- TRS SLEEVE signal ground (shield)

Unbalanced 1/4" wiring can be done with either a two- or three-conductor (TS or TRS) plug. A two-conductor (TS) plug automatically grounds the signal negative input, whereas a three-conductor (TRS) plug, wired unbalanced, provides the option of leaving the negative input open or grounded. We recommend that you ground the unused negative input (this can be done by wiring the ring and sleeve of the TRS plug together).

The TRS input is summed through a balanced input amplifier with the XLR input, allowing both inputs to be used simultaneously. Input specifications apply to both.

3. **PRODUCT SPECIFICATION:** This label contains the model and specification information.
4. **SUB-FREQUENCY VENT PORT:** This port aids in reproduction of very low frequencies by discharging frequencies below 30Hz.
5. **VOLUME CONTROL:** Use the volume control to set the output sound pressure from the BX8a Deluxe to proper levels as required.
6. **POWER RECEPTACLE:** Accepts a detachable 3-circuit line cord in order to power the monitor.
7. **FUSE HOLDER:** Holds the external main fuse.
8. **VOLTAGE-SELECT SWITCH:** Provides two selections, 115V AC and 230V AC, and should be set to match the "house supply" (receptacle) voltage of the country or location in which the speaker is used. The 115V setting is correct for the USA and Japan, while the 230V setting is correct for most of the UK and Europe.
9. **POWER SWITCH:** This switch turns the monitor on and off.

Front Panel Features

The front panel houses the Power LED, which indicates whether the speakers (amplifier) power is on or off.

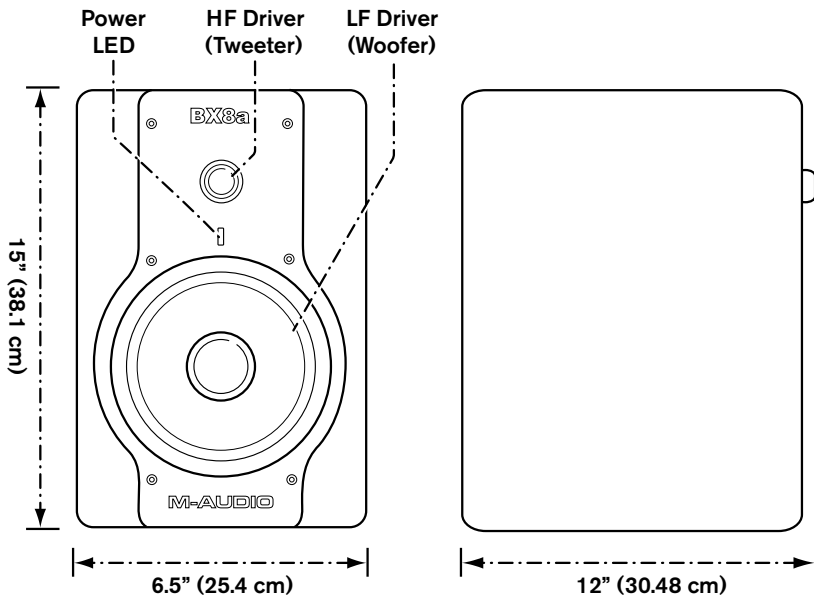

Installation

For optimal performance of the BX8a Deluxe, please read the following thoroughly and carefully prior to installation.

Precautions

Handling: Please do not touch the speaker cones. The BX8a set is packaged in the box tightly, so your attention is required when taking the monitors out of the box. To avoid possible damage to the speaker units, hold both sides of the monitor in order to pull it out of the box. The speaker cones should not be touched in order to avoid damage even after they are out of the box.

Correct Power Operation: Since the BX8a Deluxe contains its own amplifier, it must be connected to a power outlet using the detachable AC cable provided. Before connecting power, please make sure that the Voltage-Select Switch located on the speaker's rear panel is set to the appropriate position, as described in the rear-panel features list appearing earlier in this manual.

WARNING! - Use of improper Voltage-Select Switch combinations may result in hazardous conditions and/or damage to speaker components not covered by speaker warranty.

Connections: You can connect either an XLR balanced cable or TRS balanced/unbalanced cable from the input of each BX8a to your corresponding preamp, computer or game console outputs. We recommend that you use high-quality balanced or unbalanced cables for input connections. Also, ALWAYS turn off the power of the BX8a and turn the volume of the BX8a down to a minimum before making the necessary connections.

XLR Balanced Connection

Assure that the power switch of the BX8a is turned off and that the volume control of the BX8a is turned down to a minimum. Connect the male end of an XLR balanced cable to the balanced input of the BX8a Deluxe (refer to the following diagram for balanced connection).

TRS Balanced/Unbalanced Connection

Assure that the power switch of the BX8a is turned to off and that the volume control of the BX8a is turned down to a minimum. Connect the male end of a TRS balanced or TS unbalanced cable to the TRS input of the BX8a Deluxe (refer to the following diagram for TRS connection).

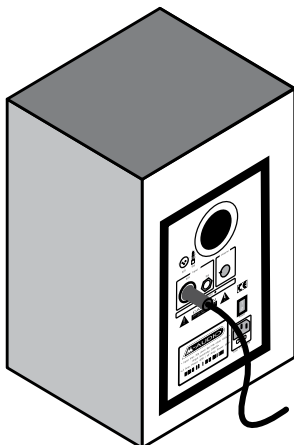

XLR Balanced Connection

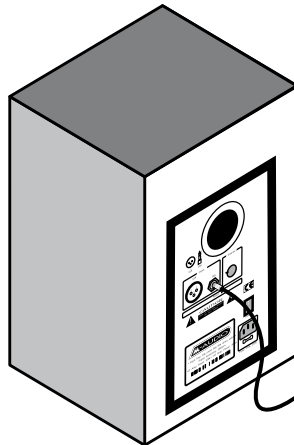

1/4" TRS Balanced or Unbalanced Connection

Connecting to Preamp or Computer Outputs

Before connecting, make sure the output device's power has been turned off. Plug the XLR balanced, TRS balanced or TS unbalanced cable to the corresponding output connectors of a pre-amplifier, computer or game console.

Placing the BX8a Deluxe

Placing the speakers is one of the most important procedures in order to monitor sound accurately. To monitor with the BX8a's performing to their maximum capability, an appropriate listening environment and correct placement are required. Please refer to the following for correct BX8a placement.

1. The two units and the listener should basically align to form a regular triangle. Refer to the following diagram.
2. Position the monitors so that the top of the woofers are level with your ears in a normal listening environment. Refer to the following diagram.
3. Place the BX8a's vertically with the woofer on the bottom. Placing the BX8a's horizontally is not recommended.

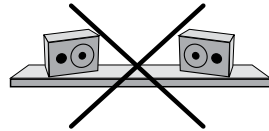
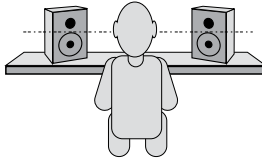
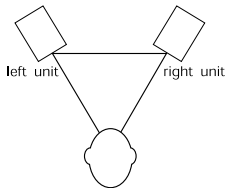

Remarks: *DO NOT place any obstacles that may block the flow of air in front or between the monitors. Also remove reflective materials such as glass, mirrors or metal from the monitoring environment. PLACE THOSE MATERIALS AWAY FROM THE PATH OF THE SOUND FROM THE BX8a's.*

Warranty

Warranty Terms

M-Audio warrants products to be free from defects in materials and workmanship, under normal use and provided that the product is owned by the original, registered user.

Visit www.m-audio.com/warranty for terms and limitations applying to your specific product.

Warranty Registration

Immediately registering your new M-Audio product entitles you to full warranty coverage and helps M-Audio develop and manufacture the finest quality products available. Register online at www.m-audio.com/register to receive FREE product updates and for the chance to win M-Audio giveaways.

Appendix A - Technical Specifications

Type:	2-way near-field studio reference monitors
LF Driver:	8-inch Kevlar curved cone with high temperature voice coil and damped rubber surround. Magnetically shielded woofer.
HF Driver:	1-1/4 inch magnetically shielded natural silk dome
Frequency Response:	40Hz - 22kHz
Crossover Frequency:	2.2kHz
LF Amplifier Power:	70W
HF Amplifier Power:	60W
Maximum S/N: (dynamic range)	> 100dB typical A-weighted
Input Connectors:	1 x XLR balanced input connector 1 x TRS balanced/unbalanced input connector
Polarity:	positive signal at + input produce outward LF cone displacement
Input Impedance:	20k ohms balanced, 10k ohms unbalanced
Input Sensitivity:	85mV pink noise input produces 90dBA output SPL at one meter with volume control at maximum
Protection:	RF interference, output current limiting, over temperature, turn-on/off transient, subsonic filter, external mains fuse.
Indicator:	power on/off indicator on rear panel
Power Requirements:	factory programmed for either 115V ~50/60Hz, 230V~50/60Hz
Cabinet:	vinyl-laminated MDF
Dimension:	12" (H) x 10" (W) x 15" (D)
Weight:	26.4 lbs. unit 11.97 kg

* Above specifications subject to change without notice

WARNING: This product contains chemicals, including lead, known to the State of California to cause cancer, and birth defects or other reproductive harm. **Wash hands after handling.**

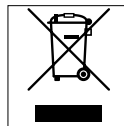

© 2007 Avid Technology, Inc. All rights reserved. Product features, specifications, system requirements and availability are subject to change without notice. Avid, M-Audio and Studiophile BX8a Deluxe are either trademarks or registered trademarks of Avid Technology, Inc. All other trademarks contained herein are the property of their respective owners.

M-Audio USA
5795 Martin Rd., Irwindale, CA 91706

Technical Support

web. www.m-audio.com/tech
tel (pro products) (626) 633-9055
tel (consumer products) (626) 633-9066
fax (shipping) (626) 633-9032

Sales

e-mail sales@m-audio.com
tel. 1(866) 657-6434
fax (626) 633-9070

Web www.m-audio.com

M-Audio U.K.
Floor 6, Gresham House, 53 Clarendon Road, Watford
WD17 1LA, United Kingdom

Technical Support

e-mail support@maudio.co.uk
tel (Mac and PC support) . . . +44 (0)1753 658630

Sales

tel. +44 (0)1923 204010
tel. +44 (0)1923 204039

Web www.maudio.co.uk

Benelux

Technical Support

Belgium tel. +32 22 54 88 93
Holland tel +31 35 625 0097

M-Audio France
Floor 6, Gresham House, 53 Clarendon Road, Watford
WD17 1LA, United Kingdom

Renseignements Commerciaux

tel. 0 810 001 105
email info@m-audio.fr

Assistance Technique

PC 0 820 000 731
Mac. 0 820 391 191
e-mail (PC) support@m-audio.fr
email (Mac) mac@m-audio.fr
fax +33 (0)1 72 72 90 52

Web www.m-audio.com

M-Audio Germany
Kuhallmand 34, D-74613 Ohringen, Germany

Technical Support

email support@m-audio.de
tel. +49 (0)7941 - 9870030
tel. +49 (0)7941 - 98 70070

Sales

e-mail info@m-audio.de
tel. +49 (0)7941 98 7000
fax +49 (0)7941 98 70070

Web www.m-audio.de

M-Audio Canada
1400 St-Jean Baptiste Ave. #150, Quebec City,
Quebec G2E 5B7, Canada

Technical Support

e-mail techcanada@m-audio.com
tel. (418) 872-0444
fax (418) 872-0034

Sales

e-mail infocanada@m-audio.com
tel. (866) 872-0444
fax (418) 872-0034

Web www.m-audio.ca

M-Audio Japan
アビッドテクノロジー株式会社|エムオーディオ事業部:
〒460-0002 愛知県名古屋市中区丸の内2-18-10
Avid Technology K.K.:2-18-10 Marunouchi,
Naka-Ku, Nagoya, Japan 460-0002

カスタマーサポート (Technical Support)

e-mail
win-support@m-audio.jp
e-mail (Macintosh 環境専用)
mac-support@m-audio.jp
tel
052-218-0859(10:00~12:00/13:00~17:00)

セールスに関するお問い合わせ (Sales)

e-mail
info@m-audio.jp
tel
052-218-3375
fax
052-218-0875

Web
www.m-audio.jp