

The E-MU logo is displayed in a large, bold, black font. The 'E' is stylized with three horizontal bars. The background of the entire page is a faded screenshot of the E-MU Proteus X LE software interface, showing various audio processing modules and controls.

# **E-MU**

# **0404**

## **Digital Audio System**

## **Tutorials**

- **E-MU Proteus X LE**
- **Steinberg Cubase LE**
- **Steinberg WaveLab Lite**
- **Cakewalk Sonar LE**
- **Ableton Live Lite 4 for E-MU**

The Creative Professional logo is located in the bottom right corner. It consists of the word 'CREATIVE' in a bold, white, sans-serif font inside a black rounded rectangle, with the word 'PROFESSIONAL' in a smaller, white, sans-serif font inside a black rounded rectangle directly below it.

**CREATIVE**  
**PROFESSIONAL**

---

# **E-MU 0404**

## **Digital Audio System**

### **Tutorials**

- **E-MU Proteus X LE**
- **Steinberg Cubase LE**
- **Steinberg WaveLab Lite**
- **Cakewalk Sonar LE**
- **Ableton Live Lite 4 for E-MU**

© 2005 E-MU Systems  
All Rights Reserved

Software Version: 1.8

#### **E-MU World Headquarters**

##### **E-MU Systems**

1500 Green Hills Road  
Scotts Valley, CA  
95067-0015  
USA

#### **Europe, Africa, Middle East**

##### **Creative Labs**

Ballycoolin Business Park  
Blanchardstown  
Dublin 15  
IRELAND

#### **E-MU Japan**

Creative Media K K  
Kanda Eight Bldg., 3F  
4-6-7 Soto-Kanda  
Chiyoda-ku, Tokyo 101-0021  
JAPAN  
[www.japan.creative.com](http://www.japan.creative.com)

---

# Table of Contents

<b>Introduction .....</b>	<b>5</b>
Before you Begin .....	5
The Product Default Session .....	5
▶ To Open PatchMix .....	5
<b>Steinberg Cubase LE .....</b>	<b>6</b>
1 - Setting up Cubase LE .....	6
2 - Basic Multitrack Recording .....	7
Recording Path Block Diagram .....	9
Recording Mono Inputs as Stereo .....	9
3 - Export Audio Mixdown to Stereo .....	10
4 - Running Proteus X LE VSTi from Cubase LE .....	12
▶ To Record a MIDI Track .....	14
▶ To Record a MIDI Track on another MIDI Channel .....	14
<b>Steinberg WaveLab Lite .....</b>	<b>15</b>
1 - Setting up WaveLab Lite .....	15
2 - Turning on the PatchMix WAVE Send .....	16
3 - Recording .....	17
<b>Cakewalk Sonar LE .....</b>	<b>19</b>
1 - Setting up Sonar LE .....	19
2 - Basic Multitrack Recording .....	21
Record Path Block Diagram .....	23
3 - Export Audio to Stereo .....	24
4 - Running Proteus X LE VSTi from Sonar LE .....	26
▶ To Record a MIDI Track .....	29
▶ To Record a MIDI Track on another MIDI Channel .....	29
<b>Ableton Live Lite 4 for E-MU .....</b>	<b>30</b>
1 - Setting up the Preferences .....	30
2 - Running Proteus X LE VSTi from Ableton Live Lite 4 .....	33
3 - Recording Audio into Ableton Live Lite 4 .....	38

---

<b>Recording &amp; Monitoring with Effects .....</b>	<b>39</b>
The Order of Effects .....	39
About PatchMix DSP .....	40
About ASIO .....	40
IMPORTANT -> Activating ASIO .....	40
▶ An Example: .....	40
ASIO Channels are STEREO! .....	40

# Tutorials

## Introduction

This guide contains step-by-step walk-throughs of basic recording operations using PatchMix DSP and a variety of popular software applications. We encourage you to perform the steps on your computer as you read so that you become familiar with the process. The first tutorial only takes about half an hour to complete, by which time you should be comfortable with multitrack recording using your new Digital Audio System.

Once you're up and recording, you can find detailed information on all aspects of PatchMix DSP and your E-MU interface hardware in the pdf Owner's Manual.

## Before you Begin

- You should have already installed the E-MU hardware and software on your computer according to the instructions in your printed "Getting Started" manual.
- You should hear the computer sounds coming out of the E-MU hardware and your speakers when you play a CD or an MP3 using Windows Media Player. If not, make sure your E-MU hardware is properly connected according to the diagrams in the "Getting Started" and "Owner's Manual".
- A source of audio should be connected to the inputs (instr./tape/cd/MP3 player).

■ **Important Note:**  
If you need additional help with the bundled applications, please see the "Technical Support Information" pdf located in the "Creative Professional, Documents" folder.

## The Product Default Session

Before we begin, you should verify that the **Product Default** session is selected. This session has everything connected for you. A *Session* is a stored connection/mixer setup. You can create your own custom Sessions later on if you wish.

### ► To Open PatchMix

1. Left-click once on the E-MU  icon on the Windows System Tray.
2. The PatchMix DSP mixer window appears.
3. The **Product Default** session contains two Aux 1 Sends as shown at right. If you're not sure the Product Default session is loaded, see the "Comment" box in the "Session Settings".
4. If the Product Default session is NOT selected, click once on the **Open Session** button and select "Product Default" from the list.
5. Close PatchMix by clicking the "X" in the upper right corner.
6. OK, now we're ready to proceed!

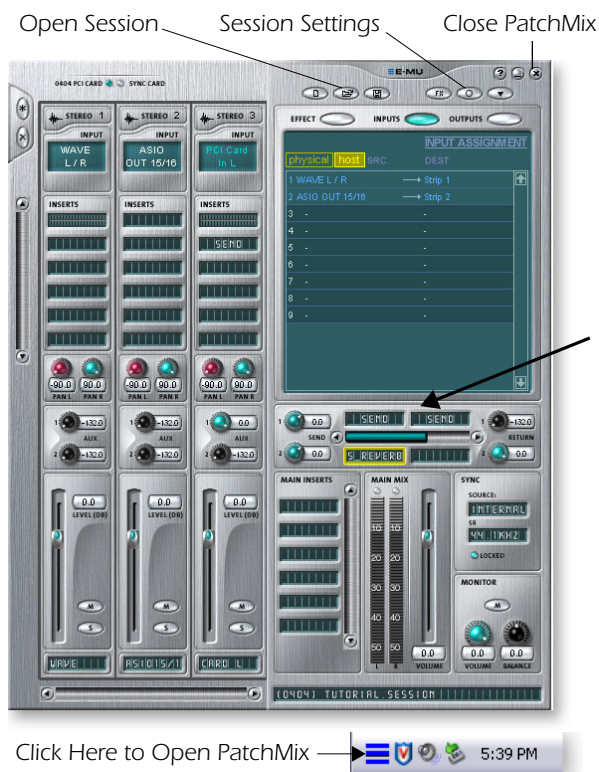

❖ Verify that both Aux 1 Insert slots are filled with Send Inserts as shown.

## Steinberg Cubase LE

Steinberg Cubase LE is a 24-bit/96kHz multi-track audio/MIDI recorder with high-quality effects, automation, virtual instruments (VSTi) and many other professional features.

The following step-by-step tutorials are designed to get you recording as quickly as possible. After you have finished the tutorial we encourage you to read the Cubase LE pdf manual in order to learn about the many features of this powerful program. We have provided a PatchMix DSP Session, as well as a special **Cubase LE Project** to go along with the following tutorials.

### 1 - Setting up Cubase LE

Follow these instructions carefully to ensure that Cubase LE runs smoothly the first time. Cubase LE will remember these settings, so you'll only have to do this once.

1. **Open Cubase LE** from the Start menu or by double-clicking the desktop icon. An ASIO multimedia driver test dialog box will pop up to ask if you want to run the ASIO test. **Choose No**, because you won't be using the driver anyway.
2. Select **Device Setup...** from the **Devices** menu.
3. Select **VST Multitrack** from the list and the following screen appears.

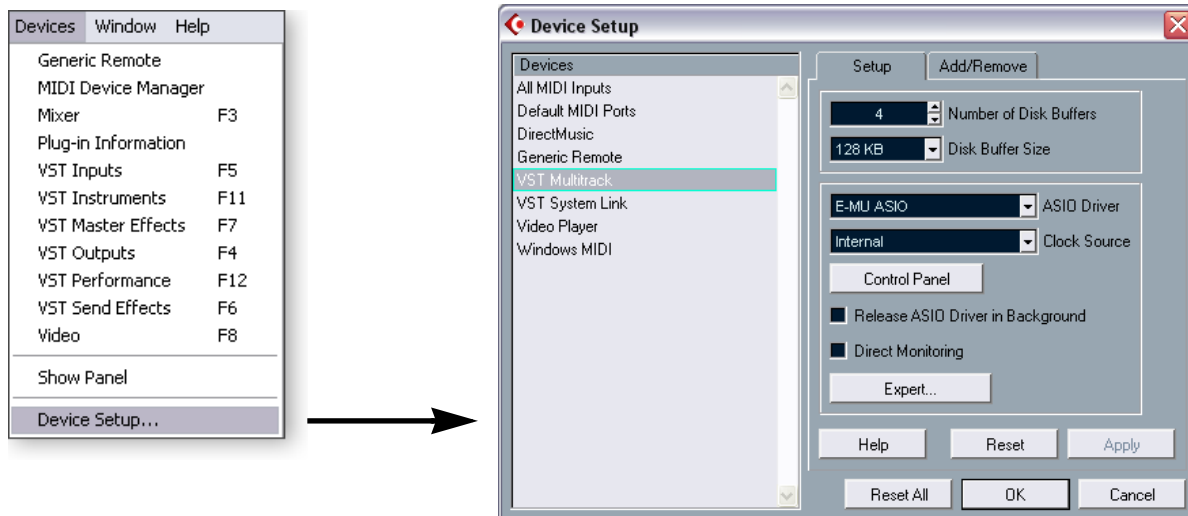

4. In the Setup section of the dialog box, select **E-MU ASIO** as the ASIO Driver. A pop up dialog box asks, "Do you want to switch the ASIO driver?" Select **Switch**.
5. Click the **Control Panel** button. The pop-up dialog box shown at right appears.
6. Set the **ASIO Buffer Latency** to 10 ms or less. A low latency setting is important to assure fast MIDI response time and to minimize delay when monitoring through Cubase. **Click OK**.
7. Make sure the **Direct Monitoring** box is **Unchecked**.
8. Close the **Device Setup** screen by selecting **OK**.
9. **Close Cubase LE** by clicking the  button. (Close the application even if you're going to continue with the tutorials, in order to "lock-in" your Preference settings.)



## 2 - Basic Multitrack Recording

In this tutorial, we'll assume you're using a single input or pair of inputs. For more advanced recording, refer to the Cubase LE manual.

Select the Cubase LE Recording Template

1. Choose **(0404) Cubase LE** from the **Start -> Programs** menu. The path is: (Program Files\Creative Professional\E-MU PatchMix DSP\VST\ Recording Templates). Cubase LE will launch and load the Project.
2. A pop-up dialog box will appear, asking you to **Select Directory**. Choose a location on your hard disk where you wish to store your audio files, then click **OK**.
3. The Cubase LE Project window shown below appears. Five empty tracks are ready to record. Each track is already connected to an input in PatchMix.
4. **Select the Track** that matches the inputs you've connected to the Digital Audio System by clicking on it. Note that the selected track brightens as you select it. In the example below, we are using **I/O Card L**.
5. **Turn the Monitor button OFF**  for the track. You will be monitoring the input through PatchMix DSP which has zero-latency.
6. If you want to record in mono, set the track to mono by clicking the Mono/Stereo Selector button. Use the **Left** input of the stereo pair for mono recording.

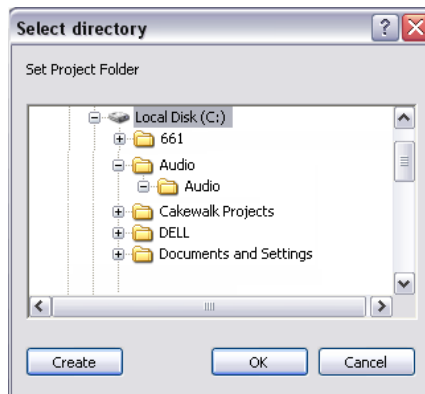

❖ **Tip:** If you have two or more hard disks, it's better to store audio files on a disk that isn't running your OS.

### The Cubase LE Project Window

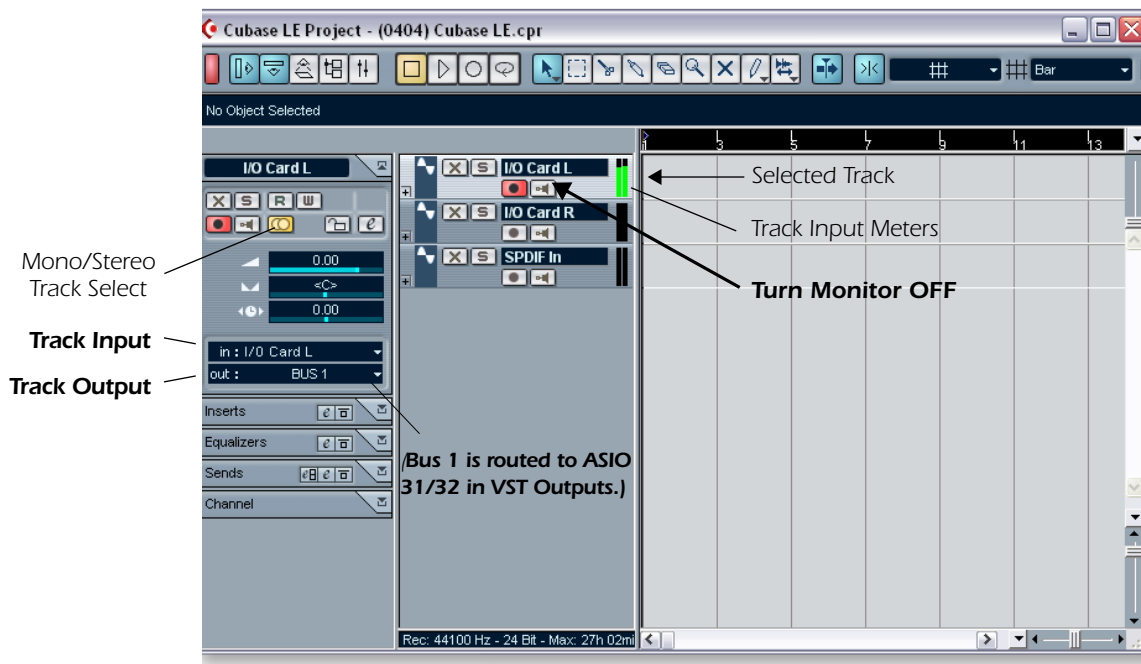

7. You should see activity on the Track Input Meter when feeding a signal into the Digital Audio System. If not, open PatchMix to verify meter activity on the input

channel (strip). Make sure the PatchMix input channel (strip) matches the Cubase LE Track Input.

8. If your input signal is either too weak or too strong, adjust your input source or the Digital Audio System gain controls.

#### Record a Track

9. Press **Record** on the Cubase LE Transport control and start playing.

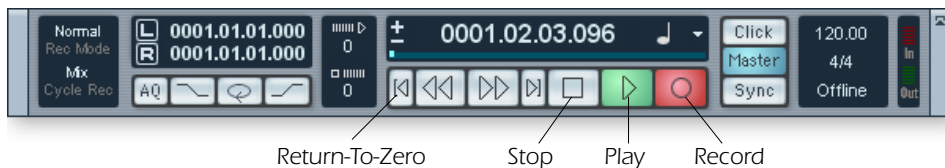

10. Press **Stop** when you're finished recording the first track.
11. Press the **Return-to-Zero** button  on the Cubase Transport.
12. Press **Play** on the Cubase Transport to play back your track. The audio from Cubase comes back into PatchMix on the **ASIO Out 31/32 Strip**.

#### Record Another Track

13. Press the **Return to Zero** button  on the Cubase Transport.
14. Add another track by selecting **Add Track**, from the Project menu. Select **Audio**.
15. A new audio track is added. Notice that the red **Record Enable** button has been automatically turned on in the new track. (If you wish to record multiple tracks simultaneously, simply turn Record Enable on for each track you wish to record.)
16. Again, set up the track to be either **mono** or **stereo**, then choose the **Track Input** routing. The input can be the same one you used for the first track or you can choose a different input.

#### Save your Project

17. Choose **Save As...** from the Cubase LE file menu to save your project. Choose a name and location that will make the project easy to find later.

To record into Cubase LE, you must have a PatchMix session containing these 4 basic components:

- a) a **physical input strip** for your input source.
- b) an **ASIO Send** on the physical input strip (so that Cubase can receive your input).
- c) an **ASIO output strip** for Cubase to output its audio back through PatchMix.
- d) an **output assigned** to any physical output (to your monitor speakers).

◆ A quick way to record additional tracks using the same input is to simply drag the Part (audio region) you just recorded down to another location in the Cubase Arrange window, then hit Record again and go.



These diagrams may be helpful to visualize the signal routing path.

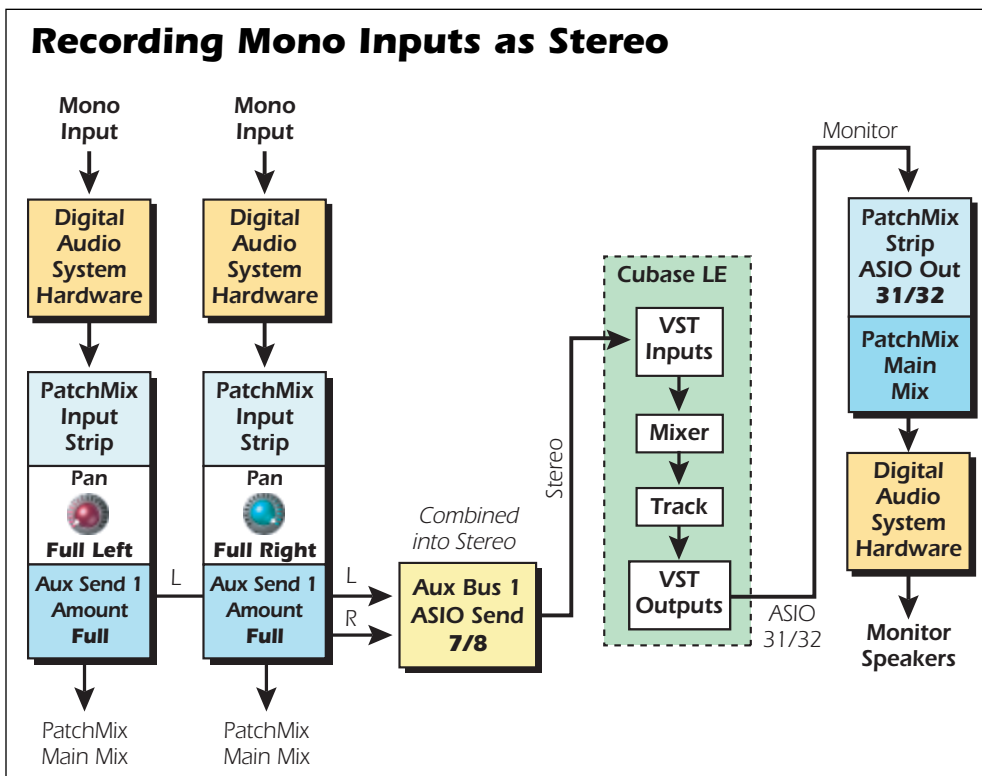
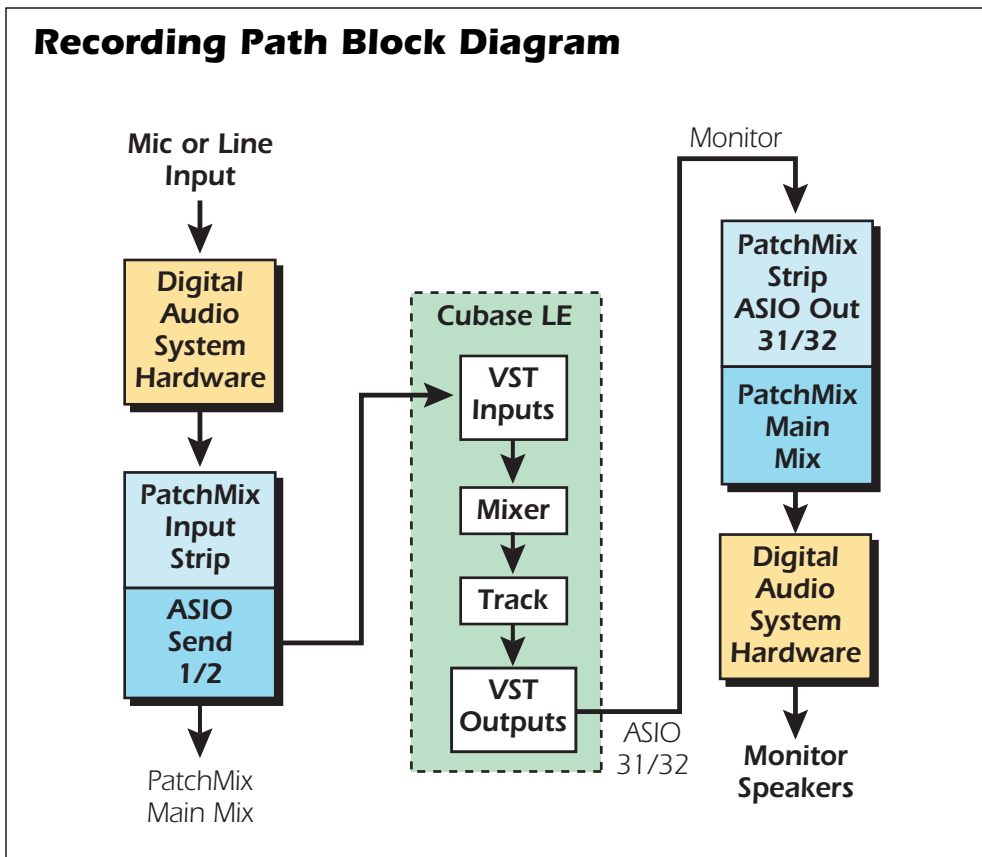

### 3 - Export Audio Mixdown to Stereo

At some point, you'll want to mix down your multitrack project to stereo. Cubase LE has a special function (Audio Mixdown) that makes this job a breeze. The Cubase LE Project window below shows a short song with 4 stereo tracks recorded.

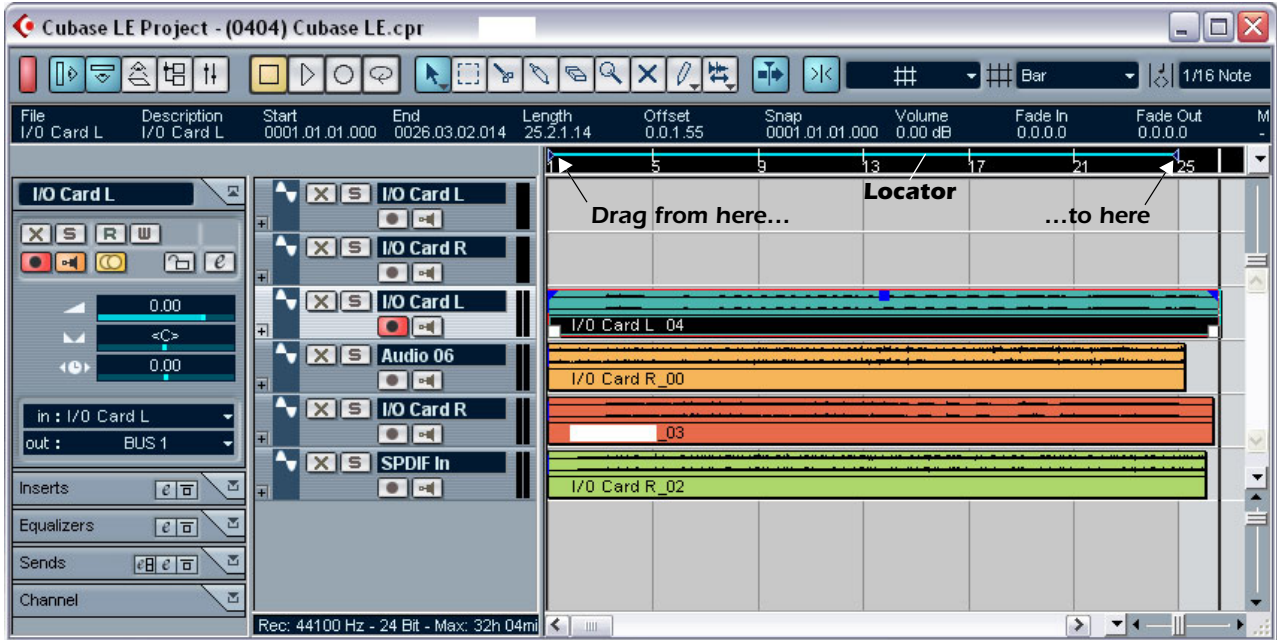

1. Drag the Right Locator (little blue triangle) to the right. Keep dragging until the blue Locator Bar encompasses the entire song or section you want to mix down. See above.

Mix your Song

2. From the Cubase LE Project window, select **Mixer** from the **Devices** menu (or press F3). The Cubase LE Track Mixer appears.



3. Play your song and use the Faders to set the levels of each part. (Note: These moves can be automated in Cubase LE. See the online documentation for details.)

## Export Audio

- From the Cubase LE Project window, select **Export** from the **File** menu and choose **Audio Mixdown**.

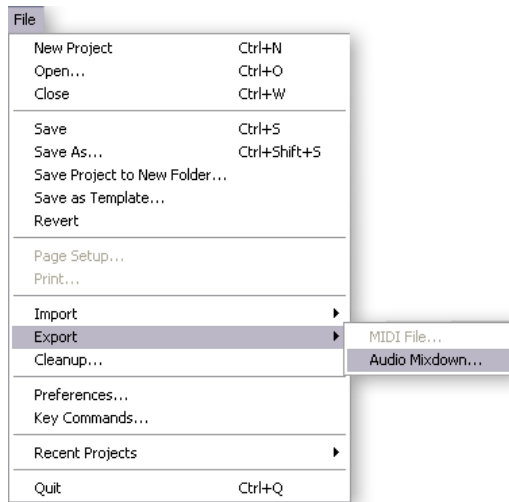

- The following screen appears. First choose a location for your file.

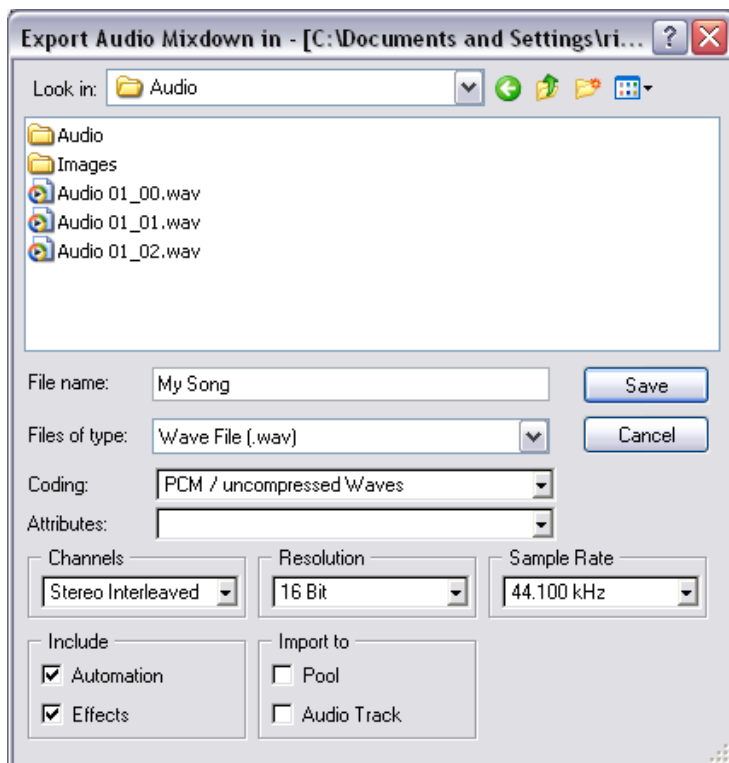

- Next choose the file type. Cubase LE can export as: **WAVE** (.wav), **AIFF** (.aif), **MPEG Layer 3** (.mp3), **RealAudio G2** (.rm), or **Windows Media Audio** (.wma). WAVE is a good choice for a master file since it is an uncompressed format. "Stereo Interleaved" creates a single stereo file.
- Select the desired **Sample Rate** and bit **Resolution**.
- Press **Save** to process your Audio Mixdown.

## 4 - Running Proteus X LE VSTi from Cubase LE

These instructions explain how to start Proteus X LE from within Cubase LE. If you have a MIDI keyboard, you should connect it now using the setup diagrams and instructions that came with your E-MU Digital Audio System. Without a keyboard, you will only be able to play one note at a time using the mini keyboard on Proteus X LE.

■ These instructions also apply to Proteus X or Emulator X.

1. From the Cubase LE Project window, select **Add Track** from the **Project** menu and choose **MIDI Track**.

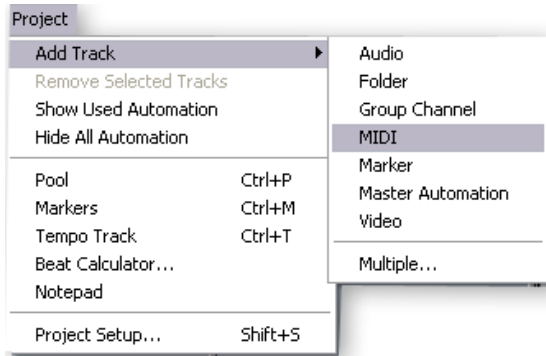

2. The Cubase Project Window should now look like this with one MIDI track.

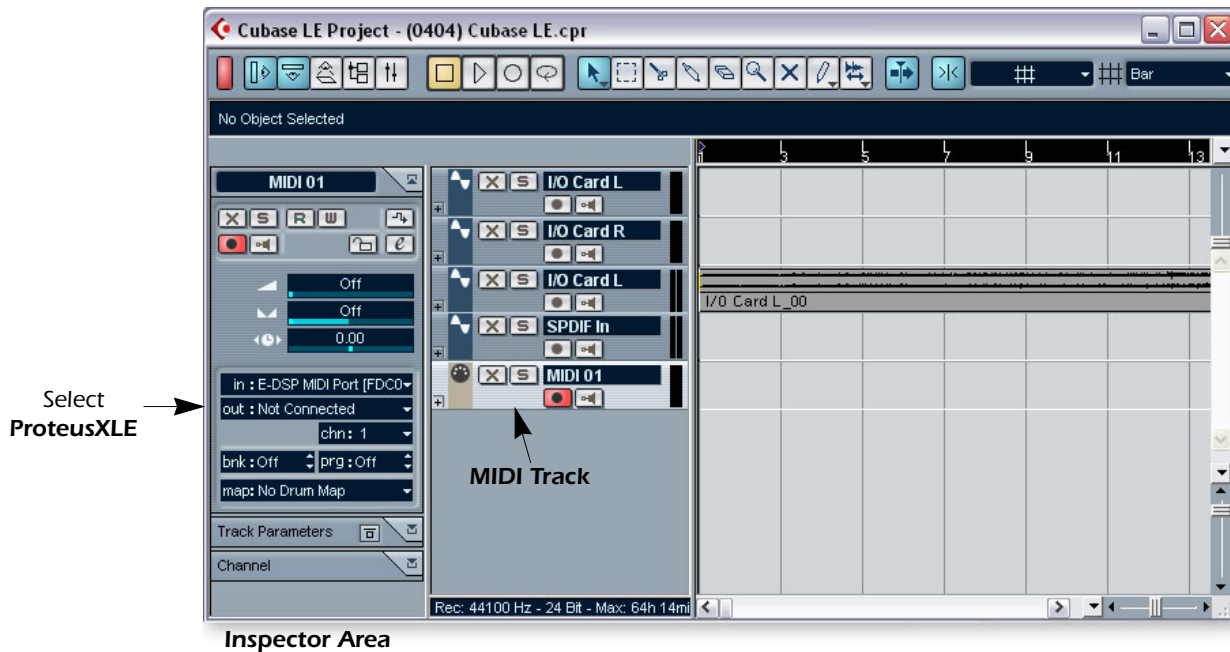

3. Click on the **Devices** menu pull-down and select **VST Instruments** (or press F11).

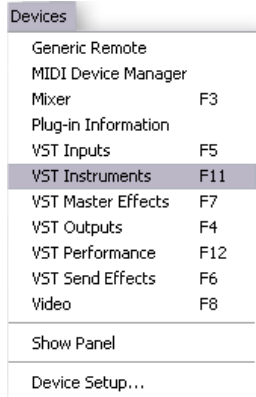

4. The VST Instruments window appears. Select **ProteusXLE**.

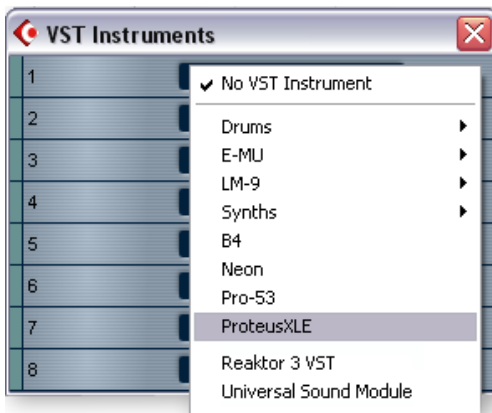

5. The VST Instruments window now looks like this.

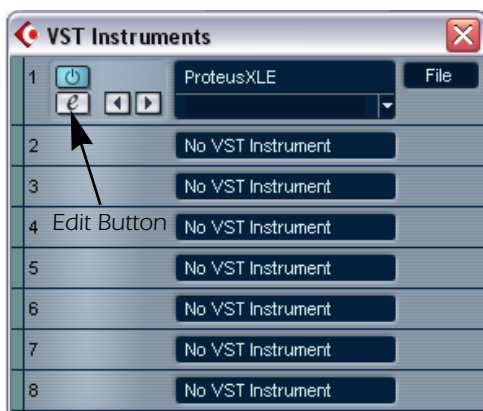

❖ **Tip:** Unlike some VSTi's, Proteus X LE is multitimbral, and able to play up to 16 MIDI channels at once.

It's far more CPU-efficient to have multiple MIDI channels playing on one instance of Proteus X LE, rather than to have multiple VSTi's running.

6. Take a look at the **Inspector** area on the left side of the Cubase LE project window (diagram on following page). The input to the MIDI track is connected to E-DSP MIDI Port, but the Output is not yet connected to anything. Click on the Output and select **ProteusXLE**. Now you're ready to play.

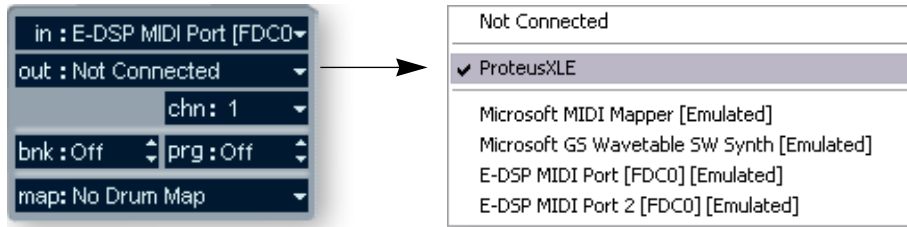

7. Click the **Edit** button  of the **VST Instruments** window to open Proteus X LE. You can also click on the **Edit** button of the track **Inspector** to open Proteus X LE.

Load the Proteus X Composer Bank

8. Proteus X LE is now running, but you need to load a bank of sounds.
9. Choose **Open** from the **File** menu on Proteus X LE. Locate and load the **Proteus X Composer bank**, which is located here: ("Program Files/Creative Professional/E-MU Sound Central") The bank takes a few seconds to load.

Play the Proteus X Composer Bank



10. **Click on the mini keyboard** at the bottom of the window. You should be hearing sound. If not, close Cubase LE, and verify that you have the **PatchMix DSP Product Default** session loaded. Then close and restart Cubase LE.
11. **Play your MIDI keyboard** (if connected) and verify that it plays Proteus X LE.
12. **Change the Preset** using the preset inc/dec keys. 
13. Feel free to play around for awhile and don't worry about losing anything. Nothing is made permanent until you **Save** the bank, so have fun.

### ► **To Record a MIDI Track**

14. Just hit **Record** on the Cubase LE Transport control and start playing.
15. Press **Stop** when you're finished recording the first track and press the **Return-to-Zero** button .
16. Press **Play** on the Cubase Transport to play back your track.

### ► **To Record a MIDI Track on another MIDI Channel**

Proteus X LE VSTi can play back up to 16 MIDI tracks at once. It's much better to use several channels on one VSTi than to use multiple VSTi's with one channel each.

17. Select **Add Track** from the **Project** menu and choose **MIDI Track**. Notice that the channel number in the **Inspector** section is now set to **chn:2**.
18. Select **Proteus XLE** as the **Output** destination in the **Inspector** section.
19. Click on the **Edit** button  of the track **Inspector** to open Proteus X.
20. **Select MIDI Channel 2** using the channel inc/dec keys .
21. **Select a Preset on Channel 2**. Place the cursor in the preset number field and use the up/down arrow keys on your computer keyboard to scroll through the list.
22. When you're ready, hit **Record** on the Cubase LE Transport and start playing.
23. Press **Stop** when you're finished recording, then **RTZ** (return-to-zero), then **Play**. Proteus X LE now plays both MIDI channels.

◆ There are several ways to select presets. See the Proteus X LE Operation manual for details.

### **On Your Own**

Cubase LE includes excellent online documentation and help files. Take the time to learn all the features of this powerful program, and most of all have fun.

## Steinberg WaveLab Lite

Steinberg Wavelab Lite is an easy-to-use, stereo digital audio recorder and editor. You can use it to record and edit audio from the Digital Audio System or import tracks from CDs. Audio recorded in WaveLab can be saved in WAVE or AIFF formats.

In this tutorial you'll learn how to use WDM drivers (E-DSP WAVE) to transfer digital audio between the Digital Audio System and Wavelab Lite. WDM works well for stereo recordings, but ASIO is best for low-latency, multi-track recording.

After you have finished the tutorial we encourage you to read the WaveLab Lite pdf manual in order to learn about all the features of this powerful program.

### 1 - Setting up WaveLab Lite

Follow these instructions carefully to ensure that Wavelab Lite runs smoothly the first time. WaveLab Lite will remember these settings, so you'll only have to do this once.

1. Open Wavelab Lite from the Start menu or by double-clicking the desktop icon.
2. Select **Preferences...** from the **Options** menu. The Preferences window appears.
3. Select the **Audio Card** tab to display the following screen.

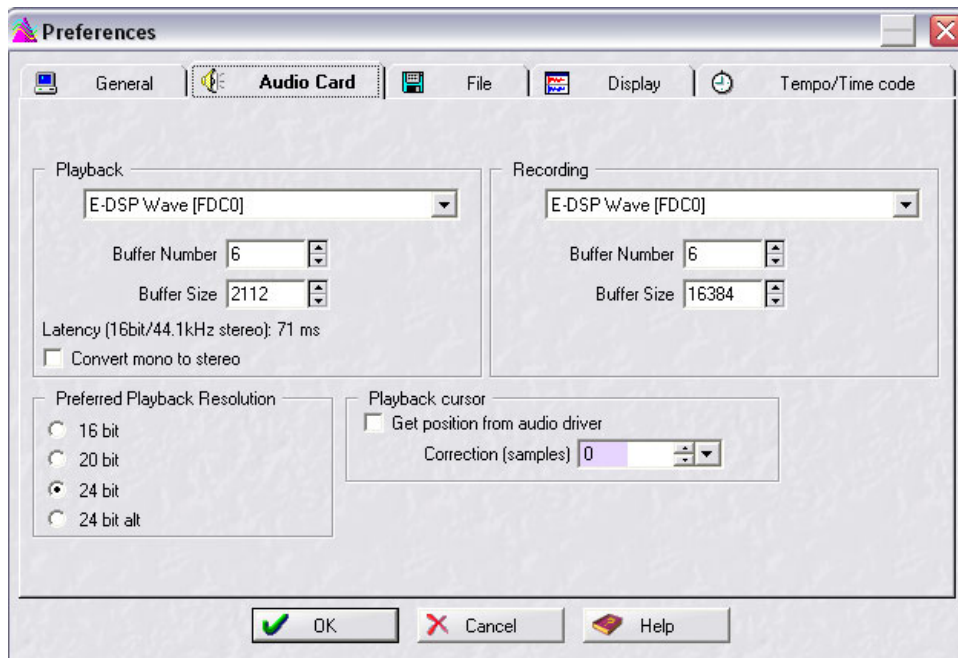

4. In the **Playback** and **Recording** selection boxes, select **E-DSP Wave**.
5. Save your settings and close the **Preferences** window by selecting **OK**.

## 2 - Turning on the PatchMix WAVE Send

WaveLab Lite interfaces with PatchMix DSP using WAVE audio instead of ASIO. A WAVE Send is included in the PatchMix Product Default session. You just have to turn it on. This is the setup you'll use with any application that uses WAVE instead of ASIO.

Open PatchMix

1. Left-click once on the E-MU  icon on the Windows System Tray. The PatchMix DSP mixer window appears.
2. Make sure that the **Product Default** session is loaded. This session is easily recognized by the presence of **TWO Sends** in the Aux 1 section (yellow box below).
  - If the Product Default session is **NOT** selected, click once on the **Open Session** button and select "Product Default" from the list.

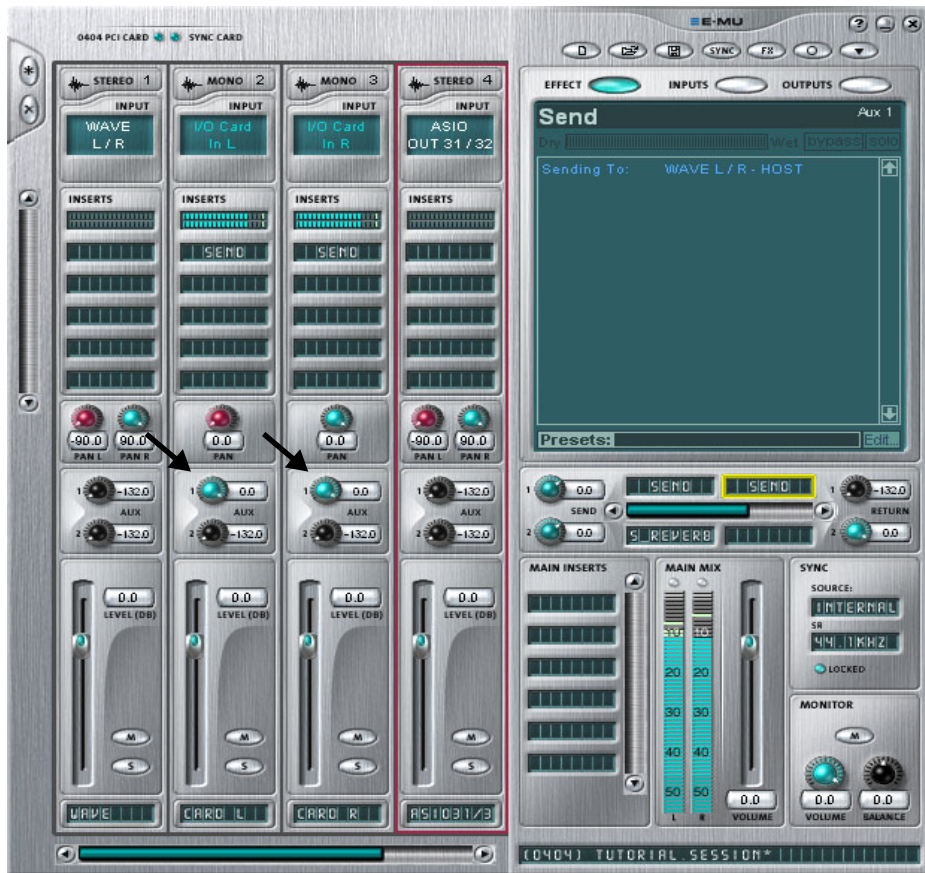

◆ The TV screen shows the details of whichever insert you click on. In the example at left, the Insert Send highlighted in yellow is shown in the TV screen.

Supply Audio to PatchMix

3. Connect your audio source to either or both inputs on the Digital Audio System. Verify that you have meter activity on the channel.

Turn up the Aux Send 1 Amounts

4. **Turn up the Aux Send 1 Amount on the input channel(s) you are using.** In the screen above, signal is coming in on both I/O Card L and I/O Card R, and the Aux 1 amounts are turned up all the way to 0.0dB, as shown by the arrows.
5. **Notice the Send highlighted above in yellow.** The TV screen shows this to be a WAVE Send. By turning up the Aux 1 Amount, you routed the signal to the Aux 1 bus and then out the WAVE Send.

▼ This example shows how to use a stereo input — the pan controls are panned hard left and right. If you're using a mono input, set the span control to center.



### Using the Mono Inputs as a Stereo Pair

- Notice that the mono input channels are panned hard left and hard right. This has been done so that the two mono inputs can be used as a stereo pair. **The two mono channels will be combined into one stereo signal in the Aux Bus.**
- If you wish to use the two mono inputs as a stereo pair, simply turn up the Aux 1 Sends for **both mono channels**. (To record in mono, just turn up one channel.)

## 3 - Recording

- Click the red **Record** button on the WaveLab Lite transport controls. The Record Window shown below appears.
- You should see meter activity on these meters when your input signal is being fed into the Digital Audio System.

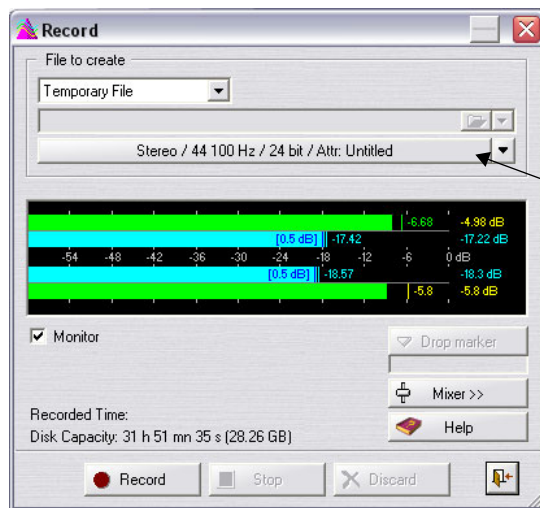

Click here for:  
**Audio File Format  
Properties**

- Click on the bar to open the **Audio File Format** properties. The dialog box shown below appears.

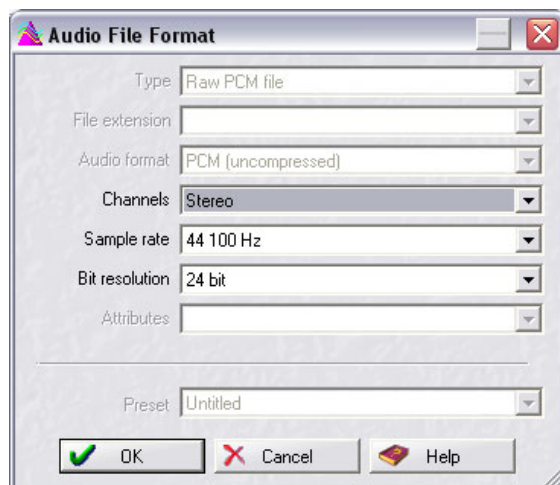

- Set the recording properties as desired, then click **OK**.

### Important Note when using WDM

When using WAVE applications, **avoid mismatched sample rates**. The sample rate of your application **MUST** match the sample rate of the Digital Audio System. If the Windows WDM drivers detect different sample rates, they will automatically perform a sample rate conversion to correct the mismatch. You might not hear the difference, but you might as well go for the best possible audio quality.

#### Record

5. Click the **red Record button** on the record dialog box. Recording begins.
6. Click the **Stop button** to stop recording. A new untitled window appears with your recording.

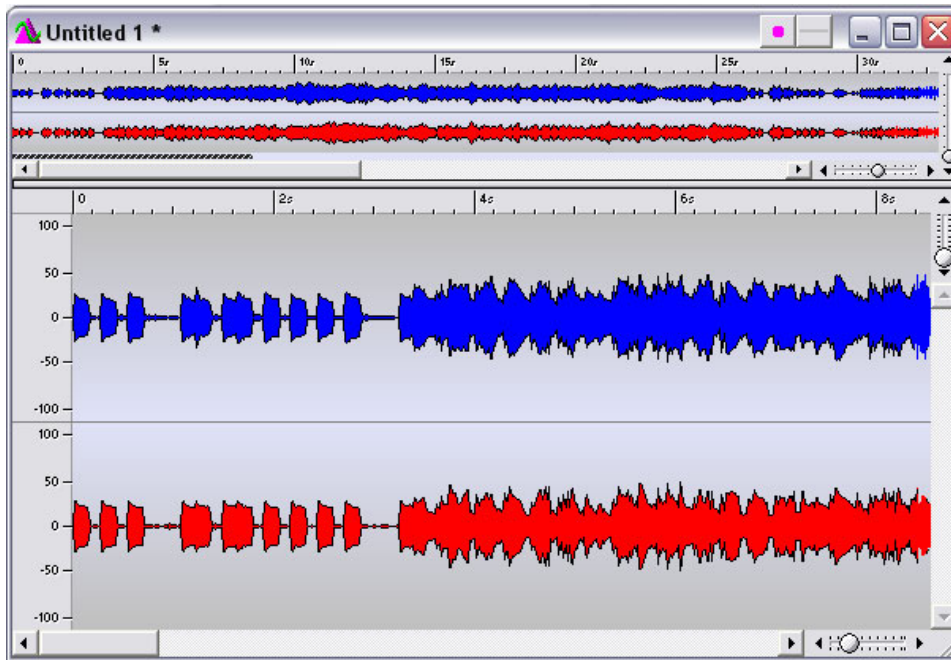

#### Normalize?

7. Many people will Normalize the recording at this time. Normalization increases the gain until the loudest peak reaches a preset level (usually 0dB). Normalization is located in the **Process** menu. (*You have to select the audio region first.*)

#### Save your Audio File

8. Choose **Save As...** from the File menu. Normally you will choose **WAVE**. The Save dialog box allows you to save in either WAVE (.wav) or AIFF (.aif, .aiff, .snd) formats.
9. Name your new file and click **Save**.

## Cakewalk Sonar LE

Sonar LE is a professional tool for authoring sound and music on your computer. Sonar supports Wave, AIFF, ASIO, MP3, ACIDized waves, WMA and other audio formats.

The following step by step tutorials are designed to get you recording on Sonar LE. After you have finished the tutorial we encourage you to read the Sonar LE pdf manual in order to learn about the many features of this comprehensive program.

We have provided a special PatchMix DSP Session, as well as a Sonar LE Recording Project to go along with the following tutorial.

### 1 - Setting up Sonar LE

Follow these instructions carefully to ensure that Sonar LE runs smoothly the first time. Sonar LE will remember these settings, so you'll only have to do this once.

Setup the Audio Options

1. Choose the **(0404) Sonar LE** session from the **Start -> Programs** menu. The path is: (Program Files\Creative Professional\E-MU PatchMix DSP\VST\Recording Templates). Sonar LE will launch and load the Project.
2. Select **Audio...** from the **Options** menu. The following dialog box appears.

■ **Note:** A PatchMix Session containing ASIO Sends and Returns must be loaded BEFORE you launch Sonar LE.

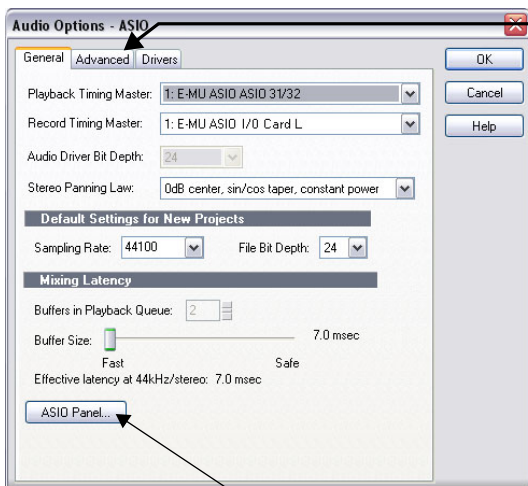

3. Set the **ASIO Buffer Latency**.

1. Click on the **Advanced** Tab to access the next window.

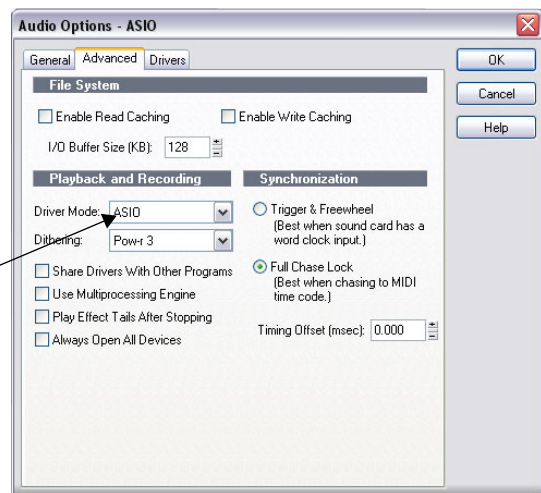

2. Set the **Driver Mode** to **ASIO**.

3. Set the **Audio Settings** as shown in the dialog boxes above. Select **E-MU ASIO**.
4. In the **General** section of the dialog box, select **ASIO Panel**. The pop-up dialog box shown at right appears.
5. Set the **ASIO Buffer Latency** to 10 ms or less. A low latency setting is important to assure fast MIDI response time and to minimize delay when monitoring through Sonar. **Click OK**.
6. Close the **Audio Options** screen by selecting **OK**.

**Note:** If the Sonar LE application crashes for any reason, it is recommended that you reboot the computer



## Setup the MIDI Options

7. Select **MIDI Devices...** from the **Options** menu. The following screen appears.

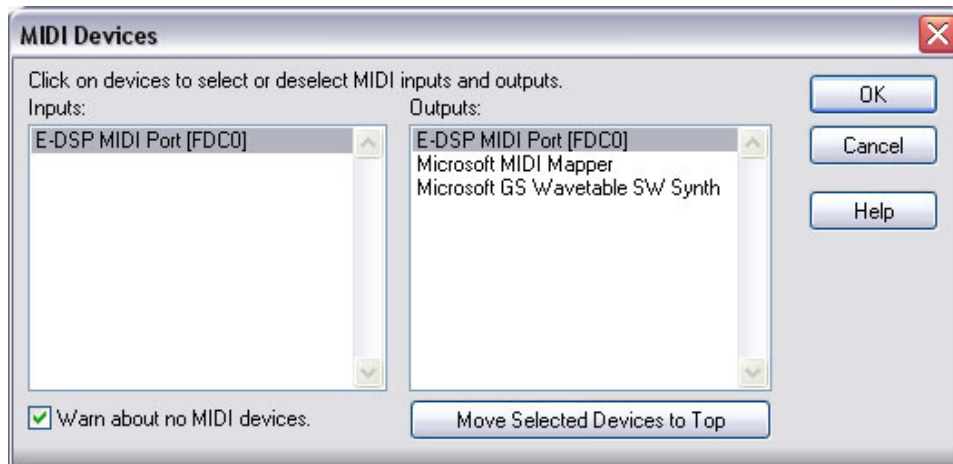



8. Select the **E-DSP MIDI Ports** for inputs and outputs, then click **OK** to close the window.
9. OK, that's all. Close **Sonar LE** by clicking the  button. (Do this even if you're going to continue with the tutorials.)

- To Set the Location of your Audio Files:
  1. Select **Global...** from the Options menu, then
  2. Select **Audio Data**.

## 2 - Basic Multitrack Recording

In this tutorial, we'll assume you're using a single input or pair of inputs. For more advanced recording, refer to the Sonar LE manual.

Select the Sonar LE Recording Template

1. Choose **(0404) Sonar LE** from the **Start -> Programs** menu. The path is: (Program Files\Creative Professional\E-MU PatchMix DSP\VST\Recording Templates). Sonar LE will launch and load the Project.
2. The Sonar LE Project window shown below appears. Five empty tracks are ready to record. Each track is already connected to an input or pair of inputs in PatchMix.
3. Click the **Zoom In Vertical** button  repeatedly to enlarge the tracks as in the Project Window below.
4. **Select the Track** which matches the input you want to use on the Digital Audio System by clicking on it. Note that the selected track heading brightens as you select it. In the example below, we are using **Track 1**, fed from **I/O Card L**.
5. Change the input setting if you want to use the line inputs to record in mono. Click on the little triangle  on the right side of the track **Input** box to see the list of all the PatchMix DSP inputs.

### The Sonar Project Window

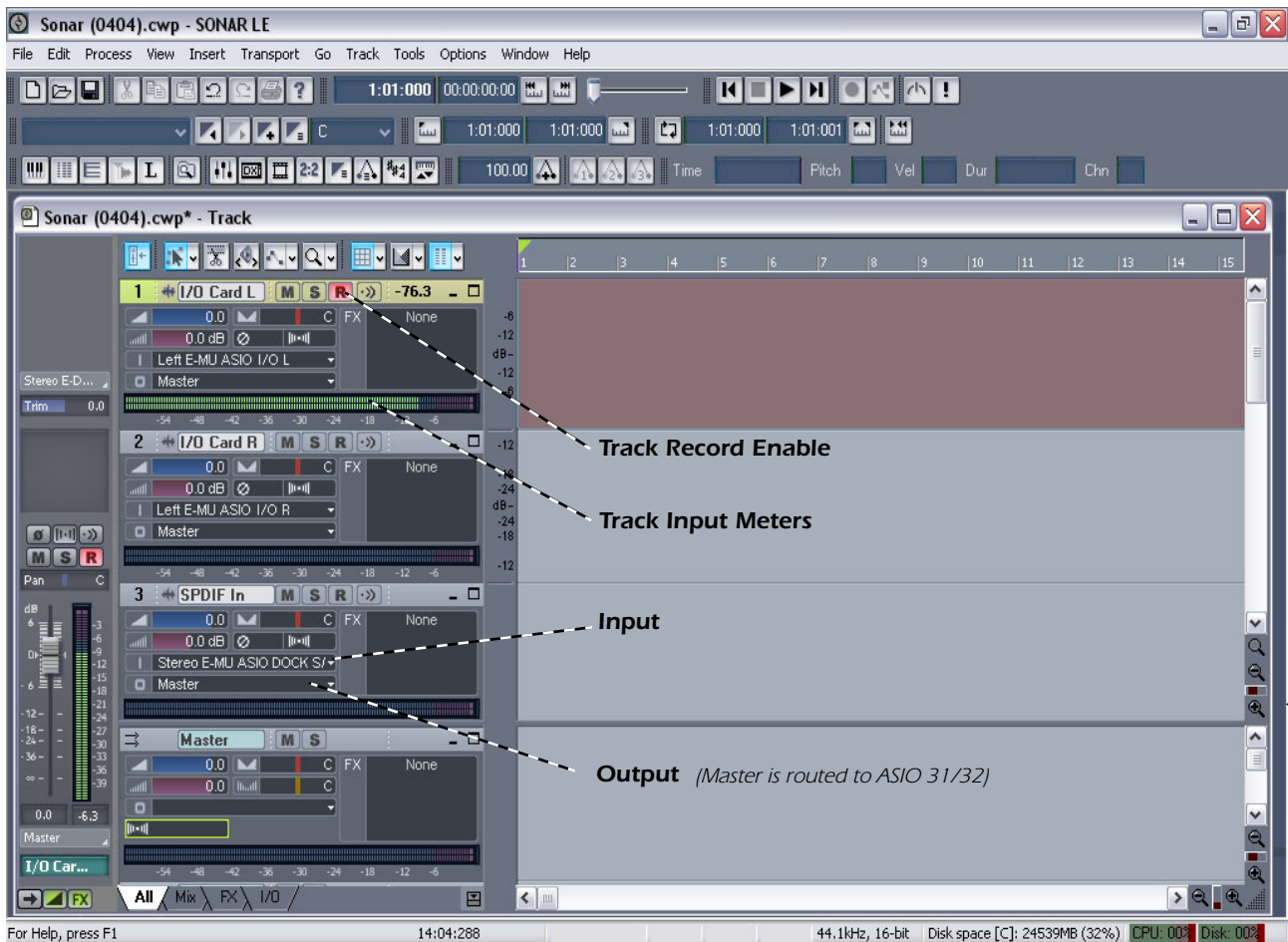



Click the **Vertical Zoom** to Enlarge the Tracks

6. Press the **Track Record Enable button**  for the Track that you want to use. The track turns a dull red color to indicate that it is record-enabled. You should now see activity on the Track Input Meter when feeding a signal into the Digital Audio System.
  - If you don't see meter activity on the track, try record enabling all the other tracks to see if any of the meters move (you may have record enabled the wrong track). If you still don't see meter activity, open PatchMix DSP to verify meter activity on the input channel. Next, make sure the input channel on PatchMix matches your Track Input in Sonar LE.
7. If your input signal is either too weak or too strong, adjust the level of your input source.

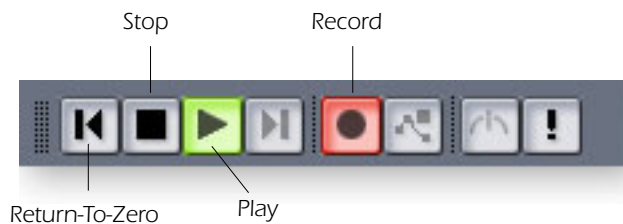

### Record a Track

8. Press **Record** on the Sonar LE Transport control and start playing.



9. Press **Stop** when you're finished recording the first track.
10. Press the **Return-to-Zero** button  on the Sonar Transport.
11. Press **Play** on the Sonar LE Transport to play back your track. The audio from Sonar comes back into PatchMix on the **ASIO Out 31/32 Strip**. (*Go look and see.*)
12. If you want to dump the track and start over, **Right-click over the waveform display** in the track and choose **Delete**.

### Record Another Track

13. Press the **Return to Zero** button  on the Sonar LE Transport.
14. Add another track by selecting **Audio Track**, from the **Insert** menu. A new audio track is added to the bottom of the list.
15. The new track is very narrow because it is "minimized". Click on the **Restore Strip Size** icon  to make the track parameters visible.
16. Now you have to connect an input to the Track. Click on the little triangle  on the right side of the track **Input** box. (If you wish to record multiple tracks simultaneously, simply turn Record Enable on for each track you wish to record.)
17. Again, set up the track to be either **mono or stereo**, then choose the **Track Input** routing. The input can be the same one you used for the first track or you can choose a different input.

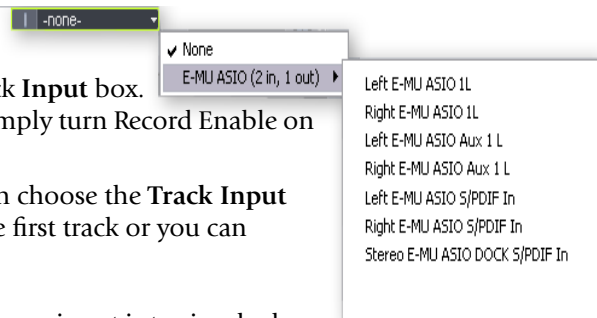

**Hot Tip:** A quick way to record additional tracks using the same input is to simply drag the Part (audio region) you just recorded up or down to another track in the Sonar Project Window, then just hit Record again and go. (Choose "Slide Over Old to Make Room" when asked in the Drag & Drop Options.)

Save your Project

18. Choose **Save As...** from the Sonar LE file menu to save your project. Choose a name and location that will make the project easy to find later.

The following diagram may be helpful to visualize the signal routing path.

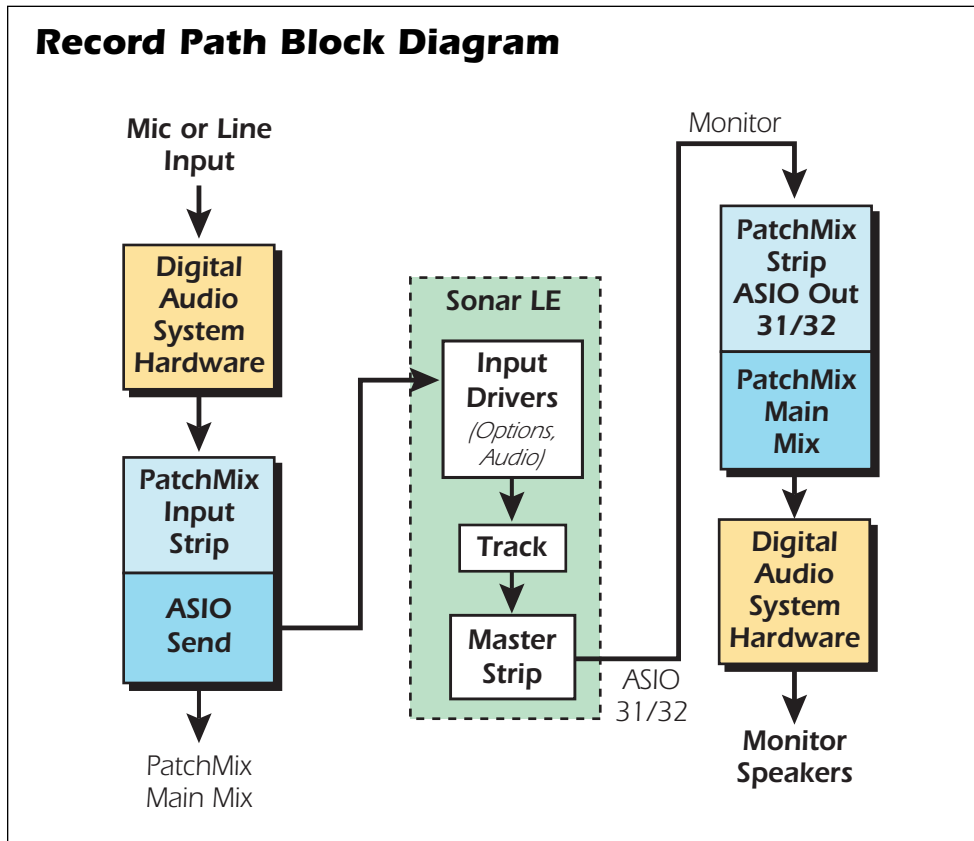

To record into Sonar LE, you must have a PatchMix session containing these 4 basic components:

- a) a **physical input strip** for your input source
- b) a **send** from this strip to an ASIO input so that Sonar LE can receive your input
- c) an **ASIO output strip** for Sonar LE to output its audio back through PatchMix
- d) an **output assigned** to any physical output (to your monitors)

### 3 - Export Audio to Stereo

At some point, you'll want to mix down your multitrack project to stereo. Sonar LE has a special function (Export Audio) that makes this a simple job. The Sonar LE Project window below shows a short song with 3 stereo tracks recorded.

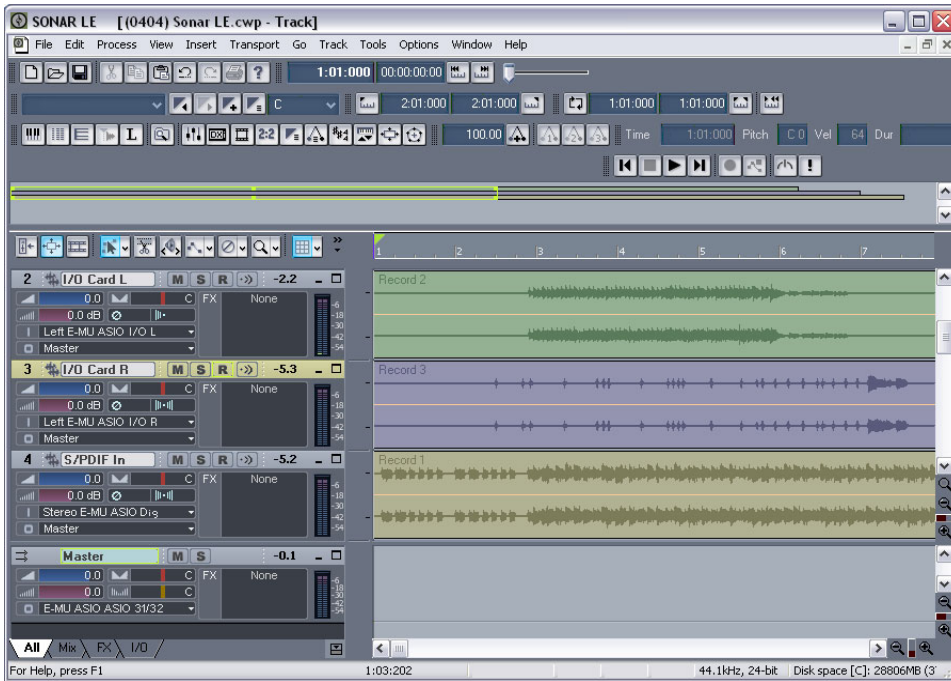

#### Mix your Song

1. From the Sonar LE Project window, select **Console** from the **View** menu (or press Alt+3). The Sonar LE Track Mixer appears.





2. Play your song and use the Faders to set the levels of each part. (Note: These moves can be automated in Sonar LE. See the Sonar LE pdf manual for details.)

### Export Audio

3. From the Sonar LE Project window, select **Export** from the **File** menu and choose **Audio**.

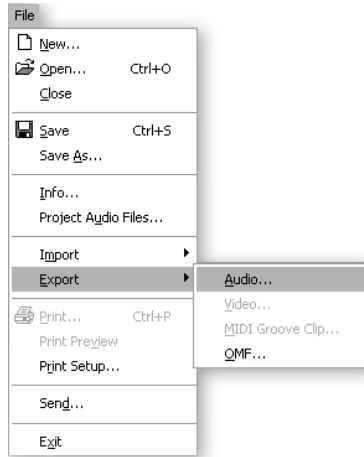

- ◆ To go back to the Track display, select "Track" in the Window menu.

4. The following screen appears. First choose a location for your file.

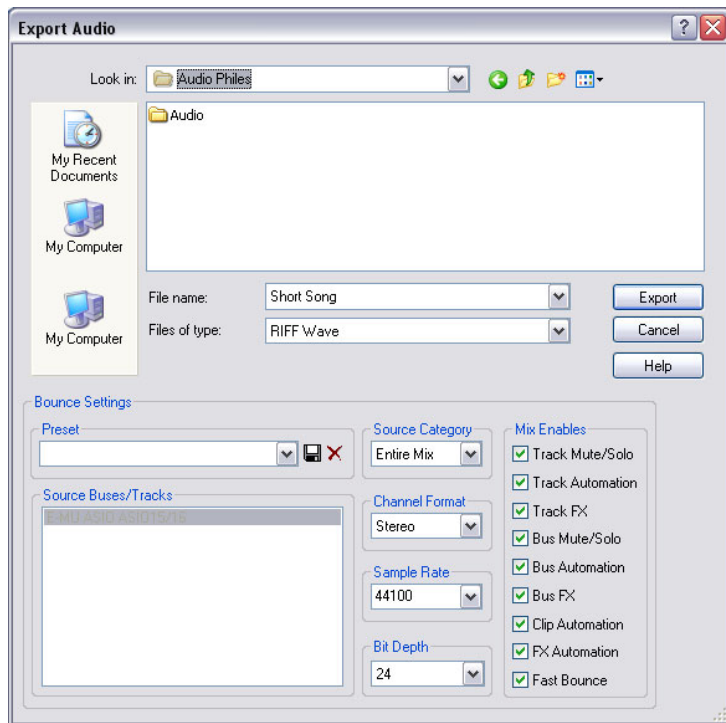

5. Next choose the file type. **RIFF Wave** or **Broadcast Wave** are good choices for a master file since they can be read by most other audio applications.
6. Select the desired **Sample Rate**, **Channel Format** and **Bit Depth**.
7. Press **Export** to process your Audio Mixdown.

## 4 - Running Proteus X LE VSTi from Sonar LE

These instructions explain how to start Proteus X LE from within Sonar LE. If you have a MIDI keyboard, you should connect it now using the setup diagrams and instructions that came with your E-MU Digital Audio System. Without a keyboard, you will only be able to play one note at a time using the mini keyboard on Proteus X LE.

Select the Virtual Instrument

1. From the Sonar LE Project window, select **Synth Rack** from the **View** menu. The following window appears.

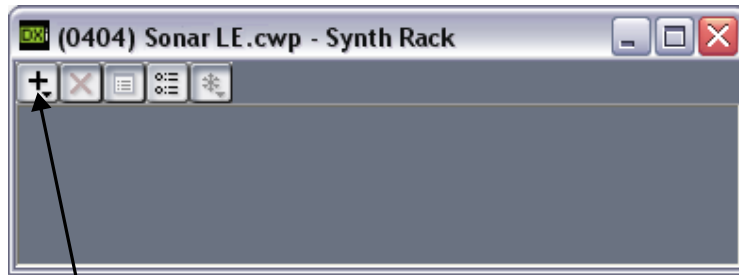

Click Here

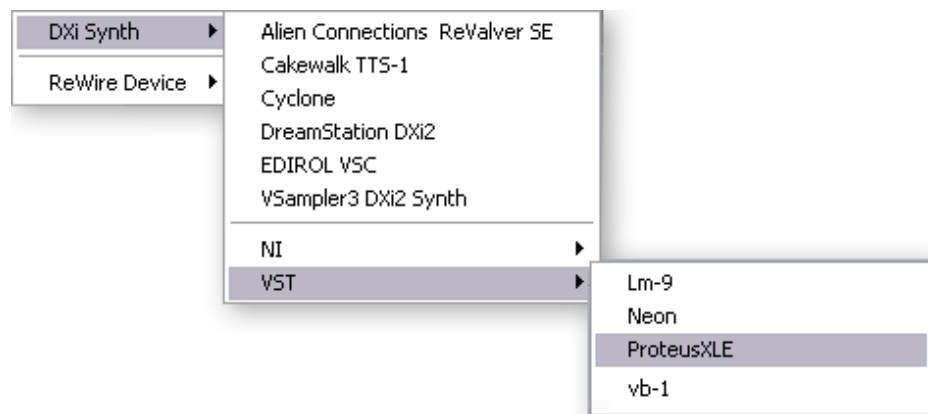

2. Click on the + symbol to add an instrument. Follow the path shown above and select **Proteus X LE** from the list or VST instruments. The following pop-up dialog box appears.



■ These instructions also apply to Proteus X or Emulator X.

3. Select the default options (MIDI Source Track & First Synth Output) as shown. Click **OK** to continue. (This may take a few seconds.)

- Proteus X LE now appears in the Synth rack and two new tracks have been added to the bottom of the track list. (You may have to scroll down to see the new tracks.)

#### New Proteus X LE Tracks



Make the MIDI Connection

- Select the blue **MIDI Input** track by clicking on it. The MIDI Input connection appears in the strip to the left of the MIDI tracks.

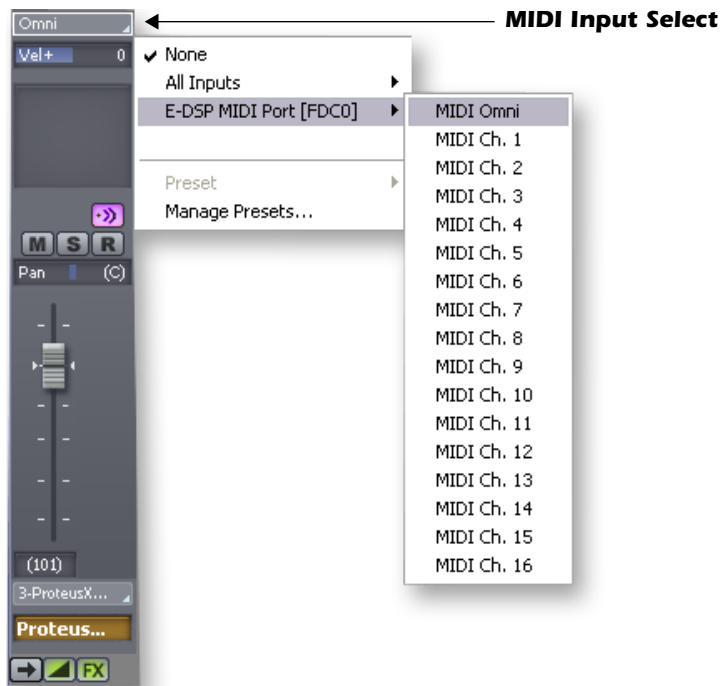

- Select **E-DSP MIDI Port** as the MIDI input and select **MIDI Omni** as shown at right. "MIDI Omni" allows Proteus X LE to receive all 16 MIDI channels. (Proteus X LE is "multitimbral" and can assign a different preset to each of the 16 MIDI channels.)

Open Proteus X LE

- Double-click on the number (or on the ProteusXLE name) to open the Proteus X LE editor.

#### Synth Rack with Proteus X LE

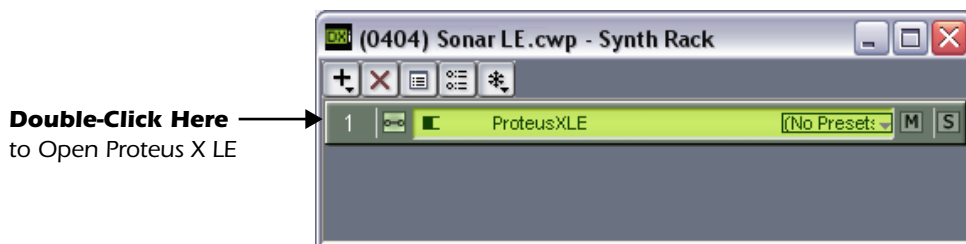

8. The Proteus X LE editor screen shown below appears.



Load the Proteus X Composer Bank

9. Proteus X LE is now running, but you need to load a bank of sounds.
10. Choose **Open** from the **File** menu on Proteus X LE. Locate and load the Proteus X Composer bank, which is located here: ("Program Files/Creative Professional/E-MU Sound Central") The bank takes a few seconds to load.

Play the Proteus X Composer Bank

11. **Click on the mini keyboard** at the bottom of the window. You should be hearing sound. If not, close Sonar LE, and verify that you have the PatchMix DSP **Product Default** session loaded. Then close and restart Sonar LE.
12. **Play your MIDI keyboard** (if connected) and verify that it plays Proteus X LE.
13. **Change the Preset** using the preset inc/dec keys. 
14. Feel free to play around for awhile and don't worry about losing anything. Nothing is made permanent until you **Save** the bank, so have fun.

### ► To Record a MIDI Track

15. Minimize the Proteus X LE window by pressing the minimize button .
16. **Record-Enable** the MIDI Track by pressing the track **Record** button. The track turns a dull red color to indicate that it is record-enabled.



17. Press **Record** on the Sonar LE Transport control and start playing.
18. Press **Stop** when you're finished recording the first track and press the **Return-to-Zero** button .
19. Press **Play** on the Sonar LE Transport to play back your track.

### ► To Record a MIDI Track on another MIDI Channel

Proteus X LE VSTi can play back up to 16 MIDI tracks at once. It's much better to use several channels on one VSTi than to use multiple VSTi's with one channel each.

20. Select **MIDI Track** from the **Insert** menu.
21. Select **E-DSP MIDI Port** as the MIDI input for the new MIDI track. Select **MIDI Omni** as you did before.
22. Select **Proteus XLE** as the **Output** destination for the track.
23. Bring up Proteus X LE again and **select MIDI Channel 2** using the channel inc/dec keys .
24. **Select a Preset on Channel 2.** Place the cursor in the preset number field and use the up/down arrow keys on your computer keyboard to scroll through the list.
25. When you're ready, **Record-Enable** the track, then hit **Record** on the Sonar LE Transport and start playing.
26. Press **Stop** when you're finished recording, then **RTZ** (return-to-zero), then **Play**. Proteus X LE now plays both MIDI channels.

◆ There are several ways to select presets. See the Proteus X LE Operation Manual for details.

### On Your Own

Now that you've had a taste of what Proteus X LE can do, please read the Proteus X LE Operation Manual pdf to learn all about this exceptional instrument.

Sonar LE also includes useful online documentation and help files to help you learn about the features of this powerful program.

## Ableton Live Lite 4 for E-MU

Ableton Live Lite 4 is an innovative composition and performance tool. Ableton Live combines digital recording, virtual instruments, digital effects with an original interface design that many people find more intuitive than traditional designs.

The following step by step tutorials are designed to get you recording as quickly as possible. After you have finished the tutorial we encourage you to follow Ableton Live's excellent interactive Lessons and read the Ableton Live reference manual pdf in order to learn more about the program.

### 1 - Setting up the Preferences

Follow these instructions carefully to ensure that Ableton Live Lite 4 runs smoothly the first time. Ableton Live Lite 4 will remember these settings, so you'll only have to do this once.

1. **Open Ableton Live Lite 4** from the Start menu or by double-clicking its desktop icon.
2. Select **Preferences...** from the **Options** menu. The following screen appears.

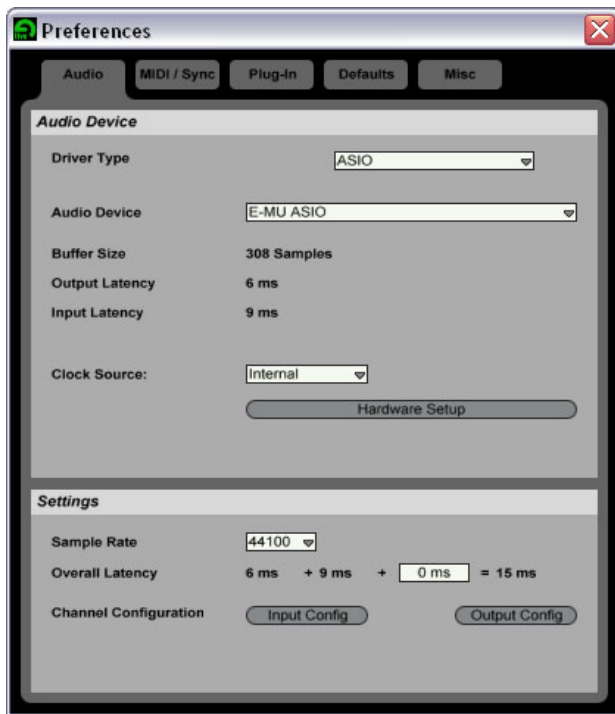

3. In the Driver Type section of the dialog box, select **ASIO**.
4. In the Audio Device section of the dialog box, select **E-MU ASIO**.
5. Click the **Hardware Setup** button. The pop-up dialog box shown at right appears.
6. Set the **ASIO Buffer Latency** to 10 ms or less. A low latency setting is important to assure fast MIDI response time and to minimize delay when monitoring. **Click OK**.

Setup the Channel Configuration

7. The **Output Configuration** is already selected and doesn't need to be changed.
8. Click on the **Input Configuration** button in the Audio Preferences. The following dialog box appears.



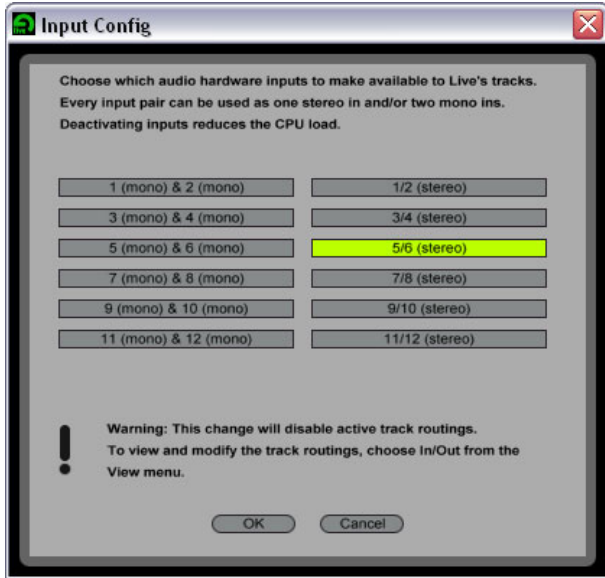

9. Select the ASIO channels that you might use to input audio into Ableton Live Lite 4. These numbers correspond to the **ASIO Send Inserts** in PatchMix DSP. For example, choose a stereo or mono input in PatchMix DSP, then click on the **SEND** in that strip. The ASIO Channels will be displayed in the PatchMix TV screen.
10. After you have made your selections, **click OK** to close the dialog box.

■ **Note:** You can only select two input channels in this special version of Ableton Live.

#### Set up Plug-ins

The following steps allow Ableton Live Lite 4 to find the Proteus X LE and PatchMix DSP VST plug-ins.

11. Click on the **Plug-ins** tab of the Preferences dialog box. The following screen appears.

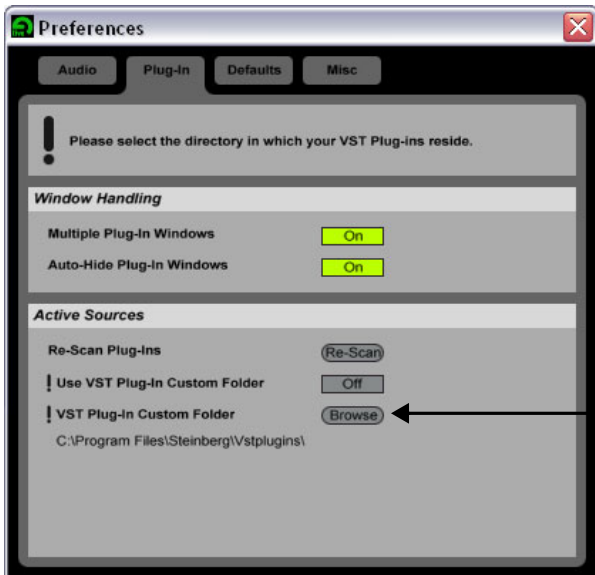

Locate: Steinberg\VSTplugins

12. Press the **Browse** button, then locate **VST Plugins** located in the **Steinberg** folder.
13. After selecting the VST plug-ins folder, press **OK**. (You may have to wait a few seconds while Ableton locates the plug-ins.)

Set up the MIDI Parameters

14. Click on the **MIDI/Sync** tab of the Preferences dialog box. The MIDI screen appears.

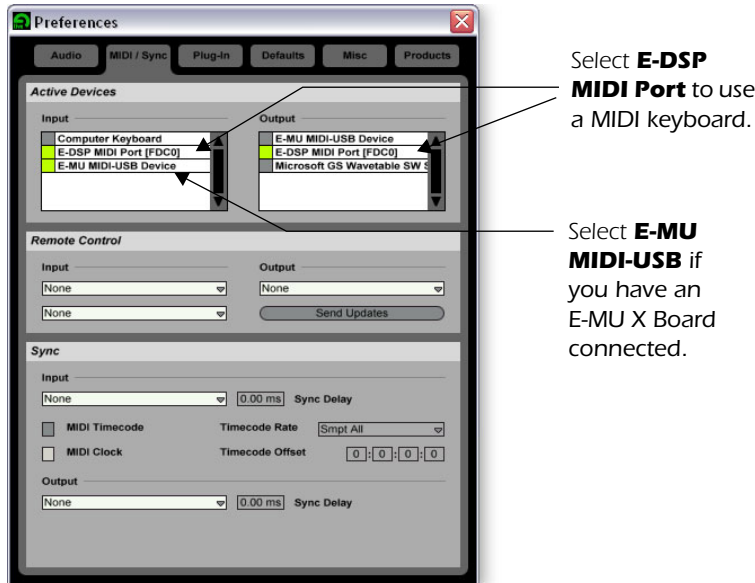

■ Live enables every MIDI input by default

Select **E-DSP MIDI Port** to use a MIDI keyboard.

Select **E-MU MIDI-USB** if you have an E-MU X Board connected.

15. Select the **E-DSP MIDI Port** if you want to connect a MIDI keyboard.

16. Select **E-MU-USB Device** if you have an E-MU X Board.

Set up the Miscellaneous Parameters

17. Click on the **Misc** tab of the Preferences dialog box. The following screen appears.

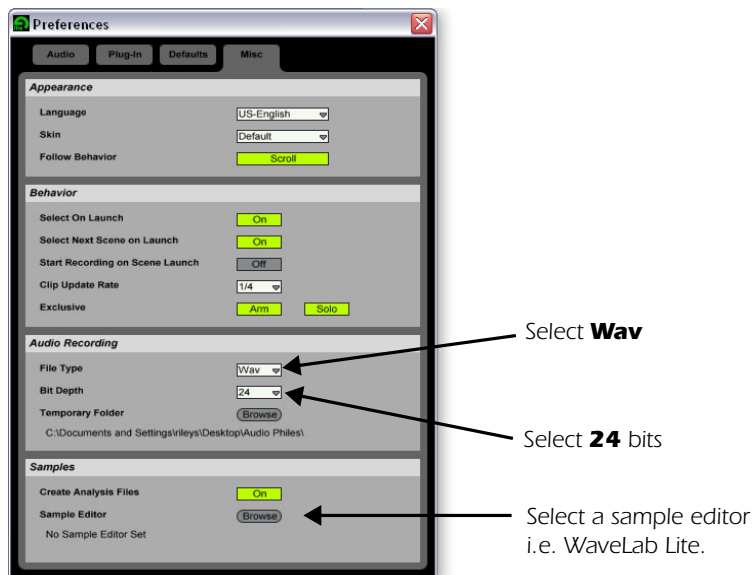

Select **Wav**

Select **24** bits

Select a sample editor i.e. WaveLab Lite.

18. Select **Wav** as the File Type, in the Audio Recording section of the dialog box.

19. Select **24** as the Bit Depth, in the Audio Recording section of the dialog box.

20. Select your favorite sample editor to be associated with Ableton Live Lite 4 for loop editing. Choose **WaveLab Lite** if you don't have another wave editor.

21. Close the Preferences dialog box by clicking the close box .



## 2 - Running Proteus X LE VSTi from Ableton Live Lite 4

These instructions explain how to run Proteus X LE from within Ableton Live Lite 4. Ableton Live's forte is making it easy to combine pre-recorded audio and MIDI clips in new and exciting ways. In this tutorial, you'll learn how to use a MIDI keyboard or the excellent pre-recorded MIDI loops that come with Ableton Live Lite 4 to play Proteus X LE.

■ These instructions also apply to Proteus X or Emulator X.

Select the Virtual Instrument

1. If you began with *Tutorial 1- Setting up the Preferences*, you should have a new set open with two audio tracks and two MIDI tracks such as the one shown below. (If you have another set open select **New Live Set** (Ctrl+N) from the File menu.)

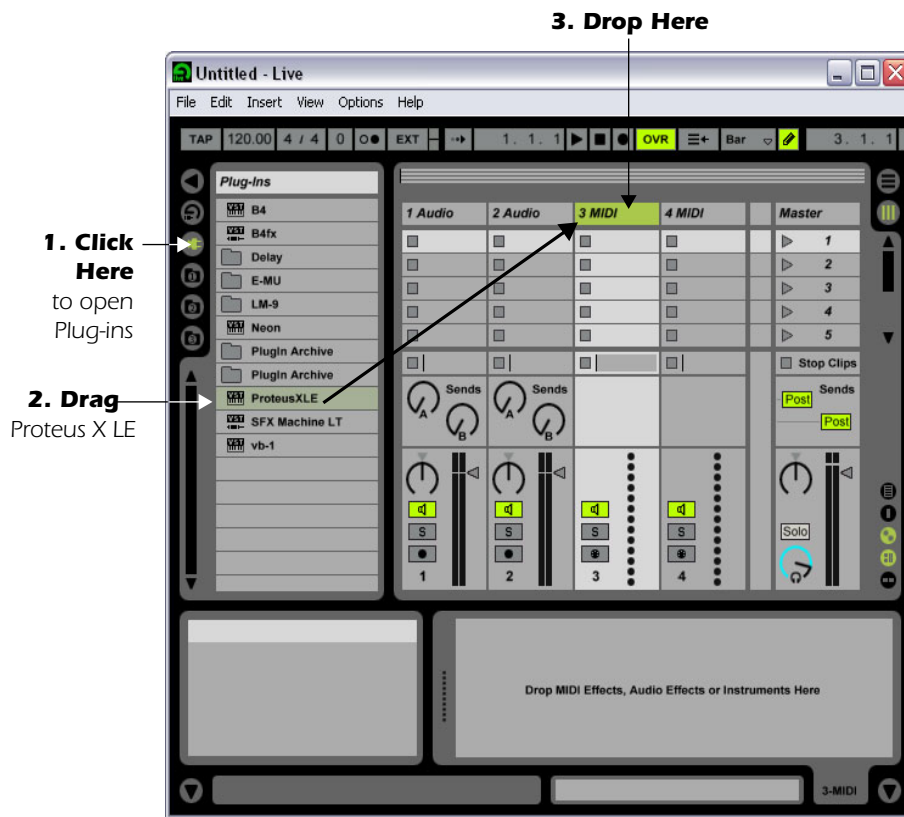

2. Click on the Plug-in Device Browser button  on the left side of the window. → The list of Ableton Plug-ins appears at the left side of the window.
3. Select **Proteus X LE** from the Plug-ins list and **drag it over the MIDI Track heading** as shown above. Wait a second or two, then you'll see the Proteus X LE VSTi appear in the MIDI Track View area below the mixer.

Load the Proteus X LE Bank

4. Click on the wrench icon  on Proteus X LE in the MIDI Track View area.





5. The Proteus X LE editor screen shown below appears.



Load the Proteus X Composer Bank

6. Proteus X LE is now running, but you need to load a bank of sounds.
7. Choose **Open** from the **File** menu on Proteus X LE. Locate and load the Proteus X Composer bank, which is located here: ("Program Files/Creative Professional/E-MU Sound Central") The bank takes a few seconds to load.

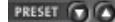
Play the Proteus X Composer Bank

8. **Click on the mini keyboard** at the bottom of the window. You should be hearing sound. If not, close Ableton Live Lite 4, and verify that you have the PatchMix DSP **Product Default** session loaded. Then close and restart Ableton Live Lite 4.
9. **Change the Preset** using the preset inc/dec keys. 
10. Feel free to play around for awhile—turn some knobs, change presets. Don't worry about losing anything. Nothing is made permanent until you **Save** the bank.
11. When you're ready to move on, select preset, **P0004 A KuStq**, then close the Proteus X LE editor by clicking on the close box .

Play MIDI Clips

12. Locate **MIDI Loops by Keyfax** in the Factory Content section of the Ableton Live Lite 4 Browser. →
13. Click on the folder to open it. You'll see a bunch of other folders.

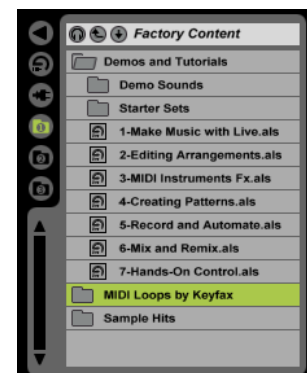

14. The first folder, BRK\_120 contains a nice bass riff. Open it, then open the next folder BRK-Bass.mid. Now, you'll see a MIDI file named BRK-Bass.
15. Click and drag BRK-Bass over one of the clip slots in the 3 MIDI strip as shown below.

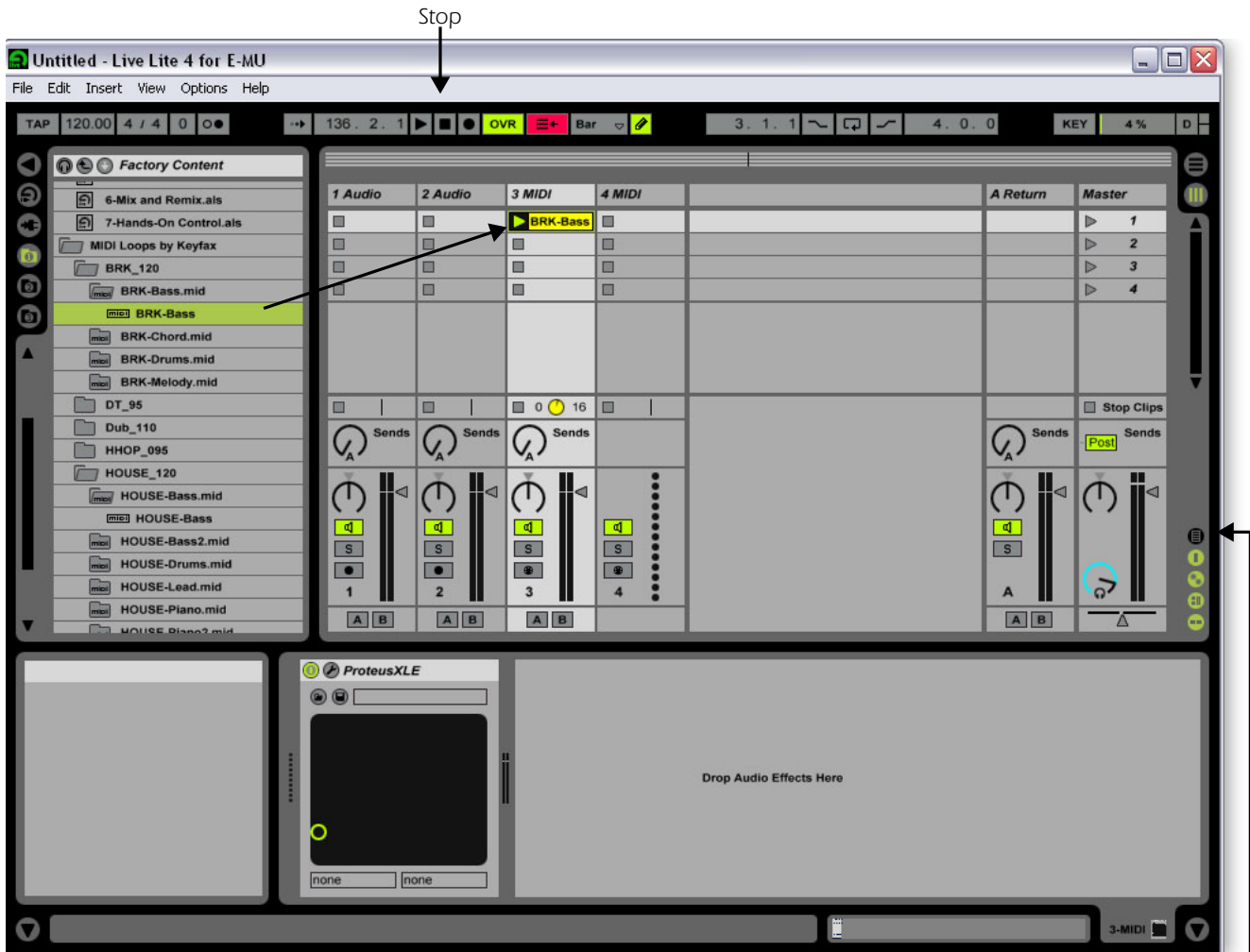

Show/Hide In/Out Section

16. Now click on the **Clip Launch Button** (little triangle) ► on the MIDI clip you just dragged over. The MIDI bass loop begins playing the bass preset on Proteus X LE. To stop playing, press the Stop button.
17. Find some other MIDI loops and drop them into the other slots of the track. **Hint:** look in different folders. Click on the Clip Launch Buttons to switch between clips.

#### Add Another MIDI Track

Ableton Live Lite 4 allows two MIDI tracks, so let's play a different MIDI loop and sound on track 4 MIDI.

18. Choose a different MIDI loop such as **House-Lead**, (located in the **HOUSE-120** folder) and drop it onto one of the 4 MIDI clip slots.
19. Click on the **Show/Hide In/Out Section** button shown above. The Input/Output options now appear in the track strips.
20. Currently, the **MIDI To** box reads "No Output". Instead, select **3-MIDI**. Another option box labeled "Track In" now appears beneath 3-MIDI.

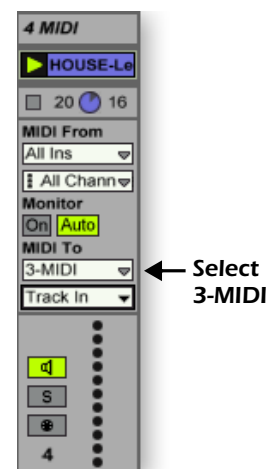

Select 3-MIDI

21. Click on the **Track In** box to see the list of MIDI channels.
22. Select **MIDI Channel 2** as shown at right.
23. Click on the **Clip Launch Button** ▶ on the 4 MIDI clip to get it started. You won't hear anything because you haven't yet assigned a preset to MIDI channel 2 on Proteus X LE.

#### Choose a Sound for MIDI Channel 2

24. Click on the **3 MIDI** heading to show the Proteus X LE VSTi. Next, click on the wrench icon ⚙ again (in the MIDI Track View) to open Proteus X LE.
25. Select **MIDI Channel 2** using the channel inc/dec keys .
26. Select a **Preset** on **Channel 2**. Place the cursor in the preset number field and use the up/down arrow keys on your computer keyboard to scroll through the list.
  - **Note:** There are several ways to select presets. See the Proteus X LE Operation manual for details.
27. Now you should be hearing the beat. If not, check to make sure both clips are playing (green triangle). Each clip plays a different preset.

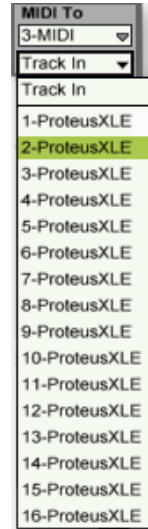

#### Add MIDI Clips

28. Drop a few more MIDI clips into both MIDI channel slots. Play around with the Clip Launch buttons.

#### Preset Change

Here's another way to change the MIDI Program (Preset in E-MU speak) without going into the Proteus X LE editor.

29. **Double-click on one of the currently playing MIDI clips.** The Clip View appears at the bottom of the window.
30. Select the **Show/Hide Notes Box**  located in the lower left corner of the Clip View window. The Notes box appears in the Clip View section. →
31. **Select a Program number.** You'll hear the Proteus X LE sound change. Keep selecting until you find one you like.
  - **Hint:** Use the **Up/Down Arrow** keys to select Programs. Use **Sub-Bank** to select presets higher than 128.
32. As an added bonus, the program (sound) you selected is now associated with the MIDI clip. Whenever you select this MIDI clip, the sound will also be selected.
33. Select another clip and assign a different program number. Notice that the Preset changes when you switch back and forth between clips.

■ Proteus X LE sounds are called Presets or Programs. Ableton Live Programs are offset by +1 from Proteus X LE.

#### Save the Set

34. Save your work by selecting **Save Live Set As...** from the File menu. The next time you load the set, the Proteus X LE bank will automatically load as well.

#### Setup to Record a MIDI Track

Now let's record a MIDI track using a USB keyboard such as the E-MU X Board or an external MIDI keyboard. Connect your MIDI keyboard now if it isn't already connected. If you're using a USB keyboard and it isn't connected, you'll have to quit Ableton Live Lite 4, connect the USB keyboard, then restart Ableton Live Lite 4 before continuing.

35. You can use the MIDI Track you set up on MIDI channel 2. Make sure there is at least one empty slot in the MIDI track. (Select and hit backspace to delete a clip.)

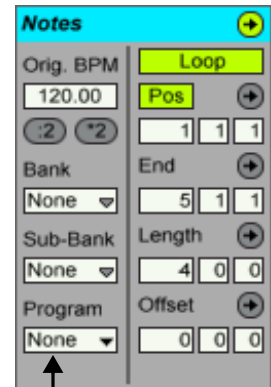

Select Preset

36. Click on the **Show/Hide In/Out Section** button  if it's not already selected. The Input/Output options now appear in the track strips.
37. Set up the MIDI track as shown at right.
  - a. Select either E-DSP MIDI for a MIDI keyboard or USB Device for a USB keyboard.
  - b. Set the input to listen to MIDI channel 2.
  - c. Monitor should be On (for now).
  - d. This routes the MIDI data to track 3 (which contains Proteus X LE).
  - e. Set the output to MIDI channel 2.
  - f. Turn record On (red).

38. Set your keyboard to transmit on **MIDI channel 2**.

39. **Play the keyboard.** You should hear Proteus X LE playing the last sound you selected on channel 2. Go ahead and change the sound if you wish. (Double-click the top of Track 3, then click the **Wrench** icon on the Device Title Bar. Make sure you're changing the sound on channel 2.)

#### Ready to Record

40. Start up the bass line on track 3 MIDI and practice playing along with it.
41. Optional: You can set the **Global Quantization** value to time correct your playing. Set it to anything other than "None".



42. Click on any of the **MIDI Clip Record** buttons to begin recording. 
43. Click the **Clip Launch** button, the **Clip Stop** button, or the **Spacebar** to stop recording.

#### On Your Own

Now you've had a taste of what Proteus X LE and Ableton Live Lite 4 can do. But don't stop now! Read the Proteus X LE Operation Manual pdf to learn all about this exceptional instrument.

Ableton Live Lite 4 for E-MU includes several excellent hands-on tutorials to help you learn all the features of this ground breaking music application.

**Note:** The "Assignable X-Y Controls" are not enabled in this version of Proteus X LE.

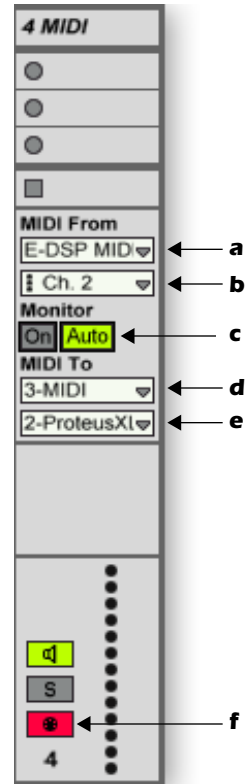

### 3 - Recording Audio into Ableton Live Lite 4

These instructions explain how to record your own audio loops into Ableton Live Lite 4.

Clean the Slate

1. Choose **New Live Set** (Ctrl+N) from the Ableton Live Lite 4 **File** menu.

Setup Ableton Live Lite 4

2. Click on the **Show/Hide In/Out Section** button  shown on [page 35](#). The Input/Output options now appear in the track strips
3. Set up the **1 Audio** Track as shown at right with **Ext In**, the **ASIO** input selected and **Monitor On**.
4. You should now see meter activity and hear audio when you feed a signal into PatchMix DSP. If not, you may have the wrong input channels selected (#2 in the diagram at right).

If you still don't have audio, verify meter activity on PatchMix DSP and make sure ASIO Send on PatchMix DSP matches the Ableton Input select. (Ableton inputs are selected on the Preferences menu. See ["Setup the Channel Configuration"](#) on [page 30](#).

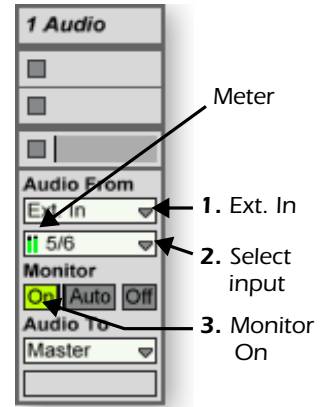

Ready to Record

5. Click the **Record** button to record-enable the track. The record button and the channel meters turn red.
6. When you're ready to record, **click the circle on the clip** you want to record into. Recording begins immediately. The circle turns into a green triangle.
7. **To stop recording, press the spacebar**, and turn off the red **Record-Enable** button.
8. Set the Monitor to **Auto** to and click the triangle on the clip playback the audio you recorded.
9. If you're not happy with the recording, **select the clip**, then hit the **Backspace** button to dump it.
10. **Double-click on the clip** to display the sample parameters below the mixer.
11. If you need to edit your loop, Ableton provides a host of loop editing features. See the pdf manual and Lessons.
12. Depending on how accurately you pressed record and stop buttons, you might have to trim the start and end points of the loop with an editor. The **Edit** button in the Sample parameters calls the selected wave editor (normally WaveLab Lite).
13. When you're finished editing the loop, simply close (quit) the wave editor and **Save selected** over without changing the name when prompted. The clip will now contain your edited wave.



Continue On

Ableton Live Lite 4 for E-MU is a powerful music creation tool that's really fun to use. Now that you know how to get audio in and out and how to run Proteus X LE, continue on by following the excellent hands-on Lessons provided with the Ableton software.

## Recording & Monitoring with Effects

### The Order of Effects

PatchMix DSP allows you to record your tracks without effects (dry) and monitor with effects enabled (wet). It works like this: If the effect is inserted *BEFORE* the ASIO send in the signal path, it will get recorded; if the effect is inserted *AFTER* the ASIO send, it will not be recorded.

Recording dry allows you to hear your performance with effect (to get the proper feel), but gives you the flexibility to add or modify effects later during mixdown. This way if you don't like the way the effect sounds, you can change or modify the effect without having to perform the part again.

The basic session setup for this is shown below.

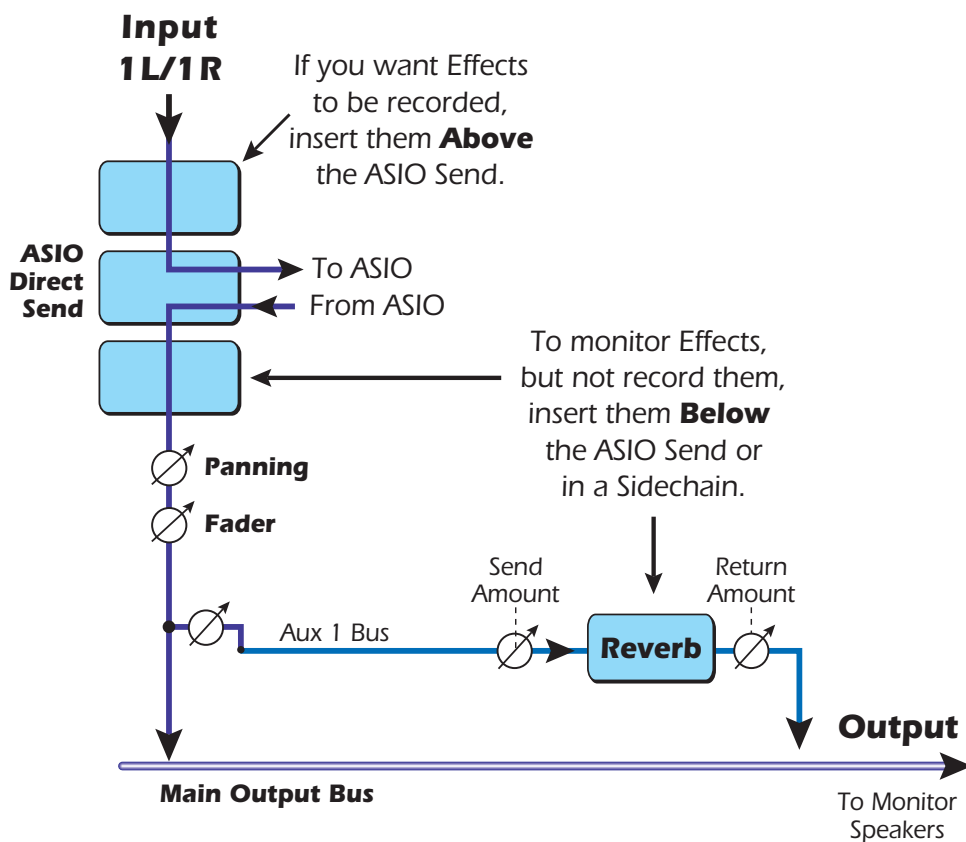

## About PatchMix DSP

### PatchMix = Patchbay + Mixer

It's a simple concept. PatchMix is a patchbay for your computer, where any physical input or output (analog, S/PDIF, ADAT) can be connected to any HOST input or output (ASIO, WDM, WAVE). Strips = Inputs and Insert Sends = Outputs. That's the "Patch" part of the name. Now add a simple mixer with two auxiliary sends and a bunch of effects. This lets you hear zero-latency effects while recording, a feat that no plug-in effect can match. It's a super-flexible patchbay first and a mixer second—PatchMix.

### Too Much Power?

We included the PatchMix DSP mixer and powered effects because they allow you to do things that you can't do with any other sound card. However...please do not be intimidated by PatchMix, because you **DON'T HAVE TO USE IT** unless you want to. The **Product Default Session** connects every input and output for you. Once this session is selected, you can forget about PatchMix and use the Digital Audio System like any other sound card without the hardware effects and flexible routing features. PatchMix was never meant to replace the mixer of your recording application. It's forte is allowing you to connect your hardware inputs and outputs to your software applications in a number of useful ways. You may not need this additional power right away. Use PatchMix in the background if you prefer, and come back to it whenever you're ready.

## About ASIO

ASIO stands for Audio Stream In/Out and is a standard communication protocol between audio software and a piece of audio hardware. The low latency made possible by ASIO, for example, allows you to sing into a microphone and hear your voice going through software and hardware effects with virtually no delay in the signal. The effects of a low-latency ASIO driver make it ideal for use with Virtual Studio Technology (VST) instruments, plug-ins, and all other software-based synthesizers.

## IMPORTANT -> Activating ASIO

It is important to understand that ASIO inputs do not appear in Cubase or other host applications until they are **CREATED** in PatchMix DSP. This allows you to dynamically assign the 32 available ASIO channels according to your specific needs.

### ► An Example:

1. Create a new strip from a physical source such as S/PDIF L/R.
2. Next, right-click on the new strip's insert chain and select the **Insert Send** option.
3. Choose an available host ASIO input.
4. This S/PDIF L/R input should now be available to record in your ASIO application.

## ASIO Channels are STEREO!

ASIO channels are stereo, period. Even when you are recording a mono source such as a microphone, the ASIO stream is stereo (with the mono signal on both channels). To record a mono input, you simply set up a sequencer track as a mono track and use either the left or right ASIO channel from PatchMix as the input for the track.



---

# Index

## A

- Ableton Live Lite 4 for E-MU
  - changing presets 36
  - playing MIDI clips 34
  - recording audio into 38
  - running Proteus X LE in 33
  - setting up 30
- Add Track, Cubase LE 12
- AIFF Export
  - Cubase LE 11
  - WaveLab Lite 18
- ASIO
  - activating 40
  - definition 40
- ASIO Buffer Latency 6, 19, 30
- ASIO Send Inserts, setup in Ableton Live Lite 31
- Audio File Format, WaveLab Lite 17
- Audio Recording Prefs, Ableton Live Lite 32
- Audio Settings, Sonar LE 19

## B

- Basic Recording Components 8, 23
- Block Diagram
  - Cubase LE record path 9
  - recording mono inputs as stereo 9
  - Sonar LE record path 23

## C

- Control Panel 6
- Cubase LE
  - project window 7
  - recording template 7
  - running Proteus X LE in 12
  - setting up 6
  - tutorial 6

## D

- Device Setup, Cubase LE 6
- Devices 12
  - menu, Cubase LE 6

- Sonar MIDI 20
- Direct Monitoring box 6

## E

- E-DSP MIDI Ports, Sonar LE 20
- E-DSP Wave, WaveLab Lite 15
- Effects, order of 39
- E-MU ASIO
  - Ableton Live Lite 4 30
  - Cubase LE 6
  - Sonar LE 19
- Export Audio
  - Cubase LE 10
  - Sonar LE 24
- Export Formats
  - Cubase LE 11
  - Sonar LE 25

## H

- Hardware Setup, Ableton Live Lite 30

## I

- Inspector, Cubase LE 13

## M

- MIDI Channels, using multiple 14, 29, 36
- MIDI Clips
  - adding in Ableton Live Lite 36
  - playing in Ableton Live Lite 34
- MIDI Connection
  - Cubase LE 13
  - Sonar LE 27
- MIDI Devices, Sonar LE 20
- MIDI Track
  - adding in Ableton Live Lite 35
  - recording in Cubase LE 14
  - recording in Sonar LE 29
- Mixdown to Stereo
  - Cubase LE 10
  - Sonar LE 24
- Monitor Button, Cubase LE 7
- Monitor with Effects 39
- Mono Inputs, recording as stereo 17
- Multitrack Recording
  - Cubase LE 7
  - Sonar LE 21

## N

- Normalize 18

**O**

- Options Menu
  - Ableton Live Lite 30
  - Sonar LE 19
- Order of Effects 39

**P**

- PatchMix, opening 5
- Preferences
  - Ableton Live Lite 4 30
  - WaveLab Lite 15
- Preset Changes, Ableton Live Lite 36
- Product Default Session 5
- Project Window, Cubase LE 7
- Proteus X Composer Bank, loading 14, 28, 34
- Proteus X LE
  - editor screen 28
  - using with Ableton Live Lite 33
  - using with Cubase LE 12
  - using with Sonar LE 26

**R**

- Record a Track
  - Cubase LE 8
  - Sonar LE 22
- Record Window, WaveLab Lite 17
- Recording
  - into Ableton Live Lite 38
  - into Cubase LE 7
  - into Sonar LE 21
  - into WaveLab Lite 18
- Recording Effects or Recording Dry 39
- Recording Mono Inputs as Stereo
  - Cubase LE 9
  - WaveLab Lite 17

**S**

- Save Audio File, WaveLab Lite 18
- Save Live Set, Ableton Live Lite 36
- Save Project
  - Cubase LE 8
  - Sonar LE 23
- Select Directory 7
- Sonar LE 19
  - multitrack recording 21
  - project window 21
  - record path diagram 23
  - running Proteus X LE in 26
  - setting up 19
- Sub-Bank, Ableton Live Lite 36

**T**

- Track Input Meter, Cubase LE 7
- Track Record Enable Button
  - Ableton Live Lite 38
  - Sonar LE 22

**V**

- VST Instruments 12
- VST Multitrack 6
- VST Plug-ins, locating in Ableton Live Lite 31

**W**

- WAV Export
  - Cubase LE 11
  - Sonar LE 25
- WAVE Send, enabling in PatchMix 16
- WaveLab Lite 15
  - normalizing 18
  - recording 17
  - setting up 15
- WDM Drivers 15
- WDM, important note 18