



O1V96

DIGITAL MIXING CONSOLE

Version 2

Owner's Manual



Keep This Manual For Future Reference.



FCC INFORMATION (U.S.A.)

1. IMPORTANT NOTICE: DO NOT MODIFY THIS UNIT!

This product, when installed as indicated in the instructions contained in this manual, meets FCC requirements. Modifications not expressly approved by Yamaha may void your authority, granted by the FCC, to use the product.

2. IMPORTANT: When connecting this product to accessories and/or another product use only high quality shielded cables. Cable/s supplied with this product **MUST** be used. Follow all installation instructions. Failure to follow instructions could void your FCC authorization to use this product in the USA.

3. NOTE: This product has been tested and found to comply with the requirements listed in FCC Regulations, Part 15 for Class "B" digital devices. Compliance with these requirements provides a reasonable level of assurance that your use of this product in a residential environment will not result in harmful interference with other electronic devices. This equipment generates/uses radio frequencies and, if not installed and used according to the instructions found in the users manual, may cause interference harmful to the operation of other electronic devices. Compliance with FCC regulations does

not guarantee that interference will not occur in all installations. If this product is found to be the source of interference, which can be determined by turning the unit "OFF" and "ON", please try to eliminate the problem by using one of the following measures:

Relocate either this product or the device that is being affected by the interference.

Utilize power outlets that are on different branch (circuit breaker or fuse) circuits or install AC line filter/s.

In the case of radio or TV interference, relocate/reorient the antenna. If the antenna lead-in is 300 ohm ribbon lead, change the lead-in to co-axial type cable.

If these corrective measures do not produce satisfactory results, please contact the local retailer authorized to distribute this type of product. If you can not locate the appropriate retailer, please contact Yamaha Corporation of America, Electronic Service Division, 6600 Orangethorpe Ave, Buena Park, CA90620

The above statements apply **ONLY** to those products distributed by Yamaha Corporation of America or its subsidiaries.

* This applies only to products distributed by YAMAHA CORPORATION OF AMERICA.

(class B)

ADVARSEL!

Lithiumbatteri—Eksplussionsfare ved fejlagtig håndtering. Udskiftning må kun ske med batteri af samme fabrikat og type. Levér det brugte batteri tilbage til leverandoren.

VARNING

Explosionsfara vid felaktigt batteribyte. Använd samma batterityp eller en ekvivalent typ som rekommenderas av apparattillverkaren. Kassera använt batteri enligt fabrikantens instruktion.

VAROITUS

Paristo voi räjähtää, jos se on virheellisesti asennettu. Vaihda paristo ainoastaan laitevalmistajan suosittelemaan tyyppiin. Hävitä käytetty paristo valmistajan ohjeiden mukaisesti.

(lithium caution)

IMPORTANT NOTICE FOR THE UNITED KINGDOM

Connecting the Plug and Cord

WARNING: THIS APPARATUS MUST BE EARTHED

IMPORTANT. The wires in this mains lead are coloured in accordance with the following code:

GREEN-AND-YELLOW	: EARTH
BLUE	: NEUTRAL
BROWN	: LIVE

As the colours of the wires in the mains lead of this apparatus may not correspond with the coloured markings identifying the terminals in your plug proceed as follows:

The wire which is coloured GREEN-and-YELLOW must be connected to the terminal in the plug which is marked by the letter E or by the safety earth symbol  or colored GREEN or GREEN-and-YELLOW.

The wire which is coloured BLUE must be connected to the terminal which is marked with the letter N or coloured BLACK.

The wire which is coloured BROWN must be connected to the terminal which is marked with the letter L or coloured RED.

• This applies only to products distributed by Yamaha-Kemble Music (U.K.) Ltd. (3 wires)

NEDERLAND / THE NETHERLANDS

- Dit apparaat bevat een lithium batterij voor geheugen back-up.
- This apparatus contains a lithium battery for memory back-up.
- Raadpleeg uw leverancier over de verwijdering van de batterij op het moment dat u het apparaat aan het einde van de levensduur afdankt of de volgende Yamaha Service Afdeling:
Yamaha Music Nederland Service Afdeling
Kanaalweg 18-G, 3526 KL UTRECHT
Tel. 030-2828425
- For the removal of the battery at the moment of the disposal at the end of the service life please consult your retailer or Yamaha Service Center as follows:
Yamaha Music Nederland Service Center
Address : Kanaalweg 18-G, 3526 KL UTRECHT
Tel : 030-2828425
- Gooi de batterij niet weg, maar lever hem in als KCA.
- Do not throw away the battery. Instead, hand it in as small chemical waste.

(lithium disposal)

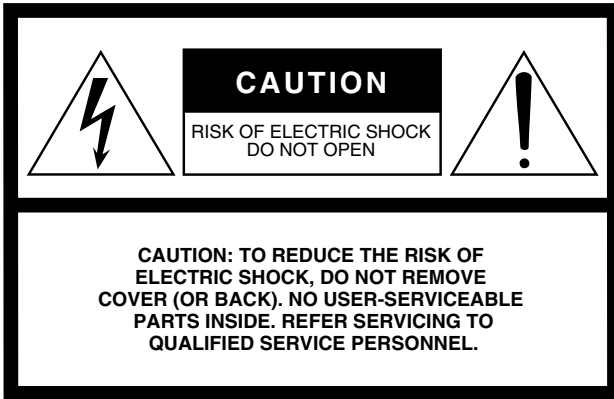

The above warning is located on the side of the unit

• Explanation of Graphical Symbols

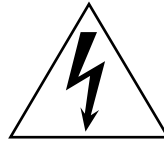

The lightning flash with arrowhead symbol within an equilateral triangle is intended to alert the user to the presence of uninsulated “dangerous voltage” within the product’s enclosure that may be of sufficient magnitude to constitute a risk of electric shock to persons.



The exclamation point within an equilateral triangle is intended to alert the user to the presence of important operating and maintenance (servicing) instructions in the literature accompanying the product.

IMPORTANT SAFETY INSTRUCTIONS

- 1 Read these instructions.
- 2 Keep these instructions.
- 3 Heed all warnings.
- 4 Follow all instructions.
- 5 Do not use this apparatus near water.
- 6 Clean only with dry cloth.
- 7 Do not block any ventilation openings. Install in accordance with the manufacturer’s instructions.
- 8 Do not install near any heat sources such as radiators, heat registers, stoves, or other apparatus (including amplifiers) that produce heat.
- 9 Do not defeat the safety purpose of the polarized or grounding-type plug. A polarized plug has two blades with one wider than the other. A grounding type plug has two blades and a third grounding prong. The wide blade or the third prong are provided for your safety. If the provided plug does not fit into your outlet, consult an electrician for replacement of the obsolete outlet.
- 10 Protect the power cord from being walked on or pinched particularly at plugs, convenience receptacles, and the point where they exit from the apparatus.
- 11 Only use attachments/accessories specified by the manufacturer.
- 12 Use only with the cart, stand, tripod, bracket, or table specified by the manufacturer, or sold with the apparatus. When a cart is used, use caution when moving the cart/apparatus combination to avoid injury from tip-over.
- 13 Unplug this apparatus during lightning storms or when unused for long periods of time.
- 14 Refer all servicing to qualified service personnel. Servicing is required when the apparatus has been damaged in any way, such as power-supply cord or plug is damaged, liquid has been spilled or objects have fallen into the apparatus, the apparatus has been exposed to rain or moisture, does not operate normally, or has been dropped.



WARNING

TO REDUCE THE RISK OF FIRE OR ELECTRIC SHOCK, DO NOT EXPOSE THIS APPARATUS TO RAIN OR MOISTURE.

PRECAUTIONS

PLEASE READ CAREFULLY BEFORE PROCEEDING

* Please keep this manual in a safe place for future reference.



WARNING

Always follow the basic precautions listed below to avoid the possibility of serious injury or even death from electrical shock, short-circuiting, damages, fire or other hazards. These precautions include, but are not limited to, the following:

Power supply/Power cord

- Only use the voltage specified as correct for the device. The required voltage is printed on the name plate of the device.
- Use only the specified power code.
- Do not place the power cord near heat sources such as heaters or radiators, and do not excessively bend or otherwise damage the cord, place heavy objects on it, or place it in a position where anyone could walk on, trip over, or roll anything over it.

Do not open

- Do not open the device or attempt to disassemble the internal parts or modify them in any way. The device contains no user-serviceable parts. If it should appear to be malfunctioning, discontinue use immediately and have it inspected by qualified Yamaha service personnel.

Water warning

- Do not expose the device to rain, use it near water or in damp or wet conditions, or place containers on it containing liquids which might spill into any openings.
- Never insert or remove an electric plug with wet hands.

If you notice any abnormality

- If the power cord or plug becomes frayed or damaged, or if there is a sudden loss of sound during use of the device, or if any unusual smells or smoke should appear to be caused by it, immediately turn off the power switch, disconnect the electric plug from the outlet, and have the device inspected by qualified Yamaha service personnel.
- If this device should be dropped or damaged, immediately turn off the power switch, disconnect the electric plug from the outlet, and have the device inspected by qualified Yamaha service personnel.



CAUTION

Always follow the basic precautions listed below to avoid the possibility of physical injury to you or others, or damage to the device or other property. These precautions include, but are not limited to, the following:

Power supply/Power cord

- Remove the electric plug from the outlet when the device is not to be used for extended periods of time, or during electrical storms.
- When removing the electric plug from the device or an outlet, always hold the plug itself and not the cord. Pulling by the cord can damage it.

Location

- Before moving the device, remove all connected cables.
- Avoid setting all equalizer controls and faders to their maximum. Depending on the condition of the connected devices, doing so may cause feedback and may damage the speakers.
- Do not expose the device to excessive dust or vibrations, or extreme cold or heat (such as in direct sunlight, near a heater, or in a car during the day) to prevent the possibility of panel disfiguration or damage to the internal components.
- Do not place the device in an unstable position where it might accidentally fall over.

- Do not block the vents. This device has ventilation holes at the top/front/rear/sides to prevent the internal temperature from rising too high. In particular, do not place the device on its side or upside down, or place it in any poorly-ventilated location, such as a bookcase or closet.
- Do not use the device in the vicinity of a TV, radio, stereo equipment, mobile phone, or other electric devices. Otherwise, the device, TV, or radio may generate noise.

Connections

- Before connecting the device to other devices, turn off the power for all devices. Before turning the power on or off for all devices, set all volume levels to minimum.
- Be sure to connect to a properly grounded power source. A ground screw terminal is provided on the rear panel for safely grounding the device and preventing electrical shock.

Handling caution

- Do not insert your fingers or hand in any gaps or openings on the device (vents, etc.).
- Avoid inserting or dropping foreign objects (paper, plastic, metal, etc.) into any gaps or openings on the device (vents, etc.) If this happens, turn off the power immediately and unplug the power cord from the AC outlet. Then have the device inspected by qualified Yamaha service personnel.
- Do not use headphones for a long period of time at a high or uncomfortable volume level, since this can cause permanent hearing loss. If you experience any hearing loss or ringing in the ears, consult a physician.
- Do not apply oil, grease, or contact cleaner to the faders. Doing so may cause problems with electrical contact or fader motion.
- Do not rest your weight on the device or place heavy objects on it, and avoid use excessive force on the buttons, switches or connectors.
- This device has a rear-panel slot for installing mini-YGDAI cards. For technical reasons, certain card combinations are not supported. Before installing any cards, check the Yamaha web site (see page 6) to see whether your card is compatible.
Installing cards that are not endorsed by Yamaha may cause electrical shock, fire, or damage to the unit.

Backup battery

- This device has a built-in backup battery. When you unplug the power cord from the AC outlet, the internal data is retained. However, if the backup battery fully discharges, this data will be lost. If the backup battery is running low, when you turn on the device the display indicates "WARNING Low Battery!". In this case, immediately save the data to an external media using MIDI Bulk Dump, then have qualified Yamaha service personnel replace the backup battery.

- Using a mobile telephone near this unit may induce noise. If noise occurs, use the telephone away from the unit.
- The digital circuits of this unit may induce a slight noise into nearby radios and TVs. If noise occurs, relocate the affected equipment.
- When you change the wordclock settings on any device in your digital audio system, some devices may output noise, so turn down your power amps beforehand, otherwise your speakers may be damaged.

XLR-type connectors are wired as follows (IEC60268 standard): pin 1: ground, pin 2: hot (+), and pin 3: cold (-).
Insert TRS phone jacks are wired as follows: sleeve: ground, tip: send, and ring: return.

Yamaha cannot be held responsible for damage caused by improper use or modifications to the device, or data that is lost or destroyed.

Always turn the power off when the device is not in use.

The performance of components with moving contacts, such as switches, volume controls, and connectors, deteriorates over time. Consult qualified Yamaha service personnel about replacing defective components.

- * The illustrations and screen displays as shown in this Owner's Manual are for instructional purposes only, and may be different from the ones on your device.
- * The company names and product names in this Owner's Manual are the trademarks or registered trademarks of their respective companies.

Yamaha Pro Audio global website

<http://www.yamahaproaudio.com/>

Package Contents

- 01V96 Digital Mixing Console
- CD-ROM
- Power cord
- This manual
- Studio Manager Installation Guide

Optional Extras

- RK1 Rack Mount Kit
- mini YGDAI I/O cards

About this Owner's Manual

This *Owner's Manual* explains how to operate the 01V96 Digital Mixing Console.

The Table of Contents can help you to familiarize yourself with the manual's organization and to locate tasks and topics. The index can help you locate specific information.

Before diving in, it's recommend that you read the "Operating Basics" chapter, starting on page 27.

Each chapter in this manual discusses a specific section or function of the 01V96. The Input and Output Channels are explained in the following chapters: "Input Channels," "Bus Outs," and "Aux Outs." Where possible, these chapters have been organized in order of signal flow, from input to output.

Conventions Used in this Manual

The 01V96 features two types of buttons: physical buttons that you can press (e.g., ENTER and DISPLAY) and buttons that appear on the display pages. References to physical buttons are enclosed in square brackets, for example, "press the [ENTER] button."

References to display page buttons are not emphasized, for example, "move the cursor to the ON button."

You can select display pages by using the [DISPLAY] buttons or the Left Tab Scroll, Right Tab Scroll, and F1–4 buttons below the display. In order to simplify explanations, the procedures reference only the [DISPLAY] button method.

See "Selecting Display Pages" on page 28 for details on all the ways in which you can select pages.

New Functions in 01V96 Version 2

The following functions have been added to the 01V96 as part of the upgrade of the firmware from version 1.0 to version 2.0.

Aux Sends

- If an Aux Send is set to pre-fader, you can set the Pre point before or after channel mute. → page 114

Monitor

- You can select whether the Input Channel's Pan setting is used when the Input Channel Solo signal is set to Pre Fader. → page 132
- Raising the channel faders for soloed Channels from $-\infty$ can unsolo the Channels. → page 132

Surround Pan

- The on/off status of the Follow Pan button is reflected in the pan and Surround Pan settings. → page 135

Group/Link

- The Fader Group Master function enables you to control the overall level of the Fader group channels simultaneously while maintaining the relative level balance of each channel. → page 152
- The Mute Group Master function enables you to mute all channels in a Mute group simultaneously. → page 153

Internal Effects

- You can add optional Add-On Effects to the preset effects. → page 162

Scene Memory

- Any channel or parameter settings in the current scene can be copied and pasted into other scenes. → page 173
- You can select additional parameters for the Recall Safe function. → page 172

Remote Control

- Cubase SX has been added as a target of the Remote layer. → page 189
- Yamaha's proprietary Advanced DAW protocol has been added to Nuendo, Cubase SX, and General DAW. This enables you to control these devices using the 01V96's SELECTED CHANNEL section. (Controllable functions vary depending on the DAW software and version you are using.)

Other Functions

- You can set the Routing ST Pair Link so that the routing from paired channels to the Stereo Bus is linked. → page 232
- You can assign the selected channels to a Fader or Mute group using the USER DEFINED KEYS. → page 247
- You can switch the windows of the included Studio Manager software application using the USER DEFINED KEYS. → page 247

Contents

1	Welcome	11
2	Control Surface & Rear Panel	13
	Control Surface	13
	Rear Panel	23
	Installing an Optional Card	26
3	Operating Basics	27
	About the Display	27
	Selecting Display Pages	28
	Display Interface	29
	Selecting Layers	31
	Selecting Channels	32
	Selecting Fader Modes	33
	Metering	34
4	Connections and Setup	37
	Connections	37
	Wordclock Connections and Settings	40
	Input and Output Patching	43
5	Tutorial	47
	Connections and Setup	47
	Initial Track Recording	49
	Overdubbing to Other Tracks	60
	Mixing Recorded Tracks into Stereo (Mixdown)	63
6	Analog I/O & Digital I/O	69
	Analog Inputs & Outputs	69
	Digital Inputs & Outputs	71
	Converting Sampling Rates of Signals Received at I/O Card Inputs	72
	Monitoring Digital Input Channel Status	73
	Dithering Digital Outputs	74
	Setting the Transfer Format for Higher Sampling Rates	75
7	Input Channels	77
	About Input Channels	77
	Setting the Input Channels from the Display	79
	Setting the Input Channels from the Control Surface	90
	Pairing Input Channels	92
	Naming Input Channels	94
8	Bus Outs	97
	About Stereo Out	97
	Bus Out 1–8	98
	Setting the Stereo Out and Bus Out 1–8 from the Display	99
	Setting the Stereo Out and Bus Out 1–8 from the Control Surface	104
	Pairing Buses or Aux Sends	105
	Attenuating Output Signals	106
	Naming the Stereo Out and Bus Outs	107
9	Aux Outs	109
	Aux Out 1–8	109
	Setting Aux Out 1–8 from the Display	110
	Viewing Aux Out Settings	112
	Setting Aux Out 1–8 from the Control Surface	113

Setting Aux Send Levels	113
Viewing Aux Send Settings for Multiple Channels	117
Panning Aux Sends	119
Copying Channel Fader Positions to Aux Sends	120
10 Input & Output Patching	121
Input Patching	121
Output Patching	123
Patching Direct Outs	125
Insert Patching	127
11 Monitoring	131
Monitor	131
Monitor and Solo Setup	132
Using the Monitor	133
Using the Solo Function	134
12 Surround Pan	135
About Surround Pan	135
Setting Up and Selecting Surround Pan Modes	136
Surround Panning	142
13 Grouping Channels & Linking Parameters	149
Grouping & Linking	149
Using Fader Groups and Mute Groups	150
Using Fader Group Master	152
Using Mute Group Master	153
Linking EQ and Compressor Parameters	154
14 Internal Effects	157
About the Internal Effects	157
Using Effects Processors via Aux Sends	158
Inserting the Internal Effects into Channels	160
Editing Effects	161
About Add-On Effects	162
About Plug-Ins	163
15 Scene Memories	165
About Scene Memories	165
What is Stored in a Scene?	165
About Scene Numbers	166
Storing and Recalling Scenes	167
Auto Scene Memory Update	169
Fading Scenes	170
Recalling Scenes Safely	172
Sorting Scenes	173
Copying and Pasting a Scene (Global Paste)	173
16 Libraries	175
About the Libraries	175
General Library Operation	175
Using Libraries	177
17 Remote Control	189
About Remote Function	189
Pro Tools Remote Layer	190
Nuendo/Cubase SX Remote Layer	206
Other DAW Remote Layer	206
MIDI Remote Layer	207
Machine Control Function	212

18 MIDI	215
MIDI & the 01V96	215
MIDI Port Setup	216
Assigning Scenes to Program Changes for Remote Recall	219
Assigning Parameters to Control Changes for Real-time Control	220
Controlling Parameters by Using Parameter Changes	225
Transmitting Parameter Settings via MIDI (Bulk Dump)	226
19 Other Functions	229
Changing the Input and Output Channel Names	229
Setting Preferences	230
Creating a Custom Layer by Combining Channels (User Assignable Layer) ...	233
Using the Oscillator	234
Using the User Defined Keys	235
Using Operation Lock	237
Cascading Consoles	238
Checking the Battery and the System Version	242
Initializing the 01V96	243
Calibrating the Faders	244
Appendix A: Parameter Lists	247
USER DEFINED KEYS	247
USER DEFINED KEYS Initial Assignments	249
Input Patch Parameters	249
Initial Input Patch Settings	251
Output Patch Parameters	253
Initial Output Patch Settings	255
User Defined Remote Layer Initial Bank Settings	256
Effects Parameters	260
Effects and tempo synchronization	270
Preset EQ Parameters	271
Preset Gate Parameters (fs = 44.1 kHz)	272
Preset Compressor Parameters (fs = 44.1 kHz)	273
Dynamics Parameters	275
Appendix B: Specifications	280
General Spec	280
Libraries	285
Analog Input Spec	286
Analog Output Specs	286
Digital Input Spec	287
Digital Output Spec	287
I/O SLOT Spec	287
CONTROL I/O Spec	288
Dimensions	288
Appendix C: MIDI	289
Scene Memory to Program Change Table	289
Initial Parameter to Control Change Table	290
MIDI Data Format	306
Appendix D: Options	318
Index	319
MIDI Implementation Chart	End of Manual
01V96 Block Diagram	End of Manual
01V96 Level Diagram	End of Manual

1 Welcome

Thank you for choosing the Yamaha 01V96 Digital Mixing Console.

The compact 01V96 Digital Console features 24-bit/96 kHz digital audio processing without compromise, as well as 40-channel simultaneous mixing. The 01V96 covers a broad range of needs and applications, including multi-track recording, 2-channel mixdown, and cutting-edge surround sound production. This integrated, comprehensive audio system features remote control function for DAWs (Digital Audio Workstations) as popularized by the DM2000 and 02R96 Digital Mixing Consoles.

The 01V96 offers the following features:

■ Hardware Features

- 100-mm motorized faders x 17
- Faders can set levels for Input Channels, Aux send levels, and Bus Outs.
- Four selectable software layers determine the function of channel faders.
- 320 x 240 dot LCD display
- Buttons and controls in the SELECTED CHANNEL section enable direct editing of channel EQ parameters.
- 8 USER-DEFINED KEYS enable you to assign functions to control 01V96 internal parameters.
- ADAT optical connectors
- Expansion slot for optional digital I/O, AD, and DA cards.

■ Sonic Specifications

- Linear 24-bit, 128-times oversampling A/D converters
- Linear 24-bit, 128-times oversampling D/A converters
- 20 Hz through 40 kHz frequency response at 96 kHz sampling rate.
- 106 dB typical dynamic range
- 32-bit internal signal processing (58-bit accumulator)

■ Inputs and Outputs

- 12 mic/line inputs with switchable +48 V phantom power and 4 line inputs
- 12 analog inserts
- Any Bus Outs or Channel Inserts can be routed to four Omni Outs.
- Individual outputs for Stereo Out and Monitor Out
- Analog 2TR In and Out for use with Tape In and Out signals
- An optional card installed in the slot permits a maximum of 16 inputs/outputs.
- Digital 2TR In and Out for consumer-format digital audio signals
- Double Channel support for recording and playing at 88.2/96 kHz on 44.1/48 kHz legacy multi-track digital recorders.
- You can cascade two 01V96s while remaining in the digital domain.
- Input patches enable assignment of input signals to desired signal paths.
- Output patches enable assignment of Bus Out signals and Input Channel Direct Outs to desired output jacks.

■ Channel Configuration

- 32 Input Channels and four ST IN channels can be mixed at a time. Group multiple channels and pair channels for stereo.
- Eight Bus Outs and eight Aux Sends. Bus Outs 1-8 can be routed to Stereo Buses for use as Group Buses.
- Channel library for storing and recalling the channel settings for each Input Channel and Output Channel
- Four-band EQ on each channel
- Dynamics processors on all channels (excluding ST IN channels)
- Dynamics processor settings and EQ settings can be stored in libraries and recalled.

■ Effects

- Four high-quality multi-channel effects (Apply effects via Aux Sends or Channel Inserts)
- Effect library for storing and recalling effect settings.
- Optional Add-On Effects packages for adding effects that utilize a variety of new algorithms.

■ Scene Memory

- Scene memories for storing and recalling mix settings as Scenes

■ Surround Sound

- Supports 3-1, 5.1, and 6.1 channel surround sound production
- Surround channel outputs can be assigned to suit connected devices.

■ Remote Control

- Control and manage your 01V96 from your Mac or PC using bundled Studio Manager software.
- Remote Layer for remote control of Pro Tools, Nuendo, Cubase SX, and other DAWs that support the Pro Tools protocol
- Control an external recorder via MMC commands.

■ MIDI

- Equipped with MIDI ports and a USB port for computer connection
- Scene recall and mix parameter changes via MIDI

2 Control Surface & Rear Panel

Control Surface

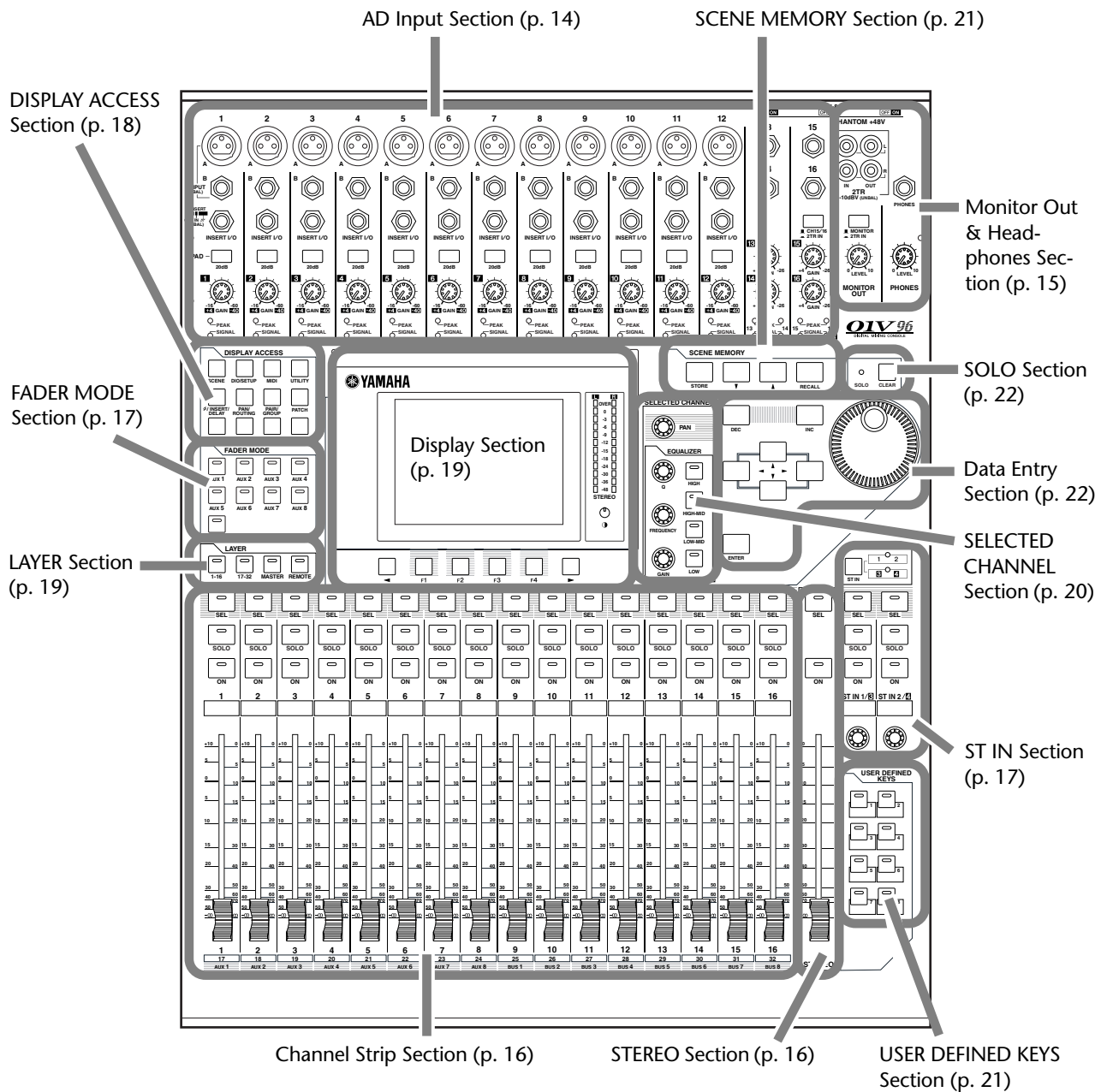

Note: Screw holes for attaching a cover are located at both sides of the AD input section of the 01V96. (Size M3, horizontal spacing 417 mm, vertical spacing 36 mm.) You may wish to fabricate your own cover and attach it to the front panel to prevent the controls from being operated inadvertently. Yamaha does not sell such a cover. If you fabricate and attach your own cover, make sure that the mounting screws do not extend more than 10 mm into the front panel. You will need to allow approximately 15–20 mm between the top panel and the cover in order to clear the control knobs and buttons.

AD Input Section

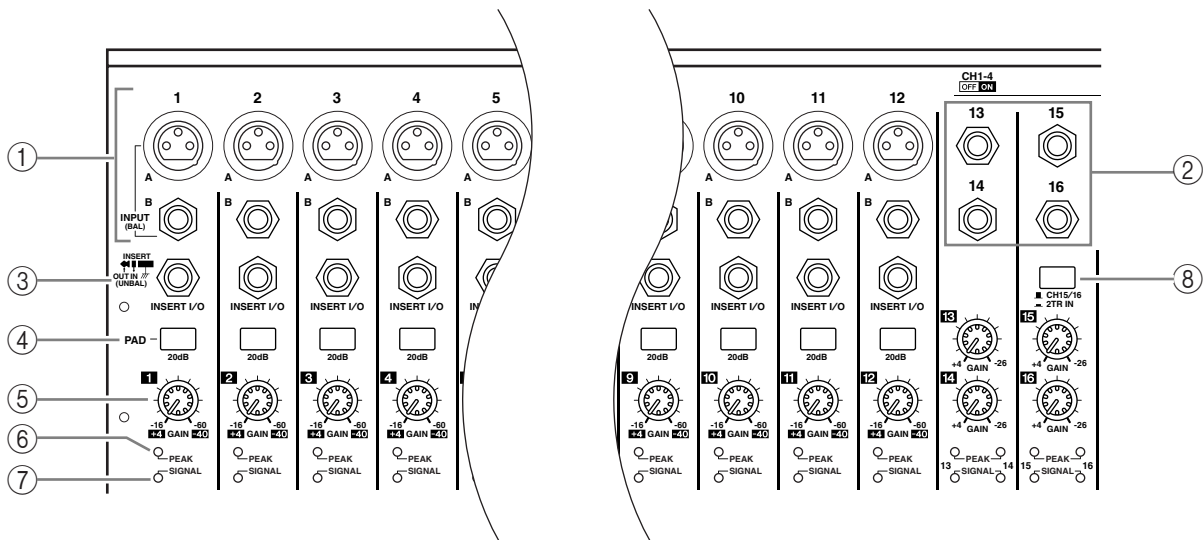

① INPUT connectors A/B

INPUT A connectors are balanced XLR-3-31-type connectors that accept line-level and microphone signals. Each of the phantom [+48V] switches on the rear panel turns on or off the +48V phantom power feed to the corresponding input. INPUT B connectors are balanced TRS phone-type connectors that accept line-level and microphone signals. The nominal signal level of both types of connectors ranges from -60 dB to +4 dB. Phantom power is not supplied to these connectors.

If you connect cables to INPUT A and INPUT B connectors of the same number, only the signal from INPUT B is effective.

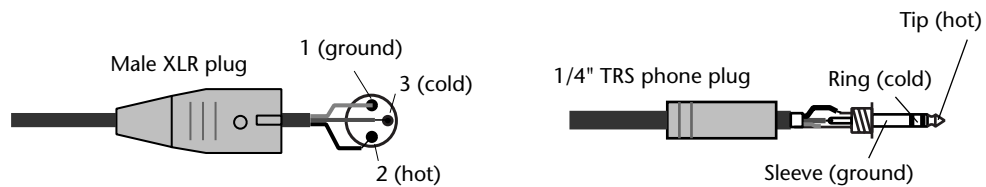

② INPUT connectors 13-16

These balanced TRS phone-type connectors accept line-level signals. The nominal signal level ranges from -26 dB to +4 dB. INPUT 15 & 16 connectors are available only when the AD 15/16 button is turned off (page 15).

③ INSERT I/O connectors

These unbalanced TRS phone-type connectors are used for channel insert ins and outs. Use a split cable to insert an external effects processor to AD input channels.

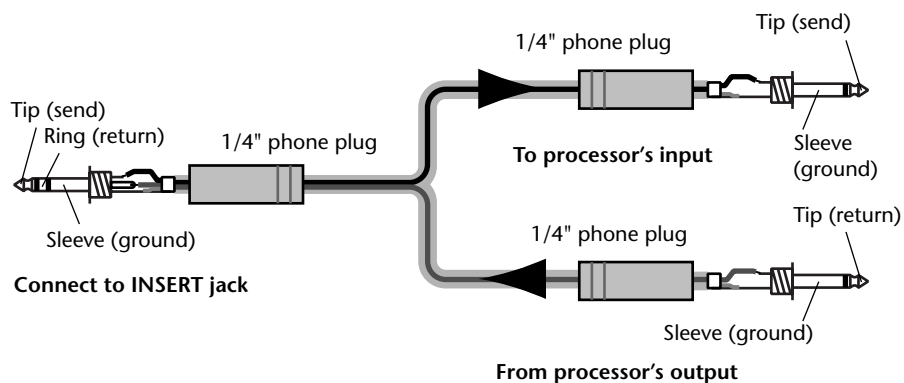

- ④ **PAD switches**
These switches turn on or off the 20 dB pad (attenuator) for each AD Input.
- ⑤ **GAIN controls**
These controls adjust input sensitivity for each AD Input. Input sensitivity is -16 dB to -60 dB when the Pad is off, and $+4$ dB to -40 dB when the Pad is on.
- ⑥ **PEAK indicators**
These indicators light up when the input signal level is 3 dB below clipping. Adjust the Pad switch and GAIN control so that the indicator rarely lights up at signal peak.
- ⑦ **SIGNAL indicators**
These indicators light up when the input signal level exceeds -34 dB.
- ⑧ **AD15/16 selector**
This button selects AD Input Channel 15 and 16 signals. When the button is turned on (pushed in), the 2TR IN signals (page 24) are selected. When the button is turned off (raised), the INPUT 15 and 16 signals are selected.

Monitor Out & Headphones Section

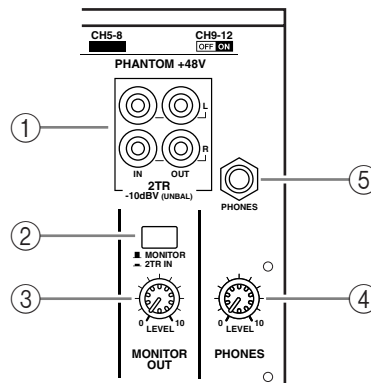

- ① **2TR IN/OUT connectors**
These unbalanced RCA phono connectors input and output line-level signals, and are typically used to connect a master recorder.
When the AD15/16 selector in the AD Input section (⑧) is turned on (pushed in), the signals input at the 2TR IN connectors are routed to AD Input Channels 15 and 16. When the Monitor Source selector (②) is turned on (pushed in), you can monitor the 2TR IN signals from the MONITOR OUT connectors.
The 2TR OUT signals are always the same as the STEREO OUT signals.
- ② **Monitor Source selector**
This button selects the signals output from the MONITOR OUT connectors on the rear panel. When this button is turned on (pushed in), you can monitor the signals input from the 2TR IN connectors. When the button is turned off (raised), you can monitor the Stereo Out signals or soloed channel signals.
- ③ **MONITOR LEVEL control**
This control adjusts the monitoring level of the signals output from the MONITOR OUT connectors.
- ④ **PHONES LEVEL control**
This control sets the level of the PHONES. (See page 131 for more information on monitoring through the headphones.)
- ⑤ **PHONES jack**
You can connect a set of stereo headphones to this stereo phone jack. The signals output from the MONITOR OUT connectors are also output from this jack.

Channel Strip Section

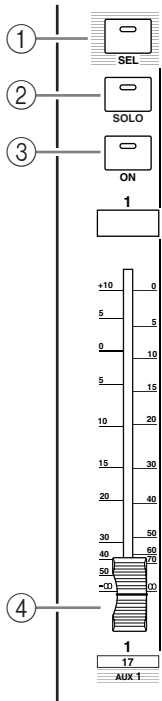

① [SEL] buttons

These buttons enable you to select desired channels. The [SEL] button indicator for the currently-selected channel lights up. The channel selected by each [SEL] button depends on the layer selected in the LAYER section (see page 19).

These buttons also allow you to create or cancel channel pairs, and add channels to (or remove them from) Fader, Mute, EQ, and Compressor groups.

② [SOLO] buttons

These buttons solo the selected channels. The [SOLO] button indicator of the currently-soloed channel lights up.

③ [ON] buttons

These buttons turn the selected channels on or off. The [ON] button indicators for On channels light up.

④ Channel faders

Depending on the button selected in the FADER MODE section (see page 17), these faders adjust the selected channel input levels or the Bus Out or Aux Out levels.

STEREO Section

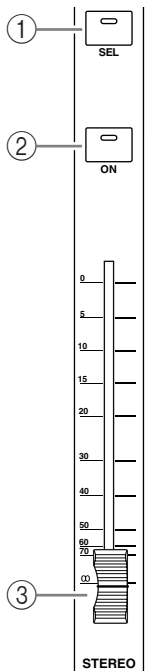

① [SEL] button

Selects the Stereo Out.

② [ON] button

Turns the Stereo Out on or off.

③ [STEREO] fader

This 100mm motorized fader adjusts the final output level of the Stereo Out.

ST IN Section

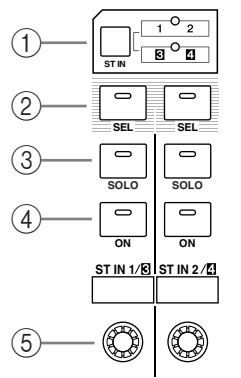

① [ST IN] button

This button selects an ST IN channel pair (ST IN Channels 1 & 2 or 3 & 4) which you can control using the buttons and controls in the ST IN section. The indicators to the right of the button indicate the available ST IN channels.

② [SEL] buttons

These buttons select the ST IN channel you want to control.

③ [SOLO] buttons

These buttons solo the selected ST IN channels.

④ [ON] buttons

These buttons turn the ST IN channels on or off.

⑤ Level controls

These controls adjust the ST IN channel levels.

FADER MODE Section

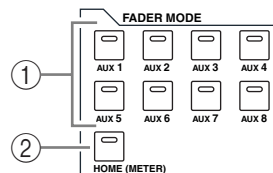

① [AUX 1]–[AUX 8] buttons

These buttons enable you to select the Aux Send you wish to control. Pressing one of these buttons switches the Fader mode (see page 33), and displays the corresponding Aux page. (The selected button's indicator lights up.)

You can now adjust the send level of signals routed from Input Channels to the corresponding Aux buses by using the faders.

② [HOME] button

This button recalls Meter pages that display Input Channel levels or Output Channel (Bus Out, Aux Out, Stereo Out) levels (see page 34).

DISPLAY ACCESS Section

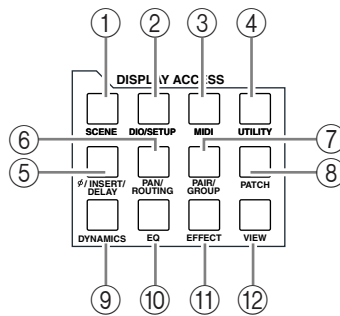

- ① **[SCENE] button**
This button displays a Scene page, enabling you to store and recall Scenes (see page 165).
- ② **[DIO/SETUP] button**
This button displays a DIO/Setup page, enabling you to set up the 01V96, including digital input and output setup and remote control setup (see pages 72, 192).
- ③ **[MIDI] button**
This button displays a MIDI page, enabling you to make MIDI settings (see page 219).
- ④ **[UTILITY] button**
This button displays a Utility page, enabling you to use the internal oscillators and view information about installed optional cards.
- ⑤ **[ϕ /INSERT/DELAY] button**
This button displays a ϕ /INS/DLY page, enabling you to switch the signal phase, set the signal to be inserted, or set the delay parameters (see pages 79, 127).
- ⑥ **[PAN/ROUTING] button**
This button displays a Pan/Route page, enabling you to select a Bus to which the selected channel signal is routed, adjust the selected channel pan settings, adjust the level of signals routed from Buses 1–8 to the Stereo Bus, and adjust the stereo or surround pan settings (see pages 85, 135).
- ⑦ **[PAIR/GROUP] button**
This button displays a Pair/Grup page, enabling you to create or cancel channel pairs and group multiple channel faders or [ON] buttons (see pages 93, 149).
- ⑧ **[PATCH] button**
This button displays a Patch page, enabling you to patch input signals and Bus Out signals to Input channels, or patch signals to the desired output connectors (see page 121).
- ⑨ **[DYNAMICS] button**
This button displays a Dynamics page, enabling you to control channel gates and compressors (see page 81).
- ⑩ **[EQ] button**
This button displays an EQ page, enabling you to set the equalizer and attenuator of the selected channel (see page 84).
- ⑪ **[EFFECT] button**
This button displays an Effect page, enabling you to edit the internal effects processors and use optional plug-in cards (see page 161).
- ⑫ **[VIEW] button**
This button displays a View page, enabling you to view and set mix parameters for a specific channel (see page 87).

LAYER Section

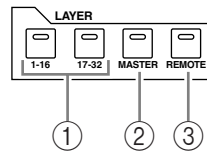

① [1-16]/[17-32] buttons

These buttons select an Input Channel layer as the layer controlled in the Channel Strip section. When the [1-16] button is turned on, you can control Channels 1-16. When the [17-32] button is turned on, you can control Channels 17-32. (See page 31 for more information on the Input Channel layers.)

② [MASTER] button

This button selects the Master Layer as the layer controlled in the Channel Strip section. You can use this layer to control Bus Outs and AUX Sends. (See page 31 for more information on the Master layer.)

③ [REMOTE] button

This button selects the Remote Layer as the layer controlled in the Channel Strip section. You can use this layer to control external MIDI devices or computer-based DAWs. (See page 189 for more information on the Remote layer.)

Tip: The ST IN section is not affected by the layer settings.

Display Section

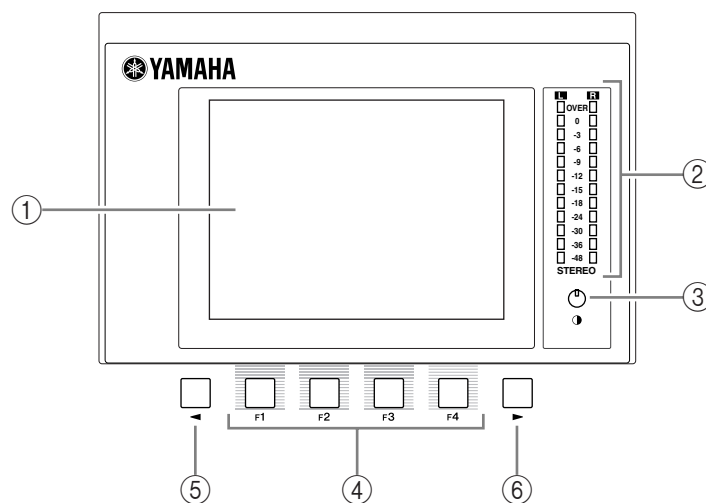

① Display

This is a 320 x 240 dot LCD display with a backlight.

② Stereo meters

These 12-segment level meters display the final output level of the Stereo Bus.

③ Contrast control

This control adjusts the display contrast.

④ [F1]–[F4] buttons

These buttons select a page from a multi-page screen. Selecting a tab at the bottom of the screen using one of these buttons displays the corresponding page. (See page 28 for more information on displaying a page.)

- ⑤ **Left Tab Scroll [◀] button**
- ⑥ **Right Tab Scroll [▶] button**

If there are more pages available than the four whose tabs are currently displayed, use these buttons to display the additional tabs. These buttons are available only when the left or right Tab Scroll arrow appears.

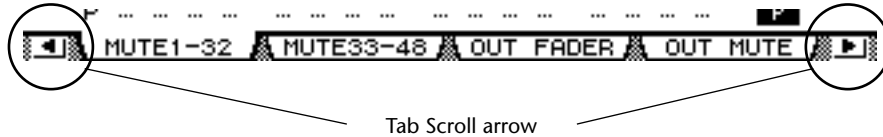

SELECTED CHANNEL Section

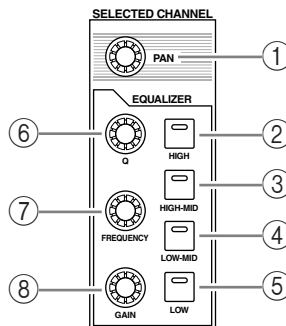

- ① **[PAN] control**
This control adjusts the pan of the channel selected by the [SEL] button.
- ② **[HIGH] button**
- ③ **[HIGH-MID] button**
- ④ **[LOW-MID] button**
- ⑤ **[LOW] button**
These buttons select the EQ band (HIGH, HIGH-MID, LOW-MID, LOW) of the channel selected by the [SEL] button. The corresponding button indicator of the currently-selected band lights up.
- ⑥ **[Q] control**
This control adjusts the currently-selected band Q.
- ⑦ **[FREQUENCY] control**
This control adjusts the currently-selected band frequency.
- ⑧ **[GAIN] control**
This control adjusts the currently-selected band gain.

SCENE MEMORY Section

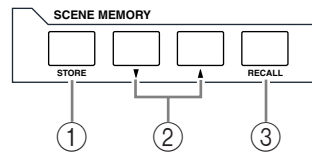

① [STORE] button

This button enables you to store the current mix settings. (See page 165 for more information on Scene Memories.)

② Scene Up [▲] / Down [▼] buttons

These buttons select a Scene to store or recall. Pressing the Scene Up [▲] button increments the selection; pressing the Scene Down [▼] button decrements the selection. Holding down either key increments or decrements the selection continuously.

③ [RECALL] button

This button recalls the Scene memory selected by the Scene Up [▲] / Down [▼] buttons.

USER DEFINED KEYS Section

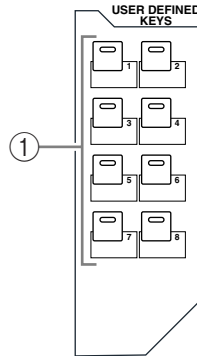

① [1]–[8] buttons

You can assign any of the 167 functions to these User Defined buttons.

Data Entry Section

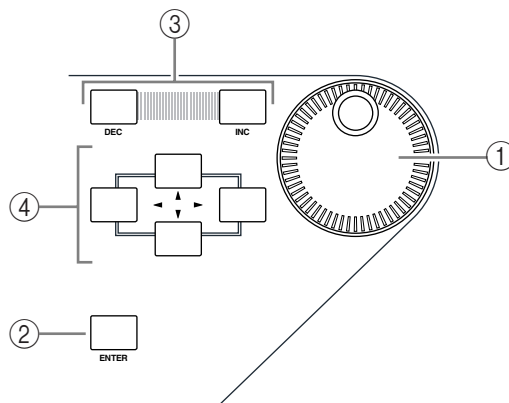

- ① **Parameter wheel**
This control adjusts the parameter values shown on the display. Turning it clockwise increases the value; turning it counterclockwise decreases the value. This wheel also enables you to scroll a displayed list and select a character for entry (see page 30).
- ② **[ENTER] button**
This button activates a selected (highlighted) button on the display, and confirms the edited parameter values.
- ③ **[DEC] & [INC] buttons**
These buttons increment or decrement a parameter value by one. Pressing the [INC] button increments the value; pressing the [DEC] button decrements the value. Holding down either key increments or decrements the value continuously.
- ④ **Left, Right, Up, Down ([◀]/[▶]/[▲]/[▼]) cursor buttons**
These buttons move the cursor around the display pages, or select parameters and options. Holding down a cursor button moves the cursor continuously in the corresponding direction.

SOLO Section



- ① **[SOLO] indicator**
This indicator flashes when single or multiple channels are soloed.
- ② **[CLEAR] button**
This button “unsolos” all soloed Channels.

Rear Panel

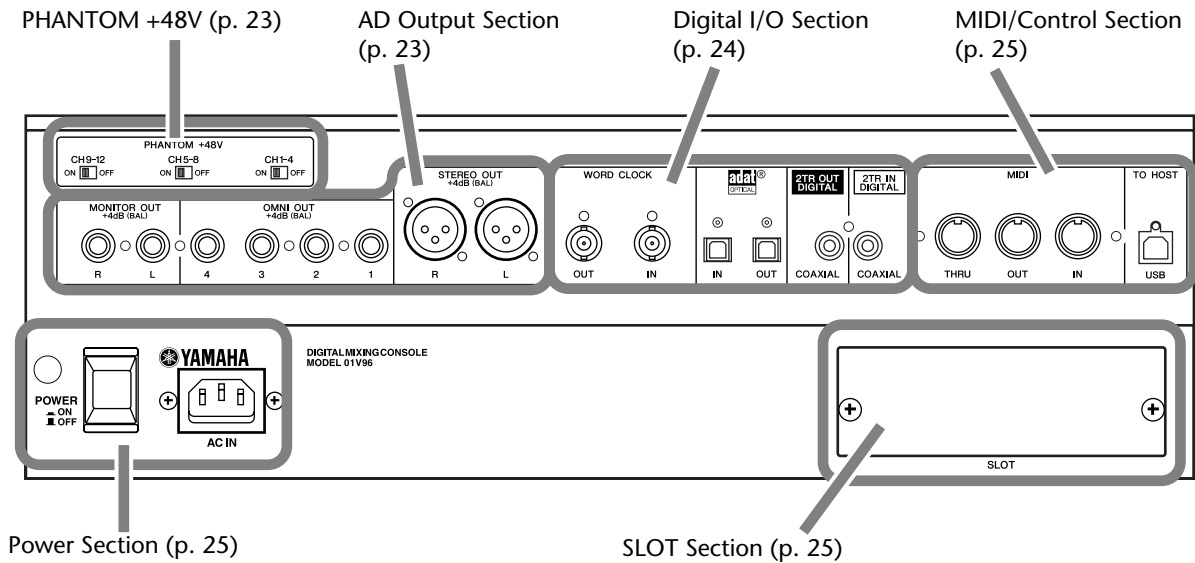

PHANTOM +48V

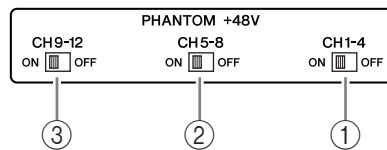

- ① CH1-4 ON/OFF switch
- ② CH5-8 ON/OFF switch
- ③ CH9-12 ON/OFF switch

Each of these switches turns on or off the +48V phantom power feed to four corresponding inputs. When the switches are on, +48V phantom power is supplied to the INPUT A connectors.

AD Output Section

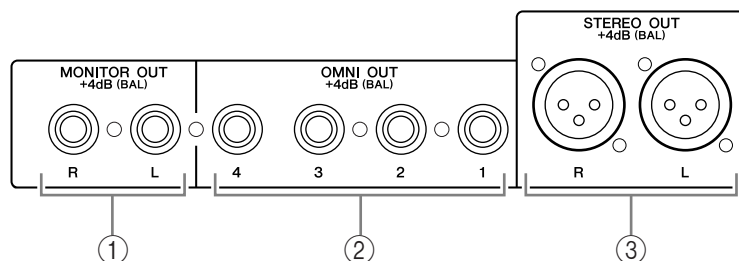

- ① **MONITOR OUT** connectors L/R

These balanced TRS phone-type connectors output monitoring signals or 2TR IN signals. The nominal signal level is +4 dB.

You can select signals using the Monitor Source selector.

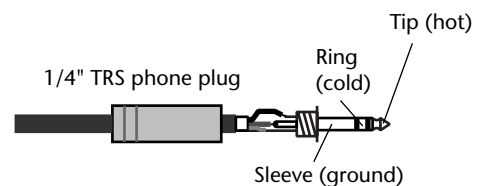

② **OMNI OUT connectors 1–4**

These balanced TRS phone-type connectors output any Bus signals or channel Direct Out signals. The nominal signal level is +4 dB.

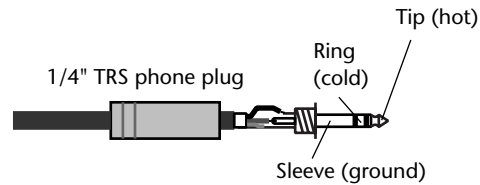

③ **STEREO OUT connectors L/R**

These balanced XLR-3-32-type connectors output the Stereo Out signals. The nominal signal level is +4 dB.

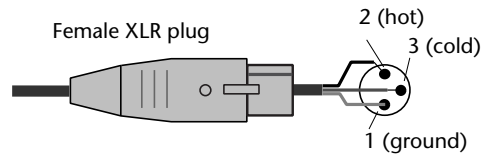

Digital I/O Section

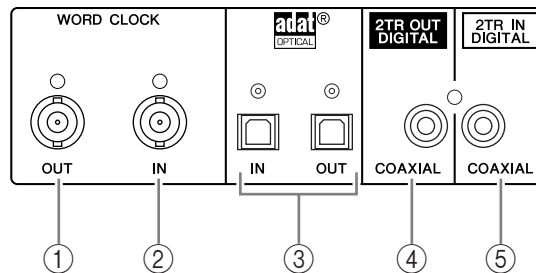

① **WORD CLOCK OUT connector**

This BNC connector outputs a wordclock signal from the 01V96 to a connected external device.

② **WORD CLOCK IN connector**

This BNC connector inputs a wordclock signal from a connected external device to the 01V96.

③ **ADAT IN/OUT connectors**

These optical TOSLINK connectors input and output ADAT digital audio signals.

④ **2TR OUT DIGITAL COAXIAL**

This RCA phono connector outputs consumer format (IEC-60958) digital audio. The connector is typically used to connect the digital stereo input (consumer format) of a DAT recorder, MD recorder, or CD recorder.

⑤ **2TR IN DIGITAL COAXIAL**

This RCA phono connector accepts consumer format (IEC-60958) digital audio. The connector is typically used to connect the digital stereo output (consumer format) of a DAT recorder, MD recorder, or CD recorder.

MIDI/Control Section

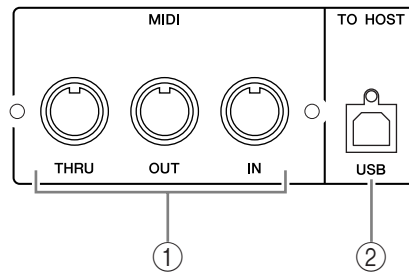

① MIDI IN/THRU/OUT ports

These standard MIDI IN, OUT and THRU ports enable you to connect the 01V96 to other MIDI equipment.

② TO HOST USB port

This USB port enables you to connect a computer equipped with a USB port.

SLOT Section

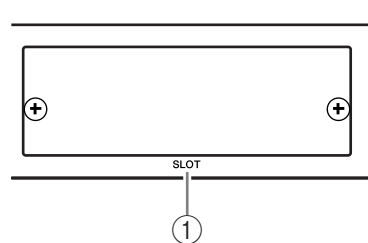

① SLOT

You can insert optional mini-YGDAI cards into this slot. (See page 26 for information on installing these cards.)

Power Section

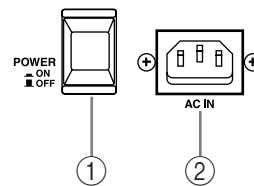

① POWER ON/OFF switch

This switch turns the power to the 01V96 on or off.

Note: To prevent loud clicks and thumps in your speakers, turn on your audio equipment in the following order (reverse this order when turning the equipment off)—sound sources, multitrack and master recorders, 01V96, monitoring power amplifiers.

② AC IN connector

This connector enables you to connect the 01V96 to an AC outlet via the supplied power cord.

Installing an Optional Card

Visit the following Yamaha Pro Audio web site to ensure that the card you are installing is supported by the 01V96.

<<http://www.yamahaproaudio.com/>>.

Follow the steps below to install an optional mini-YGDAI card.

- 1 Make sure that the power to the 01V96 is turned off.**
- 2 Undo the two fixing screws and remove the slot cover, as shown below.**
Keep the cover and fixing screws in a safe place for future use.

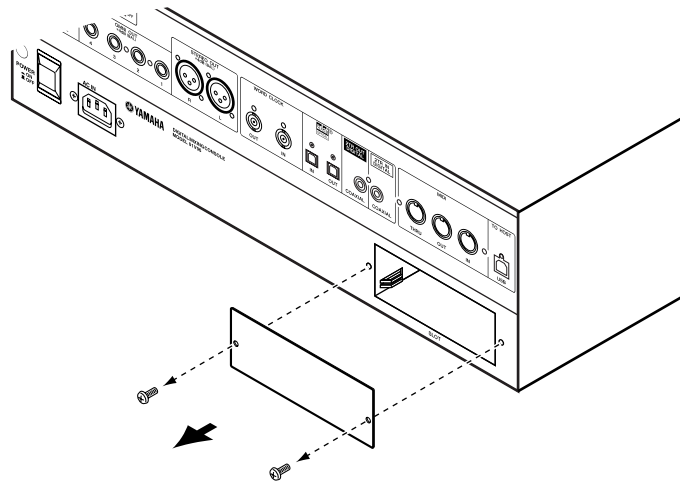

- 3 Insert the card between the guide rails and slide it all the way into the slot, as shown below.**

You may have to push firmly to fully insert the card into the internal connector.

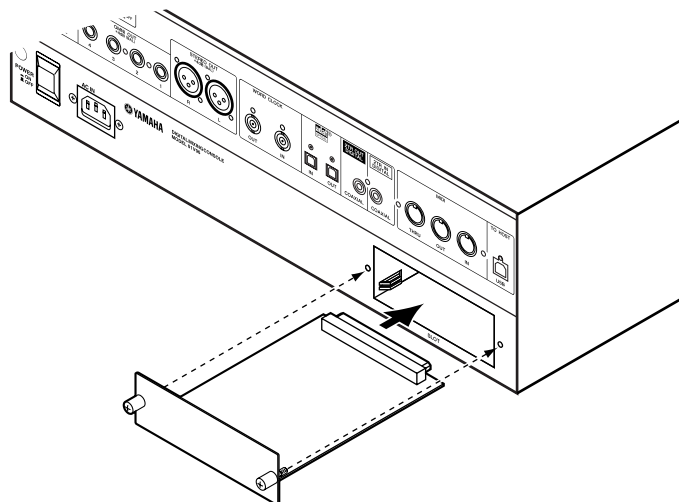

- 4 Secure the card using the attached thumbscrews.**

Tighten the screws firmly to secure the card. Otherwise, the card may not be grounded correctly.

3 Operating Basics

This chapter describes basic operations on the 01V96, including how to use the display and operate the controls on the top panel.

About the Display

The top panel display indicates various parameters that you must set before you can operate the 01V96. The display indicates the following items:

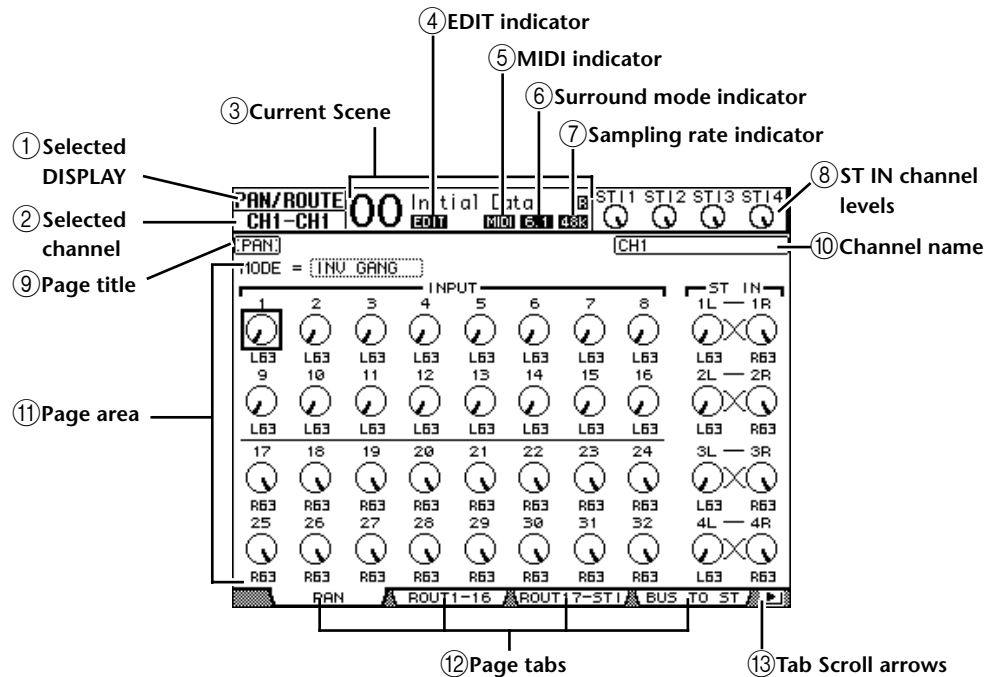

- ① **Selected DISPLAY**
This section indicates the currently-selected display page group.
- ② **Selected channel**
This section indicates the Input or Output Channel currently selected by its corresponding [SEL] button. The first four characters are the Channel ID (e.g., CH1–CH32, BUS1–BUS8, AUX1–AUX8, ST-L, ST-R). The second four characters are the channel’s Short name. You can edit the channel’s Short name if you desire (see page 229).
- ③ **Current Scene**
This section indicates the number and title of the currently-selected Scene memory (see page 166). If the selected Scene is write-protected, a padlock icon (🔒) appears.
- ④ **EDIT indicator**
This indicator appears when the current mix settings no longer match those of the Scene that was most-currently recalled.
- ⑤ **MIDI indicator**
This indicator appears when the 01V96 is receiving MIDI data via the MIDI IN port, USB port, or an installed MY8-mLAN card.
- ⑥ **Surround mode indicator**
This indicator identifies the currently-selected Surround mode (ST=stereo, 3-1, 5.1, or 6.1) (see page 135).

⑦ Sampling rate indicator

This indicator identifies the 01V96's current sampling rate: 44.1 kHz (44k), 48 kHz (48k), 88.2 kHz (88k), or 96 kHz (96k).

⑧ ST IN channel levels

These level controls indicate the level of ST IN channels 1–4.

⑨ Page title

This section indicates the title of the current page.

⑩ Channel name

On certain pages, this area displays the Long name of the currently-selected channel.

⑪ Page area

This page area displays various page contents.

⑫ Page tabs

These tabs enable you to select a display page.

⑬ Tab Scroll arrows

These arrows indicate that more pages are available.

Selecting Display Pages

To select a display page:

1 Press the corresponding button on the top panel to select the desired page group.

Display pages are grouped by function. To select a page group, press the desired button in the DISPLAY ACCESS section.

2 You can select pages that have currently-displayed tabs by pressing the [F1]–[F4] buttons.

If the selected display page group contains multiple pages, press the [F1]–[F4] buttons below the corresponding tab to select a specific page.

3 To select a page for which a tab is not currently displayed, press either the Left or Right [◀]/[▶] Tab Scroll button (depending on where the page is located) to display the page tab, then press the corresponding [F1]–[F4] button.

If display page groups contain more than four pages, either the left or right arrow appears. To display the currently-hidden tabs, press the Right or Left [◀]/[▶] Tab Scroll button.

You can also select a page from a page group as follows:

• Selecting the next page in a page group:

Press the button you selected in Step 1 repeatedly. This enables you to select a page that has a hidden tab.

• To select the previous page in a page group:

Press and hold down the button you selected in Step 1. The screen steps back through the pages one by one. Release the button when the desired page is displayed. This enables you to select a page that has a hidden tab.

• To select the first page in the group:

Double-click the button you selected in Step 1.

- 4 Press the cursor buttons to move the cursor (a bold frame) to a button, parameter box, rotary control, or fader so that you can change the value.

Tip: The 01V96 remembers the current page and parameter when you select a new page group. If you return to the previous page group, the 01V96 displays the correct page, with the same parameter selected. You can also select a page by using the controls or buttons on the top panel (see page 230).

Display Interface

This section describes how to use the display interface.

Rotary Controls & Faders

The rotary controls and faders enable you to adjust the continuously variable parameter values, including Input Channel levels and effects parameters. Press the cursor buttons to move the cursor to a rotary control or fader you want to adjust, then rotate the Parameter wheel or press the [INC]/[DEC] buttons to modify the value.

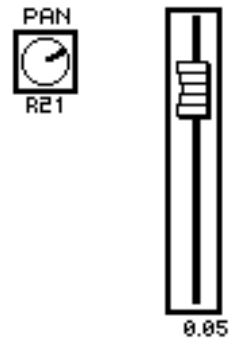

Buttons

The buttons enable you to turn certain functions on (enabled) or off (disabled). Move the cursor to the appropriate button, then press the [ENTER] button to turn the function on (highlighted) or off. The buttons also enable you to select one of two options or to execute certain functions.



Parameter Boxes

The parameter boxes enable you to select one of multiple options. Press the cursor buttons to move the cursor to a parameter box, then rotate the Parameter wheel or press the [INC]/[DEC] buttons to select the setting.

You may need to press the [ENTER] button to confirm a change in certain parameter boxes. If you edit a value in this type of parameter box, the value flashes. Press the [ENTER] button to confirm the change, and the flashing stops. If you move the cursor to other parameters while the edited value is flashing, the edit is cancelled.

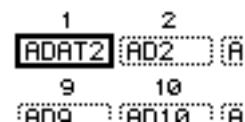

Confirmation Messages

For certain functions, the 01V96 prompts you for confirmation before executing the functions, as shown here.

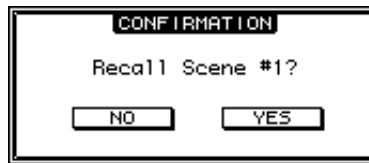

Move the cursor to YES and press [ENTER] to execute the function, or move the cursor to NO and press [ENTER] to cancel.

If you take no action for awhile, the confirmation window closes automatically and the function is not executed.

Title Edit Window

The Title Edit window enables you to enter titles for Scene and library memories. You can enter 4, 12, or 16 characters, depending on the item.

The figure on the left shows uppercase characters and various punctuation marks. The figure on the right shows lowercase characters and numbers.

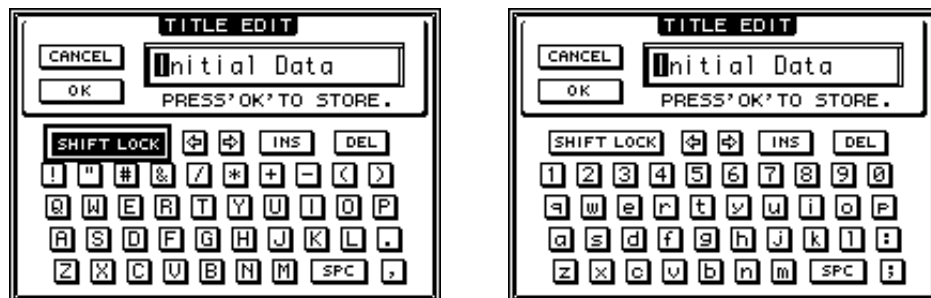

Use the cursor buttons to select characters, and press the [ENTER] button to enter them into the title. The cursor moves to the right automatically as each character is entered. Use the Parameter wheel to move the cursor within the title.

Use the SHIFT LOCK button to select uppercase or lowercase characters, and use the SPC button to enter a space.

To insert a space at the cursor position and move subsequent characters to the right, move the cursor to the INS button and press [ENTER].

To delete the character at the cursor position and move subsequent characters to the left, move the cursor to the DEL button and press [ENTER].

When you have finished, move the cursor to the OK button, then press [ENTER] to confirm the title. To cancel the title entry, move the cursor to the CANCEL button, then press [ENTER].

Selecting Layers

Input Channels and Output Channels (Bus Outs & Aux Outs) are arranged into layers, as illustrated below. There are four layers altogether.

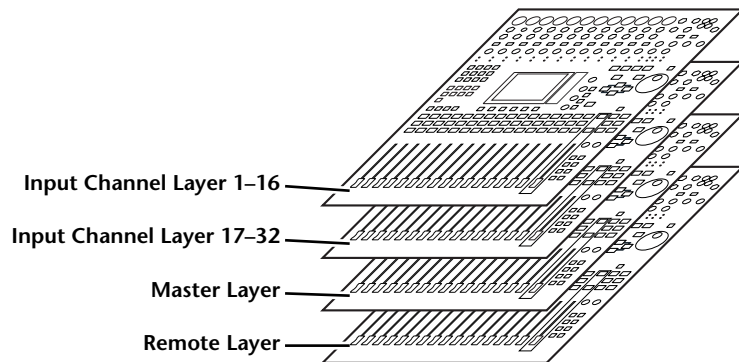

The currently-selected layer determines the function of the channel strip, [SEL] buttons, [SOLO] buttons, [ON] buttons, and faders. Use the LAYER buttons to select a layer you wish to edit using the channel strip controls.

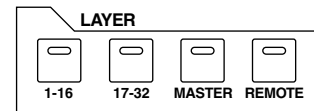

The following table shows the layers that you can access using the LAYER buttons, and the parameters you can control using the channel strips on each layer.

LAYER buttons	Layers	Channel Strips	
		1-8	9-16
[1-16] button	Input Channel Layer 1-16	Input Channels 1-16	
[17-32] button	Input Channel Layer 17-32	Input Channels 17-32	
[REMOTE] button	Remote Layer	Operation depends on the selected target (see page 189).	
[MASTER] button	Master Layer	Aux Send masters 1-8	Bus Out masters 1-8

Tip:

- The function of each channel strip fader depends on the currently-selected Fader mode (see page 33).
- The STEREO [SEL] button, [ON] button, and [STEREO] fader always control the Stereo Out signal, regardless of the Layer settings.
- The ST IN [SEL] buttons, [SOLO] buttons, [ON] buttons, and level control knobs always adjust the ST IN channels selected via the [ST IN] button regardless of the Layer settings.

Selecting Channels

To select a channel on the 01V96, press the corresponding [SEL] button. To adjust the Pan and EQ settings, use the rotary controls in the SELECTED CHANNEL section. To select a channel on pages that cover multiple channels, press the corresponding [SEL] button.

- 1 Press the corresponding LAYER button to select a layer that includes the desired channel (see page 31).**

To select ST IN channels, press the ST IN [ST IN] button.

- 2 Use the corresponding [SEL] button to select the desired channel.**

The channel is selected and the [SEL] button indicator lights up. The Channel's ID and Short name appear in the upper-left corner of the display. If the currently-displayed page contains a relevant channel parameter, the cursor moves to that parameter automatically. If the currently-displayed page contains no such parameter, a page that does contain such a parameter is selected automatically.

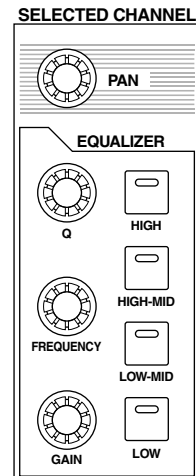

Tip: For paired Input or Output Channels, the channel for which you pressed the [SEL] button is selected, and its indicator lights up. The [SEL] button indicator of the paired partner flashes.

- 3 To select the Stereo Out, press the STEREO [SEL] button.**

Repeatedly pressing the STEREO [SEL] button toggles between the Stereo Out left and Stereo Out right channels.

If the currently-displayed page contains a relevant Stereo Out parameter, the cursor moves to that parameter automatically. If the currently-displayed page contains no such parameter, a page that does contain such a parameter is selected automatically.

Selecting Fader Modes

The function of channel faders (1–16) depends on the selected Layer and Fader mode.

1 Select a layer that includes the desired channel (see page 31).

2 Press the FADER MODE buttons to select a Fader mode.

The button indicators identify the following Fader modes:

- **When the [HOME] button indicator lights up:**
You can use channel faders to control Input Channels and ST IN Channel levels or Output Channels (Aux Out 1–8, Bus Out 1–8) master levels.
- **When one of the [AUX1]–[AUX8] button indicators light up:**
You can use channel faders to control the corresponding Aux Send level.

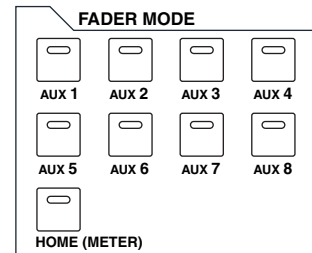

The following table shows the channel fader functions for each Layer and Fader mode.

LAYER buttons	Fader Mode	Channel Strip Fader	
		1–8	9–16
[1–16] button	[HOME] button	Input Channel 1–16 level	
	[AUX1]–[AUX8] buttons	Input Channel 1–16 Aux Send level	
[17–32] button	[HOME] button	Input Channel 17–32 level	
	[AUX1]–[AUX8] buttons	Input Channel 17–32 Aux Send level	
[REMOTE] button	[HOME] button	Operation depends on the selected target (see page 189).	
	[AUX1]–[AUX8] buttons		
[MASTER] button	[HOME] button	Aux Send master 1–8 output level	Bus Out master 1–8 output level
	[AUX1]–[AUX8] buttons	No operation	

Note: You cannot select the [AUX1]–[AUX8] buttons while the Master layer is selected. If you switch to the Master layer while one of the [AUX1]–[AUX8] button indicators is lit, the indicator automatically turns off and the [HOME] button indicator lights up.

Metering

This section describes how to check Input and Output Channel levels using the Meter pages.

- 1 Press the FADER MODE [HOME] button repeatedly until the Meter | Position page appears.

This page enables you to set the metering position for Input and Output Channels.

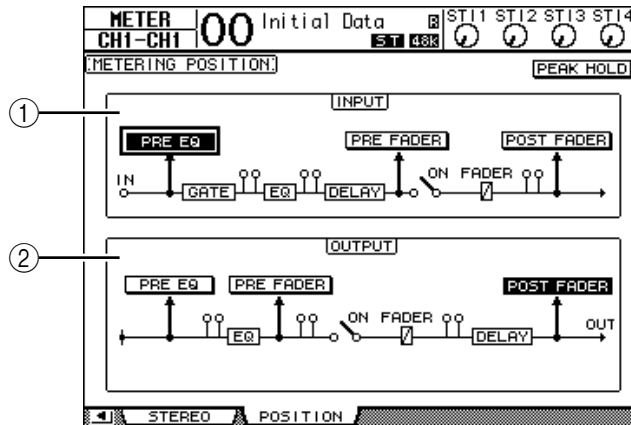

① **INPUT section**

This section enables you to select the metering position for Input Channel and ST IN Channel signals.

② **OUTPUT section**

This section enables you to select the metering position for Output Channel (Aux Out 1–8, Bus Out 1–8, Stereo Out) signals.

- 2 Move the cursor to the desired parameter button in the INPUT or OUTPUT section, then press [ENTER].

You can select one of the following three positions in each section.

- PRE EQ..... Immediately before EQ.
- PRE FADER..... Immediately before the fader.
- POST FADER Immediately after the fader.

- 3 Press the FADER MODE [HOME] button repeatedly until the page listed below that contains the desired channels appears.

- CH1-32 page

This page displays the Input Channel 1–32 levels respectively.

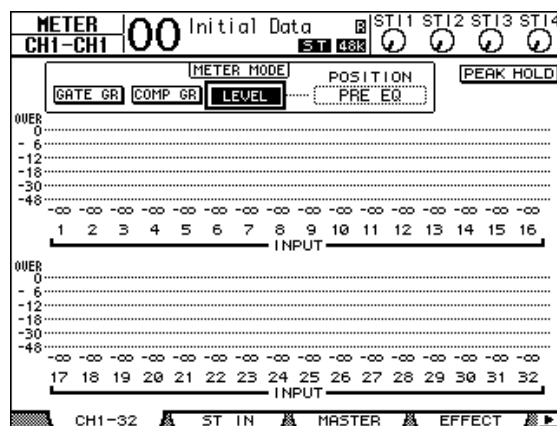

- **ST IN page**
This page displays the left and right ST IN Channel 1–4 levels separately.

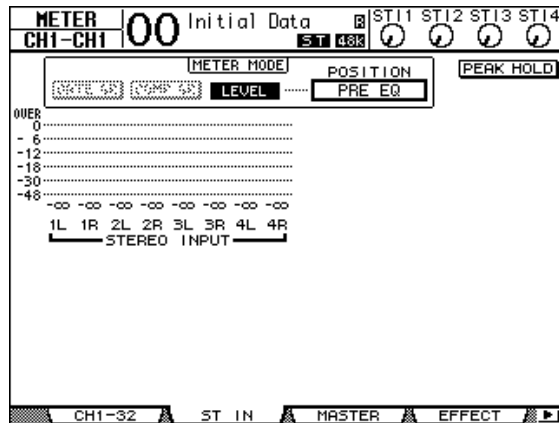

- **Master page**
This section displays the Output Channel (Aux Out 1–8, Bus Out 1–8, Stereo Out) levels altogether.

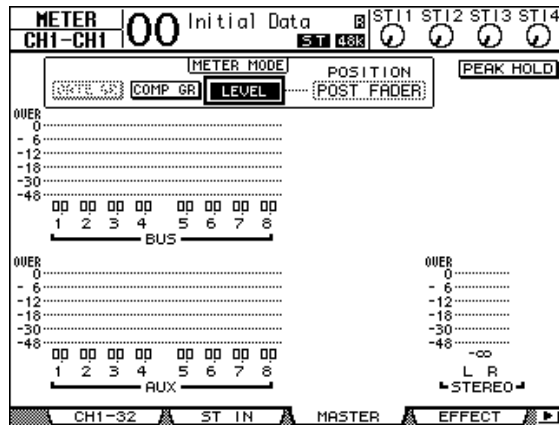

- **Effect page**
This page displays the internal effects processor 1–4 input and output levels altogether.

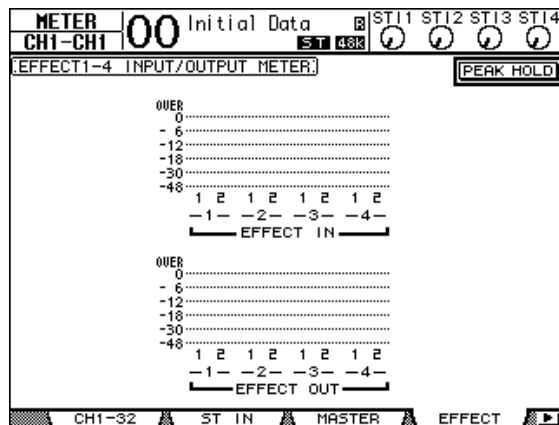

- **Stereo page**
This page displays the Stereo Out output level.

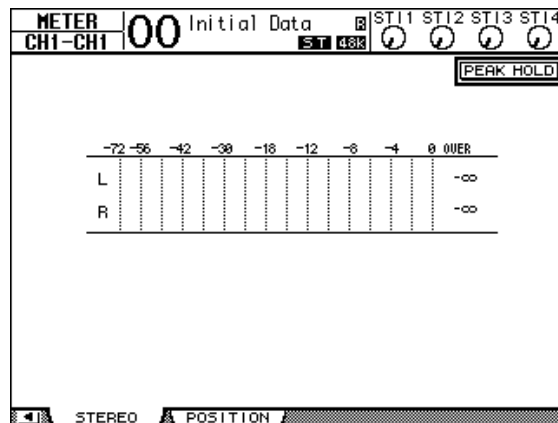

If you selected the CH1-32 page or the Master page, use the MASTER MODE parameter to select one of the following three metering signal types:

- **GATE GR**..... The amount of gain reduction for the gate (only for CH1-32)
- **COMP GR**..... The amount of gain reduction for the compressor
- **LEVEL** Input Channel input level, or Output Channel output level

Tip: These pages also allow you to change the metering position using the POSITION parameter. This parameter setting operates in unison with the Meter | Position page setting.

4 To activate the Peak Hold function, move the cursor to the PEAK HOLD button, then press [ENTER].

The PEAK HOLD button turns on, and the peak level is held on the meters on the page. To cancel the Peak Hold function, turn the PEAK HOLD button off.

4 Connections and Setup

This chapter explains how to connect and set up your 01V96.

Connections

The following section explains three typical ways to connect the 01V96 to external equipment, although there are numerous others.

■ Configuring an analog 24-channel mixing system

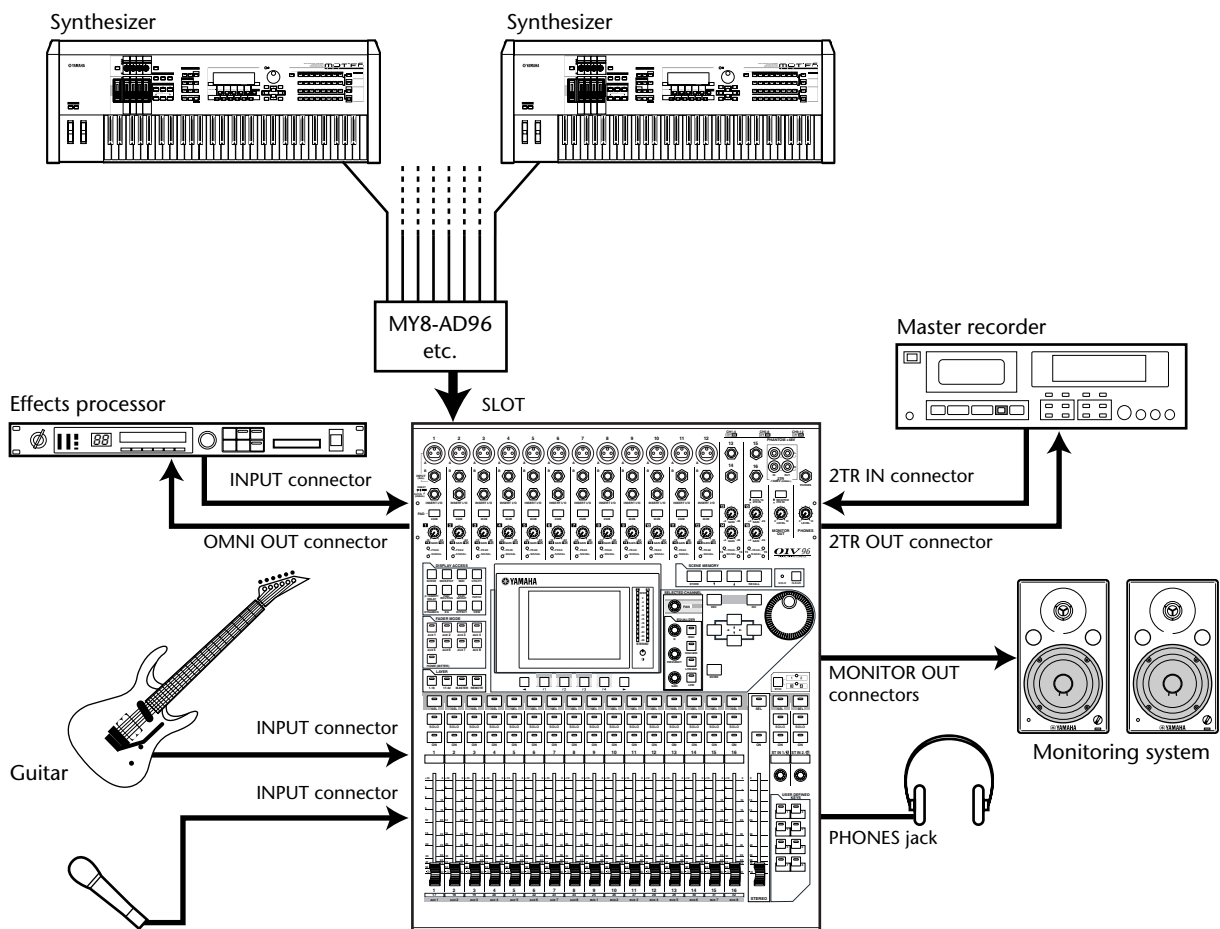

In this system, the 01V96, with an optional AD card (MY8-AD, MY8-AD96, etc.) installed in the slot, is used as a keyboard mixer or sound re-enforcement mixer. Up to 24 analog channels, including Inputs 1–16 and slot channels, are available for mixing.

Tip: You can adjust the gain of the AD card channels by setting the DIP switches on the card. For more information, see your AD card documentation.

■ Configuring a recording system with a hard disk recorder

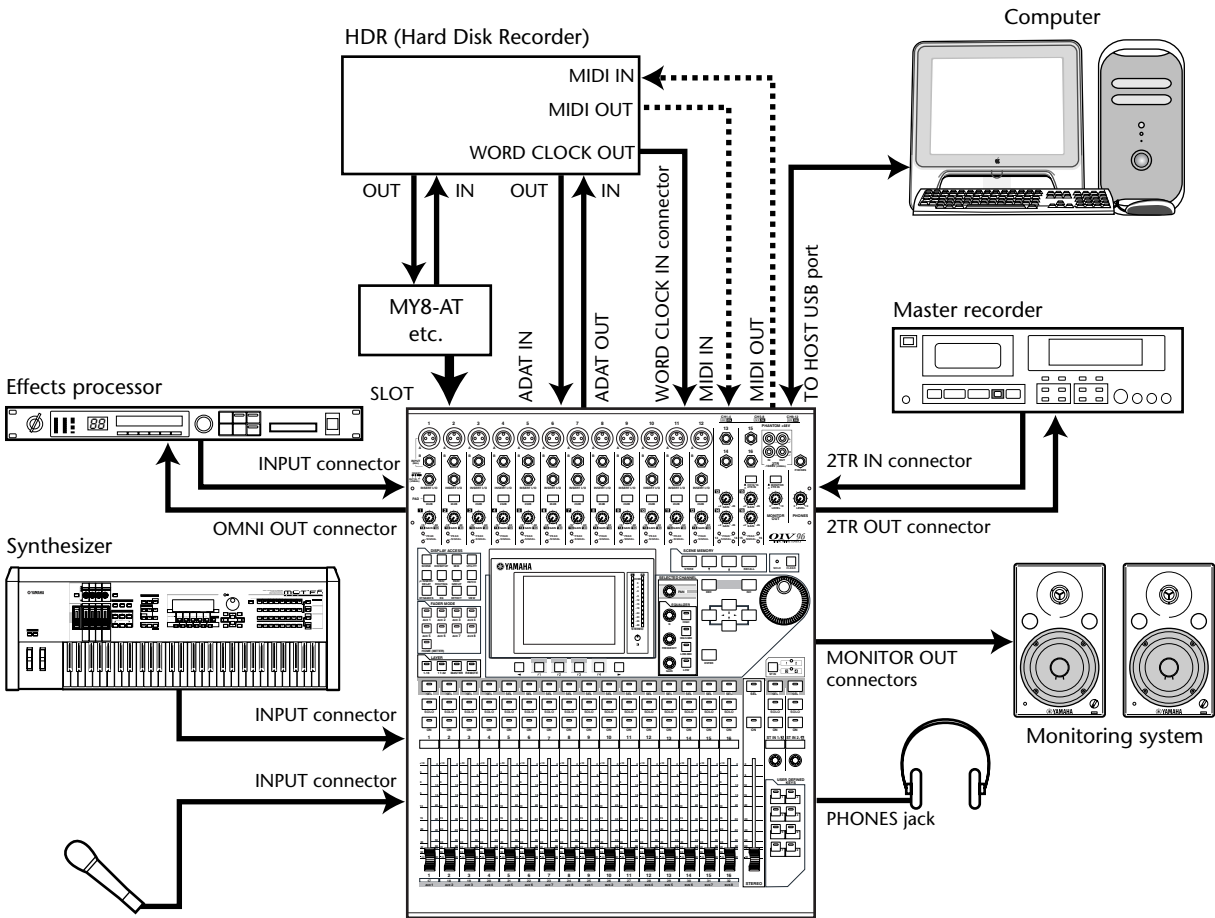

In this system, the 01V96 is one component in a system that includes a digital MTR, such as a hard disk recorder, that is connected to the 01V96 via the ADAT IN and OUT connectors on the rear panel and via an optional I/O card (MY8-AT, MY16-AT, MY8-TD, etc.) installed in the slot. This system will support track recording, overdubbing, track bouncing, and mixdown. You can also control the hard disk recorder's transport section by sending MMC commands from the 01V96 to the recorder.

■ Configuring a recording system that uses a DAW (Digital Audio Workstation)

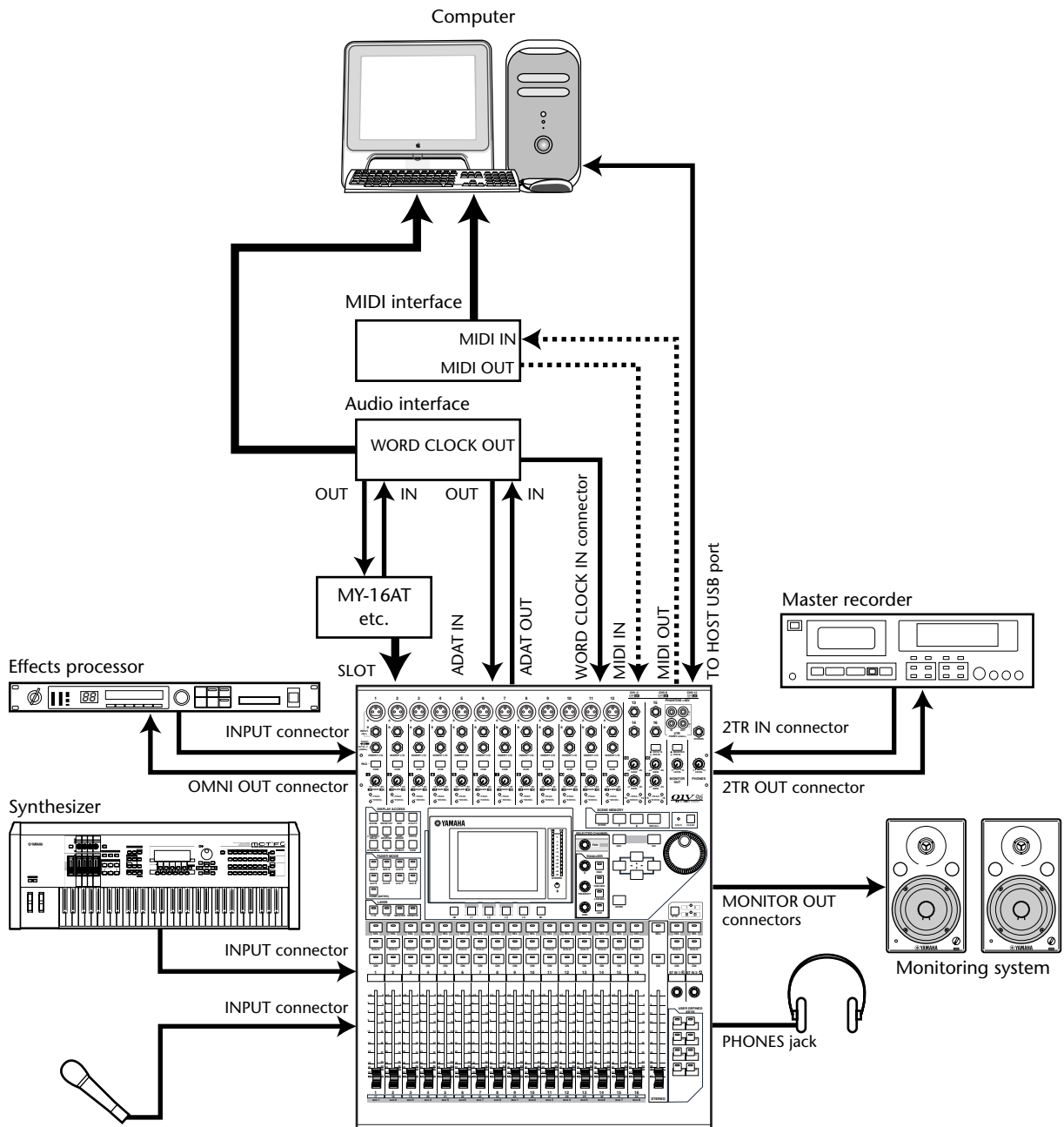

In this system, the 01V96, with an optional I/O card (MY8-AT, MY16-AT, MY8-AE, etc.) installed in the slot, is connected to a computer-based DAW (Digital Audio Workstation). The 01V96 can provide audio input and output for the DAW. If you connect the 01V96 and the computer via USB, the 01V96's Remote function enables you to control the DAW's locate and transport functions and change the parameters.

Wordclock Connections and Settings

About Wordclock

Digital audio equipment must be synchronized when digital audio signals are transferred from one device to another. Even if both devices use identical sampling rates, digital signals may not transfer correctly, or audible noise or unwanted clicks may occur if the digital audio processing circuits inside each digital audio device are not synchronized with each other.

Wordclocks are signals that enable digital audio processing circuits to synchronize with each other. In a typical digital audio system, one device operates as the wordclock master, transmitting wordclock signals, and the other devices operate as wordclock slaves, synchronizing to the wordclock master.

If you are digitally connecting the 01V96 to other equipment, you must decide which device to use as the wordclock master and which devices to use as slaves, then set up all the devices accordingly. The 01V96 can be used as the wordclock master running at either 44.1 kHz, 48 kHz, 88.2 kHz, or 96 kHz, or slaved to an external wordclock source.

Wordclock Connections

To establish wordclock synchronization between the 01V96 and external devices, you can distribute wordclock signals independently via dedicated cables, or you can use clock information derived from digital audio connections.

The WORD CLOCK IN and OUT connectors transmit and receive wordclock signals independently on the 01V96. The following examples show two ways in which wordclock signals can be distributed and received via the WORD CLOCK IN and OUT connectors.

- **Daisy Chain Distribution**

In this example, the wordclock signal is distributed in a “daisy-chain” fashion, with each device feeding the wordclock signal from the wordclock out connector on to the wordclock in connector of the next device. This method of distribution is not recommended for larger systems.

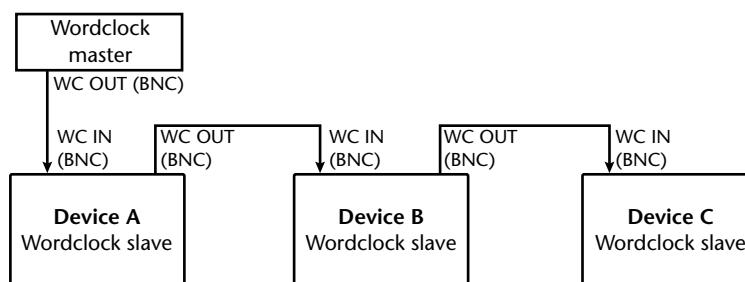

- **Star Distribution**

In this example, a dedicated wordclock distribution box is used to supply wordclock signals from the wordclock master to each wordclock slave individually.

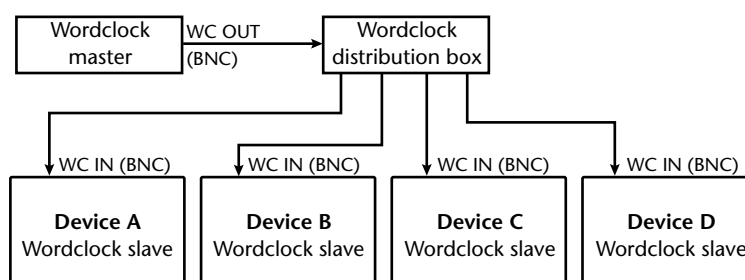

If the external devices do not have wordclock in and out connectors, you can use the clock information included in the digital audio signals. In this case, digital audio signals and wordclock signals are transferred via the 2TR OUT DIGITAL and 2TR IN DIGITAL jacks or via the digital I/O card installed in the rear panel slot.

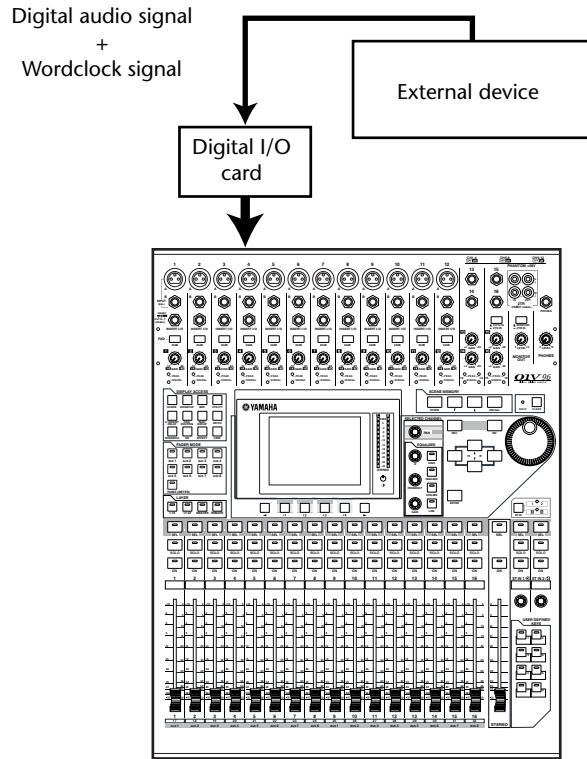

Specifying the Wordclock Source

To digitally connect the 01V96 to external devices, you must specify the wordclock source for the system. Follow the steps below.

Note: When you change the wordclock settings on any device in your digital audio system, some devices may output noise due to being out of synchronization. Be sure to turn down your monitoring device before changing wordclock settings.

- 1 Press the DISPLAY ACCESS [DIO/SETUP] button repeatedly until the DIO/Setup | Word Clock page appears.

On this page, you can view the current synchronization status of input signals at each slot and connector.

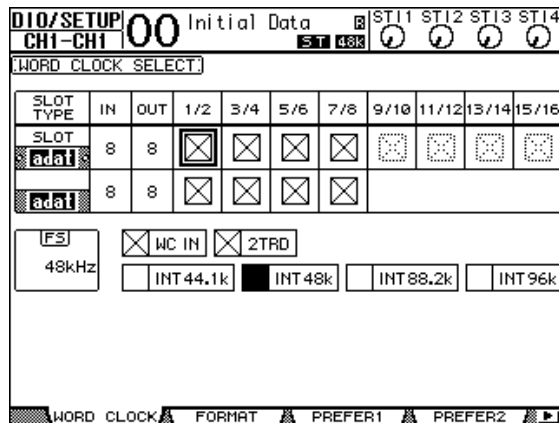

The source select button indicators are explained below:

- A usable wordclock signal is present at this input, and it is in sync with the current 01V96 internal clock.
- No wordclock signal is present at this input.
- A usable wordclock signal is present at this input, but it is out of sync with the current 01V96 internal clock.
- This input is the currently-selected wordclock source.
- This input was selected as the wordclock source, but no usable signal was received.
- Either this input is not receiving wordclock, or else it cannot be used with the currently-installed I/O card.

Tip:

- The FS box displays the sampling frequency at which the 01V96 is currently operating.
- The SLOT TYPE column displays the names of any installed I/O card.
- The IN and OUT columns indicate the number of input and output channels available for each installed I/O card.

2 Use the cursor buttons to move the cursor to a source, then press [ENTER].

The following are possible wordclock sources:

- **SLOT** These buttons select the inputs from the digital I/O card installed in the slot as the wordclock source. Inputs are selected in pairs (odd and even numbers in this order). The SLOT TYPE column displays the names of any installed I/O card. The number of pairs depends on the type of I/O card installed.
- **adat** These buttons select the inputs from the ADAT IN connector on the rear panel. Inputs are selected in pairs (odd and even numbers in this order).
- **WC IN**..... This button selects the wordclock signal input at the WORD CLOCK IN connector on the rear panel.
- **2TRD** This button selects the 2TR IN DIGITAL input as the wordclock source.
- **INT 44.1k, INT 48k**
INT 88.2k, INT 96k These buttons select the internal clock generator as the wordclock source. The 01V96 will function as the wordclock master.

Note: To transfer data at higher sampling frequencies (88.2 kHz or 96 kHz) between the 01V96 and connected external devices, you need to set the data transfer format. For more information, see page 72.

Tip: If wordclock transfer is interrupted while the 01V96 (being used as a slave unit) is receiving the clock signal, the unit will automatically switch to an internal clock (INT 44.1k/ INT 48k/INT 88.2k/INT 96k) that is closest to the interrupted clock.

Input and Output Patching

The 01V96 is designed to enable you to patch (assign) signals to Inputs and Outputs. This section explains how to view the signals patched to Inputs and Outputs and change the assignment.

Tip: If the data from a connected instrument fails to be input, or if you are unable to monitor the signal at the desired output, check the I/O patching, as explained below:

Patching Input Channels

By default, the Input Channels are patched as follows:

- INPUT connectors 1–16 Input Channels 1–16
- ADAT IN channels 1–8 Input Channels 17–24
- Slot channels 1–8 Input Channels 25–32
- Outputs 1–2 of Internal Effects Processor 1–4 ST IN Channels 1–4

Follow the steps below to view or change the patching.

- 1 Press the DISPLAY ACCESS [PATCH] button repeatedly until the following page appears.

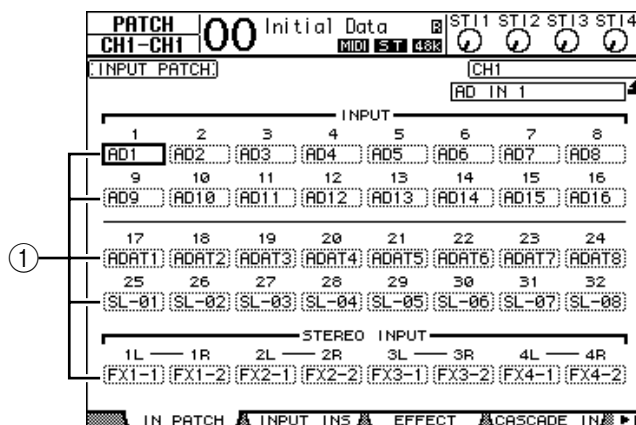

Inputs and Slot channels that are currently assigned to Input Channels are shown in the parameter boxes (①) beneath the channel numbers. The parameter indicators are explained below:

- -No assignment
- AD1–AD16INPUT connectors 1–16
- ADAT1–ADAT8ADAT IN channels 1–8
- SL-01–SL-16Slot channels 1–16
- FX1-1–FX1-2Outputs 1–2 of Internal Effects Processor 1
- FX2-1–FX2-2Outputs 1–2 of Internal Effects Processor 2
- FX3-1–FX3-2Outputs 1–2 of Internal Effects Processor 3
- FX4-1–FX4-2Outputs 1–2 of Internal Effects Processor 4
- 2TD-L/R2TR IN DIGITAL L/R connectors

Follow the steps below to view or change the patching.

- 2 Use the cursor buttons to move the cursor to a patch parameter (①) for which you want to change the assignment, and rotate the Parameter wheel or press the [INC]/[DEC] buttons to modify the patching.

3 Press [ENTER] to confirm the change.

Tip: To restore the default patching, recall Input Patch memory #00 (see page 178).

Patching Omni Outs

By default, the output connectors are patched as follows:

- **OMNI OUT connectors 1–4**Aux Out 1–4
- **ADAT OUT channels 1–8**Bus Out 1–8
- **Slot channels 1–8**Bus Out 1–8
- **Slot channels 9–16**Bus Out 1–8
- **2TR DIGITAL connectors**Stereo Out L & R

Tip:

- The **STEREO OUT** connectors always output the Stereo Bus signals.
- The **MONITOR OUT** connectors output monitor signals or the 2TR IN signals, depending on the Monitor Source selector setting.

Follow the steps below to view or change the patching.

1 Press the **DISPLAY ACCESS [PATCH]** button repeatedly until the following page appears.

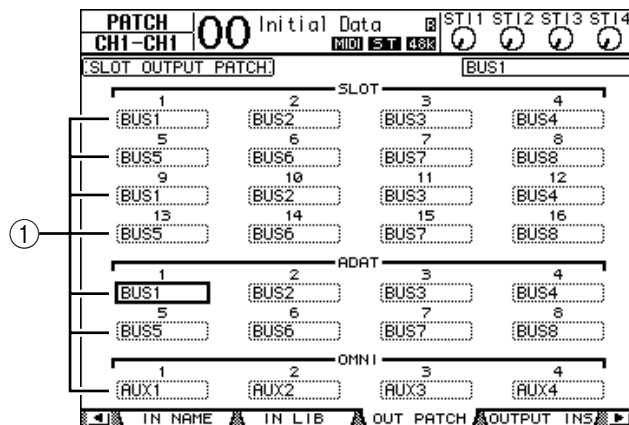

Signals that are currently assigned to the output connectors are shown in the parameter boxes (①) underneath the connector numbers. The parameter indicators are explained below:

- -No assignment
- **BUS1–BUS8**Bus Out 1–8 signals
- **AUX1–AUX8**Aux Out 1–8 Signals
- **ST L/R**Stereo Out signals
- **INS CH1–INS CH32**Input Channels 1–32 Insert Outs
- **INS BUS1–INS BUS8**Bus Out 1–8 Insert Outs
- **INS AUX1–INS AUX8**Aux Out 1–8 Insert Outs
- **INS ST-L/ST-R**Stereo Out Insert Outs
- **CAS BUS1–BUS8**Bus Out 1–8 Cascade Outs
- **CAS AUX1–AUX8**Aux Out 1–8 Cascade Outs
- **CAS ST-L/ST-R**Stereo Out Cascade Outs
- **CASSOLOL/CASSOLOR**Solo Channel Cascade Outs

- 2 Use the cursor buttons to move the cursor to a patch parameter (①) you wish to change, and rotate the Parameter wheel or press the [INC]/[DEC] buttons to modify the patching.
- 3 Press [ENTER] to confirm the change.

Tip: To restore the default patching, recall Output Patch memory #00 (see page 179).

5 Tutorial

This chapter describes how to use the 01V96 for multitrack recording and mixdown, using an example in which the 01V96 is connected to a digital multitrack recorder. A rhythm machine, guitar, bass, and keyboard are recorded.

Connections and Setup

1 Connect a digital MTR, musical instruments and a microphone to the 01V96.

In this example, a 16-track hard disk recorder is connected to the ADAT IN and OUT connectors on the rear panel, and the ADAT IN and OUT connectors on an installed MY8-AT card. (See page 38 for connection details.)

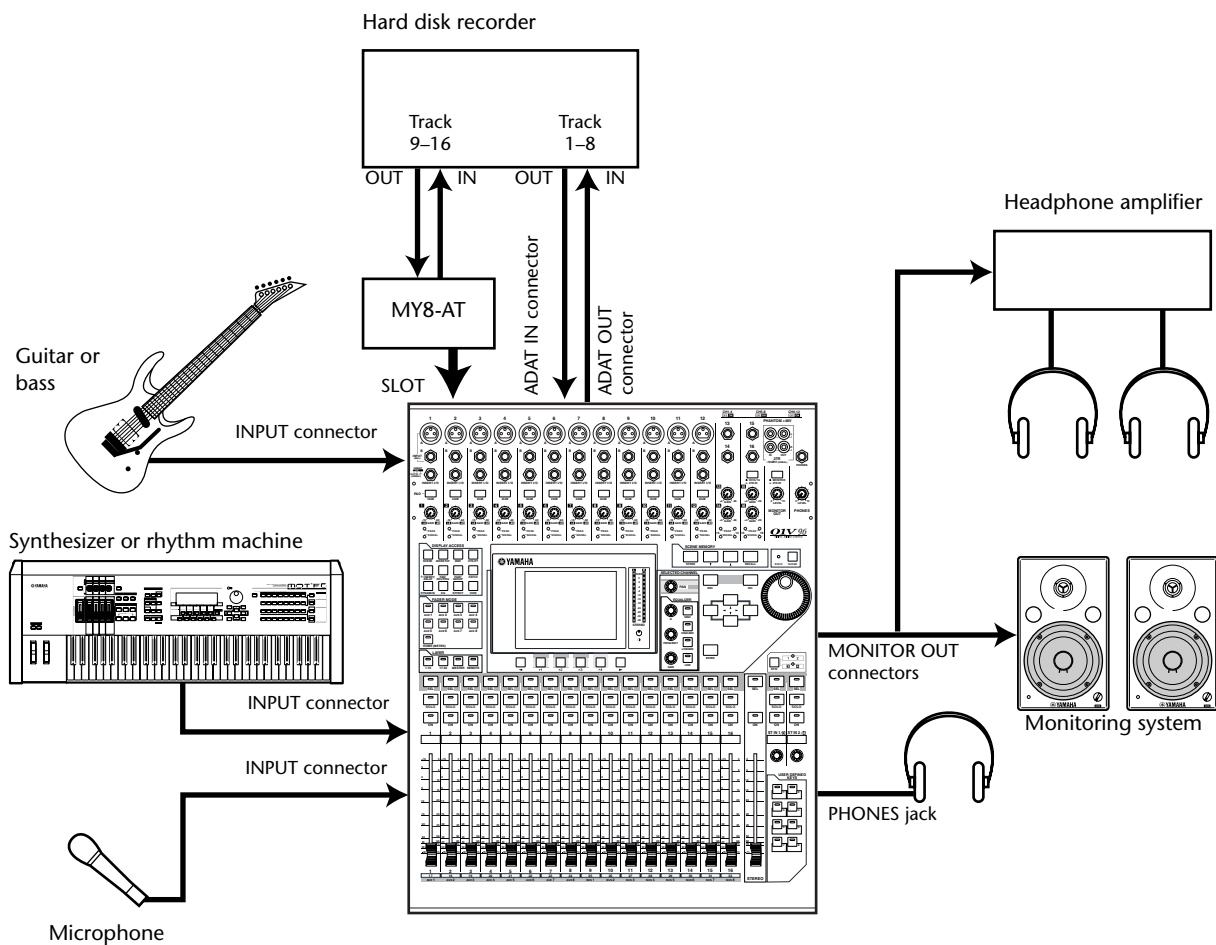

2 Press the DISPLAY ACCESS [DIO/SETUP] button repeatedly until the DIO/Setup | Word Clock page appears. On this page, specify the wordclock source.

The best wordclock source depends on the system and environment.

In the following example, a hard disk recorder operating at a sampling frequency of 44.1kHz is used as the wordclock master. The wordclock source is derived from the signal input at the ADAT IN Channels 1 and 2.

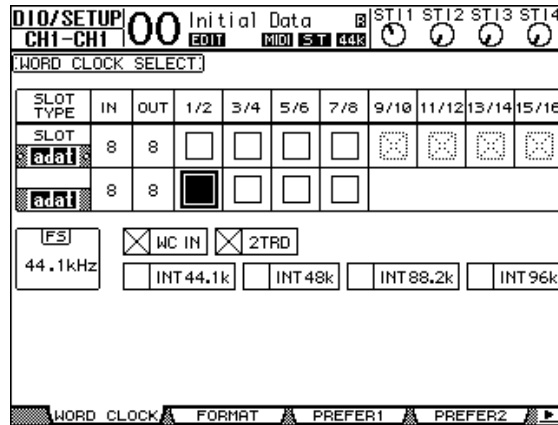

Tip:

- See page 40 for more information on wordclock.
- See page 75 for more information on 01V96s running at higher sampling frequencies (88.2 kHz or 96 kHz).

Note:

- You can select the 01V96 internal clock as the wordclock source. In this case, you must set the hard disk recorder so that it will synchronize to an external clock.
- If the 01V96 and a connected device are not synchronizing to each other, the 01V96 displays the message “Sync Error!” If this happens, check the ADAT IN and OUT connections, digital I/O card connection, and the sampling frequency setting on each device.

- 3 Press the DISPLAY ACCESS [PATCH] button repeatedly until the Patch | In Patch page appears. On this page, make sure that the Input Patch settings remain set to default values, as shown below.

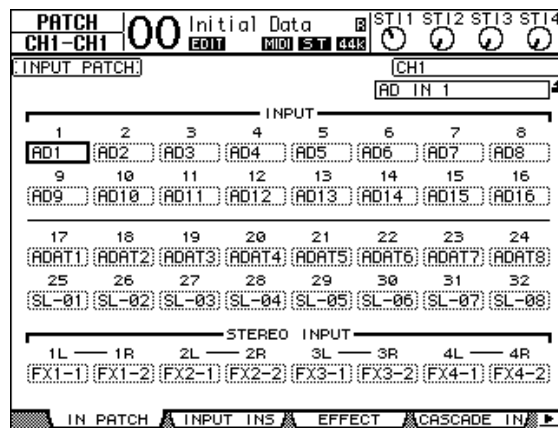

By default (as shown in this example), the signals input at INPUT connectors 1–16 are routed to Input Channels 1–16.

The signals input at the ADAT IN connector (the Track 1–8 signals from the hard disk recorder in this example) are routed to Input Channels 17–24, and the signals input from the slot (the Track 9–16 signals from the hard disk recorder) are routed to Input Channels 25–32.

If the Input Patch settings have been changed from the default settings, recall Input Patch memory #00 from the Input Patch library (page 175).

- Press the [PATCH] button repeatedly until the Patch | Out Patch page appears. On this page, make sure that the Output Patch settings remain set to default values, as shown below.

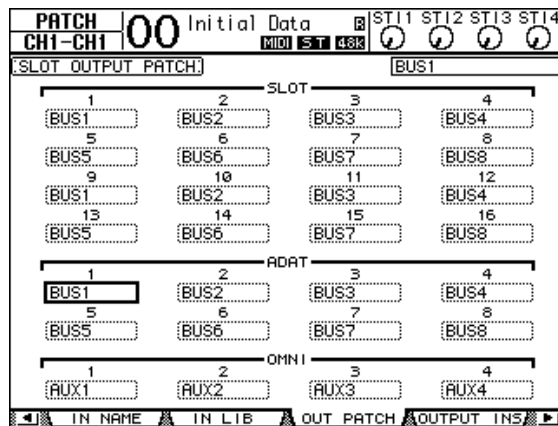

By default (as shown in this example), the signals output from Bus Outs 1–8 are routed to the ADAT OUT connector (Tracks 1–8 of the hard disk recorder in this example), and to the slot output channels (Tracks 9–16 of the hard disk recorder in this example).

If the Output Patch settings have been changed from the default settings, recall Output Patch memory #00 from the Output Patch library (page 175).

Initial Track Recording

This section explains how to make an initial recording to the hard disk recorder's tracks of a rhythm machine, synthesizer, bass, guitar, and microphone that are connected to INPUT connectors 1–12.

Setting the Input Levels

- Cue the musicians to play the musical instruments connected to INPUT connectors 1–12 while adjusting the corresponding [PAD] switches and [GAIN] controls so that the [PEAK] indicators temporarily flash at the highest volumes.

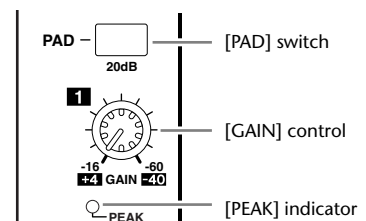

Tip: The [GAIN] controls adjust the analog input sensitivity. To make a high-quality recording with a wide dynamic range and little noise, set the [GAIN] controls as high as possible while avoiding clipping.

- Press the LAYER [1–16] button.

Input Channel Layer 1–16 is now available for control from the channel strip section.

Tip: Since the fader and [ON] button positions of each layer are memorized, those positions for the corresponding layer are restored when you switch to that layer.

- Press the FADER MODE [HOME] button, then press the [F1] button to display the Meter | CH1-32 page.

Meter pages are the start point for mixing and recording. They display channel input and output levels, and compressor and gate gain reduction amounts.

The CH1-32 page enables you to view Input Channel 1–32 levels and compressor and gate gain reduction amounts.

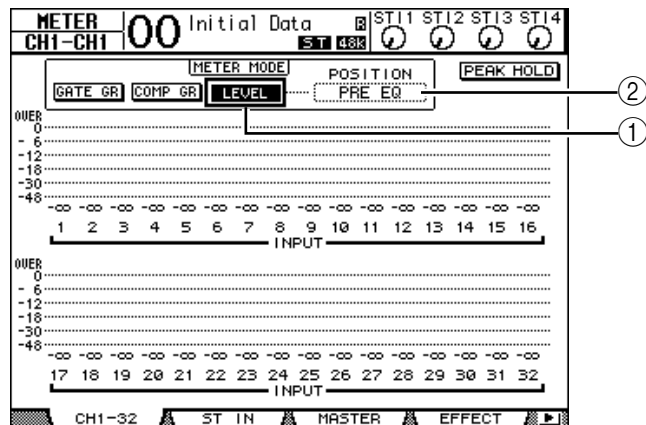

- 4 Make sure that the LEVEL button (①) is turned on in the METER MODE section.

The METER MODE section enables you to select the type of signals displayed on the meters. If any button other than the LEVEL button is turned on, move the cursor to the LEVEL button, then press [ENTER].

- 5 Move the cursor to the POSITION parameter box (②) to the right of the LEVEL button, rotate the Parameter wheel or press the [INC]/[DEC] buttons to select “POST FADER,” then press [ENTER].

The POSITION parameter indicates the metering position. When “POST FADER” is selected, the meters indicate the post-fader signal levels.

Tip: If you set the POSITION parameter to “PRE EQ,” the pre-EQ input levels are metered. If you set the parameter to “PRE FADER,” the post-EQ and pre-fader input levels are metered.

- 6 Make sure that [ON] button indicators 1–12 are lit, then raise faders 1–12 to 0dB.
- 7 While the musicians play the musical instruments, check the input channel levels using the level meters on the display.

Tip: If the meters reach the “OVER” level, make sure that the faders are set to 0dB, then lower the corresponding [GAIN] controls.

Pairing Channels

On the 01V96, you can pair adjacent odd-even channels for stereo operation. Faders and most mix parameters of paired channels (excluding the Input Patch, phase, routing, and pan parameters) are linked. Pairing Input Channels is useful when you are connecting stereo sources, such as a rhythm machine or synthesizer.

- 1 To pair adjacent odd-even Input Channels, press and hold the [SEL] button for one of the channels you wish to pair, and press the [SEL] button for the adjacent channel.

The corresponding two channels are paired, and the settings (such as faders, channel on/off, etc.) of the first channel are copied to the second channel. Subsequently, adjusting the linked parameters of one of the paired channels will adjust the parameters of its partner in the same way.

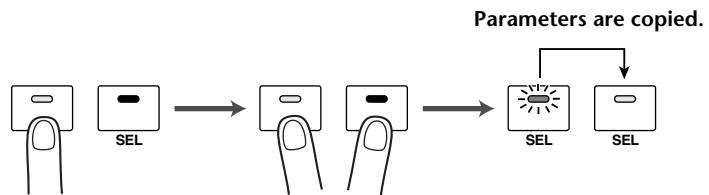
**Tip:**

- You can still select one of the paired channels for control by pressing the corresponding [SEL] button. When you select the channel, the [SEL] button indicator lights up, and the [SEL] button for the paired partner flashes.
- You can also determine how to copy the parameter settings to the paired partner by using a special window (see page 230).
- You can create or cancel pairs on the Pair/Grup pages (see page 93).
- You can also group the faders, [ON] buttons, EQs, or compressors of multiple channels (see page 149).

- 2 To cancel a pair, press and hold the [SEL] button for one of the paired channels, and press the [SEL] button for the other channel.

Note: If you want to operate the faders of paired channels, make sure you operate only one fader for the pair. If you try to operate the faders for both channels in the pair, an excessive load will be applied to the fader motor, causing malfunction.

Routing Signals

To record the 01V96 input signals to an external digital multitrack recorder, you must specify the destination of the signals for each Input Channel. This process is called “routing.” There are two routing methods.

- **Using Bus Outs 1–8**

Input Channel signals are first routed to Buses 1–8, then through Bus Outs 1–8 to the output connectors or channels. Use this method to mix multiple Input Channel signals and record them to the MTR’s tracks. If you desire, you can process the signals using the Bus Out 1–8 compressors and EQs.

In the following example, Input Channel signals are routed through Bus Outs 1 and 2 to ADAT OUT connectors 1 and 2.

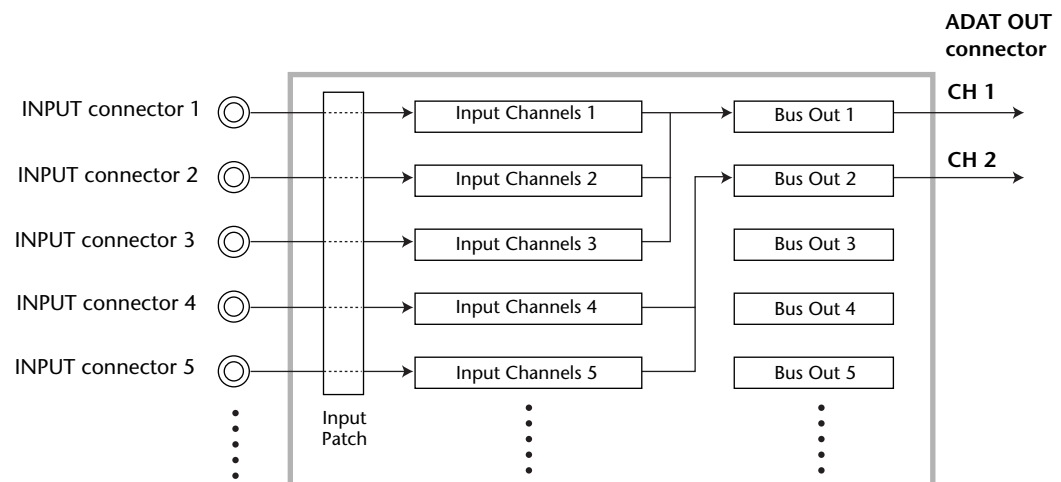

- **Using Direct Outs**

Each Input Channel signal is directly routed to and output from the specified output connectors and channels. Use this method to patch each Input Channel directly to each MTR track.

The following example illustrates the signals directly output from ADAT OUT channels 1–5.

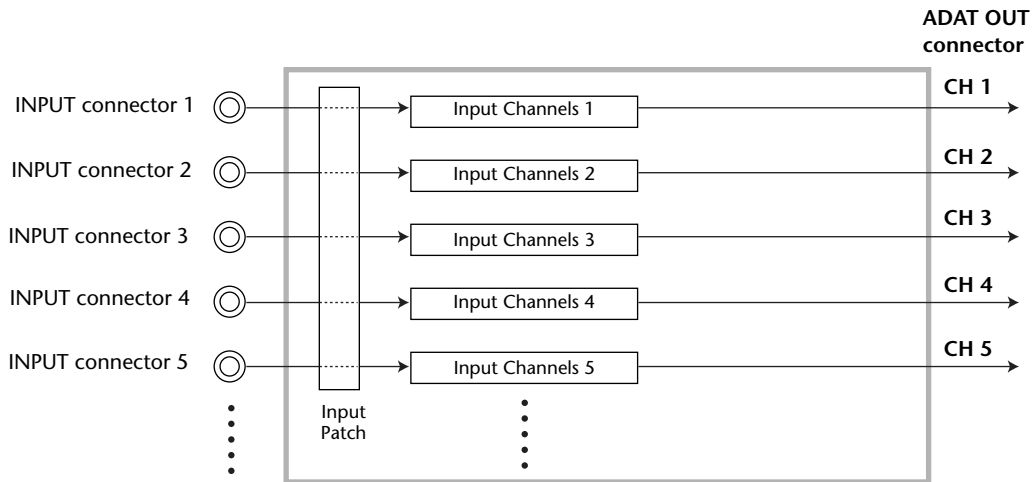

This section describes how to route signals by combining the above two routing methods.

- 1 **Press the DISPLAY ACCESS [PAN/ROUTING] button repeatedly to display the Pan/Route | Rout1-16 page.**

This page enables you to select a Bus Out as the signal destination for each channel.

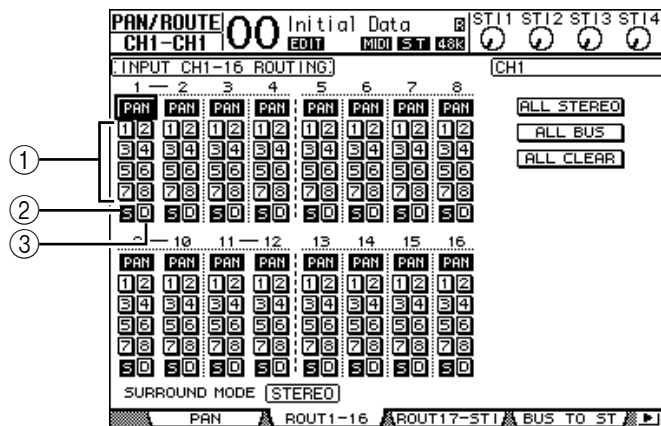

This page contains the following buttons:

- ① **1–8 buttons**
These buttons route Input Channel signals to Buses 1–8. You can select multiple buttons.
- ② **S button**
This button routes Input Channel signals to the Stereo Bus.
- ③ **D button**
This button routes Input Channel signals to the specified output connectors and channels directly.

- 2 Move the cursor to the **S** button for the Input Channel to which the musical instrument or microphone is connected, then press [ENTER] to turn it off.

By default, each Input Channel is routed to the Stereo Bus, which enables you to monitor the signals from the MONITOR OUT connectors and the PHONES jack.

However, during multitrack recording you may usually want to monitor the signals returned from the connected digital MTR, rather than monitoring the Input Channel signals. To do so, you must turn off the **S** button so that the particular Input Channel signals will not be routed to the Stereo Bus.

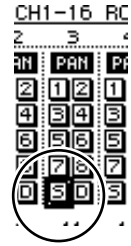

- 3 To route Input Channel signals to the connected digital MTR via Buses 1–8, use the 1–8 buttons to specify a Bus Out as the destination for each of the Input Channels to which the musical instruments and microphone are connected.

In this example, Input Channels 1–4 are assigned to Buses 1 and 2, and Input Channels 5–8 are assigned to Buses 3 and 4.



- 4 Press the [PAN/ROUTING] button repeatedly to display the Pan/Route | Pan page.

This page enables you to set the panpots for signals routed from the Input Channels to the Stereo Bus, and for signals routed from the Input Channels to the odd-even buses.

- 5 Move the cursor to the **PAN** parameter controls for the Input Channels that are assigned to the odd-even buses, then rotate the Parameter wheel or press the [INC]/[DEC] buttons to set the pan.

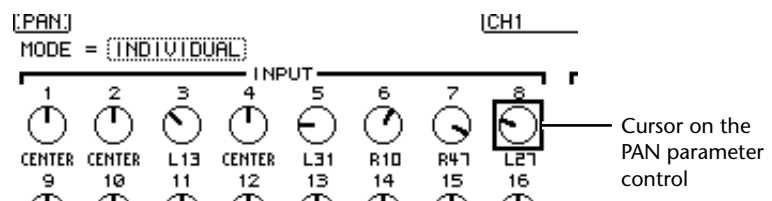

Tip: You can also use the [SEL] buttons to select Input Channels, and the SELECTED CHANNEL [PAN] control to adjust the pan setting.

- 6 To route Input Channel signals to Direct Outs, press the DISPLAY ACCESS [PATCH] button repeatedly until the Patch | Direct Out page appears.

The Direct Out page enables you to specify the output connectors or channels to which each Input Channel is directly patched.

- 7 Move the cursor to the parameter box for the Input Channels you want to route to Direct Outs, then specify the output connectors or channels.

In this example, Input Channel 9–12 signals are routed to ADAT OUT channels 5–8.

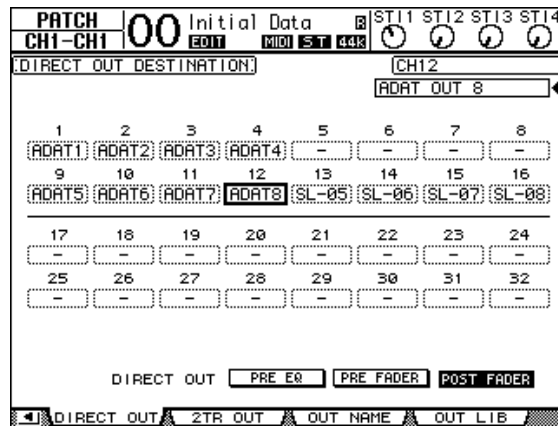

- 8 Press the DISPLAY ACCESS [PAN/ROUTING] button repeatedly until the Pan/Route | Rout1-16 page appears.
- 9 Move the cursor to the D button for the Input Channels you want to route to Direct Outs, then press [ENTER].

The Input Channels for which the D buttons are turned on are directly patched to the output connectors or channels specified in Step 7.

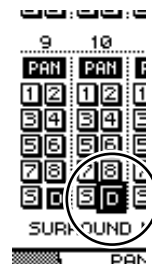

Adjusting the Monitoring Level

You can monitor the recording signals by placing the digital MTR in record ready mode, routing the signals sent to Tracks 1–8 of the digital MTR back to the 01V96's Input Channels 17–24, then patching them to the MONITOR OUT connectors and the PHONES jack.

- 1 **Arm the connected digital MTR's tracks for recording.**
At this time, set the monitor mode on the digital MTR accordingly so that you can monitor the input signals on the armed tracks. (Refer to the owner's manual for the digital MTR for more information.) In this way, signals sent to Tracks 1–8 of the digital MTR are returned to the 01V96's Input Channels 17–24.
- 2 **Press the LAYER [17–32] button.**
Input Channel Layer 17–32 is now available for control from the channel strip section.
- 3 **Press the DISPLAY ACCESS [PAN/ROUTING] button repeatedly until the Pan/Route | Rout17-STI page appears.**

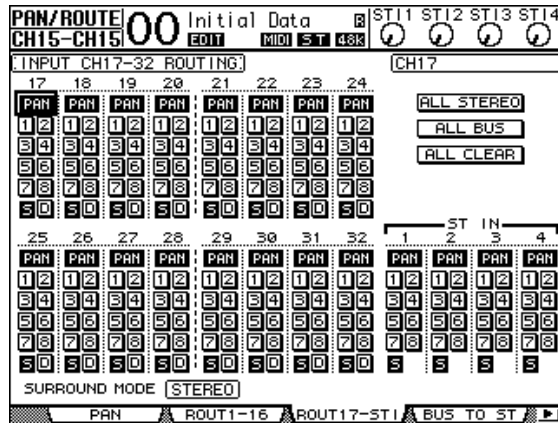

- 4 Make sure that the S buttons for Input Channels 17–24 are turned on and the 1–8 buttons are turned off, then use the PAN control to pan the monitoring signal.

Tip: Controlling Input Channel 17–32 Pan settings, faders, and the [ON] buttons will affect the monitoring signal, but will not affect the signal recorded to the digital MTR.

- 5 Press the DISPLAY ACCESS [HOME] button, then press the [F1] button to display the Meter | CH1-32 page.
- 6 Make sure that [ON] button indicators 1–8 are steadily lit, then raise the [STEREO] fader to 0 dB.

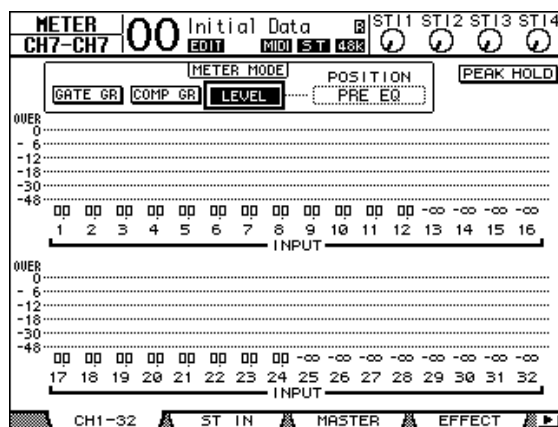

- 7 While the musicians play the musical instruments, adjust faders 1–8, [MONITOR OUT] control, and [PHONES] control to set the appropriate monitoring level.

Now you can monitor via the monitoring system and headphones the signals sent from Input Channels 17–24 to the Stereo Bus.

Note: If the L & R level meters reach the “OVER” position, lower the [STEREO] fader.

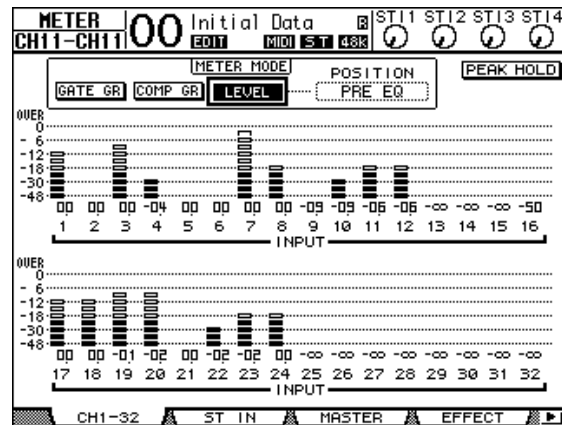

EQ'ing the Input Signals

The 01V96's Input Channels feature 4-band full parametric EQ. This section describes how to apply EQ to the signals before they are recorded to the tracks.

1 Press the LAYER [1–16] button.

Input Channel Layer 1–16 is now available for control from the channel strip section.

2 Press the [SEL] button for the Input Channel to which you want to apply EQ.

3 Press the [EQ] button, then the [F1] button to display the EQ | EQ Edit page.

The EQ Edit page enables you to adjust the EQ parameters for the currently-selected channel.

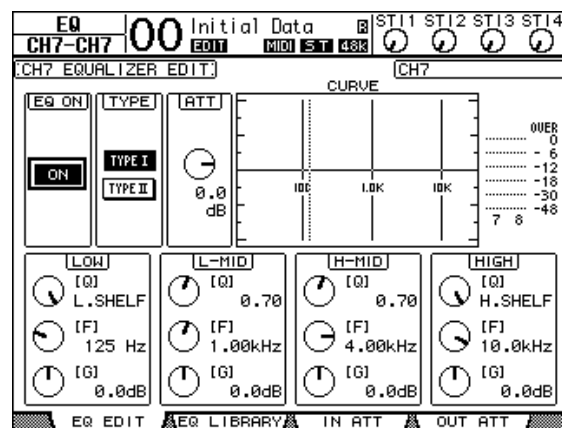

4 Make sure that the EQ ON button (in the upper-left corner) is turned ON.

The EQ ON/OFF button turns the currently-selected Input Channel's EQ on or off. If the button is off, press the [ENTER] button to turn it on.

5 While a musician plays the musical instrument, adjust the EQ parameters.

To do so, move the cursor to the parameters in the lower half of the page, then rotate the Parameter wheel to change the values. You can adjust the following parameters for the LOW, L-MID, H-MID, and HIGH bands individually.

- **Q**
This parameter control specifies the Q (slope) for cut/boost of the center frequency set via the F parameter control. The setting range is between 10 and 0.10. The higher the value, the steeper the slope becomes. This parameter control also selects the type of EQ for the LOW and HIGH band.
- **F (Frequency)**
This parameter control specifies the center frequency for cut/boost, with a setting range of 21.2 Hz to 20.0 kHz.
- **G (Gain)**
This parameter control specifies the cut/boost amount in the range of -18.0 dB to $+18.0$ dB. The LOW and HIGH GAIN controls function as filter on/off controls when Q is set to HPF and LPF respectively.

You can also press the buttons ([HIGH], [HIGH-MID], [LOW-MID], [LOW]) in the SELECTED CHANNEL section to select the desired band and use the rotary controls ([Q], [FREQUENCY], [GAIN]) to directly edit the Q, F, and G parameters.

Tip:

- Turn the Q parameter control for the LOW band clockwise all the way to set the LOW-band EQ to “L. SHELF” (low-shelving), and counter-clockwise all the way to set it to “HPF” (high-pass filter).
- Turn the Q parameter control for the HIGH band clockwise all the way to set the HIGH-band EQ to “H. SHELF” (high-shelving), and counter-clockwise all the way to set it to “LPF” (low-pass filter).
- By default, the LOW band is set to “L. SHELF,” and the HIGH band is set to “H. SHELF.”

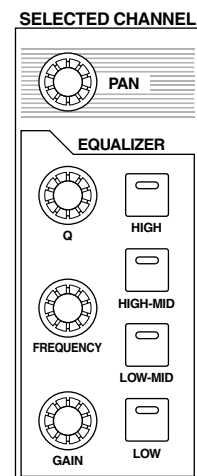

6 In the same way, adjust the EQ for the other channels.

Tip:

- The meters in the upper-right corner of the page indicate the post-EQ signal levels of the currently-selected Input Channel. If these meters reach the “OVER” position, lower the pre-EQ signal level using the ATT. parameter control located in the upper-left on the page.
- You can also apply EQ to the Input Channel signals returned from the recorder. In this way, you can process only the monitoring signals, without affecting the signals being recorded to the recorder.
- You can use the EQ settings (programs) in the provided EQ library for various applications and instruments.

Compressing the Input Signals

The 01V96's Input Channels 1–32 feature individual channel compressors. This section describes how to compress the signals before they are recorded to the tracks.

1 Press the LAYER [1–16] button.

Input Channel Layer 1–16 is now available for control from the channel strip section.

2 Press the [SEL] button of the Input Channel to which you want to apply compression.

3 Press the [DYNAMICS] button, then press the [F4] button.

The Dynamics | Comp Lib page appears. This page enables you to store compressor settings (programs) to the Compressor library, and recall compressor programs from the library. This example uses one of the compressor programs 1–36 from the Compressor library.

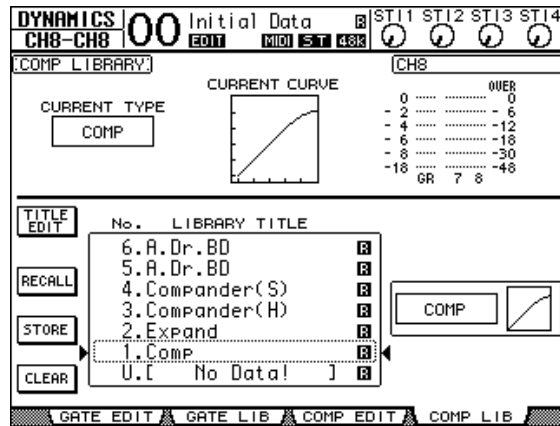

4 Rotate the Parameter wheel to scroll the library title list, and select a program that you want to recall.

The selected program appears inside the dotted box.

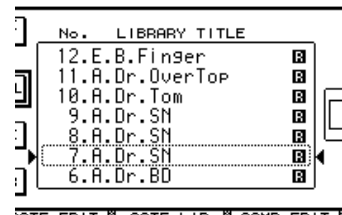

5 Move the cursor to the RECALL button located to the left of the library title list, then press [ENTER].

The selected program is recalled.

6 Press the [F3] button.

The 01V96 displays the Dynamics | Comp Edit page, which enables you to adjust compressor parameters.

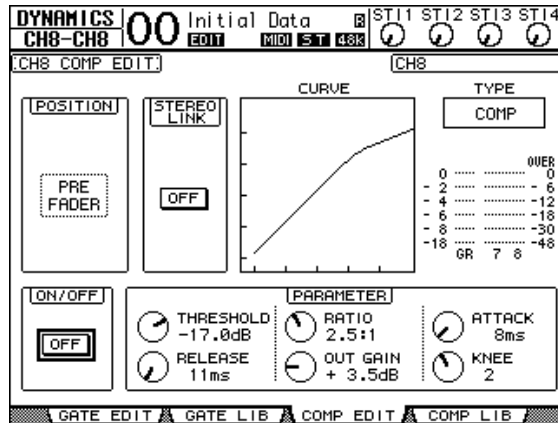
**Tip:**

- The 01V96 features four types of dynamics processors: COMP (Compressor), EXPAND (Expander), COMP. (S) (Compander Soft), and COMP. (H) (Compander Hard). These processors feature different parameters. (See page 272 for the parameters for each compressor type.)
- You cannot change the compressor type on the Comp Edit page. To change the compressor type, recall a program that uses the desired compressor type from the Compressor library, then adjust the parameters as desired.

7 Press the [ENTER] button to turn on the ON/OFF button located in the lower-left corner of the page.

The ON/OFF button turns the currently-selected Input Channel's compressor on or off.

8 While a musician plays the musical instrument, adjust the compressor parameters.

To do so, move the cursor to the desired parameter in the PARAMETER section on the page, then rotate the Parameter wheel or press the [INC]/[DEC] buttons.

Input Channels 1–32 feature a gate that can be used independently of the compressor. To use the gate, first press the [DYNAMICS] button, then the [F2] button to access the Gate library. After you recall a gate program, press the [Dynamics] button, then the [F1] button to display the Gate Edit page, which enables you to adjust gate parameters.

Recording

When you finish setting up each channel, you can start recording on the digital MTR as follows:

1 Start recording on the digital MTR, and cue the musicians to start playing the musical instruments.

During recording, press the [HOME] button to display the Meter | CH1-32 page or the Master page, and check to confirm that the Input Channel levels and Bus 1–8 output levels are not clipping.

2 When you finish playing, stop the digital MTR.

3 To check the recording, play the digital MTR from the beginning.

4 If you are satisfied with the recording, stop the playback and disarm Tracks 1–8 on the recorder.

Tip: If the digital MTR supports MMC (MIDI Machine Control) commands, you can use the 01V96's Machine Control function to select tracks or locate a position on the recorder from the 01V96 (see page 212).

Overdubbing to Other Tracks

This section describes how to overdub the musical instruments or microphone connected to the INPUT connectors 1 and 2 to the digital MTR's Tracks 9 and 10, while listening to the performance recorded on Tracks 1–8.

Setting the Input Levels

- 1 Connect the musical instruments to INPUT connectors 1 and 2, and adjust the corresponding [PAD] switches and [GAIN] controls so that the [PEAK] indicators temporarily flash at the highest volumes.

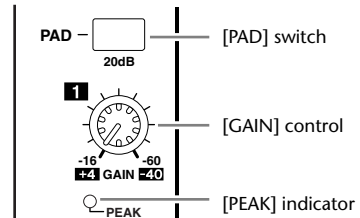

- 2 Press the LAYER [1–16] button.

Input Channel Layer 1–16 is now available for control from the channel strip section.

- 3 Press the DISPLAY ACCESS [HOME] button, then press the [F1] button to display the Meter | CH1-32 page.

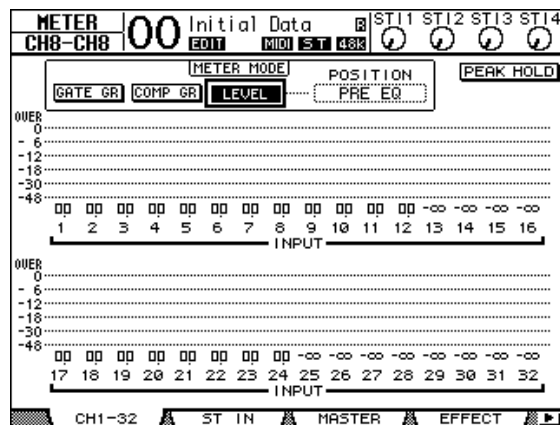

- 4 Make sure that [ON] button indicators for the channels to which the instruments or microphone are connected are lit, then raise the corresponding faders to 0dB.

Turn off the [ON] buttons for the channels not in use.

- 5 While the musicians play the musical instruments, check the input channel levels using the level meters on the display.

Routing Signals

Follow the steps below to route the Input Channel 1 and 2 signals to Slot Channels 1 and 2 directly so that the signals will be recorded to Tracks 9 and 10 on the digital MTR.

- 1 Press the **DISPLAY ACCESS [PATCH]** button repeatedly until the **Patch | Direct Out** page appears.
- 2 Move the cursor to the parameter box for the Input Channels you want to route to Direct Outs, then specify the output connectors or channels.

In this example, Input Channel 1 and 2 signals are patched to Slot output channels 1 and 2.

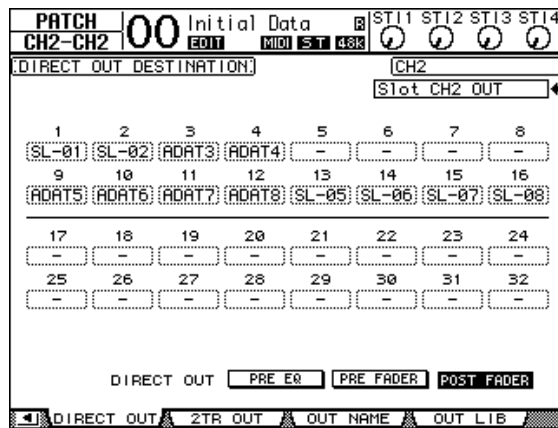

- 3 Press the **DISPLAY ACCESS [PAN/ROUTING]** button repeatedly until the **Pan/Route | Rout1-16** page appears.
- 4 Move the cursor to the **D** buttons for Input Channels 1 and 2, then press **[ENTER]**. Turn off the **S** buttons and 1–8 buttons.

The Input Channel 1 and 2 signals are now routed to Slot output channels 1 and 2, then output to Tracks 9 and 10 on the digital MTR.



Adjusting the Monitoring Level

Follow the steps below to place the digital MTR in record ready mode and monitor the signals (that are sent from Tracks 9 and 10 of the digital MTR back to the 01V96's Input Channels 25 and 26) through the MONITOR OUT connectors and the PHONES jack.

- 1 **Arm the connected digital MTR's Tracks 9 and 10.**
At this time, set the monitor mode on the digital MTR accordingly so that you can monitor the input signals on the armed tracks, and monitor playback signals from the other tracks. (Refer to the owner's manual for the digital MTR for more information.)
- 2 **Press the LAYER [17–32] button.**
Input Channel Layer 17–32 is now available for control from the channel strip section.
- 3 **Press the DISPLAY ACCESS [PAN/ROUTING] button repeatedly until the Pan/Route | Rout17–STI page appears.**
- 4 **Make sure that the S buttons for Input Channels 25 and 26 are turned on and the 1–8 buttons are turned off.**

- Press the [F1] button to display the Pan/Route | Pan page, then use the PAN parameter controls on the page to pan channel signals.

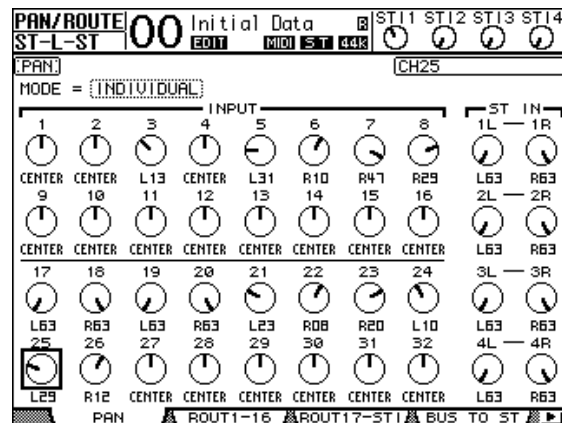

- Press the DISPLAY ACCESS [HOME] button, then press the [F1] button to display the Meter | CH1-32 page.
- Make sure that [ON] button indicators 9 and 10 are steadily lit.
- While the musicians play the musical instruments, raise faders 9 and 10 to set the appropriate monitoring level.
If necessary, play back the recording on the digital MTR and adjust the volume balance between the recorded and recording signals.

Recording

- Start recording on the digital MTR, and cue the musicians to start playing the musical instruments while monitoring the recorded tracks.
During recording, display the Meter | CH1-32 page, and confirm that the Input Channel levels are not clipping.
- When the musicians finish playing, stop the digital MTR.
- To check the recording, play the digital MTR from the beginning.
- If you are satisfied with the recording, stop the playback and disarm Tracks 9 and 10 on the recorder.

Mixing Recorded Tracks into Stereo (Mixdown)

“Mixdown” is the process of mixing recorded tracks into stereo and recording the stereo signal to an external master recorder. This section describes how to mix signals recorded on Tracks 1–16 into a stereo signal, then apply the 01V96’s internal effects to the signal, then record it to an external master recorder.

Connecting and Setting Up the Master Recorder

Follow the steps below to connect a DAT recorder, MD recorder, CD recorder or other master recorder to the 01V96. Change the 01V96’s internal patch so that you can monitor the playback signal on the master recorder through ST IN Channel 2.

1 Connect a master recorder to the 01V96.

In the following example, the 01V96 2TR OUT DIGITAL connector is connected to the master recorder’s digital input, and the 01V96 2TR IN DIGITAL connector is connected to the master recorder’s digital output.

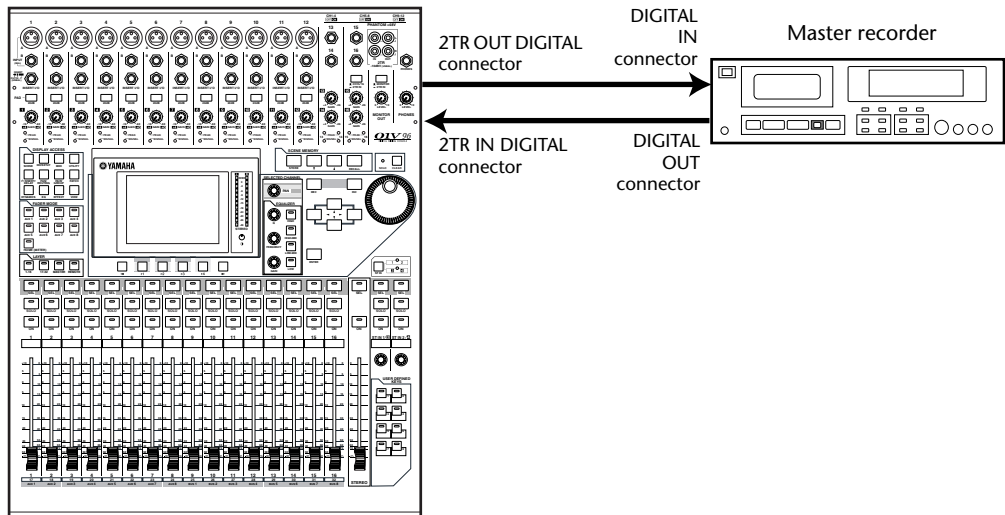

Tip: To monitor the master recorder’s playback signals, you can also connect the analog output of the master recorder to the 01V96 2TR IN connector. In this way, you can quickly switch the monitoring signal using the Monitor Source selector in the MONITOR OUT section.

2 Press the DISPLAY ACCESS [PATCH] button repeatedly until the Patch | In Patch page appears.

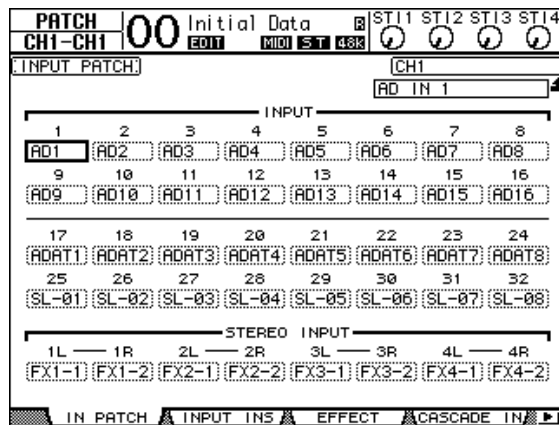

- 3 Move the cursor to the 2L parameter box in the STEREO INPUT section, rotate the Parameter wheel or press the [INC]/[DEC] buttons to select "2TD L," then press [ENTER].
- 4 In the same way, move the cursor to the 2R parameter box in the STEREO INPUT section, then select "2TD R."

The signals input at the 2TR IN DIGITAL connector are now routed to ST IN Channel 2 L and R.

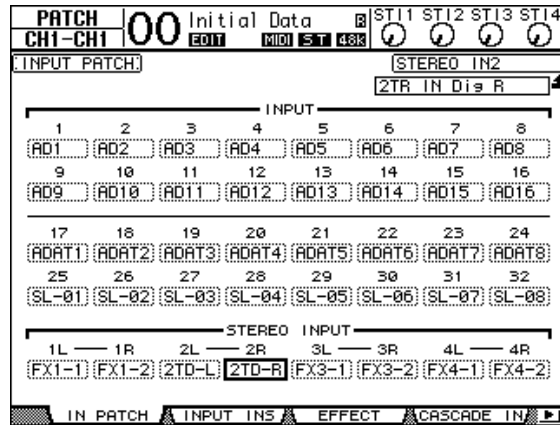

- 5 Use the ST IN [ST IN] button to select ST IN Channels 1 and 2.

The ST IN [ST IN] button selects an ST IN channel pair (ST IN Channels 1 and 2 or 3 and 4) which you can control using the buttons and controls in the ST IN section. The indicators to the right of the button indicate which ST IN channels are currently selected.

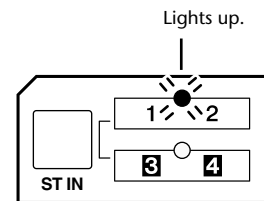

- 6 Turn off the [ON] button for ST IN Channel 2.

The button indicator turns off.

This [ON] button should be turned on only when you monitor the playback signal of the master recorder.

Adjusting the Track Mix Balance

Follow the steps below to adjust the mix balance among Tracks 1–16 and process the signals using the EQ, compressor and gate.

- 1 Make sure that Tracks 1–16 on the digital MTR are all disarmed and the recorder is in a mode that enables you to monitor the track playback signals.
- 2 Press the LAYER [1–16] button, then turn off the [ON] buttons for Input Channels 1–16.
- 3 Press the LAYER [17–32] button and make sure that the [ON] buttons for Input Channels 17–32 are turned on.
- 4 Press the DISPLAY ACCESS [PAN/ROUTING] button repeatedly until the Pan/Route | Rout17–STI page appears. On this page, make sure that the 5 buttons for Input Channels 17–32 are turned on, and the 1–8 buttons are turned off.

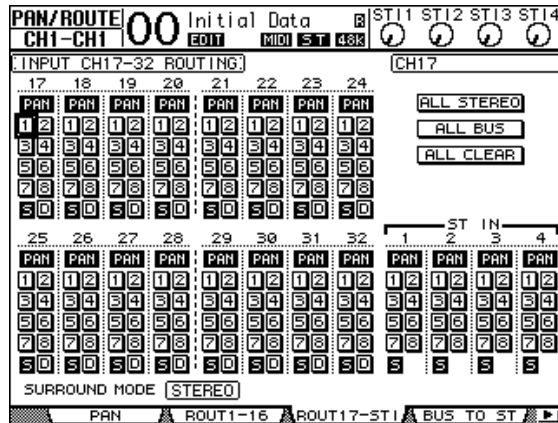

Input Channel 17–32 signals input from Tracks 1–16 of the digital MTR are now routed through the Stereo Bus, to the STEREO OUT and 2TR OUT DIGITAL connectors.

5 Use the PAN parameter controls for Input Channels 17–32 on the page to adjust the panpot for each track.

Tip: Alternatively, you can adjust the pan settings by selecting the Input Channels via the corresponding [SEL] button, then rotating the SELECTED CHANNEL [PAN] control.

6 Raise the [STEREO] fader to 0 dB.

7 While playing back the recording on the digital MTR from the beginning, operate faders 1–16 to adjust the mix balance among the tracks.

- **EQ'ing the track signals**

Select the desired channel by pressing the corresponding [SEL] button, press the [EQ] button, then press the [F1] button to display the EQ Edit page (see page 84). Alternatively, adjust the EQ parameters using the buttons and controls in the SELECTED CHANNEL section.

- **Compressing the track signals**

Select the desired channel by pressing the corresponding [SEL] button, press the [DYNAMICS] button, then press the [F4] button to display the Dynamics | Comp Lib page and recall the desired compressor program (see page 82). Press the [DYNAMICS] button, then press the [F3] button to display the Comp Edit page, then edit the compressor parameters.

- **Gating the track signals**

Select the desired channel by pressing the corresponding [SEL] button, press the [DYNAMICS] button, then press the [F2] button to display the Dynamics | Gate Lib page. Then, recall the desired gate program. Press the [DYNAMICS] button, then press the [F1] button to display the Gate Edit page, then edit the gate parameters.

Using the Internal Effects

The 01V96 features four internal multi-effects processors that can be used via Aux Sends and Returns or by inserting them into specific channels. This section describes how to use internal Effects processor 1 via Aux Send 1, and apply reverb to the track signals.

- 1 Press the **DISPLAY ACCESS [PATCH]** button repeatedly until the **Patch | Effect** page appears.

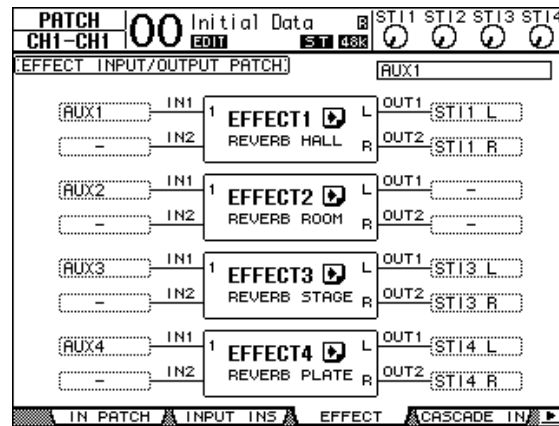

This page enables you to patch the inputs and outputs of Effects processors 1–4. By default, Aux Send 1 is patched to the input of Effects processor 1, and the output of Effects processor 1 is patched to ST IN Channel 1 L and R, as shown in the diagram above.

Tip: If the patch for internal Effects processor 1 is different from the above, use the Parameter wheel or [INC]/[DEC] buttons, and the [ENTER] button to change the patch.

- 2 Make sure that the [ON] button for ST IN Channel 1 in the ST IN section is turned on.
- 3 Press the **DISPLAY ACCESS [EFFECT]** button repeatedly until the **Effect | FX1 Lib** page appears.

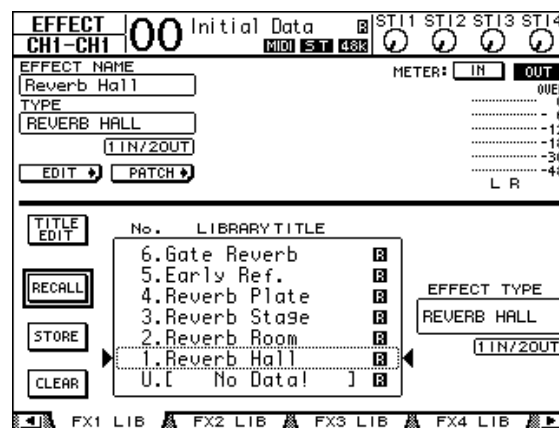

The Effect | FX1 Lib page enables you to recall effect programs to be used by Effects processor 1 from the Effects library, and store the current effects settings of Effects processor 1 to the Effects library.

Select from the list in the center column a program memory to which you wish to store the effects settings, or a program memory that you wish to recall. The selected program appears inside the dotted box.

4 Rotate the Parameter wheel and select “2. Reverb Room”

For purposes of this tutorial, select this room reverb program.

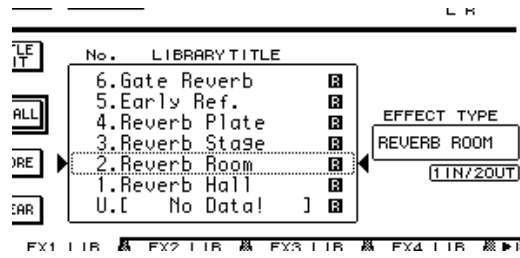

5 Move the cursor to the RECALL button located to the left of the list, then press [ENTER].

Effect program “Reverb Room” is loaded into Effects processor 1.

Tip: To edit the effect parameters, press the [EFFECT] button repeatedly until the Effect | FX1 Edit page appears (see page 161).

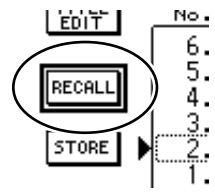

6 Press the LAYER [17–32] button.

Input Channel Layer 17–32 is selected for control from the channel strip section.

7 Press the FADER MODE [AUX1] button.

The button indicator lights up.

While the [AUX 1]–[AUX 8] button indicators are lit, faders 1–16 control the Aux 1–8 send levels.

In this example, the faders control the send level of the signals routed from Input Channels 17–32 to Aux 1 (Effects processor 1 input).

Tip: To reset the fader 1–16 function to normal mode, press the FADER MODE [HOME] button.

8 While playing back the recording on the digital MTR from the beginning, operate faders 1–16 to adjust the send level of the signals routed from Input Channels to Effects processor 1.

9 To adjust the effect return level, use the rotary level control located on the left side of the ST IN section on the top panel.

You can view the current level in the upper-right corner of the display.

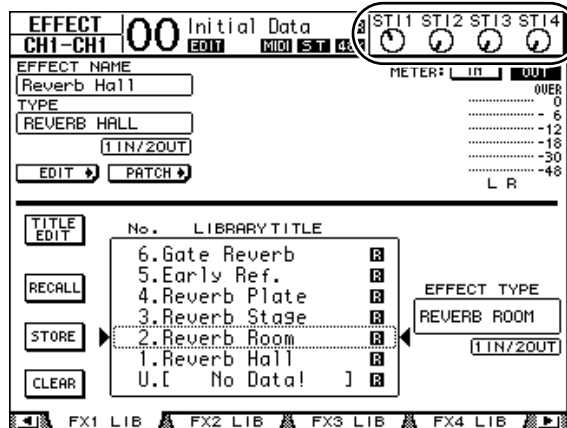

Recording to the Master Recorder

Follow the steps below to record the mixed stereo signal from the 01V96 to the connected master recorder.

1 Start recording on the master recorder, then start playing back on the digital MTR.

During recording, observe the stereo meter on the right of the display and confirm that the stereo output level is not clipping.

2 When the playback is finished, stop the master recorder, then stop the digital MTR.

3 Turn on the [ON] button for ST IN Channel 2 in the ST IN section. The button indicator lights up.

4 Play back the recording on the master recorder.

The playback signal is input at the 01V96's 2TR IN DIGITAL connector, then routed through ST IN Channel 2 to the Stereo bus.

Note: Most consumer-type DAT recorders and MD recorders are unable to synchronize to external wordclock during playback (that is, they cannot be wordclock slaves). If this type of master recorder is connected to the 01V96's 2TR IN DIGITAL connector, access the DIO/Setup | Word Clock page and select "2TRD" (2TR IN DIGITAL) as the wordclock source.

When the master recorder finishes playing back, turn off the [ON] button for ST IN Channel 2.

Tip: If you desire, you can store the current mix settings to memory as a Scene (see page 165).

6 Analog I/O & Digital I/O

This chapter describes the 01V96's analog and digital input/output connectors as well as the basic operations involving the digital I/Os.

Analog Inputs & Outputs

Input Section

The 01V96's top panel features input connectors, which enable you to connect microphone and line-level sources.

- **INPUT connectors A 1–12**

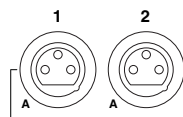

These balanced TRS-type phone connectors accept line-level and microphone signals. The nominal input range is -60 dB through $+4$ dB. The phantom $[+48V]$ switches on the rear panel turn on or off the $+48V$ phantom power feed to these inputs.

- **INPUT connectors B 1–12**

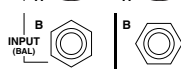

These balanced TRS-type connectors accept line-level and microphone signals. The nominal input range is -60 dB through $+4$ dB.

You cannot use same-numbered INPUT A and INPUT B connectors simultaneously. (For example, you cannot use INPUT A-2 and INPUT B-2 at the same time.) If you connect cables to A and B connectors of the same number, only the signal from INPUT B is effective (e.g., B-2 takes priority over A-2).

- **INPUT connectors 13–16**

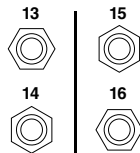

These balanced TRS-type phone connectors accept line-level signals. When the AD 15/16 source selector is turned on (pushed in), signals from INPUT 15 and 16 are ignored. Instead, signals from the 2TR IN connector will be routed to AD Input Channels 15 and 16.

Tip: You can patch signals input from the INPUT connectors to any Input Channels. (See page 121 for information on patching input signals to Input Channels.)

- **INSERT I/O connectors**



These TRS-type phone connectors are used to insert external devices, such as effects processors, into AD Input Channels.

- **Phantom Power**

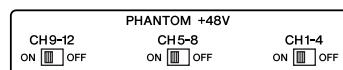

Inputs 1 through 12 feature switchable $+48V$ phantom powering for use with condenser-type microphones and direct boxes. The phantom $[+48V]$ switches on the rear panel turn on or off the $+48V$ phantom power feed to the corresponding inputs.

- **PAD switches**



Inputs 1 through 12 feature pad switches, which attenuate input signals by 20 dB. These switches are effective on both INPUT A and B signals.

- **GAIN controls**

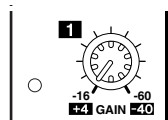

Inputs 1 through 16 feature rotary gain controls that adjust input sensitivity. Input sensitivity for INPUT connectors 1–12 ranges from –16 dB to –60 dB when the Pad is off, and from +4 dB to –40 dB when the Pad is on. Input sensitivity for INPUT connectors 13–16 ranges from +4 dB to –26 dB.

- **PEAK & SIGNAL Indicators**

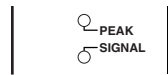

The SIGNAL indicator lights up when the input signal level at INPUTs 1–16 exceeds –34 dB. The PEAK indicator lights up when the input signal level is 3 dB below clipping.

- **2TR IN connectors**

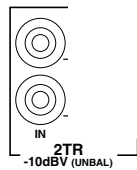

These unbalanced RCA phono connectors accept line-level signals from master recorders.

When the AD 15/16 source selector is turned on (pushed in), signals input at these conductors are routed to AD Inputs 15 and 16. When the Monitor source selector is turned on (pushed in), you can monitor these signals from the MONITOR OUT connectors.

Output Section

The 01V96 top and rear panels feature output connectors that enable you to connect a monitoring system, master recorder, effects processors and other line-level devices.

- **MONITOR OUT connectors L/R**

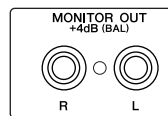

These balanced TRS-type phone connectors output monitoring signals or input signals routed from the 2TR IN connectors. The nominal output level is +4 dB.

Use the Monitor source selector in the AD Input section to select the signal output from these connectors.

- **OMNI OUT connectors 1–4**

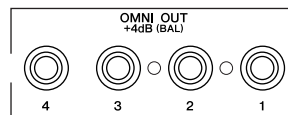

These balanced TRS-type phone connectors output any Bus Outs or Input Channel Direct Outs. The nominal output level is +4 dB.

Tip: Any signal path can be patched to the OMNI OUT connectors. (See page 124 for more information on patching signals to the OMNI OUT connectors.)

- **STEREO OUT connectors L/R**

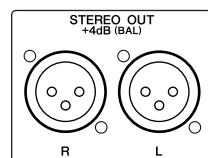

These balanced XLR-3-32-type connectors output the Stereo Out signals. The nominal output level is +4 dB.

- **2TR OUT connectors**

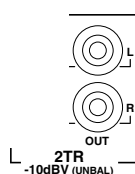

These unbalanced RCA phono connectors output line-level signals to a connected master recorder or other external device. These connectors always output the Stereo Out signals.

Digital Inputs & Outputs

The 01V96 rear panel features digital input and output connectors that enable you to connect external digital devices. Any signal path can be patched to these digital inputs and outputs.

You can also add analog and digital I/Os by installing an optional I/O card in the slot.

Digital I/O Connectors

- **2TR IN DIGITAL connector**



2TR IN DIGITAL is an RCA phono connector and accepts consumer format (IEC-60958) digital audio. You can patch digital signals input at this connector to any Input Channel (page 121).

- **2TR OUT DIGITAL connector**



This RCA phono connector outputs consumer format (IEC-60958) digital audio. You can patch any Bus outs or Input channel Direct Outs to this output (page 125).

- **ADAT IN connector**

This TOSLINK connector accepts 8-channel ADAT optical format signals, which can be patched to any Input Channel (page 121).

- **ADAT OUT connector**

This TOSLINK connector outputs an 8-channel ADAT optical format signal. You can patch any Bus Outs or Input Channel Direct outs to this output (page 123).

SLOT

This slot allows you to install an optional mini-YGDAI (Yamaha General Digital Audio Interface) I/O card. This card offers AD/DA conversion, and various analog I/O options and digital I/O interfaces in all the popular digital audio interconnect formats, including AES/EBU, ADAT, and Tascam. You can patch signals input at these card connectors to any Input Channels or Insert Ins (see page 122).

You can patch the card outputs to Bus Outs or Input Channel Direct Outs (see page 125).

The following mini-YGDAI I/O cards are currently available.

Card	Format	In	Out	Resolution/Sampling Rate	Connectors
MY8-AD	Analog in	8	—	20-bit, 44.1/48 kHz	Phone jack (balanced) x8
MY8-AD24 ¹				24-bit, 44.1/48 kHz	
MY4-AD				4	XLR-3-31 type (balanced) x4
MY8-AD96		8		24-bit, 44.1/48/88.2/96 kHz	D-sub 25-pin
MY4-DA	Analog out	—	4	20-bit, 44.1/48 kHz	XLR-3-32 type (balanced) x4
MY8-DA96				8	D-sub 25-pin
MY8-ADDA96	Analog in/out	8	8	24-bit, 44.1/48/88.2/96 kHz	Euroblock x4
MY8-AE ²	AES/EBU I/O	8	8	24-bit, 44.1/48 kHz	D-sub 25-pin
MY16-AE ²		16	16		
MY8-AEB		8	8		BNC connector x8

Card	Format	In	Out	Resolution/Sampling Rate	Connectors
MY8-AE96	AES/EBU I/O	8	8	24-bit, 44.1/48/88.2/96 kHz	D-sub 25-pin
MY8-AE96S ³					
MY8-AT ²	ADAT I/O	8	8	24-bit, 44.1/48 kHz	Optical x2
MY16-AT ²		16	16		Optical x4
MY8-TD ²	Tascam	8	8		D-sub 25-pin BNC wordclock output
MY16-TD ²		16	16		D-sub 25-pin
MY8-mLAN ²	IEEE1394	8	8		6-pin 1394 connector x2
MY16-mLAN ²		16	16		
WAVES Y56K	ADAT	8	8	24-bit, 44.1/48 kHz	Optical x2
WAVES Y96K				24-bit, 44.1/48/88.2/96 kHz	

1. This card is a substitution for a 20-bit MY8-AD card.
2. These cards support 24-bit/96 kHz in Double Channel mode. (Separate 96 kHz wordclock required.)
3. This card is identical to the MY8-AE96, except that it features a sampling rate converter.

See the Yamaha Professional Audio Web site at the following URL for up-to-date news on I/O cards:

<<http://www.yamahaproaudio.com/>>.

Converting Sampling Rates of Signals Received at I/O Card Inputs

An optional MY8-AE96S Digital I/O card features sampling rate converters, so you can easily convert the sampling frequency of digital inputs to the current 01V96 sampling rate.

- 1 Press the **DISPLAY ACCESS [DIO/SETUP]** button repeatedly until the **DIO/Setup | Format page** appears.

Use the buttons in the SRC sections to turn the sampling rate converters on and off. You can turn the sampling rate converters of the digital I/O card on or off in pairs (odd & even channels, in this order).

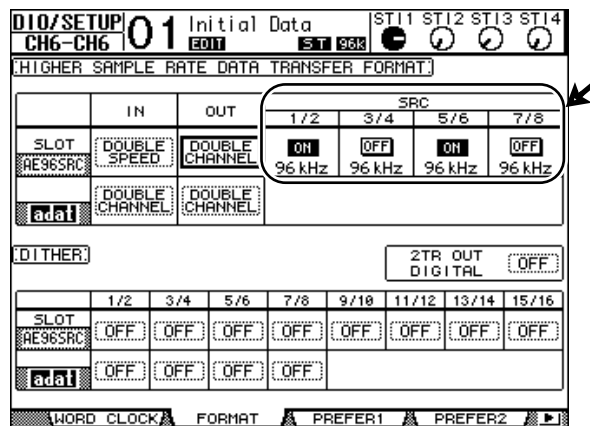

Tip: The FS box on the Word Clock page displays the sampling frequency at which the 01V96 is currently operating.

Note: The sampling rate converter is available only on the Yamaha MY8-AE96S Digital I/O card. If you have installed another type of I/O card in the slot, or if no card is installed in the 01V96, the buttons in the SRC sections are disabled.

- 2 Use the cursor buttons to move the cursor to any two-channel button in the SRC sections, then press [ENTER].

The sampling rate converter for the selected 2-channel input turns on or off. When on, the sampling rate of the received digital audio is converted to the 01V96's current sampling rate.

Monitoring Digital Input Channel Status

You can view and monitor the Channel Status (sampling rate, emphasis, etc.) of digital audio signals connected to the 2TR Digital Inputs and Slot Inputs as follows.

- 1 Press the DISPLAY ACCESS [UTILITY] button, then press the [F2] button.

The Utility / CH Status page appears.

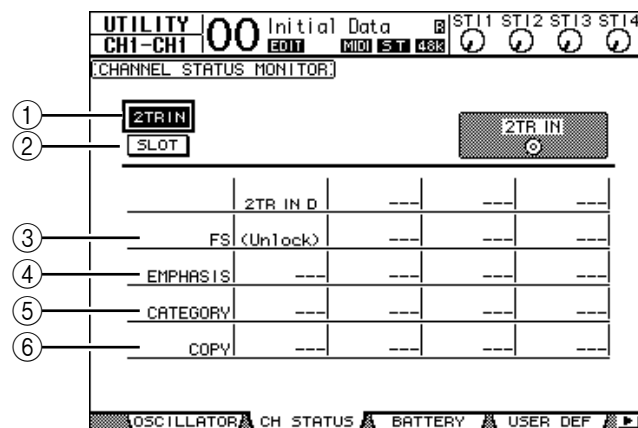

On this page, use the following buttons to select a slot or connector for which you want to view the channel status.

- 1 **2TR IN**

This button enables you to view the Channel Status of input signals connected to the 2TR Digital Inputs.

- 2 **SLOT**

These buttons enable you to view the Channel Status of each two adjacent (odd and even, in this order) channel signals connected to the digital I/O card installed in the slot.

- 2 Move the cursor to the desired input or slot button, then press [ENTER].

Channel Status information for the selected input is displayed. However, if a mini-YGDAI I/O card other than AES/EBU format is installed, Channel Status information will be grayed out. Channel Status information includes the following items:

- 3 **FS**

Indicates the sampling rate. If no signal is being input, or if the incoming wordclock is not syncing to the internal clock, "Unlock" appears.

- 4 **EMPHASIS**

Indicates the Emphasis on/off status.

- 5 **CATEGORY**

Indicates the status of "Category Code Bit" included in the IEC958 Part 2 (S/PDIF-Consumer) format. This parameter can display the following values:

Parameter value	Description
General	Temporarily used
Laser Optical	Laser optical device
D/D Conv	Digital - Digital converter and signal processing device

Parameter value	Description
Magnetic	Magnetic tape device and magnetic disk device
D.Broadcast	Digital broadcast reception
Instruments	Musical instrument, microphone, and sources that generate string signals
A/D Conv	A/D converter (without copyright information)
A/D Conv with (C)	A/D converter (with copyright information)
Solid Memory	Solid memory device
Experimental	Experimental device
Unknown	Unknown

Note: “AES/EBU” appears in the Category row when you are monitoring IEC958 Part 3 (AES/EBU-Professional) format signals (that do not include Category Code Bit).

⑥ COPY

Indicates the status of copy protection information included in the IEC958 Part2 (S/PDIF-Consumer) format signals. “OK” appears if copying is allowed. “Prohibit” appears if copy-protected.

- 3 If you select the SLOT button for a slot that has an MY16-AE card installed, use the 01–08 and 09–16 buttons located in the lower-right corner of the screen to select a channel group you wish to display.



Dithering Digital Outputs

When digital audio is transferred to lower-resolution systems, truncated bits may generate unpleasant noise. To cancel the audible effect of this noise, a small complement of noise is intentionally added to the digital outputs. This process is called “dithering.”

On the 01V96, you can dither the 2TR Digital Outputs and Slot Outputs. For example, you can apply dithering to the 01V96 stereo mix data and record to a 16-bit DAT recorder.

- 1 Press the DISPLAY ACCESS [DIO/SETUP] button repeatedly until the DIO/Setup | Format page appears.

The dithering settings are displayed at the bottom of the page.

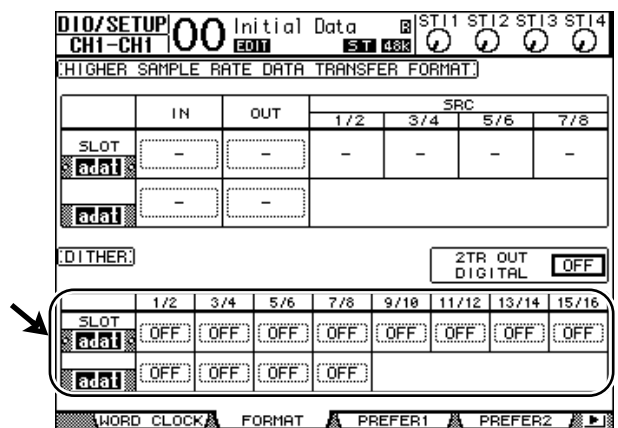

- 2 Move the cursor to the output or channel to which you want to apply dithering, then rotate the Parameter wheel or press the [INC]/[DEC] buttons to select the value that matches the resolution of the receiving device.

Note:

- You cannot apply dithering to outputs or channels that are set to “OFF.”
- Dithering is effective only when the resolution of the receiving device is lower than that of the 01V96.

Tip: To copy the currently-selected setting to all channels, double-click the [ENTER] button. The copy confirmation window is displayed.

Setting the Transfer Format for Higher Sampling Rates

To operate the 01V96 at higher sampling frequencies (88.2 kHz or 96 kHz) and transfer digital audio signals to and from connected external devices, you must set the data transfer format in accordance with the sampling frequencies supported by the external devices.

- 1 Press the DISPLAY ACCESS [DIO/SETUP] button repeatedly until the DIO/Setup | Word Clock page appears.
- 2 Select INT88.2k or INT96k as the wordclock source.

Note: When the 01V96 operates at a high sampling rate (88.2 kHz or 96 kHz), only two internal effects processors are available.

- 3 Press the DISPLAY ACCESS [DIO/SETUP] button repeatedly until the DIO/Setup | Format page appears.

DIO/SETUP		Initial Data		ST11	ST12	ST13	ST14
CHI-CHI 00		edit ST 488					
HIGHER SAMPLE RATE		TE DATA TRANSFER FORMAT					
	IN	OUT	SRC				
			1/2	3/4	5/6	7/8	
SLOT	-	-	-	-	-	-	-
adat	-	-					
adat	-	-					
DITHER:		2TR OUT DIGITAL OFF					
	1/2	3/4	5/6	7/8	9/10	11/12	13/14
SLOT	OFF	OFF	OFF	OFF	OFF	OFF	OFF
adat	OFF	OFF	OFF	OFF			
adat	OFF	OFF	OFF	OFF			
WORD CLOCK		FORMAT		PREFER1		PREFER2	

- 4 Use the cursor buttons to move the cursor to an IN/OUT parameter field (①), then rotate the Parameter wheel or press the [INC]/[DEC] buttons to set the data transfer format.

The IN/OUT parameters are used to set one of the following data transfer formats for each slot input and output.

- **DOUBLE CHANNEL**

In Double Channel mode, digital audio data is received and transmitted as mono signals at a sampling rate that is exactly half (44.1/48 kHz) the current higher sampling rate. Data is handled by two channels. This is useful when you wish to transfer data between the 01V96 running at a higher sampling rate and legacy 44.1/48 kHz digital MTRs or HDRs.

Note: *Double Channel mode reduces the total number of inputs or outputs on the corresponding slot. The even-numbered channels are disabled.*

- **DOUBLE SPEED**

In Double Speed mode, digital audio data is received and transmitted at the current high sampling rate (i.e., 88.2 kHz or 96 kHz). Select this mode if the devices that support the higher sampling rates transmit or receive data.

Note: *You can select this setting only for slots in which a digital I/O card that inputs/outputs double-speed digital audio data (e.g., MY8-AE96, MY8-AE96S) is installed.*

- **SINGLE**

In Single mode, digital audio data is received and transmitted at a sampling rate that is half (44.1/48 kHz) the current higher sampling rate of the 01V96. For example, this is useful when you wish to send 44.1 kHz digital signals from an external HDR to the 01V96 running at 88.2 kHz.

Note: *You cannot select this setting for slots in which a digital I/O card that inputs/outputs double-speed digital audio data (e.g., MY8-AE96, MY8-AE96S) is installed.*

Tip: *The parameter fields display “–” if the slot contains no I/O card or if an AD/DA card or other I/O card that does not allow you to set the transfer format has been installed.*

7 Input Channels

This chapter describes how to adjust the 01V96's Input Channel parameters.

About Input Channels

The input Channel section enables you to adjust the level and tone of the signals input to the 01V96 (and the signals output from the internal Effects processors 1–4), and route the signals to Buses 1–8, the Stereo Bus, and Aux Sends 1–8. There are two types of Input Channels, each featuring slightly different functions: monaural Input Channels 1–32 and stereo ST IN Channels 1–4.

Input Channels 1–32

Each of these monaural Input Channels features a phase effect, gate, compressor, attenuator, and EQ for signal processing. The following diagram illustrates the Input Channel 1–32 signal flow.

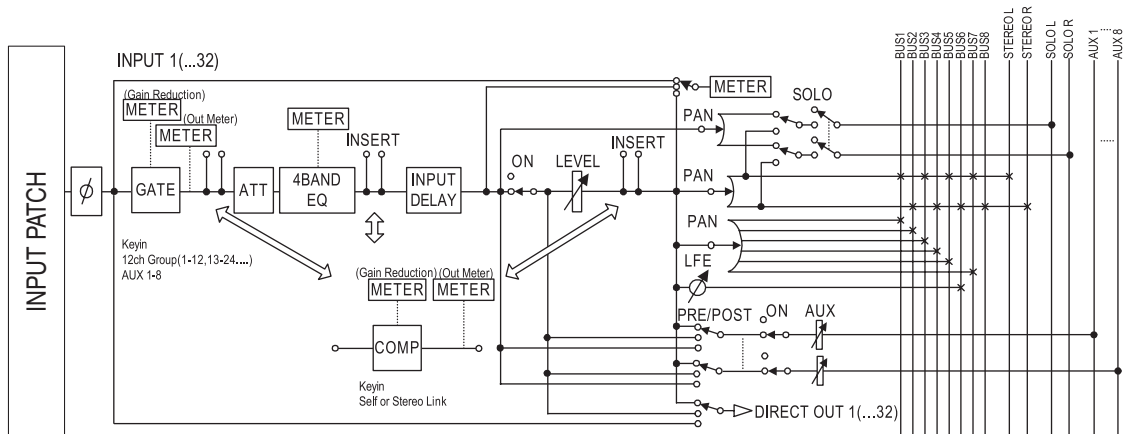

Input Channels 1–32 feature the following parameters:

- φ (Phase)**
 This section switches the phase of input signals.
- GATE**
 This dynamics processor can be used as a gate or for ducking.
- COMP (Compressor)**
 This dynamics processor can be used as compressor, expander or limiter. The compressor can be pre-EQ, pre-fader, or post-fader.
- ATT (Attenuator)**
 This section enables you to attenuate or amplify the level of signals that will be input to the EQ. The attenuator enables you to prevent post-EQ signals from clipping and to correct signal levels that are too low.
- 4 BAND EQ (4-band equalizer)**
 This parametric EQ features four bands (high, high-mid, low-mid, and low).
- INPUT DELAY (Input delay)**
 This section enables you to delay input signals. You can use this delay to fine-tune the timing between channels, or as a delay effect with feedback.

- **ON (On/Off)**
This section enables you to turn the channel on or off. The channel is muted with the Off setting.
- **LEVEL**
This section enables you to adjust the input level of the Input Channel signal.
- **PAN**
This section enables you to adjust the pan setting of the signals routed from the Input Channels to the Stereo Bus. You can also apply the pan setting to a pair of Bus channels.
- **AUX (Aux Send level)**
This section enables you to adjust the level of signals routed to Aux Sends 1–8. The signals can be routed to Aux Sends from either the pre-fader or post-fader position.
- **INSERT**
This section enables you to patch input signals to external devices via the on-board I/O connectors or I/O card, or insert the internal effect processors. You can patch any inputs, outputs, or I/O card channels. (Note that this is different from the INSERT I/O connectors in the AD Input section.)
- **METER**
This section enables you to switch the metering position of the signal levels that are displayed in the Meter page. (See page 34 for more information on selecting the metering position.)

ST IN Channels 1–4

These stereo channels enable you to process stereo signals using the phase effect, attenuator, and EQ. The following diagram illustrates the ST IN Channel 1–4 signal flow.

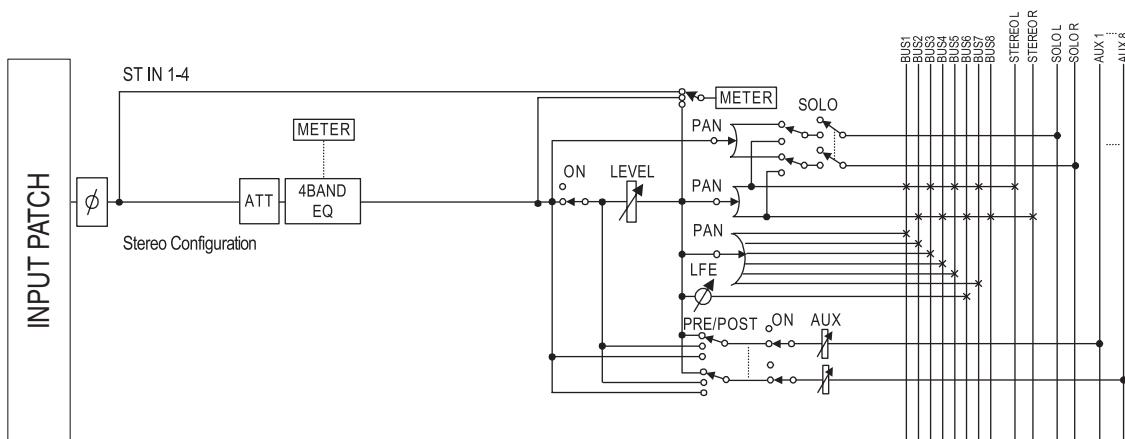

ST IN Channels 1–4 feature the following parameters:

- **φ (Phase)**
- **ATT (Attenuator)**
- **4 BAND EQ (4-band equalizer)**
- **ON (On/Off)**
- **LEVEL**
- **PAN**
- **AUX (Aux Send level)**
- **METER**

Refer to the description of Input Channels for more information on these parameters (page 77).

Tip: You can store these channel parameter settings in the Channel library. You can also store the Gate, Compressor, and EQ parameter settings to the corresponding libraries.

Setting the Input Channels from the Display

To set the Input Channel parameters, you can either move the cursor to the desired parameter on the display and change the value, or operate the desired button or control on the top panel to directly change the setting.

This section explains how to set the parameters via the display.

Switching the Signal Phase

To switch the phase of each Input Channel, press the [ϕ /INSERT/DELAY] button repeatedly until the following ϕ /INS/DLY | Phase page appears.

Move the cursor to the NOR/REV button of the channel for which you want to change the phase, then press the [ENTER] or [INC]/[DEC] buttons to change the setting.

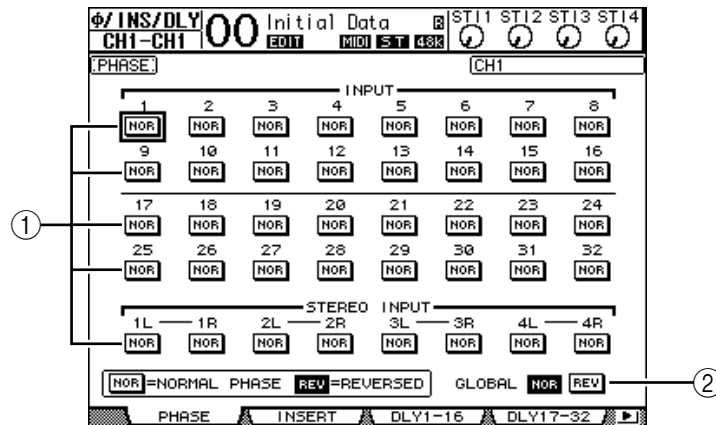

① NOR/REV

These buttons switch the corresponding Input Channel phase. NOR buttons indicate normal phase, and REV buttons indicate reversed phase.

② GLOBAL

The GLOBAL NOR/REV buttons allow you to set the phase for all Input Channels simultaneously.

Tip:

- The name of the currently-selected channel is indicated in the upper-right corner of the screen.
- You can set the phase separately for each of the ST IN Channels or for each channel in a channel pair. If you selected the desired ST IN Channel using the corresponding [SEL] button, pressing the same [SEL] button repeatedly will toggle between channels L and R.

Delaying Input Channels

To set the delay for each channel, press the [ϕ /INSERT/DELAY] button repeatedly until the page listed below that contains the desired channels appears.

- **DLY 1-16 page**
This page enables you to set the Delay function for Input Channels 1–16.
- **DLY 17-32 page**
This page enables you to set the Delay function for Input Channels 17–32.

The parameters on these two pages (and the procedure for setting them) are the same.

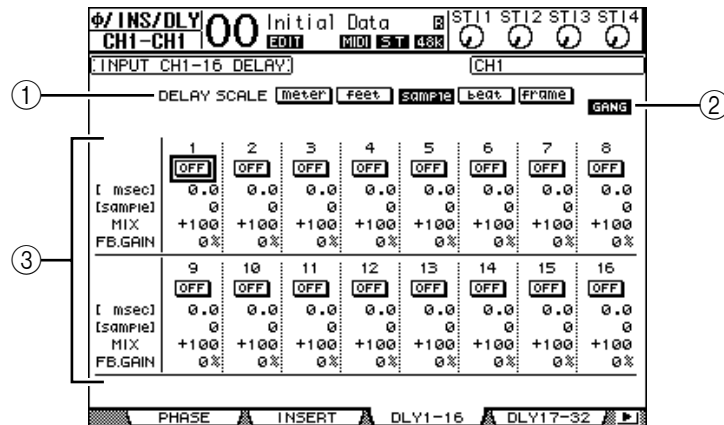

① DELAY SCALE

The following buttons determine the units of the delay value shown below the msec value.

- **meter** Units are set to meters.
- **feet** Units are set to feet.
- **sample** Units are set to samples.
- **beat** Units are set to beats.
- **frame** Units are set to timecode frames.

② GANG button

When this button is turned on (highlighted), the delay time for each channel in a channel pair can be set simultaneously. When this option is turned off, the delay time can be set for each channel in a channel pair individually.

③ Channel section

You can set individual delay parameters here. The delay parameters include the following items:

- **ON/OFF** This button switches the corresponding channel delay on or off.
- **msec** This parameter sets the delay time in milliseconds.
- **meter/feet/sample/beat/frame** The delay time can be set using units of meters, feet, samples, beats, or frames, which you select by using the DELAY SCALE buttons.
- **MIX** This parameter sets the mix balance of dry (Input Channel) and wet (delayed) signals.
- **FB.GAIN** This parameter sets the amount of delay feedback.

Tip:

- This function is unavailable for the ST IN Channels.
- The delay time range depends on the sampling rate at which the 01V96 is operating. (For example, at 44.1 kHz, the range is 0 through 984.1 msec.)
- If you select the DELAY SCALE meter or feet button, the distance value can be converted to the delay time based on sonic speeds (about 340 m/sec at 15 degrees Celsius). This option is useful if you wish to correct the timing difference between two sound sources that are far apart.
- If you select the DELAY SCALE beat button, a parameter box for setting a note that represents the beat and a parameter box for a tempo (BPM) setting appear below the DELAY SCALE parameter. Setting the note and BPM settings in these parameter boxes enables you to set a delay time that synchronizes to the song tempo.

Gating Input Channels

To set the Input Channel gates, use the [SEL] buttons to select the desired Input Channel, then press the DISPLAY ACCESS [DYNAMICS] button, then press the [F1] button. The Dynamics | Gate Edit page appears.

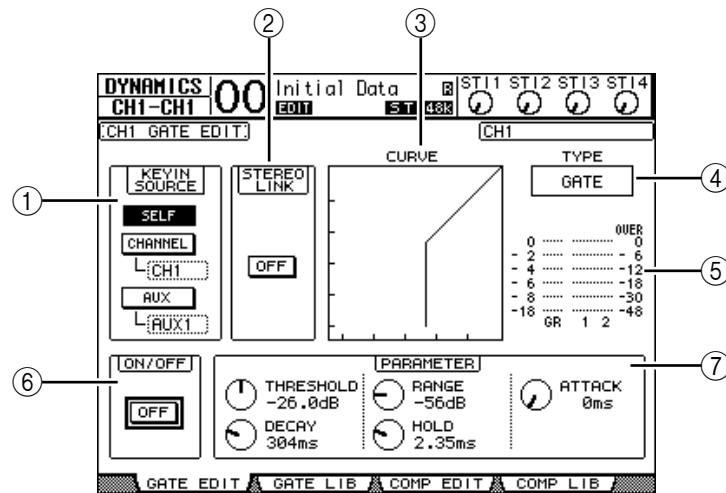

① KEYIN SOURCE

Select one of the following buttons to determine the trigger source for the currently-selected Input Channel's gate.

- **SELF**The selected channel's own input signal is the trigger source.
- **CHANNEL**Another Channel's input signal is the trigger source. Select the desired channel in the parameter box below the CHANNEL button.
- **AUX**.....An Aux Send signal is the trigger source. Select the desired bus in the parameter box below the AUX button.

② STEREO LINK

This parameter's ON/OFF button enables you to pair gates for stereo operation even when the Input Channels are not paired.

③ CURVE

This area displays the current gate curve.

④ TYPE

This area displays the current gate type (GATE or DUCKING).

Note: You cannot change the gate type on this page. To change the gate type, recall a program that uses the desired gate type from the Gate library.

⑤ **Meters**

These meters indicate the levels of the post-gate signals and the amount of gain reduction.

⑥ **ON/OFF**

The ON/OFF button turns the currently-selected Input Channel’s gate on or off.

⑦ **PARAMETER**

These controls enable you to set the gate parameters. (See page 272 for more information on the parameters.)

Tip:

- This function is unavailable for the ST IN Channels.
- You can store the gate settings in the Gate library, which features preset programs that can be used for various applications (see page 183).

Compressing Input Channels

To set the Input Channel compressors, use the [SEL] buttons to select the desired Input Channel, then press the DISPLAY ACCESS [DYNAMICS] button, then press the [F3] button to display the Dynamics | Comp Edit page.

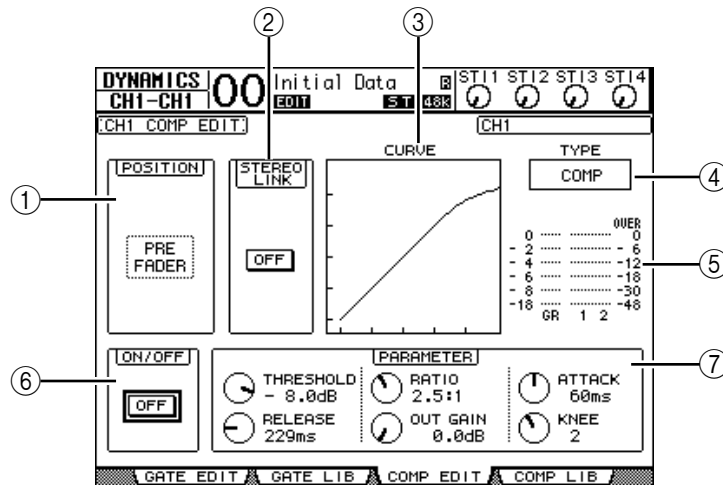

① **POSITION**

Use the Parameter wheel, or the [INC]/[DEC] buttons to select the position of the compressor within the channel from the following options:

- **PRE EQ**..... Immediately before EQ (default)
- **PRE FADER**..... Immediately before the fader
- **POST FADER**..... Immediately after the fader

② **STEREO LINK**

This ON/OFF button enables you to pair compressors for stereo operation even when channels are not paired.

③ **CURVE**

This area displays the current compressor curve.

④ **TYPE**

This field indicates the compressor type used by the currently-selected channel’s compressor (COMP/EXPAND/COMP (H)/COMP (S)).

Note: You cannot change the Compressor type on this page. To change the compressor type, recall a program that uses the desired compressor type from the compressor library.

⑤ **Meters**

These meters indicate the levels of the post-compressor signals and the amount of gain reduction.

⑥ **ON/OFF**

The ON/OFF button turns the currently-selected Input Channel's compressor on or off.

⑦ **PARAMETER section**

These controls enable you to set the compressor parameters. (See page 273 for more information on the parameters of each compressor type.)

Tip:

- This function is unavailable for the ST IN Channels.
- You can store the compressor settings in the compressor library, which features preset programs that can be used for various applications (see page 185).

Attenuating Input Channels

To set the attenuator for each Input Channel, press the DISPLAY ACCESS [EQ] button, then press the [F3] button to display the EQ | In Att page.

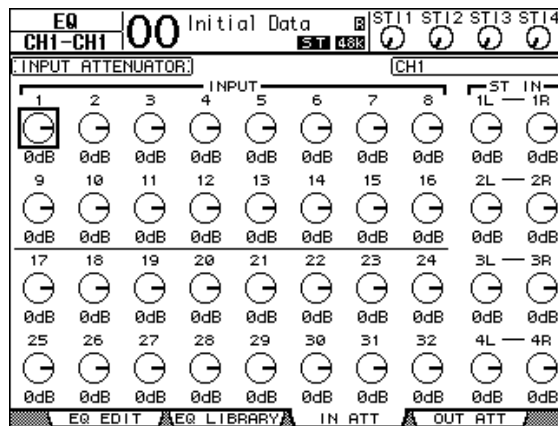

Move the cursor to the knob for the desired Input Channel, then rotate the Parameter wheel to set the amount of attenuation in the range of -96 dB to $+12$ dB.

Tip: You can also set the attenuation amount (in dB) for the currently-selected channel on the EQ | EQ Edit page.

EQ'ing Input Channels

The 01V96's Input Channels feature 4-band (LOW, LOW-MID, HIGH-MID, HIGH) parametric EQ. The LOW-MID and HIGH-MID bands are a peaking type of EQ. The LOW and HIGH bands can be set to shelving, peaking, or HPF and LPF respectively.

- 1 Press the [SEL] button of the channel for which you want to adjust EQ.
- 2 Press the DISPLAY ACCESS [EQ] button, then press the [F1] button to display the EQ | EQ Edit page.

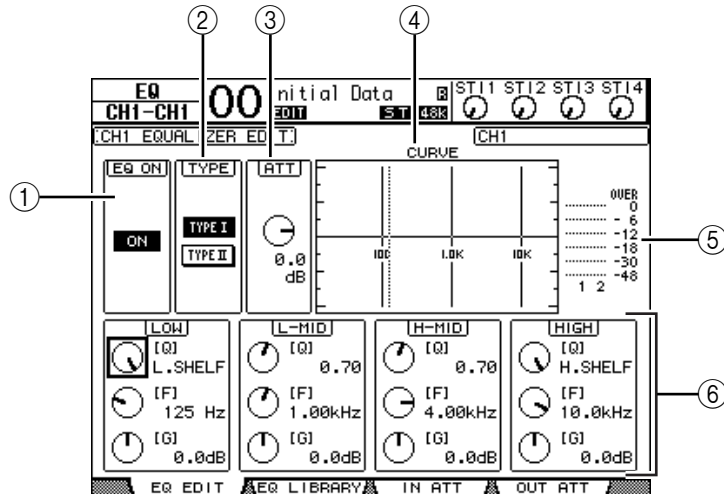

The parameters on this page are described below:

- ① **EQ ON**
The ON/OFF button turns the currently-selected Input Channel's EQ on or off. You can press the [ENTER] button to turn the EQ on or off as long as the cursor is located on any parameter other than TYPE.
- ② **TYPE**
Selects the type of EQ. TYPE I is the EQ type used on legacy Yamaha 02R series digital mixing consoles. TYPE II is a newly developed algorithm.
- ③ **ATT**
Determines the amount of pre-EQ signal attenuation in dB. It is the same Attenuator parameter that appears on the EQ | ATT In page.
- ④ **CURVE**
This area displays the current EQ curve.
- ⑤ **Meters**
These meters indicate the post-EQ signal levels of the currently-selected Input Channel and its available pair partner.
- ⑥ **LOW, L-MID, H-MID, HIGH sections**
These sections contain the Q, Frequency (F), and Gain (G) parameters for the four bands. These parameter values range as follows:

Parameter	LOW	LOW-MID	HIGH-MID	HIGH
Q	HPF, 10.0 to 0.10 (41 steps), L.SHELF	10.0 to 0.10 (41 steps)		LPF, 10.0 to 0.10 (41 steps), H.SHELF
Frequency	21.2 Hz to 20.0 kHz (120 steps per 1/12 octave)			
Gain	-18.0 dB to +18.0 dB (0.1 dB steps) ¹			

1. The LOW and HIGH GAIN controls function as filter on/off controls when Q is set to HPF or LPF respectively.

Tip:

- The LOW-band EQ functions as a high-pass filter when the Q parameter in the LOW section is set to HPF. It functions as a shelving-type EQ when the Q parameter is set to L.SHELF.
- The HIGH-band EQ functions as a low-pass filter when the Q parameter in the HIGH section is set to LPF. It functions as a shelving-type EQ when the Q parameter is set to H.SHELF.

3 Move the cursor to the desired parameter, then rotate the Parameter wheel to change the value.

Tip:

- The EQ settings for the ST IN Channels L & R are linked to each other.
- You can also press the buttons in the SELECTED CHANNEL section to select the desired band and use the rotary controls to directly edit the Q, F, and G parameters (see page 91).
- You can store the EQ settings in the EQ library, which features preset programs that can be used for various applications (see page 271).

Panning Input Channels

Input Channels can be panned in the range of L63 through CENTER to R63. To pan each channel, press the [PAN/ROUTING] button repeatedly until the Pan/Route | Pan page appears.

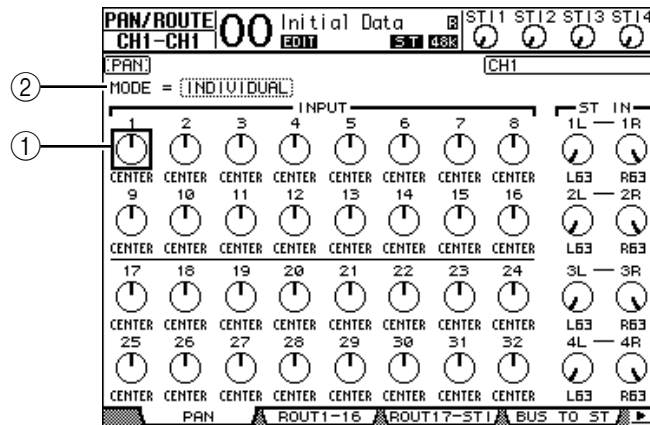

Move the cursor to the desired Pan control, then rotate the Parameter wheel to set the value.

① Pan controls

These knobs adjust the channel pan settings.

Press the [ENTER] button to reset the currently-selected Pan control to center.

② MODE

The MODE parameter determines how paired Input Channels are panned. There are three Pan modes as follows:

- **INDIVIDUAL**.....In Individual mode, paired Input Channel pan controls operate independently.
- **GANG**In Gang mode, paired Input Channel pan controls operate in unison, maintaining the current pan range.
- **INV GANG**.....In Inverse Gang mode, paired Input Channel pan controls operate in unison but move in opposite directions.



Tip:

- You can adjust the pan setting for the ST IN Channels L & R separately.
- You can also adjust the pan setting for the Input Channels using the PAN control in the SELECTED CHANNEL section.
- Surround Pan is available when the 01V96 is in Surround mode. Refer to Chapter 12 for more information on Surround Pan.

Routing Input Channels

You can route each Input Channel to the Stereo Bus, Bus 1–8, or its own Direct Out. With the default setting, signals are routed only to the Stereo Bus. However, you can patch signals to a single or multiple destinations, if necessary.

- 1 Press the **DISPLAY ACCESS [PAN/ROUTING]** button repeatedly until the page listed below that contains the desired channels appears.
 - **ROUT1-16 page**
This page enables you to change the routing for Input Channels 1–16.
 - **ROUT17-ST1 page**
This page enables you to change the routing for Input Channels 17–32 and ST IN Channels 1-4.

The parameters on these two pages (and the procedure for setting them) are the same.

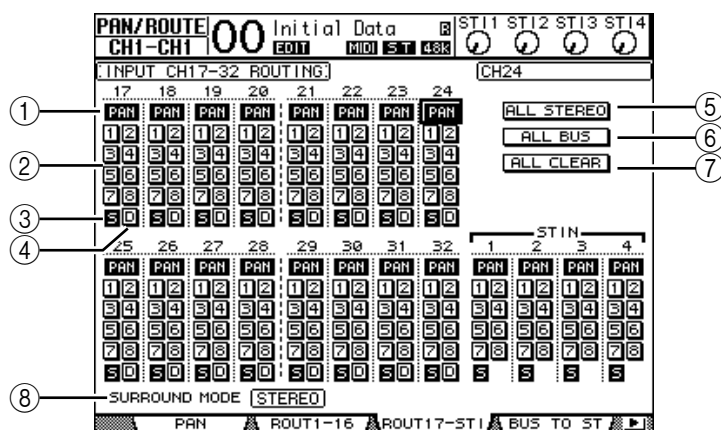

① **PAN buttons**

These buttons determine whether the channel’s Pan setting is applied to the Bus outs. In surround mode, they also determine whether the Surround Pan setting is applied to the Bus Outs.

② **Bus buttons 1–8**

These buttons route the currently-selected Input Channel to the Bus Outs. If the 01V96 is in Surround mode, the button indicators change as follows, depending on the selected Surround mode:

Bus buttons	1	2	3	4	5	6	7	8
Surround mode: 3-1	L	R	C	S	5	6	7	8
Surround mode: 5.1	L	R	Ls	Rs	C	E	7	8
Surround mode: 6.1	L	R	Ls	Rs	C	Bs	E	8

L=Left, R=Right, C=Center, S=Surround, Ls=Left Surround
Rs=Right Surround, E=Low Frequency Effect, Bs=Back Surround

The above table shows the default assignment. The actual assignment may vary, depending on the settings on the DIO/Setup | Surround Bus Setup page.

- ③ **S**
When this button is turned on, the currently-selected Input Channel is routed to the Stereo Bus.
- ④ **D**
When this button is turned on, the currently-selected Input Channel is routed to its Direct Out. See page 125 for more information on the Direct Out.
- ⑤ **ALL STEREO**
This button turns on the S button for all channels on the page.
- ⑥ **ALL BUS**
This button turns on the Bus buttons 1–8 for all channels on the page.
- ⑦ **ALL CLEAR**
This button clears all routing assignments on the page.
- ⑧ **SURROUND MODE**
This field displays the current Surround mode.

Tip: The routings of the ST IN Channels L & R are linked. The D button is unavailable for the ST IN Channels.

Viewing Input Channel Settings

You can view and adjust parameter settings for the currently-selected Input Channel on the View | Parameter or Fader pages.

■ Viewing the Gate, Compressor, and EQ Settings

To display the View | Parameter page for a specific Input Channel, use the corresponding [SEL] button to select the desired channel, then press the DISPLAY ACCESS [VIEW] button repeatedly.

Move the cursor to a parameter you wish to change, then rotate the Parameter wheel or press the [INC]/[DEC] buttons or [ENTER] button to modify the setting.

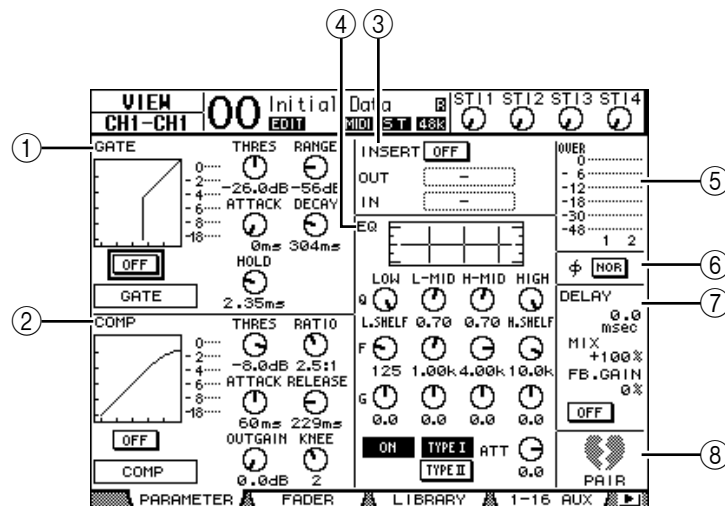

The following parameters are available (sections marked with an asterisk (*) are unavailable for the ST IN Channels).

① **GATE section (*)**

This section enables you to turn the gate-type dynamics processor on or off and set the parameters. (See page 81 for more information.)

- ② **COMP section (*)**
This section enables you to turn the compressor-type dynamics processor on or off and set the parameters. (See page 82 for more information.)
- ③ **INSERT section (*)**
This section enables you to turn the Insert on or off and patch the Insert In and Out. (See page 127 for more information.)
- ④ **EQ section**
This section enables you to set various EQ parameters. (See page 84 for more information.)
- ⑤ **Meters**
These meters indicate the signal levels of the currently-selected Input Channel and its available pair partner.
- ⑥ **∅ (Phase) section**
You can reverse the signal phase of the currently-selected Input Channel. (See page 79 for more information.)
- ⑦ **DELAY section (*)**
This section enables you to set the currently-selected channel's Delay function. (See page 80 for more information.)
- ⑧ **PAIR section (*)**
This section indicates whether or not channels are paired. The heart icon (♥) is in one piece when channels are paired. The heart icon is broken (♥) when channels are not paired. (See page 92 for more information.)

■ **Viewing the Pan, Fader, and Aux Send Level Settings**

To display the View | Fader page of a certain Input Channel, use the corresponding [SEL] button to select the desired channel, then press the DISPLAY ACCESS [VIEW] button repeatedly.

Move the cursor to a parameter you wish to change, then rotate the Parameter wheel or press the [INC]/[DEC] buttons to modify the setting.

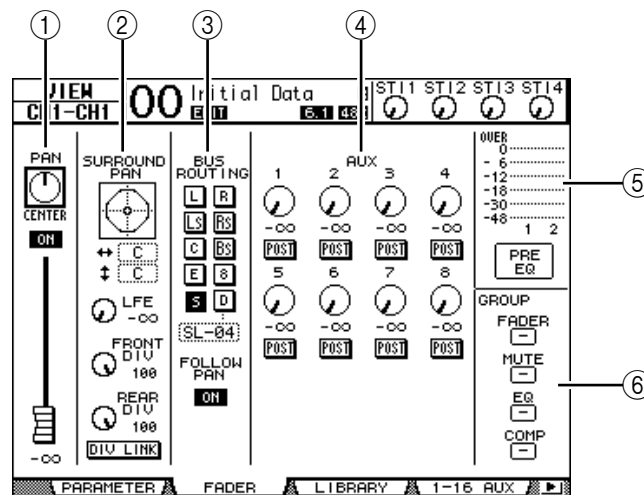

- ① **PAN/ON/Fader section**
 - **PAN control**..... This control adjusts the currently-selected Input Channel's Pan parameter.
Press the [ENTER] button to reset the Pan control to Center.

- **ON/OFF button** This button turns on or off the currently-selected Input Channel.
 - **Fader** This parameter sets the fader position of the currently-selected Input Channel. The fader knob is highlighted when the fader is set to 0.0 dB.
Press the [ENTER] button to reset the Fader to 0.0 dB.
- ② **SURROUND PAN section**
- **SURROUND PAN**..... The Surround pan parameters for the currently-selected Input Channel are displayed only when a Surround mode is selected. See page 135 for more information on Surround pan.
- ③ **BUS ROUTING/FOLLOW PAN section**
- **BUS ROUTING** This section enables you to select a destination Bus for the selected channel. When the D button is turned on, the channel signal is patched to the Direct Out selected in the parameter box below the button. (The D button is unavailable for the ST IN Channels.)
 - **FOLLOW PAN**..... This button determines whether the Input Channel's Pan setting is applied to the paired Bus Outs (Follow Pan function). When the button is turned off, the Follow Pan function is disabled and an identical signal is sent to the paired Bus Outs. In surround mode, it also determines whether the Surround Pan setting is applied to the Bus Outs.
- ④ **AUX section**
- **AUX**..... These controls set the currently-selected Input Channel's Aux Send 1–8 levels and positions. (See page 109 for more information on Aux Sends.)
- ⑤ **Meter section**
- **Meters** These meters indicate the levels of the currently-selected Input Channel.
 - **PRE EQ/PRE FADER/POST FADER** The metering position is displayed below the meters.
- ⑥ **GROUP section**
- **FADER/MUTE/EQ/COMP** These buttons indicate which Fader, Mute, EQ, or Comp group, if any, the currently-selected Input Channel is in. If the channel is in a group, the group number appears. If the channel is not in a group, “—” appears. (The compressor is unavailable for the ST IN Channels.)

Setting the Input Channels from the Control Surface

You can use the faders, [SEL] buttons, and various buttons and controls in the SELECTED CHANNEL section on the top panel to directly control most parameters for Input Channels.

Setting Input Channel Levels and Panning the Channels

■ Input Channels 1–32

- 1 Press the LAYER [1–16] or [17–32] button to select a layer.
- 2 Press the [SEL] button of the channel for which you want to adjust the input level and/or pan settings.
- 3 Use the faders to set the Input Channel levels.
- 4 Rotate the SELECTED CHANNEL [PAN] control to adjust the pan settings.

When you rotate the [PAN] control, the Pan/Route | Pan page is displayed automatically.

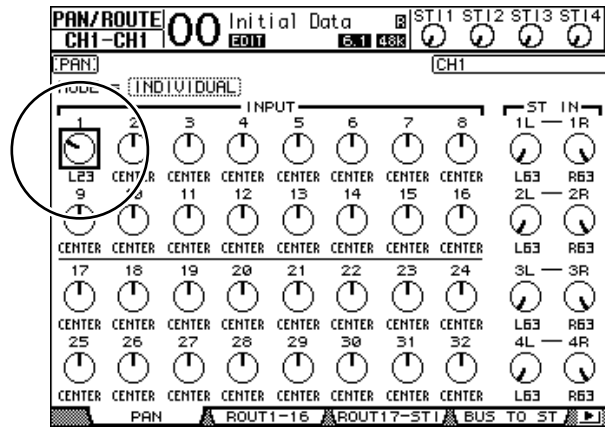

■ ST IN Channels 1–4

- 1 Use the ST IN [ST IN] button to select the desired ST IN Channels.
The indicators next to the [ST IN] button display the ST IN Channels currently selected for control by the ST IN section.
- 2 Press the [SEL] button for the channel for which you want to adjust the level and/or pan settings.
- 3 Rotate the level control of the desired channel to set the level.

You can always view the current channel level at the top of the display.

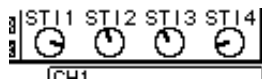

- 4 Rotate the SELECTED CHANNEL [PAN] control to adjust the pan setting.

The pan setting can be applied to either ST IN channel L or R. To switch between channels L and R for the pan setting, press the same [SEL] button repeatedly. (The channel currently being controlled is indicated in the upper-left corner of the display.)

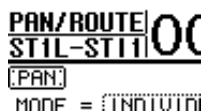

EQ'ing Input Channels

- 1 Press the [SEL] button or move the fader for the channel you wish to control.
- 2 To control EQ for the currently-selected channel, press one of the following buttons to select the band you wish to adjust:
 - [HIGH] button.....HIGH band
 - [H-MID] button.....HIGH-MID band
 - [L-MID] button.....LOW-MID band
 - [LOW] buttonLOW band
- 3 Use the SELECTED CHANNEL [Q], [FREQUENCY], and [GAIN] controls to adjust the Q, frequency, and gain of the band selected in Step 2.

When the Auto EQUALIZER Display (page 231) check box is on, the 01V96 displays the EQ/EQ Edit page.

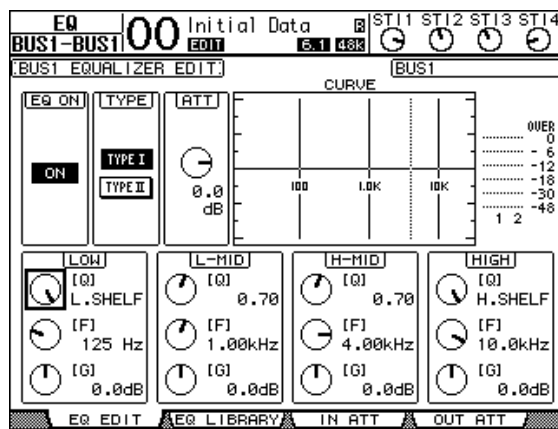

If the check box is off, the parameter value currently being adjusted pops up.

See page 84 for more information on EQ.

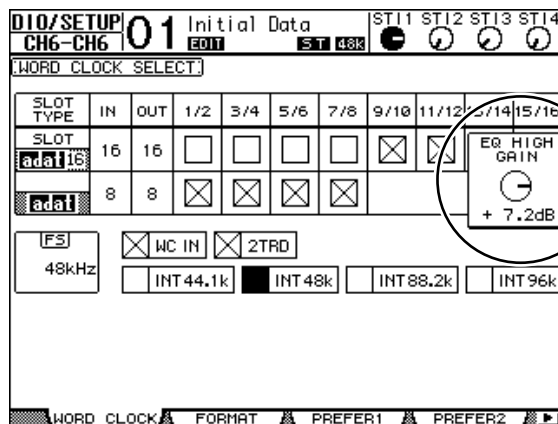

Tip:

- Pressing and holding down the button selected in Step 2 resets the corresponding band gain.
- Pressing the SELECTED CHANNEL [HIGH] and [LOW] buttons simultaneously resets the Q, frequency and gain for each band.

Pairing Input Channels

On the 01V96, you can pair adjacent odd-even Input Channels or counterpart channels on Layer 1 and Layer 2 that share the same physical fader. Faders and most parameters of paired channels are linked for stereo operation. Paired channels' linked parameters and non-linked parameters (that are available for independent control) are listed below:

Linked parameters	Non-linked parameters
[SEL] buttons	Input patches
Faders	Insert patches
Channel on/off	Output patches
Insert on/off	Comp insert position
Solo on/off	Phase
Solo Safe	Delay on/off
Aux on/off	Delay time *
Aux Send level	Delay feedback
Aux Sends as Pre or Post	Delay mix
Gate	Routing
Comp settings	Pan, Follow Pan
EQ settings	Surround pan
Fader group	Aux Send pan
Mute group	Balance
Fade time	Attenuators **
Recall Safe	

* You can set this parameter for each channel independently if the GANG button is turned off on the ϕ /INS/DLY | DLY page.

** You can set this parameter for each channel independently on the EQ | ATT page, but the paired channel settings are linked on the EQ | Edit and View pages.

Note: You cannot pair an ST IN channel 1–4 with an Input Channel.

To pair channels, or to cancel channel pairs, you can use the [SEL] buttons on the top panel or access the Pair/Grup pages.

■ Pairing Channels by Using the [SEL] Buttons

- 1 While pressing and holding down the [SEL] button for one of the channels you wish to pair, press the [SEL] button for the adjacent channel. (The paired channel numbers should be odd and even in this order).

When the Pair Confirmation check box is on, the Channel Pairing window appears.

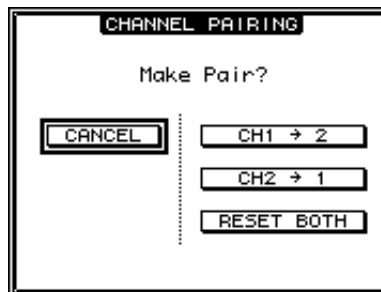

Note: You can pair only channels that are adjacent, odd-even (in this order) channels. Pressing the [SEL] button for a non-adjacent channel will be ignored. You cannot create or cancel a pair of vertical partners.

2 Move the cursor to the desired button in the Channel Pairing window, then press [ENTER].

The following buttons are available in this window:

- **CANCEL**
Cancels the operation.
- **CH x → y**
Copies the odd channel parameter values to the even channel.
- **CH y → x**
Copies the even channel parameter values to the odd channel.
- **RESET BOTH**
Resets both channel parameters to the default settings (same as when Channel memory #01 is recalled).
Move the cursor to the desired button, then press [ENTER] to confirm the pair.

Tip: Pressing and holding down the first [SEL] button of the paired channels and pressing the second [SEL] button cancels the pair.

■ Pairing Input Channels Using the Display

1 Press the [PAIR/GROUP] button repeatedly until the Pair/Grup | Input page appears.

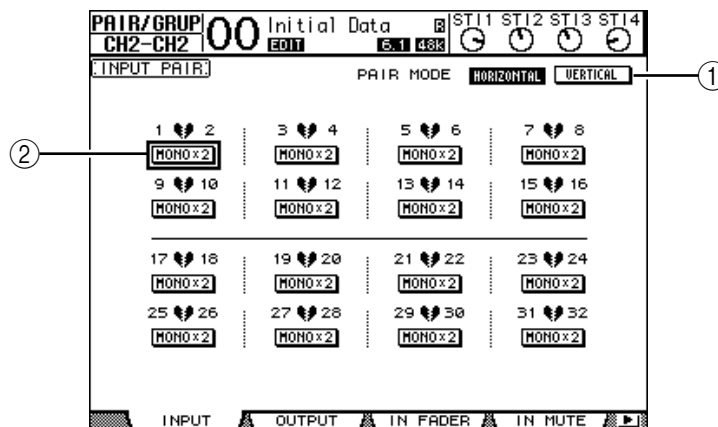

The parameters on this page are described below:

- ① **PAIR MODE**
Determines how channels are paired.
- ② **STEREO/MONO x2 buttons**
These buttons turn pairs on or off.

2 Move the cursor to the PAIR MODE parameter field (①), then select the HORIZONTAL or VERTICAL button.

The function of each mode is described below:

- **HORIZONTAL**.....This button pairs adjacent odd-even channels (default).
- **VERTICAL**.....This button pairs counterpart channels on Layer 1 and Layer 2 that share the same physical fader (e.g., CH1 & CH17, CH16 & CH32, etc.). This mode is useful when you wish to use one fader to control both stereo channels.

When you switch the Pair Mode, the combinations of channel numbers displayed on the page also change.

Note:

- When Pair mode is switched, only the channel numbers change. The mix parameters of the paired partners do not change.
- For example, if you change Pair mode from Horizontal to Vertical, the Input Channel “2” indication changes to Input Channel “17.” However, its parameters do not change. (If Channels 1 and 2 have been paired, switching the mode will pair Channels 1 and 17.)

- 3 Move the cursor to the desired channel’s MONOx2 button (②), then press [ENTER].

The channels are paired.

- 4 To cancel a pair, move the cursor to the desired channel’s STEREO button, then press [ENTER].

Tip: You can also create or cancel a pair of Output Channels in the same way on the Pair/Group | Output page (see page 105).

Naming Input Channels

By default, Input Channels are named CH1, CH2, etc. You can change these names if desired. For example, it may be helpful for mixdown if you name a particular Input Channel with the type of musical instrument connected to the corresponding input jack.

- 1 Press the DISPLAY ACCESS [PATCH] button repeatedly until the Patch | IN Name page appears.

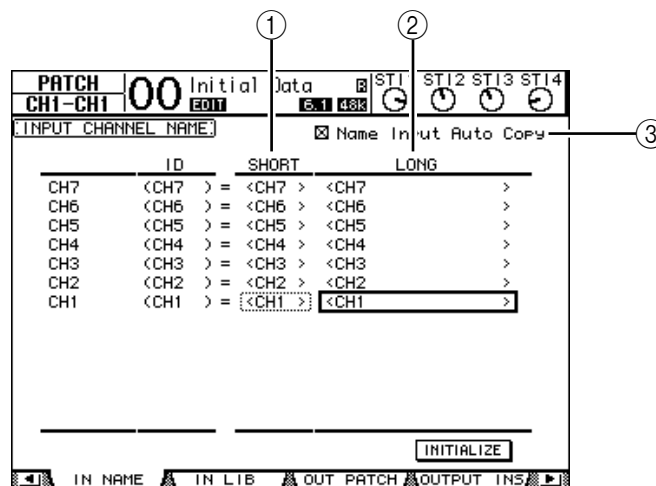

You can specify Short names in the center column (①) and Long (full) names in the right column (②).

When the Name Input Auto Copy check box (③) is on, the first four characters of a newly-entered Long name are automatically copied to the Short name. On the other hand, a newly-entered Short name is automatically added to the beginning of the Long name.

You can reset all channel names to their default names by moving the cursor to the INITIALIZE button, then pressing [ENTER].

2 Move the cursor to a name you wish to change, then press [ENTER].

The Title Edit window appears, enabling you to enter a name.

**3 Edit the name, move the cursor to the OK button, then press [ENTER].**

The new name is now effective.

Tip: The edited name is stored in the Input Patch library.

8 Bus Outs

This chapter describes how to adjust the 01V96's Stereo Out and Bus Out 1–8 parameters.

About Stereo Out

The Stereo Out section receives Input Channel and Bus Out 1–8 signals, mixes them into two channels, processes them using on-board EQ, compressor, etc., then routes them to the STEREO OUT and 2TR OUT connectors. The following diagram illustrates the Stereo Out signal flow.

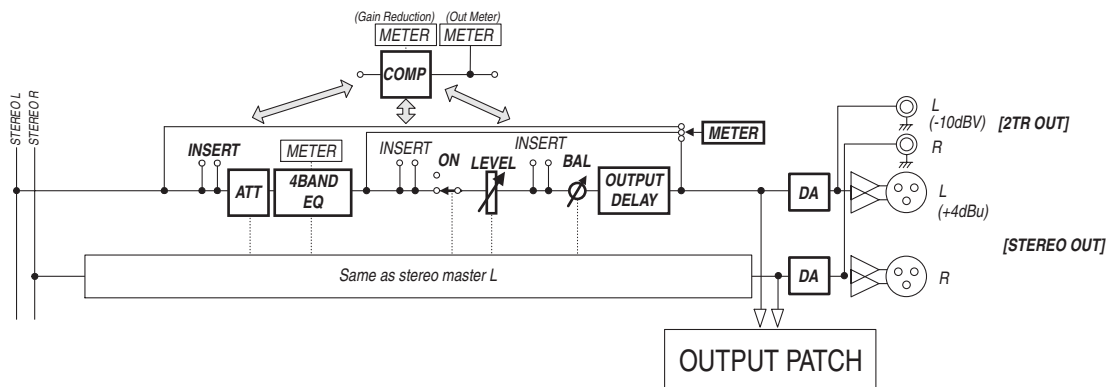

- **INSERT**
This section enables you to route the Stereo Out signals to external devices via the on-board connectors or I/O card, or insert internal effects processors.
- **ATT (Attenuator)**
This section enables you to attenuate or amplify the level of signals to be input to the EQ. The attenuator prevents post-EQ signals from clipping or corrects signal levels that are too low.
- **4 BAND EQ (4-band equalizer)**
This parametric EQ features four bands (HIGH, HIGH-MID, LOW-MID, and LOW).
- **COMP (Compressor)**
This dynamics processor can be used as compressor, expander, or limiter. The processor can be located pre-EQ, pre-[STEREO] fader, or post-[STEREO] fader.
- **ON (On/Off)**
This button turns the Stereo Out on or off.
- **LEVEL**
The [STEREO] fader adjusts the Stereo Out output levels.
- **Balance**
This section enables you to adjust the level balance between the L and R channels of the Stereo Out.
- **OUTPUT DELAY (Output delay)**
This section delays the output signals. It is mainly used to fine-tune the signal timing.

- **METER**

This section enables you to switch the metering position of signal levels that are displayed on the Meter page or by the stereo meter to the right of the screen. (See page 34 for more information on selecting the metering position.)

Note: You can also patch the Stereo Out signals to other output connectors or the I/O card by using the Patch | Out Patch pages.

Bus Out 1–8

The Bus Out 1–8 section mixes signals routed from Input Channels to the specified buses, processes them using on-board EQ, compressor, etc., then routes them to the specified output connectors or I/O card.

The following diagram illustrates the Bus Out signal flow.

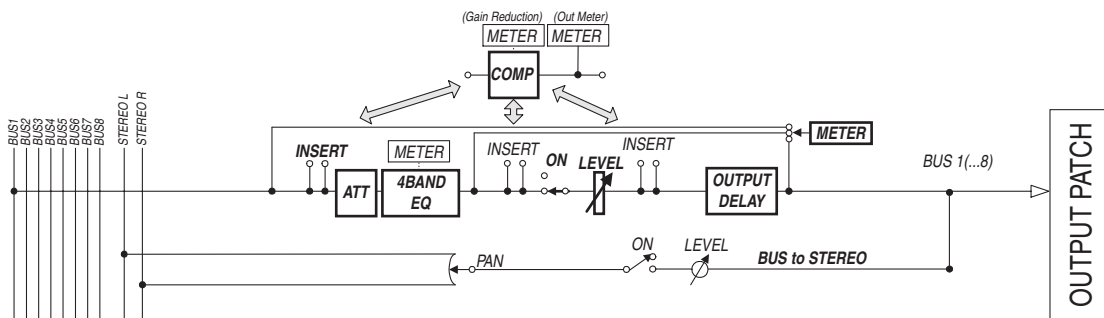

- **INSERT**
- **ATT (Attenuator)**
- **4 BAND EQ (4-band equalizer)**
- **COMP (Compressor)**
- **ON (On/Off)**
- **LEVEL**
- **OUTPUT DELAY (Output delay)**
- **METER**

The parameters and sections listed above are identical to those for the Stereo Out. For more information, refer to the explanation of the Stereo Out (see page 97).

- **Bus to Stereo**

Bus Out 1–8 signals are also routed to the Stereo Bus. In addition to the ON, LEVEL, and other parameters, you can also set the Send Level, On/Off, Pan, and other parameters.

Tip:

- You can also pair adjacent odd-even buses for stereo operation (see page 105).
- By default, Slot channels 1–8 and 9–16 and ADAT OUT channels 1–8 are patched to the Bus Out 1–8 outputs. However, you can change this patching on the Patch | Out Patch page (see page 123).

Setting the Stereo Out and Bus Out 1–8 from the Display

To set the Stereo Out and Bus Out 1–8 parameters, you can either move the cursor to the desired parameter on the display and change the value, or operate the desired button or control on the top panel.

This section explains how to set the parameters on the display.

Tip: Refer to Chapter 10 “Input & Output Patching” on page 121 for more information on how to set inserts.

Attenuating the Stereo Out and Bus Out

To attenuate the Stereo Out and Bus Out signals, press the DISPLAY ACCESS [EQ] button, then press the [F4] button to display the EQ | Out Att page. On this page, you can attenuate the Bus Out 1–8, Aux Out 1–8, and Stereo Out signals.

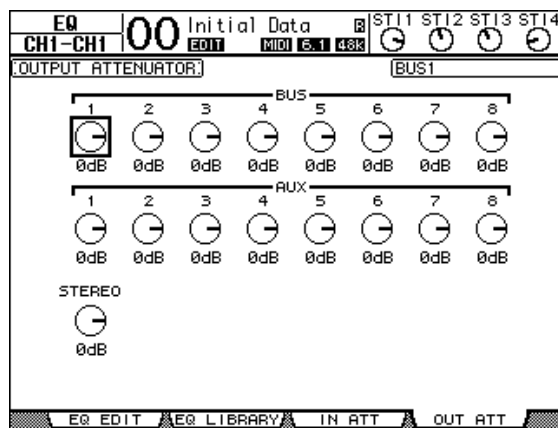

The parameters on this page (and the procedure for setting them) are the same as for Input Channels (see page 83).

Delaying the Stereo Out and Bus Outs

To delay the Stereo Out and Bus Out 1–8 signals, press the [ϕ /INSERT/DELAY] button repeatedly until the ϕ /INS/DLY | Out Dly page appears.

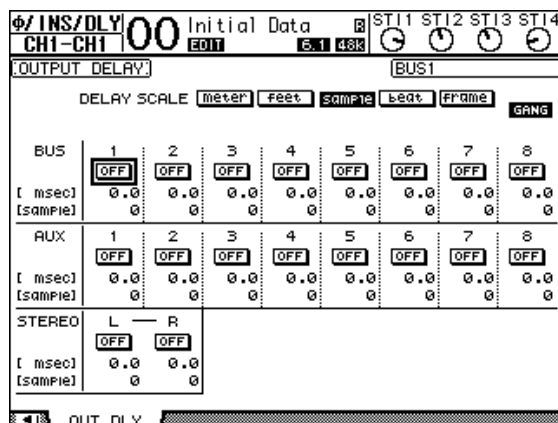

The parameters on this page (and the procedure for setting them) are the same as for Input Channels, except that this page does not include the MIX/FB.GAIN parameters (see page 80).

Tip: You can also display the Out Dly page by pressing the [ϕ /INSERT/DELAY] button once, then press the [SEL] button to select the Stereo Out or Bus Out 1–8.

Compressing the Stereo Out and Bus Outs

To set the Stereo Out and Bus Out 1–8 compressors, press the [DYNAMICS] button, then the [F3] button to display the Dynamics | Comp Edit page, and use the [SEL] buttons to select the Stereo Out or Bus Out 1–8.

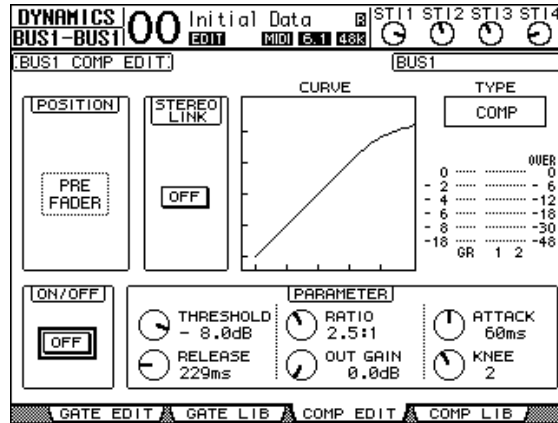

The parameters on this page (and the procedure for setting them) are the same as for Input Channels (see page 82).

EQ'ing the Stereo Out and Bus Outs

To set the EQ for the Stereo Out and Bus Out 1–8 EQ, press the DISPLAY ACCESS [EQ] button, then press the [F1] button to display the EQ | EQ Edit page, and use the [SEL] buttons to select the Stereo Out or Bus Out 1–8.

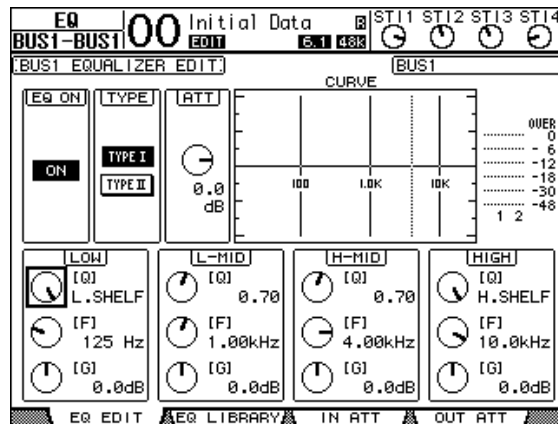

The parameters on this page (and the procedure for setting them) are the same as for Input Channels (see page 84). Note that the Stereo Out does not feature the STEREO LINK parameter.

Routing Bus Out 1–8 Signals to the Stereo Bus.

You can patch Bus Out 1–8 signals to Outputs and Slots 1/2, as well as to the Stereo Bus. You can adjust the level and pan settings of the signals routed to the Stereo Bus for each bus. This is convenient when you wish to use Bus Outs (1–8) as a Group Bus.

To patch the Bus Out 1–8 signals to the Stereo Bus, press the DISPLAY ACCESS [PAN/ROUTING] button repeatedly to display the Pan/Route | Bus to St page.

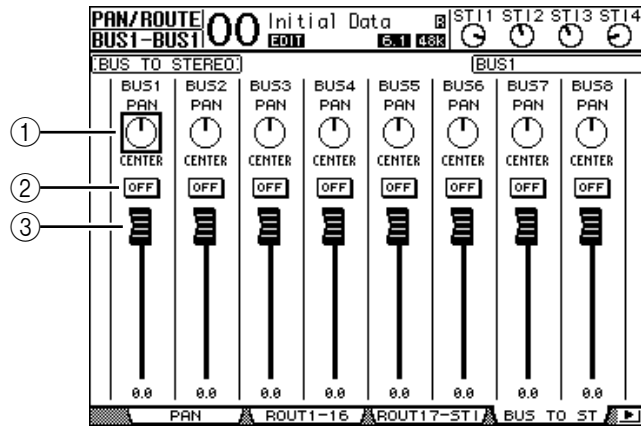

Move the cursor to the desired parameter you wish to change, then rotate the Parameter wheel or press the [INC]/[DEC] buttons to modify the setting.

① TO ST PAN

These controls pan the Bus Out 1–8 signals between the left and right Stereo Out buses.

② TO ST ON/OFF

These buttons turn on and off the Bus Out 1–8 to the Stereo Bus routing.

③ TO ST Faders

These faders set the Bus Out 1–8 to Stereo Bus levels.

Viewing the Stereo Out and Bus Out Settings

You can view and adjust parameter settings for the currently-selected Stereo Out or Bus Out on the View | Parameter and Fader pages.

■ Viewing the Compressor and EQ Settings

To display the View | Parameter page, use the corresponding [SEL] button to select the desired bus, then press the DISPLAY ACCESS [VIEW] button, then press the [F1] button.

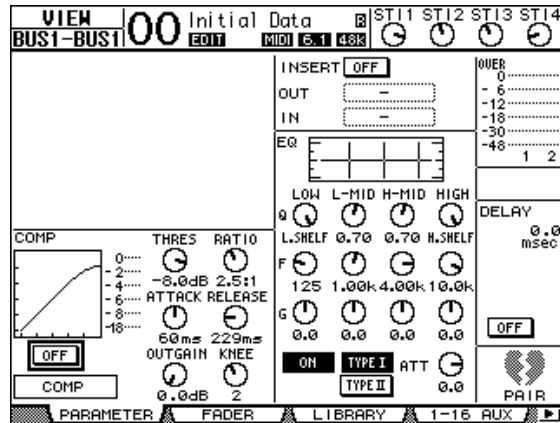

The parameters on this page (and the procedure for setting them) are the same as for Input Channels, except for the following items:

- The Stereo Out and Bus Out 1–8 Parameter pages do not contain the Gate and Phase parameters.
- The Stereo Out Parameter page does not contain the Pair parameter.

■ Viewing Faders and Other Parameters

To display the View | Fader page, use the corresponding [SEL] button to select the desired bus, then press the DISPLAY ACCESS [VIEW] button, then press the [F2] button.

The Fader page layouts for Stereo Out and Bus Out 1–8 are slightly different.

- **Stereo Out Fader page**

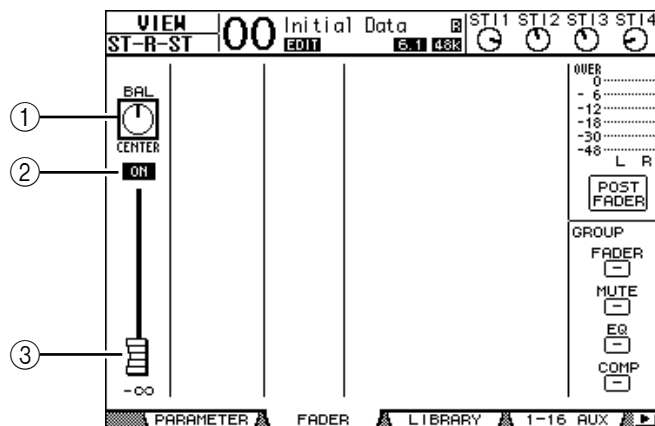

- ① **BAL**
This control adjusts the level balance between the L and R channels of the Stereo Out.
- ② **ON/OFF**
This button turns the Stereo Out on or off, and links with the [ON] button in the STEREO section.

③ Fader

This fader adjusts the Stereo Out output levels, and links with the [STEREO] fader. The fader knob is highlighted when the fader is set to 0.0 dB.

- **Bus Out (1–8) Fader page**

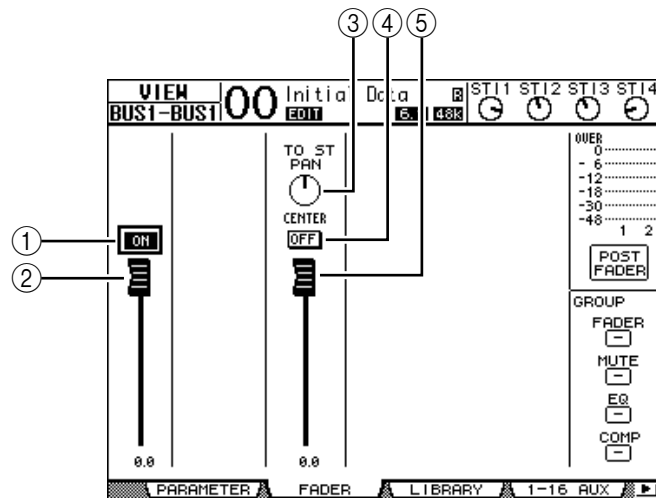

① ON/OFF

This button turns the currently-selected Bus Out (1–8) on or off, and links with the [ON] (9–16) button in the Master layer.

② Fader

This fader sets the currently-selected Bus Out (1–8) level, and links with the fader (9–16) in the Master layer. The fader knob is highlighted when the fader is set to 0.0 dB.

③ TO ST PAN

This control sets the Bus Out to Stereo Out Pan position for the currently-selected Bus Out (1–8).

④ TO ST ON/OFF

This button turns on or off the Bus Out to Stereo Out signal for the currently-selected Bus Out (1–8).

⑤ TO ST Fader

This fader sets the Bus Out to Stereo Out signal level for the currently-selected Bus Out (1–8).

Tip: The TO ST PAN, ON/OFF, and TO ST Fader parameters also appear on the Pan/Route | Bus to St page.

Setting the Stereo Out and Bus Out 1–8 from the Control Surface

You can use the faders, [SEL] buttons, and various buttons and controls in the SELECTED CHANNEL section on the top panel to directly control certain parameters for the Stereo Out and Bus Out 1–8.

Setting the Levels

Move the [STEREO] fader to adjust the Stereo Out levels. Press the [ON] button in the STEREO section to turn the Stereo Out on or off.

To set Bus Out 1–8 levels, press the [MASTER] button in the LAYER section to select the Master layer, then move faders 9–16. At this time, you can turn Bus Out 1–8 on or off using the [ON] 9–16 buttons.

EQ'ing and Balancing the Stereo Out and Bus Outs

- 1 Press the [SEL] button of the bus to which you want to apply EQ or set the level balance.
- 2 To adjust the EQ of the currently-selected bus, select the desired band by pressing one of the following buttons in the SELECTED CHANNEL section:
 - [HIGH] button HIGH band
 - [H-MID] button HIGH-MID band
 - [L-MID] button LOW-MID band
 - [LOW] button LOW band
- 3 Use the [Q], [FREQUENCY], and [GAIN] controls to adjust the Q, frequency, and gain of the band selected in Step 2.
See page 84 for more information on EQ.
- 4 To adjust the Stereo Out Balance parameter, use the [PAN] control in the SELECTED CHANNEL section.

Note: If you select Aux Out 1–8 or Bus Out 1–8, the [PAN] control is disabled.

Pairing Buses or Aux Sends

You can pair adjacent odd-even (in this order) buses or Aux Sends for stereo operation. Paired bus and Aux Send linked parameters and non-linked parameters (that are available for independent controls) are listed below:

Linked parameters
[SEL] buttons
Fader
Channel on/off
Insert on/off
Solo on/off
Comp settings
Comp insert position
EQ settings
Fader group
Mute group
Fade time
Recall safe
Bus to Stereo on/off*
Bus to Stereo fader*

Non-linked parameters
Output Patching
Insert Patching
Delay on/off
Delay time**
Bus to Stereo Pan*
Attenuators***

** You can set this parameter for each channel independently if the GANG button is turned off on the Φ /INS/DLY | DLY page.

*** You can set this parameter for each channel independently on the EQ | ATT page, but the paired channel settings are linked on the EQ | Edit and View pages.

Parameters marked with an asterisk * are available only for Bus Outs.

- 1 Press the DISPLAY ACCESS [PAIR/GROUP] button repeatedly until the Pair/Grup | Output page appears.

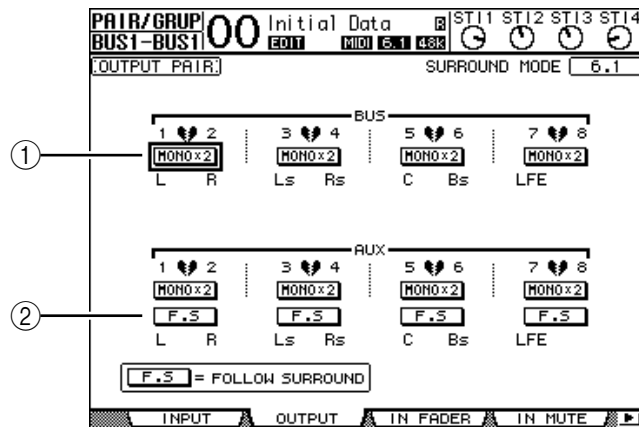

The parameters on this page are described below.

① **STEREO/MONOx2**

These buttons turn Bus or Aux Send pairs on or off.

② **F.S**

This button determines whether Aux Sends follow the Input Channel Surround Pan when the 01V96 is in any Surround mode other than “Stereo.” When this button is turned on, Aux Sends follow the Input Channel Surround Pan. This is useful for feeding Surround signals to external Surround effects processors.

- 2 Move the cursor to the MONOx2 button for the desired Bus or Aux Send, then press [ENTER].

The buses or Aux Sends are paired.

- 3 To cancel a pair, move the cursor to the STEREO button for the desired Bus or Aux Send, then press [ENTER].

Attenuating Output Signals

To attenuate the 01V96's output signals, display the EQ | Out Att page and adjust the Stereo Out and Bus Out 1–8 attenuators individually.

If necessary, you can also select Output and I/O card channels and specify the amount of attenuation. This technique is convenient when you want to attenuate output signals quickly, regardless of the source signal patching.

- 1 Press the **DISPLAY ACCESS [DIO/SETUP]** button repeatedly until the **DIO/Setup | Output Att** page appears.

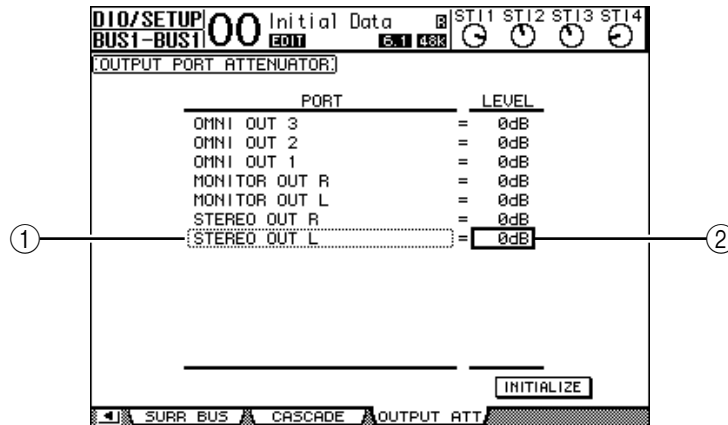

- 2 Move the cursor in the left column (①), then scroll the list up or down using the Parameter wheel to select the desired output or slot channel for which you want to adjust attenuation.

The following outputs and slot channels can be selected:

- STEREO OUT L/RSTEREO OUT L & R channels
- MONITOR OUT L/RMONITOR OUT L & R channels
- OMNI OUT 1–4OMNI OUT connectors 1–4
- SLOT OUT 1–1 through 1–16Slot channels 1–16
- ADAT OUT 1–8ADAT OUT channels 1–8
- 2TR OUT DIGITAL L/R2TR OUT DIGITAL L & R channels

- 3 Move the cursor to the parameter value in the right column (②), then rotate the Parameter wheel or press the **[INC]/[DEC]** buttons to set the amount of attenuation.

The amount of attenuation can be set from 0 dB to –9 dB.

Tip: To reset the attenuation amount of all Output Channels to 0 dB, move the cursor to the **INITIALIZE** button, then press **[ENTER]**.

Naming the Stereo Out and Bus Outs

You can change the default Bus names (BUS1, AUX4, STEREO, etc.). It may be convenient to name the buses “Monitor Out” or “Effect Send,” for example, so that you can easily identify the signal type.

- 1 Press the DISPLAY ACCESS [PATCH] button repeatedly until the Patch | Out Name page appears.

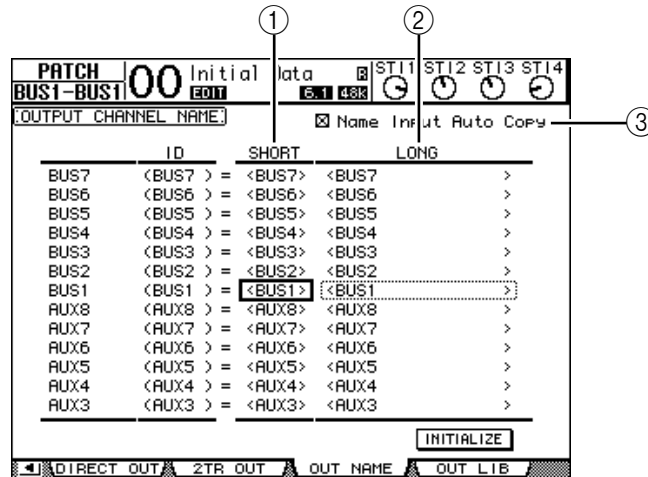

You can specify Short names in the center column (1) and Long (full) names in the right column (2).

When the Name Input Auto Copy check box (3) is on, the first four characters of a newly-entered Long name are automatically copied to the Short name. On the other hand, a newly-entered Short name is automatically added to the beginning of the Long name.

You can reset all bus names to their default names by moving the cursor to the INITIALIZE button, then pressing [ENTER].

- 2 Move the cursor to a name you wish to change, then press [ENTER].

The Title Edit window appears, which enables you to edit the name.

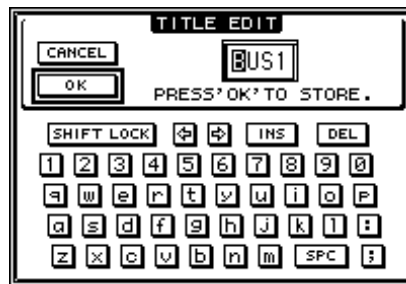

- 3 Edit the name, move the cursor to the OK button, then press [ENTER].

The new name is now effective.

Tip: The edited name is stored in the Output Patch library.

9 Aux Outs

This chapter describes how to control Aux Out 1–8.

Aux Out 1–8

The Aux Out 1–8 section mixes signals routed from the Input Channels to the corresponding Aux Sends, processes them using on-board EQ, compressor, etc., then routes them to the specified internal effects processors, output connectors or I/O card connectors.

The 01V96 features eight Aux Sends, which can be used to send signals to the internal and external effects processors and monitors.

The following diagram illustrates the Aux Out 1–8 signal flow.

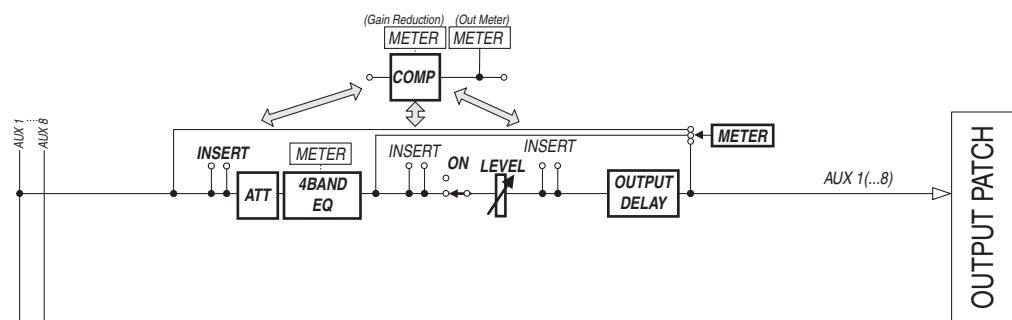

- INSERT
- ATT (Attenuator)
- 4 BAND EQ (4-band equalizer)
- COMP (Compressor)
- ON (On/Off)
- LEVEL
- OUTPUT DELAY (Output delay)
- METER

These parameters are the same as the Stereo Out and Bus Out 1–8 (see page 97).

Tip: You can also pair adjacent odd-even Aux Sends (in this order) for stereo Aux operation.

Note: With the default setting, Aux Out 1–4 are patched to OMNI OUT connectors 1–4 and to internal Effects processors 1–4. However, you can change this patching on the Patch | Output page.

Setting Aux Out 1–8 from the Display

To set Aux Out 1–8 parameters, you can either move the cursor to the desired parameter on the screen and change the value, or operate the desired button or control on the top panel. This section explains how to set the parameters on the screen.

Tip: Refer to Chapter 10 “Input & Output Patching” on page 121 for more information on how to set inserts.

Attenuating Aux Outs

To attenuate Aux Out 1–8 signals, press the [EQ] button, then press the [F4] button to display the EQ | Out Att page.

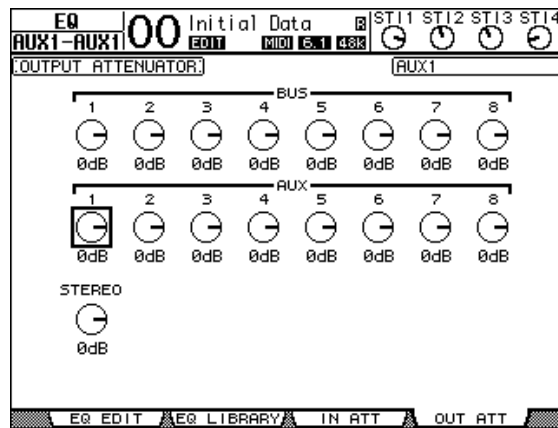

The parameters on this page (and the procedure for setting them) are the same as for Input Channels (see page 83).

Delaying Aux Outs

To delay Aux Out 1–8 signals, press the DISPLAY ACCESS [ϕ/INSERT/DELAY] button repeatedly until the ϕ/INS/DLY | Out Dly page appears.

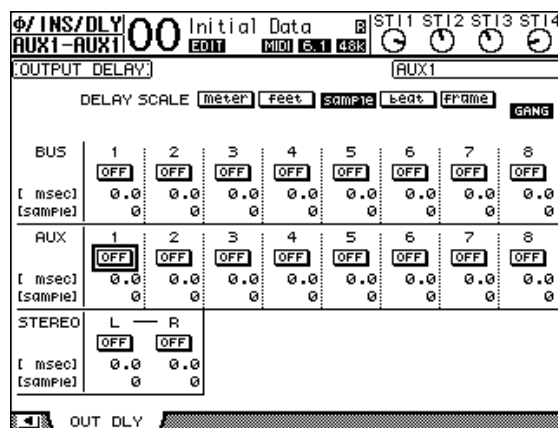

The parameters on this page (and the procedure for setting them) are the same as for Input Channels, except that this page does not include the MIX/FB.GAIN parameters (see page 80).

Tip: You can also display the Out Dly page if you select the desired Aux Out (1–8) by pressing the corresponding [SEL] button while the DLY-related parameters are indicated on the page.

Comp settings

To set the Aux Out 1–8 compressors, press the DISPLAY ACCESS [DYNAMICS] button, then press the [F3] button to display the Dynamics | Comp Edit page, then select the desired Aux Out 1–8 by using the corresponding [SEL] buttons.

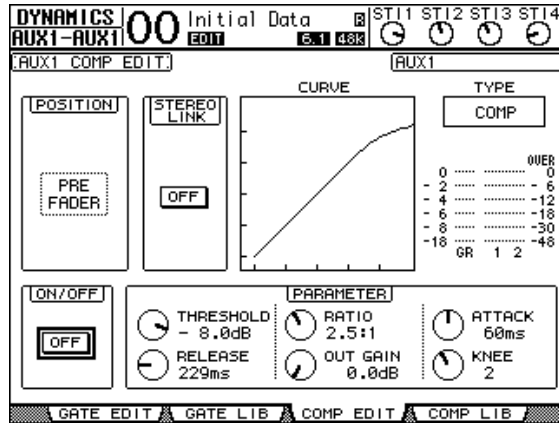

The parameters on this page (and the procedure for setting them) are the same as for Input Channels (see page 82).

EQ settings

To set the EQ for Aux Out 1–8, press the DISPLAY ACCESS [EQ] button, then press the [F1] button to display the EQ | EQ Edit page, then use the [SEL] buttons to select Aux Out 1–8.

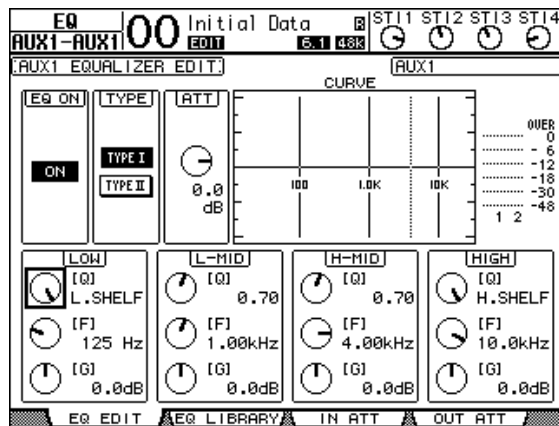

The parameters on this page (and the procedure for setting them) are the same as for Input Channels (see page 84).

Viewing Aux Out Settings

You can view and adjust the parameter settings for the currently-selected Aux Out on the View | Parameter and Fader pages.

■ Viewing the Compressor and EQ Settings

To display the View | Parameter page, use the corresponding [SEL] button to select the desired Aux Out (1–8), then press the DISPLAY ACCESS [VIEW] button, then press the [F1] button.

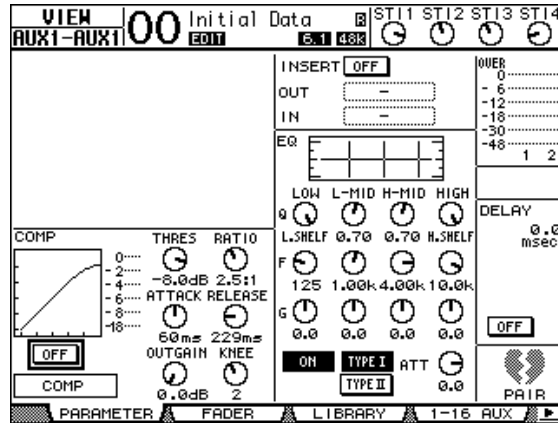

The parameters on this page (and the procedure for setting them) are the same as for Input Channels, except that this page does not include the Gate and Phase parameters (see page 87).

■ Viewing Faders and On/Off Parameters

To display the View | Fader page, use the corresponding [SEL] button to select the desired Aux Out (1–8), then press the DISPLAY ACCESS [VIEW] button, then press the [F2] button.

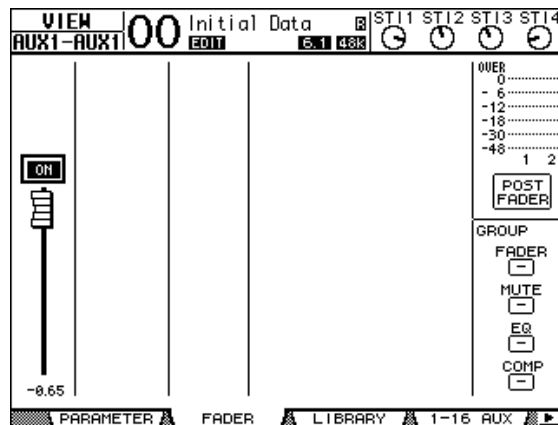

- **ON/OFF** This button turns the currently-selected Aux Out (1–8) on or off. It links with the corresponding [ON] (1–8) button in the Master layer.
- **Fader** This fader sets the currently-selected Aux Out (1–8) level. It links with the corresponding fader (1–8) in the Master layer. The fader knob is highlighted when the fader is set to 0.0 dB.

Setting Aux Out 1–8 from the Control Surface

You can use the faders, [SEL] buttons, and various buttons and controls in the SELECTED CHANNEL section on the top panel to directly control certain parameters for Aux Out 1–8.

Setting Levels

To set Aux Out 1–8 levels, press the [MASTER] button in the LAYER section to select the Master layer, then move faders 1–8. At this time, you can turn Aux Out 1–8 on or off using the corresponding [ON] 1–8 buttons.

EQ settings

To control Aux Out 1–8 EQ parameters, select the desired Aux Out (1–8) using the corresponding [SEL] button or fader, then use the buttons and controls in the SELECTED CHANNEL section. The parameters on this page (and the procedure for setting them) are the same as for Input Channels (see page 83).

Setting Aux Send Levels

You can adjust the level of signals routed from Input Channels to the corresponding Aux Out (1–8).

Setting Send Levels from the Display

You can view multiple channels' Aux Send levels on the screen and adjust them individually.

- 1 Press the FADER MODE [AUX 1]–[AUX 8] buttons to select the Aux.
- 2 Make sure that the 01V96 displays the Aux | Send page.

This page enables you to adjust the level of the signals routed from each Input Channel to the Aux selected in Step 1.

If the Send page is not displayed, repeatedly press the button that you pressed in Step 1 until the Send page appears.

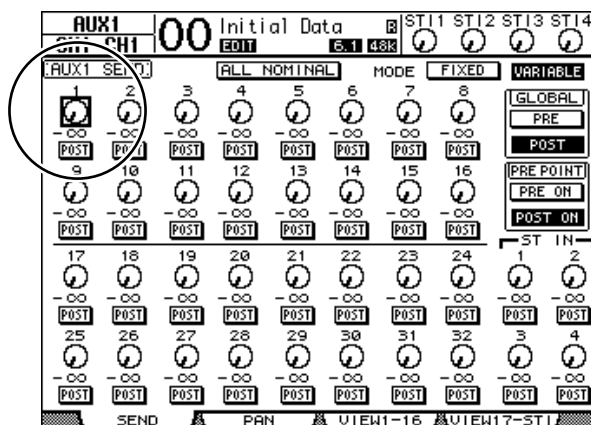

- **Aux Send rotary controls**
These controls adjust the Aux Send level of the Input Channels. The current numeric levels appear below the rotary controls.
- **PRE/POST**
These buttons enable you to specify the Aux signal source points. The PRE buttons send pre-fader signals, and the POST buttons send post-fader signals.

- MODE**
 Aux Sends have two operating modes that determine how signals are sent: Fixed (Aux Send levels are fixed); and Variable (Aux Send levels are variable).
- GLOBAL**
 The GLOBAL PRE and POST buttons enable you to set all Input Channels for the selected Aux to pre-fader or post-fader simultaneously.
- PRE POINT**
 The PRE POINT PRE ON and POST ON buttons enable you to set the pre-fader channels to pre-on (before the [ON] button) or post-on (after the [ON] button).

Note: In Fixed mode, Aux Send ON/OFF buttons appear instead of the Aux Send rotary controls, PRE/POST buttons, GLOBAL PRE/POST buttons, and PRE POINT PRE ON/POST ON. These ON/OFF buttons turn on or off each Input Channel for the currently-selected Aux Send.

3 Move the cursor to the FIXED or VARIABLE button in the MODE section for the currently-selected Aux Send to select a mode.

- Fixed Mode**
 In this mode, Aux Send levels are fixed at nominal (0.0 dB). Also, channel ON/OFF buttons appear instead of the Send level rotary controls and PRE/POST buttons.

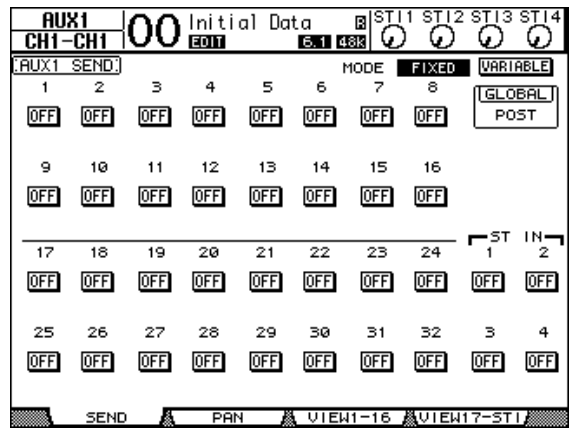

- **Variable Mode**

In this mode, Aux Send levels are variable and the signal source point can be either pre-fader or post-fader. Channel Send level rotary controls and PRE/POST buttons appear on the screen.

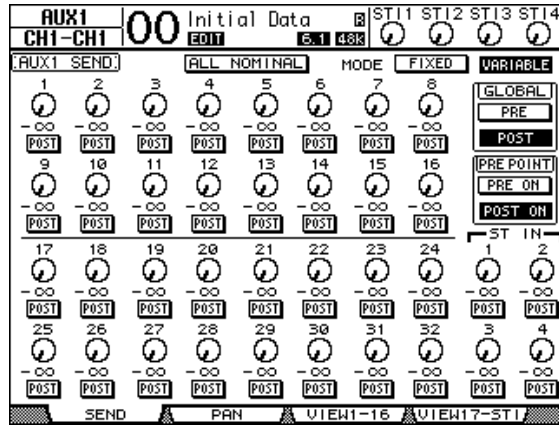

Tip: You can select Variable or Fixed mode individually for each of the eight Aux.

Note:

- In Fixed mode, all ON/OFF buttons are turned OFF.
- When you switch to Variable mode, the signal source points are set to post-fader (PRE/POST buttons are set to POST), and Send level rotary controls are reset to $-\infty$.

4 If you switched to Fixed mode in Step 3, the ON/OFF buttons turn each Input Channel on or off for the currently-selected Aux Send.

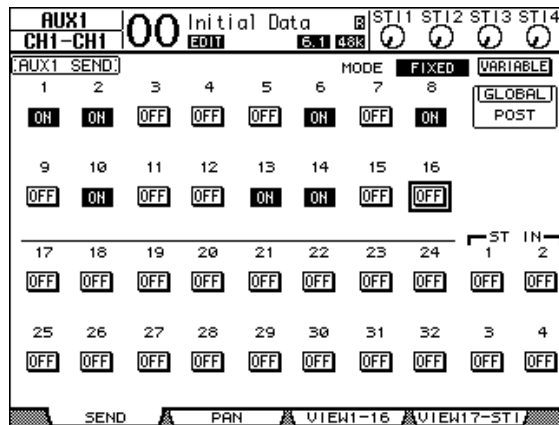

Note: In Fixed mode, the Aux On/Off parameters for paired Input Channels are not linked to each other.

- 5 If you switched to Variable mode in Step 3, the PRE/POST buttons and Send level rotary controls enable you to adjust the signal source points and Send levels.

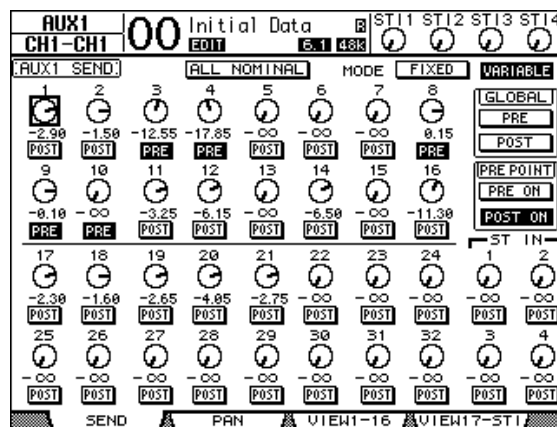

You can turn each Input Channel on or off for the currently-selected Aux Send even in Variable mode. To do this, move the cursor to the desired Send level control, then press [ENTER]. (The rotary controls for Off channels are grayed out.)

Tip:

- In Variable mode, Aux Send levels, Aux On/Off, and Pre/Post parameters for paired Input Channels are linked to each other.
- GLOBAL PRE/POST buttons enable you to set all Input Channels simultaneously (including those not displayed on the current page) to pre-fader or post-fader.

Note:

- Do not raise the level of the Aux Sends (patched to the effects processor) on the effects return channels.
- For example, by default, Aux 1 is routed to the input of the internal Effects processor 1, and L and R of ST IN Channel 1 are patched to the processor's output. Under these conditions, if you raise the level of the send signals from ST IN Channel 1 to Aux 1, the signals are returned to ST IN Channel 1, creating a signal loop and possibly damaging your speakers.

Viewing Aux Send Settings for Multiple Channels

You can view and set parameters for all Aux Send 1–8, including setting levels and Pre/Post parameters.

This is convenient when you wish to visually check all Aux Send settings or simultaneously adjust the levels of certain channels routed to Aux 1–8.

1 Press one of the FADER MODE [AUX 1]–[AUX 8] buttons repeatedly until the page listed below that contains the desired channels appears.

- View1-16 page

This page displays the Aux Send levels of Input Channels 1–16.

- View17-STI page

This page displays the Aux Send levels of Input Channels 17–32 and ST IN Channels 1–4.

These pages display the source Input channels and the corresponding Aux Sends in a matrix. The parameters on these two pages (and the procedure for setting them) are the same.

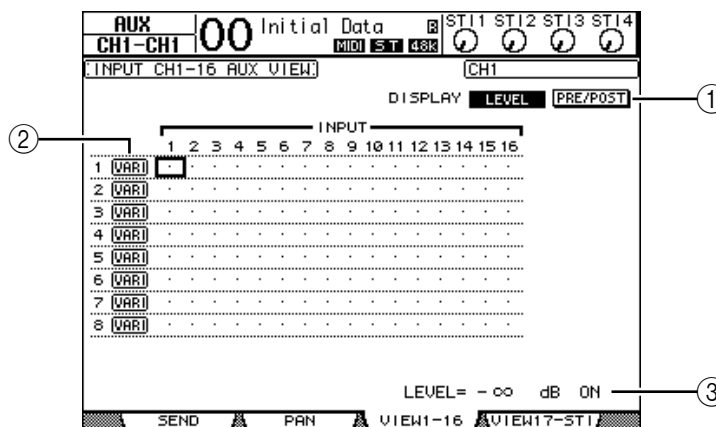

① DISPLAY

Use the following buttons to display the desired parameters.

- **LEVEL**.....Select the LEVEL button to display Send level bar graphs for Input Channels routed to Aux 1–8.
- **PRE/POST**.....Select the PRE/POST button to display signal source points for Input Channels routed to Aux 1–8.

② FIX/VARI

These buttons indicate the Aux mode (Fixed or Variable) for Aux Out 1–8 and are only for display purposes.

③ LEVEL

This field displays in dB the level of the Aux Send currently-selected by the cursor.

2 Move the cursor to either the DISPLAY LEVEL or PRE/POST button, then press [ENTER] to display the Level or Pre/Post parameters.

- If you selected the PRE/POST button in Step 2, move the cursor to the desired Input Channel and Aux intersection, then press the [ENTER] button to change the signal source point.

		INPUT															
		1	2	3	4	5	6	7	8	9	10	11	12	13	14	15	16
1	[VAR]	P0	P0	FX	FX	P0	P0	FX	P0	P0	P0	P0	P0	FX	P0	FX	P0
2	[VAR]	P0	P0	P0	P0	P0	P0	P0	P0	P0	P0	P0	P0	P0	P0	P0	P0
3	[VAR]	P0	P0	P0	P0	P0	P0	P0	P0	P0	P0	P0	P0	P0	P0	P0	P0

Note: You can switch between Pre and Post only for Aux Sends that are set to Variable mode. The “FIX” indication appears for Aux Sends that are set to Fixed mode, and you cannot switch Pre/Post.

- If you selected the LEVEL button in Step 2, move the cursor to the desired Input Channel and Aux intersection, then edit the Send level or turn the currently-selected AUX Send on or off.

Rotate the Parameter wheel or press the [INC]/[DEC] buttons to set the Send level, then press the [ENTER] button to turn the currently-selected Aux Send on or off.

One of the following indicators appears, depending on the current Aux mode.

- Aux Sends in Fixed mode**.....A “FIX” indicator appears for On Aux Sends, and a dot “.” appears for Off Aux Sends.

		INPUT															
		1	2	3	4	5	6	7	8	9	10	11	12	13	14	15	16
1	[FIX]	FX	FX	FX	FX	FX	FX	FX	FX	FX	FX	FX	FX	FX	FX	FX	FX
2	[VAR]	█	█	█	█	█	█	█	█	█	█	█	█	█	█	█	█
3	[VAR]

- Aux Sends in Variable mode**.....The current Send levels are displayed by the bar graphs. If the level is set to nominal (0.0 dB), “N” appears in the bar. The bars for Aux Sends that are turned off are highlighted.

		INPUT															
		1	2	3	4	5	6	7	8	9	10	11	12	13	14	15	16
1	[FIX]	FX	FX	FX	FX	FX	FX	FX	FX	FX	FX	FX	FX	FX	FX	FX	FX
2	[VAR]	█	█	█	█	█	█	█	█	█	█	█	█	█	█	█	█
3	[VAR]

Panning Aux Sends

You can pair adjacent odd-even (in this order) Aux Sends for stereo operation. This enables you to pan signals from Input Channels to paired Aux Sends.

- 1 Pair the desired two Aux Sends. (See page 105 for more information on pairing channels.)
- 2 Use the FADER MODE [AUX 1]–[AUX 8] buttons to select one of the paired Aux Sends.
- 3 Repeatedly press the button you pressed in Step 2 to display the Aux | Pan page.

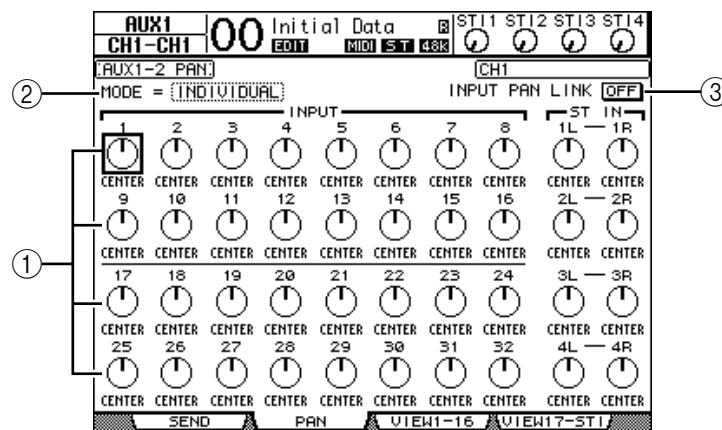

① **Aux pan controls**

These controls adjust the pan setting of signals routed from Input Channels to paired Aux buses.

② **MODE**

The MODE parameter determines how paired Input Channels are panned.

③ **INPUT PAN LINK**

When this parameter is turned on, Aux Sends follow the Input Channel Pan.

- 4 Move the cursor to the Aux pan control of the desired Input Channel, the rotate the Parameter wheel to set the pan value.
- 5 If necessary, move the cursor to the MODE parameter box, then rotate the Parameter wheel to select INDIVIDUAL, GANG, or INV GANG, then press [ENTER].

If the INPUT PAN LINK ON/OFF button is turned off, this Mode setting is independent of the Mode parameter on the Pan page. (See page 85 for more information on Mode options.)

- 6 To link the Input Channel Pan setting with the Aux Send Pan setting, move the cursor to the INPUT PAN LINK ON/OFF button, then press [ENTER].

The pan positions on the Pan page are copied to the Aux pan setting, and the pan controls on both pages are linked.

Tip:

- If paired Aux Sends are in Variable mode, the Aux Send levels, Aux On/Off, and Pre/Post parameters for paired Input Channels are linked to each other.
- If paired Aux Sends are in Fixed mode, the Aux On/Off parameters for paired Input Channels are not linked to each other.

Copying Channel Fader Positions to Aux Sends

While Aux Sends are in Variable mode, you can copy all Input Channel fader positions on one layer to the corresponding Aux Sends.

This is convenient when you wish to send to the musicians monitor signals that have the same balance setting as the Stereo Out signals.

1 Press and hold down the copy source layer (LAYER [1–16] or [17–32]) button.

Note: If you release the button in the LAYER section before you proceed to Step 2, you will be unable to complete the Copy operation.

2 Press one of the FADER MODE [AUX 1]–[AUX 8] buttons to select the desired Aux Send copy destination.

The confirmation window for the Copy operation appears.

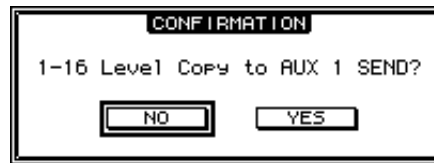

3 To execute the Copy operation, move the cursor to the YES button, then press [ENTER].

To cancel the Copy operation, move the cursor to the NO button, then press [ENTER].

Tip: If the copy destination Input Channel has been paired with a vertical partner in another Layer, the fader position will be copied to the partner's Aux Send.

10 Input & Output Patching

This chapter describes how to patch (assign) signal paths within the 01V96 to its inputs, outputs, and slot channels

Input Patching

Signals input at INPUT connectors 1–16, ADAT IN connector, 2TR IN DIGITAL connector, and Slot I/O card are patched to Input Channels for use.

Patch example:

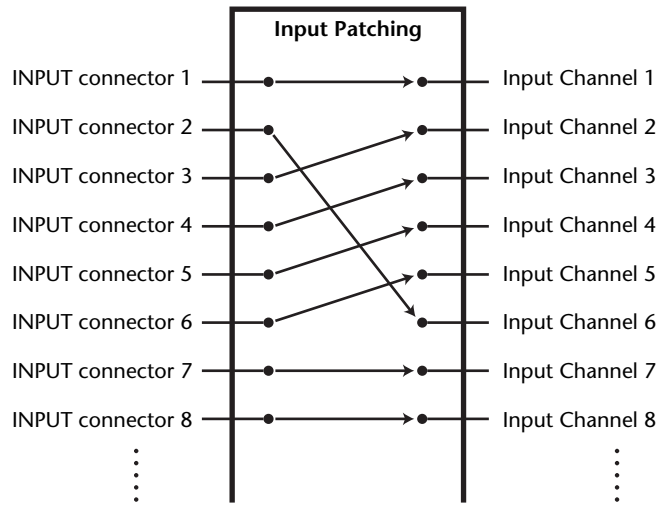

By default, the Input Channels are patched as follows:

Input Channels	Input connectors and Slot channels
1–16	INPUT connectors 1–16
17–24	ADAT IN Input Channels 1–8
25–32	Slot Channels 1–8
ST IN Channels 1–4	Internal Effects Processor 1–4 Outputs 1–2

You can change these patches, if you desire.

Input Patching

Follow the steps below to change the Input Patch.

- 1 Press the **DISPLAY ACCESS [PATCH]** button repeatedly until the Patch | In Patch page appears.

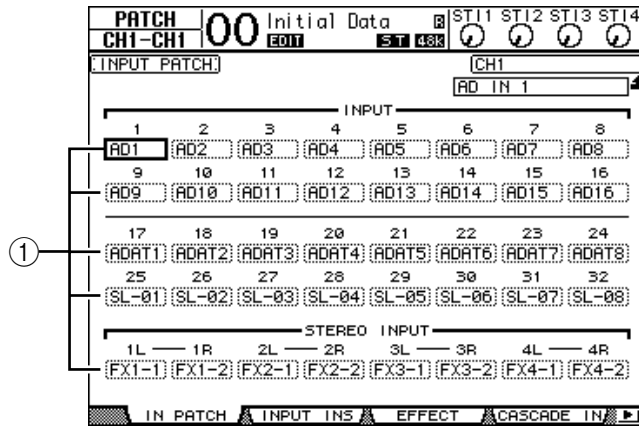

Inputs, ADAT IN channels, and slot channels that are currently assigned to Input Channels are shown in the parameter boxes (①) below the channel numbers. The parameter indicators are explained below:

Parameter value	Description
–	No assignment
AD1–AD16	INPUT connectors 1–16
ADAT1–ADAT8	ADAT IN Input Channels 1–8
SL-01–SL-16	Slot Channels 1–16
FX1-1 & FX1-2	Outputs 1 & 2 of Internal Effects Processor 1
FX2-1 & FX2-2	Outputs 1 & 2 of Internal Effects Processor 2
FX3-1 & FX3-2	Outputs 1 & 2 of Internal Effects Processor 3
FX4-1 & FX4-2	Outputs 1 & 2 of Internal Effects Processor 4
2TD-L & 2TD-R	2TR DIGITAL IN (L/R)

- 2 Move the cursor to an input patch parameter you wish to change, then rotate the Parameter wheel or press the **[INC]/[DEC]** buttons to modify the patching.

The long name of the currently-selected channel is indicated in the upper-right corner of the screen (①). Below the channel name is the long name of the selected input channel (②). (See page 94 and 229 for information on changing channel names.)

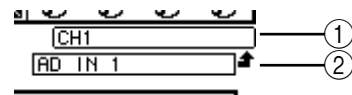

- 3 Press **[ENTER]** to confirm the change.

Tip:

- You can patch an input signal to multiple Input Channels.
- You can store the Input Patch settings to the Input Patch library. Refer to Chapter 16 for more information.

Output Patching

The 01V96's Stereo Out, Bus Out 1–8, Aux Out 1–8 signals can be patched to any outputs, ADAT OUT output channels, and slot output channels.

Patch example:

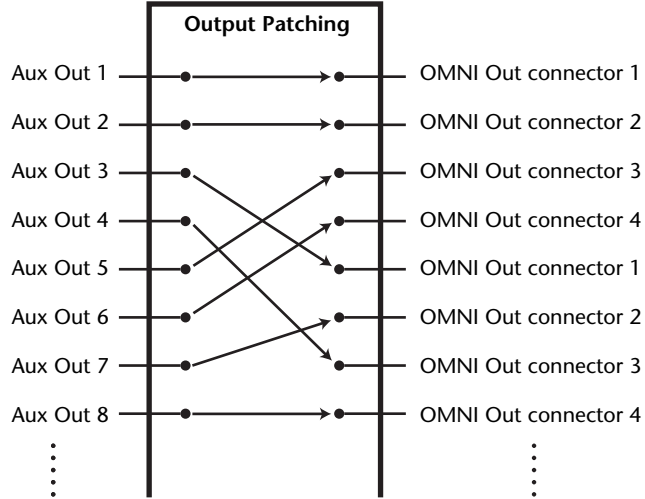

By default, the following signal paths are patched to outputs, ADAT OUT output channels, and slot output channels:

Output connectors and slot channels	Signal flow
ADAT OUT output channels 1–8	Bus Outs 1–8
Slot Channels 1–8	Bus Outs 1–8
Slot Channels 9–16	Bus Outs 1–8
OMNI OUT connectors 1–4	Aux Outs 1–4
2TR OUT DIGITAL (L)	Stereo Out L
2TR OUT DIGITAL (R)	Stereo Out R

Tip:

- You can patch a signal to multiple outputs.
- You can store the Output Patch settings to the Output Patch library. Refer to Chapter 16 for more information.

You can change these patches, if you desire. The procedure for patching signals to output varies depending on the output connectors and slots.

Changing the Signal Path to the ADAT OUT Connector, Slot, or OMNI OUT connectors

Follow the steps below to change the signal path patched to the ADAT OUT connector, the optional mini-YGDAI card installed in the slot, or the OMNI OUT connectors.

- 1 Press the **DISPLAY ACCESS [PATCH]** button repeatedly until the **Patch | Out Patch** page appears.

Each parameter box displays the currently-patched signal path.

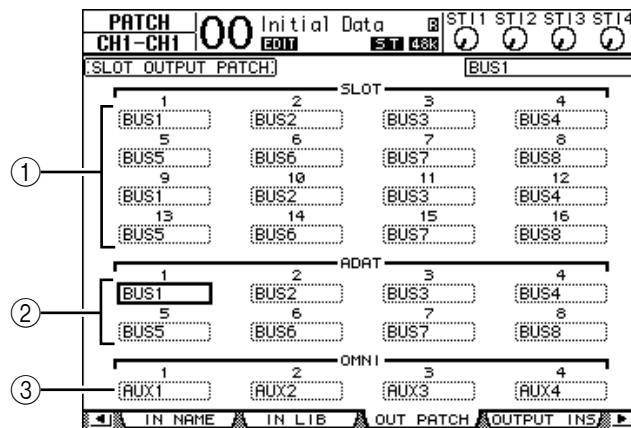

① **SLOT 1-16**

These parameter boxes set the routing of Slot Channel 1-16 signals.

② **ADAT 1-8**

These parameter boxes set the routing of ADAT OUT connector output channel 1-8 signals.

③ **OMNI 1-4**

These parameter boxes set the routing of OMNI OUT connector 1-4 signals.

The parameter indicators are explained below:

Parameter value	Description
-	No assignment
BUS1–BUS8	Bus Out 1–8 signal
AUX1–AUX8	Aux Out 1–8 signal
ST L/R	Stereo Out signal
INS CH1–INS CH32	Input Channel 1–32 Insert Out
INS BUS1–INS BUS8	Bus Out 1–8 Insert Out
INS AUX1–INS AUX8	Aux Out 1–8 Insert Out
INS ST-L/ST-R	Stereo Out Insert Out
CAS BUS1–BUS8	Bus 1–8 Cascade Outs
CAS AUX1–AUX8	Aux Bus 1–8 Cascade Outs
CAS ST-L/ST-R	Stereo Bus Cascade Outs
CASSOLOL/CASSOLOR	Solo Bus Cascade Outs

- 2 Move the cursor to a patch parameter you wish to change, then rotate the Parameter wheel or press the **[INC]/[DEC]** buttons to modify the patching.
- 3 Press **[ENTER]** to confirm the change.

Tip: You can store the Output Patch settings to the Output Patch library. Refer to Chapter 16 for more information.

Patching the 2TR Digital Outputs

Follow the steps below to change the signal path patched to the 2TR OUT DIGITAL connector.

- 1 Press the DISPLAY ACCESS [PATCH] button repeatedly until the Patch | 2TR Out page appears.

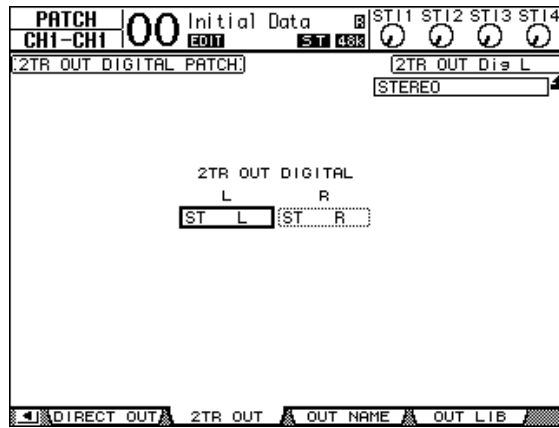

Signals assigned on the Out Patch page can also be assigned on this page.

- 2 Move the cursor to a patch parameter you wish to change, then rotate the Parameter wheel or press the [INC]/[DEC] buttons to modify the patching.
- 3 Press [ENTER] to confirm the change.

10

Input & Output Patching

Patching Direct Outs

Input Channel 1–32 signals can be directly patched to any outputs or slot outputs, as well as Bus Out 1–8 and Stereo Out. This patching is convenient when you wish to record each Input Channel signal to an individual track on a connected recorder.

- 1 Press the DISPLAY ACCESS [PATCH] button repeatedly until the Patch | Direct Out page appears.

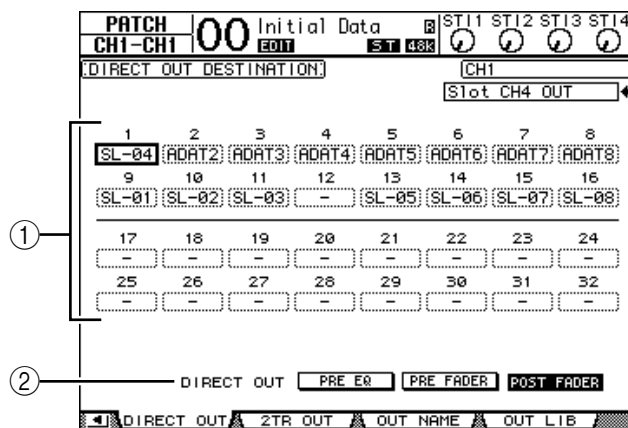

The parameters on this page are described below.

- ① **1–32**
These boxes indicate the Direct Out destination (outputs, ADAT OUT output channels, and slot output channels) for Input Channels 1–32.
- ② **DIRECT OUT**
Determines the Direct Out signal source position from the following three options:

- **PRE EQ**..... Immediately before Input Channel EQ
- **PRE FADER**..... Immediately before Input Channel fader
- **POST FADER** Immediately after Input Channel fader

2 Move the cursor to a patch parameter (1–32) you want to change, then rotate the Parameter wheel or press the [INC]/[DEC] buttons to select the destination.

If necessary, specify the signal source position using the DIRECT OUT parameter.

3 Press [ENTER] to confirm the change.

***Note:** If you select a destination that is already used by an Output Patch setting and turn on the Direct Out, the Output Patch setting will be disabled. To restore the Output Patch setting, select another Direct Out destination or turn off the Direct Out.*

4 Press the DISPLAY ACCESS [PAN/ROUTING] button repeatedly until one of the following pages containing the channels you want to patch to the Direct Out appears.

- **Rout1-16 page** This page enables you to change the Input Channel 1–16 routings.
- **Rout17-STI page** This page enables you to change the Input Channels 17–32 and ST IN Channel 1–4 routings.

***Tip:** Refer to page 86 for more information on these pages.*

5 Move the cursor to the D button for the channel you want to patch to the Direct Out, then press [ENTER].

The Direct Out patching is now effective, and the signals are routed to the assigned outputs, ADAT OUT channels, or slot output channels.

Insert Patching

The 01V96's Input Channels and Output Channels (Stereo Out, Bus Out 1–8, Aux Out 1–8) feature independent Insert Ins and Outs. Inputs, outputs, ADAT connector channels, slot channels, and internal effects processor inputs and outputs can be patched to the Output Channel Insert Ins and Outs. In this way, you can send the signals to external effects processors for processing, or insert internal effects.

Individual Insert Patching

You can patch the 01V96's inputs, outputs, ADAT connector channels, slot channels, and effects processor inputs and outputs to the Insert Ins and Outs. The same procedure applies to both Input Channels and Output Channels.

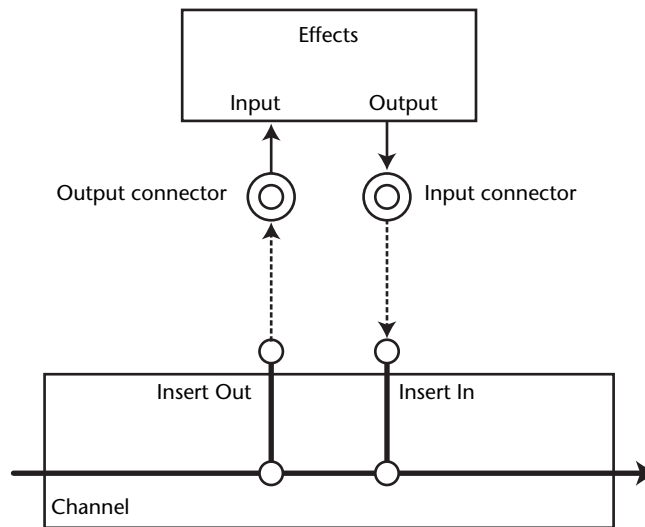

- 1 Press the [SEL] button of an Input Channel or Output Channel for Insert patching.
- 2 Press the [ϕ /INSERT/DELAY] button repeatedly until the ϕ /INS/DLY | Insert page appears.

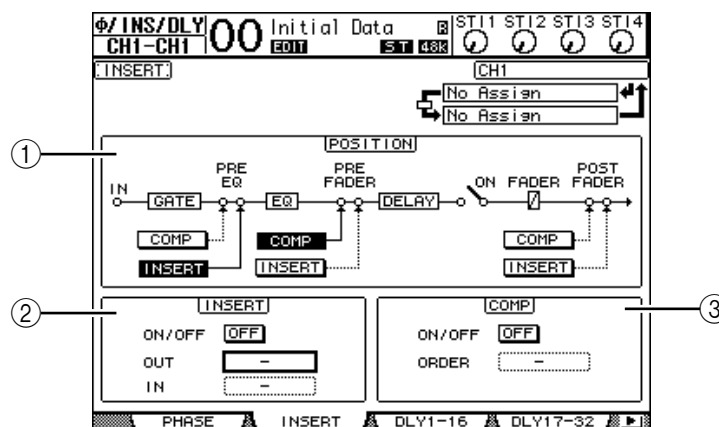

This page contains the following parameters:

① **POSITION**

This parameter determines the insert position of the Insert patch or compressor. The insert position is indicated by highlighted COMP or INSERT buttons.

② **INSERT section**

- **ON/OFF** This button turns the Insert on or off.
- **OUT** This parameter enables you to select outputs, ADAT OUT channels, slot output channels, or internal effects inputs as the Insert Out destination.
- **IN** This parameter enables you to select inputs, ADAT IN channels, slot input channels, or internal effects outputs as the Insert In source.

③ **COMP section**

- **ON/OFF** This button turns the compressor on or off.
- **ORDER** This parameter determines the order of Insert patch and compressor when they are inserted at the same signal path point. With the “COMP → INS” setting, signals pass through the compressor first, then the Insert. With the “INS → COMP” setting, signals pass through the Insert first, then the compressor.

3 Move the cursor to the OUT parameter box, then rotate the Parameter wheel or press the [INC]/[DEC] buttons to select the desired outputs, slot channels, or internal effects inputs to be patched to Insert Out.

The parameter indicators are explained below:

Parameter values	Description
–	No assignment
ADAT 1–ADAT 8	ADAT OUT Output Channels 1–8
SL-01–SL-16	Slot Channels 1–16
OMNI1–OMNI4	OMNI OUT connectors 1–4
2TD-L/2TD-R	2TR OUT DIGITAL (L/R)
FX1-1/FX1-2	Inputs 1 & 2 of Internal Effects Processor 1
FX2-1/FX2-2	Inputs 1 & 2 of Internal Effects Processor 2
FX3-1/FX3-2	Inputs 1 & 2 of Internal Effects Processor 3
FX4-1/FX4-2	Inputs 1 & 2 of Internal Effects Processor 4

4 Press [ENTER] to confirm the change.

If you move the cursor to another parameter box or display another page before you press the [ENTER] button, all settings on this page will be cancelled.

5 Move the cursor to the desired IN parameter box, then rotate the Parameter wheel or press the [INC]/[DEC] buttons to select the inputs, ADAT IN channels, or slot input channels to be patched to the Insert In.

Refer to the explanation regarding the Input Patch for more information on the parameter values (see page 122).

6 Press [ENTER] to confirm the change.

***Tip:** Move the cursor to an empty OUT or IN parameter box and press the [ENTER] button. The Patch Select window appears. Rotate the Parameter wheel or press the cursor buttons to select an item to be patched, then press [ENTER]. Move the cursor to the YES button, then press [ENTER]. The selected item is now patched.*

7 To enable the specified Insert patch, move the cursor to the ON/OFF button in the INSERT section, and press [ENTER] to turn it on or off.

Viewing and Changing Insert In Patch

You can view and also change the items patched to the Insert Ins of all Input Channels (or all Output Channels). This is useful when you wish to find out if multiple channels have the same patch.

- 1 To view the Input Channels' Insert Ins, press the [PATCH] button repeatedly until the Patch | Input Ins page appears.

This page displays Input Channels 1–32 Insert In Patches.

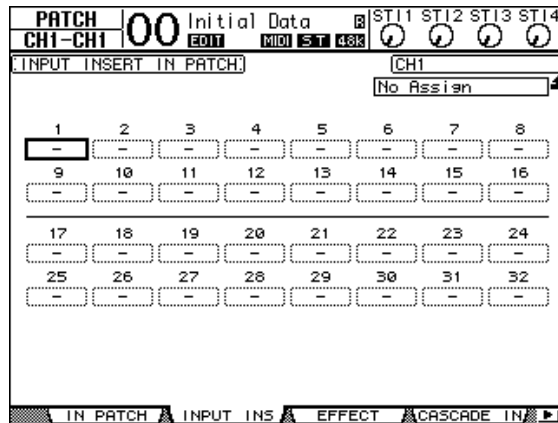

- 2 Move the cursor to a channel patch parameter box you wish to change, then rotate the Parameter wheel or press the [INC]/[DEC] buttons to modify the patching.
- 3 Press [ENTER] to confirm the change.
- 4 To view the Output Channels' Insert Ins, press the [PATCH] button repeatedly until the Patch | Output Ins page appears.

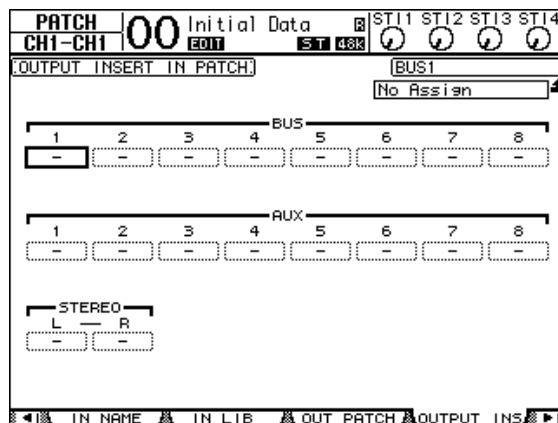

- 5 Move the cursor to a channel patch parameter box you wish to change, then rotate the Parameter wheel or press the [INC]/[DEC] buttons to modify the patching.
- 6 Press [ENTER] to confirm the change.

11 Monitoring

This chapter explains how to set up monitoring and use the Solo function on the 01V96.

Monitor

The 01V96 features the stereo signal path to feed the monitors. The monitoring signal source is patched to MONITOR OUT connectors L & R and the PHONES connector.

The following diagram illustrates the monitoring signal flow.

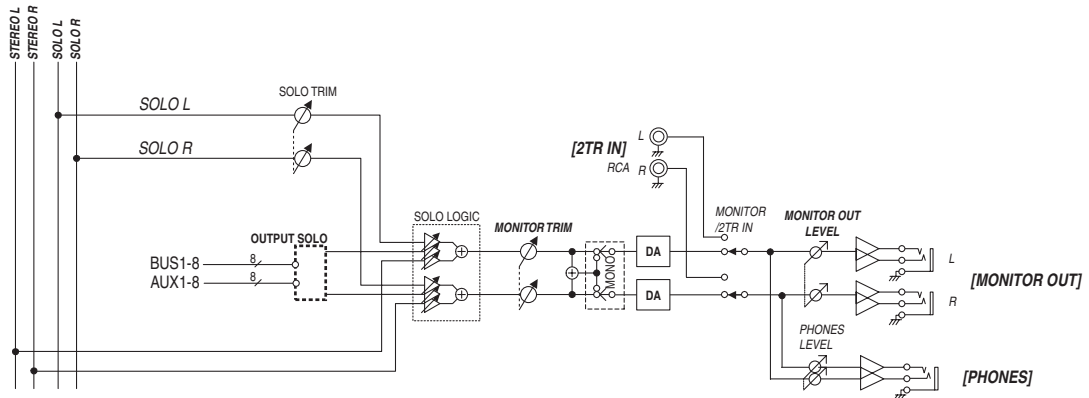

- **SOLO bus**

This special bus routes soloed Input Channels to the Monitor outputs, bypassing Bus 1–8 and the Stereo Bus.

- **OUTPUT SOLO**

This section routes soloed Output Channels (Aux Out 1–8, Bus Out 1–8) to the Monitor outputs.

***Note:** Input and Output Channels cannot be solo-monitored simultaneously. The solo function for the most-recently soloed channels is enabled.*

- **MONITOR TRIM**

This section adjusts the monitoring signal level in the digital domain.

- **MONITOR OUT LEVEL**

Use the MONITOR [MONITOR OUT] control on the top panel to adjust the monitoring signal level in the analog domain.

- **MONITOR/2TR IN**

As a monitoring signal, you can select either the 01V96 internal signals or 2TR IN digital inputs.

- **PHONES**

The Monitor signal is also fed to the PHONES jack. You can set the level independently.

Monitor and Solo Setup

For monitoring and solo setup, press the DISPLAY ACCESS [DIO/SETUP] button repeatedly until the DIO/Setup | Monitor page appears.

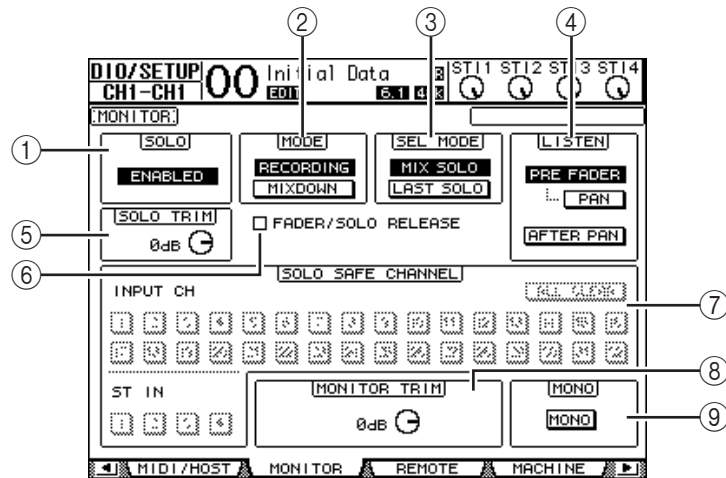

This page contains the following parameters:

① **SOLO**

This parameter turns the Solo function on or off. By default, it is set to Enabled.

② **MODE**

This parameter determines how the Solo function works. There are two options. The setting affects only Input Channels.

- **RECORDING** In Recording Solo mode, soloed Input Channel signals are fed to the Solo bus and output via the Monitor outputs. Other buses (Stereo bus and Bus 1–8) are unaffected by this mode.
- **MIXDOWN** In Mixdown Solo mode, soloed Input Channel signals are fed to the Stereo bus and output via the Monitor outputs. Unsoloed Input Channels are not fed to the Stereo bus while the Solo function is enabled.

Tip:

- Recording Solo mode is convenient when you wish to monitor certain Input Channels while recording, since the Stereo bus and Bus 1–8 signals are unaffected.
- Mixdown Solo mode is useful when you wish to mute unsoloed Input Channels and feed soloed Input Channel signals to the Stereo bus during mixdown.

③ **SEL MODE**

This parameter determines how the Input Channels will be soloed when you press the [SOLO] button of each Channel. There are two options.

- **MIX SOLO** In Mix Solo mode, any number of channels can be soloed simultaneously.
- **LAST SOLO** In Last Solo mode, only one channel can be soloed at a time by pressing the [SOLO] button. The Solo function that was previously enabled for channels is automatically cancelled.

④ **LISTEN**

This parameter determines the source of the Input Channel Solo signal: Pre Fader or Post Pan. When Pre Fader is selected, turning on the PAN button below the Pre Fader option will solo the channel with the pan position specified by the Pan setting even if the source precedes the fader. This parameter is effective only in Recording Solo mode.

⑤ **SOLO TRIM**

This parameter enables you to trim the level of the Solo signal in the range of -96 dB to $+12$ dB.

⑥ **FADER/SOLO RELEASE**

If this check box is checked, you can unsolo the channels by raising the channel faders that were at the level of $-\infty$ when the Solo function was turned on. If the faders were set to higher than $-\infty$, the channels cannot be soloed. This setting is not effective in Mix-down Solo mode and for Output Channels.

Note: When you check the FADER/SOLO RELEASE check box, the Solo setting is temporarily cancelled.

⑦ **SOLO SAFE CHANNEL**

For Mixdown Solo mode, Input Channels can be configured individually so that they are not muted when other Input Channels are soloed (Solo Safe function). Signals from Input Channels with the SOLO SAFE CHANNEL button turned on are always fed to the Stereo bus, regardless of the channels' Solo function status. You can clear all Solo Safe settings by turning on the ALL CLEAR button.

Tip: For example, if you set the internal effects processor's return signal to Solo Safe, you can monitor the soloed "processed (or wet)" signals.

⑧ **MONITOR TRIM**

This parameter enables you to trim the level of the monitoring signal in the range of -96 dB to $+12$ dB.

⑨ **MONO**

This button switches the Monitor signal into mono.

Using the Monitor

1 Connect a monitoring system to the MONITOR OUT connectors.

To monitor the signal via headphones, connect headphones to the PHONES jack.

2 Press the Monitor Source selector in the MONITOR section to select the monitoring signal source.

To monitor the 01V96's internal signals, turn off the selector (the button should be raised). To monitor the signals at the 2TR IN connectors, turn on the selector (the button should be pushed in).

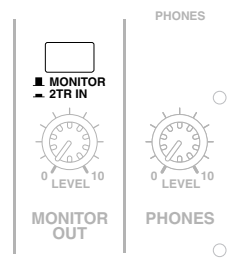

3 Adjust the monitoring level using the MONITOR [MONITOR LEVEL] control while playing the sound sources.

To adjust the level of the monitoring signal via headphones, turn the [PHONES LEVEL] control.

Using the Solo Function

You can solo and monitor Input Channels, Aux Out 1–8, and Bus Out 1–8 using the [SOLO] buttons on the top panel.

- 1 Press the [DIO/SETUP] button repeatedly until the DIO/Setup | Monitor page appears.**
- 2 Set the SOLO parameter to On.**
Set other parameters on the page, if necessary.
- 3 To solo and monitor Input Channels, press the corresponding LAYER button to select a Layer that contains the desired channels, then press the channel [SOLO] buttons.**

The channel [SOLO] button indicators and the SOLO [SOLO] indicator light up. Only the soloed Input Channel signals are fed to the Monitor outputs.

***Tip:** If the SEL MODE parameter is set to Mix Solo on the DIO/Setup | Monitor page, you can solo multiple Channels simultaneously.*

- 4 To solo and monitor Output Channels, press the LAYER [MASTER] button, then press the channel [SOLO] buttons.**

Input and Output Channels (Aux Out 1–8, Bus Out 1–8) cannot be solo-monitored simultaneously. For example, if you solo an Input Channel, then solo an Output Channel, the first solo channel is cancelled.

If you solo an Output Channel first, then solo an Input Channel, canceling the Input Channel's solo will activate the Output Channel's solo.

- 5 You can unsolo all soloed channels by pressing all illuminated channel [SOLO] buttons.**

The button indicators turn off. You can also unsolo all soloed channels by pressing the SOLO [CLEAR] button.

12 Surround Pan

This chapter describes surround panning, which determines how Input Channel signals are panned within and across the stereo field.

About Surround Pan

The Surround Pan function places a sound image within a two-dimensional field using a multi-channel playback system, and pans the image to the front, rear, left, and right in relation to the listening position. To pan the stereo image, you can use the Parameter wheel, or [INC]/[DEC] buttons.

If each channel's follow pan (see page 89) is turned off, you can route the signals to the corresponding Bus Outs regardless of the Surround Pan setting. This is convenient when you wish to assign the surround source or surround effect returns to the Buses.

If "Nominal Pan" (see page 231) in the Prefer1 page is checked, the level of the Input Channels that are panned hard left or right will be used as the nominal level. If the check box is not checked, the nominal level will be +3dB.

Note: If you save a scene with the Follow Pan function turned off while using a 01V96 that runs firmware older than Version 2.0, the surround settings of the scene may not be played back correctly.

You can also store the surround pan settings in a Scene. In addition to a normal Stereo mode, the 01V96 features the following three Surround modes:

- **3-1**

This mode uses four channels that include front left, front right, front center, and rear.

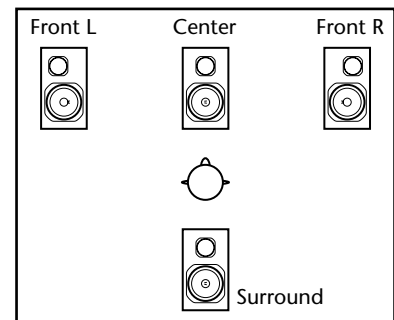

- **5.1**

This mode uses six channels that include front left, front right, rear left, rear right, front center, and subwoofer.

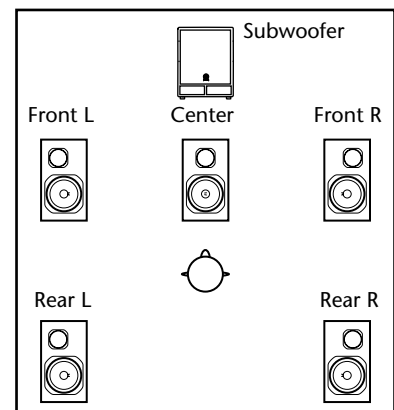

- **6.1**
This mode uses seven channels that include six channels of 5.1 mode plus rear center.

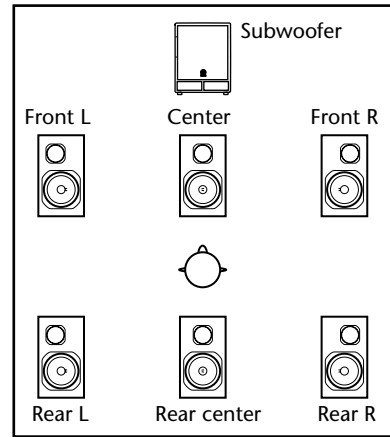

When you select one of these Surround modes, each surround channel signal is output as the Bus Out signal specified on the DIO/Setup | Surr Bus page (see page 139).

The following table shows the factory-default Surround Channel to Bus Out assignment in each Surround mode.

Surround Mode	BUS1	BUS2	BUS3	BUS4	BUS5	BUS6	BUS7
3-1	L	R	C	S	—	—	—
	Front left	Front right	Center	Surround			
5.1	L	R	Ls	Rs	C	LFE	—
	Front left	Front right	Rear left	Rear right	Center	Subwoofer	
6.1	L	R	Ls	Rs	C	Bs	LFE
	Front left	Front right	Rear left	Rear right	Center	Rear center	Subwoofer

Tip: You can set the surround pan either independently of normal panpots or in unison with them.

Setting Up and Selecting Surround Pan Modes

To configure the surround environment, select 3-1, 5.1, or 6.1 Surround mode on the 01V96 and connect a digital MTR or multi-channel monitoring system to the 01V96.

- 1 Press the DISPLAY ACCESS [PAN/ROUTING] button repeatedly until the Pan/Route | Surr Mode page appears.

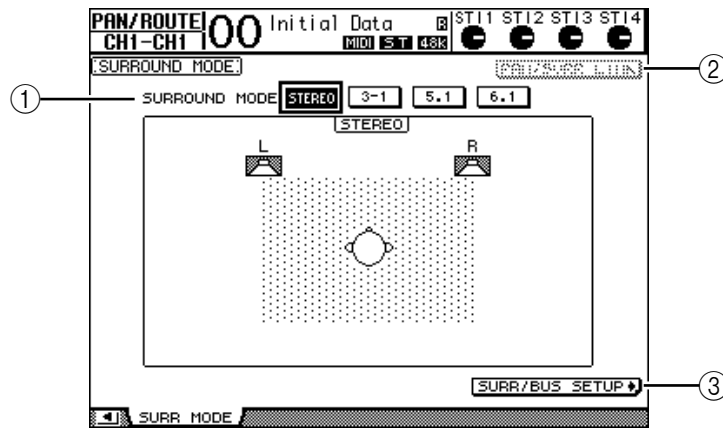

① **SURROUND MODE**

This parameter enables you to select a Surround mode by using the following buttons. The button that is turned on (highlighted) indicates the currently-selected Surround mode.

- **STEREO**.....The 01V96 uses normal stereo mode (default).
- **3-1**.....Selects 3-1 Surround mode.
- **5.1**.....Selects 5.1 Surround mode.
- **6.1**.....Selects 6.1 Surround mode.

② **PAN/SURR LINK**

When this button is turned on, Input Channel panpots and stereo surround panning are linked.

③ **SURR./BUS SETUP**

Press this button to display the Surr/Bus Setup page, which enables you to change the Surround Channel to Bus Out assignment.

2 Move the cursor to the Surround mode button you want to use.

When you move the cursor to one of these buttons, speaker icons appear, indicating a typical listening position and the Surround Channel to Bus Out configuration.

• **3-1 Surround**

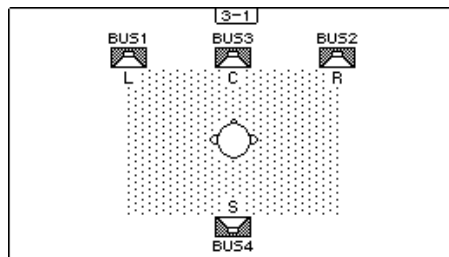

• **5.1 Surround**

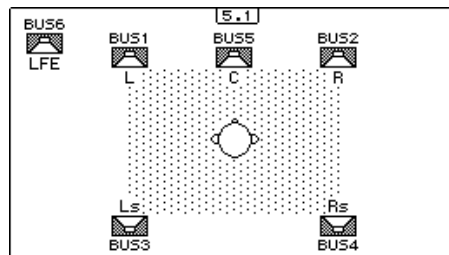

• **6.1 Surround**

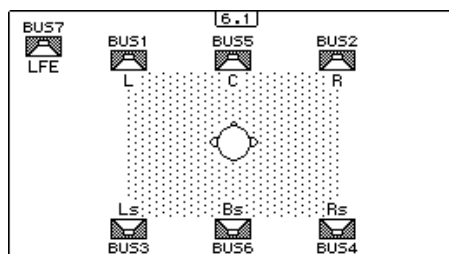

3 Press the [ENTER] button.

The confirmation window for changing the Surround mode appears.

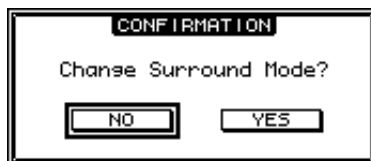

4 Move the cursor to the YES button, then press [ENTER].

The 01V96 enters the selected Surround mode.

5 To link the Input Channel Pan setting with the stereo surround panning, move the cursor to the PAN/SURR LINK button, then press [ENTER].

When the PAN/SURR LINK button is turned on, adjusting the Input Channel pan settings will also change the stereo surround panning accordingly, and vice versa.

- 6 To change the Surround Channel to Bus Out assignment, move the cursor to the SURR/BUS SETUP button, then press [ENTER].

The DIO/Setup | Surr Bus page appears.

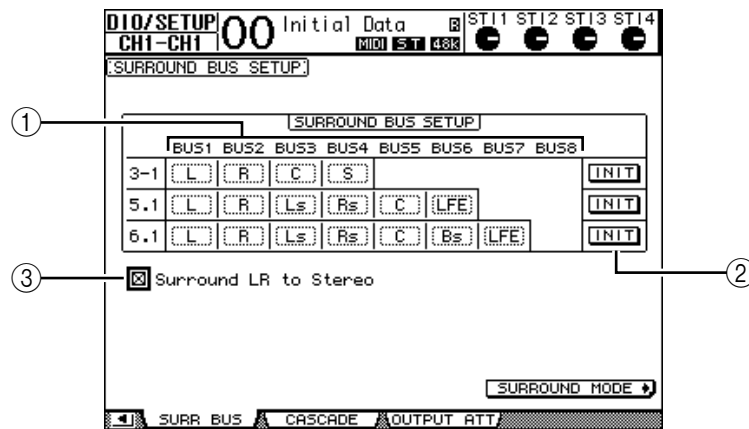

① **BUS1–BUS8**

These parameters select channels to be assigned to the Bus Outs in 3-1, 5.1, and 6.1 Surround modes.

② **INIT**

These buttons reset the channel assignment to the default setting.

③ **Surround LR to Stereo**

When this check box is on, the left and right front signals of the surround channels are output from the STEREO L & R connectors.

- 7 To change the assignment, move the cursor to the desired Bus parameter, rotate the Parameter wheel to select a channel, then press [ENTER].

The channels are swapped between the selected Bus and the Bus to which the channel assigned to the selected Bus was assigned previously.

Tip:

- Pressing the DISPLAY ACCESS [SETUP] button repeatedly also displays the Surr Bus page.
- Available Bus Outs vary depending on the Surround mode. For example, in 3-1 Surround mode, Bus Outs 1–4 are available. In 5.1 Surround mode, Bus Outs 1–6 are available, and in 6.1 Surround mode, Bus Outs 1–7 are available.

- 8 Depending on the selected Surround mode or applications, patch the Bus Out signals to the outputs, ADAT OUT channels, or slot output channels. Connect a playback device or MTR to the output connectors.

■ Surround Pan Recording

To record surround pan movement to a digital MTR, route the Bus Outs to the ADAT OUT channels or slot output channels that are connected to the digital MTR.

The following diagram illustrates an example of recording 5.1 Surround mode signals to a digital MTR.

01V96

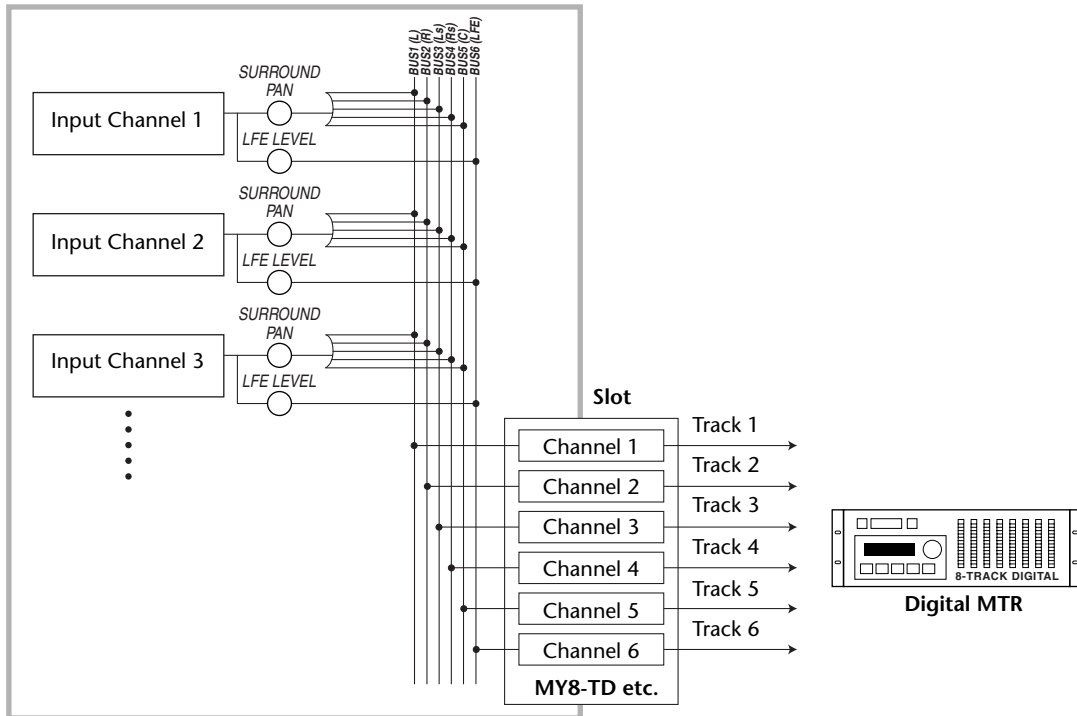

■ **Surround Pan Monitoring**

To monitor surround pan movement, patch the Bus Outs to the analog outputs, to which a monitoring system is connected.

The following diagram illustrates an example in which Bus Out 1 & 2 (left and right front channel) signals are output from the STEREO OUT L & R connectors and Bus Out 3-6 signals are output from the OMNI OUT 1-4 connectors in 5.1 Surround mode.

01V96

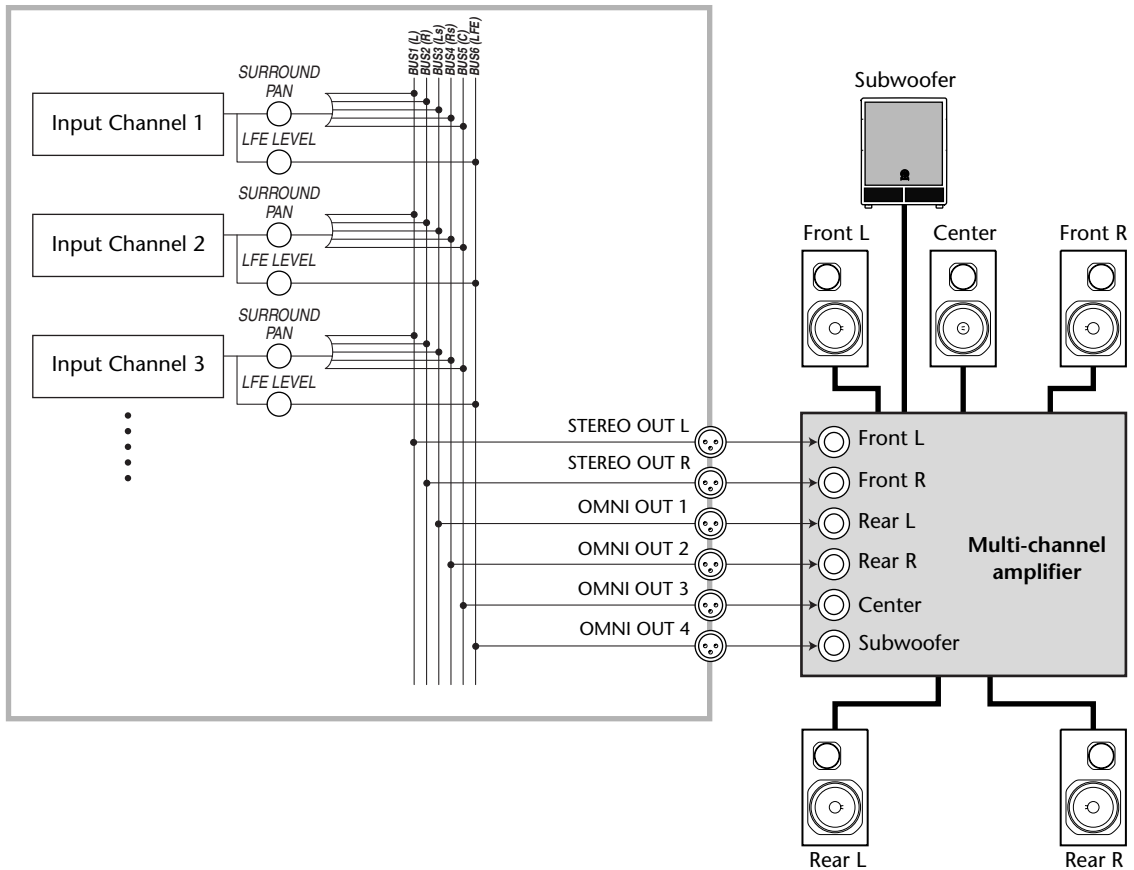

Tip: To output left and right front signals of the surround channels from the STEREO OUT L & R connectors, turn on the Surround LR to Stereo checkbox on the Surr Bus page.

Surround Panning

You can set the surround pan parameters for each Input Channel.

- 1 Make sure that the 01V96 is in any Surround mode except Stereo, then press the [SEL] button of the channel for which you want to set surround pan.
- 2 Press the DISPLAY ACCESS [PAN/ROUTING] button repeatedly until the Pan/Route | Ch Edit page appears.

The Ch Edit page displays the selected Input Channel, and its surround pan setting and available pair partner.

The following display page is an example in 6.1 Surround mode.

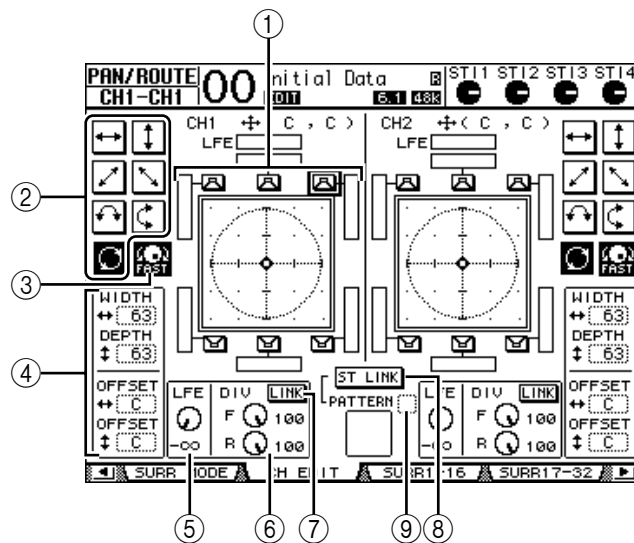

The following parameters are available on this page:

- ① **Surround pan graph**
This graph indicates the pan positions in a two-dimensional field, with the listening position in the center. A small diamond (◆) indicates the current surround pan position. You can move the current surround pan position (◆) directly to one of the speaker icons by selecting its icon, then pressing [ENTER].
- ② **Trajectory patterns**
These buttons represent seven trajectory patterns that determine how the surround pan moves when you operate the Parameter wheel or the [INC]/[DEC] buttons.
- ③ **FAST**
Turning on this button increases the speed of sound images panned via the Parameter wheel.
- ④ **Trajectory pattern parameters**
These parameters fine-tune the surround pan trajectory pattern.
 - **WIDTH** ↔ This parameter sets the left-to-right width of the selected trajectory pattern.
 - **DEPTH** ‡ This parameter sets the front-to-rear width of the selected trajectory pattern.
 - **OFFSET** ↔ This parameter offsets the left-to-right direction of the selected trajectory pattern.
 - **OFFSET** ‡ This parameter offsets the front-to-rear direction of the selected trajectory pattern.

⑤ **LFE**

This parameter control sets the level of the LFE (Low Frequency Effects) Channel signal routed to the subwoofer, and appears only in 5.1 and 6.1 Surround modes.

⑥ **F/R**

In 6.1 Surround mode, F and R parameter controls appear. The F parameter control determines how the Front Center signal is fed to the Left and Right channels, and the R parameter control determines how the rear surround signal is fed to the Left and Right surround channels.

⑥ **DIV**

This parameter control, instead of the F/R parameter control, appears in 3-1 or 5.1 Surround mode, and determines how the Center signal is fed to the Left, Right, and Center channels. It is expressed as a percentage ranging from 0 to 100%. When you set the parameter to 100, the Center signal is fed to only the Center channel. When you set the parameter to 0, the Center signal is fed to only the Left and Right channels. When you set the parameter to 50, the Center signal is fed equally to the Left, Right, and Center channels.

⑦ **LINK**

This button is available only in 6.1 Surround mode. When you turn on this button, the F and R controls are set to the same value, and linked together.

⑧ **ST LINK**

Turning on this button links the surround pan parameters of two Input Channels that are currently displayed on the page (Stereo Link function). You can link the surround pan parameters of two channels regardless of whether they are paired.

⑨ **PATTERN**

When Input Channels are linked by the Stereo Link function, the seven patterns selectable here determine how the linked surround pan moves via the Parameter wheel and the [INC]/[DEC] buttons.

3 Select one of seven trajectory patterns by turning on the corresponding trajectory pattern button.

The following patterns are available:

-  The sound image moves between left and right.

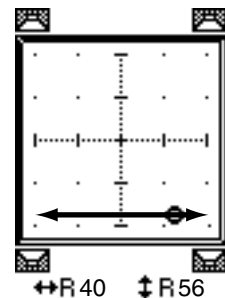
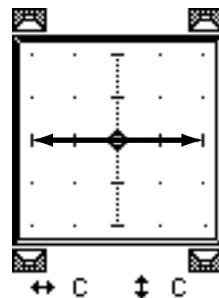
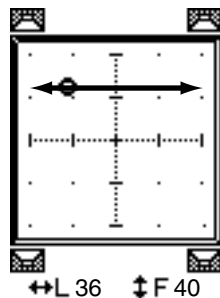

-  The sound image moves between front and rear.

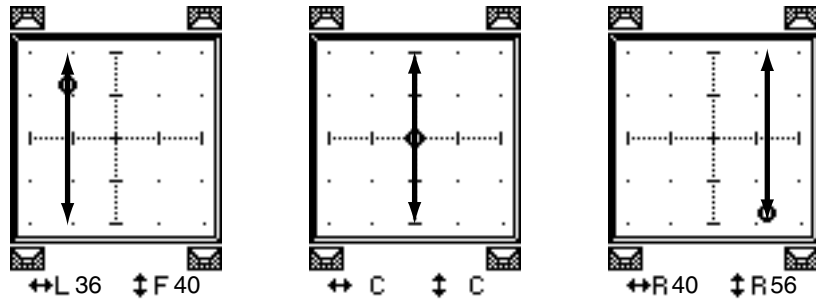

-  The sound image moves from front left to rear right. With this pattern, you can also fine-tune the trajectory by using the WIDTH, DEPTH, OFFSET (↓), and OFFSET (↔) parameters.

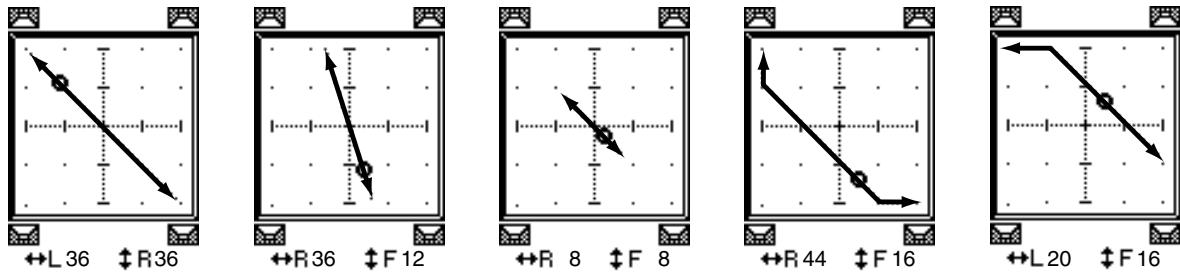

-  The sound image moves from front right to rear left. With this pattern, you can also fine-tune the trajectory using the WIDTH, DEPTH, OFFSET (↓), and OFFSET (↔) parameters.

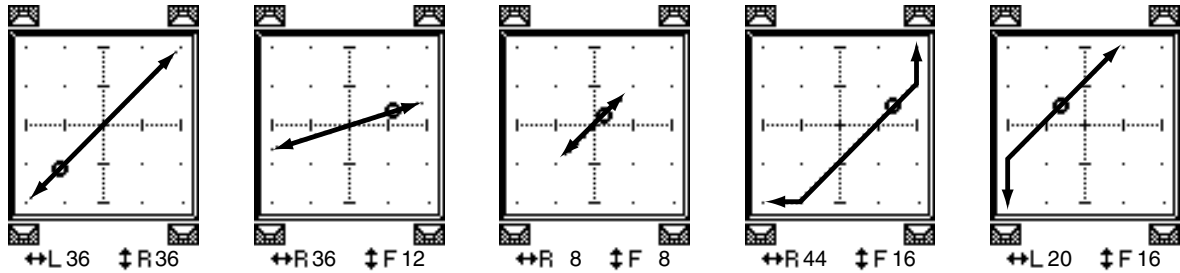

-  The sound image moves between left and right while tracing an arc. With this pattern, you can also fine-tune the radius and shape of the arc using the WIDTH, DEPTH, OFFSET (↓), and OFFSET (↔) parameters.

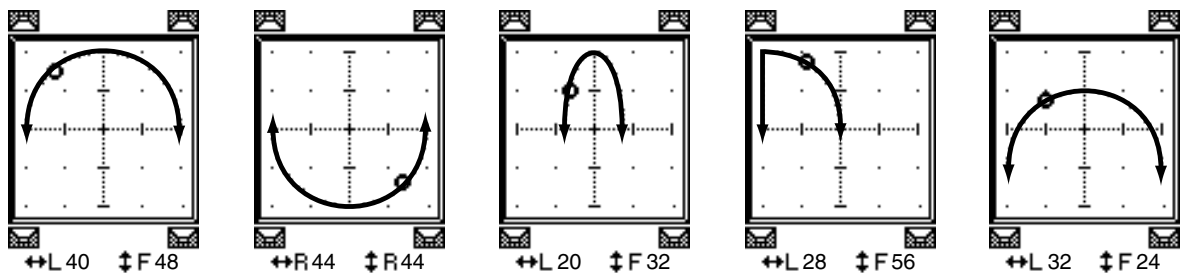

-  The sound image moves between front and rear while tracing an arc. With this pattern, you can also fine-tune the radius and shape of the arc using the WIDTH, DEPTH, OFFSET (\updownarrow), and OFFSET (\leftrightarrow) parameters.

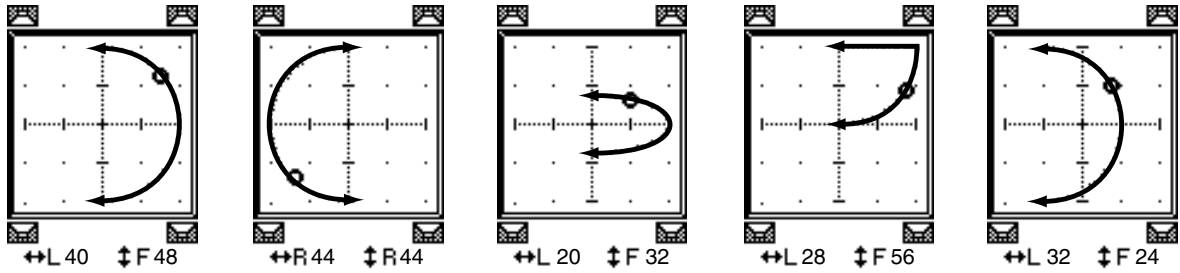

-  The sound image moves while tracing a circle or oval. With this pattern, you can also fine-tune the radius and shape of the circle or oval using the WIDTH, DEPTH, OFFSET (\updownarrow), and OFFSET (\leftrightarrow) parameters.

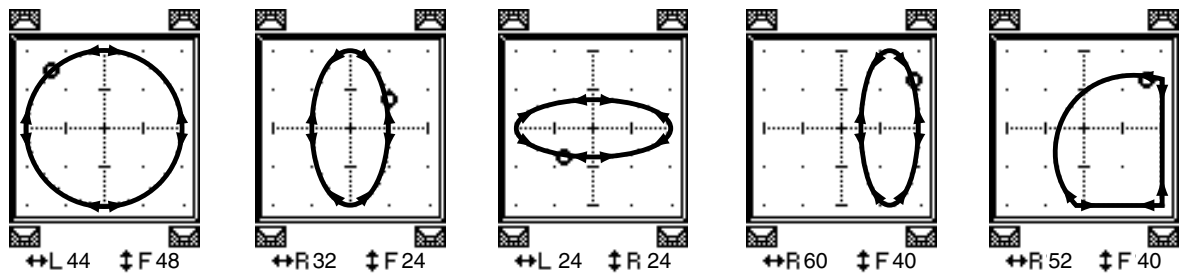

- If necessary, fine-tune the trajectory by editing the WIDTH, DEPTH, OFFSET (\updownarrow), and OFFSET (\leftrightarrow) parameter values.
- To move the sound image, move the cursor to anywhere outside the parameter boxes, then rotate the Parameter wheel.

The sound image of the selected channel moves along the selected trajectory pattern.

Tip: You can also adjust the front and rear or left and right movement, the trajectory pattern and other parameters from an external MIDI device by assigning the surround parameters to MIDI Control Changes (see page 220).

- To link the surround pan settings of two channels displayed on the page, turn on the ST LINK button.
Use the PATTERN parameter box below the ST LINK button to specify how you want the linked surround pan to move.

The following table shows how the sound images on two linked channels move when different trajectory patterns and stereo link patterns are combined. A solid line indicates the movement of the selected channel, and a dotted line indicates the movement of the linked partner.

Trajectory Pattern							

7 To list multiple-channel surround pan settings, press the [PAN/ROUTING] button repeatedly until the Pan/Route | Surr1-16, Surr17-32, or Surr ST IN page appears.

These pages display and enable you to edit the surround pan settings for 16 channels.

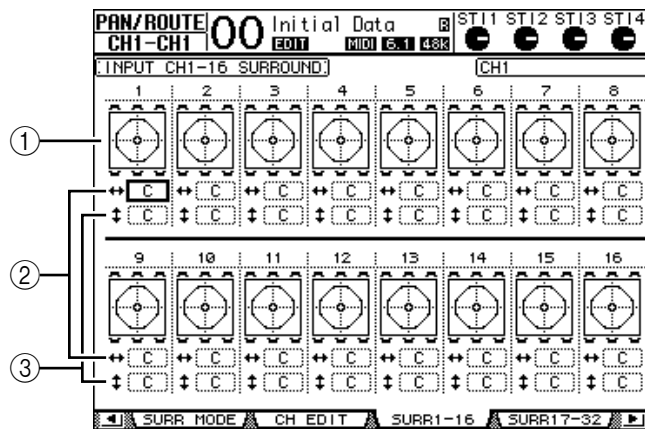

① Surround pan graphs

These graphs display the trajectory patterns and the current pan positions for the Input Channels.

② **↔ parameter box**

This parameter box enables you to move the surround pan setting of the selected channel left and right.

③ **↕ parameter box**

This parameter box enables you to move the surround pan setting of the selected channel front and rear.

8 To move the sound image of each channel on these pages, move the cursor to the desired channel, then rotate the Parameter wheel.

The pan setting of the channel changes along the trajectory pattern. Press [ENTER] to display the currently-selected channel's CH Edit page.

13 Grouping Channels & Linking Parameters

This chapter describes how to group faders or [ON] buttons for multiple channels and link the EQ or compressor parameters for simultaneous operation.

Grouping & Linking

On the 01V96, you can group faders or [ON] buttons for multiple Input Channels (Input Channels 1–32, ST IN Channels 1–4) or multiple Output Channels (Bus Outs 1–8, Aux Outs 1–8, Stereo Out) and link the EQ or compressor parameters.

The following elements can be grouped or linked within Input Channels or Output Channels.

- **Fader group**

Input Channel or Output Channel faders (or level controls) can be grouped. There are eight Input Channel Fader groups and four Output Channel Fader groups. When channel faders or level controls are grouped, operating any one of them enables you to control the level of the other grouped faders or level controls while maintaining the relative level differences.

Also, the 01V96 features a Fader Group Master function that enables you to control the level of all grouped channels using the Group Master level while maintaining the relative level balance between channels.

- **Mute group**

Input Channel or Output Channel [ON] buttons can be grouped. There are eight Input Channel mute groups and four Output Channel mute groups. When channel [ON] buttons are grouped, pressing any one of them turns the [ON] buttons for all the grouped channels on or off. A mute group can include On channels and Off channels at the same time, which turn off or on respectively when you press any one of the grouped [ON] buttons.

Also, the 01V96 features a Mute Group Master function that enables you to mute grouped channels using the Master Mute buttons.

- **EQ Link**

Input or Output Channel EQ parameters can be linked. There are four EQ links for Input Channels and Output Channels respectively.

All channels in an EQ link share the same EQ parameter settings. When you change an EQ parameter value for one of the linked channels, the change is applied to all other linked channels.

- **Compressor Link**

Input or Output Channel compressor parameters can be linked. There are four compressor links for Input Channels and Output Channels respectively.

All channels in a compressor link share the same compressor parameter settings. When you change a compressor parameter value for one of the linked channels, the change is applied to all other linked channels.

Tip: Compressor Link is not available for the ST IN Channels, since they do not feature compressors.

Using Fader Groups and Mute Groups

Follow the steps below to group faders or [ON] buttons for Input Channels or Output Channels.

1 Press the DISPLAY ACCESS [PAIR/GROUP] button repeatedly until one of the pages that contains the desired group and channels appears.

- **In Fader page**
This page enables you to set Fader groups (A–H) for Input Channels 1–32 and ST IN Channels 1–4.
- **Out Fader page**
This page enables you to set Fader groups (Q–T) for Bus Outs (1–8), Aux Outs (1–8) and Stereo Out.

• In Fader page

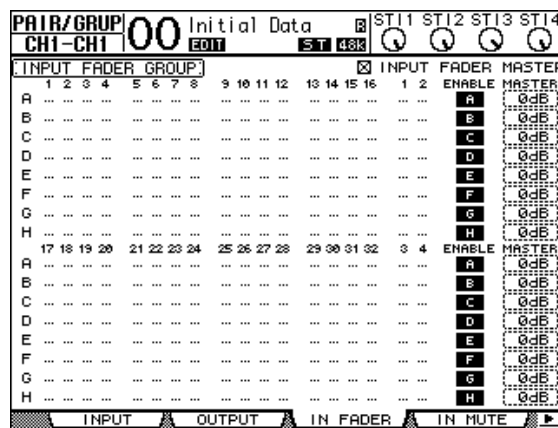

- **In Mute page**
This page enables you to set Mute groups (I–P) for Input Channels 1–32 and ST IN Channels 1–4 respectively.
- **Out Mute page**
This page enables you to set Mute groups (U–X) for Bus Outs (1–8), Aux Outs (1–8) and Stereo Out.

• In Mute page

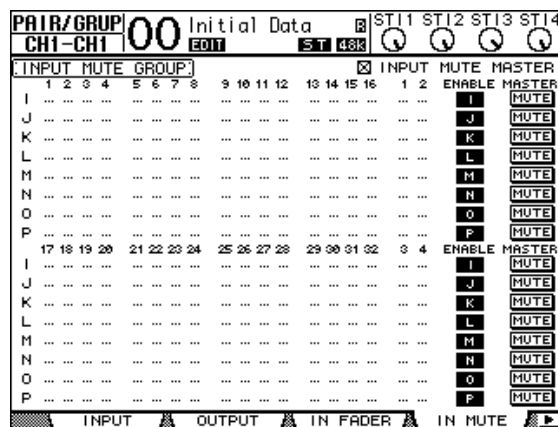

2 Press the up (▲) or down (▼) button to select a group.

INPUT FADER GROUP																INPUT FADER MASTER				
	1	2	3	4	5	6	7	8	9	10	11	12	13	14	15	16	1	2	ENABLE	MASTER
A			A	0dB
B			B	0dB
C			C	0dB
D			D	0dB
E			E	0dB
F			F	0dB

3 Press the [SEL] button for a channel you wish to add to the group.

The selected channel is marked with “●” and the channel is added to the group.

Example: Input Channels 1–4, 7, 8, and 15, 16 have been added to Fader group C.

INPUT FADER GROUP																INPUT FADER MASTER				
	1	2	3	4	5	6	7	8	9	10	11	12	13	14	15	16	1	2	ENABLE	MASTER
A			A	0dB
B			B	0dB
C	●	●	●	●	●	●	●	●			C	0dB
D			D	0dB
E			E	0dB
F			F	0dB

Tip:

- If you add one channel from a pair to a group, the pair partner is automatically added to the group.
- You can also select a channel on another layer by switching layers.

4 In the same way, press the [SEL] button for other channels you wish to add to the group.

The relative level of the faders for the grouped channels is determined by the position of the faders when the channels were added to the group.

The On/Off status of the grouped channels is determined by the [ON] button status when the channels were added to the group.

5 To turn a group on or off, move the corresponding button in the ENABLE column, then press [ENTER].

When the group Enable button is turned off, the corresponding group is temporarily cancelled.

6 To use a fader group, operate one of the faders or level controls for the grouped channels.

Note:

- If you wish to change the relative level balance between the grouped channels while this page is displayed, first turn off the Enable button or remove the channels for which you want to change the level from the group.
- If other pages are displayed, press and hold down the [SEL] button for the desired channels to temporarily remove them from the group, then change the level balance.

7 To use a mute group, press one of the [ON] buttons for the grouped channels.

All channels in the group switch their on/off status.

Note:

- While a mute group is enabled, you cannot turn a subset of the grouped channels on or off.
- If you wish to turn a subset of the grouped channels on or off, first turn off the Enable button, or remove the channels you wish to turn on or off from the group.

Using Fader Group Master

The 01V96 features a Fader Group Master function that enables you to control the level of all channels using the Group Master level while maintaining the relative balance between channels, much like a VCA group on an analog mixing console. While this function is enabled, channel fader operation does not affect channel levels in the corresponding Fader group.

- 1 After you perform Step 5 in “Using Fader Groups and Mute Groups” on page 150, use the cursor buttons to select the INPUT FADER MASTER check box or the OUTPUT FADER MASTER check box, then press [ENTER] to turn on the Fader Group Master function.

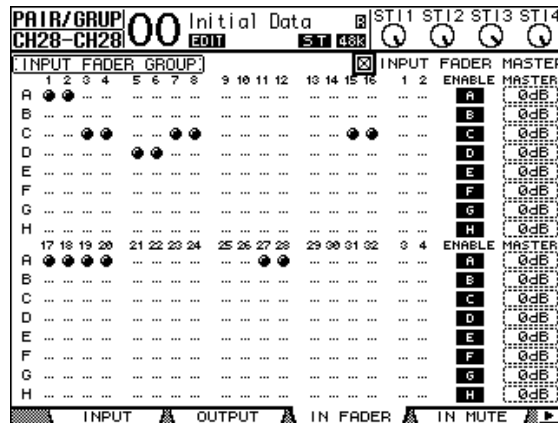

- 2 When the Fader Master check box is checked, you can set channel levels of the Fader groups in the Master column.

When the Master column is selected, repeatedly pressing the [ENTER] button turns the Fader group on and off.

You can also make these settings in the In Master page or Out Master page, as shown below.

- 3 Press the DISPLAY ACCESS [GROUP] button repeatedly until the Group | In Master or Group | Out Master page appears.

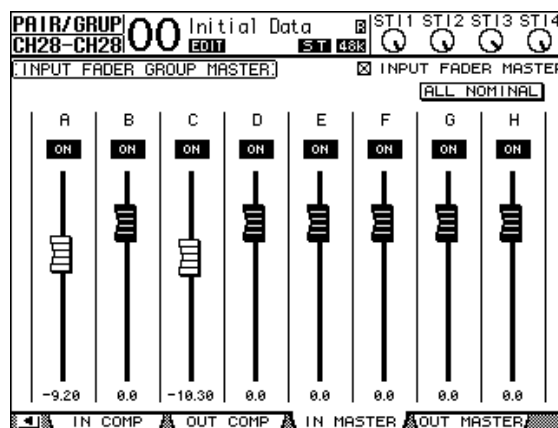

- 4 Use the cursor buttons to select parameters, then use the Parameter wheel, INC/DEC buttons, or [ENTER] button to set the parameters.

- INPUT/OUTPUT FADER MASTER ... When this check box is checked, you can set the master levels for the Fader groups. The resultant Channel level equals the corresponding Channel fader level plus the Group Master level.

- **ALL NOMINAL**..... This button resets the master levels for all Fader groups to nominal.
- **ON/OFF**..... This turns each Input Fader group on or off. This function works like a VCA mute on an analog mixing console.
- **Faders** These faders adjust the master levels of the Fader groups. Fader knobs are highlighted when faders are set to 0.0 dB. Press the [ENTER] button to set the currently-selected fader to 0.0 dB.

You can also control the parameters from the channel strips on the control surface as described below by using the User Assignable Layer of the Remote Layers. See page 233 for information on the User Assignable Layer.

- **[SEL] buttons** These buttons move the cursor on the In Master page or Out Master page.
- **[SOLO] buttons** These buttons turn the Solo function of each Fader group on and off. You can monitor all the channels in each Fader group.
- **Channel Faders** The channel faders enable you to set the master level for each Fader group.

Using Mute Group Master

In addition to the Mute Group function that links the operation of channel [ON] buttons, the 01V96 features a Mute Group Master function that enables you to mute grouped channels using the Master Mute buttons in a manner similar to using a mute group on an analog mixing console. While this function is enabled, the [ON] buttons for grouped channels will not be linked.

- 1 After you perform Step 5 in “Using Fader Groups and Mute Groups” on page 150, use the cursor buttons to select the INPUT MUTE MASTER check box or OUTPUT MUTE MASTER check box, then press [ENTER] to turn on the Mute Group Master function.

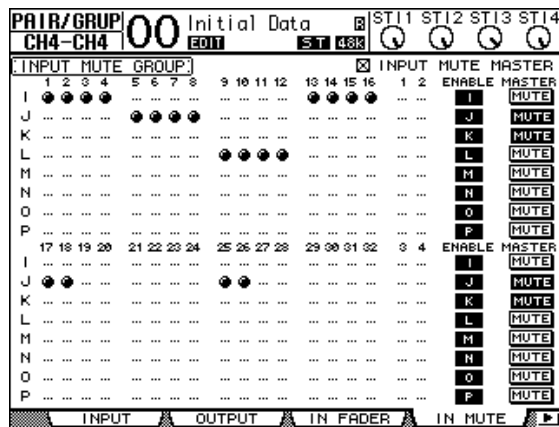

- 2 When the Mute Master check box is checked, use the group MASTER MUTE buttons to mute or unmute the groups.

If channels are muted via the Mute Master function, the channel [ON] button indicators flash. It is useful if you assign the MASTER MUTE buttons to USER DEFINED KEYS buttons.

Linking EQ and Compressor Parameters

Follow the steps below to link EQ or compressor parameters for Input Channels or Output Channels. This function enables you to set EQ or compressor parameters for multiple channels to the same values simultaneously.

- 1 Press the **DISPLAY ACCESS [PAIR/GROUP]** button repeatedly until one of the following pages appears.

- **In EQ page**

This page enables you to set EQ links (a–d) for Input Channels 1–32 and ST IN Channels 1–4.

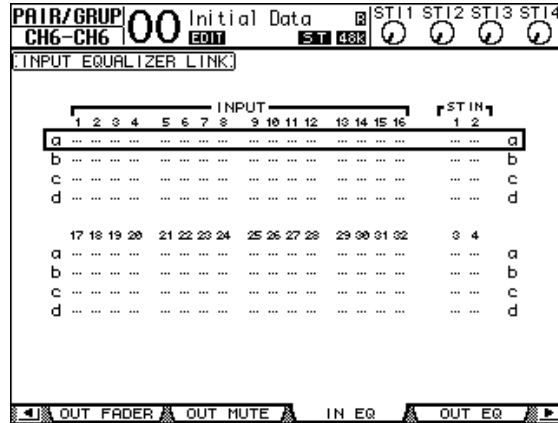

- **Out EQ page**

This page enables you to set EQ links (e–h) for Bus Outs (1–8), Aux Outs (1–8) and Stereo Out.

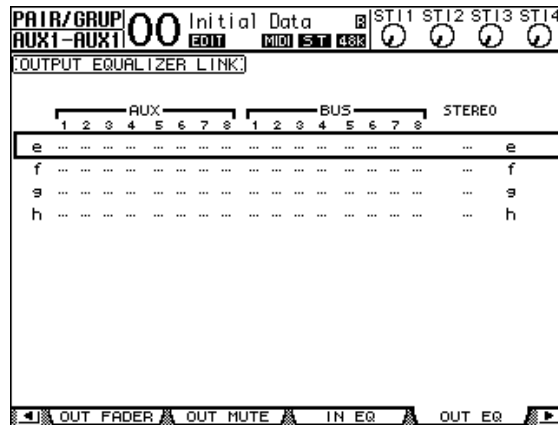

- **In Comp page**
This page enables you to set Compressor links (i-l) for Input Channels 1–32.

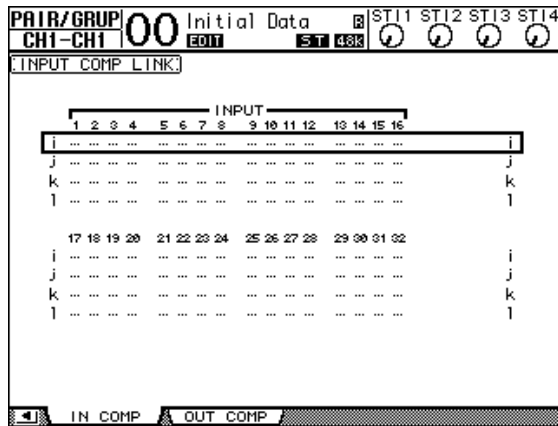

- **Out Comp page**
This page enables you to set Compressor links (m-p) for Bus Outs (1–8), Aux Outs (1–8) and Stereo Out.

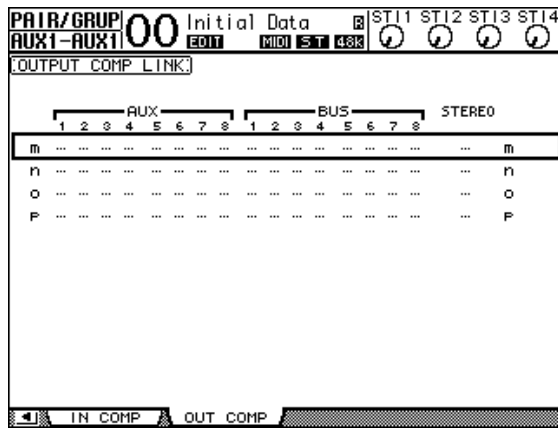

- 2 Press the up (▲) or down (▼) cursor button to select a link to which you want to add channels.

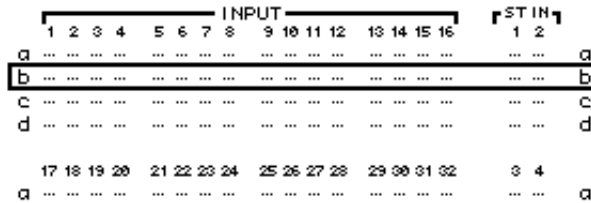

3 Press the [SEL] button for a channel you wish to add to the EQ or Compressor link.

The selected channel is marked with “●” and the channel is added to the link.

Example: Input Channels 1–4, 7, 8, 12 and 14 have been added to EQ link b.

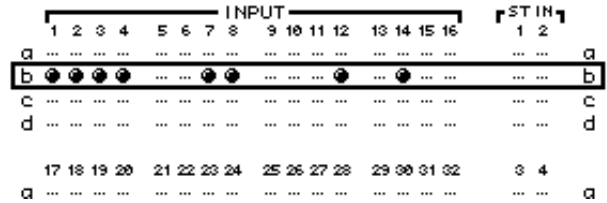

Tip:

- If you add one channel from a pair to a link, the pair partner is automatically added to the link.
- You can also select a channel on another layer by switching layers.

4 In the same way, press the [SEL] button for other channels you wish to add to the link.

The EQ or compressor settings for the first channel added to the link are applied to all subsequently-added channels.

5 After all desired channels are added to the link, edit the EQ or compressor parameters for one of the linked channels.

The edits for the EQ or compressor parameters are applied to the rest of the linked channels.

14 Internal Effects

This chapter describes how to use the 01V96's internal effects processors.

About the Internal Effects

The 01V96 features four internal multi-effects processors. These effects processors offer numerous types of effects, including **reverbs**, **delays**, **modulation-based effects**, and **combination effects** designed especially for use with surround sound.

Note: When the 01V96 operates at a high sampling frequency (88.2 kHz or 96 kHz), you can use only Effects processors 1 and 2.

Processor inputs and outputs can be patched to various sources. For example, effects processor inputs can be fed from the Aux Sends and output to ST IN Channels (effects send/return). Effects processors can also be inserted into Input Channels, Bus Outs, Aux Outs, or the Stereo Out.

Effects processors 1 through 4 create 1-in/2-out or 2-in/2-out effects.

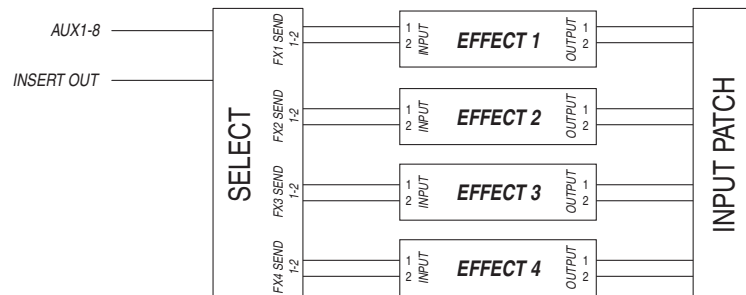

The 01V96 also features the Effects library, which contains 53 preset programs (including Add-On Effects) and 75 user programs.

Using Effects Processors via Aux Sends

You can use effects processors via Aux Sends by patching effects processor inputs to Aux Outs, and effects processor outputs to ST IN Channels.

1 Recall an effect program you wish to use.

Refer to page 179 for more information on recalling effect programs.

2 Press the DISPLAY ACCESS [PATCH] button repeatedly until the Patch | Effect page appears.

This page enables you to patch all inputs and outputs of Effects processors 1–4.

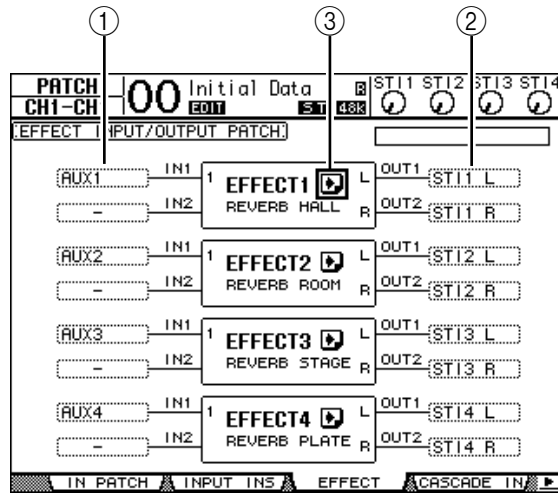

This page contains the following parameters:

- ① **IN**
These parameter boxes select the signals to be fed to the effects processors.
 - ② **OUT**
These parameter boxes select the destination of the signals output from the effects processors.
 - ③ **[Edit] button**
This button recalls the FX1 Edit–FX4 Edit pages, which enable you to adjust the effect parameters.
- 3 To select a signal to be input to the effects processor, move the cursor to the desired In parameter box, select a signal from the following options, then press [ENTER].**
- – No assignment
 - AUX1–8 Aux Sends 1–8
 - INS CH1–32 Input Channel 1–32 Insert Out
 - INS BUS1–8 Bus 1–8 Insert Out
 - INS AUX1–8 Aux Send 1–8 Insert Out
 - INS ST-L/R Stereo Out Insert Out

To use the internal effects processors via Aux Sends, select Aux 1–8 (in most cases).

You can patch a different signal to the other input of 2-in/2-out effect programs.

Tip:

- You can patch a signal to multiple effect inputs.
- Move the cursor to an IN parameter box and press the [ENTER] button. The Patch Select window appears. This window enables you to select the input source quickly.

4 To patch a signal output from the effects processor, move the cursor to the desired OUT parameter box, select the signal destination from the following options, then press [ENTER].

- –No assignment
- CH1–32Input Channels 1–32
- ST IN 1L–ST IN 4RST IN Channels 1L–4R
- INS CH1–32.....Input Channel Insert In
- INS BUS1–8Bus 1–8 Insert In
- INS AUX1–8.....Aux 1–8 Insert In
- INS ST-L & INS ST-R...Stereo Bus Insert In

To use the internal effects processors via Aux Sends, select CH 1–32 or ST IN 1–4 (in most cases). The channels you assign here will become the effects return channels.

You can patch a different channel to the other output of a 1-in/2-out or 2-in/2-out effect program to create stereo effects.

Tip:

- If you select an ST IN Channel as the destination, you can patch the L and R channel signals separately.
- You can also use the Patch Select window to set the OUT parameter boxes, as explained in Step 3.
- The number of inputs available for each effect varies depending on the type of effect programs initially recalled.

Note: You cannot select a channel as the destination of multiple effect signals. If you select a channel that is already selected in another OUT parameter box, that OUT parameter box switches its indicator to “–” (not assigned).

5 Adjust the level of Aux Sends patched to the effects processor.

Refer to “9 Aux Outs” on page 109 for information on setting the Aux Sends.

Note: Do not raise the level of the Aux Sends (patched to the effects processor’s input) on the effects return channels. Otherwise, the signal will return to the same channel, creating a signal loop and possibly damaging your speakers.

Tip: Use the Master layer fader to adjust the final Aux Send output level. At this time, you can view the level on the Meter | Master page (see page 35).

6 Adjust the level, pan, and EQ of the Input Channels patched to the effect outputs.

Tip: To mix the effects sound returned via the Aux sends with the original dry sound, set the effect’s MIX BALANCE parameter to 100% (only the effects sound will be output).

Inserting the Internal Effects into Channels

You can insert the internal effects into certain Input Channels or Output Channels (Bus 1–8, Aux Bus 1–8, or the Stereo Bus).

Note:

- You cannot use Insert In and Out for ST IN Channels.
- If effects are inserted in channels, you cannot use those effects via Aux Sends or insert them into other channels.

- 1 Select an internal Effects processor (1–4), then recall the desired effect programs.
- 2 Press the [SEL] button of the Input Channel or Output Channel into which you want to insert the selected effects.

Tip: Repeatedly pressing the STEREO [SEL] button toggles between the left and right Stereo Bus channels.

- 3 Press the DISPLAY ACCESS [ϕ /INSERT/DELAY] button repeatedly until the ϕ /Ins/Dly | Insert page appears.

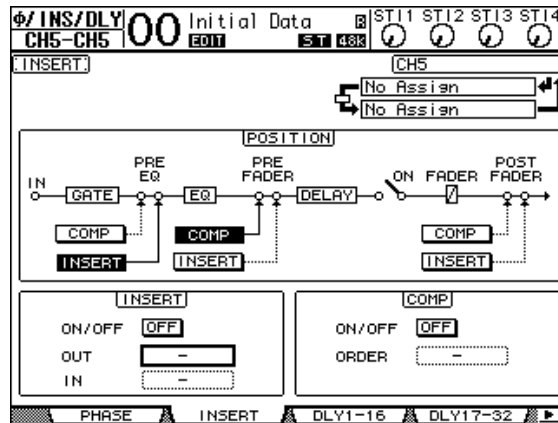

- 4 Select the effect insertion position using the INSERT button in the POSITION section.
- 5 Move the cursor to the OUT parameter box in the INSERT section, then select the inputs of the effects processor selected in Step 1.
 - FX1-1 & FX1-2 Inputs 1 & 2 of Internal Effects Processor 1
 - FX2-1 & FX2-2 Inputs 1 & 2 of Internal Effects Processor 2
 - FX3-1 & FX3-2 Inputs 1 & 2 of Internal Effects Processor 3
 - FX4-1 & FX4-2 Inputs 1 & 2 of Internal Effects Processor 4
- 6 Press [ENTER] to confirm the setting.
- 7 Move the cursor to the IN parameter box in the INSERT section, select the outputs of the effects processor selected in Step 1, then press [ENTER] to confirm the setting.
- 8 Move the cursor to the ON/OFF button in the INSERT section, then press [ENTER] to turn on the button.
Effect insertion is now enabled.

Tip:

- After inserting effects to channels, adjust the MIX BALANCE parameter for the effects, according to the purpose and effects type.
- Move the cursor to an empty IN or OUT parameter box and press the [ENTER] button. The Patch Select window appears, which enables you to quickly select available signal paths.

Editing Effects

To edit effect programs recalled to the internal Effects processors 1–4, press the DISPLAY ACCESS [EFFECT] button repeatedly until the Edit page for the effects processor you wish to edit appears.

Effects processors 1–4 correspond to the following pages:

- **Effects Processor 1**.....FX1 Edit page
- **Effects Processor 2**.....FX2 Edit page
- **Effects Processor 3**.....FX3 Edit page
- **Effects Processor 4**.....FX4 Edit page

These Edit pages contain the following effect parameters.

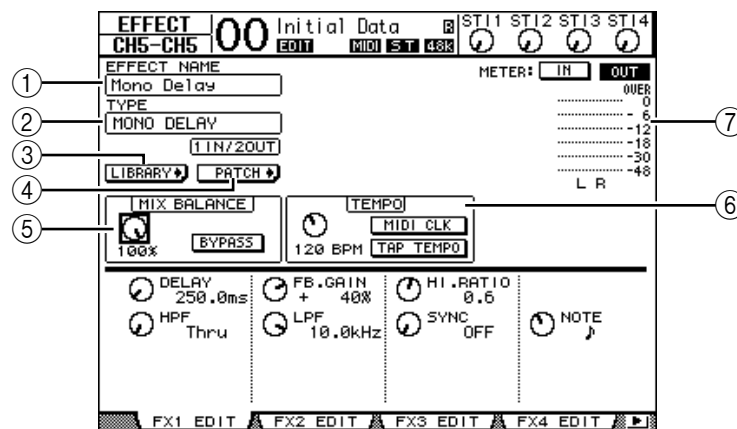

① EFFECT NAME

This parameter displays the name of the effect program currently used by the effects processor.

② TYPE

This parameter displays the type of effect program currently used by the effects processor. The I/O configuration of the effect program is displayed below this parameter.

③ **LIBRARY** button

Move the cursor to this parameter, then press [ENTER] to display the Library page for the selected effects processor.

④ **PATCH** button

Move the cursor to this button, then press [ENTER] to display the Patch | Effect page, which enables you to assign signals to the inputs and outputs of Effects processors 1–4.

⑤ MIX BALANCE

This parameter knob enables you to set the balance between wet and dry signals. When the parameter is set to 0%, only the dry signal is heard. When set to 100%, only the wet signal is heard. Turn on the BYPASS button to bypass the currently-selected effects processor.

⑥ TEMPO

This section enables you to set the tempo and interval of the selected effects, and displays certain parameters only when certain effect types are selected. Use the parameter control on the left side of this section to adjust the value between 25BPM and 300BPM. When the **MIDI CLK button** is on, the 01V96 updates the TEMPO data (BPM) based on the MIDI Clock information received at the MIDI IN port. You can also specify the tempo by moving the cursor to the **TAP TEMPO button** and double-clicking the [ENTER] button. The 01V96 calculates the tempo based on the time interval between your two taps (clicks) on the [ENTER] button.

Tip: If the Freeze effect is selected, the TEMPO section displays the record and playback buttons for using the effect, the recording data condition, and a progress bar that indicates the current status.

⑦ Meters

These meters indicate the input or output levels of the currently-selected effects processor. Select the IN button or OUT button to display the input levels or output levels respectively.

Tip: You can also view the input and output levels of the effects processors on the Meter | Effect 1–4 pages (see page 34).

Move the cursor to a parameter you wish to change, and rotate the Parameter wheel or press the [INC]/[DEC] buttons to adjust the setting. You can store the edited settings as a new program in the Effects library (see page 179).

Note: You cannot change the effects type on this page. To change the effects type, recall a program that uses the desired effects type from the Effects library.

About Add-On Effects

Installing optional Add-On Effects packages enables you to expand your effects selection beyond the internal effects. Add-On Effects will be stored in and recalled from preset #45 and the subsequent preset programs. You can also store edited effects in user program #54 and the subsequent user programs. For more information on Add-On Effects, refer to the installation guide that is included in your Add-On Effects packages.

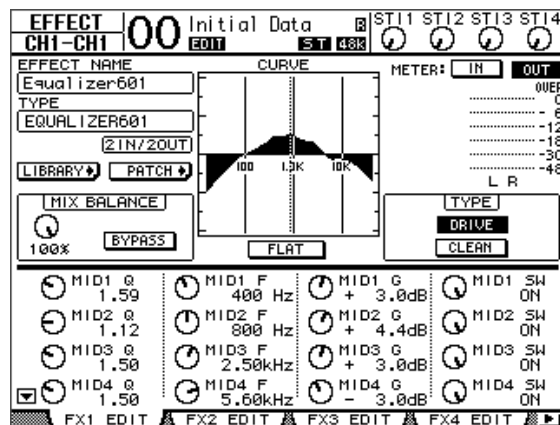

About Plug-Ins

If you installed a mini-YGDAI card that supports the Effects function into Slot, you can use plug-in effects in addition to the internal effects processors.

You can patch Bus signals or channel insert outs to the plug-in input. The plug-in output can be patched to Input Channels or channel insert ins.

To use the plug-in effects, press the [EFFECT] button repeatedly until the Effect | P-In Edit page appears.

For details on using plug-ins, refer to the owner's manual that came with the plug-in card.

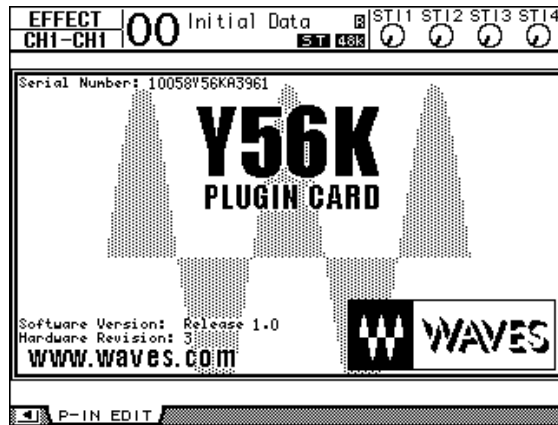

As of July 2004, the 01V96 supports the following plug-in cards. Visit the Yamaha web site (<http://www.yamahaproaudio.com/>) for the latest information on compatible plug-in cards.

- Waves.....Y56K

The Y56K card setting is stored in memory in the card when you store scenes, and is recalled at the time of scene recall. The setting is not stored in a scene memory on the 01V96. Therefore, the setting does not support the scene memory's Global Paste, Sort, and Auto Update functions.

Note: The Y56K card supports scenes #1-96. If you store or recall a scene # 97 or subsequent scenes, the Y56K card setting will not respond. (In this case, a warning message appears.)

15 Scene Memories

This chapter describes Scene memories, which store 01V96 mix and effects settings.

About Scene Memories

Scene memories enable you to store a snapshot of 01V96 channel mix settings and internal effects processor settings as a “Scene” in a special memory area.

There are 99 Scene memories, and you can recall any Scene using the display pages or the controls on the top panel.

Tip:

- You can recall Scenes by transmitting Program Changes from external MIDI devices (see page 219).
- You can back up Scene memories to external MIDI devices by using MIDI Bulk Dump (see page 226).

What is Stored in a Scene?

The following parameter settings are stored in a Scene:

Scene	Parameters
Mix parameters	All channel faders (and level controls)
	Channel to Aux Out 1–8 Send levels
	Aux Out 1–8 & Bus Out 1–8 levels
	All channel [ON] button settings
	All channel Phase settings
	All channel Attenuator settings
	All channel Delay settings (excluding ST IN Channels)
	All channel Compressor settings (excluding ST IN Channels)
	Input channel Gate settings (excluding ST IN Channels)
	All channel EQ settings
	All channel Pan settings
	All channel routings
	Fader groups, Mute groups, Fader group Masters, Mute group Masters, EQ links, and Compressor links
All channel pair settings	
Effects parameters	Effect programs recalled for Effects processors 1–4 and their parameter settings
Remote Layer	Fader and [ON] button status (only when Remote Control Target is set to USER DEFINED)
Scene settings	Scene titles and Fade Time settings
Input Patching	Currently-selected Input Patch library number
Output Patching	Currently-selected Output Patch library number

Note:

- Scenes take a snapshot of Input and Output Patch library numbers that are in use at the time the Scene is stored, but exclude current (edited) Input and Output patching.
- If you do not store the edited Input and Output patching to the libraries, recalling a Scene may change the current patching.

About Scene Numbers

Scene memories are numbered with #U or from #00 through #99. You can store Scenes in Scene memories #01–99. When you recall a Scene, the Scene memory number appears at the top of the display page.

Scene memory #00 is a special read-only memory that contains the default settings of all mix parameters. To reset all mix parameters on the 01V96 to their initial or default values, recall Scene memory #0.

Also, the Initial Data Nominal check box on the Setup | Prefer1 page (see page 230) enables you to specify whether Input Channel faders are set to either 0 dB or $-\infty$ dB when Scene memory #0 is recalled.

Scene memory “Ud” is a special read-only memory that contains the mix settings in effect immediately before the most recently recalled or stored Scene. To undo or redo Scene memory recall and store operations, recall Scene memory #U.

When you adjust parameters after recalling a Scene, the Edit indicators appear (“EDIT” at the top of the display), indicating that the mix settings no longer match those of the Scene that was most recently recalled. The contents of the Edit Buffer (where the current mix settings are stored) are retained while the 01V96 is turned off. This allows the 01V96 to restore the edited mix settings when you turn on the power.



The contents of recalled Scene memory #2 match the current settings on the 01V96, and the Edit indicator remains off.

The parameters of recalled Scene memory #2 were edited. Therefore, the Edit indicators appear, indicating that the current settings on the 01V96 do not match Scene memory #2.

Storing and Recalling Scenes

You can store and recall Scenes by pressing the buttons on the top panel or using the dedicated Scene memory page on the display.

Note:

- When you store Scenes, make sure that there are no settings in the Edit Buffer that you do not want to store. Make sure that no settings, especially faders, have been adjusted unintentionally.
- If you are not sure of the Edit Buffer's contents, recall the last Scene, make the adjustments you want, then store the Scene. You may wish to store the current Scene to an unused Scene memory, just in case.

Storing and Recalling Scenes Using the SCENE MEMORY Buttons

You can use the SCENE MEMORY buttons to store and recall Scenes.

- 1 Adjust the mix parameters on the 01V96 to the conditions you wish to store as a Scene.**
- 2 Press the SCENE MEMORY Up [▲] or Down [▼] buttons to select a Scene memory number.**

If you select a Scene memory other than the currently-recalled Scene, its number flashes at the top of the display.

Scene memories #U (“Ud”) and #0 (“00”) are special read-only memories, to which you cannot store Scenes. Also, you cannot store Scenes to write-protected Scene memories (see page 168).

- 3 Press the SCENE MEMORY [STORE] button.**

The Title Edit window appears, which enables you to name the Scene to be stored.

Tip: You can disable this window by turning the Store Confirmation parameter to Off on the DIO/Setup | Prefer1 page (see page 230). In this case, the stored Scene will have the same name as the one recalled most-recently.

- 4 Enter the title, move the cursor to the OK button, then press [ENTER].**
The Title Edit window closes and the current Scene is stored to the selected Scene memory.
- 5 To recall a Scene, press the SCENE MEMORY Up [▲] or Down [▼] buttons to select a Scene memory number, then press the SCENE MEMORY [RECALL] button.**

Tip: If you turn the Recall Confirmation parameter to On on the DIO/Setup | Prefer1 page, a Scene recall confirmation window for Scene recalls appears before the Scene is recalled (see page 230).

Storing and Recalling Scenes Using the Scene Memory Page

On the Scene Memory page, you can store, recall, write-protect, delete, and edit the titles of Scenes.

- 1 Adjust the mix parameters on the 01V96 to the conditions you wish to store as a Scene.
- 2 Press the DISPLAY ACCESS [SCENE] button repeatedly until the Scene | Scene page appears.

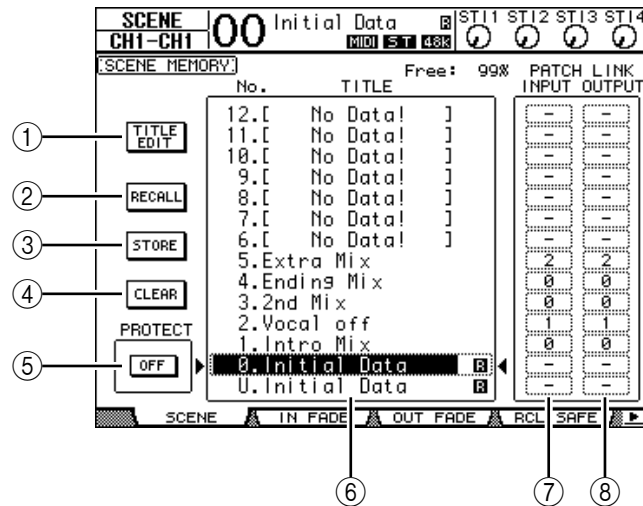

- 3 Rotate the Parameter wheel or press the [INC]/[DEC] buttons to select a Scene memory, move the cursor to one of the following buttons, then press [ENTER].

① **TITLE EDIT**

Select this button to display the Title Edit window, which enables you to edit a selected Scene title.

② **RECALL**

This button recalls the contents of the selected Scene memory.

③ **STORE**

This button stores the current Scene to the selected Scene memory. By default, a confirmation window appears before you store the Scene.



④ **CLEAR**

This button deletes the contents of the selected Scene memory.

⑤ **PROTECT ON/OFF**

This button switches on and off the write-protection of the contents of the selected Scene memory. A padlock icon () appears next to the title of a Scene memory that is write-protected.

⑥ **Library list**

Scene memories 01–99 are listed in the library memory title list. The titles of stored Scenes are indicated in the title column. The message “No Data!” appears in the title column of empty library memories. The selected memory appears inside the dotted box between the  and  marks.

⑦ **PATCH LINK INPUT**

This indicates the Input Patch library number that is linked to each scene. When you store a scene, the number of the input patch that was most recently recalled or stored will automatically be linked with that scene. When you recall that scene, this library number will also be automatically recalled. You can also move the cursor to the parameter boxes and change the library numbers.

⑧ **PATCH LINK OUTPUT**

This indicates the Output Patch library number that is linked to each scene. When you store a scene, the number of the output patch that was most recently recalled or stored will automatically be linked with that scene. When you recall that scene, this library number will also be automatically recalled. You can also move the cursor to the parameter boxes and change the library numbers.

Auto Scene Memory Update

If the Scene MEM Auto Update check box on the Setup | Prefer1 page (see page 230) is turned on, parameter edits are stored automatically in a **Shadow memory**, which is available for each Scene. This is called the **Auto Update function**.

If the Auto Update function is enabled, parameter edits made after the Scene was recalled are stored in the Scene’s Shadow memory. When you again recall the Scene, the contents of the Original and Shadow memories are recalled alternately.

Therefore, **even after you recall the Original Scene memory, you can recall the edited version from Shadow memory to restore the most recent edits.**

If the “EDIT” indicator appears at the top of the display, the edited version from Shadow memory has been recalled.

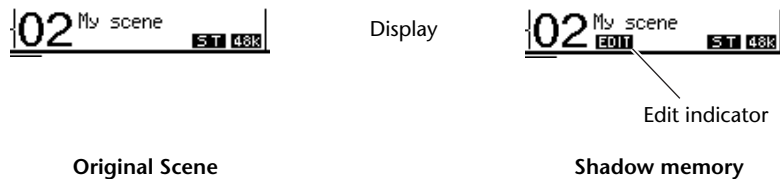

If a Shadow memory is recalled, the edited version is stored when you store the Scene. (The contents of the Original and Shadow memories then become identical.)

Fading Scenes

You can specify the time it takes the Input and Output Channel faders (or level controls) to move to their new positions when a Scene is recalled. This is called Fade Time, and it can be set for each channel in the range of 00.0 through 30.0 seconds (in 0.1 second steps). You can set the Fade Time for each Scene individually or for all Scenes globally.

Fading Input Channels

To set the Fade Time for Input Channels 1–32 and ST IN Channels 1–4, press the DISPLAY ACCESS [SCENE] button repeatedly until the Scene | In Fade page appears. Move the cursor to the desired channel parameter box, then rotate the Parameter wheel or press the [INC]/[DEC] buttons to modify the Fade Time setting.

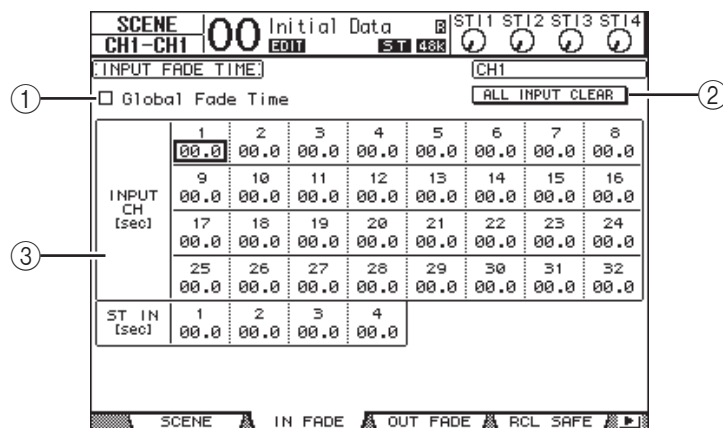

① **Global Fade Time**

When this check box is checked, a Scene is recalled using the currently-specified Fade Time. (The Fade Time setting stored in the recalled Scene is temporarily ignored.) This check box setting works in unison with the Out Fade page.

② **ALL INPUT CLEAR**

This button resets all channel Fade Times on the page to 00.0 second.

③ **INPUT CH1–32/ST IN 1–4**

These parameters enable you to set the Fade Time for each Input Channel in the range of 00.0 through 30.0 seconds. The Fade Time setting for one channel in a pair works in unison with its partner.

Tip:

- If you operate a fader while fading channels, the fader’s Fade Time setting is temporarily ignored.
- You can copy the currently-selected Input Channel Fade Time to all Input Channels by double-clicking the [ENTER] button to display a window for copying. This is convenient when you wish to set the Fade Time for all channels simultaneously.

Fading Output Channels

To set the Fade Time for the Output Channels (Stereo Out, Bus Outs 1–8, Aux Outs 1–8), press the DISPLAY ACCESS [SCENE] button repeatedly until the Scene | Out Fade page appears.

The basic operation is the same as on the In Fade page.

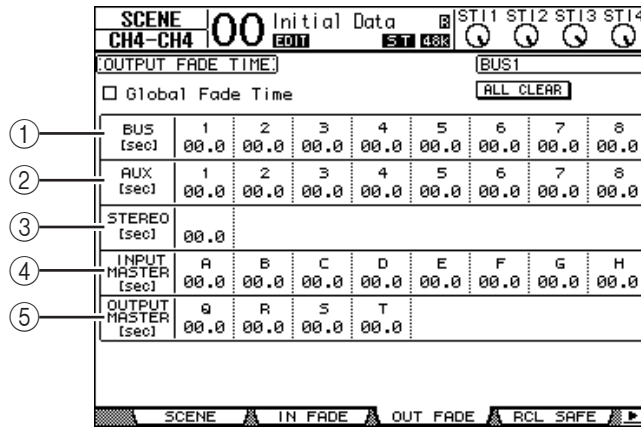

① **BUS1–8**

These parameters enable you to set the Fade Time for each Bus Out (1–8) in the range of 00.0 through 30.0 seconds.

② **AUX1–8**

These parameters enable you to set the Fade Time for Aux Outs 1–8.

③ **STEREO**

This parameter enables you to set the Fade Time for the Stereo Out.

④ **INPUT MASTER A–H**

These parameters enable you to set the Fade Time for Input Fader Group Master A–H.

⑤ **OUTPUT MASTER Q–T**

These parameters enable you to set the Fade Time for Output Fader Group Master Q–T.

Tip: You can copy the currently-selected Output Channel Fade Time setting to all Output Channels by double-clicking the [ENTER] button.

Recalling Scenes Safely

When a Scene is recalled, all mix parameters are set accordingly. However, in some situations, **you can retain the current settings of certain parameters** on certain channels by using the **Recall Safe function**. You can set the Recall Safe function parameters for each Scene individually or for all Scenes globally.

To set the Recall Safe function, press the DISPLAY ACCESS [SCENE] button repeatedly until the Scene | Rcl Safe page appears.

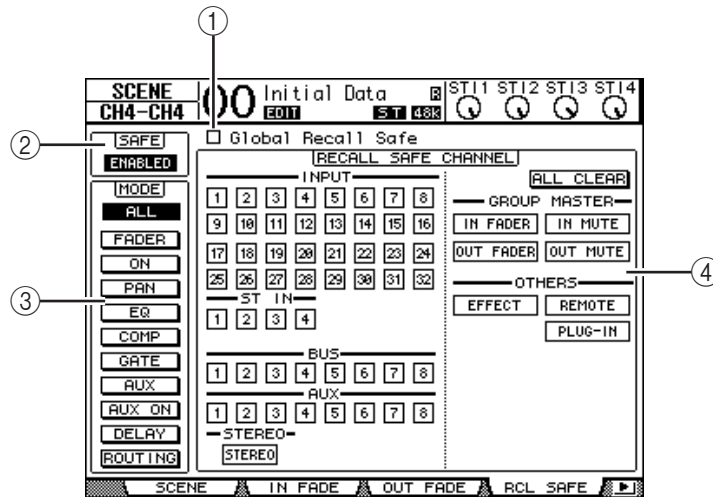

① **Global Recall Safe**

When this check box is checked, Recall Safe settings stored in Scene memories are ignored and the current settings are retained.

② **SAFE**

This parameter enables or disables the Recall Safe function.

③ **MODE**

The following MODE buttons determine which Safe channel parameters will remain unaffected by Scene recalls. The MODE buttons correspond to the following parameters:

- **ALL** All parameters
- **FADER**..... Channel faders (or level controls)
- **ON**..... Channel On/Off parameters
- **PAN**..... Channel Pan parameters, Stereo Out balance
- **EQ** Channel EQ parameters
- **COMP**..... Channel Comp parameters
- **GATE** Channel Gate parameters
- **AUX** Channel Aux Send levels, Pre/Post
- **AUX ON** Aux Send On/Off parameters
- **DELAY** Channel Delay parameters
- **ROUTING** Channel Routing parameters

Tip: The ALL button is mutually exclusive of the other buttons.

④ **RECALL SAFE CHANNEL section**

This section enables you to select which channels will remain unaffected by Scene recalls, including Input Channels 1–32, ST IN Channels 1–4, Bus Outs 1–8, Aux Outs 1–8, Stereo Out, internal effects, USER DEFINED Remote layers, and plug-in effects. The Recall Safe function is effective on channels and functions for which the buttons are turned on.

Sorting Scenes

You can sort Scenes in Scene memories.

- 1 Press the DISPLAY ACCESS [SCENE] button repeatedly until the Scene | Sort page appears.

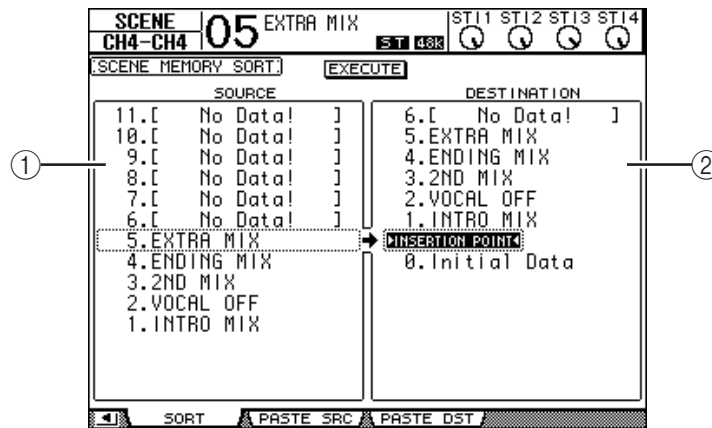

- 2 Move the cursor to the SOURCE list (①) in the left column, then rotate the Parameter wheel or press the [INC]/[DEC] buttons to select the Scene memory you wish to move.
- 3 Move the cursor to the DESTINATION list (②) in the right column, then rotate the Parameter wheel or press the [INC]/[DEC] buttons to select the position to which you want to move the source Scene memory.
- 4 Press [ENTER] to move the source Scene memory to the specified destination.

The Scene memory numbers are updated accordingly.

Copying and Pasting a Scene (Global Paste)

Any channel or parameter settings for the current scene can be copied and pasted into one or more scenes. This function is useful when you want to apply edited parameter settings in the current scene to other scenes.

- 1 Press the DISPLAY ACCESS [SCENE] button repeatedly until the Paste SRC page appears.

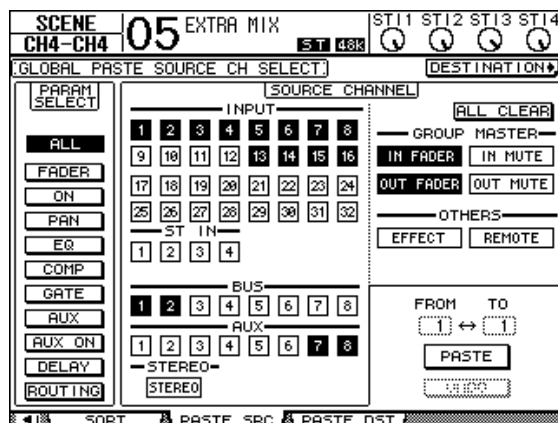

- 2 Use the cursor buttons, [SEL] buttons, or Parameter wheel to select the channel category, then use the [ENTER] button or the INC/DEC buttons to select the copy source channel.

The number of the source channel is highlighted.

You can also select Group Masters, internal Effects, and a User Defined Remote layer as copy sources.

- 3 Use the cursor buttons or Parameter wheel to select the copy source parameter, then press the [ENTER] button.
- 4 Press the DISPLAY ACCESS [SCENE] button repeatedly until the Paste DST page appears.

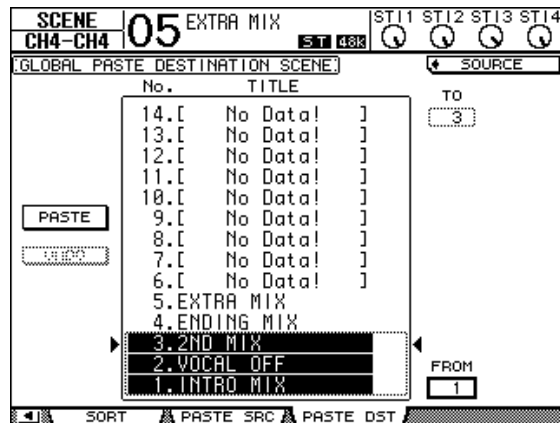

- 5 Use the Parameter wheel or INC/DEC buttons to select the destination scene(s).

Scenes specified between FROM and TO (inclusive) become the paste destination. You can paste up to 10 scenes at a time.

- 6 Use the cursor buttons to select the PASTE button, then use the [ENTER] button to paste the settings.

You cannot paste the settings to write-protected scenes.

To restore the previous settings that existed before the paste operation, click the UNDO button, then press [Enter]. However, if the settings in the scene are changed after the paste operation (such as by saving, clearing, or sorting the scene, or receiving scene data via MIDI Bulk Dump), the UNDO function is disabled. Also, note that you will not be able to undo the operation after you turn off the power to the console.

16 Libraries

This chapter describes the 01V96's various libraries.

About the Libraries

The 01V96 features seven libraries that enable you to store Channel, Input Patch, Output Patch, Effects, and other data. You can also quickly recall this data from the libraries to restore previous parameter values.

The 01V96 offers the following libraries:

- Channel Library
- Input Patch Library
- Output Patch Library
- Effects Library
- Gate Library
- Compressor Library
- EQ Library

Tip:

- You can store library data to a computer hard disk using the included Studio Manager software. Be sure to back up your important data.
- You can also store library data to an external MIDI device, such as a MIDI data filer, by using MIDI Bulk Dump (see page 226).

General Library Operation

Most library functions are the same for each library.

1 Use the buttons on the top panel to locate the desired library pages.

The procedure for locating library pages varies depending on the library. Refer to the latter part of this chapter for more information on how to display the desired library page.

The example below assumes you have located the Input Patch library page.

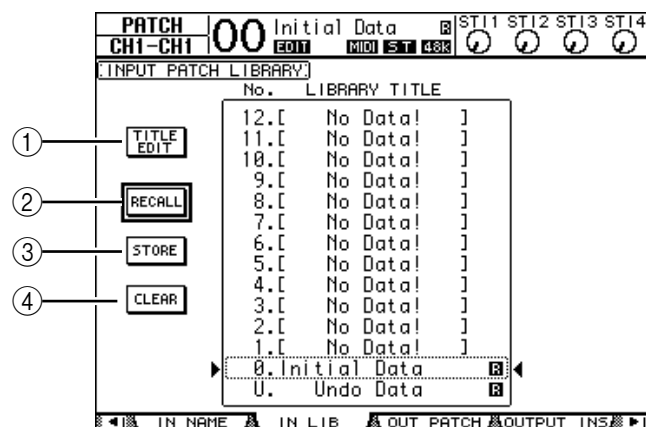

The library memory title list is displayed in the middle of the page. The message “No Data!” appears in the title column of empty library memories.

An “” icon is displayed next to the name of read-only preset memories. You cannot store, clear, or edit the titles of these memories.

Memories #0 and #U are special read-only memories. Recall memory #0 to reset the parameter settings to their initial values. Recall #U to undo memory recall and store operations.

2 Rotate the Parameter wheel or press the [INC]/[DEC] buttons to select the desired memory.

The selected memory appears inside the dotted box.

3 Move the cursor to one of the following function buttons, then press [ENTER].**① TITLE EDIT**

This button displays the Title Edit window, which enables you to edit the title of the selected memory. Move the cursor to the OK button, then press [ENTER] to confirm the edited title. Refer to page 30 for more information on entering characters.

② RECALL

This button recalls the contents of the selected library memory. If you turn on the Recall Confirmation parameter on the DIO/Setup | Prefer 1 page, the 01V96 displays a memory recall confirmation window.

③ STORE

This button stores the settings to the selected memory. Before you store the settings, you can enter or edit the title using the Title Edit window. Refer to page 30 for more information on entering characters.

You can disable the Title Edit window by turning off the Store Confirmation parameter on the DIO/Setup | Prefer 1 page. If you bypass the Edit Title window, the name “New Data” will be used as a title for the Scene memory.

④ CLEAR

This button deletes the contents of the selected memory. After you press [ENTER], the 01V96 displays a confirmation window. To execute the delete operation, move the cursor to the YES button in the confirmation window, then press [ENTER].

Note: *If you select a memory that already contains settings and execute the delete operation, the settings will be lost. Make sure that you do not accidentally delete important settings.*

Using Libraries

Channel Library

Channel library enables you to store and recall Input Channel and Output Channel parameter settings. The library contains two preset memories and 127 user (readable & writable) memories.

You can recall only the settings for the currently-selected channels from the Channel library. For example, you cannot recall Input Channel 1–32 settings to ST IN Channels 1–4, Bus Outs 1–8, Aux Outs 1–8, or Stereo Out, with the exception that memories #0 and #1 can be recalled to any channels.

Follow the steps below to use the Channel library.

- 1 Press the **DISPLAY ACCESS [VIEW]** button repeatedly until the **View | Library** page appears.

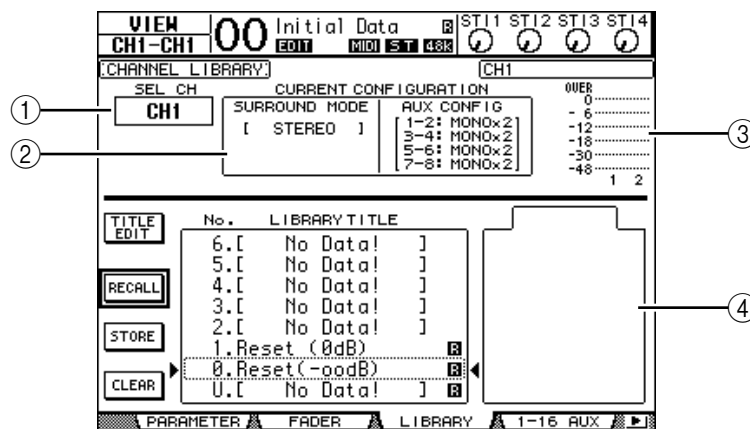

- ① **SEL CH**

This parameter indicates the currently-selected channel.

- ② **CURRENT CONFIGURATION section**

If the currently-selected channel is an Input Channel (1–32) or ST IN Channels (1–4), its Surround mode and Aux configuration information is displayed here.

- ③ **Level meters**

These meters indicate the levels of the currently-selected channel and the available partner.

- ④ **STORED FROM**

This parameter indicates the channel for which the settings were originally stored in the selected library memory. If the currently-selected library memory contains Input Channel 1–32 and ST IN Channels 1–4 settings, its Surround mode and Aux pairing information are also displayed below this parameter.

- 2 Use the **LAYER** buttons to select layers, then press the **[SEL]** buttons to select channels.

For details on the Store and Recall functions, see “General Library Operation” on page 175.

If the selected memory’s channel type does not match the type of the destination channel, an alarm mark (▲) and the word “CONFLICT” appear next to the STORED FROM parameter. These alarms indicate that you tried to recall unrecallable channel settings to the currently-selected channel.

The alarm indicators also appear when the Surround mode, Aux pair, and other non-channel parameter settings originally stored in the memory do not match those for the destination channel. However, if the channel type of the memory and that of the destination channel match, you can recall the settings even with the alarm indicators displayed. (For unmatched parameter settings, the 01V96 will use the settings in the memory that is to be recalled.)

The following preset memories are available for the Channel library.

No.	Preset Name	Description
0	Reset (∞ dB)	This preset memory resets all parameters of the currently-selected channel to their initial values and sets the channel fader level to (∞ dB).
1	Reset (0 dB)	This preset memory resets all parameters of the currently-selected channel to their initial values and sets the channel fader level to 0 dB (i.e., nominal).

Input Patch Library

The Input Patch library enables you to store and recall all Input Patch settings. The library contains one preset memory and 32 user (readable & writable) memories.

To access the Input Patch library, press the DISPLAY ACCESS [PATCH] button repeatedly until the Patch | IN LIB page appears. For details on storing and recalling memories, see “General Library Operation” on page 175.

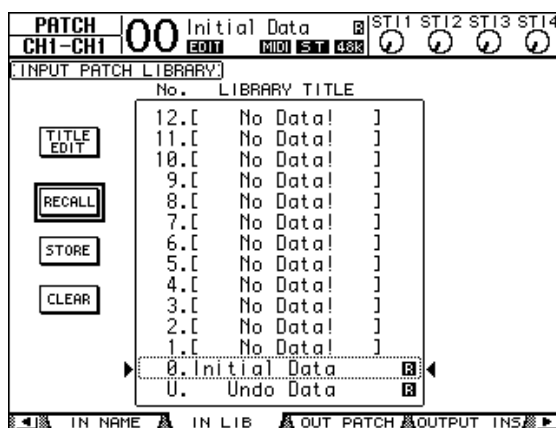

Input Patch preset memory #0 contains the following settings:

Input Channels 1–16	INPUT connectors 1–16
Input Channels 17–24	ADAT IN Channels 1–8
Input Channels 25–32	Slot Channels 1–8
ST IN Channels 1–4	Internal Effects Processor 1–4 Outputs 1 & 2

Output Patch Library

The Output Patch library enables you to store and recall all Output Patch settings. The library contains one preset memory and 32 user (readable & writable) memories.

To access the Output Patch library, press the DISPLAY ACCESS [PATCH] button repeatedly until the Patch | Out LIB page appears.

For details on storing and recalling memories, see “General Library Operation” on page 175.

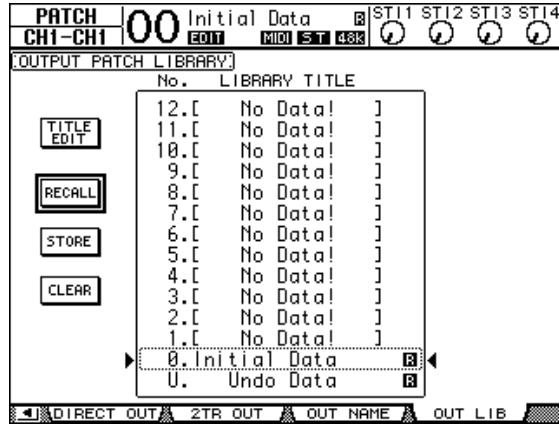

The Output Patch preset memory #0 contains the following settings:

Slot output channels 1–8	Bus Outs 1–8
Slot output channels 9–16	Bus Outs 1–8
ADAT OUT channels 1–8	Bus Outs 1–8
OMNI OUT connectors 1–4	Aux Outs 1–4

Effects Library

The Effects library enables you to store and recall Effects processor 1–4 programs. The library contains 53 preset programs (including Add-On Effects) and 75 user (readable & writable) programs.

Note: The Effects library is shared by Effects processors 1–4. However, only Effects processors 1 and 2 enable the recall of Effect 19 “HQ Pitch” and Effect 42 “Freeze.”

To store and recall settings to and from the library, you must locate the corresponding Effects processor’s page.

To access the Effects library, press the DISPLAY ACCESS [EFFECT] button repeatedly until the library page for the desired Effects processor appears.

Each Effects processor features the library pages listed below:

- **Internal Effects Processor 1 Library**..... FX1 Lib page
- **Internal Effects Processor 2 Library**..... FX2 Lib page
- **Internal Effects Processor 3 Library**..... FX3 Lib page
- **Internal Effects Processor 4 Library**..... FX4 Lib page

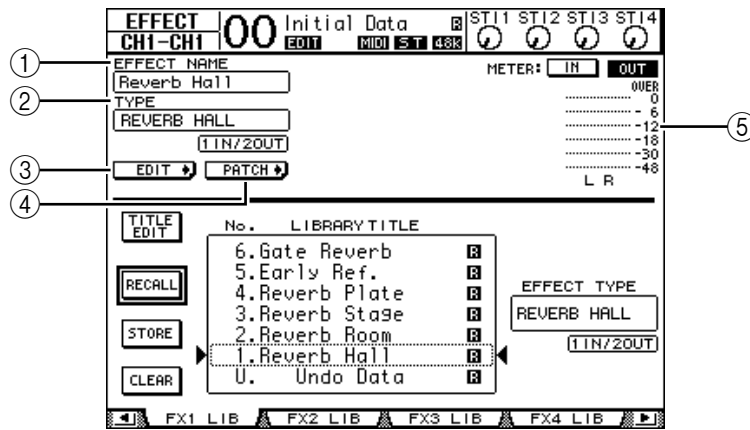

① **EFFECT NAME**

This parameter displays the name of the Effects program currently selected by the Effects processor.

② **TYPE**

This parameter displays the effects type currently used by the Effects processor. The number of input and output channels for the currently-used effects appears below the TYPE parameter.

③ **EDIT**

Move the cursor to this button, then press [ENTER] to display the Effect | FX1 Edit, FX2 Edit, FX3 Edit, or FX4 Edit page to adjust the Effects parameters.

④ **PATCH**

Move the cursor to this button, then press [ENTER] to display the In Patch | Effect page to assign the input and output signals of Effects processors 1–4.

⑤ **Level meters**

These meters indicate the input or output levels of the currently-selected Effects processor. Select the IN button or OUT button to display the input levels or output levels respectively.

For details on storing and recalling programs, see “General Library Operation” on page 175.

The following tables list the preset effects programs in the Effects library:

- **Reverbs**

No.	Preset Name	Type	Description
1	Reverb Hall	REVERB HALL	Concert hall reverberation simulation with gate
2	Reverb Room	REVERB ROOM	Room reverberation simulation with gate
3	Reverb Stage	REVERB STAGE	Reverb designed for vocals, with gate
4	Reverb Plate	REVERB PLATE	Plate reverb simulation with gate
5	Early Ref.	EARLY REF.	Early reflections without the subsequent reverb
6	Gate Reverb	GATE REVERB	Gated early reflections
7	Reverse Gate	REVERSE GATE	Gated reverse early reflections

- **Delays**

No.	Preset Name	Type	Description
8	Mono Delay	MONO DELAY	Simple mono delay
9	Stereo Delay	STEREO DELAY	Simple stereo delay
10	Mod.delay	MOD.DELAY	Simple repeat delay with modulation
11	Delay LCR	DELAY LCR	3-tap (left, center, right) delay
12	Echo	ECHO	Stereo delay with crossed left/right feedback

- **Modulation-based Effects**

No.	Preset Name	Type	Description
13	Chorus	CHORUS	Chorus
14	Flange	FLANGE	Flanger
15	Symphonic	SYMPHONIC	Proprietary Yamaha effect that produces a richer and more complex modulation than normal chorus
16	Phaser	PHASER	16-stage stereo phase shifter
17	Auto Pan	AUTO PAN	Auto-panner
18	TREMOLO	TREMOLO	Tremolo
19	HQ.Pitch	HQ.PITCH	Mono pitch shifter, producing stable results (Available for internal effects 1 and 2.)
20	Dual Pitch	DUAL PITCH	Stereo pitch shifter
21	Rotary	ROTARY	Rotary speaker simulation
22	Ring Mod.	RING MOD.	Ring modulator
23	Mod.Filter	MOD.FILTER	Modulated filter

- **Guitar Effects**

No.	Preset Name	Type	Description
24	Distortion	DISTORTION	Distortion
25	Amp Simulate	AMP SIMULATE	Guitar amp simulation

- **Dynamic Effects**

No.	Preset Name	Type	Description
26	Dyna.Filter	DYNA.FILTER	Dynamically controlled filter
27	Dyna.Flange	DYNA.FLANGE	Dynamically controlled flanger
28	Dyna.Phaser	DYNA.PHASER	Dynamically controlled phase shifter

• **Combination Effects**

No.	Preset Name	Type	Description
29	Rev+Chorus	REV+CHORUS	Reverb and chorus in parallel
30	Rev->Chorus	REV->CHORUS	Reverb and chorus in series
31	Rev+Flange	REV+FLANGE	Reverb and flanger in parallel
32	Rev->Flange	REV->FLANGE	Reverb and flanger in series
33	Rev+Sympho.	REV+SYMPHO.	Reverb and symphonic in parallel
34	Rev->Sympho.	REV->SYMPHO.	Reverb and symphonic in series
35	Rev->Pan	REV->PAN	Reverb and auto-pan in series
36	Delay+ER.	DELAY+ER.	Delay and early reflections in parallel
37	Delay->ER.	DELAY->ER.	Delay and early reflections in series
38	Delay+Rev	DELAY+REV	Delay and reverb in parallel
39	Delay->Rev	DELAY->REV	Delay and reverb in series
40	Dist->Delay	DIST->DELAY	Distortion and delay in series

• **Others**

No.	Preset Name	Type	Description
41	Multi.Filter	MULTI.FILTER	3-band parallel filter (24 dB/octave)
42	Freeze	FREEZE	Simple sampler (Available for internal effects 1 and 2.)
43	Stereo Reverb	ST REVERB	Stereo reverb
44	M.Band Dyna.	M.BAND DYNA.	3-band dynamics processor

• **Add-On Effects**

No.	Preset Name	Type	Description
45 ¹	Comp276	COMP276	—
46 ¹	Comp276S	COMP276S	
47 ¹	Comp260	COMP260	
48 ¹	Comp260S	COMP260S	
49 ¹	Equalizer601	EQUALIZER601	
50 ¹	OpenDeck	OPENDECK	
51 ¹	REV-X Hall	REV-X HALL	
52 ¹	REV-X Room	REV-X ROOM	
53 ¹	REV-X Plate	REV-X PLATE	

1. These preset programs are dedicated to Add-On Effects. The numbers of effects programs that do not have Add-On Effects installed are grayed out and cannot be used. For more information on Add-On Effects, refer to “About Add-On Effects” on page 162.

Gate Library

The Gate library enables you to store and recall Input Channel gate settings. The library contains four preset memories and 124 user (readable & writable) memories.

Follow the steps below to use the Gate library.

1 Press the DISPLAY ACCESS [DYNAMICS] button, then press the [F2] button.

The Dynamics | Gate Lib page appears.

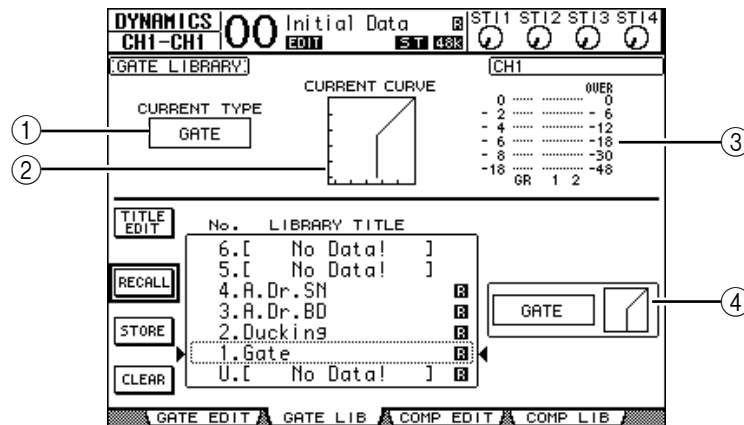

① CURRENT TYPE

This parameter displays the currently-selected channel gate type (Gate or Ducking).

② CURRENT CURVE

This graph displays the current channel gate curve.

③ GR meters

These meters indicate the amount of gain reduction being applied by the gate, and the post-gate levels of the currently-selected channel and its available pair partner.

④ Type & Curve section

The type (Gate or Ducking) and curve of the currently-selected memory is displayed here.

Tip: If you selected an ST IN Channel (1–4), Aux Out (1–8), Bus Out (1–8), or Stereo Out that does not feature a gate, the 01V96 indicates “XXX has no Gate!” (in which XXX represents a channel name).

2 Use the LAYER buttons to select layers, then press the [SEL] buttons to select channels.

You can now store the selected channel gate settings or recall the gate library memories to channels. For details on storing and recalling memories, see “General Library Operation” on page 175.

The following table lists the preset memories in the Gate library:

No.	Preset Name	Type	Description
1	Gate	GATE	Gate template
2	Ducking	DUCKING	Ducking template
3	A. Dr. BD	GATE	Gate preset for use with acoustic bass drums
4	A. Dr. SN	GATE	Gate preset for use with acoustic snare drums

Compressor Library

This library enables you to store and recall settings for the compressors on Input Channels, Bus Outs 1–8, Aux Outs 1–8, and Stereo Out. The library contains 36 preset memories and 92 user (readable & writable) memories.

Follow the steps below to use the Compressor library.

1 Press the DISPLAY ACCESS [DYNAMICS] button, then press the [F4] button.

The Dynamics | Comp Lib page appears.

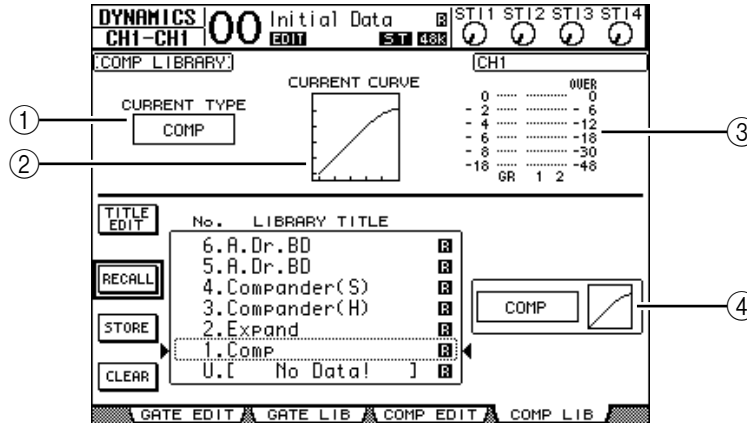

① CURRENT TYPE

This parameter displays the currently-selected channel comp type (Compressor, Expander, Compander Soft, Compander Hard).

② CURRENT CURVE

This graph displays the current compressor curve.

③ GR meters

These meters indicate the amount of gain reduction being applied by the compressor, and the post-comp levels of the currently-selected channel and its available pair partner.

④ Type & Curve section

The type and curve of the currently-selected memory is displayed here.

2 Use the LAYER buttons to select layers, then press the [SEL] buttons to select channels.

You can now store the selected channel comp settings and recall the compressor library memories to channels. For details on storing and recalling memories, see “General Library Operation” on page 175. Since ST IN Channels do not feature compressors, if you select an ST IN Channel, the message “Stereo in has no Comp!” appears on the display.

The following table lists the preset memories in the Compressor library:

No.	Preset Name	Type	Description
1	Comp	COMP	Compressor for reducing the overall volume level. Use it on the stereo output during mixdown, or with paired Input or Output Channels.
2	Expand	EXPAND	Expander template.
3	Compander (H)	COMPAND-H	Hard-kneed compressor template.
4	Compander (S)	COMPAND-S	Soft-kneed compressor template.
5	A. Dr. BD	COMP	Compressor for use with acoustic bass drum.
6	A. Dr. BD	COMPAND-H	Hard-kneed compander for use with acoustic bass drum.
7	A. Dr. SN	COMP	Compressor for use with acoustic snare drum.
8	A. Dr. SN	EXPAND	Expander for use with acoustic snare drum.
9	A. Dr. SN	COMPAND-S	Soft-kneed compander for use with acoustic snare drum.
10	A. Dr. Tom	EXPAND	Expander for use with acoustic tom toms, which automatically reduces the volume when the tom toms are not played, improving mic separation.
11	A. Dr. OverTop	COMPAND-S	Soft-kneed compander for emphasizing the attack and ambience of cymbals recorded with overhead mics. It automatically reduces the volume when the cymbals are not played, improving mic separation.
12	E. B. Finger	COMP	Compressor for leveling the attack and volume of a finger-picked electric bass guitar.
13	E. B. Slap	COMP	Compressor for leveling the attack and volume of a slapped electric bass guitar.
14	Syn. Bass	COMP	Compressor for controlling or emphasizing the level of a synth bass.
15	Piano1	COMP	Compressor for brightening the tonal color of a piano.
16	Piano2	COMP	A variation on preset 15, using a deep threshold to change the overall attack and level.
17	E. Guitar	COMP	Compressor for electric guitar "cutting" or arpeggio-style backing. The sound color can be varied by playing different styles.
18	A. Guitar	COMP	Compressor for acoustic guitar "stroke" or arpeggio-style backing.
19	Strings1	COMP	Compressor for use with strings.
20	Strings2	COMP	A variation on preset 19, intended for violas or cellos.
21	Strings3	COMP	A variation on preset 20, intended for string instruments with a very low range, such as cellos or contrabass.
22	BrassSection	COMP	Compressor for brass sounds with a fast and strong attack.
23	Syn. Pad	COMP	Compressor for musical instruments that feature gentle sounds which, depending on the tones, could diffuse, such as synth pad. Intended to prevent diffusion of the sound.
24	SamplingPerc	COMPAND-S	Compressor for making sampled percussion sound like real acoustic percussion.
25	Sampling BD	COMP	A variation on preset 24, intended for sampled bass drum sounds.
26	Sampling SN	COMP	A variation on preset 25, intended for sampled snare drum sounds.
27	Hip Comp	COMPAND-S	A variation on preset 26, intended for sampled loops and phrases.
28	Solo Vocal1	COMP	Compressor for use with main vocals.
29	Solo Vocal2	COMP	A variation on preset 28.
30	Chorus	COMP	A variation on preset 28, intended for choruses.

No.	Preset Name	Type	Description
31	Click Erase	EXPAND	Expander for removing a click track that may bleed through from a musician's headphones.
32	Announcer	COMPAND-H	Hard-kneed compander for reducing the level of the music when an announcer speaks.
33	Limiter1	COMPAND-S	A soft-kneed compander with a slow release.
34	Limiter2	COMP	A "peak-stop" compressor.
35	Total Comp1	COMP	Compressor for reducing the overall volume level. Use it on the stereo output during mixdown, or with paired Input or Output Channels.
36	Total Comp2	COMP	A variation on preset 35, but with more compression.

EQ Library

This library enables you to store and recall EQ settings for Input Channels, Bus Outs 1–8, Aux Outs 1–8, and Stereo Out. The library contains 40 preset memories and 160 user (readable & writable) memories.

Follow the steps below to use the EQ library.

1 Press the DISPLAY ACCESS [EQ] button, then press the [F2] button.

The EQ | EQ Library page appears.

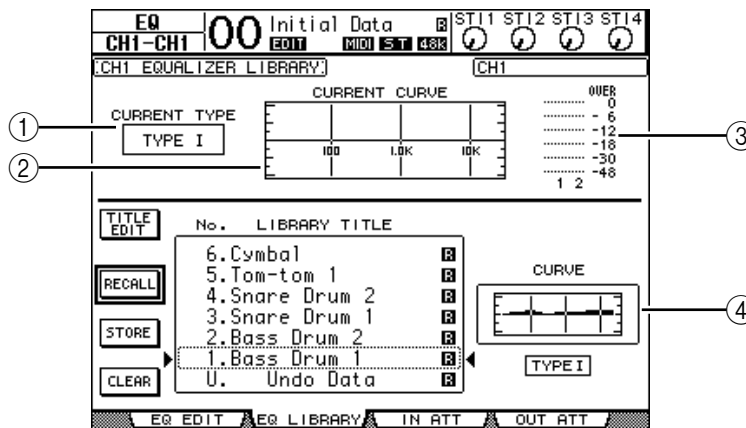

① CURRENT TYPE

This parameter displays the currently-selected channel EQ type (TYPE I or II).

② CURRENT CURVE

This graph displays the current EQ curve.

③ Level meters

These meters indicate the post-EQ levels of the currently-selected channel and its available pair partner.

④ Type & Curve section

The type and curve of the currently-selected EQ program are displayed here.

2 Use the LAYER buttons to select layers, then press the [SEL] buttons to select channels.

You can now store the selected channel EQ settings or recall the EQ library memories to channels. For details on storing and recalling memories, see “General Library Operation” on page 175.

The following table lists the preset memories in the EQ library:

No.	Preset Name	Description
1	Bass Drum 1	Emphasizes the low range of a bass drum and the attack created by the beater.
2	Bass Drum 2	Creates a peak around 80 Hz, producing a tight, stiff sound.
3	Snare Drum 1	Emphasizes "snappy" and rimshot sounds.
4	Snare Drum 2	Emphasizes various ranges for that classic rock snare drum sound.
5	Tom-tom 1	Emphasizes the attack of tom-toms, and creates a long, "leathery" decay.
6	Cymbal	Emphasizes the attack of crash cymbals, extending the "sparkling" decay.
7	High Hat	Use on a tight high-hat, emphasizing the mid to high range.
8	Percussion	Emphasizes attack and adds clarity to the high-range of instruments, such as shakers, cabasas, and congas.
9	E. Bass 1	Produces a tight electric bass sound by cutting very low frequencies.
10	E. Bass 2	Unlike preset 9, this preset emphasizes the low range of an electric bass.
11	Syn. Bass 1	Use on a synth bass with emphasized low range.
12	Syn. Bass 2	Emphasizes the attack that is peculiar to synth bass.
13	Piano 1	Makes pianos sound brighter.
14	Piano 2	Used in conjunction with a compressor, this preset emphasizes the attack and low range of pianos.
15	E. G. Clean	Use for line-level recording of an electric or semi-acoustic guitar to get a slightly harder sound.
16	E. G. Crunch 1	Adjusts the tonal quality of a slightly distorted guitar sound.
17	E. G. Crunch 2	A variation on preset 16.
18	E. G. Dist. 1	Makes a heavily distorted guitar sound clearer.
19	E. G. Dist. 2	A variation on preset 18.
20	A. G. Stroke 1	Emphasizes the bright tones of acoustic guitars.
21	A. G. Stroke 2	A variation on preset 20. You can also use it with an acoustic-electric nylon string guitar.
22	A. G. Arpeg. 1	Ideal for arpeggio playing on acoustic guitars.
23	A. G. Arpeg. 2	A variation on preset 22.
24	Brass Sec.	Use with trumpets, trombones, or saxes. When used with a single instrument, try adjusting the HIGH or HIGH-MID frequency.
25	Male Vocal 1	An EQ template for male vocals. Try adjusting the HIGH or HIGH-MID parameters according to the voice quality.
26	Male Vocal 2	A variation on preset 25.
27	Female Vo. 1	An EQ template for female vocals. Try adjusting the HIGH or HIGH-MID parameters according to the voice quality.
28	Female Vo. 2	A variation on preset 27.
29	Chorus&Harmo	An EQ template for brightening choruses.
30	Total EQ 1	Use on a stereo mix during mixdown. Sounds even better when used with a compressor.
31	Total EQ 2	A variation on preset 30.
32	Total EQ 3	A variation on preset 30. Can also be used with paired Input or Output Channels.
33	Bass Drum 3	A variation on preset 1, with low and mid range reduced.
34	Snare Drum 3	A variation on preset 3, creating a thicker sound.
35	Tom-tom 2	A variation on preset 5, emphasizing the mid and high ranges.
36	Piano 3	A variation on preset 13.
37	Piano Low	Emphasizes the low range of pianos recorded in stereo.
38	Piano High	Emphasizes the high range of pianos recorded in stereo.
39	Fine-EQ Cass	Add clarity when recording to or from cassette tape.
40	Narrator	Ideal for recording narration.

17 Remote Control

This chapter describes the Remote function, which enables you to control external equipment directly from the 01V96 top panel.

About Remote Function

The 01V96's Remote function enables you to control external DAW (Digital Audio Workstation) equipment, MIDI devices, recorders, etc.

There are two types of Remote functions (Remote and Machine Control):

■ REMOTE (Remote Layer)

To use these types of Remote functions, you must connect the 01V96 to a target device via USB or an optional MY8-mLAN card installed in the slot, and operate the faders and [ON] buttons on the top panel to control the external device remotely.

You can specify a target device and parameter values on the DIO/Setup | Remote page. This layer is enabled when you turn on the LAYER [REMOTE] button. During Remote operation, the controls on the top panel enable you to control the external device. (You cannot adjust the 01V96's parameters unless you select a different layer.)

You can assign functions of a target device to the controls on the top panel of the 01V96 by using Remote layer. The following targets are available for remote control:

- **ProTools** You can remotely control Digidesign Pro Tools.
- **Nuendo** You can remotely control Steinberg Nuendo.
- **Cubase SX** You can remotely control Steinberg Cubase SX.
- **General DAW** You can remotely control DAW software that supports the protocol used by Pro Tools.
- **User Defined** You can also assign MIDI messages to the faders or [ON] buttons to remotely control a connected MIDI device, such as a synthesizer.
- **User Assignable Layer** You can combine the 01V96 channels to create a custom layer. (See page 233 for more information on this function.)

■ Machine Control

By using MIDI Machine Control commands and the DIO/Setup | Machine page, you can control an external recording machine that is connected to the 01V96 MIDI port, USB port, or optional MY8-mLAN card installed in the slot.

Tip: To control external devices from the 01V96, you can also use the User Defined buttons. Refer to “19 Other Functions” for more information.

Pro Tools Remote Layer

The 01V96 features Remote Layer target especially designed for controlling Pro Tools.

Connections and Configuring Pro Tools

Follow the steps below to connect the 01V96 to your computer via the USB port so that you can control Pro Tools from the 01V96.

Note: You cannot control Pro Tools via MIDI connections. Be sure to connect your computer via the USB or an optional MY8-mLAN card installed in the 01V96 slot.

■ Configuring Windows Computers

- 1 Connect the 01V96 TO HOST USB port to a USB port on your PC using a USB cable.

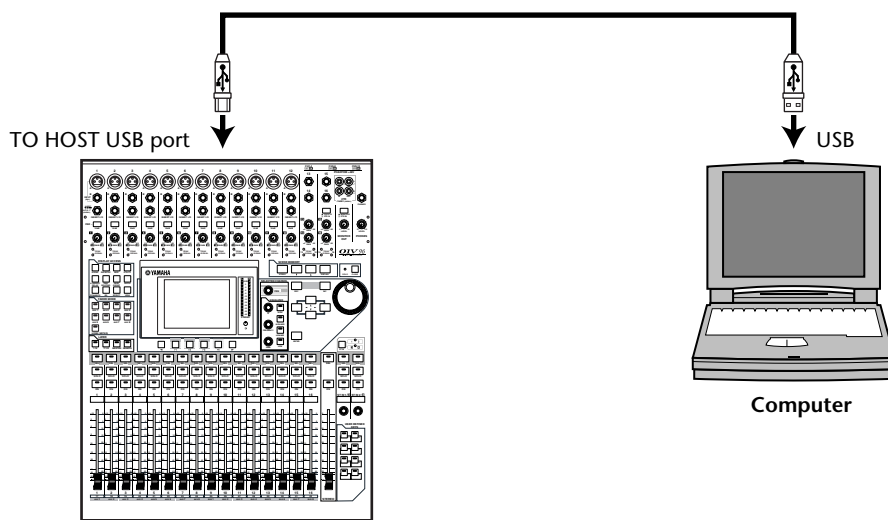

- 2 Install the necessary USB drivers included on the 01V96 CD-ROM.

See the Studio Manager Installation Guide for more information on installing the drivers.

■ Configuring Macintosh Computers

- 1 Connect the 01V96 TO HOST USB port to a USB port on your Mac using a USB cable.

- 2 Install the required USB driver included on the 01V96 CD-ROM.

See the Studio Manager Installation Guide for more information on installing the driver.

- 3 If you are using Mac OS versions 8.6 through 9.2.2, install OMS.

The 01V96 communicates with Pro Tools via OMS (Open Music System) software.

If you have not installed OMS on your Mac, use the OMS installer included on the 01V96 CD-ROM to install OMS.

- 4 Launch Pro Tools.

- 5 If you are using Mac OS versions 8.6 through 9.2.2, choose OMS Studio Setup from the Setups menu, and configure OMS as necessary.

Refer to the documentation that came with OMS for more information on configuring the OMS Studio Setup menu. OMS recognizes the 01V96 as a USB MIDI interface that features eight ports.

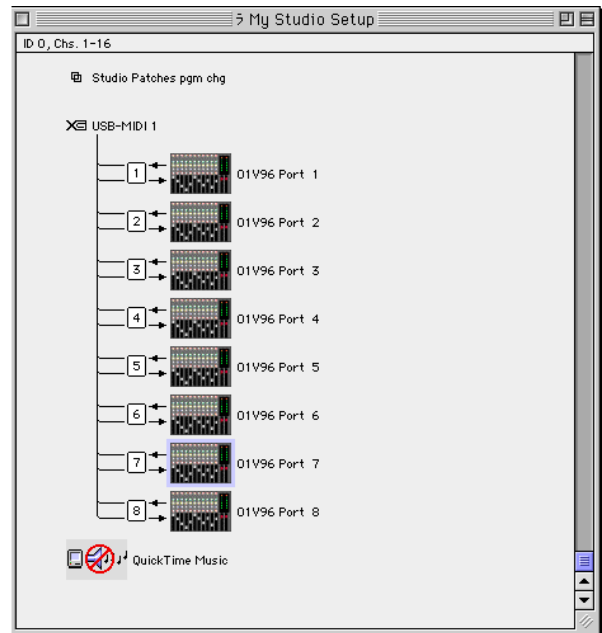

- 6 Choose Peripherals from the Setups menu to open the Peripherals window.
- 7 Double-click the MIDI Controllers tab.
- 8 Refer to the screen below to set the Type, Receive From, Send To, and #Ch's parameters.

The 01V96 can emulate up to two MIDI controllers.

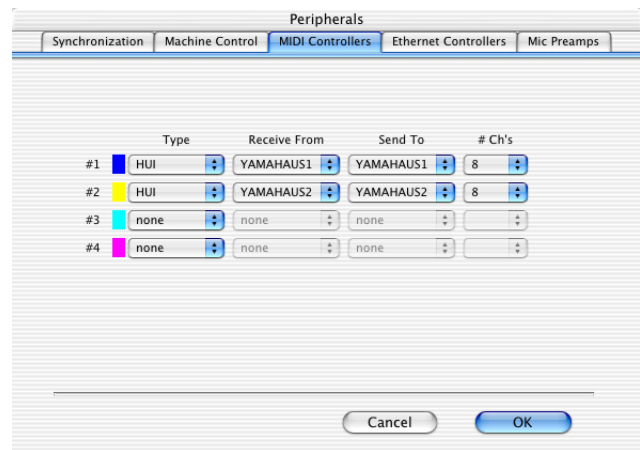
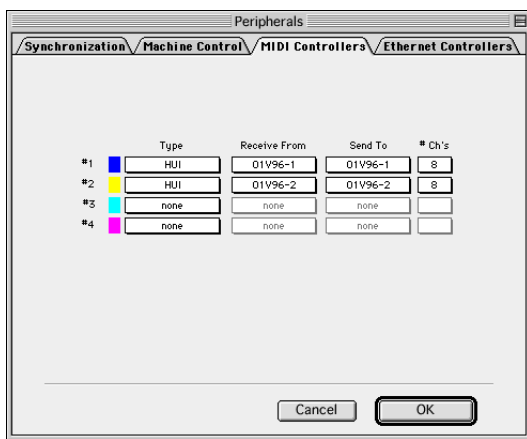

Tip: To control Pro Tools remotely, you need one port for every eight audio channels.

- 9 When you finish setting the parameters, close the window.

Configuring the 01V96

Follow the steps below to set up the 01V96 so that you can remotely control Pro Tools from the 01V96 Remote Layer.

- 1 Press the DISPLAY ACCESS [DIO/SETUP] button repeatedly until the DIO/Setup | MIDI/Host page appears.

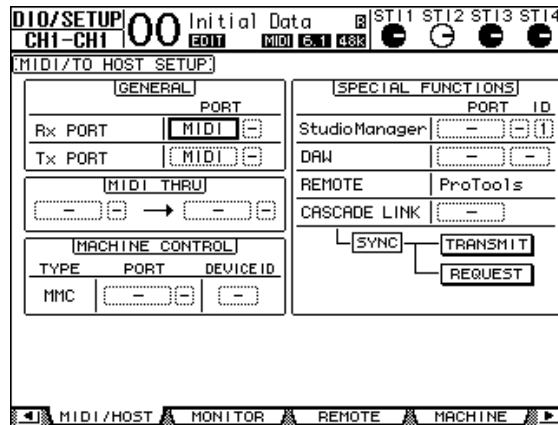

- 2 Move the cursor to the first DAW parameter box in the SPECIAL FUNCTIONS section, then rotate the Parameter wheel to select USB as the port.
- 3 Press [ENTER] to confirm the setting.
- 4 Move the cursor to the adjacent parameter box (on the right), then rotate the Parameter wheel to specify the port ID.

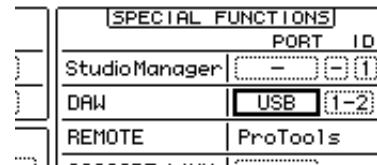

Note: If you select an incorrect port, you will be unable to use the Remote function. Be sure to match the port ID with that specified in the Peripherals window in Pro Tools.

- 5 Press the DISPLAY ACCESS [DIO/SETUP] button repeatedly until the DIO/Setup | Remote page appears.

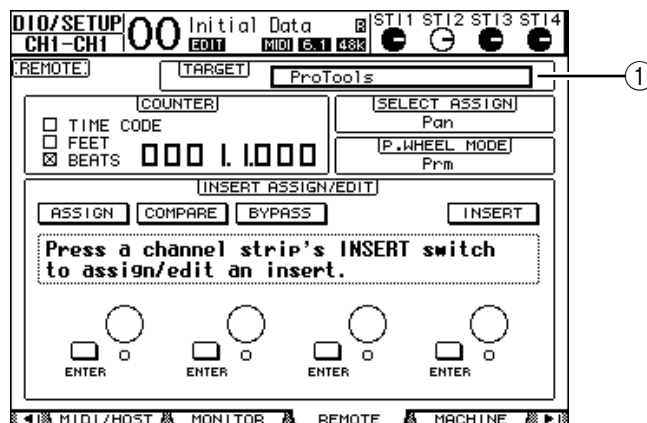

- 6 Select ProTools (as the target device) for the Target parameter (①) located in the upper-right corner of the page.

By default, the Remote layer target is set to ProTools. If another target has been selected, rotate the Parameter wheel to select ProTools.

7 Press the LAYER [REMOTE] button.

The Remote Layer is now available for control, enabling you to remotely control Pro Tools.

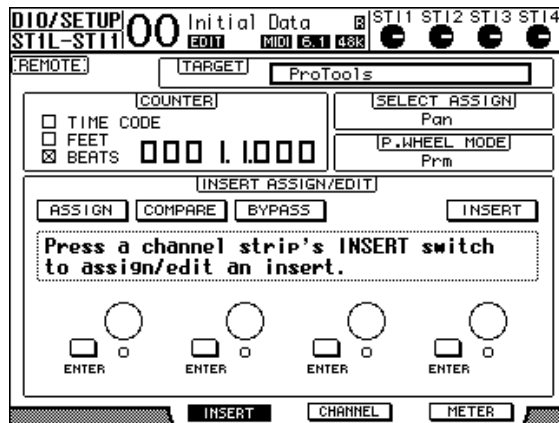

Note: When the Pro Tools Remote layer is selected, the 01V96's top panel faders and other channel buttons are available for remote control. To control the 01V96, you need to select an Input Channel Layer or the Master Layer.

Display

While the Pro Tools layer is selected, you can use the [F2]–[F4] buttons as well as the left and right [◀]/[▶] Tab Scroll buttons to select display modes. You can select the following display modes using these buttons:

■ Insert Display mode ([F2] button)

Press the [F2] button to select Insert Display mode. In this mode, you can assign and edit plug-ins.

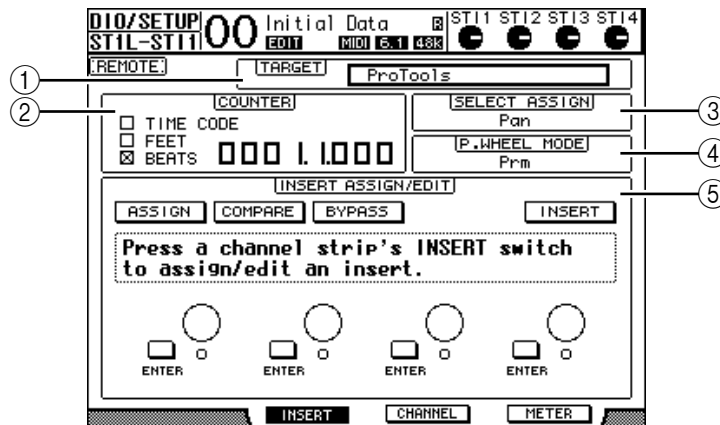

① TARGET

This parameter enables you to select the remote control target device.

② COUNTER

This counter indicates the current position. This counter works in unison with the time-code counter on Pro Tools. The display format of the counter is specified in Pro Tools. The following three check boxes in the COUNTER section indicate the currently-selected format.

- **TIME CODE:**.....Pro Tools timecode format is set to “Time Code.”
- **FEET:**Pro Tools timecode format is set to “Feet:Frames.”
- **BEATS:**.....Pro Tools timecode format is set to “Bars:Beats.”

- **If no check boxes are selected:**.....Pro Tools timecode format is set to “Minutes:Seconds” or “Samples.”

③ **SELECT ASSIGN**

This parameter indicates the current parameter, which can be adjusted via the parameter controls on the page. For example, Pan, PanR, SndA, SndB, SndC, SndD, or SndE (see page 196).

④ **P.WHEEL MODE**

This parameter indicates the function currently assigned to the Parameter wheel (see page 197).

⑤ **INSERT ASSIGN/EDIT section**

This section enables you to insert plug-ins into Pro Tools channels and adjust plug-in settings. Use the left and right [◀]/[▶] Tab Scroll buttons to change the parameters displayed in this section.

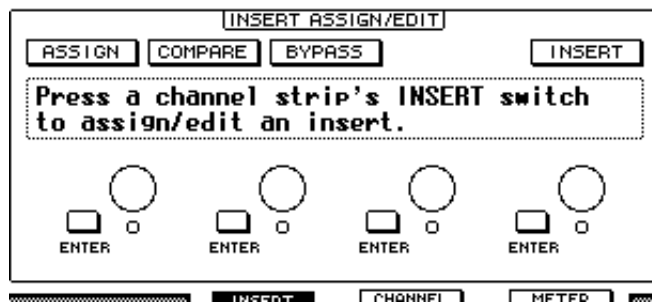

- **ASSIGN** Turn on this button to insert plug-ins into Pro Tools channels. (If you are using the TDM system, you can also assign outboard effects processors.)
- **COMPARE**..... You can compare your edits with the original settings by turning on this button. This button works in unison with the Compare button in the Pro Tools Inserts and Sends windows.
- **BYPASS** Turning on this button bypasses the plug-ins (see page 204).
- **INSERT/PARAM**..... Switching this button to INSERT enables you to assign plug-ins using four rotary controls on the page. Switching this button to PARAM enables you to adjust the plug-in parameters using the four rotary controls (see page 203).
- **Information box**..... This box displays plug-in parameter names, values, alarm messages from Pro Tools, etc.
- **Rotary controls 1–4**..... These controls enable you to select plug-ins or adjust the selected plug-in parameters.

■ **Channel Display mode ([F3] button)**

Press the [F3] button to select this display mode, in which the parameter controls for tracks 1–16 are displayed.

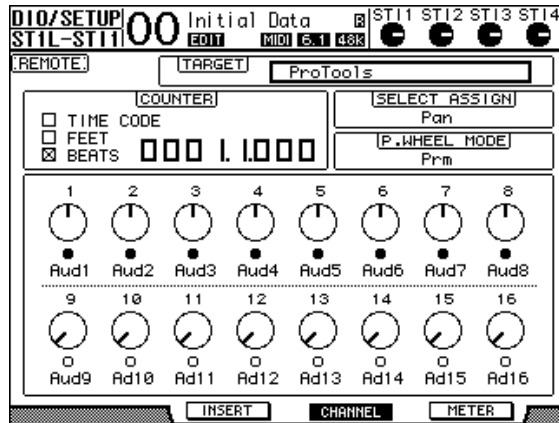

- **Parameter controls 1–16** Channel parameter controls, such as channel 1–16 panpots, Send A–E send levels, etc. are displayed.

■ **Meter Display mode ([F4] button)**

Press the [F4] button to select this display mode, in which the level meters for tracks 1–16 are displayed.

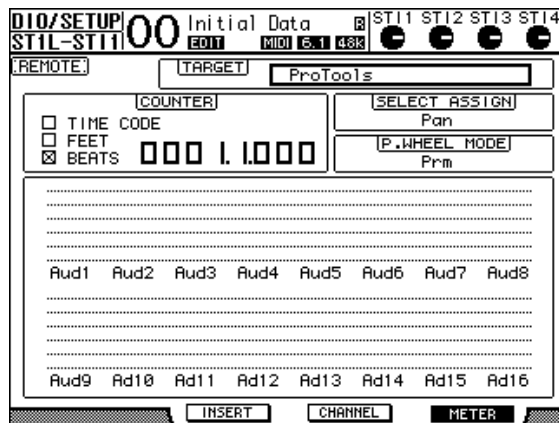

- **Channels 1–16**.....The channel 1–16 levels or Send levels are displayed.

Control Surface Operation

When the Pro Tools Remote layer is selected, the 01V96 controls on the top panel engage the following functions:

■ Channel Strip section

- **[SEL] buttons**
These buttons select Pro Tools channels, inserts, and Automation mode.
- **[SOLO] buttons**
These buttons solo Pro Tools channels. The button indicators for the soloed channels light up.
- **[ON] buttons**
These buttons mute Pro Tools channels.
- **Faders**
The faders set Pro Tools channel levels, including the audio tracks, MIDI tracks, master fader, Aux Ins, etc. If 16 or fewer channels are displayed in Pro Tools, faders are assigned starting from the left-most channel.

■ FADER MODE Section

- **[AUX 1]–[AUX 5] buttons**
These buttons select Sends A–E so that you can adjust the corresponding Pro Tools channel send level.
- **[AUX 6] button**
Press and hold down this button and press the desired [SEL] button to reset the corresponding channel fader level.
Move the cursor to the parameter control on the display, then press and hold down this button and press [ENTER] to reset the corresponding channel panpot to center. While you are holding down the [AUX 6] button, the SELECT ASSIGN parameter indicates “DFLT.”
- **[AUX 7] button**
When this button is turned on, you can adjust the selected channel panpot using the SELECTED CHANNEL [PAN] control. If you turn on this button while a Channel Display mode page is selected, you can adjust each channel panpot using parameter controls 1–16. To adjust the stereo channel panpots, press this button repeatedly to toggle between L and R channels.
- **[AUX 8] button**
Use this button along with the desired [SEL] button to assign a plug-in to the corresponding Pro Tools channel (see page 202).
- **[HOME] button**
This button turns Flip mode (see page 201) on or off. Flip mode enables you to adjust the Aux Send parameters using the faders, [ON] buttons, and the [PAN] control.

■ **DISPLAY ACCESS section**

- **[PAIR/GROUP] button**
Press this button while a Channel Display mode or Meter Display mode page is selected to display a Group ID to which each channel belongs.
- **[EFFECT] button**
Press this button to display or hide the Insert window in Pro Tools.

■ **Display section**

- **[F1] button**
Press this button to reset the Clipping and Peak Hold indicators on Meter Display mode pages.
- **Tab Scroll buttons ([◀]/[▶])**
These buttons switch the INSERT ASSIGN/EDIT parameter settings on Insert Display mode pages.

■ **Data Entry section**

- **[ENTER] button**
This button switches the on/off status of the buttons on the display.
- **Left, Right, Up, Down ([◀]/[▶]/[▲]/[▼]) cursor buttons**
These buttons move the cursor on the display.
- **[INC] & [DEC] buttons**
The [INC] button works the same as the Enter key on your computer keyboard. The [DEC] button works the same as the Esc key on your computer keyboard.
- **Parameter wheel**
The Parameter wheel enables you to adjust the currently-selected parameter, or execute the shuttle and scrub operation. By default, it adjusts the value of the currently-selected parameter (The P.WHEEL MODE parameter indicates “Prm.”).

■ **USER DEFINED KEYS section**

- **[1]–[8] buttons**
You can assign one of 194 parameters to each of these buttons. In particular, if you assign any of 54 Remote Control parameters to these buttons, you can operate the transport section and select various Pro Tools modes from the 01V96 top panel. See page 235 for more information on assigning the parameters to the buttons.

Parameter	Function
DAW REC	Places Pro Tools in Record Enabled mode. The button indicator flashes while the transport section is stopped. The indicator lights up when recording starts.
DAW PLAY	Starts playback from the current cursor position.
DAW STOP	Stops playback and recording.
DAW FF	Fast forwards the cursor position.
DAW REW	Fast rewinds the cursor position.
DAW SHUTTLE	Switches the Wheel mode to Shuttle.
DAW SCRUB	Switches the Wheel mode to Scrub (Jog).
DAW AUDITION	You can audition the pre-roll, post-roll, in-point area, or out-point area by holding down the button to which this function is assigned and pressing a button to which DAW PRE, DAW POST, DAW IN, or DAW OUT is assigned.

Parameter	Function
DAW PRE	Plays back from the pre-roll point up to the beginning of the selected area.
DAW IN	Plays back from the beginning of the selected area for a duration specified as the pre-roll.
DAW OUT	Plays back to the end of the selected area for a duration specified as the post-roll.
DAW POST	Plays back from the end of the selected area for a duration specified as the post-roll.
DAW RTZ	Moves the playback cursor to the beginning of the session.
DAW END	Moves the playback cursor to the end of the session.
DAW ONLINE	Toggles between on-line and off-line.
DAW LOOP	Toggles Loop Playback on and off.
DAW QUICKPUNCH	Toggles QuickPunch on and off.
DAW AUTO FADER	Correspond to the Automation Overwrite (Auto Enable) functions.
DAW AUTO MUTE	
DAW AUTO PAN	
DAW AUTO SEND	
DAW AUTO PLUGIN	
DAW AUTO SENDMUTE	
DAW AUTO READ	Select Automation modes.
DAW AUTO TOUCH	
DAW AUTO LATCH	
DAW AUTO WRITE	
DAW AUTO TRIM	
DAW AUTO OFF	
DAW AUTO SUSPEND	Cancels Automation recording and playback for all channels. When Automation is interrupted, the LED flashes, and channel strip controls maintain the current settings.
DAW AUTO STATUS	Displays the channel Automation mode (Read, Tch, Ltch, Wrt, or Off). The mode setting appears at the bottom of each channel on a Channel or Meter Display page when you press and hold the button to which this function is assigned.
DAW GROUP STATUS	Displays a Group ID (to which each channel belongs) below each channel number on a Channel or Meter Display page (in all caps for a main group and in lowercase letters for a sub-group).
DAW MONI STATUS	Pressing the key (to which this function is assigned) enables you to view the current monitoring mode and the channel strip type.
DAW CREATE GROUP	Pressing the key (to which this function is assigned) enables you to execute the function specified in the menu of the Pro Tools Group list.
DAW SUSPEND GROUP	Suspends all mix groups temporarily. Press the button again to undo suspension.
DAW WIN TRANSPORT	Shows or hides the Transport window.
DAW WIN INSERT	Shows or hides the Insert window.
DAW WIN MIX/EDIT	Toggles between the Mix window and Edit window. (Both windows are not displayed at the same time.)
DAW WIN MEM-LOC	Shows or hides the Memory Locations window.
DAW WIN STATUS	Shows or hides the Status window.
DAW UNDO	Executes the Edit menu's Undo/Redo command.
DAW SAVE	Executes the Edit menu's Save command.
DAW EDIT MODE	Pressing the button (to which this function is assigned) repeatedly selects Shuffle, Slip, Spot, or Grid edit mode in this order.
DAW EDIT TOOL	Pressing the button (to which this function is assigned) repeatedly selects one of seven edit tools (Zoomer, Trimmer, Selector, Grabber, Smart Tool, Scrubber, and Pencil, in this order).

Parameter	Function
DAW SHIFT/ADD	Functions in the same way as Macintosh keyboard keys (Shift, Option, Control, and Alt). Pressing one of the buttons (to which these functions are assigned) along with another button enables you to execute various commands.
DAW OPTION/ALL	
DAW CTRL/CLUCH	
DAW ALT/FINE	
DAW BANK +	Executes the Bank Swap operation. Pressing the button (to which this function is assigned) switches the entire 16-channel bank.
DAW BANK –	
DAW Channel +	Executes the Channel Scroll operation. Pressing the buttons (to which these functions are assigned) enables you to scroll channels horizontally.
DAW Channel –	
DAW REC/RDY 1	Pressing the buttons (to which these functions are assigned) places the corresponding channel strips in Record Ready mode. At this time, the indicator of the button you pressed flashes. It lights up when recording starts.
DAW REC/RDY 2	
DAW REC/RDY 3	
DAW REC/RDY 4	
DAW REC/RDY 5	
DAW REC/RDY 6	
DAW REC/RDY 7	
DAW REC/RDY 8	
DAW REC/RDY 9	
DAW REC/RDY 10	
DAW REC/RDY 11	
DAW REC/RDY 12	
DAW REC/RDY 13	
DAW REC/RDY 14	
DAW REC/RDY 15	
DAW REC/RDY 16	
DAW REC/RDY ALL	If no channel strips are in Record Enabled mode, pressing the button (to which this function is assigned) places all channel strips in Record Enabled mode. The button indicator flashes if any channel strip in any bank is in Record Enabled mode. Pressing the button while the button indicator is flashing cancels Record Enabled mode for all channel strips.

Selecting Channels

To select a single Pro Tools channel, press the [SEL] button that corresponds to the desired channel.

To select multiple Pro Tools channels simultaneously, while holding down one [SEL] button, press the [SEL] buttons of the other channels you wish to add. Press the [SEL] buttons again to cancel the selection.

Setting Channel Levels

- 1 Make sure that the FADER MODE [HOME] button indicator is lit steadily.**
If the indicator is flashing, press the [HOME] button to turn on the button indicator.
- 2 Operate the faders to set channel levels.**
Press and hold down the [AUX 6] button and press the desired [SEL] button to reset the corresponding channel fader level.

Muting Channels

To mute Pro Tools channels, press the [ON] buttons. The [ON] button indicators of muted channels turn off. Grouped channels are muted together.

Press the [ON] buttons again to unmute channels. The [ON] button indicators of unmuted channels light up.

There are two mute modes in Pro Tools: Implicit mute and Explicit mute. You can check the mute mode by viewing the [ON] button indicators.

- **Implicit mute** This is a forced mute mode in which the channels are muted because other channels are soloed. In this mode, the [ON] button indicators flash.
- **Explicit mute** In this mode, the channels are turned off manually. In this mode, the [ON] button indicators turn off.

Panning Channels

You can adjust the Pro Tools channel pan settings.

1 Press the FADER MODE [AUX 7] button.

The button indicator lights up.

2 Press the [F3] button to select Channel Display mode.

On a Channel Display mode page, parameter controls 1–16 indicate the pan settings.

3 Press the [SEL] button of the channel for which you want to adjust the pan setting.

To adjust the stereo channel panpots, press the STEREO [SEL] button, then press the [AUX 7] button to select the L or R channel. Pressing the [AUX 7] button repeatedly toggles between the left and right channels. When the left channel is selected, the [AUX 7] button indicator lights up and the SELECT ASSIGN parameter on the display indicates “Pan.” When the right channel is selected, the [AUX 7] button indicator flashes and the SELECT ASSIGN parameter indicates “PanR.”

Note: Before you adjust monaural channel panpots, first be sure the [AUX 7] button indicator is illuminated steadily. If the indicator is flashing, operating the [PAN] control will be ineffective.

4 Adjust the selected channel panpot using the SELECTED CHANNEL [PAN] control.

5 To reset the corresponding channel panpot to center, move the cursor to the parameter control on the display, then press and hold down the [AUX 6] button and press [ENTER].

You can reset the pan settings only when the [AUX 7] button indicator is lit steadily.

Soloing Channels

To solo Pro Tools channels, press the [SOLO] buttons of the desired channels. Grouped channels are soloed together, and other channels are muted.

Press the [SOLO] buttons again to unsolo the channels.

Configuring Sends A–E as Pre or Post

You can set Pro Tools channels for the selected Sends (A–E) to pre or post.

1 Press the [F3] button to select Channel Display mode.

- 2 Press the **FADER MODE [AUX 1]–[AUX 5]** buttons to select the desired Sends (A–E).
- 3 To toggle between pre and post, move the cursor to the parameter control on the display, then press **[ENTER]**.
Pressing **[ENTER]** repeatedly toggles between pre and post.

Setting Send Levels

You can adjust Pro Tools Send (A–E) send levels as follows.

- 1 Press the **[F3]** button to select **Channel Display mode**.
- 2 Press the **AUX SELECT [AUX 1]–[AUX 5]** buttons to select the desired Sends (A–E).
- 3 Move the cursor to the parameter control of the channel for which you want to adjust the Send level, then rotate the **Parameter wheel**.

You can set Send levels by operating the faders if faders, **[ON]** buttons, and the **[PAN]** control are in Flip mode. Refer to “Flip Mode” for more information.

Muting Sends A–E

You can mute Sends by pressing the **[ON]** buttons if faders, **[ON]** buttons, and the **[PAN]** control are in Flip mode. Refer to “Flip Mode” for more information.

Panning Sends A–E

You can pan channel signals sent to stereo Aux Sends by rotating the **SELECTED CHANNEL [PAN]** control if faders, **[ON]** buttons, and the **[PAN]** control are in Flip mode. Refer to the next section for more information.

Flip Mode

In Flip mode, you can use the faders, **[ON]** buttons, and the **[PAN]** control to control send levels, pre/post positions, and mute settings as shown in the following table.

Control	Normal mode	Flip Mode
Faders	Channel level	AUX Send level
[ON] buttons	Channel mute	AUX Send mute
[PAN] control	Channel pan	AUX Send pan

- 1 Press the **FADER MODE [HOME]** button repeatedly so that the button indicator flashes.
The **SELECT ASSIGN** parameter on the display indicates “FLIP.”
- 2 Press the **FADER MODE [AUX 1]–[AUX 5]** buttons to select the desired Aux Sends (A–E).
The button indicator of the selected send lights up.
- 3 Use the faders, **[ON]** buttons, and the **[PAN]** control to control the currently-selected Aux send.
For stereo Aux input channels, you can set the left and right panpots individually. To do this, press the **FADER MODE [AUX 7]** button repeatedly. When the button indicator is lit continuously, you can set the left panpot. When the button indicator is flashing, you can set the right panpot.

Assigning Plug-ins to Pro Tools Channels

You can assign plug-ins to five inserts available for Pro Tools channel strips as follows.

- 1 Press the [F2] button to select Insert Display mode.
- 2 Press the FADER MODE [AUX 8] button.

The [AUX 8] button indicator flashes. You can now select a channel to which you want to insert plug-ins.

- 3 Press the [SEL] button of each desired channel.
- 4 Make sure that the INSERT/PARAM button (①) is selected in the INSERT ASSIGN/EDIT section.

If the PARAM button is selected instead, move the cursor to the button, then press [ENTER] to select INSERT.

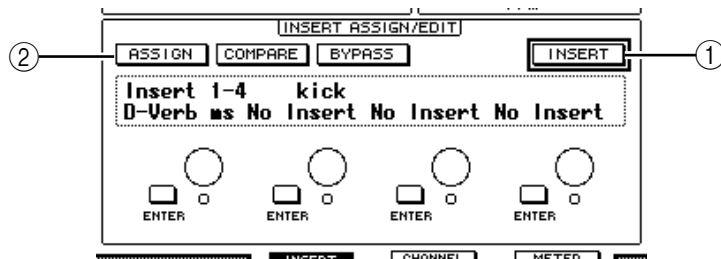

- 5 Move the cursor to the ASSIGN button (②), then press [ENTER] to turn on the button.

You can now select plug-ins. If you press another channel's [SEL] button after you turn on the ASSIGN button, the button turns off. If you wish to assign plug-ins to other channels, turn on the ASSIGN button again.

- 6 Move the cursor to one of the four parameter controls, then rotate the Parameter wheel to select a plug-in.

By default, the parameter controls enable you to select plug-ins to be assigned to channel inserts #1–#4. To assign a plug-in to insert #5, press the Tab Scroll button [►] to change the indication in the INSERT ASSIGN/EDIT section.

If you are using the TDM system, you can also assign outboard effects processors.

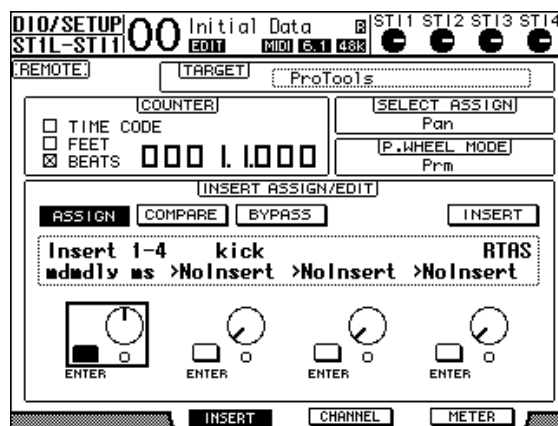

- 7 Press [ENTER] to confirm the assignment.

Repeat Steps 6 and 7 to assign more plug-ins to other insert positions in the channel strip.

- 8 In the same way, assign plug-ins to other channels.
- 9 When you finish assigning plug-ins, press the [AUX 8] button.
The button indicator turns off.

Editing Plug-ins

You can edit plug-ins inserted in the channel strips as follows:

- 1 Press the [F2] button to select Insert Display mode.
- 2 Press the corresponding [SEL] button to select the channel that was assigned the plug-in you want to edit.
- 3 In the INSERT ASSIGN/EDIT section, move the cursor to the parameter control (Insert 1–4) that was assigned the parameter you want to edit.

Note: To adjust a plug-in assigned to insert #5, press the Tab Scroll button [▶] to change the parameter indication in the INSERT ASSIGN/EDIT section, then select a parameter control.

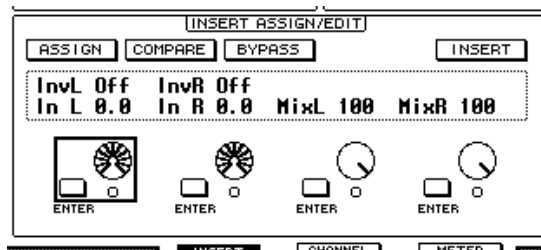

- 4 Press [ENTER] to display the parameters.

In the INSERT ASSIGN/EDIT section, the PARAM button is automatically selected and the Information box indicates the selected plug-in parameters.

You can now use parameter controls 1–4 and the [ENTER] button to adjust the parameters.

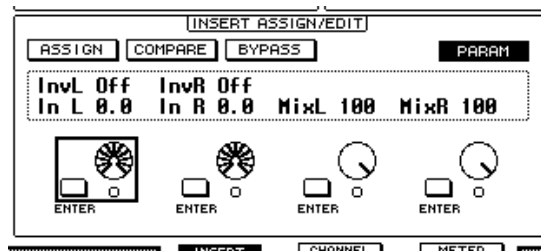

- 5 Use the Tab Scroll buttons to display the parameter value you wish to change.

Most plug-ins feature five or more parameters. To edit the fifth or subsequent parameters, use the Tab Scroll buttons to display the desired parameters and their values in the INSERT ASSIGN/EDIT section. The current page number and the plug-in name appear for a moment immediately after you press the Tab Scroll buttons.

- 6 Move the cursor to a parameter control, then rotate the Parameter wheel or press the [ENTER] button to adjust the value.

One or two parameters are assigned to a single parameter control. To turn the parameter setting on or off, press [ENTER]. To modify the parameter variable, rotate the Parameter wheel.

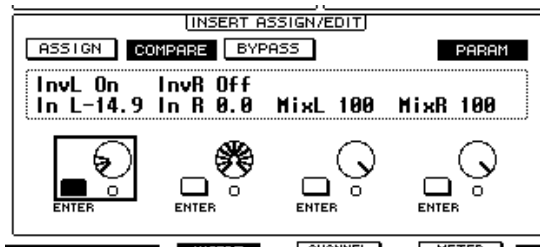

- 7 When you finish adjusting the parameters, move the cursor to the INSERT/PARAM button, then press [ENTER] to switch it to INSERT.

Bypassing Plug-ins

You can bypass plug-ins assigned to Pro Tools channels.

Before bypassing plug-ins, you must press the corresponding [SEL] button to select a channel to which the plug-ins have been assigned, then press the [F2] button to select Insert Display mode.

To bypass plug-ins, display the parameters of the plug-in you wish to bypass in the INSERT ASSIGN/EDIT section, then turn on the BYPASS button.

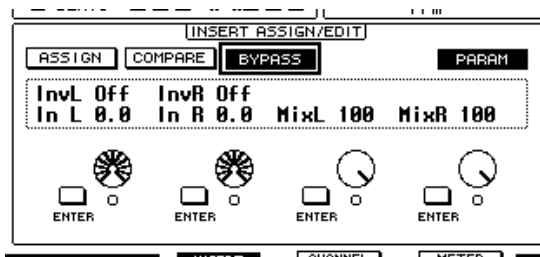

Scrub & Shuttle

By assigning the **DAW SCRUB** parameter to one of the User Defined buttons [1]–[8], you can scrub Pro Tools tracks back and forth by turning the Parameter wheel. By assigning the **DAW SHUTTLE** parameter to one of the User Defined buttons [1]–[8], you can shuttle back and forth by turning the Parameter wheel.

- 1 Assign the **DAW SCRUB** or **DAW SHUTTLE** parameter to one of the User Defined buttons [1]–[8].

Before assigning parameters to these buttons, you must switch layers to cancel the Remote function. See page 235 for more information on assigning the parameters to the User Defined buttons.

- 2 Press the **LAYER [REMOTE]** button to enable remote control of Pro Tools.
- 3 Make sure that Pro Tools is stopped.
- 4 Press the User Defined button to which you assigned the **DAW SCRUB** or **DAW SHUTTLE** parameter in Step 1.

You can now use the Scrub or Shuttle function.

5 Rotate the Parameter wheel.

Rotate the Parameter wheel clockwise to scrub or shuttle forwards. Turn it counterclockwise to scrub or shuttle backwards.

The minimum scrub playback step varies depending on the zoom setting in the Pro Tools Edit window.

6 To cancel the Scrub or Shuttle function, press the User Defined button or DAW SHUTTLE to which you assigned the DAW SCRUB parameter in Step 1.

Alternatively, you can cancel the Scrub or Shuttle function by pressing the User Defined button to which the DAW STOP parameter is assigned. The Scrub function is automatically cancelled if you commence playback or fast forward.

***Note:** The Scrub/Shuttle operation might be stopped unexpectedly by Pro Tools. Therefore, whenever you use the Scrub or Shuttle function, make sure that the P.WHEEL MODE parameter indicates “SCRUB” or “SHUTTLE.” You can check the Scrub/Shuttle function status by viewing the corresponding User Defined button indicator.*

Automation

If you assign a parameter that controls Pro Tools Automation mode (such as DAW Auto Read, DAW Auto Touch, etc.) to one of the User Defined buttons, you can control the Automation settings for each channel by using that User Defined button. See page 235 for more information on assigning parameters to User Defined buttons.

Press the STEREO OUT channel [SEL] button. The button indicator lights up, and the Channel 1–16 [SEL] buttons become available for the Automation mode setting.

Press the desired channel [SEL] buttons while pressing the programmed User Defined button to switch the corresponding channels’ Automation settings.

While the channel [SEL] buttons are available for the Automation mode setting, pressing the [SEL] buttons will cause the Fader Touch or Untouch command to be transmitted to Pro Tools. This is useful for Automation punch in and out recording.

***Note:** Operating a fader also causes the Fader Touch command to be transmitted. Also, whenever the transport mode changes (such as Play and Stop), the Fader Untouch command is transmitted.*

Depending on the currently-selected Automation mode, the channel [SEL] button indicators operate as follows:

User Defined Keys Function	Pro Tools Automation Mode	[SEL] Button Indicators
DAW AUTO WRITE	Auto write	Flashing red (Record Ready) Red (Recording)
DAW AUTO TOUTCH	Auto touch	
DAW AUTO LATCH	Auto latch	
DAW AUTO READ	Auto read	Illuminated steadily
DAW AUTO OFF	Auto off	Off

Nuendo/Cubase SX Remote Layer

You can remotely control Nuendo and Cubase SX using the Remote Layer.

■ Configuring Computers

- 1 **Connect the 01V96 to your computer using a USB cable, and install the required USB driver included on the 01V96 CD-ROM.**

Refer to the Studio Manager installation guide for more information on installing the driver.

- 2 **Launch Nuendo/Cubase SX, select the Device Setup menu, and set up Nuendo/Cubase SX so that the 01V96 can communicate with the software.**

Refer to the Nuendo/Cubase SX User's Manual for more information on setting up the software.

■ Configuring the 01V96

- 1 **Refer to page 192 to configure the DIO/Setup | MIDI/HOST page.**

- 2 **Press the LAYER [REMOTE] button to set the TARGET parameter to Nuendo/Cubase SX.**

You can now remotely control Nuendo/Cubase SX using the Remote Layer.

Other DAW Remote Layer

You can remotely control DAW software that supports the Pro Tools protocol.

■ Configuring Computers

- 1 **Connect the 01V96 to your computer using a USB cable, and install the required USB driver included on the 01V96 CD-ROM.**

Refer to the Studio Manager installation guide for more information on installing the driver.

- 2 **Launch and set up the DAW software so that the 01V96 communicates with the software.**

Refer to the DAW software's user's manual for more information on setting up the software.

■ Configuring the 01V96

- 1 **Refer to page 192 to configure the DIO/Setup | MIDI/HOST page.**

- 2 **Press the LAYER [REMOTE] button to set the TARGET parameter to General DAW.**

You can now remotely control the DAW software using the Remote Layer.

MIDI Remote Layer

If you select USER DEFINED as the target for the Remote Layer, you can remotely control the parameters of external MIDI devices (such as synthesizers and tone generators) by operating the channel [ON] buttons, and faders to output various MIDI messages. (This is called MIDI Remote function.)

You can store MIDI messages assigned to the channel controls in four banks. When the 01V96 is shipped from the factory, it includes MIDI settings in these banks, which you can quickly recall to use the MIDI Remote function.

If necessary, you can also assign other MIDI messages to the faders or [ON] buttons to remotely control the parameters of a connected MIDI device.

Using the MIDI Remote Function

This section describes how to recall and use the factory-preset MIDI Remote settings stored in the banks.

By default, the 01V96's four MIDI Remote banks (Banks 1–4) contain the following MIDI messages.

Bank	Usage	Control Function	
		[ON] buttons	Faders
1	Panning and setting GM sound levels	—	Volume
2	Setting GM sound effect send levels	—	Effect Send
3	Setting XG sound levels	—	Volume
4	Adjusting mute, and levels for Cubase series mixer	Mute	Volume

- 1 Connect the 01V96's MIDI OUT port to the MIDI IN port of the MIDI device.

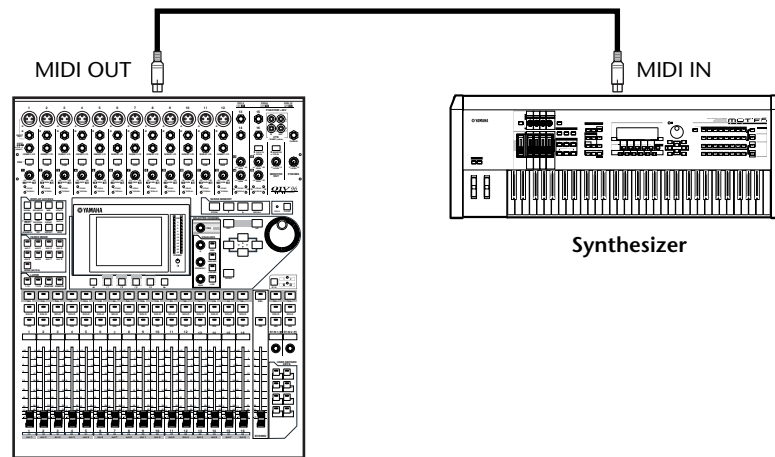

- 2 Press the DISPLAY ACCESS [DIO/SETUP] button repeatedly until the DIO/Setup | MIDI/Host page appears.

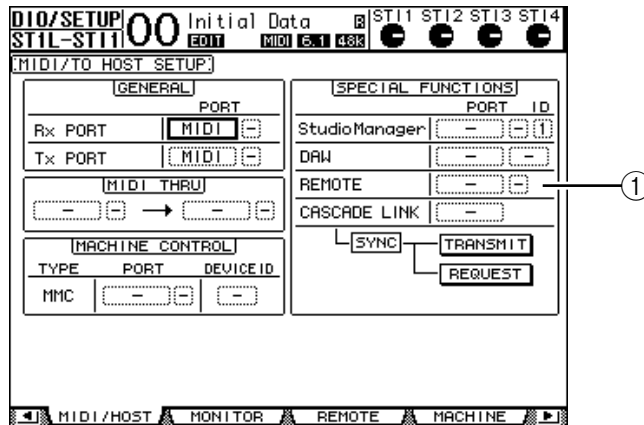

- 3 Move the cursor to the REMOTE parameter box (①) in the SPECIAL FUNCTIONS section, rotate the Parameter wheel to select MIDI, then press [ENTER].

If the MIDI port is already in use, a window confirming the assignment change appears. Move the cursor to the YES button, then press [ENTER].

Tip: If the REMOTE parameter box is grayed out, proceed to Steps 4 and 5 to set the TARGET parameter, then return to Steps 2 and 3.

- 4 Press the DISPLAY ACCESS [DIO/SETUP] button repeatedly until the DIO/Setup | Remote page appears.
- 5 Move the cursor to the TARGET parameter box, rotate the Parameter wheel to select USER DEFINED, then press [ENTER].

The confirmation window for changing the setting appears. Move the cursor to the YES button, then press [ENTER]. The display changes as follows:

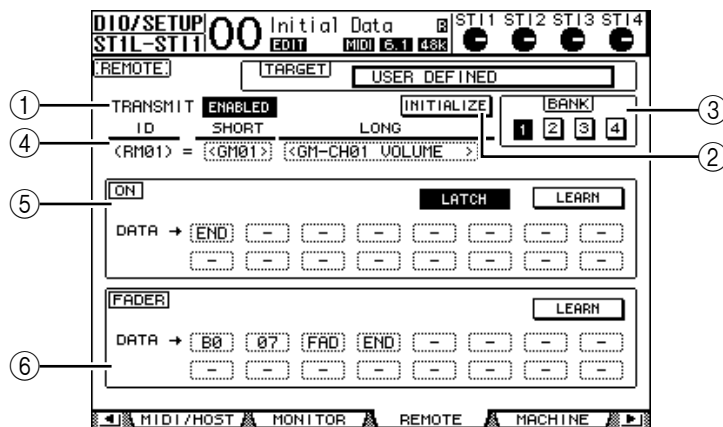

- ① **TRANSMIT ENABLE/DISABLE**
This button switches the MIDI Remote function between enable and disable.
- ② **INITIALIZE**
This button resets the settings stored in the bank selected by the BANK parameter their default settings.
- ③ **BANK**
This parameter enables you to select one of four banks.

④ ID, SHORT, LONG

These parameters display the channel names. The ID parameter displays the channel ID (RM01–RM16) for the currently-controlled MIDI device.

⑤ ON section

This section displays the type of MIDI messages (in hexadecimal or alphabet) assigned to the [ON] buttons for the currently-selected channels (RM01–RM16).

- **LATCH/UNLATCH.....** This button toggles between Latch and Unlatch for [ON] button operation.
- **LEARN.....** When you turn on this button, MIDI messages received at the MIDI IN port are assigned to the DATA parameter boxes.
- **DATA parameter boxes.....** These boxes display the type of MIDI messages (in hexadecimal or alphabets) assigned to the [ON] button).

⑥ FADER section

This section displays the type of MIDI messages (in hexadecimal or alphabet) assigned to the faders for the currently-selected channels (RM01–RM16).

- 6 Move the cursor to the desired bank button (BANK parameter buttons 1–4), then press [ENTER].
- 7 Press the LAYER [REMOTE] button to select Remote layer.
You can now use the MIDI Remote function.
- 8 Use the faders and [ON] buttons to control the MIDI device.

Assigning MIDI Messages to Channel Controls

You can quickly use the MIDI Remote function if you use the factory presets in the banks. However, you can also assign the desired MIDI messages to the faders or [ON] buttons.

This section describes how to assign MIDI messages to the channel controls, using the example of assigning Hold On/Off messages (Control Change #64; Values 127 & 0) to the Channel 1 [ON] button.

- 1 Connect the 01V96's MIDI IN port to the MIDI OUT port of a MIDI keyboard to which a Hold On/Off controllable foot switch is connected. Enable the MIDI Remote function on the 01V96.

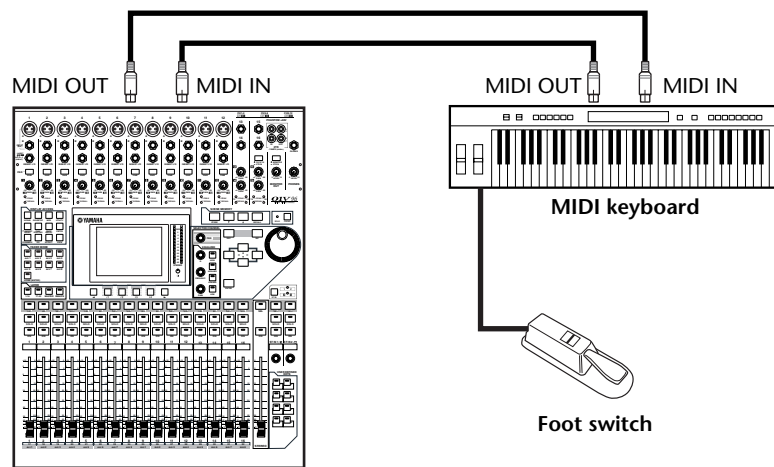

- 2 Press the **DISPLAY ACCESS [DIO/SETUP]** button repeatedly until the **DIO/Setup | Remote** page appears, then set the **TARGET** parameter to **USER DEFINED**.

You can now use the MIDI Remote function. Refer to the previous section for more information on using the MIDI Remote function.

- 3 Move the cursor to the desired bank button (**BANK** parameter buttons 1–4), then press **[ENTER]**.

- 4 Press the **[SEL]** buttons for the desired channels.

Currently-assigned MIDI messages appear in the **ON** and **FADER** sections.

*Tip: You can also choose the desired channels using the **ID**, **SHORT**, and **LONG** parameters.*

- 5 Move the cursor to the **LEARN** button in the **ON** section, then press **[ENTER]**.

MIDI messages received at the MIDI IN port of the 01V96 will be assigned to the **DATA** parameter boxes in the **ON** section.

- 6 Press and hold down the **MIDI keyboard foot switch**.

The MIDI Hold On message is assigned in the **DATA** parameter box.

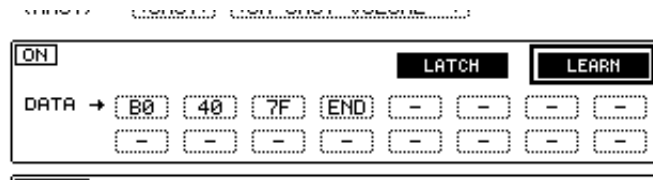

MIDI messages are described below:

- **00–7F** MIDI messages are expressed in hexadecimal.
- **END** This message indicates the end of MIDI messages. Subsequent messages assigned in the **DATA** parameter boxes will be ignored.
- **-** This message indicates that no messages are assigned to the **DATA** parameter boxes.

*Tip: When you click the **LEARN** button to assign MIDI messages, the 01V96 automatically recognizes the end of the messages and assigns **END** and “-.”*

- 7 While continuing to hold down the foot switch, turn off the **LEARN** button.

- 8 Move the cursor to the third parameter box (“7F” in this example), then rotate the **Parameter wheel** to change the value to **SW**.

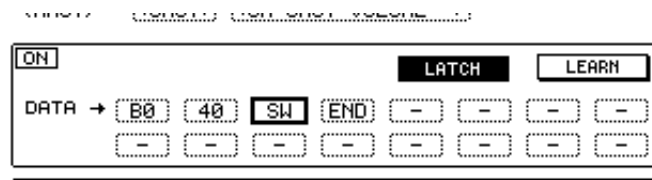

“SW” is a variable that changes depending on the **[ON]** button’s on/off status. You can use the following variables in MIDI messages.

- **SW** This variable is selectable only in the **DATA** parameter boxes of the **ON** section. When the **[ON]** buttons are turned on, “7F” (127 in decimal) is output. When the **[ON]** buttons are turned off, “00” (0 in decimal) is output.
- **FAD** This variable is selectable only in the **DATA** parameter boxes of the **FADER** section. When you operate the faders, continuously

changing values in the range of 00 to 7F (0–127 in decimal) are output.

Tip: If “SW” is not assigned in the DATA parameter boxes of the ON section, the current MIDI messages are output.

Note: Be sure to set one of the DATA parameter boxes of the FADER section to “FAD.” If no “FAD” is assigned, fader operation is ignored.

9 Move the cursor to the LATCH/UNLATCH button, then press [ENTER] to select LATCH or UNLATCH depending on how you want the [ON] buttons to function.

- **LATCH**.....Pressing the [ON] buttons repeatedly transmits alternating On and Off messages.
- **UNLATCH**Pressing and holding down the [ON] buttons transmits On messages, and releasing the [ON] buttons transmits Off messages.

Tip: Refer to the diagrams below for information on how the [ON] buttons behave when Latch or Unlatch is selected.

■ When “SW” is assigned:

- LATCH

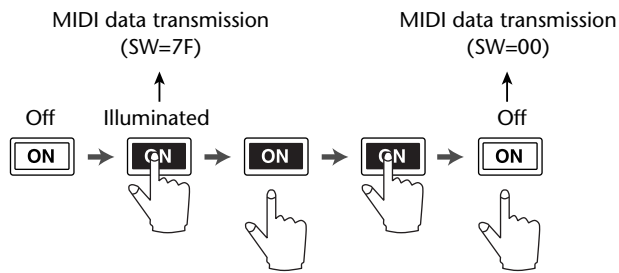

- UNLATCH

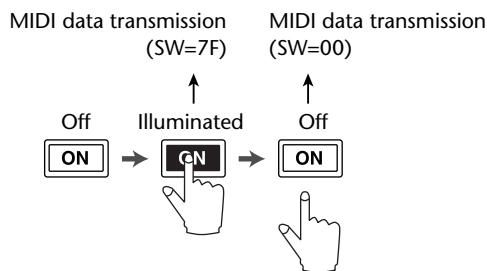

■ When “SW” is not assigned:

- UNLATCH

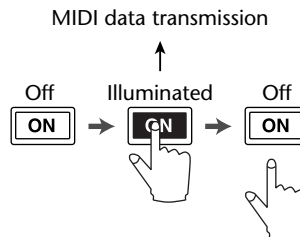

Tip: In most situations, select Unlatch if SW is not assigned.

- 10 To change the channel name, move the cursor to the ID LONG parameter box, then press [ENTER] to display the Title Edit window.

Refer to page 30 for more information on editing names.

Tip:

- Move the cursor to the INITIALIZE button, then press [ENTER]. A window is displayed that enables you to reset the parameter settings in the currently-selected bank.
- You can also assign MIDI messages to the parameter boxes manually without using the LEARN button.

Machine Control Function

The 01V96 can control the transport functions and select tracks on external recording machines that support MMC by transmitting commands via the MIDI OUT port or USB port.

Note: Controllable parameters vary depending on the connected devices. Refer to the User's Manual for the external device for more information on controllable parameters.

- 1 Refer to the diagram below for information on connecting the 01V96 to an external device.

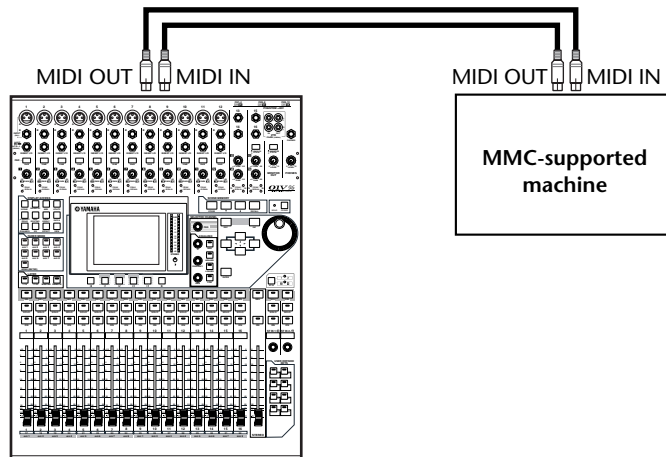

- 2 Press the DISPLAY ACCESS [DIO/SETUP] button repeatedly until the DIO/Setup | MIDI/Host page appears.

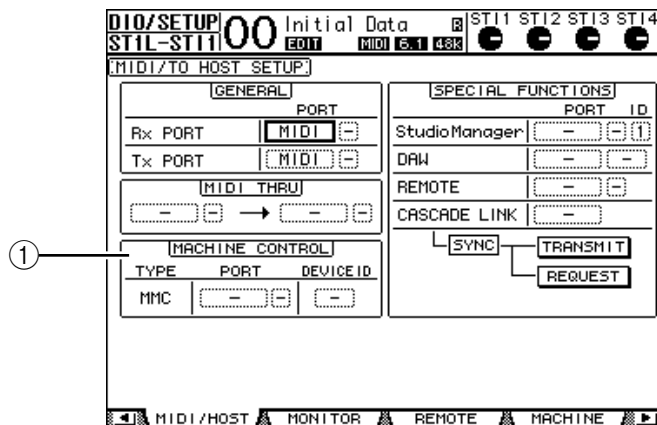

3 Move the cursor to the PORT parameter box in the MACHINE CONTROL section (①), then rotate the Parameter wheel to select the MMC destination.

The following ports and slot are available as the MMC destination.

- **MIDI**MIDI port
- **USB**USB port
- **SLOT**Slot with an MY8-mLAN (mLAN card) installed

If USB is selected, move the cursor to the adjacent parameter box (on the right), and select one of eight ports.

4 Move the cursor to the DEVICE ID parameter box, then rotate the Parameter wheel to set the 01V96 MMC Device ID to the same ID number as the external device.

MMC commands are effective on devices that use the same Device ID. Therefore, the 01V96's MMC Device ID needs to match the ID of the devices you wish to control.

5 To start remote control, press the DISPLAY ACCESS [DIO/SETUP] button repeatedly until the DIO/Setup | Machine page appears.

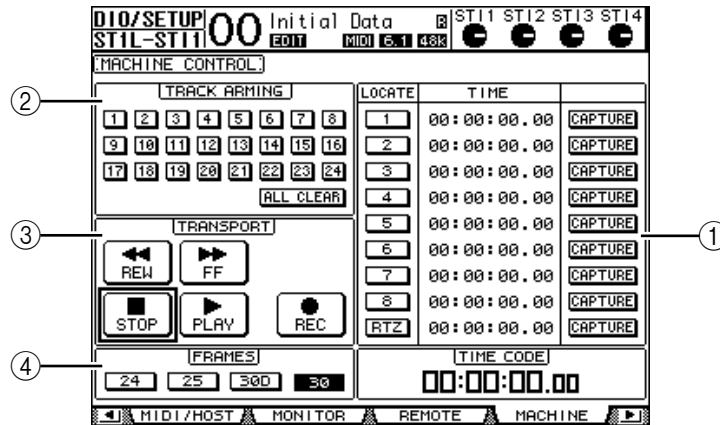

This page contains the following parameters:

① LOCATE/TIME section

This section enables you to set the locate points.

- **LOCATE 1–8** These buttons locate the positions (specified by the TIME values) on external machines.
- **RTZ** This Return To Zero button locates the zero timecode position on external machines.
- **TIME** Locate points are specified in hour/minute/second/frame format.
- **CAPTURE** These buttons capture the current position on external machines and import the information into the TIME column.

② TRACK ARMING section

This section controls the tracks on external machines.

- **1–24 buttons** These buttons turn external tracks 1–24 on or off, and set or cancel their Record Ready mode.
- **ALL CLEAR** Turning on this button switches all buttons (1–24) simultaneously.

③ **TRANSPORT section**

This section enables you to control the transport functions on external machines.

- **REW**..... This button starts rewind on external machines.
- **FF** This button starts fast forward on external machines.
- **STOP**..... This button stops external machines.
- **PLAY** This button starts playback on external machines.
- **REC**..... This button is used in conjunction with the **PLAY** button to start recording on external machines.

④ **FRAMES**

This parameter selects the timecode frame rate from 24, 25, 30D (drop frame), and 30.

- 6 **To control the transport functions, move the cursor to the desired button in the TRANSPORT section, then press [ENTER].**
- 7 **If you desire, move the cursor to the buttons and parameters in the LOCATE/TIME section and the TRACK ARMING section, then press the [ENTER] button or rotate the Parameter wheel to control the transport functions on external machines.**

***Tip:** You can also use the programmed User Defined buttons to control Machine Control functions. (See page 235 for information on assigning functions to the User Defined buttons.)*

18 MIDI

This chapter describes the 01V96's MIDI-related functions.

MIDI & the 01V96

Using Control Changes, Program Changes, and other MIDI messages enables you to recall Scenes and edit parameters on the 01V96, and store 01V96 internal data on external MIDI devices.

The 01V96 supports the following MIDI messages. Each of these MIDI messages can be individually turned on or off for transmission and reception.

- **Program Changes**

If you assign the 01V96's Scenes to Program Change numbers, the 01V96 transmits Program Changes when it recalls Scenes. Also, the 01V96 will switch Scenes when it receives Program Changes.

- **Control Changes**

If you assign the 01V96's parameters to Control Change numbers, the 01V96 transmits the assigned Control Changes when the parameter values change. Also, the 01V96 changes certain parameter values when it receives the corresponding Control Changes.

- **System Exclusive Messages**

The 01V96 transmits System Exclusive Parameter Changes in real-time when the parameter values change. Also, the 01V96 notifies certain parameter values when it receives assigned Parameter Changes.

- **MMC (MIDI Machine Control)**

MMC is used for external machine control.

- **MIDI Note On/Off**

These messages are used to adjust the Freeze effect.

- **Bulk Dump Messages**

These messages enable you to store the 01V96's internal data to a sequencer or MIDI filer. When the 01V96 receives these messages, they overwrite the 01V96 data

The 01V96 features the following interface for transmitting and receiving MIDI data.

- **MIDI IN/THRU/OUT ports**

These ports transmit and receive MIDI data to and from standard MIDI devices. Each port is a single port interface that transmits and receives single-port data (16 channels x 1 ports). The MIDI THRU port outputs MIDI messages received at the MIDI IN port without modification (as is).

- **USB port**

This port is used to connect a computer and transfer MIDI messages. This is a multiport interface that transmits and receives up to eight-port data (16 channels x 8 ports). If you connect a computer to the USB port, you must install the appropriate driver software on the computer. See the Studio Manager Installation Guide for more information on installing drivers.

Note: If the computer is turned on but the USB MIDI application has not been launched, 01V96 performance may be slow. In this case, cancel the assignment of the USB port as the MIDI message transmission port.

- **SLOT**

If an optional “MY8-mLAN” I/O card is installed in the slot, MIDI data transfer to and from an external MIDI device is available via the MY8-mLAN card.

MIDI Port Setup

Selecting a Port for MIDI Message Transfer

To configure MIDI ports for MIDI message transfer, press the DISPLAY ACCESS [DIO/SETUP] button repeatedly until the DIO/Setup | MIDI/Host page appears. This page enables you to set MIDI message input and output.

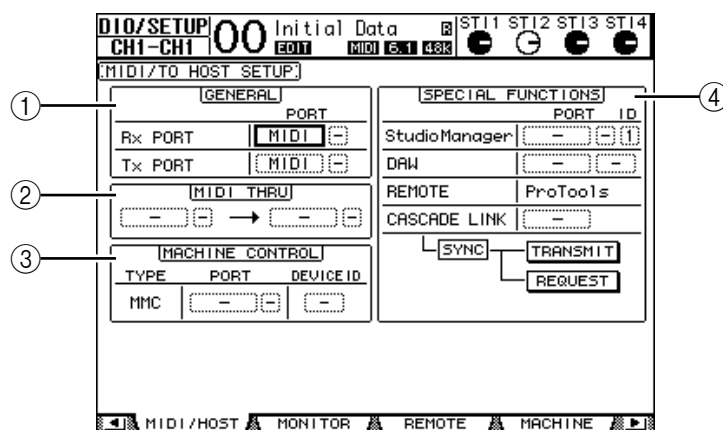

The following parameters are available on this page:

① **GENERAL section**

This section enables you to select ports that transmit and receive MIDI messages, such as Program Changes and Control Changes.

- **Rx PORT** This parameter specifies a port for general MIDI data reception. In the left parameter box, select MIDI, USB, or SLOT. If you select USB or SLOT, specify the port number (1–8) in the right parameter box.
- **Tx PORT** This parameter specifies a port for general MIDI data transmission. The available ports are the same as for the Rx PORT parameter.

② **MIDI THRU section**

These parameters enable you to route incoming MIDI data from one port or slot to another without changes. Select a port for reception in the first parameter box, and select a port for transmission in the next parameter box (located to the right of the arrow). If you select USB or SLOT, specify the port number in the small parameter box adjacent to the port parameter box.

③ **MACHINE CONTROL section**

This section enables you to select a remote control method and a remote control port to control external devices that support MMC, such as a hard disk recorder.

- **PORT** Select MIDI, USB, or SLOT for MMC command transfer. If you select USB or SLOT, specify the port number in the right parameter box.

- **DEVICE ID** Specify the 01V96's MMC Device ID. MMC Device IDs identify connected devices, enabling recognition during MMC transmission and reception.

④ **SPECIAL FUNCTIONS section**

This section enables you to specify ports for various special functions.

- **Studio Manager** In the left parameter box, select MIDI, USB or SLOT as the port used by the included Studio Manager software. In the two small parameter boxes on the right, specify a port number (if you selected USB), and an ID number.
- **DAW** Select USB or SLOT as a port for use with a DAW. Specify in the right parameter box a port number pair (1–2, 3–4, 5–6, 7–8).
- **REMOTE** This parameter indicates the target currently selected for Remote Layer. If the target is set to "USER DEFINED," you can select a MIDI message destination port.
- **CASCADE LINK** This parameter determines whether MIDI messages are transmitted between two cascaded 01V96s. If you select MIDI, MIDI messages will be transferred between two cascaded units. If you select "–," no MIDI messages are transferred.
The TRANSMIT and REQUEST buttons are used to synchronize all parameters that are cascade-linked. The TRANSMIT button synchronizes the connected 01V96's parameters to your primary 01V96's parameters. The REQUEST button synchronizes your 01V96 parameters to the connected 01V96's parameters.

Selecting MIDI Messages for Transmission and Reception

You can select MIDI messages to be transmitted or received at a specified port.

To do so, press the DISPLAY ACCESS [MIDI] button, then press the [F1] button to display the MIDI | Setup page.

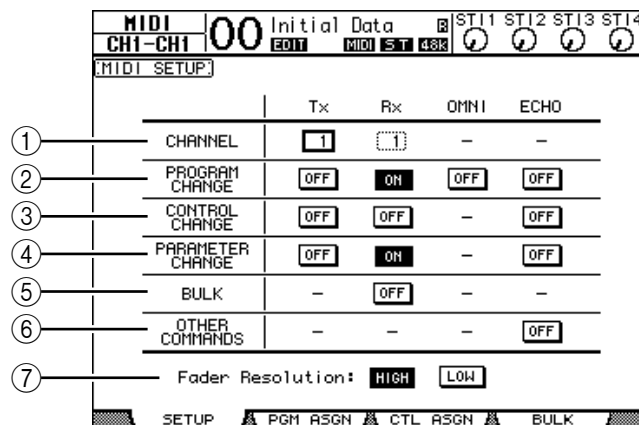

Select MIDI channels for transmission and reception in the CHANNEL row, and turn the transmission and reception of each MIDI message on or off using the buttons in the parameter rows from PROGRAM CHANGE to OTHER COMMANDS.

① CHANNEL

This parameter row enables you to specify MIDI Channels for MIDI message transmission and reception. The following parameters are available in this row:

- **Tx** This parameter box specifies a MIDI Transmit Channel.
- **Rx** This parameter box specifies a MIDI Receive Channel.

② PROGRAM CHANGE

This parameter row enables or disables transmission and reception of Program Changes.

- **Tx ON/OFF** Transmission of Program Change messages is enabled or disabled.
- **Rx ON/OFF** Reception of Program Change messages is enabled or disabled.
- **OMNI ON/OFF** When this button is turned on, Program Changes on all MIDI Channels are received regardless of the CHANNEL row settings.
- **ECHO ON/OFF** This button determines whether Program Change messages received at the MIDI IN port are echoed through to the MIDI OUT port.

③ CONTROL CHANGE

This parameter row enables or disables transmission and reception of Control Changes.

- **Tx ON/OFF** Transmission of Control Change messages is enabled or disabled.
- **Rx ON/OFF** Reception of Control Change messages is enabled or disabled.
- **ECHO ON/OFF** This button determines whether Control Change messages received at the MIDI IN port are echoed through to the MIDI OUT port.

④ PARAMETER CHANGE

This parameter row enables or disables transmission and reception of Parameter Changes.

- **Tx ON/OFF** Transmission of Parameter Change messages is enabled or disabled.
- **Rx ON/OFF** Reception of Parameter Change messages is enabled or disabled.
- **ECHO ON/OFF** This button determines whether Parameter Change messages received at the MIDI IN port are echoed through to the MIDI OUT port.

⑤ BULK

This parameter row enables or disables reception of Bulk Dump data.

- **Rx ON/OFF** Reception of Bulk Dump data is enabled or disabled.

⑥ OTHER COMMANDS

- **ECHO ON/OFF** This button determines whether other MIDI messages received at the MIDI IN port are echoed through to the MIDI OUT port.

⑦ Fader Resolution

This parameter specifies the resolution of the value output when you operate the 01V96's faders. To transfer fader value data between two cascaded 01V96s, or to record the 01V96 operation to or play it back from a sequencer, select the HIGH button. When the LOW button is selected, the fader resolution switches to 256 steps.

Assigning Scenes to Program Changes for Remote Recall

You can assign 01V96 Scenes to MIDI Program Changes for remote recall. When you recall a Scene on the 01V96, the unit transmits the assigned Program Change to the connected MIDI device. When the 01V96 receives a Program Change, the assigned Scene is recalled. Initially, Scenes 1 through 99 are assigned sequentially to Program Changes 1 through 99, and Scene #0 is assigned to Program Change #100, although you can change these assignments.

Tip: You can store a Scene to Program Change assignment table to an external device by using MIDI Bulk Dump or the included Studio Manager software.

- 1 Press the **DISPLAY ACCESS [DIO/SETUP]** button repeatedly until the **DIO/Setup | MIDI/Host** page appears, then specify ports for transmission and reception of MIDI messages (see page 216).
- 2 Make connections using the ports selected in Step 1 so that the 01V96 can transfer MIDI messages to and from the external device.
- 3 Press the **DISPLAY ACCESS [MIDI]** button, then press the **[F2]** button.

The **MIDI | Pgm Asgn** page appears.

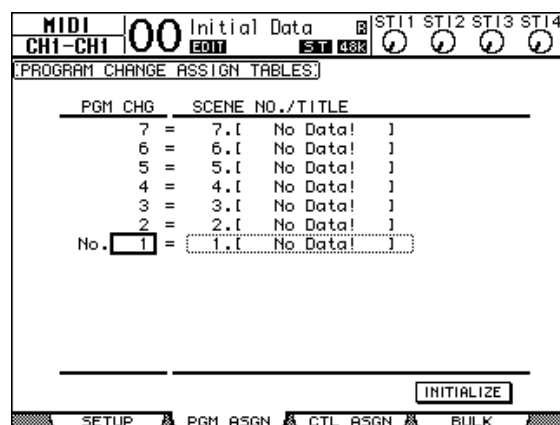

- 4 Move the cursor to a parameter box in the PGM CHG column, and rotate the Parameter wheel or press the [INC]/[DEC] buttons to select the Program Change numbers to which you want to assign Scenes.
- 5 Press the cursor button [▶] to move the cursor to a parameter box in the SCENE NO./TITLE column, then rotate the Parameter wheel or press the [INC]/[DEC] buttons to select Scenes.

Tip:

- If you assign a Scene to multiple Program Changes, the Program Change with the lowest number becomes effective.
- You can initialize the Scene to Program Change assignment table by moving the cursor to the INITIALIZE button, then pressing [ENTER].

- 6 Press the DISPLAY ACCESS [MIDI] button, then press the [F1] button to display the MIDI | Setup page, then specify the MIDI Transmit and Receive Channels.
- 7 Turn on the PROGRAM CHANGE Tx ON/OFF and Rx ON/OFF buttons.

Now, when the 01V96 receives the Program Changes on the specified MIDI Channels, the corresponding Scenes are recalled. Also, when you switch Scenes on the 01V96, the 01V96 transmits the Program Changes on the specified MIDI Channels.

Assigning Parameters to Control Changes for Real-time Control

You can assign 01V96 parameters to MIDI Control Changes for real-time control. When the 01V96 receives a Control Change, the assigned 01V96 parameter is set accordingly. Also, when you adjust a parameter on the 01V96, the 01V96 transmits the assigned Control Change message.

Tip: You can store a Parameter to Control Change assignment table to an external device by using MIDI Bulk Dump or the included Studio Manager software.

- 1 Press the DISPLAY ACCESS [DIO/SETUP] button repeatedly until the DIO/Setup | MIDI/Host page appears, then specify ports for transmission and reception of MIDI messages (see page 216).
- 2 Make connections using the ports selected in Step 1 so that the 01V96 can transfer MIDI messages to and from the external device.
- 3 Press the DISPLAY ACCESS [MIDI] button, then press the [F3] button.

The MIDI | Ctl Asgn page appears. This page enables you to assign 01V96 parameters to Control Changes.

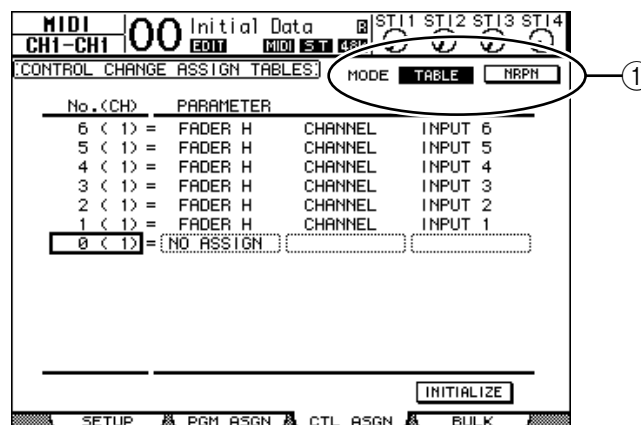

Tip: See page 290 for information on the default Parameter to Control Change assignments.

4 Move the cursor to the MODE parameter’s TABLE button (Ⓣ), then press [ENTER].

The MODE parameter determines which MIDI messages are transmitted when 01V96 parameters are adjusted. The following options are available for the MODE parameter:

- **TABLE**.....MIDI Control Change messages are transmitted in accordance with the assignments on this page.
- **NRPN**.....The assignments on the Ctl Asgn page are ignored, and pre-defined NRPNs (Non Registered Parameter Numbers) are transmitted for remote control.

Tip: NRPNs are special MIDI messages that combine three different Control Changes. They enable you to control many parameters on a single MIDI Channel.

5 If you turned on the TABLE button in Step 4, move the cursor to a parameter box in the No. (CH) column, then rotate the Parameter wheel or press the [INC]/[DEC] buttons to select the MIDI channels and Control Changes to which you want to assign parameters.

You can assign parameters to up to 16-channel Control Changes on the Ctl Asgn page, regardless of the MIDI Channels currently selected for transmission and reception.

Skip Steps 5 and 6 if you turned on the NRPN button in Step 4.

6 Select parameters in the parameter boxes in the three PARAMETER columns.

Select a parameter group in the parameter box in the first PARAMETER column, and specify the desired values in the parameter boxes in the second and third PARAMETER columns.

The following parameters and values are available:

HIGH	MID	LOW
NO ASSIGN	—	—
FADER H	CHANNEL	INPUT1–32/ST IN1–4
	MASTER	BUS1–8/AUX1–8/STEREO
	AUX1 SEND	INPUT1–32/ST IN1–4
	AUX2 SEND	
	AUX3 SEND	
	AUX4 SEND	
	AUX5 SEND	
	AUX6 SEND	
	AUX7 SEND	
	AUX8 SEND	
BUS TO ST	BUS1–8	
FADER L	CHANNEL	INPUT1–32/ST IN1–4
	MASTER	BUS1–8/AUX1–8/STEREO
	AUX1 SEND	INPUT1–32/ST IN1–4
	AUX2 SEND	
	AUX3 SEND	
	AUX4 SEND	
	AUX5 SEND	
	AUX6 SEND	
	AUX7 SEND	
	AUX8 SEND	
BUS TO ST	BUS1–8	

HIGH	MID	LOW
ON	CHANNEL	INPUT1–32/ST IN1–4
	MASTER	BUS1–8/AUX1–8/STEREO
	AUX1 SEND	INPUT1–32/ST IN1–4
	AUX2 SEND	
	AUX3 SEND	
	AUX4 SEND	
	AUX5 SEND	
	AUX6 SEND	
	AUX7 SEND	
	AUX8 SEND	
	BUS TO ST	BUS1–8
PHASE	CHANNEL	INPUT1–32/ST IN1L–4R
INSERT ON	CHANNEL	INPUT1–32
	MASTER	BUS1–8/AUX1–8/STEREO
PRE/POST	AUX1 SEND	INPUT1–32/ST IN1–4
	AUX2 SEND	
	AUX3 SEND	
	AUX4 SEND	
	AUX5 SEND	
	AUX6 SEND	
	AUX7 SEND	
	AUX8 SEND	
IN DELAY	ON	INPUT1–32
	TIME HIGH	
	TIME MID	
	TIME LOW	
	MIX HIGH	
	MIX LOW	
	FB GAIN H	
	FB GAIN L	
OUT DELAY	ON	BUS1–8/AUX1–8/STEREO L,R
	TIME HIGH	
	TIME MID	
	TIME LOW	

HIGH	MID	LOW
EQ	ON	INPUT1-32/ST IN 1-4/BUS1-8/AUX1-8/STEREO
	Q LOW	
	F LOW	
	G LOW H	
	G LOW L	
	Q LO-MID	
	F LO-MID	
	G LO-MID H	
	G LO-MID L	
	Q HI-MID	
	F HI-MID	
	G HI-MID H	
	G HI-MID L	
	Q HIGH	
	F HIGH	
	G HIGH H	
	G HIGH L	
	ATT H	
	ATT L	
	HPF ON	
LPF ON		
GATE	ON	INPUT1-32
	ATTACK	
	THRESH H	
	THRESH L	
	RANGE	
	HOLD H	
	HOLD L	
	DECAY H	
	DECAY L	
COMP	ON	INPUT1-32/BUS1-8/AUX1-8/STEREO
	ATTACK	
	THRESH H	
	THRESH L	
	RELEASE H	
	RELEASE L	
	RATIO	
	GAIN H	
	GAIN L	
	KNEE	
PAN	CHANNEL	INPUT1-32/ST IN1L-4R
	AUX1-2	
	AUX3-4	
	AUX5-6	
	AUX7-8	
BUS TO ST	BUS1-8	
BALANCE	MASTER	STEREO

HIGH	MID	LOW
SURROUND	LFE H	INPUT1-32/ST IN1L-4R
	LFE L	
	DIV (F)	
	DIV R	
	LR	
	FR	
	WIDTH	
	DEPTH	
	OFS LR	
	OFS FR	
	EFFECT	
MIX		
PARAM1 H		
PARAM1 L		
:		
PARAM32 H		
PARAM32 L		

Parameters that feature a setting range of more than 128 steps (such as Fader and Delay Time parameters) require two or more Control Change messages to specify the values. For example, if you wish to control Fader parameters on certain channels using Control Changes, you must assign the same channel to two Control Change numbers, and select “FADER H” and “FADER L” for the Control Changes in the parameter boxes in the first PARAMETER column.

```

3 ( 1 ) = FADER H      CHANNEL      INPUT 3
2 ( 1 ) = FADER L      CHANNEL      INPUT 1
1 ( 1 ) = FADER H      CHANNEL      INPUT 1
0 ( 1 ) = NO ASSIGN
    
```

If you wish to control Delay Time parameters on certain channels using Control Changes, you must assign the same channel Delay parameter to three Control Change numbers, and select “TIME LOW,” “TIME MID,” and “TIME HIGH” for the Control Changes in the parameter boxes in the second (middle) PARAMETER column.

```

01 ( 2 ) = NO ASSIGN
60 ( 2 ) = IN DELAY    TIME HIGH    INPUT 1
59 ( 2 ) = IN DELAY    TIME MID     INPUT 1
58 ( 2 ) = IN DELAY    TIME LOW     INPUT 1
57 ( 2 ) = NO ASSIGN
    
```

Note: Parameters that feature a setting range in excess of 128 steps require an appropriate combination of range parameters for successful MIDI Control Change.

Tip: You can initialize the Parameter to Control Change assignment table by moving the cursor to the INITIALIZE button, then pressing [ENTER].

7 Press the DISPLAY ACCESS [MIDI] button, then press the [F1] button to display the MIDI | Setup page, then specify MIDI Transmit and Receive Channels.

8 Turn on the CONTROL CHANGE Tx ON/OFF and Rx ON/OFF buttons.

01V96 parameters will now be set accordingly when the 01V96 receives corresponding Control Changes. Also, when you adjust parameters on the 01V96, the 01V96 will transmit corresponding Control Changes.

Note: Before controlling parameters using Control Changes, make sure that both Tx and Rx ON/OFF buttons in the PARAMETER CHANGE row on the MIDI | Setup page are turned off.

Controlling Parameters by Using Parameter Changes

You can control 01V96 parameters in real time by using Parameter Change messages that are System Exclusive messages, instead of using MIDI Control Changes.

See “MIDI Data Format” at the end of this Manual for detailed information on available Parameter Changes.

- 1 Press the **DISPLAY ACCESS [DIO/SETUP]** button repeatedly until the **DIO/Setup | MIDI/Host** page appears, then specify ports for transmission and reception of MIDI messages (see page 216).
- 2 Make connections using the ports selected in Step 1 so that the 01V96 can transmit and receive MIDI messages to and from the external device.
- 3 Press the **DISPLAY ACCESS [MIDI]** button, then press the **[F1]** button to display the **MIDI | Setup** page, then turn off the **Tx** and **Rx ON/OFF** buttons in the **PARAMETER CHANGE** row.

The 01V96 will now set certain parameter values when it receives corresponding Parameter Changes. Also, when you adjust certain parameters on the 01V96, it transmits corresponding Parameter Changes.

Note: Before controlling parameters using Parameter Changes, make sure that both **Tx** and **Rx ON/OFF** buttons in the **CONTROL CHANGE** row are turned off.

Transmitting Parameter Settings via MIDI (Bulk Dump)

You can back up data stored in the 01V96, such as libraries and Scenes, to an external MIDI device by using MIDI Bulk Dump. In this way, you can later restore previous 01V96 settings by transmitting this MIDI data back to the 01V96.

Note: Some of the data transmitted from the 01V96 to the sequence software may occasionally drop out during Bulk Dump transmission. To avoid this, we recommend that you use the included Studio Manager software to store 01V96 data to an external device.

- 1 Press the DISPLAY ACCESS [DIO/SETUP] button repeatedly until the DIO/Setup | MIDI/Host page appears, then specify ports for transmission and reception of MIDI messages (see page 216).
- 2 Make connections using the ports selected in Step 1 so that the 01V96 can transmit and receive MIDI messages to and from the external device.
- 3 Press the DISPLAY ACCESS [MIDI] button, then press the [F4] button.

The MIDI | Bulk page appears.

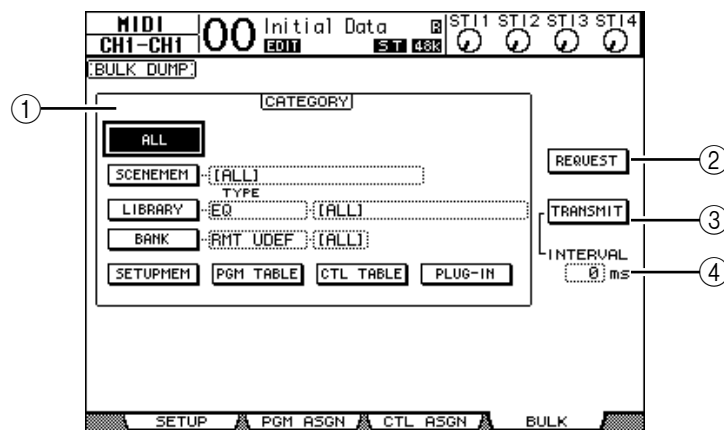

The page includes the following parameters:

- ① **CATEGORY section**
This section enables you to select data for transmission and reception.
 - ② **REQUEST**
Move the cursor to this button, then press [ENTER] to transmit messages from the 01V96 that request a second 01V96 (connected to the first 01V96) to transmit the data specified in the CATEGORY section. This button is used primarily when two 01V96s are connected in cascade.
 - ③ **TRANSMIT**
Move the cursor to this button, then press [ENTER] to transmit data specified in the CATEGORY section to an external MIDI device.
 - ④ **INTERVAL**
This parameter specifies the interval between data packets during bulk transmission in 50 millisecond steps. If the external device drops part of the bulk data, increase this parameter value.
- 4 In the CATEGORY section, move the cursor to the button of the data type you want to transmit, then press [ENTER].

The following options are available:

- **ALL**..... This button selects all data available for bulk dump. When this button is turned on, all other buttons in this section are turned off.
- **SCENEMEM** This button selects Scene memories. You can select Scenes you wish to transmit in the parameter box next to the button.
- **LIBRARY** This button selects libraries. You can select the type of library in the TYPE parameter box (next to the button), then specify the library number in the parameter box on the right.
- **BANK**..... This parameter enables you to select the User Defined Key banks (KEYS UDEF), User Defined Remote Layer banks (RMT UDEF), or User Assignable Layer banks (USR LAYER) for bulk dump. You can select one of these three types in the parameter box next to the button, and select the banks in the parameter box on the right.
- **SETUPMEM** This button selects the 01V96 setup data (i.e., system settings).
- **PGM TABLE** This button selects the MIDI | Pgm Asgn page settings.
- **CTL TABLE**..... This button selects the MIDI | Ctl Asgn page settings.
- **PLUG-IN** This button selects the settings of an optional Y56K card installed in the slot. You can select Y56K card programs in the parameter box next to the button..

Note: Data selected by the **SETUPMEM** button includes MIDI transmission and reception port settings and message settings. After you store to an external device bulk dump data that has its reception disabled, if the 01V96 later starts to receive this particular data, 01V96 bulk dump reception will be turned off immediately, and the 01V96 will be unable to receive subsequent data. Therefore, before you store the data selected by the **SETUPMEM** button using Bulk Dump, be sure to enable bulk data transmission and reception.

- 5** If necessary, move the cursor to the parameter box next to the selected button, then rotate the Parameter wheel or press the [INC]/[DEC] buttons to select the desired bulk dump data.

Tip: If you selected [ALL] in the parameter box, all data selected by the corresponding button is transmitted as bulk dump data.

- 6** To start transmitting bulk data, move the cursor to the **TRANSMIT** button, then press [ENTER].

Bulk Dump is executed. During the operation, the Bulk Dump window appears, indicating the current bulk dump status. To abort the bulk dump operation, move the cursor to the **CANCEL** button in the window, then press [ENTER].

Tip: To transmit bulk dump request messages, move the cursor to the **REQUEST** button, then press [ENTER]. If you set up the 01V96 so that it will transmit and receive MIDI messages to and from another 01V96, the other 01V96 will respond to the bulk dump request and transmit the bulk dump data to the 01V96 you are operating.

- 7** To receive bulk data, press the **DISPLAY ACCESS [MIDI]** button again to display the MIDI | Setup page, then turn on the **Rx ON/OFF** button in the **BULK** row.

Now, when the 01V96 receives bulk data, the corresponding internal data is updated.

19 Other Functions

This chapter describes the 01V96's miscellaneous functions.

Changing the Input and Output Channel Names

You can change the default name of the input channels (Input Channels 1–32, ST IN Channels 1–4) and output channels (Aux Outs 1–8, Bus Outs 1–8, Stereo Out), if you desire.

Changing the Input Channel Names

- 1 Press the DISPLAY ACCESS [PATCH] button repeatedly until the Patch| In Name page appears.

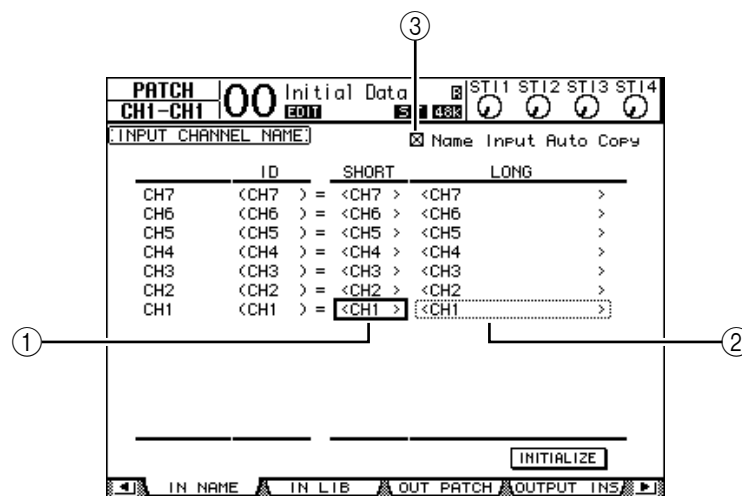

Channel IDs, Short names, and Long names are listed from left to right on the page. You can specify Short names in the parameter boxes (①) in the center column, and Long names in the parameter boxes (②) in the right column.

- 2 Move the cursor to the desired parameter box, then use the Parameter wheel or the [INC]/[DEC] buttons to select a port for which you want to change the name.
- 3 Press [ENTER].

The Title Edit window appears, which enables you to edit the name.

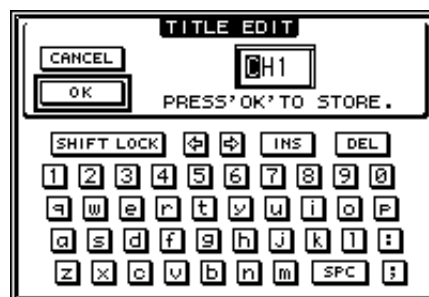

- 4 Edit the name, move the cursor to the OK button, then press [ENTER].

The new name is now effective.

Tip: The edited name is stored in the Input Patch library.

When the Name Input Auto Copy check box (③) is on, the first four characters of a newly-entered Long name are automatically copied to the Short name. On the other hand, a newly-entered Short name is automatically added to the beginning of the Long name.

You can reset all port names to their default names by moving the cursor to the INITIALIZE button, then pressing [ENTER].

Changing the Output Channel Names

To change output channel names, press the DISPLAY ACCESS [PATCH] button repeatedly until the Patch| Out Name page appears.

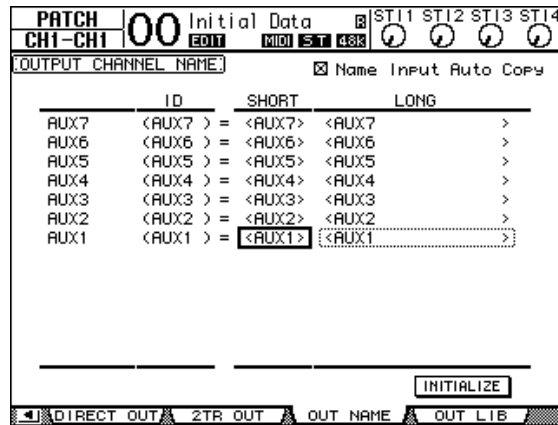

The procedure for editing the names and using the Name Input Auto Copy check box and the INITIALIZE button is the same as on the In Name page.

Setting Preferences

You can change the default settings and environmental settings of the 01V96 by using the DIO/Setup | Prefer1 and Prefer2 pages. To locate one of the Preferences page, press the DISPLAY ACCESS [DIO/SETUP] button repeatedly.

Prefer1 page

This page enables you to set the 01V96 so that when you press a button on the top panel, the 01V96 displays the corresponding display page, and shows or hides confirmation and alarm messages.

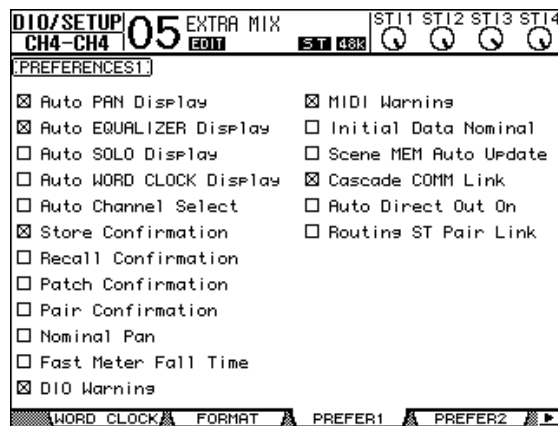

This page contains the following parameters. (These parameters are explained in the order from the top of the left column to the bottom of the right column.)

- **Auto PAN Display**
If this check box is on, the Pan/Route pages appear automatically when you operate the [PAN] control in the SELECTED CHANNEL section. In Stereo Surround mode, operating the [PAN] control enables you to adjust the left and right Pan setting. Otherwise, it enables you to adjust the Surround Pan settings.
- **Auto EQUALIZER Display**
If this check box is on, the EQ | EQ Edit page appears automatically when you press an EQ-related button in the SELECTED CHANNEL section.
- **Auto SOLO Display**
If this check box is on, the DIO/Setup | Monitor page appears automatically when you solo an Input Channel.
- **Auto WORD CLOCK Display**
If this check box is on, the DIO/Setup | Word Clock page appears automatically if the currently-selected external wordclock source fails.
- **Auto Channel Select**
If this check box is on, you can select a channel by moving the corresponding fader, or by turning on the corresponding channel [SOLO] or [ON] button.
- **Store Confirmation**
If this check box is on, the Title Edit window to input a Scene or library memory name appears when you store a Scene or library memory.
- **Recall Confirmation**
If this check box is on, a confirmation window appears when you recall a Scene or library memory.
- **Patch Confirmation**
If this check box is on, a confirmation message appears when you edit the Input and Output Patches.
- **Pair Confirmation**
If this check box is on, a confirmation message appears when you create or cancel a pair.
- **Nominal Pan**
If this check box is checked, and when Input Channel signals are panned hard left or hard right, the signals on the left/odd channels and right/even channels will be at the nominal level. If this check box is not checked, these signals will be boosted by 3 dB. (When the signals are panned to center, they will be at the nominal level.) In Surround mode, the same thing applies when any Surround pan channel is panned hard left or right.
- **Fast Meter Fall Time**
If this check box is on, the level meters fall more quickly.
- **DIO Warning**
If this check box is on, a warning message appears when any errors are detected in digital audio signals received at the Slot or 2TR Digital Inputs.
- **MIDI Warning**
If this check box is on, a warning message appears when any errors are detected in the incoming MIDI messages.

- **Initial Data Nominal**
If this check box is on, Input Channel faders and ST IN Channel level controls are set to nominal (0 dB) when you recall Scene #0. (If this check box is off, they are set to $-\infty$.)
- **Scene MEM Auto Update**
If this check box is on, you can use the Scene Memory Auto Update function (see page 169).
- **Cascade COMM Link**
If this check box is on, various functions and parameters are linked between cascaded 01V96s (See page 238 for more information on cascade connection). When the check box is off, only the Solo function is linked.
- **Auto Direct Out On**
If this check box is on and you change the channel Direct Out destination from “–” to any other output, the channel Direct Out is automatically enabled. If you change the channel Direct Out destination from an output to “–,” the channel Direct Out is automatically disabled.
- **Routing ST Pair Link**
When this check box is checked, paired channels’ routing to the Stereo Bus will be linked.

Prefer2 page

The Prefer2 page enables you to name the channel indicated on the display, and adjust the display brightness.

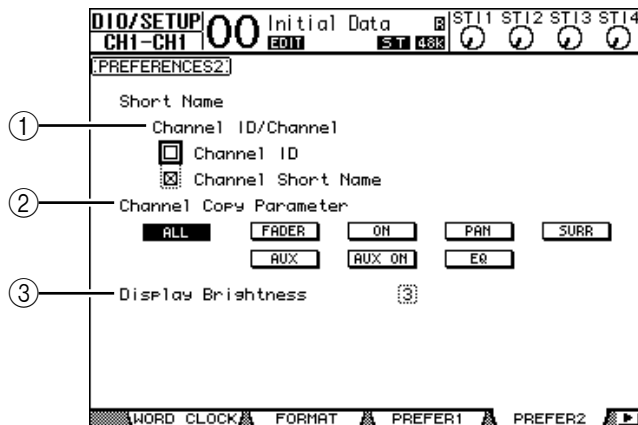

This page contains the following parameters:

- ① **Channel ID/Channel**
This parameter selects a style for the displayed channel. If the Channel ID check box is selected, the Channel ID appears (e.g., CH1, CH16, AUX1). If the Channel Short Name check box is on, the Channel Short name appears (see page 229).
- ② **Channel Copy Parameter**
This parameter selects the channel parameters to be copied when you assign the Channel Copy function to one of the User Defined buttons (see page 235). You can select multiple options.
 - **ALL** This button selects all parameters that can be copied. When you turn on this button, all other options are cancelled.
 - **FADER**..... Copies the fader values.
 - **ON**..... Copies the on/off status of the [ON] buttons.
 - **PAN**..... Copies the pan settings.

- SURRCopies the surround pan settings.
- AUX.....Copies the Aux Send levels.
- AUX ONCopies the on/off status of the Channel to Aux signals.
- EQ.....Copies the EQ parameter values.

③ **Display Brightness**

This parameter sets the brightness of the LED indicators in the range of 1 through 4.

Creating a Custom Layer by Combining Channels (User Assignable Layer)

If you set the Remote Layer target to “USER ASSIGNABLE,” you can create a custom layer by combining any 01V96 channels (excluding the Stereo Out). This custom layer is called “User Assignable layer.”

- 1 Press the **DISPLAY ACCESS [DIO/SETUP]** button repeatedly until the **DIO/Setup| Remote** page appears.
- 2 Set the **TARGET** parameter to **USER ASSIGNABLE**, then press **[ENTER]**.
A confirmation window appears.
- 3 Move the cursor to the **YES** button, then press **[ENTER]**.

The 01V96 displays the page shown below.

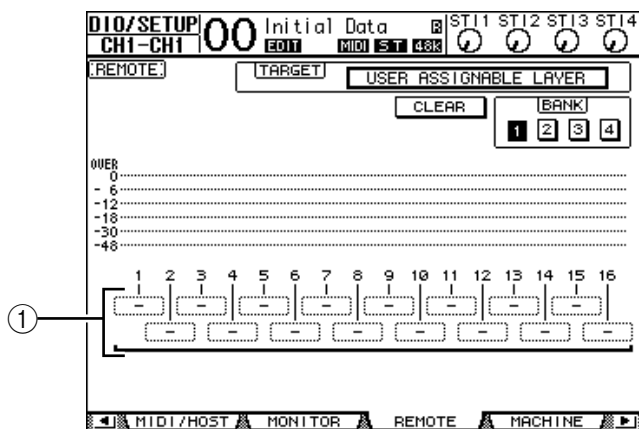

- 4 Select the channels you wish to assign to the User Assignable layer using the 1–16 parameter boxes (①).

You can store up to four 16-channel setups in four banks by switching Banks 1–4 via the BANK 1–4 buttons. If you press **[ENTER]** before selecting the channels to assign, you will still be able to select the channels you wish to assign in the User CH Select window.

Tip: You can reset the assignment to default by moving the cursor to the **CLEAR** button and pressing **[ENTER]**.

- 5 Use the **LAYER [REMOTE]** button to assign or recall the User Assignable layer. You can use the faders and **[ON]** buttons to control the assigned channels.

Using the Oscillator

The 01V96 features an Oscillator you can use for sound checks. Follow the steps below to use the Oscillator:

- 1 Press the **DISPLAY ACCESS [UTILITY]** button repeatedly until the **Utility | Oscillator** page appears.

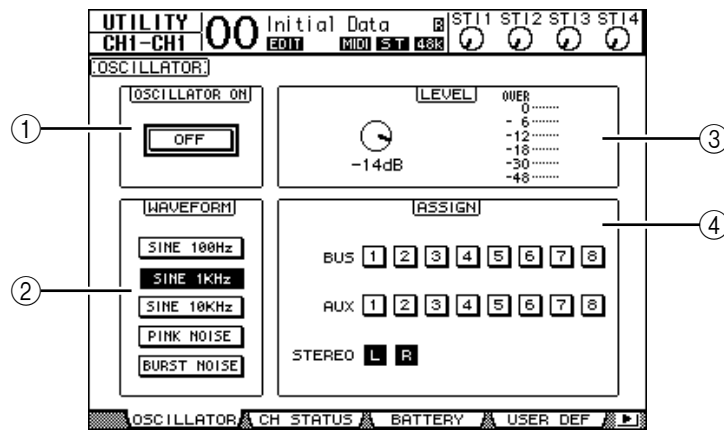

This page contains the following parameters:

- ① **OSCILLATOR ON**
This parameter button turns the Oscillator on or off.
- ② **WAVEFORM**
These parameter buttons select the Oscillator waveforms.
- ③ **LEVEL section**
The parameter control in this section sets the Oscillator output level.
- ④ **ASSIGN section**
The buttons in this section select the Oscillator output.

- 2 Move the cursor to the button for the Oscillator output channel in the **ASSIGN** section, then press **[ENTER]** (you can select multiple channels).
- 3 Move the cursor to one of the **WAVEFORM** parameter buttons, then press **[ENTER]**.

You can select the following waveforms:

- **SINE 100Hz** 100 Hz sinewave
- **SINE 1kHz** 1 kHz sinewave
- **SINE 10kHz** 10 kHz sinewave
- **PINK NOISE** Pink noise
- **BURST NOISE** Burst noise (200 msec pink noise pulses at four second intervals)

- 4 Move the cursor to the parameter control in the **LEVEL** section, then rotate the Parameter wheel to set the Oscillator level to minimum.

Note: Sinewave and pink noise create unusually high sound pressure. Oscillator levels that are too high can damage the speakers. When you use the Oscillator, be sure to set the level to minimum, then raise the level gradually.

- 5 Move the cursor to the **OSCILLATOR ON/OFF** button, then press the **[ENTER]** or **[INC]/[DEC]** buttons to turn on the Oscillator.

The Oscillator signal is now routed to the channels selected in the **ASSIGN** section.

- 6 Move the cursor to the parameter control in the LEVEL section, then rotate the Parameter wheel to raise the Oscillator level.

You can view the current Oscillator level on the LEVEL meter.

Using the User Defined Keys

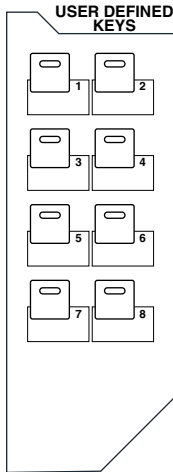

You can assign any of more than 160 functions to the USER DEFINED KEYS [1]–[8] buttons.

If you assign to one of the buttons (or “keys”) a function that is usually executed on the display pages, you can use the assigned button as a shortcut.

The Function to User Defined Keys assignments are stored in banks. Each bank accommodates an assignment of all eight buttons. (See page 249 for more information on the initial bank settings.) The 01V96 provides eight banks (Banks A–H). Switching banks enables you to change the assignment quickly.

Follow the steps below to assign functions to the USER DEFINED KEYS.

- 1 Press the USER ACCESS [UTILITY] button to locate the Utility | User Def page.

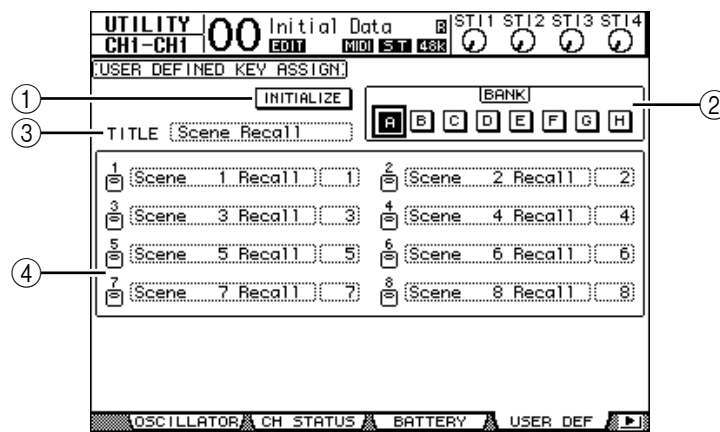

This page contains the following parameters:

- ① **INITIALIZE**
This button resets the contents of all banks to their initial settings.
- ② **BANK**
These buttons select the desired banks.
- ③ **TITLE**
This parameter displays the name of the bank selected by the BANK parameter button. Move the cursor to the TITLE parameter box, then press [ENTER]. The Title Edit window appears, enabling you to enter a name.
- ④ **1–8**
These parameter boxes enable you to assign functions to USER DEFINED KEYS [1]–[8].

- 2 Move the cursor to the desired BANK parameter button, then press [ENTER].

The corresponding bank is selected, and the functions assigned to the User Defined buttons in that bank are displayed in the 1–12 parameter boxes.

Tip: When you select a function that is executed based on specified numbers (for example, a function that recalls a specific Scene or library memory or transmits MIDI messages), an extra parameter box appears on the right, in which you must specify the number.

3 Move the cursor to one of the 1–8 parameter boxes, then press [ENTER].

The 01V96 displays the User Define Select window, which enables you to assign functions to the selected buttons.

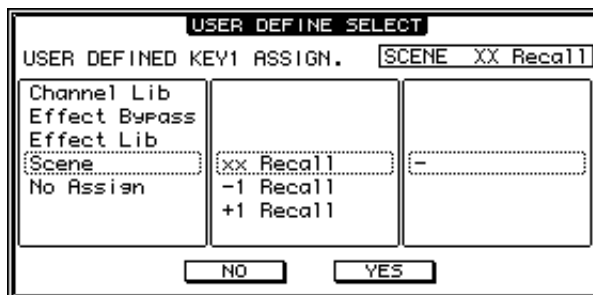
**4 Move the cursor to the left column, then rotate the Parameter wheel or press the [INC]/[DEC] buttons to select a function you wish to assign.**

A function is selected when it appears inside the dotted box. See page 247 for a complete list of assignable functions.

5 In the same way, set the center and right column.

The items that appear in the center and right columns vary depending on the function selected in Step 4.

6 To close the window, move the cursor to the YES button, then press [ENTER].

When the window closes, the specified function is assigned to the selected User Defined button.

To cancel the assignment, move the cursor to the CANCEL button, then press [ENTER].

7 If you assigned functions that require numbers (such as recalling a Scene or library memory), move the cursor to the extra parameter box shown on the right and specify the number.**Tip:**

- You can store User Defined Keys banks to a computer hard disk using the included Studio Manager software. Be sure to back up important data.
- You can also store the assignment data to an external device, such as a MIDI data filer, by using MIDI Bulk Dump (see page 226).

Using Operation Lock

The 01V96 features an Operation Lock function that prevents unintentional edits and restricts access to panel operation with a password.

To use the Operation Lock function, press the [UTILITY] button repeatedly to display the Utility | Lock page.

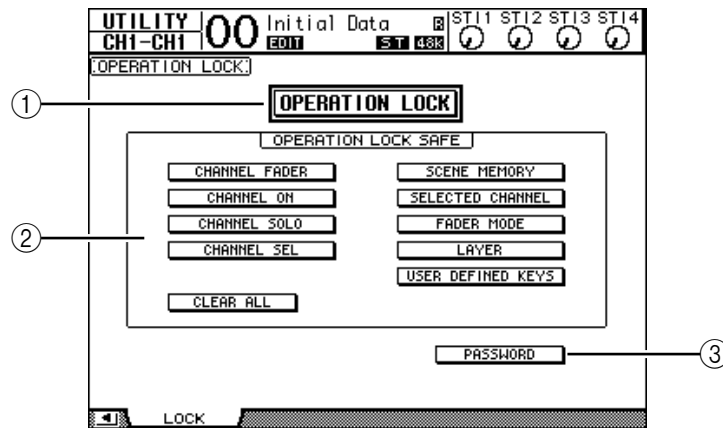

This page contains the following parameters:

① OPERATION LOCK

This button enables or cancels Operation Lock. When you turn on this button, the Password window appears.



Enter a four-letter password using the Channel 1–10 [SEL] buttons (Channel 10 [SEL] button enters “0”). (The password characters are represented by asterisks.) Move the cursor to the OK button, then press [ENTER] to enable Operation Lock. The factory default password is “1234.”

To cancel Operation Lock, press [ENTER]. The Password window appears again. Enter the password and select the OK button. Operation Lock is cancelled.

Note: If you forget the password, you cannot cancel Operation Lock. Be sure to write down the password.

② OPERATION LOCK SAFE section

This section enables you to select certain controls on the panel to exclude from Operation Lock. To cancel all “safe” buttons simultaneously, move the cursor to the CLEAR ALL button, then press [ENTER].

③ **PASSWORD**

This button enables you to change the current password. Move the cursor to the PASSWORD button, then press [ENTER]. The Set Password window appears, enabling you to change the password.

Enter the current password in the PASSWORD field, and a new password in the NEW PASSWORD field. The factory default password is “1234.” Enter the new password again in the REENTRY field located below the NEW PASSWORD field. Move the cursor to the OK button, then press [ENTER] to change the password.

Tip: To clear the registered password, move the cursor to the CLEAR button, then press [ENTER]. If you forget the password, initialize the password setting (see page 243).

Cascading Consoles

The 01V96 features a Cascade Bus that enables cascade connection. You can connect two 01V96s in cascade using the digital inputs and outputs, or the OMNI IN and OMNI OUT connectors. In this way, two consoles work just like one big console, integrating each unit’s Buses 1–8, Aux Sends 1–8, Stereo Bus, and Solo Bus.

The following functions are linked between two cascaded 01V96s via the MIDI IN and OUT ports.

- Display page selection
- Aux selection
- Solo function
- Fader Mode
- Metering Position
- Peak Hold On/Off
- Meter Fast Fall on/off
- Scene Store, Recall, and Title Edit

Tip:

- To link functions and parameters (excluding the Solo function), turn on the Cascade COMM Link check box on the Setup | Prefer1 page (see page 230).
- The Solo function is always linked regardless of the status of the Cascade COMM Link check box.
- The Fader Mode will not be linked if the Master layer is selected.

The following paragraphs explain how to make a cascade connection using two 01V96s and the inputs and outputs of the digital I/O card installed in the slot of each 01V96.

1 Install digital I/O cards into the slot on each of two 01V96s.

2 Connect two 01V96s as follows:

- Connect the digital I/O card output on the transmitting 01V96 (slave) to the digital I/O card input on the receiving 01V96 (master).
- Connect the ADAT IN connector on the master unit to the ADAT OUT connector on the slave unit.
- Connect the MIDI IN port on the master unit to the MIDI OUT port on the slave unit using a MIDI cable.
- Connect the MIDI OUT port on the master unit to the MIDI IN port on the slave unit using a MIDI cable.

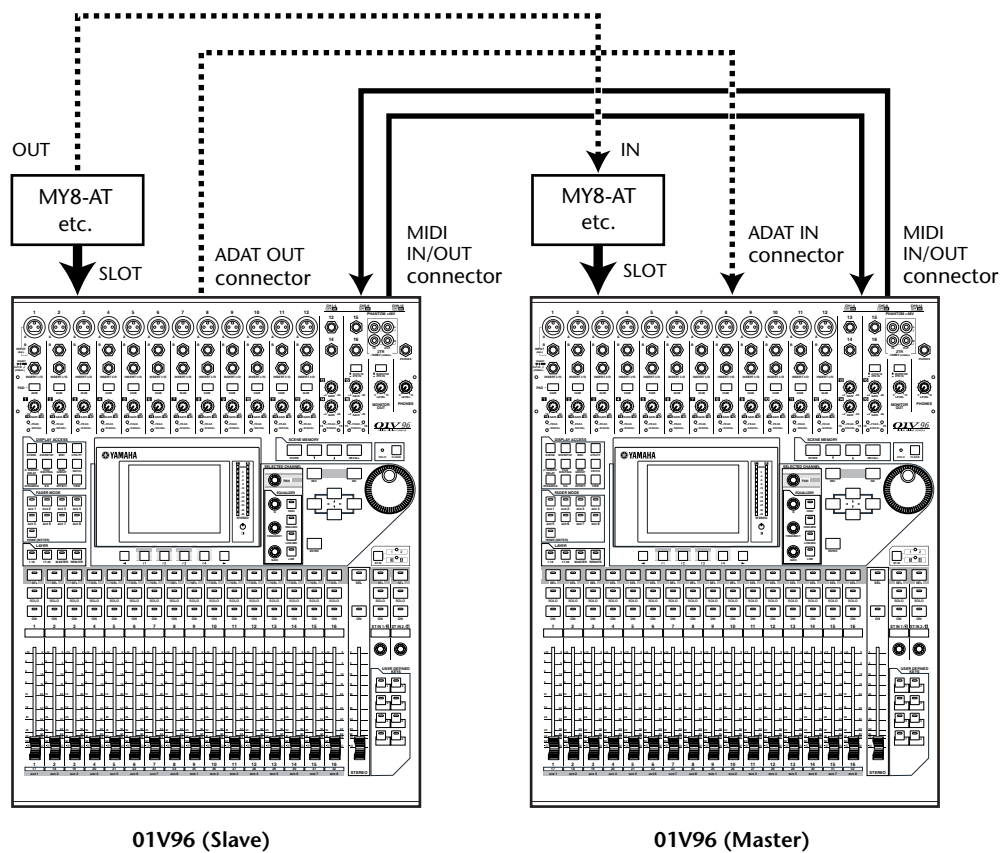

3 On the slave unit, press the DISPLAY ACCESS [PATCH] button repeatedly until the Patch | Out Patch page appears.

4 Assign the Bus signals to the channels that are used for the cascade connection.

The following signals are available:

Options	Description
CAS BUS1–BUS8	Bus 1–8 Cascade Outs
CAS AUX1–AUX8	Aux Bus 1–8 Cascade Outs
CAS ST-L, CAS ST-R	Stereo Bus L & R Cascade Outs
CASSOLOL, CASSOLOR	Solo Bus L & R Cascade Outs

The following display page is an example of integrating Bus 1–8, Aux Send 1–4, Stereo Bus, and Solo Bus signals via the ADAT IN and OUT connectors and two 8-channel digital I/O cards (such as MY8-AT).

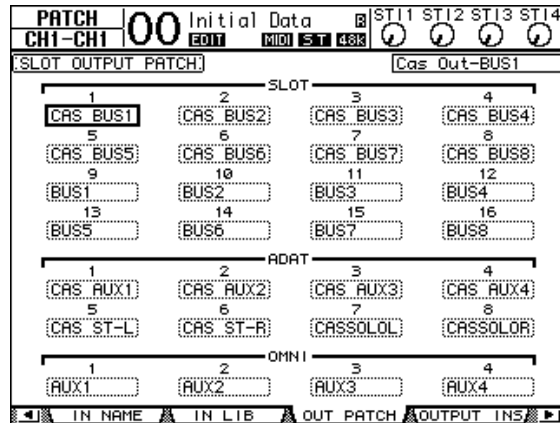

Tip: Patching may vary depending on the type and number of buses used for the cascade connection.

Note: Since the number of channels available on the digital I/O card is limited, only Aux Sends 1–4 are cascaded in this example. Using a 16-channel digital I/O card (such as MY16-AT) enables you to cascade all buses.

- 5 On the master unit, press the DISPLAY ACCESS [PATCH] button repeatedly until the Patch | Cascade In page appears.
- 6 Select the Input Channels on the master unit to which the Bus signals are input from the Slave unit.

The following display page is an example of receiving the slave unit’s Bus 1–8, Aux Send 1–4, Stereo Bus, and Solo Bus signals via the ADAT IN and OUT connectors and two 8-channel digital I/O cards (such as MY8-AT).

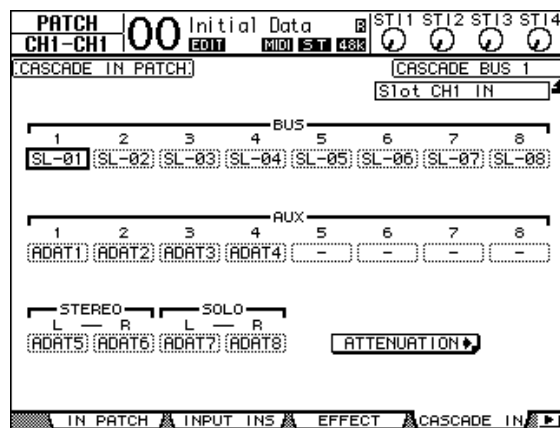

Note: Be sure to patch the slave Bus signals to the same Buses on the master unit. Incorrect patching will result in an incorrect cascade connection.

- 7 On the master unit, press the DISPLAY ACCESS [DIO/SETUP] button repeatedly until the DIO/Setup | Cascade page appears, then adjust the Attenuators using the parameter controls.

The DIO/Setup | Cascade page enables you to adjust the level of signals input to the Cascade Bus using the dedicated attenuators. You can also turn the Cascade Buses on or off using the buttons below the parameter controls.

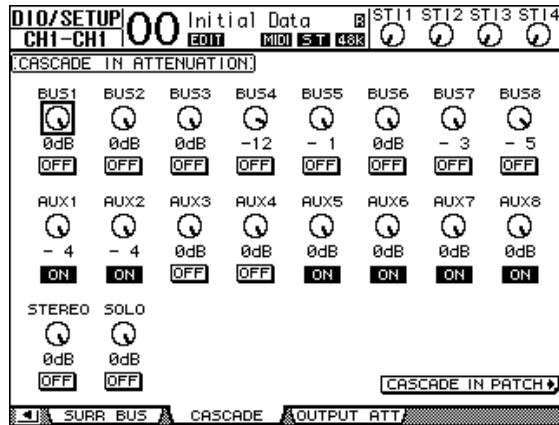

- 8 Press the DISPLAY ACCESS [DIO/SETUP] button repeatedly to display the DIO/Setup | MIDI/Host page, then set the Cascade Link parameter to "MIDI."

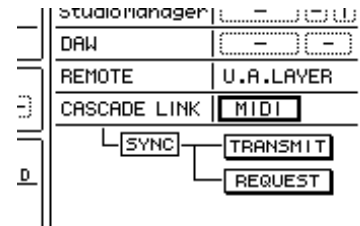

- 9 Repeat Step 8 for the master unit.

After Steps 8 and 9, the slave unit will be able to transmit and receive MIDI messages.

- 10 To match the parameters of both 01V96s, locate the DIO/Setup | MIDI/Host page on the copy source unit. Move the cursor to the TRANSMIT button for the SYNC parameter, then press [ENTER].

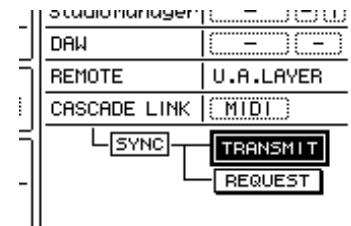

Parameters for cascade link (page 238) will be copied to the other 01V96 via the REMOTE connector. If you select the REQUEST button instead of the TRANSMIT button for the SYNC parameter, you can reverse the copy direction.

At this point, Bus 1–8, Aux 1–4, and the Stereo Bus on both 01V96s are integrated, and the data is output via Bus Outs 1–8, Aux Outs 1–4, and the Stereo Out on the master unit. If you solo channels on one of the 01V96s, you can monitor the soloed signals via the Monitor outputs.

Checking the Battery and the System Version

The Utility | Battery page enables you to check the condition of the internal memory-backup battery and the system version number. To locate this page, press the DISPLAY ACCESS [UTILITY] button repeatedly.

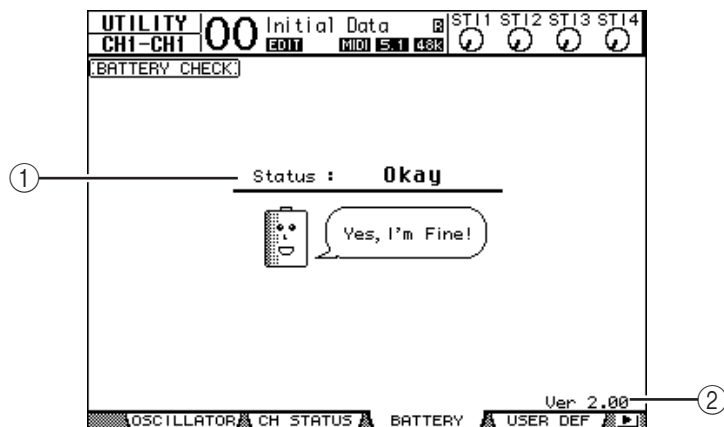

① Status

If the Status is “Okay,” the battery has sufficient voltage for operation. If the Status is “Voltage Low!,” ask your Yamaha dealer or authorized Yamaha service center to replace the battery as soon as possible. Failure to replace a low battery may result in data loss.

Note: Do not attempt to replace the battery yourself as a malfunction may occur.

② Ver X.XX (X.XX represents the version number.)

This indicator identifies the system version number. Check the current system version number before you update the firmware.

Visit the following website to check the latest system version number:
<http://www.yamahaproaudio.com/>

Initializing the 01V96

You can delete all currently-recorded settings and restore the factory-preset values, and reset the Operation Lock password to its initial setting. Follow the steps below.

Note:

- If you initialize the 01V96 to the factory-preset values, all Scene, library and other data you stored previously will be erased. Proceed with caution.
- If you want to keep the current internal data, be sure to first back up the data using the included Studio Manager software.

Tip:

- You can also store the data to an external MIDI device, such as a MIDI data filer, by using MIDI Bulk Dump (see page 226).

- 1 Make sure that the power to the 01V96 is turned off.**
- 2 While holding down the SCENE MEMORY [STORE] button, turn on the POWER ON/OFF switch.**

After a moment, the 01V96 displays the following confirmation window.

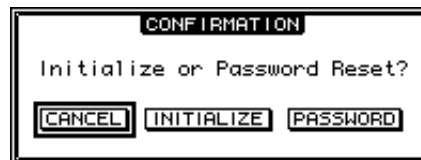

- 3 To reset the 01V96 to factory default settings, move the cursor to the INITIALIZE button, then press [ENTER].**

To cancel the initialization operation, move the cursor to the CANCEL button, then press [ENTER].

When the internal data is thoroughly overwritten, the 01V96 restarts using the factory settings.

- 4 To reset the Operation Lock password to its initial setting, in Step 2, move the cursor to the PASSWORD button, then press [ENTER].**

The password is reset to “1234”.

If you do not take any action after the confirmation window appears, the window automatically closes and the 01V96 restarts without being initialized.

Calibrating the Faders

The 01V96 motorized fader positions may shift over time depending on the operating conditions and environment. You can correct the shifted faders using the Calibration function.

- 1 **Make sure that the power to the 01V96 is turned off.**
- 2 **Press and hold down the [ENTER] button, then turn on the POWER ON/OFF switch.**

After a while, the following calibration window appears.

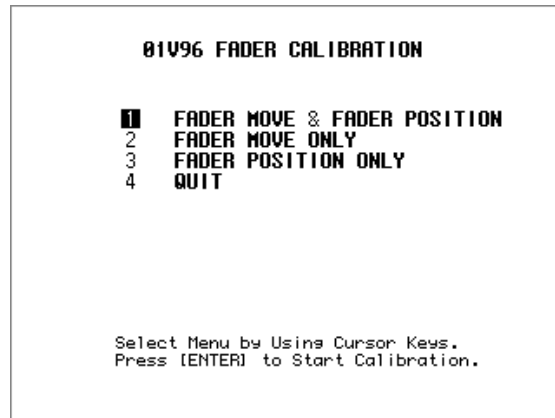

- 3 **Make sure that “1 FADER MOVE & FADER POSITION” is selected, then press [ENTER].**

To adjust only the motor fader movement, use the cursor buttons to select “2 FADER MOVE ONLY,” then press [ENTER].

To adjust only the fader position, use the cursor buttons to select “3 FADER POSITION ONLY,” then press [ENTER]. Proceed to Step 5.

To cancel the calibration operation, use the cursor buttons to select “4 QUIT,” then press [ENTER]. The 01V96 starts in normal mode.

- 4 **The calibration operation begins, adjusting the motor fader movement, and the 01V96 displays a message that indicates the calibration operation is in progress.**

The calibration operation takes about two minutes. DO NOT touch the faders during the operation.

- 5 When the calibration operation is complete, the 01V96 displays a window in which you can select faders for position adjustment.**

If you selected “2 FADER MOVE ONLY” in Step 3, the fader adjustment is complete. The 01V96 starts in normal mode.

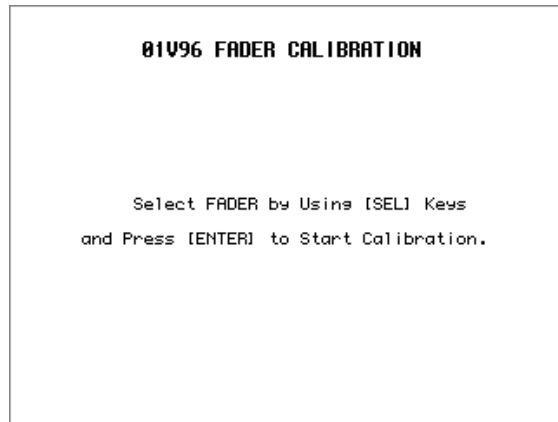

- 6 Use the channel [SEL] buttons to select faders for which you wish to calibrate the position, then press [ENTER].**

The selected channel [SEL] button indicators flash. (When you press [ENTER], they light up steadily.) At the beginning, all [SEL] buttons are flashing. However, if an error occurs and the unit is trying calibration again, only the [SEL] button indicator of a problematic fader flashes.

- 7 Follow the instruction in the window to set the position of the selected faders to $-\infty$, then press [ENTER].**
- 8 Set the position of the selected faders to the level instructed in the window, then press [ENTER]. Set faders 1-16 to -15 , and Stereo fader to -30 .**
- 9 Set the position of the selected faders to the level instructed in the window, then press [ENTER]. Set faders 1-16 to 0 , and Stereo fader to any position.**
- 10 Set the position of the selected faders to the level instructed in the window, then press [ENTER]. Set faders 1-16 to $+10$, and Stereo fader to 0 .**

If there is no problem with the calibration result, this concludes the calibration operation. The 01V96 will start in normal mode.

11 If there is any problem with the calibration result, the 01V96 displays the following window.

Also, the channel [SEL] button indicator of a problematic fader flashes.

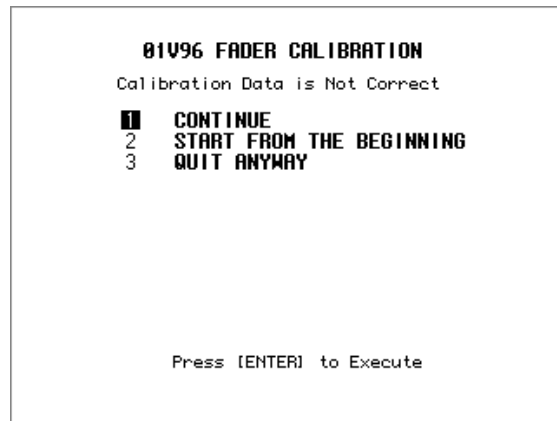

Use the cursor buttons to select one of the following three options, then press[ENTER].

- **CONTINUE**.....While the [SEL] button indicator of a problematic fader is flashing, the calibration process returns to Step 5.
- **START FROM THE BEGINNING**The calibration process returns to Step 2.
- **QUIT ANYWAY**The 01V96 cancels the calibration operation and starts in normal mode. The standard setting will be applied to problematic faders.

If this window appears after you try the calibration process several times, consult your nearest Yamaha dealer.

If the calibration data has some problems, the 01V96 displays the following window when it starts up. In this case, calibrate the position of the faders specified in the window.



Appendix A: Parameter Lists

USER DEFINED KEYS

#	Function	Display
0	No Assign	No Assign
1	Scene MEM. Recall +1	Scene +1 Recall
2	Scene MEM. Recall -1	Scene -1 Recall
3	Scene MEM. Recall No. XX	Scene XX Recall
4	Effect-1 Lib. Recall +1	Fx1 Lib+1 Recall
5	Effect-1 Lib. Recall -1	Fx1 Lib-1 Recall
6	Effect-1 Lib. Recall No.XX	Fx1 LibXXX RCL.
7	Effect-2 Lib. Recall +1	Fx2 Lib+1 Recall
8	Effect-2 Lib. Recall -1	Fx2 Lib-1 Recall
9	Effect-2 Lib. Recall No.XX	Fx2 LibXXX RCL.
10	Effect-3 Lib. Recall +1	Fx3 Lib+1 Recall
11	Effect-3 Lib. Recall -1	Fx3 Lib-1 Recall
12	Effect-3 Lib. Recall No.XX	Fx3 LibXXX RCL.
13	Effect-4 Lib. Recall +1	Fx4 Lib+1 Recall
14	Effect-4 Lib. Recall -1	Fx4 Lib-1 Recall
15	Effect-4 Lib. Recall No.XX	Fx4 LibXXX RCL.
16	Effect-1 Bypass On/Off	Fx1 Bypass
17	Effect-2 Bypass On/Off	Fx2 Bypass
18	Effect-3 Bypass On/Off	Fx3 Bypass
19	Effect-4 Bypass On/Off	Fx4 Bypass
20	Channel Lib. Recall +1	CH Lib+1 Recall
21	Channel Lib. Recall -1	CH Lib-1 Recall
22	Channel Lib. Recall No. XX	CH LibXXX Recall
23	GATE Lib. Recall +1	Gate Lib+1 RCL.
24	GATE Lib. Recall -1	Gate Lib-1 RCL.
25	GATE Lib. Recall No. XX	Gate LibXXX RCL.
26	COMP Lib. Recall +1	Comp Lib+1 RCL.
27	COMP Lib. Recall -1	Comp Lib-1 RCL.
28	COMP Lib. Recall No. XX	Comp LibXXX RCL.
29	EQ Lib. Recall +1	EQ Lib+1 Recall
30	EQ Lib. Recall -1	EQ Lib-1 Recall
31	EQ Lib. Recall No. XX	EQ LibXXX Recall
32	Input Patch Lib. Recall +1	IN Patch Lib+1
33	Input Patch Lib. Recall -1	IN Patch Lib-1
34	Input Patch Lib. Recall No. XX	IN Patch LibXX
35	Output Patch Lib. Recall +1	Out Patch Lib+1
36	Output Patch Lib. Recall -1	Out Patch Lib-1
37	Output Patch Lib. Recall No. XX	Out Patch LibXX
38	Input Fader Group Enable A	IN Fader Group A
39	Input Fader Group Enable B	IN Fader Group B
40	Input Fader Group Enable C	IN Fader Group C
41	Input Fader Group Enable D	IN Fader Group D
42	Input Fader Group Enable E	IN Fader Group E
43	Input Fader Group Enable F	IN Fader Group F
44	Input Fader Group Enable G	IN Fader Group G
45	Input Fader Group Enable H	IN Fader Group H
46	Input MUTE Group Enable I	IN Mute Group I
47	Input MUTE Group Enable J	IN Mute Group J
48	Input MUTE Group Enable K	IN Mute Group K
49	Input MUTE Group Enable L	IN Mute Group L
50	Input MUTE Group Enable M	IN Mute Group M
51	Input MUTE Group Enable N	IN Mute Group N

#	Function	Display
52	Input MUTE Group Enable O	IN Mute Group O
53	Input MUTE Group Enable P	IN Mute Group P
54	Output Fader Group Enable Q	OutFader Group Q
55	Output Fader Group Enable R	OutFader Group R
56	Output Fader Group Enable S	OutFader Group S
57	Output Fader Group Enable T	OutFader Group T
58	Output MUTE Group Enable U	Out Mute Group U
59	Output MUTE Group Enable V	Out Mute Group V
60	Output MUTE Group Enable W	Out Mute Group W
61	Output MUTE Group Enable X	Out Mute Group X
62	Input Fader Group Assign X	IN Fader Assign X
63	Input Mute Group Assign X	IN Mute Assign X
64	Input EQ Group Assign X	IN EQ Assign x
65	Input COMP Group Assign X	IN COMP Assign x
66	Output Fader Group Assign X	OutFader Assign X
67	Output Mute Group Assign X	Out Mute Assign X
68	Output EQ Group Assign X	Out EQ Assign x
69	Output COMP Group Assign X	Out COMP Assign x
70	Input Mute Group Master X	In Mute Master X
71	Output MUTE Group Master X	Out Mute Master X
72	PEAK HOLD On/Off	Peak Hold
73	OSCILLATOR On/Off	OSC ON/OFF
74	SOLO Enable	SOLO ENABLE
75	FADER/SOLO RELEASE Mode On/Off	FaderSolo RELEASE
76	Control Room Monitor MONO	C-R MONO
77	Pan / Surround Link	PAN/SURR LINK
78	Channel Name ID/Short	CH ID/Short
79	Channel Copy	Channel Copy
80	Channel Paste	Channel Paste
81	Display Back	Display Back
82	Display Forward	Display Forward
83	UDEF KEYS BANK +1	UDEF KEYS BANK+1
84	UDEF KEYS BANK -1	UDEF KEYS BANK-1
85	UDEF KEYS BANK X	UDEF KEYS BANK x
86	REMOTE USER DEFINE BANK +1	RMT UDEF BANK+1
87	REMOTE USER DEFINE BANK -1	RMT UDEF BANK-1
88	REMOTE USER DEFINE BANK X	RMT UDEF BANK X
89	REMOTE USER ASS LAYER BANK +1	USR LAYER BANK+1
90	REMOTE USER ASS LAYER BANK -1	USR LAYER BANK-1
91	REMOTE USER ASS LAYER BANK X	USR LAYER BANK X
92	MIDI NOTE No.XX	MIDI NOTE XXX
93	MIDI Program change No.XX	MIDI PGM XXX
94	MIDI Control Change No.XX	MIDI CC XXX
95	Machine REC	Machine REC
96	Machine PLAY	Machine PLAY
97	Machine STOP	Machine STOP
98	Machine FF	Machine FF
99	Machine REW	Machine REW
100	Machine SHUTTLE	Machine SHUTTLE
101	Machine SCRUB	Machine SCRUB
102	Machine LOCATE X	Machine LOCATE X
103	Machine Set LOCATE X	Machine Capture X
104	Machine RTZ	Machine RTZ
105	Machine Set RTZ	Machine Set RTZ

#	Function	Display
106	Track Arming 1	Track Arming 1
107	Track Arming 2	Track Arming 2
108	Track Arming 3	Track Arming 3
109	Track Arming 4	Track Arming 4
110	Track Arming 5	Track Arming 5
111	Track Arming 6	Track Arming 6
112	Track Arming 7	Track Arming 7
113	Track Arming 8	Track Arming 8
114	Track Arming 9	Track Arming 9
115	Track Arming 10	Track Arming 10
116	Track Arming 11	Track Arming 11
117	Track Arming 12	Track Arming 12
118	Track Arming 13	Track Arming 13
119	Track Arming 14	Track Arming 14
120	Track Arming 15	Track Arming 15
121	Track Arming 16	Track Arming 16
122	Track Arming 17	Track Arming 17
123	Track Arming 18	Track Arming 18
124	Track Arming 19	Track Arming 19
125	Track Arming 20	Track Arming 20
126	Track Arming 21	Track Arming 21
127	Track Arming 22	Track Arming 22
128	Track Arming 23	Track Arming 23
129	Track Arming 24	Track Arming 24
130	Track Arming All Clear	Track Arming CLR
131	DAW REC	DAW REC
132	DAW PLAY	DAW PLAY
133	DAW STOP	DAW STOP
134	DAW FF	DAW FF
135	DAW REW	DAW REW
136	DAW SHUTTLE	DAW SHUTTLE
137	DAW SCRUB	DAW SCRUB
138	DAW AUDITION	DAW AUDITION
139	DAW PRE	DAW PRE
140	DAW IN	DAW IN
141	DAW OUT	DAW OUT
142	DAW POST	DAW POST
143	DAW RTZ	DAW RTZ
144	DAW END	DAW END
145	DAW ONLINE	DAW ONLINE
146	DAW LOOP	DAW LOOP
147	DAW QUICKPUNCH	DAW QUICKPUNCH
148	DAW GROUP STATUS	DAW GROUP STATUS
149	DAW AUTO FADER	DAW AUTO FADER
150	DAW AUTO MUTE	DAW AUTO MUTE
151	DAW AUTO PAN	DAW AUTO PAN
152	DAW AUTO SEND	DAW AUTO SEND
153	DAW AUTO PLUGIN	DAW AUTO PLUGIN
154	DAW AUTO SEND MUTE	DAW AUTO SENDMUTE
155	DAW AUTO READ	DAW AUTO READ
156	DAW AUTO TOUCH	DAW AUTO TOUCH
157	DAW AUTO LATCH	DAW AUTO LATCH
158	DAW AUTO WRITE	DAW AUTO WRITE
159	DAW AUTO TRIM	DAW AUTO TRIM
160	DAW AUTO OFF	DAW AUTO OFF
161	DAW AUTO SUSPEND	DAW AUTO SUSPEND
162	DAW AUTO STATUS	DAW AUTO STATUS
163	DAW MONITOR STATUS	DAW MONI STATUS
164	DAW CREATE GROUP	DAW CREATE GROUP

#	Function	Display
165	DAW SUSPEND GROUP	DAW SUSPEND GRP
166	DAW WINDOW TRANSPORT	DAW WIN TRANSPORT
167	DAW WINDOW INSERT	DAW WIN INSERT
168	DAW WINDOW MIX/EDIT	DAW WIN MIX/EDIT
169	DAW WINDOW MEM-LOC	DAW WIN MEM-LOC
170	DAW WINDOW STATUS	DAW WIN STATUS
171	DAW Shortcut UNDO	DAW UNDO
172	DAW Shortcut SAVE	DAW SAVE
173	DAW Shortcut EDIT MODE	DAW EDIT MODE
174	DAW Shortcut EDIT TOOL	DAW EDIT TOOL
175	DAW Shortcut SHIFT/ADD	DAW SHIFT/ADD
176	DAW Shortcut OPTION/ALL	DAW OPTION/ALL
177	DAW Shortcut CTRL/CLUCH	DAW CTRL/CLUCH
178	DAW Shortcut ALT/FINE	DAW ALT/FINE
179	DAW BANK +	DAW BANK +
180	DAW BANK -	DAW BANK -
181	DAW Channel +	DAW Channel +
182	DAW Channel -	DAW Channel -
183	DAW REC/RDY X	DAW REC/RDY X
184	DAW REC/RDY ALL	DAW REC/RDY ALL
185	Studio Manager Window Control Close	SM CTRL Close
186	Studio Manager Window Control Close All	SM CTRL Close All
187	Studio Manager Window Control Selected Channel	SM CTRL Sel Ch
188	Studio Manager Window Control Library	SM CTRL Library
189	Studio Manager Window Control Patch Editor	SM CTRL Patch
190	Studio Manager Window Control Surround Editor	SM CTRL Surround
191	Studio Manager Window Control Effect Editor	SM CTRL Effect
192	Studio Manager Window Control Meter	SM CTRL Meter
193	Studio Manager Window Control Layer	SM CTRL Layer
194	Studio Manager Window Control Master	SM CTRL Master

USER DEFINED KEYS Initial Assignments

	BANK A	BANK B	BANK C	BANK D	BANK E	BANK F	BANK G	BANK H
TITLE	Scene Recall	Group Enable	DAW 1	DAW 2	Machine Control	Program Change	Special Function	No Assign
1	Scene 1 Recall	IN Fader Group A	UDEF BANK D	UDEF BANK C	Machine SHUTTLE	MIDI PGM 1	Display Back	No Assign
2	Scene 2 Recall	IN Mute Group I	DAW WIN MIX/EDIT	DAW OPTION/ALL	Machine SCRUB	MIDI PGM 2	Display Forward	No Assign
3	Scene 3 Recall	IN Fader Group B	DAW BANK -	DAW AUTO READ	Machine RTZ	MIDI PGM 3	Channel Copy	No Assign
4	Scene 4 Recall	IN Mute Group J	DAW BANK +	DAW AUTO TOUCH	Machine REC	MIDI PGM 4	Channel Paste	No Assign
5	Scene 5 Recall	IN Fader Group C	DAW SHUTTLE	DAW AUTO LATCH	Machine STOP	MIDI PGM 5	No Assign	No Assign
6	Scene 6 Recall	IN Mute Group K	DAW SCRUB	DAW AUTO WRITE	Machine PLAY	MIDI PGM 6	No Assign	No Assign
7	Scene 7 Recall	IN Fader Group D	DAW STOP	DAW AUTO TRIM	Machine REW	MIDI PGM 7	No Assign	No Assign
8	Scene 8 Recall	IN Mute Group L	DAW PLAY	DAW AUTO OFF	Machine FF	MIDI PGM 8	No Assign	No Assign

Input Patch Parameters

INPUT		INSERT IN		EFFECT IN		CASCADE	
Port ID	Description	Port ID	Description	Port ID	Description	Port ID	Description
-	NONE	-	NONE	-	NONE	-	NONE
AD1	AD IN 1	AD1	AD IN 1	AUX1	AUX1	ADAT1	ADAT1 IN
AD2	AD IN 2	AD2	AD IN 2	AUX2	AUX2	ADAT2	ADAT2 IN
AD3	AD IN 3	AD3	AD IN 3	AUX3	AUX3	ADAT3	ADAT3 IN
AD4	AD IN 4	AD4	AD IN 4	AUX4	AUX4	ADAT4	ADAT4 IN
AD5	AD IN 5	AD5	AD IN 5	AUX5	AUX5	ADAT5	ADAT5 IN
AD6	AD IN 6	AD6	AD IN 6	AUX6	AUX6	ADAT6	ADAT6 IN
AD7	AD IN 7	AD7	AD IN 7	AUX7	AUX7	ADAT7	ADAT7 IN
AD8	AD IN 8	AD8	AD IN 8	AUX8	AUX8	ADAT8	ADAT8 IN
AD9	AD IN 9	AD9	AD IN 9	INS CH1	InsertOut-CH1	SL-01	Slot CH1 IN
AD10	AD IN 10	AD10	AD IN 10	INS CH2	InsertOut-CH2	SL-02	Slot CH2 IN
AD11	AD IN 11	AD11	AD IN 11	INS CH3	InsertOut-CH3	SL-03	Slot CH3 IN
AD12	AD IN 12	AD12	AD IN 12	INS CH4	InsertOut-CH4	SL-04	Slot CH4 IN
AD13	AD IN 13	AD13	AD IN 13	INS CH5	InsertOut-CH5	SL-05	Slot CH5 IN
AD14	AD IN 14	AD14	AD IN 14	INS CH6	InsertOut-CH6	SL-06	Slot CH6 IN
AD15	AD IN 15	AD15	AD IN 15	INS CH7	InsertOut-CH7	SL-07	Slot CH7 IN
AD16	AD IN 16	AD16	AD IN 16	INS CH8	InsertOut-CH8	SL-08	Slot CH8 IN
ADAT1	ADAT1 IN	ADAT1	ADAT1 IN	INS CH9	InsertOut-CH9	SL-09	Slot CH9 IN
ADAT2	ADAT2 IN	ADAT2	ADAT2 IN	INS CH10	InsertOut-CH10	SL-10	Slot CH10 IN
ADAT3	ADAT3 IN	ADAT3	ADAT3 IN	INS CH11	InsertOut-CH11	SL-11	Slot CH11 IN
ADAT4	ADAT4 IN	ADAT4	ADAT4 IN	INS CH12	InsertOut-CH12	SL-12	Slot CH12 IN
ADAT5	ADAT5 IN	ADAT5	ADAT5 IN	INS CH13	InsertOut-CH13	SL-13	Slot CH13 IN
ADAT6	ADAT6 IN	ADAT6	ADAT6 IN	INS CH14	InsertOut-CH14	SL-14	Slot CH14 IN
ADAT7	ADAT7 IN	ADAT7	ADAT7 IN	INS CH15	InsertOut-CH15	SL-15	Slot CH15 IN
ADAT8	ADAT8 IN	ADAT8	ADAT8 IN	INS CH16	InsertOut-CH16	SL-16	Slot CH16 IN
SL-01	Slot CH1 IN	SL-01	Slot CH1 IN	INS CH17	InsertOut-CH17	AD1	AD IN 1
SL-02	Slot CH2 IN	SL-02	Slot CH2 IN	INS CH18	InsertOut-CH18	AD2	AD IN 2
SL-03	Slot CH3 IN	SL-03	Slot CH3 IN	INS CH19	InsertOut-CH19	AD3	AD IN 3
SL-04	Slot CH4 IN	SL-04	Slot CH4 IN	INS CH20	InsertOut-CH20	AD4	AD IN 4
SL-05	Slot CH5 IN	SL-05	Slot CH5 IN	INS CH21	InsertOut-CH21	AD5	AD IN 5
SL-06	Slot CH6 IN	SL-06	Slot CH6 IN	INS CH22	InsertOut-CH22	AD6	AD IN 6

INPUT		INSERT IN		EFFECT IN		CASCADE	
Port ID	Description	Port ID	Description	Port ID	Description	Port ID	Description
SL-07	Slot CH7 IN	SL-07	Slot CH7 IN	INS CH23	InsertOut-CH23	AD7	AD IN 7
SL-08	Slot CH8 IN	SL-08	Slot CH8 IN	INS CH24	InsertOut-CH24	AD8	AD IN 8
SL-09	Slot CH9 IN	SL-09	Slot CH9 IN	INS CH25	InsertOut-CH25	AD9	AD IN 9
SL-10	Slot CH10 IN	SL-10	Slot CH10 IN	INS CH26	InsertOut-CH26	AD10	AD IN 10
SL-11	Slot CH11 IN	SL-11	Slot CH11 IN	INS CH27	InsertOut-CH27	AD11	AD IN 11
SL-12	Slot CH12 IN	SL-12	Slot CH12 IN	INS CH28	InsertOut-CH28	AD12	AD IN 12
SL-13	Slot CH13 IN	SL-13	Slot CH13 IN	INS CH29	InsertOut-CH29	AD13	AD IN 13
SL-14	Slot CH14 IN	SL-14	Slot CH14 IN	INS CH30	InsertOut-CH30	AD14	AD IN 14
SL-15	Slot CH15 IN	SL-15	Slot CH15 IN	INS CH31	InsertOut-CH31	AD15	AD IN 15
SL-16	Slot CH16 IN	SL-16	Slot CH16 IN	INS CH32	InsertOut-CH32	AD16	AD IN 16
FX1-1	Effect1 OUT 1	FX1-1	Effect1 OUT 1	INS BUS1	InsertOut-BUS1	2TD-L	2TR IN Dig. L
FX1-2	Effect1 OUT 2	FX1-2	Effect1 OUT 2	INS BUS2	InsertOut-BUS2	2TD-R	2TR IN Dig. R
FX2-1	Effect2 OUT 1	FX2-1	Effect2 OUT 1	INS BUS3	InsertOut-BUS3		
FX2-2	Effect2 OUT 2	FX2-2	Effect2 OUT 2	INS BUS4	InsertOut-BUS4		
FX3-1	Effect3 OUT 1	FX3-1	Effect3 OUT 1	INS BUS5	InsertOut-BUS5		
FX3-2	Effect3 OUT 2	FX3-2	Effect3 OUT 2	INS BUS6	InsertOut-BUS6		
FX4-1	Effect4 OUT 1	FX4-1	Effect4 OUT 1	INS BUS7	InsertOut-BUS7		
FX4-2	Effect4 OUT 2	FX4-2	Effect4 OUT 2	INS BUS8	InsertOut-BUS8		
2TD-L	2TR IN Dig. L	2TD-L	2TR IN Dig. L	INS AUX1	InsertOut-AUX1		
2TD-R	2TR IN Dig. R	2TD-R	2TR IN Dig. R	INS AUX2	InsertOut-AUX2		
				INS AUX3	InsertOut-AUX3		
				INS AUX4	InsertOut-AUX4		
				INS AUX5	InsertOut-AUX5		
				INS AUX6	InsertOut-AUX6		
				INS AUX7	InsertOut-AUX7		
				INS AUX8	InsertOut-AUX8		
				INS ST-L	InsertOut-ST-L		
				INS ST-R	InsertOut-ST-R		

Initial Input Patch Settings

CHANNEL

1	AD1
2	AD2
3	AD3
4	AD4
5	AD5
6	AD6
7	AD7
8	AD8
9	AD9
10	AD10
11	AD11
12	AD12
13	AD13
14	AD14
15	AD15
16	AD16
17	ADAT1
18	ADAT2
19	ADAT3
20	ADAT4
21	ADAT5
22	ADAT6
23	ADAT7
24	ADAT8
25	S-1
26	S-2
27	S-3
28	S-4
29	S-5
30	S-6
31	S-7
32	S-8

ST11L	FX1-1
ST11R	FX1-2
ST12L	FX2-1
ST12R	FX2-2
ST13L	FX3-1
ST13R	FX3-2
ST14L	FX4-1
ST14R	FX4-2

EFFECT IN PATCH

1-1	AUX1
1-2	NONE
2-1	AUX2
2-2	NONE
3-1	AUX3
3-2	NONE
4-1	AUX4
4-2	NONE

CASCADE IN PATCH

BUS1	NONE
BUS2	NONE
BUS3	NONE
BUS4	NONE
BUS5	NONE
BUS6	NONE
BUS7	NONE
BUS8	NONE
AUX1	NONE
AUX2	NONE
AUX3	NONE
AUX4	NONE
AUX5	NONE
AUX6	NONE
AUX7	NONE
AUX8	NONE
ST L	NONE
ST R	NONE
SOLO L	NONE
SOLO R	NONE

EFFECT TYPE

EFFECT1	REVERB HALL
EFFECT2	REVERB ROOM
EFFECT3	REVERB STAGE
EFFECT4	REVERB PLATE

(mono input)

CHANNEL NAME

	CHANNEL ID	SHORT	LONG
CH1	CH1	CH1	CH1
CH2	CH2	CH2	CH2
CH3	CH3	CH3	CH3
CH4	CH4	CH4	CH4
CH5	CH5	CH5	CH5
CH6	CH6	CH6	CH6
CH7	CH7	CH7	CH7
CH8	CH8	CH8	CH8
CH9	CH9	CH9	CH9
CH10	CH10	CH10	CH10
CH11	CH11	CH11	CH11
CH12	CH12	CH12	CH12
CH13	CH13	CH13	CH13
CH14	CH14	CH14	CH14
CH15	CH15	CH15	CH15
CH16	CH16	CH16	CH16
CH17	CH17	CH17	CH17
CH18	CH18	CH18	CH18
CH19	CH19	CH19	CH19
CH20	CH20	CH20	CH20
CH21	CH21	CH21	CH21
CH22	CH22	CH22	CH22
CH23	CH23	CH23	CH23
CH24	CH24	CH24	CH24
CH25	CH25	CH25	CH25
CH26	CH26	CH26	CH26
CH27	CH27	CH27	CH27
CH28	CH28	CH28	CH28
CH29	CH29	CH29	CH29
CH30	CH30	CH30	CH30
CH31	CH31	CH31	CH31
CH32	CH32	CH32	CH32

ST IN1	STI1	STI1	STEREO IN1
ST IN2	STI2	STI2	STEREO IN2
ST IN3	STI3	STI3	STEREO IN3
ST IN4	STI4	STI4	STEREO IN4

Output Patch Parameters

SLOT, ADAT, OMNI		INSERT IN		DIRECT OUT		2TR OUT Digital	
Source	Description	Source	Description	Source	Description	Source	Description
–	NONE	–	NONE	–	NONE	–	NONE
BUS1	BUS1	AD1	AD IN 1	ADAT1	ADAT1 OUT	BUS1	BUS1
BUS2	BUS2	AD2	AD IN 2	ADAT2	ADAT2 OUT	BUS2	BUS2
BUS3	BUS3	AD3	AD IN 3	ADAT3	ADAT3 OUT	BUS3	BUS3
BUS4	BUS4	AD4	AD IN 4	ADAT4	ADAT4 OUT	BUS4	BUS4
BUS5	BUS5	AD5	AD IN 5	ADAT5	ADAT5 OUT	BUS5	BUS5
BUS6	BUS6	AD6	AD IN 6	ADAT6	ADAT6 OUT	BUS6	BUS6
BUS7	BUS7	AD7	AD IN 7	ADAT7	ADAT7 OUT	BUS7	BUS7
BUS8	BUS8	AD8	AD IN 8	ADAT8	ADAT8 OUT	BUS8	BUS8
AUX1	AUX1	AD9	AD IN 9	SL-01	Slot CH1 IN	AUX1	AUX1
AUX2	AUX2	AD10	AD IN 10	SL-02	Slot CH2 IN	AUX2	AUX2
AUX3	AUX3	AD11	AD IN 11	SL-03	Slot CH3 IN	AUX3	AUX3
AUX4	AUX4	AD12	AD IN 12	SL-04	Slot CH4 IN	AUX4	AUX4
AUX5	AUX5	AD13	AD IN 13	SL-05	Slot CH5 IN	AUX5	AUX5
AUX6	AUX6	AD14	AD IN 14	SL-06	Slot CH6 IN	AUX6	AUX6
AUX7	AUX7	AD15	AD IN 15	SL-07	Slot CH7 IN	AUX7	AUX7
AUX8	AUX8	AD16	AD IN 16	SL-08	Slot CH8 IN	AUX8	AUX8
ST L	STEREO L	ADAT1	ADAT1 IN	SL-09	Slot CH9 IN	ST L	STEREO L
ST R	STEREO R	ADAT2	ADAT2 IN	SL-10	Slot CH10 IN	ST R	STEREO R
INS CH1	InsertOut-CH1	ADAT3	ADAT3 IN	SL-11	Slot CH11 IN	INS CH1	InsertOut-CH1
INS CH2	InsertOut-CH2	ADAT4	ADAT4 IN	SL-12	Slot CH12 IN	INS CH2	InsertOut-CH2
INS CH3	InsertOut-CH3	ADAT5	ADAT5 IN	SL-13	Slot CH13 IN	INS CH3	InsertOut-CH3
INS CH4	InsertOut-CH4	ADAT6	ADAT6 IN	SL-14	Slot CH14 IN	INS CH4	InsertOut-CH4
INS CH5	InsertOut-CH5	ADAT7	ADAT7 IN	SL-15	Slot CH15 IN	INS CH5	InsertOut-CH5
INS CH6	InsertOut-CH6	ADAT8	ADAT8 IN	SL-16	Slot CH16 IN	INS CH6	InsertOut-CH6
INS CH7	InsertOut-CH7	SL-01	Slot CH1 IN	OMNI1	OMNI OUT 1	INS CH7	InsertOut-CH7
INS CH8	InsertOut-CH8	SL-02	Slot CH2 IN	OMNI2	OMNI OUT 2	INS CH8	InsertOut-CH8
INS CH9	InsertOut-CH9	SL-03	Slot CH3 IN	OMNI3	OMNI OUT 3	INS CH9	InsertOut-CH9
INS CH10	InsertOut-CH10	SL-04	Slot CH4 IN	OMNI4	OMNI OUT 4	INS CH10	InsertOut-CH10
INS CH11	InsertOut-CH11	SL-05	Slot CH5 IN	2TD-L	2TR OUT Dig. L	INS CH11	InsertOut-CH11
INS CH12	InsertOut-CH12	SL-06	Slot CH6 IN	2TD-R	2TR OUT Dig. R	INS CH12	InsertOut-CH12
INS CH13	InsertOut-CH13	SL-07	Slot CH7 IN	—	—	INS CH13	InsertOut-CH13
INS CH14	InsertOut-CH14	SL-08	Slot CH8 IN	—	—	INS CH14	InsertOut-CH14
INS CH15	InsertOut-CH15	SL-09	Slot CH9 IN	—	—	INS CH15	InsertOut-CH15
INS CH16	InsertOut-CH16	SL-10	Slot CH10 IN	—	—	INS CH16	InsertOut-CH16
INS CH17	InsertOut-CH17	SL-11	Slot CH11 IN	—	—	INS CH17	InsertOut-CH17
INS CH18	InsertOut-CH18	SL-12	Slot CH12 IN	—	—	INS CH18	InsertOut-CH18
INS CH19	InsertOut-CH19	SL-13	Slot CH13 IN	—	—	INS CH19	InsertOut-CH19
INS CH20	InsertOut-CH20	SL-14	Slot CH14 IN	—	—	INS CH20	InsertOut-CH20
INS CH21	InsertOut-CH21	SL-15	Slot CH15 IN	—	—	INS CH21	InsertOut-CH21
INS CH22	InsertOut-CH22	SL-16	Slot CH16 IN	—	—	INS CH22	InsertOut-CH22
INS CH23	InsertOut-CH23	FX1-1	Effect1 OUT 1	—	—	INS CH23	InsertOut-CH23
INS CH24	InsertOut-CH24	FX1-2	Effect1 OUT 2	—	—	INS CH24	InsertOut-CH24
INS CH25	InsertOut-CH25	FX2-1	Effect2 OUT 1	—	—	INS CH25	InsertOut-CH25
INS CH26	InsertOut-CH26	FX2-2	Effect2 OUT 2	—	—	INS CH26	InsertOut-CH26
INS CH27	InsertOut-CH27	FX3-1	Effect3 OUT 1	—	—	INS CH27	InsertOut-CH27
INS CH28	InsertOut-CH28	FX3-2	Effect3 OUT 2	—	—	INS CH28	InsertOut-CH28
INS CH29	InsertOut-CH29	FX4-1	Effect4 OUT 1	—	—	INS CH29	InsertOut-CH29
INS CH30	InsertOut-CH30	FX4-2	Effect4 OUT 2	—	—	INS CH30	InsertOut-CH30
INS CH31	InsertOut-CH31	2TD-L	2TR IN Dig. L	—	—	INS CH31	InsertOut-CH31
INS CH32	InsertOut-CH32	2TD-R	2TR IN Dig. R	—	—	INS CH32	InsertOut-CH32

SLOT, ADAT, OMNI		INSERT IN		DIRECT OUT		2TR OUT Digital	
Source	Description	Source	Description	Source	Description	Source	Description
INS BUS1	InsertOut-BUS1	—	—	—	—	INS BUS1	InsertOut-BUS1
INS BUS2	InsertOut-BUS2	—	—	—	—	INS BUS2	InsertOut-BUS2
INS BUS3	InsertOut-BUS3	—	—	—	—	INS BUS3	InsertOut-BUS3
INS BUS4	InsertOut-BUS4	—	—	—	—	INS BUS4	InsertOut-BUS4
INS BUS5	InsertOut-BUS5	—	—	—	—	INS BUS5	InsertOut-BUS5
INS BUS6	InsertOut-BUS6	—	—	—	—	INS BUS6	InsertOut-BUS6
INS BUS7	InsertOut-BUS7	—	—	—	—	INS BUS7	InsertOut-BUS7
INS BUS8	InsertOut-BUS8	—	—	—	—	INS BUS8	InsertOut-BUS8
INS AUX1	InsertOut-AUX1	—	—	—	—	INS AUX1	InsertOut-AUX1
INS AUX2	InsertOut-AUX2	—	—	—	—	INS AUX2	InsertOut-AUX2
INS AUX3	InsertOut-AUX3	—	—	—	—	INS AUX3	InsertOut-AUX3
INS AUX4	InsertOut-AUX4	—	—	—	—	INS AUX4	InsertOut-AUX4
INS AUX5	InsertOut-AUX5	—	—	—	—	INS AUX5	InsertOut-AUX5
INS AUX6	InsertOut-AUX6	—	—	—	—	INS AUX6	InsertOut-AUX6
INS AUX7	InsertOut-AUX7	—	—	—	—	INS AUX7	InsertOut-AUX7
INS AUX8	InsertOut-AUX8	—	—	—	—	INS AUX8	InsertOut-AUX8
INS ST-L	InsertOut-STL	—	—	—	—	INS ST-L	InsertOut-ST-L
INS ST-R	InsertOut-STR	—	—	—	—	INS ST-R	InsertOut-ST-R
CAS BUS1	Cascade Out Bus1	—	—	—	—	CAS BUS1	Cascade Out Bus1
CAS BUS2	Cascade Out Bus2	—	—	—	—	CAS BUS2	Cascade Out Bus2
CAS BUS3	Cascade Out Bus3	—	—	—	—	CAS BUS3	Cascade Out Bus3
CAS BUS4	Cascade Out Bus4	—	—	—	—	CAS BUS4	Cascade Out Bus4
CAS BUS5	Cascade Out Bus5	—	—	—	—	CAS BUS5	Cascade Out Bus5
CAS BUS6	Cascade Out Bus6	—	—	—	—	CAS BUS6	Cascade Out Bus6
CAS BUS7	Cascade Out Bus7	—	—	—	—	CAS BUS7	Cascade Out Bus7
CAS BUS8	Cascade Out Bus8	—	—	—	—	CAS BUS8	Cascade Out Bus8
CAS AUX1	Cascade Out Aux1	—	—	—	—	CAS AUX1	Cascade Out Aux1
CAS AUX2	Cascade Out Aux2	—	—	—	—	CAS AUX2	Cascade Out Aux2
CAS AUX3	Cascade Out Aux3	—	—	—	—	CAS AUX3	Cascade Out Aux3
CAS AUX4	Cascade Out Aux4	—	—	—	—	CAS AUX4	Cascade Out Aux4
CAS AUX5	Cascade Out Aux5	—	—	—	—	CAS AUX5	Cascade Out Aux5
CAS AUX6	Cascade Out Aux6	—	—	—	—	CAS AUX6	Cascade Out Aux6
CAS AUX7	Cascade Out Aux7	—	—	—	—	CAS AUX7	Cascade Out Aux7
CAS AUX8	Cascade Out Aux8	—	—	—	—	CAS AUX8	Cascade Out Aux8
CAS ST-L	Cascade STEREO-L	—	—	—	—	CAS ST-L	Cascade STEREO-L
CAS ST-R	Cascade STEREO-R	—	—	—	—	CAS ST-R	Cascade STEREO-R
CASSOLOL	Cascade SOLO L	—	—	—	—	CASSOLOL	Cascade SOLO L
CASSOLOR	Cascade SOLO R	—	—	—	—	CASSOLOR	Cascade SOLO R

Initial Output Patch Settings

SLOT

SLOT1-1	BUS1
SLOT1-2	BUS2
SLOT1-3	BUS3
SLOT1-4	BUS4
SLOT1-5	BUS5
SLOT1-6	BUS6
SLOT1-7	BUS7
SLOT1-8	BUS8
SLOT1-9	BUS1
SLOT1-10	BUS2
SLOT1-11	BUS3
SLOT1-12	BUS4
SLOT1-13	BUS5
SLOT1-14	BUS6
SLOT1-15	BUS7
SLOT1-16	BUS8

ADAT OUT

1	BUS1
2	BUS2
3	BUS3
4	BUS4
5	BUS5
6	BUS6
7	BUS7
8	BUS8

OMNI OUT

1	AUX1
2	AUX2
3	AUX3
4	AUX4

DIRECT OUT

1	ADAT1
2	ADAT2
3	ADAT3
4	ADAT4
5	ADAT5
6	ADAT6
7	ADAT7
8	ADAT8
9	SLOT-1
10	SLOT-2
11	SLOT-3
12	SLOT-4
13	SLOT-5
14	SLOT-6
15	SLOT-7
16	SLOT-8

17	NONE
18	NONE
19	NONE
20	NONE
21	NONE
22	NONE
23	NONE
24	NONE
25	NONE
26	NONE
27	NONE
28	NONE
29	NONE
30	NONE
31	NONE
32	NONE

2TR OUT Digital

1L	ST L
1R	ST R

CHANNEL NAME

	CHANNEL ID	SHORT	LONG
AUX1	AUX1	AUX1	AUX1
AUX2	AUX2	AUX2	AUX2
AUX3	AUX3	AUX3	AUX3
AUX4	AUX4	AUX4	AUX4
AUX5	AUX5	AUX5	AUX5
AUX6	AUX6	AUX6	AUX6
AUX7	AUX7	AUX7	AUX7
AUX8	AUX8	AUX8	AUX8
BUS1	BUS1	BUS1	BUS1
BUS2	BUS2	BUS2	BUS2
BUS3	BUS3	BUS3	BUS3
BUS4	BUS4	BUS4	BUS4
BUS5	BUS5	BUS5	BUS5
BUS6	BUS6	BUS6	BUS6
BUS7	BUS7	BUS7	BUS7
BUS8	BUS8	BUS8	BUS8
STEREO	ST	ST	STEREO

User Defined Remote Layer Initial Bank Settings

Bank 1 (GM Vol & Pan)

ID	Name		Controller	Data Format															
	Short	Long		1	2	3	4	5	6	7	8	9	10	11	12	13	14	15	16
RM01	GM01	GM-CH01 VOL&PAN	ON	END	-	-	-	-	-	-	-	-	-	-	-	-	-	-	-
			FADER	B0	07	FAD	END	-	-	-	-	-	-	-	-	-	-	-	-
RM02	GM02	GM-CH02 VOL&PAN	ON	END	-	-	-	-	-	-	-	-	-	-	-	-	-	-	-
			FADER	B1	07	FAD	END	-	-	-	-	-	-	-	-	-	-	-	-
RM03	GM03	GM-CH03 VOL&PAN	ON	END	-	-	-	-	-	-	-	-	-	-	-	-	-	-	-
			FADER	B2	07	FAD	END	-	-	-	-	-	-	-	-	-	-	-	-
RM04	GM04	GM-CH04 VOL&PAN	ON	END	-	-	-	-	-	-	-	-	-	-	-	-	-	-	-
			FADER	B3	07	FAD	END	-	-	-	-	-	-	-	-	-	-	-	-
RM05	GM05	GM-CH05 VOL&PAN	ON	END	-	-	-	-	-	-	-	-	-	-	-	-	-	-	-
			FADER	B4	07	FAD	END	-	-	-	-	-	-	-	-	-	-	-	-
RM06	GM06	GM-CH06 VOL&PAN	ON	END	-	-	-	-	-	-	-	-	-	-	-	-	-	-	-
			FADER	B5	07	FAD	END	-	-	-	-	-	-	-	-	-	-	-	-
RM07	GM07	GM-CH07 VOL&PAN	ON	END	-	-	-	-	-	-	-	-	-	-	-	-	-	-	-
			FADER	B6	07	FAD	END	-	-	-	-	-	-	-	-	-	-	-	-
RM08	GM08	GM-CH08 VOL&PAN	ON	END	-	-	-	-	-	-	-	-	-	-	-	-	-	-	-
			FADER	B7	07	FAD	END	-	-	-	-	-	-	-	-	-	-	-	-
RM09	GM09	GM-CH09 VOL&PAN	ON	END	-	-	-	-	-	-	-	-	-	-	-	-	-	-	-
			FADER	B8	07	FAD	END	-	-	-	-	-	-	-	-	-	-	-	-
RM10	GM10	GM-CH10 VOL&PAN	ON	END	-	-	-	-	-	-	-	-	-	-	-	-	-	-	-
			FADER	B9	07	FAD	END	-	-	-	-	-	-	-	-	-	-	-	-
RM11	GM11	GM-CH11 VOL&PAN	ON	END	-	-	-	-	-	-	-	-	-	-	-	-	-	-	-
			FADER	BA	07	FAD	END	-	-	-	-	-	-	-	-	-	-	-	-
RM12	GM12	GM-CH12 VOL&PAN	ON	END	-	-	-	-	-	-	-	-	-	-	-	-	-	-	-
			FADER	BB	07	FAD	END	-	-	-	-	-	-	-	-	-	-	-	-
RM13	GM13	GM-CH13 VOL&PAN	ON	END	-	-	-	-	-	-	-	-	-	-	-	-	-	-	-
			FADER	BC	07	FAD	END	-	-	-	-	-	-	-	-	-	-	-	-
RM14	GM14	GM-CH14 VOL&PAN	ON	END	-	-	-	-	-	-	-	-	-	-	-	-	-	-	-
			FADER	BD	07	FAD	END	-	-	-	-	-	-	-	-	-	-	-	-
RM15	GM15	GM-CH15 VOL&PAN	ON	END	-	-	-	-	-	-	-	-	-	-	-	-	-	-	-
			FADER	BE	07	FAD	END	-	-	-	-	-	-	-	-	-	-	-	-
RM16	GM16	GM-CH16 VOL&PAN	ON	END	-	-	-	-	-	-	-	-	-	-	-	-	-	-	-
			FADER	BF	07	FAD	END	-	-	-	-	-	-	-	-	-	-	-	-

Bank 2 (GM Vol & Effect 1)

ID	Name		Controller	Data Format															
	Short	Long		1	2	3	4	5	6	7	8	9	10	11	12	13	14	15	16
RM01	GM01	GM-CH01 VOL&EFF1	ON	END	-	-	-	-	-	-	-	-	-	-	-	-	-	-	-
			FADER	B0	07	FAD	END	-	-	-	-	-	-	-	-	-	-	-	-
RM02	GM02	GM-CH02 VOL&EFF1	ON	END	-	-	-	-	-	-	-	-	-	-	-	-	-	-	-
			FADER	B1	07	FAD	END	-	-	-	-	-	-	-	-	-	-	-	-
RM03	GM03	GM-CH03 VOL&EFF1	ON	END	-	-	-	-	-	-	-	-	-	-	-	-	-	-	-
			FADER	B2	07	FAD	END	-	-	-	-	-	-	-	-	-	-	-	-
RM04	GM04	GM-CH04 VOL&EFF1	ON	END	-	-	-	-	-	-	-	-	-	-	-	-	-	-	-
			FADER	B3	07	FAD	END	-	-	-	-	-	-	-	-	-	-	-	-
RM05	GM05	GM-CH05 VOL&EFF1	ON	END	-	-	-	-	-	-	-	-	-	-	-	-	-	-	-
			FADER	B4	07	FAD	END	-	-	-	-	-	-	-	-	-	-	-	-
RM06	GM06	GM-CH06 VOL&EFF1	ON	END	-	-	-	-	-	-	-	-	-	-	-	-	-	-	-
			FADER	B5	07	FAD	END	-	-	-	-	-	-	-	-	-	-	-	-
RM07	GM07	GM-CH07 VOL&EFF1	ON	END	-	-	-	-	-	-	-	-	-	-	-	-	-	-	-
			FADER	B6	07	FAD	END	-	-	-	-	-	-	-	-	-	-	-	-
RM08	GM08	GM-CH08 VOL&EFF1	ON	END	-	-	-	-	-	-	-	-	-	-	-	-	-	-	-
			FADER	B7	07	FAD	END	-	-	-	-	-	-	-	-	-	-	-	-
RM09	GM09	GM-CH09 VOL&EFF1	ON	END	-	-	-	-	-	-	-	-	-	-	-	-	-	-	-
			FADER	B8	07	FAD	END	-	-	-	-	-	-	-	-	-	-	-	-
RM10	GM10	GM-CH10 VOL&EFF1	ON	END	-	-	-	-	-	-	-	-	-	-	-	-	-	-	-
			FADER	B9	07	FAD	END	-	-	-	-	-	-	-	-	-	-	-	-
RM11	GM11	GM-CH11 VOL&EFF1	ON	END	-	-	-	-	-	-	-	-	-	-	-	-	-	-	-
			FADER	BA	07	FAD	END	-	-	-	-	-	-	-	-	-	-	-	-
RM12	GM12	GM-CH12 VOL&EFF1	ON	END	-	-	-	-	-	-	-	-	-	-	-	-	-	-	-
			FADER	BB	07	FAD	END	-	-	-	-	-	-	-	-	-	-	-	-
RM13	GM13	GM-CH13 VOL&EFF1	ON	END	-	-	-	-	-	-	-	-	-	-	-	-	-	-	-
			FADER	BC	07	FAD	END	-	-	-	-	-	-	-	-	-	-	-	-
RM14	GM14	GM-CH14 VOL&EFF1	ON	END	-	-	-	-	-	-	-	-	-	-	-	-	-	-	-
			FADER	BD	07	FAD	END	-	-	-	-	-	-	-	-	-	-	-	-
RM15	GM15	GM-CH15 VOL&EFF1	ON	END	-	-	-	-	-	-	-	-	-	-	-	-	-	-	-
			FADER	BE	07	FAD	END	-	-	-	-	-	-	-	-	-	-	-	-
RM16	GM16	GM-CH16 VOL&EFF1	ON	END	-	-	-	-	-	-	-	-	-	-	-	-	-	-	-
			FADER	BF	07	FAD	END	-	-	-	-	-	-	-	-	-	-	-	-

Bank 3 (XG Vol & Pan)

ID	Name		Controller	Data Format															
	Short	Long		1	2	3	4	5	6	7	8	9	10	11	12	13	14	15	16
RM01	XG01	XG-CH01 VOL&PAN	ON	END	-	-	-	-	-	-	-	-	-	-	-	-	-	-	-
			FADER	F0	43	10	4C	08	00	0B	FAD	F7	END	-	-	-	-	-	-
RM02	XG02	XG-CH02 VOL&PAN	ON	END	-	-	-	-	-	-	-	-	-	-	-	-	-	-	-
			FADER	F0	43	10	4C	08	01	0B	FAD	F7	END	-	-	-	-	-	-
RM03	XG03	XG-CH03 VOL&PAN	ON	END	-	-	-	-	-	-	-	-	-	-	-	-	-	-	-
			FADER	F0	43	10	4C	08	02	0B	FAD	F7	END	-	-	-	-	-	-
RM04	XG04	XG-CH04 VOL&PAN	ON	END	-	-	-	-	-	-	-	-	-	-	-	-	-	-	-
			FADER	F0	43	10	4C	08	03	0B	FAD	F7	END	-	-	-	-	-	-
RM05	XG05	XG-CH05 VOL&PAN	ON	END	-	-	-	-	-	-	-	-	-	-	-	-	-	-	-
			FADER	F0	43	10	4C	08	04	0B	FAD	F7	END	-	-	-	-	-	-
RM06	XG06	XG-CH06 VOL&PAN	ON	END	-	-	-	-	-	-	-	-	-	-	-	-	-	-	-
			FADER	F0	43	10	4C	08	05	0B	FAD	F7	END	-	-	-	-	-	-
RM07	XG07	XG-CH07 VOL&PAN	ON	END	-	-	-	-	-	-	-	-	-	-	-	-	-	-	-
			FADER	F0	43	10	4C	08	06	0B	FAD	F7	END	-	-	-	-	-	-
RM08	XG08	XG-CH08 VOL&PAN	ON	END	-	-	-	-	-	-	-	-	-	-	-	-	-	-	-
			FADER	F0	43	10	4C	08	07	0B	FAD	F7	END	-	-	-	-	-	-
RM09	XG09	XG-CH09 VOL&PAN	ON	END	-	-	-	-	-	-	-	-	-	-	-	-	-	-	-
			FADER	F0	43	10	4C	08	08	0B	FAD	F7	END	-	-	-	-	-	-
RM10	XG10	XG-CH10 VOL&PAN	ON	END	-	-	-	-	-	-	-	-	-	-	-	-	-	-	-
			FADER	F0	43	10	4C	08	09	0B	FAD	F7	END	-	-	-	-	-	-
RM11	XG11	XG-CH11 VOL&PAN	ON	END	-	-	-	-	-	-	-	-	-	-	-	-	-	-	-
			FADER	F0	43	10	4C	08	0A	0B	FAD	F7	END	-	-	-	-	-	-
RM12	XG12	XG-CH12 VOL&PAN	ON	END	-	-	-	-	-	-	-	-	-	-	-	-	-	-	-
			FADER	F0	43	10	4C	08	0B	0B	FAD	F7	END	-	-	-	-	-	-
RM13	XG13	XG-CH13 VOL&PAN	ON	END	-	-	-	-	-	-	-	-	-	-	-	-	-	-	-
			FADER	F0	43	10	4C	08	0C	0B	FAD	F7	END	-	-	-	-	-	-
RM14	XG14	XG-CH14 VOL&PAN	ON	END	-	-	-	-	-	-	-	-	-	-	-	-	-	-	-
			FADER	F0	43	10	4C	08	0D	0B	FAD	F7	END	-	-	-	-	-	-
RM15	XG15	XG-CH15 VOL&PAN	ON	END	-	-	-	-	-	-	-	-	-	-	-	-	-	-	-
			FADER	F0	43	10	4C	08	0E	0B	FAD	F7	END	-	-	-	-	-	-
RM16	XG16	XG-CH16 VOL&PAN	ON	END	-	-	-	-	-	-	-	-	-	-	-	-	-	-	-
			FADER	F0	43	10	4C	08	0F	0B	FAD	F7	END	-	-	-	-	-	-

Bank 4 (Nuendo VST Mixer)

ID	Name		Controller	Data Format															
	Short	Long		1	2	3	4	5	6	7	8	9	10	11	12	13	14	15	16
RM01	CH1	VST MIXER CH1	ON	B0	40	SW	END	-	-	-	-	-	-	-	-	-	-	-	-
			FADER	B0	07	FAD	END	-	-	-	-	-	-	-	-	-	-	-	-
RM02	CH2	VST MIXER CH2	ON	B1	40	SW	END	-	-	-	-	-	-	-	-	-	-	-	-
			FADER	B1	07	FAD	END	-	-	-	-	-	-	-	-	-	-	-	-
RM03	CH3	VST MIXER CH3	ON	B2	40	SW	END	-	-	-	-	-	-	-	-	-	-	-	-
			FADER	B2	07	FAD	END	-	-	-	-	-	-	-	-	-	-	-	-
RM04	CH4	VST MIXER CH4	ON	B3	40	SW	END	-	-	-	-	-	-	-	-	-	-	-	-
			FADER	B3	07	FAD	END	-	-	-	-	-	-	-	-	-	-	-	-
RM05	CH5	VST MIXER CH5	ON	B4	40	SW	END	-	-	-	-	-	-	-	-	-	-	-	-
			FADER	B4	07	FAD	END	-	-	-	-	-	-	-	-	-	-	-	-
RM06	CH6	VST MIXER CH6	ON	B5	40	SW	END	-	-	-	-	-	-	-	-	-	-	-	-
			FADER	B5	07	FAD	END	-	-	-	-	-	-	-	-	-	-	-	-
RM07	CH7	VST MIXER CH7	ON	B6	40	SW	END	-	-	-	-	-	-	-	-	-	-	-	-
			FADER	B6	07	FAD	END	-	-	-	-	-	-	-	-	-	-	-	-
RM08	CH8	VST MIXER CH8	ON	B7	40	SW	END	-	-	-	-	-	-	-	-	-	-	-	-
			FADER	B7	07	FAD	END	-	-	-	-	-	-	-	-	-	-	-	-
RM09	CH9	VST MIXER CH9	ON	B8	40	SW	END	-	-	-	-	-	-	-	-	-	-	-	-
			FADER	B8	07	FAD	END	-	-	-	-	-	-	-	-	-	-	-	-
RM10	CH10	VST MIXER CH10	ON	B9	40	SW	END	-	-	-	-	-	-	-	-	-	-	-	-
			FADER	B9	07	FAD	END	-	-	-	-	-	-	-	-	-	-	-	-
RM11	CH11	VST MIXER CH11	ON	BA	40	SW	END	-	-	-	-	-	-	-	-	-	-	-	-
			FADER	BA	07	FAD	END	-	-	-	-	-	-	-	-	-	-	-	-
RM12	CH12	VST MIXER CH12	ON	BB	40	SW	END	-	-	-	-	-	-	-	-	-	-	-	-
			FADER	BB	07	FAD	END	-	-	-	-	-	-	-	-	-	-	-	-
RM13	CH13	VST MIXER CH13	ON	BC	40	SW	END	-	-	-	-	-	-	-	-	-	-	-	-
			FADER	BC	07	FAD	END	-	-	-	-	-	-	-	-	-	-	-	-
RM14	CH14	VST MIXER CH14	ON	BD	40	SW	END	-	-	-	-	-	-	-	-	-	-	-	-
			FADER	BD	07	FAD	END	-	-	-	-	-	-	-	-	-	-	-	-
RM15	CH15	VST MIXER CH15	ON	BE	40	SW	END	-	-	-	-	-	-	-	-	-	-	-	-
			FADER	BE	07	FAD	END	-	-	-	-	-	-	-	-	-	-	-	-
RM16	CH16	VST MIXER CH16	ON	BF	40	SW	END	-	-	-	-	-	-	-	-	-	-	-	-
			FADER	BF	07	FAD	END	-	-	-	-	-	-	-	-	-	-	-	-

Effects Parameters

REVERB HALL, REVERB ROOM, REVERB STAGE, REVERB PLATE

One input, two output hall, room, stage, and plate reverb simulations, all with gates.

Parameter	Range	Description
REV TIME	0.3–99.0 s	Reverb time
INI. DLY	0.0–500.0 ms	Initial delay before reverb begins
HI. RATIO	0.1–1.0	High-frequency reverb time ratio
LO. RATIO	0.1–2.4	Low-frequency reverb time ratio
DIFF.	0–10	Reverb diffusion (left–right reverb spread)
DENSITY	0–100%	Reverb density
E/R DLY	0.0–100.0 ms	Delay between early reflections and reverb
E/R BAL.	0–100%	Balance of early reflections and reverb (0% = all reverb, 100% = all early reflections)
HPF	THRU, 21.2 Hz–8.00 kHz	High-pass filter cutoff frequency
LPF	50.0 Hz–16.0 kHz, THRU	Low-pass filter cutoff frequency
GATE LVL	OFF, –60 to 0 dB	Level at which gate kicks in
ATTACK	0–120 ms	Gate opening speed
HOLD	1	Gate open time
DECAY	2	Gate closing speed

- 0.02 ms–2.13 s (fs=44.1 kHz), 0.02 ms–1.96 s (fs=48 kHz), 0.01 ms–1.06 s (fs=88.2 kHz), 0.01 ms–981 ms (fs=96 kHz)
- 6 ms–46.0 s (fs=44.1 kHz), 5 ms–42.3 s (fs=48 kHz), 3 ms–23.0 s (fs=88.2 kHz), 3 ms–21.1 s (fs=96 kHz)

EARLY REF.

One input, two output early reflections.

Parameter	Range	Description
TYPE	S-Hall, L-Hall, Random, Revers, Plate, Spring	Type of early reflection simulation
ROOMSIZE	0.1–20.0	Reflection spacing
LIVENESS	0–10	Early reflections decay characteristics (0 = dead, 10 = live)
INI. DLY	0.0–500.0 ms	Initial delay before reverb begins
DIFF.	0–10	Reflection diffusion (left–right reflection spread)
DENSITY	0–100%	Reflection density
ER NUM.	1–19	Number of early reflections
FB.GAIN	–99 to +99%	Feedback gain
HI. RATIO	0.1–1.0	High-frequency feedback ratio
HPF	THRU, 21.2 Hz–8.00 kHz	High-pass filter cutoff frequency
LPF	50.0 Hz–16.0 kHz, THRU	Low-pass filter cutoff frequency

GATE REVERB, REVERSE GATE

One input, two output early reflections with gate, and early reflections with reverse gate.

Parameter	Range	Description
TYPE	Type-A, Type-B	Type of early reflection simulation
ROOMSIZE	0.1–20.0	Reflection spacing
LIVENESS	0–10	Early reflections decay characteristics (0 = dead, 10 = live)
INI. DLY	0.0–500.0 ms	Initial delay before reverb begins
DIFF.	0–10	Reflection diffusion (left–right reflection spread)
DENSITY	0–100%	Reflection density
HI. RATIO	0.1–1.0	High-frequency feedback ratio
ER NUM.	1–19	Number of early reflections
FB.GAIN	–99 to +99%	Feedback gain
HPF	THRU, 21.2 Hz–8.00 kHz	High-pass filter cutoff frequency
LPF	50.0 Hz–16.0 kHz, THRU	Low-pass filter cutoff frequency

MONO DELAY

One input, two output basic repeat delay.

Parameter	Range	Description
DELAY	0.0–2730.0 ms	Delay time
FB. GAIN	–99 to +99%	Feedback gain (plus values for normal-phase feedback, minus values for reverse-phase feedback)
HI. RATIO	0.1–1.0	High-frequency feedback ratio
HPF	THRU, 21.2 Hz–8.00 kHz	High-pass filter cutoff frequency
LPF	50.0 Hz–16.0 kHz, THRU	Low-pass filter cutoff frequency
SYNC	OFF, ON	Tempo parameter sync on/off
NOTE	1	Used in conjunction with TEMPO to determine DELAY

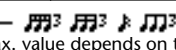
-  Max. value depends on tempo setting)

STEREO DELAY

Two input, two output basic stereo delay.



Parameter	Range	Description
DELAY L	0.0–1350.0 ms	Left channel delay time
DELAY R	0.0–1350.0 ms	Right channel delay time
FB. G L	–99 to +99%	Left channel feedback (plus values for normal-phase feedback, minus values for reverse-phase feedback)
FB. G R	–99 to +99%	Right channel feedback (plus values for normal-phase feedback, minus values for reverse-phase feedback)
HI. RATIO	0.1–1.0	High-frequency feedback ratio
HPF	THRU, 21.2 Hz–8.00 kHz	High-pass filter cutoff frequency
LPF	50.0 Hz–16.0 kHz, THRU	Low-pass filter cutoff frequency
SYNC	OFF, ON	Tempo parameter sync on/off
NOTE L	1	Used in conjunction with TEMPO to determine left channel DELAY
NOTE R	1	Used in conjunction with TEMPO to determine right channel DELAY

1.  (Maximum value depends on the tempo setting)

MOD. DELAY

One input, two output basic repeat delay with modulation.

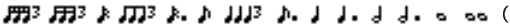
Parameter	Range	Description
DELAY	0.0–2725.0 ms	Delay time
FB. GAIN	–99 to +99%	Feedback gain (plus values for normal-phase feedback, minus values for reverse-phase feedback)
HI. RATIO	0.1–1.0	High-frequency feedback ratio
FREQ.	0.05–40.00 Hz	Modulation speed
DEPTH	0–100%	Modulation depth
WAVE	Sine, Tri	Modulation waveform
HPF	THRU, 21.2 Hz–8.00 kHz	High-pass filter cutoff frequency
LPF	50.0 Hz–16.0 kHz, THRU	Low-pass filter cutoff frequency
SYNC	OFF, ON	Tempo parameter sync on/off
DLY.NOTE	1	Used in conjunction with TEMPO to determine DELAY
MOD.NOTE	2	Used in conjunction with TEMPO to determine FREQ

1.  (Maximum value depends on the tempo setting)
2. 

DELAY LCR

One input, two output 3-tap delay (left, center, right).

Parameter	Range	Description
DELAY L	0.0–2730.0 ms	Left channel delay time
DELAY C	0.0–2730.0 ms	Center channel delay time
DELAY R	0.0–2730.0 ms	Right channel delay time
FB. DLY	0.0–2730.0 ms	Feedback delay time
LEVEL L	–100 to +100%	Left channel delay level
LEVEL C	–100 to +100%	Center channel delay level
LEVEL R	–100 to +100%	Right channel delay level
FB. GAIN	–99 to +99%	Feedback gain (plus values for normal-phase feedback, minus values for reverse-phase feedback)
HI. RATIO	0.1–1.0	High-frequency feedback ratio
HPF	THRU, 21.2 Hz–8.00 kHz	High-pass filter cutoff frequency
LPF	50.0 Hz–16.0 kHz, THRU	Low-pass filter cutoff frequency
SYNC	OFF, ON	Tempo parameter sync on/off
NOTE L	1	Used in conjunction with TEMPO to determine DELAY L
NOTE C	1	Used in conjunction with TEMPO to determine DELAY C
NOTE R	1	Used in conjunction with TEMPO to determine DELAY R
NOTE FB	1	Used in conjunction with TEMPO to determine FB. DLY

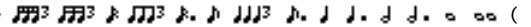
1.  (Maximum value depends on the tempo setting)

ECHO

Two input, two output stereo delay with crossed feedback loop.

Parameter	Range	Description
DELAY L	0.0–1350.0 ms	Left channel delay time
DELAY R	0.0–1350.0 ms	Right channel delay time
FB.DLY L	0.0–1350.0 ms	Left channel feedback delay time
FB.DLY R	0.0–1350.0 ms	Right channel feedback delay time
FB. G L	–99 to +99%	Left channel feedback gain (plus values for normal-phase feedback, minus values for reverse-phase feedback)
FB. G R	–99 to +99%	Right channel feedback gain (plus values for normal-phase feedback, minus values for reverse-phase feedback)
L->R FBG	–99 to +99%	Left to right channel feedback gain (plus values for normal-phase feedback, minus values for reverse-phase feedback)
R->L FBG	–99 to +99%	Right to left channel feedback gain (plus values for normal-phase feedback, minus values for reverse-phase feedback)
HI. RATIO	0.1–1.0	High-frequency feedback ratio
HPF	THRU, 21.2 Hz–8.00 kHz	High-pass filter cutoff frequency
LPF	50.0 Hz–16.0 kHz, THRU	Low-pass filter cutoff frequency
SYNC	OFF, ON	Tempo parameter sync on/off
NOTE L	1	Used in conjunction with TEMPO to determine DELAY L
NOTE R	1	Used in conjunction with TEMPO to determine DELAY R
NOTE FBL	1	Used in conjunction with TEMPO to determine FB.DLY L
NOTE FBR	1	Used in conjunction with TEMPO to determine FB.DLY R

1. (Maximum value depends on the tempo setting)

CHORUS

Two input, two output chorus effect.

Parameter	Range	Description
FREQ.	0.05–40.00 Hz	Modulation speed
AM DEPTH	0–100%	Amplitude modulation depth
PM DEPTH	0–100%	Pitch modulation depth
MOD. DLY	0.0–500.0 ms	Modulation delay time
WAVE	Sine, Tri	Modulation waveform
LSH F	21.2 Hz–8.00 kHz	Low shelving filter frequency
LSH G	–12.0 to +12.0 dB	Low shelving filter gain
EQ F	100 Hz–8.00 kHz	EQ (peaking type) frequency
EQ G	–12.0 to +12.0 dB	EQ (peaking type) gain
EQ Q	10.0–0.10	EQ (peaking type) bandwidth
HSH F	50.0 Hz–16.0 kHz	High shelving filter frequency
HSH G	–12.0 to +12.0 dB	High shelving filter gain
SYNC	OFF, ON	Tempo parameter sync on/off
NOTE	1	Used in conjunction with TEMPO to determine FREQ.

- 1.

FLANGE

Two input, two output flange effect.

Parameter	Range	Description
FREQ.	0.05–40.00 Hz	Modulation speed
DEPTH	0–100%	Modulation depth
MOD. DLY	0.0–500.0 ms	Modulation delay time
FB. GAIN	–99 to +99%	Feedback gain (plus values for normal-phase feedback, minus values for reverse-phase feedback)
WAVE	Sine, Tri	Modulation waveform
LSH F	21.2 Hz–8.00 kHz	Low shelving filter frequency
LSH G	–12.0 to +12.0 dB	Low shelving filter gain
EQ F	100 Hz–8.00 kHz	EQ (peaking type) frequency
EQ G	–12.0 to +12.0 dB	EQ (peaking type) gain
EQ Q	10.0–0.10	EQ (peaking type) bandwidth
HSH F	50.0 Hz–16.0 kHz	High shelving filter frequency
HSH G	–12.0 to +12.0 dB	High shelving filter gain
SYNC	OFF, ON	Tempo parameter sync on/off
NOTE	1	Used in conjunction with TEMPO to determine FREQ.

- 1.

SYMPHONIC

Two input, two output symphonic effect.

Parameter	Range	Description
FREQ.	0.05–40.00 Hz	Modulation speed
DEPTH	0–100%	Modulation depth
MOD. DLY	0.0–500.0 ms	Modulation delay time
WAVE	Sine, Tri	Modulation waveform
LSH F	21.2 Hz–8.00 kHz	Low shelving filter frequency
LSH G	–12.0 to +12.0 dB	Low shelving filter gain
EQ F	100 Hz–8.00 kHz	EQ (peaking type) frequency
EQ G	–12.0 to +12.0 dB	EQ (peaking type) gain
EQ Q	10.0–0.10	EQ (peaking type) bandwidth
HSH F	50.0 Hz–16.0 kHz	High shelving filter frequency
HSH G	–12.0 to +12.0 dB	High shelving filter gain
SYNC	OFF, ON	Tempo parameter sync on/off
NOTE	1	Used in conjunction with TEMPO to determine FREQ.

- 1.

PHASER

Two input, two output 16-stage phaser.

Parameter	Range	Description
FREQ.	0.05–40.00 Hz	Modulation speed
DEPTH	0–100%	Modulation depth
FB. GAIN	–99 to +99%	Feedback gain (plus values for normal-phase feedback, minus values for reverse-phase feedback)
OFFSET	0–100	Lowest phase-shifted frequency offset
PHASE	0.00–354.38 degrees	Left and right modulation phase balance
STAGE	2, 4, 6, 8, 10, 12, 14, 16	Number of phase shift stages
LSH F	21.2 Hz–8.00 kHz	Low shelving filter frequency
LSH G	–12.0 to +12.0 dB	Low shelving filter gain
HSH F	50.0 Hz–16.0 kHz	High shelving filter frequency
HSH G	–12.0 to +12.0 dB	High shelving filter gain
SYNC	OFF, ON	Tempo parameter sync on/off
NOTE	1	Used in conjunction with TEMPO to determine FREQ.

1. (Musical notation showing a sequence of notes with phaser effect symbols.)

AUTO PAN

Two input, two output autopanner.

Parameter	Range	Description
FREQ.	0.05–40.00 Hz	Modulation speed
DEPTH	0–100%	Modulation depth
DIR.	1	Panning direction
WAVE	Sine, Tri, Square	Modulation waveform
LSH F	21.2 Hz–8.00 kHz	Low shelving filter frequency
LSH G	–12.0 to +12.0 dB	Low shelving filter gain
EQ F	100 Hz–8.00 kHz	EQ (peaking type) frequency
EQ G	–12.0 to +12.0 dB	EQ (peaking type) gain
EQ Q	10.0–0.10	EQ (peaking type) bandwidth
HSH F	50.0 Hz–16.0 kHz	High shelving filter frequency
HSH G	–12.0 to +12.0 dB	High shelving filter gain
SYNC	OFF, ON	Tempo parameter sync on/off
NOTE	2	Used in conjunction with TEMPO to determine FREQ.

1. L<->R, L->R, L<-R, Turn L, Turn R
2. (Musical notation showing a sequence of notes with auto pan effect symbols.)

TREMOLO

Two input, two output tremolo effect.

Parameter	Range	Description
FREQ.	0.05–40.00 Hz	Modulation speed
DEPTH	0–100%	Modulation depth
WAVE	Sine, Tri, Square	Modulation waveform
LSH F	21.2 Hz–8.00 kHz	Low shelving filter frequency
LSH G	–12.0 to +12.0 dB	Low shelving filter gain
EQ F	100 Hz–8.00 kHz	EQ (peaking type) frequency
EQ G	–12.0 to +12.0 dB	EQ (peaking type) gain
EQ Q	10.0–0.10	EQ (peaking type) bandwidth
HSH F	50.0 Hz–16.0 kHz	High shelving filter frequency
HSH G	–12.0 to +12.0 dB	High shelving filter gain
SYNC	OFF, ON	Tempo parameter sync on/off
NOTE	1	Used in conjunction with TEMPO to determine FREQ.

1. (Musical notation showing a sequence of notes with tremolo effect symbols.)

HQ. PITCH

One input, two output high-quality pitch shifter (Available for internal effects 1 and 2.).

Parameter	Range	Description
PITCH	–12 to +12 semi-tones	Pitch shift
FINE	–50 to +50 cents	Pitch shift fine
DELAY	0.0–1000.0 ms	Delay time
FB. GAIN	–99 to +99%	Feedback gain (plus values for normal-phase feedback, minus values for reverse-phase feedback)
MODE	1–10	Pitch shift precision
SYNC	OFF, ON	Tempo parameter sync on/off
NOTE	1	Used in conjunction with TEMPO to determine DELAY

1. (Musical notation showing a sequence of notes with HQ pitch effect symbols.)
(Maximum value depends on the tempo setting)

DUAL PITCH

Two input, two output pitch shifter.

Parameter	Range	Description
PITCH 1	–24 to +24 semi-tones	Channel #1 pitch shift
FINE 1	–50 to +50 cents	Channel #1 pitch shift fine
LEVEL 1	–100 to +100%	Channel #1 level (plus values for normal phase, minus values for reverse phase)
PAN 1	L63 to R63	Channel #1 pan
DELAY 1	0.0–1000.0 ms	Channel #1 delay time
FB. G 1	–99 to +99%	Channel #1 feedback gain (plus values for normal-phase feedback, minus values for reverse-phase feedback)
PITCH 2	–24 to +24 semi-tones	Channel #2 pitch shift
FINE 2	–50 to +50 cents	Channel #2 pitch shift fine
LEVEL 2	–100 to +100%	Channel #2 level (plus values for normal phase, minus values for reverse phase)
PAN 2	L63 to R63	Channel #2 pan
DELAY 2	0.0–1000.0 ms	Channel #2 delay time
FB. G 2	–99 to +99%	Channel #2 feedback gain (plus values for normal-phase feedback, minus values for reverse-phase feedback)
MODE	1–10	Pitch shift precision
SYNC	OFF, ON	Tempo parameter sync on/off
NOTE 1	1	Used in conjunction with TEMPO to determine Channel #1 delay
NOTE 2	1	Used in conjunction with TEMPO to determine Channel #2 delay

1. (Musical notation showing a sequence of notes with dual pitch effect symbols.)
(Maximum value depends on the tempo setting)

ROTARY

One input, two output rotary speaker simulator.

Parameter	Range	Description
ROTATE	STOP, START	Rotation stop, start
SPEED	SLOW, FAST	Rotation speed (see SLOW and FAST parameters)
SLOW	0.05–10.00 Hz	SLOW rotation speed
FAST	0.05–10.00 Hz	FAST rotation speed
DRIVE	0–100	Overdrive level
ACCEL	0–10	Acceleration at speed changes
LOW	0–100	Low-frequency filter
HIGH	0–100	High-frequency filter

RING MOD.

Two input, two output ring modulator.

Parameter	Range	Description
SOURCE	OSC, SELF	Modulation source: oscillator or input signal
OSC FREQ	0.0–5000.0 Hz	Oscillator frequency
FM FREQ.	0.05–40.00 Hz	Oscillator frequency modulation speed
FM DEPTH	0–100%	Oscillator frequency modulation depth
SYNC	OFF, ON	Tempo parameter sync on/off
NOTE FM	1	Used in conjunction with TEMPO to determine FM FREQ

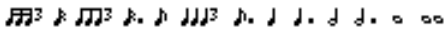
1. 

MOD. FILTER

Two input, two output modulation filter.

Parameter	Range	Description
FREQ.	0.05–40.00 Hz	Modulation speed
DEPTH	0–100%	Modulation depth
PHASE	0.00–354.38 degrees	Left-channel modulation and right-channel modulation phase difference
TYPE	LPF, HPF, BPF	Filter type: low pass, high pass, band pass
OFFSET	0–100	Filter frequency offset
RESO.	0–20	Filter resonance
LEVEL	0–100	Output level
SYNC	OFF, ON	Tempo parameter sync on/off
NOTE	1	Used in conjunction with TEMPO to determine FREQ

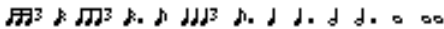
1. 

DISTORTION

One input, two output distortion effect.

Parameter	Range	Description
DST TYPE	DST1, DST2, OVD1, OVD2, CRUNCH	Distortion type (DST = distortion, OVD = overdrive)
DRIVE	0–100	Distortion drive
MASTER	0–100	Master volume
TONE	–10 to +10	Tone
N. GATE	0–20	Noise reduction

AMP SIMULATE

One input, two output guitar amp simulator.

Parameter	Range	Description
AMP TYPE	1	Guitar amp simulation type
DST TYPE	DST1, DST2, OVD1, OVD2, CRUNCH	Distortion type (DST = distortion, OVD = overdrive)
DRIVE	0–100	Distortion drive
MASTER	0–100	Master volume
BASS	0–100	Bass tone control
MIDDLE	0–100	Middle tone control
TREBLE	0–100	High tone control
CAB DEP	0–100%	Speaker cabinet simulation depth
EQ F	100–8.00 kHz	Parametric equalizer frequency
EQ G	–12.0 to +12.0 dB	Parametric equalizer gain
EQ Q	10.0–0.10	Parametric equalizer bandwidth
N. GATE	0–20	Noise reduction

1. STK-M1, STK-M2, THRASH, MIDBST, CMB-PG, CMB-VR, CMB-DX, CMB-TW, MINI, FLAT

DYNA. FILTER

Two input, two output dynamically controlled filter.

Parameter	Range	Description
SOURCE	INPUT, MIDI	Control source: input signal or MIDI Note On velocity
SENSE	0–100	Sensitivity
DIR.	UP, DOWN	Upward or downward frequency change
DECAY	1	Filter frequency change decay speed
TYPE	LPF, HPF, BPF	Filter type
OFFSET	0–100	Filter frequency offset
RESO.	0–20	Filter resonance
LEVEL	0–100	Output Level

1. 6 ms–46.0 s (fs=44.1 kHz), 5 ms–42.3 s (fs=48 kHz), 3 ms–23.0 s (fs=88.2 kHz), 3 ms–21.1 s (fs=96 kHz)

DYNA. FLANGE

Two input, two output dynamically controlled flanger.

Parameter	Range	Description
SOURCE	INPUT, MIDI	Control source: input signal or MIDI Note On velocity
SENSE	0–100	Sensitivity
DIR.	UP, DOWN	Upward or downward frequency change
DECAY	1	Decay speed
OFFSET	0–100	Delay time offset
FB.GAIN	–99 to +99%	Feedback gain (plus values for normal-phase feedback, minus values for reverse-phase feedback)
LSH F	21.2 Hz–8.00 kHz	Low shelving filter frequency
LSH G	–12.0 to +12.0 dB	Low shelving filter gain
EQ F	100 Hz–8.00 kHz	EQ (peaking type) frequency
EQ G	–12.0 to +12.0 dB	EQ (peaking type) gain
EQ Q	10.0–0.10	EQ (peaking type) bandwidth
HSF F	50.0 Hz–16.0 kHz	High shelving filter frequency
HSF G	–12.0 to +12.0 dB	High shelving filter gain

1. 6 ms–46.0 s (fs=44.1 kHz), 5 ms–42.3 s (fs=48 kHz), 3 ms–23.0 s (fs=88.2 kHz), 3 ms–21.1 s (fs=96 kHz)

DYNA. PHASER

Two input, two output dynamically controlled phaser.

Parameter	Range	Description
SOURCE	INPUT, MIDI	Control source: input signal or MIDI Note On velocity
SENSE	0–100	Sensitivity
DIR.	UP, DOWN	Upward or downward frequency change
DECAY	1	Decay speed
OFFSET	0–100	Lowest phase-shifted frequency offset
FB.GAIN	–99 to +99%	Feedback gain (plus values for normal-phase feedback, minus values for reverse-phase feedback)
STAGE	2, 4, 6, 8, 10, 12, 14, 16	Number of phase shift stages
LSH F	21.2 Hz–8.00 kHz	Low shelving filter frequency
LSH G	–12.0 to +12.0 dB	Low shelving filter gain
HSH F	50.0 Hz–16.0 kHz	High shelving filter frequency
HSH G	–12.0 to +12.0 dB	High shelving filter gain

1. 6 ms–46.0 s (fs=44.1 kHz), 5 ms–42.3 s (fs=48 kHz), 3 ms–23.0 s (fs=88.2 kHz), 3 ms–21.1 s (fs=96 kHz)

REV+CHORUS

One input, two output reverb and chorus effects in parallel.

Parameter	Range	Description
REV TIME	0.3–99.0 s	Reverb time
INI. DLY	0.0–500.0 ms	Initial delay before reverb begins
HI. RATIO	0.1–1.0	High-frequency reverb time ratio
DIFF.	0–10	Spread
DENSITY	0–100%	Reverb density
HPF	THRU, 21.2 Hz–8.00 kHz	High-pass filter cutoff frequency
LPF	50.0 Hz–16.0 kHz, THRU	Low-pass filter cutoff frequency
REV/CHO	0–100%	Reverb and chorus balance (0% = all reverb, 100% = all chorus)
FREQ.	0.05–40.00 Hz	Modulation speed
AM DEPTH	0–100%	Amplitude modulation depth
PM DEPTH	0–100%	Pitch modulation depth
MOD. DLY	0.0–500.0 ms	Modulation delay time
WAVE	Sine, Tri	Modulation waveform
SYNC	OFF, ON	Tempo parameter sync on/off
NOTE	1	Used in conjunction with TEMPO to determine FREQ.

- 1.

REV->CHORUS

One input, two output reverb and chorus effects in series.

Parameter	Range	Description
REV TIME	0.3–99.0 s	Reverb time
INI. DLY	0.0–500.0 ms	Initial delay before reverb begins
HI. RATIO	0.1–1.0	High-frequency reverb time ratio
DIFF.	0–10	Spread
DENSITY	0–100%	Reverb density
HPF	THRU, 21.2 Hz–8.00 kHz	High-pass filter cutoff frequency
LPF	50.0 Hz–16.0 kHz, THRU	Low-pass filter cutoff frequency
REV.BAL	0–100%	Reverb and chorused reverb balance (0% = all chorused reverb, 100% = all reverb)
FREQ.	0.05–40.00 Hz	Modulation speed
AM DEPTH	0–100%	Amplitude modulation depth
PM DEPTH	0–100%	Pitch modulation depth
MOD. DLY	0.0–500.0 ms	Modulation delay time
WAVE	Sine, Tri	Modulation waveform
SYNC	OFF, ON	Tempo parameter sync on/off
NOTE	1	Used in conjunction with TEMPO to determine FREQ.

- 1.

REV+FLANGE

One input, two output reverb and flanger effects in parallel.

Parameter	Range	Description
REV TIME	0.3–99.0 s	Reverb time
INI. DLY	0.0–500.0 ms	Initial delay before reverb begins
HI. RATIO	0.1–1.0	High-frequency reverb time ratio
DIFF.	0–10	Spread
DENSITY	0–100%	Reverb density
HPF	THRU, 21.2 Hz–8.00 kHz	High-pass filter cutoff frequency
LPF	50.0 Hz–16.0 kHz, THRU	Low-pass filter cutoff frequency
REV/FLG	0–100%	Reverb and flange balance (0% = all reverb, 100% = all flange)
FREQ.	0.05–40.00 Hz	Modulation speed
DEPTH	0–100%	Modulation depth
MOD. DLY	0.0–500.0 ms	Modulation delay time
FB. GAIN	–99 to +99%	Feedback gain (plus values for normal-phase feedback, minus values for reverse-phase feedback)
WAVE	Sine, Tri	Modulation waveform
SYNC	OFF, ON	Tempo parameter sync on/off
NOTE	1	Used in conjunction with TEMPO to determine FREQ.

- 1.

REV->FLANGE

One input, two output reverb and flanger effects in series.

Parameter	Range	Description
REV TIME	0.3–99.0 s	Reverb time
INI. DLY	0.0–500.0 ms	Initial delay before reverb begins
HI. RATIO	0.1–1.0	High-frequency reverb time ratio
DIFF.	0–10	Spread
DENSITY	0–100%	Reverb density
HPF	THRU, 21.2 Hz–8.00 kHz	High-pass filter cutoff frequency
LPF	50.0 Hz–16.0 kHz, THRU	Low-pass filter cutoff frequency
REV.BAL	0–100%	Reverb and flanged reverb balance (0% = all flanged reverb, 100% = all reverb)
FREQ.	0.05–40.00 Hz	Modulation speed
DEPTH	0–100%	Modulation depth
MOD. DLY	0.0–500.0 ms	Modulation delay time
FB. GAIN	–99 to +99%	Feedback gain (plus values for normal-phase feedback, minus values for reverse-phase feedback)
WAVE	Sine, Tri	Modulation waveform
SYNC	OFF, ON	Tempo parameter sync on/off
NOTE	1	Used in conjunction with TEMPO to determine FREQ.

1.

REV+SYMPHO.

One input, two output reverb and symphonic effects in parallel.

Parameter	Range	Description
REV TIME	0.3–99.0 s	Reverb time
INI. DLY	0.0–500.0 ms	Initial delay before reverb begins
HI. RATIO	0.1–1.0	High-frequency reverb time ratio
DIFF.	0–10	Spread
DENSITY	0–100%	Reverb density
HPF	THRU, 21.2 Hz–8.00 kHz	High-pass filter cutoff frequency
LPF	50.0 Hz–16.0 kHz, THRU	Low-pass filter cutoff frequency
REV/SYM	0–100%	Reverb and symphonic balance (0% = all reverb, 100% = all symphonic)
FREQ.	0.05–40.00 Hz	Modulation speed
DEPTH	0–100%	Modulation depth
MOD. DLY	0.0–500.0 ms	Modulation delay time
WAVE	Sine, Tri	Modulation waveform
SYNC	OFF, ON	Tempo parameter sync on/off
NOTE	1	Used in conjunction with TEMPO to determine FREQ.

1.

REV->SYMPHO.

One input, two output reverb and symphonic effects in series.

Parameter	Range	Description
REV TIME	0.3–99.0 s	Reverb time
INI. DLY	0.0–500.0 ms	Initial delay before reverb begins
HI. RATIO	0.1–1.0	High-frequency reverb time ratio
DIFF.	0–10	Spread
DENSITY	0–100%	Reverb density
HPF	THRU, 21.2 Hz–8.00 kHz	High-pass filter cutoff frequency
LPF	50.0 Hz–16.0 kHz, THRU	Low-pass filter cutoff frequency
REV.BAL	0–100%	Reverb and symphonic reverb balance (0% = all symphonic reverb, 100% = all reverb)
FREQ.	0.05–40.00 Hz	Modulation speed
DEPTH	0–100%	Modulation depth
MOD. DLY	0.0–500.0 ms	Modulation delay time
WAVE	Sine, Tri	Modulation waveform
SYNC	OFF, ON	Tempo parameter sync on/off
NOTE	1	Used in conjunction with TEMPO to determine FREQ.

1.

REV->PAN

One input, two output reverb and autopan effects in parallel.

Parameter	Range	Description
REV TIME	0.3–99.0 s	Reverb time
INI. DLY	0.0–500.0 ms	Initial delay before reverb begins
HI. RATIO	0.1–1.0	High-frequency reverb time ratio
DIFF.	0–10	Spread
DENSITY	0–100%	Reverb density
HPF	THRU, 21.2 Hz–8.00 kHz	High-pass filter cutoff frequency
LPF	50.0 Hz–16.0 kHz, THRU	Low-pass filter cutoff frequency
REV.BAL	0–100%	Reverb and panned reverb balance (0% = all panned reverb, 100% = all reverb)
FREQ.	0.05–40.00 Hz	Modulation speed
DEPTH	0–100%	Modulation depth
DIR.	1	Panning direction
WAVE	Sine, Tri, Square	Modulation waveform
SYNC	OFF, ON	Tempo parameter sync on/off
NOTE	2	Used in conjunction with TEMPO to determine FREQ.

1. L<->R, L->R, L<-R, Turn L, Turn R

2.

DELAY+ER.

One input, two output delay and early reflections effects in parallel.

Parameter	Range	Description
DELAY L	0.0–1000.0 ms	Left channel delay time
DELAY R	0.0–1000.0 ms	Right channel delay time
FB. DLY	0.0–1000.0 ms	Feedback delay time
FB. GAIN	–99 to +99%	Feedback gain (plus values for normal-phase feedback, minus values for reverse-phase feedback)
HI. RATIO	0.1–1.0	High-frequency feedback ratio
HPF	THRU, 21.2 Hz–8.00 kHz	High-pass filter cutoff frequency
LPF	50.0 Hz–16.0 kHz, THRU	Low-pass filter cutoff frequency
DLY/ER	0–100%	Delay and early reflections balance (0% = all delay, 100% = all early reflections)
TYPE	S-Hall, L-Hall, Random, Revers, Plate, Spring	Type of early reflection simulation
ROOMSIZE	0.1–20.0	Reflection spacing
LIVENESS	0–10	Early reflections decay characteristics (0 = dead, 10 = live)
INI. DLY	0.0–500.0 ms	Initial delay before reverb begins
DIFF.	0–10	Spread
DENSITY	0–100%	Reverb density
ER NUM.	1–19	Number of early reflections
SYNC	OFF, ON	Tempo parameter sync on/off
NOTE L	1	Used in conjunction with TEMPO to determine left channel DELAY L
NOTE R	1	Used in conjunction with TEMPO to determine right channel DELAY R
NOTE FB	1	Used in conjunction with TEMPO to determine FB. DLY

1.  (Maximum value depends on the tempo setting)

DELAY->ER.

One input, two output delay and early reflections effects in series.

Parameter	Range	Description
DELAY L	0.0–1000.0 ms	Left channel delay time
DELAY R	0.0–1000.0 ms	Right channel delay time
FB. DLY	0.0–1000.0 ms	Feedback delay time
FB. GAIN	–99 to +99%	Feedback gain (plus values for normal-phase feedback, minus values for reverse-phase feedback)
HI. RATIO	0.1–1.0	High-frequency feedback ratio
HPF	THRU, 21.2 Hz–8.00 kHz	High-pass filter cutoff frequency
LPF	50.0 Hz–16.0 kHz, THRU	Low-pass filter cutoff frequency
DLY.BAL	0–100%	Delay and early reflected delay balance (0% = all early reflected delay, 100% = all delay)
TYPE	S-Hall, L-Hall, Random, Revers, Plate, Spring	Type of early reflection simulation
ROOMSIZE	0.1–20.0	Reflection spacing
LIVENESS	0–10	Early reflections decay characteristics (0 = dead, 10 = live)
INI. DLY	0.0–500.0 ms	Initial delay before reverb begins
DIFF.	0–10	Spread
DENSITY	0–100%	Reverb density
ER NUM.	1–19	Number of early reflections
SYNC	OFF, ON	Tempo parameter sync on/off
NOTE L	1	Used in conjunction with TEMPO to determine left channel DELAY L
NOTE R	1	Used in conjunction with TEMPO to determine right channel DELAY R
NOTE FB	1	Used in conjunction with TEMPO to determine FB. DLY

1.  (Maximum value depends on the tempo setting)

DELAY+REV

One input, two output delay and reverb effects in parallel.

Parameter	Range	Description
DELAY L	0.0–1000.0 ms	Left channel delay time
DELAY R	0.0–1000.0 ms	Right channel delay time
FB. DLY	0.0–1000.0 ms	Feedback delay time
FB. GAIN	–99 to +99%	Feedback gain (plus values for normal-phase feedback, minus values for reverse-phase feedback)
DELAY HI	0.1–1.0	Delay high-frequency feedback ratio
HPF	THRU, 21.2 Hz–8.00 kHz	High-pass filter cutoff frequency
LPF	50.0 Hz–16.0 kHz, THRU	Low-pass filter cutoff frequency
DLY.BAL	0–100%	Delay and reverb balance (0% = all delay, 100% = all reverb)
REV TIME	0.3–99.0 s	Reverb time
INI. DLY	0.0–500.0 ms	Initial delay before reverb begins
REV HI	0.1–1.0	High-frequency reverb time ratio
DIFF.	0–10	Spread
DENSITY	0–100%	Reverb density
SYNC	OFF, ON	Tempo parameter sync on/off
NOTE L	1	Used in conjunction with TEMPO to determine left channel DELAY L
NOTE R	1	Used in conjunction with TEMPO to determine right channel DELAY R
NOTE FB	1	Used in conjunction with TEMPO to determine FB. DLY

1. (Maximum value depends on the tempo setting)

DELAY->REV

One input, two output delay and reverb effects in series.

Parameter	Range	Description
DELAY L	0.0–1000.0 ms	Left channel delay time
DELAY R	0.0–1000.0 ms	Right channel delay time
FB. DLY	0.0–1000.0 ms	Feedback delay time
FB. GAIN	–99 to +99%	Feedback gain (plus values for normal-phase feedback, minus values for reverse-phase feedback)
DELAY HI	0.1–1.0	Delay high-frequency feedback ratio
HPF	THRU, 21.2 Hz–8.00 kHz	High-pass filter cutoff frequency
LPF	50.0 Hz–16.0 kHz, THRU	Low-pass filter cutoff frequency
DLY.BAL	0–100%	Delay and delayed reverb balance (0% = all delayed reverb, 100% = all delay)
REV TIME	0.3–99.0 s	Reverb time
INI. DLY	0.0–500.0 ms	Initial delay before reverb begins
REV HI	0.1–1.0	High-frequency reverb time ratio
DIFF.	0–10	Spread
DENSITY	0–100%	Reverb density
SYNC	OFF, ON	Tempo parameter sync on/off

Parameter	Range	Description
NOTE L	1	Used in conjunction with TEMPO to determine left channel DELAY L
NOTE R	*1	Used in conjunction with TEMPO to determine right channel DELAY R
NOTE FB	*1	Used in conjunction with TEMPO to determine FB. DLY

1. (Maximum value depends on the tempo setting)

DIST->DELAY

One input, two output distortion and delay effects in series.

Parameter	Range	Description
DST TYPE	DST1, DST2, OVD1, OVD2, CRUNCH	Distortion type (DST = distortion, OVD = overdrive)
DRIVE	0–100	Distortion drive
MASTER	0–100	Master volume
STONE	–10 to +10	Tone control
N. GATE	0–20	Noise reduction
DELAY	0.0–2725.0 ms	Delay time
FB. GAIN	–99 to +99%	Feedback gain (plus values for normal-phase feedback, minus values for reverse-phase feedback)
HI. RATIO	0.1–1.0	High-frequency feedback ratio
FREQ.	0.05–40.00 Hz	Modulation speed
DEPTH	0–100%	Modulation depth
DLY.BAL	0–100%	Distortion and delay balance (0% = all distortion, 100% = all delayed distortion)
SYNC	OFF, ON	Tempo parameter sync on/off
DLY.NOTE	1	Used in conjunction with TEMPO to determine DELAY
MOD.NOTE	2	Used in conjunction with TEMPO to determine FREQ.

1. (Maximum value depends on the tempo setting)

2. (Maximum value depends on the tempo setting)

MULTI FILTER

Two input, two output 3-band multi-filter (24 dB/octave).

Parameter	Range	Description
TYPE 1	HPF, LPF, BPF	Filter 1 type: high pass, low pass, band pass
TYPE 2	HPF, LPF, BPF	Filter 2 type: high pass, low pass, band pass
TYPE 3	HPF, LPF, BPF	Filter 3 type: high pass, low pass, band pass
FREQ. 1	28.0 Hz–16.0 kHz	Filter 1 frequency
FREQ. 2	28.0 Hz–16.0 kHz	Filter 2 frequency
FREQ. 3	28.0 Hz–16.0 kHz	Filter 3 frequency
LEVEL 1	0–100	Filter 1 level
LEVEL 2	0–100	Filter 2 level
LEVEL 3	0–100	Filter 3 level
RESO. 1	0–20	Filter 1 resonance
RESO. 2	0–20	Filter 2 resonance
RESO. 3	0–20	Filter 3 resonance

FREEZE

One input, one output basic sampler (Available for internal effects 1 and 2.).

Parameter	Range	Description
REC MODE	MANUAL, INPUT	In MANUAL mode, recording is started by pressing the REC and PLAY buttons. In INPUT mode, Record-Ready mode is engaged by pressing the REC button, and actual recording is triggered by the input signal.
REC DLY	-1000 to +1000 ms	Recording delay. For plus values, recording starts after the trigger is received. For minus values, recording starts before the trigger is received.
TRG LVL	-60 to 0 dB	Input trigger level (i.e., the signal level required to trigger recording or playback)
TRG MASK	0-1000 ms	Once playback has been triggered, subsequent triggers are ignored for the duration of the TRG MASK time.
PLY MODE	MOMENT, CONTL., INPUT	In MOMENT mode, the sample plays only while the that the PLAY button is pressed. In CONTL mode, playback continues once the PLAY button has been pressed. The number of times the sample plays is set using the LOOP NUM parameter. In INPUT mode, playback is triggered by the input signal.
START	1	Playback start point in milliseconds
END	1	Playback end point in milliseconds
LOOP	1	Loop start point in milliseconds
LOOP NUM	0-100	Number of times the sample plays
START [SAMPLE]	2	Playback start point in samples
END [SAMPLE]	2	Playback end point in samples
LOOP [SAMPLE]	2	Loop start point in samples
PITCH	-12 to +12 semi-tones	Playback pitch shift
FINE	-50 to +50 cents	Playback pitch shift fine
MIDI TRG	OFF, C1-C6, ALL	PLAY button can be triggered by using MIDI Note on/off messages.

- 0.0-2970.5 ms (fs=44.1 kHz), 0.0-2729.2 ms (fs=48 kHz), 0.0-2970.5 ms (fs=88.2 kHz), 0.0-2729.2 ms (fs=96 kHz)
- 0-131000 (fs=44.1 kHz, 48 kHz), 0-262000 (fs=88.2 kHz, 96 kHz)

ST REVERB

Two input, two output stereo reverb.

Parameter	Range	Description
REV TIME	0.3-99.0 s	Reverb time
REV TYPE	Hall, Room, Stage, Plate	Reverb type
INI. DLY	0.0-100.0 ms	Initial delay before reverb begins
HI. RATIO	0.1-1.0	High-frequency reverb time ratio
LO. RATIO	0.1-2.4	Low-frequency reverb time ratio
DIFF.	0-10	Reverb diffusion (left-right reverb spread)
DENSITY	0-100%	Reverb density
E/R BAL.	0-100%	Balance of early reflections and reverb (0% = all reverb, 100% = all early reflections)

Parameter	Range	Description
HPF	THRU, 21.2 Hz-8.00 kHz	High-pass filter cutoff frequency
LPF	50.0 Hz-16.0 kHz, THRU	Low-pass filter cutoff frequency

M.BAND DYNA.

Two input, two output 3-band dynamics processor, with individual solo and gain reduction metering for each band.

Parameter	Range	Description
LOW GAIN	-96.0 to +12.0 dB	Low band level
MID GAIN	-96.0 to +12.0 dB	Mid band level
HI. GAIN	-96.0 to +12.0 dB	High band level
PRESENCE	-10 to +10	For positive values, the threshold of the high band is lowered and the threshold of the low band is increased. For negative values, the opposite will occur. When set to 0, all three bands are affected the same.
CMP. THRE	24.0 to 0.0 dB	Compressor threshold
CMP. RAT	1:1 to 20:1	Compressor ratio
CMP. ATK	0-120 ms	Compressor attack
CMP. REL	1	Compressor release time
CMP. KNEE	0-5	Compressor knee
LOOKUP	0.0-100.0 ms	Lookup delay
CMP. BYP	OFF, ON	Compressor bypass
L-M XOVR	21.2 Hz-8.00 kHz	Low/mid crossover frequency
M-H XOVR	21.2 Hz-8.00 kHz	Mid/high crossover frequency
SLOPE	-6 to -12 dB	Filter slope
CEILING	-6.0 to 0.0 dB, OFF	Specifies the maximum output level
EXP. THRE	-54.0 to -24.0 dB	Expander threshold
EXP. RAT	1:1 to ∞:1	Expander ratio
EXP. REL	1	Expander release time
EXP. BYP	OFF, ON	Expander bypass
LIM. THRE	-12.0 to 0.0 dB	Limiter threshold
LIM. ATK	0-120 ms	Limiter attack
LIM. REL	1	Limiter release time
LIM. BYP	OFF, ON	Limiter bypass
LIM. KNEE	0-5	Limiter knee
SOLO LOW	OFF, ON	If this is on, only the low-frequency band will be output.
SOLO MID	OFF, ON	If this is on, only the mid-frequency band will be output.
SOLO HIGH	OFF, ON	If this is on, only the high-frequency band will be output.

- 6 ms-46.0 s (fs=44.1 kHz), 5 ms-42.3 s (fs=48 kHz), 3 ms-23.0 s (fs=88.2 kHz), 3 ms-21.1 s (fs=96 kHz)

Other preset effects (COMP276, COMP276S, COMP260, COMP260S, EQUALIZER601, OPEN-DECK, REV-X HALL, REV-X ROOM, REV-X PLATE) are optional Add-On Effects. For more information on these effects, refer to the Owner's Manual that came with the Add-On Effects packages.

Effects and tempo synchronization

Some of the 01V96's effects allow you to synchronize the effect with the tempo. There are two such types of effect; delay-type effects and modulation-type effects. For delay-type effects, the delay time will change according to the tempo. For modulation-type effects, the frequency of the modulation signal will change according to the tempo.

Parameters related to tempo synchronization

The following five parameters are related to tempo synchronization.

- 1) SYNC 2) NOTE 3) TEMPO 4) DELAY 5) FREQ.

SYNC:.....This is the on/off switch for tempo synchronization.

NOTE and TEMPO:These are the basic parameters for tempo synchronization.

DELAY and FREQ.:DELAY is the delay time, and FREQ. is the frequency of the modulation signal. These directly affect the way in which the effect sound will change. DELAY is relevant only for delay-type effects, and FREQ. is relevant only for modulation-type effects.

How the parameters are related

Tempo synchronization uses TEMPO and NOTE to calculate a value that will be the basis for the tempo, and continues making adjustments so that this tempo basis stays essentially the same as the DELAY (or FREQ.). This means that when TEMPO, NOTE, and DELAY (or FREQ.) are synchronized, and you change any of these values, the other parameters will be re-set in order to maintain the correct relationship. The parameters that are re-set and the calculation method(*a) used are as follows.

If you turn SYNC on → NOTE will be set

If you edit DELAY (or FREQ.) → NOTE will be set

In this case, the NOTE value is calculated as follows.

$$\text{NOTE} = \text{DELAY (or FREQ.)} / (4 \times (60/\text{TEMPO}))$$

If you edit NOTE → DELAY (or FREQ.) will be set

In this case, the DELAY (or FREQ.) value is calculated as follows.

$$\text{DELAY (or FREQ.)} = \text{NOTE} \times 4 \times (60/\text{TEMPO})$$

If you edit TEMPO → DELAY (or FREQ.) will be set

In this case, the DELAY (or FREQ.) value is calculated as follows.

$$\text{DELAY (or FREQ.)} = \text{original DELAY (or FREQ.)} \times (\text{previous TEMPO/new TEMPO})$$

Example 1: When SYNC=ON, DELAY=250 ms, TEMPO=120, you change NOTE from 8th note to quarter note

$$\begin{aligned} \text{DELAY} &= \text{new NOTE} \times 4 \times (60/\text{TEMPO}) \\ &= (1/4) \times 4 \times (60/120) \\ &= 0.5 \text{ (sec)} \\ &= 500 \text{ ms} \end{aligned}$$

Thus, the DELAY will change from 250 ms to 500 ms.

Example 2: When SYNC=ON, DELAY=250 ms, NOTE=8th note, you change TEMPO from 120 to 121

$$\begin{aligned} \text{DELAY} &= \text{original DELAY} \times (\text{previous TEMPO/new TEMPO}) \\ &= 250 \times (120/121) \\ &= 247.9 \text{ (ms)} \end{aligned}$$

Thus, the TEMPO will change from 250 ms to 247.9 ms.

*a Rounded values are used for the calculation results.

Ranges of the NOTE and TEMPO values

The ranges of the NOTE and TEMPO values are limited by the ranges of the DELAY or FREQ. values. You cannot set NOTE or TEMPO values that would cause DELAY or FREQ. to exceed their maximum possible values when synchronized to tempo. This limitation also applies even when SYNC is OFF.

Special characteristics of the TEMPO parameter

The TEMPO parameter has the following characteristics that are unlike other parameters.

- It is a common value shared by all effects
- You cannot store it to or recall it from the Effects Library. (You can store it to and recall it from a Scene.)

This means that the TEMPO value may not necessarily be the same when an effect is recalled as when that effect was stored. Here is an example.

Store the effect: TEMPO=120 → Change TEMPO to 60 → Recall the effect: TEMPO=60

Normally when you change the TEMPO, the DELAY (or FREQ.) will be re-set accordingly. However if the DELAY (or FREQ.) were changed, the effect would sound differently when recalled than when it was stored. To prevent the effect from changing in this way between store and recall, the 01V96 does not update the DELAY (or FREQ.) value when an effect is recalled, even if the TEMPO is no longer the same as when that effect was stored.

* The NOTE parameter is calculated based on the following values.

= 1/48	= 1/24	= 1/16	= 1/12	= 3/32	= 1/8	= 1/6
= 3/16	= 1/4	= 3/8	= 1/2	= 3/4	= 1/1	= 2/1

Preset EQ Parameters

#	Title	Parameter				
		LOW	L-MID	H-MID	HIGH	
01	Bass Drum 1		PEAKING	PEAKING	PEAKING	H.SHELF
		G	+3.5 dB	-3.5 dB	0.0 dB	+4.0 dB
		F	100 Hz	265 Hz	1.06 kHz	5.30 kHz
		Q	1.2	10	0.9	—
02	Bass Drum 2		PEAKING	PEAKING	PEAKING	LPF
		G	+8.0 dB	-7.0 dB	+6.0 dB	ON
		F	80 Hz	400 Hz	2.50 kHz	12.5 kHz
		Q	1.4	4.5	2.2	—
03	Snare Drum 1		PEAKING	PEAKING	PEAKING	H.SHELF
		G	-0.5 dB	0.0 dB	+3.0 dB	+4.5 dB
		F	132 Hz	1.00 kHz	3.15 kHz	5.00 kHz
		Q	1.2	4.5	0.11	—
04	Snare Drum 2		L.SHELF	PEAKING	PEAKING	PEAKING
		G	+1.5 dB	-8.5 dB	+2.5 dB	+4.0 dB
		F	180 Hz	335 Hz	2.36 kHz	4.00 kHz
		Q	—	10	0.7	0.1
05	Tom-tom 1		PEAKING	PEAKING	PEAKING	PEAKING
		G	+2.0 dB	-7.5 dB	+2.0 dB	+1.0 dB
		F	212 Hz	670 Hz	4.50 kHz	6.30 kHz
		Q	1.4	10	1.2	0.28
06	Cymbal		L.SHELF	PEAKING	PEAKING	H.SHELF
		G	-2.0 dB	0.0 dB	0.0 dB	+3.0 dB
		F	106 Hz	425 Hz	1.06 kHz	13.2 kHz
		Q	—	8	0.9	—
07	High Hat		L.SHELF	PEAKING	PEAKING	H.SHELF
		G	-4.0 dB	-2.5 dB	+1.0 dB	+0.5 dB
		F	95 Hz	425 Hz	2.80 kHz	7.50 kHz
		Q	—	0.5	1	—
08	Percussion		L.SHELF	PEAKING	PEAKING	H.SHELF
		G	-4.5 dB	0.0 dB	+2.0 dB	0.0 dB
		F	100 Hz	400 Hz	2.80 kHz	17.0 kHz
		Q	—	4.5	0.56	—
09	E. Bass 1		L.SHELF	PEAKING	PEAKING	H.SHELF
		G	-7.5 dB	+4.5 dB	+2.5 dB	0.0 dB
		F	35.5 Hz	112 Hz	2.00 kHz	4.00 kHz
		Q	—	5	4.5	—
10	E. Bass 2		PEAKING	PEAKING	PEAKING	H.SHELF
		G	+3.0 dB	0.0 dB	+2.5 dB	+0.5 dB
		F	112 Hz	112 Hz	2.24 kHz	4.00 kHz
		Q	0.1	5	6.3	—
11	Syn. Bass 1		PEAKING	PEAKING	PEAKING	H.SHELF
		G	+3.5 dB	+8.5 dB	0.0 dB	0.0 dB
		F	85 Hz	950 Hz	4.00 kHz	12.5 kHz
		Q	0.1	8	4.5	—
12	Syn. Bass 2		PEAKING	PEAKING	PEAKING	H.SHELF
		G	+2.5 dB	0.0 dB	+1.5 dB	0.0 dB
		F	125 Hz	180 Hz	1.12 kHz	12.5 kHz
		Q	1.6	8	2.2	—
13	Piano 1		L.SHELF	PEAKING	PEAKING	H.SHELF
		G	-6.0 dB	0.0 dB	+2.0 dB	+4.0 dB
		F	95 Hz	950 Hz	3.15 kHz	7.50 kHz
		Q	—	8	0.9	—

#	Title	Parameter				
		LOW	L-MID	H-MID	HIGH	
14	Piano 2		PEAKING	PEAKING	PEAKING	H.SHELF
		G	+3.5 dB	-8.5 dB	+1.5 dB	+3.0 dB
		F	224 Hz	600 Hz	3.15 kHz	5.30 kHz
		Q	5.6	10	0.7	—
15	E. G. Clean		PEAKING	PEAKING	PEAKING	H.SHELF
		G	+2.0 dB	-5.5 dB	+0.5 dB	+2.5 dB
		F	265 Hz	400 Hz	1.32 kHz	4.50 kHz
		Q	0.18	10	6.3	—
16	E. G. Crunch 1		PEAKING	PEAKING	PEAKING	PEAKING
		G	+4.5 dB	0.0 dB	+4.0 dB	+2.0 dB
		F	140 Hz	1.00 kHz	1.90 kHz	5.60 kHz
		Q	8	4.5	0.63	9
17	E. G. Crunch 2		PEAKING	PEAKING	PEAKING	H.SHELF
		G	+2.5 dB	+1.5 dB	+2.5 dB	0.0 dB
		F	125 Hz	450 Hz	3.35 kHz	19.0 kHz
		Q	8	0.4	0.16	—
18	E. G. Dist. 1		L.SHELF	PEAKING	PEAKING	H.SHELF
		G	+5.0 dB	0.0 dB	+3.5 dB	0.0 dB
		F	355 Hz	950 Hz	3.35 kHz	12.5 kHz
		Q	—	9	10	—
19	E. G. Dist. 2		L.SHELF	PEAKING	PEAKING	H.SHELF
		G	+6.0 dB	-8.5 dB	+4.5 dB	+4.0 dB
		F	315 Hz	1.06 kHz	4.25 kHz	12.5 kHz
		Q	—	10	4	—
20	A. G. Stroke 1		PEAKING	PEAKING	PEAKING	H.SHELF
		G	-2.0 dB	0.0 dB	+1.0 dB	+4.0 dB
		F	106 Hz	1.00 kHz	1.90 kHz	5.30 kHz
		Q	0.9	4.5	3.5	—
21	A. G. Stroke 2		L.SHELF	PEAKING	PEAKING	H.SHELF
		G	-3.5 dB	-2.0 dB	0.0 dB	+2.0 dB
		F	300 Hz	750 Hz	2.00 kHz	3.55 kHz
		Q	—	9	4.5	—
22	A. G. Arpeg. 1		L.SHELF	PEAKING	PEAKING	PEAKING
		G	-0.5 dB	0.0 dB	0.0 dB	+2.0 dB
		F	224 Hz	1.00 kHz	4.00 kHz	6.70 kHz
		Q	—	4.5	4.5	0.12
23	A. G. Arpeg. 2		L.SHELF	PEAKING	PEAKING	H.SHELF
		G	0.0 dB	-5.5 dB	0.0 dB	+4.0 dB
		F	180 Hz	355 Hz	4.00 kHz	4.25 kHz
		Q	—	7	4.5	—
24	Brass Sec.		PEAKING	PEAKING	PEAKING	PEAKING
		G	-2.0 dB	-1.0 dB	+1.5 dB	+3.0 dB
		F	90 Hz	850 Hz	2.12 kHz	4.50 kHz
		Q	2.8	2	0.7	7
25	Male Vocal 1		PEAKING	PEAKING	PEAKING	PEAKING
		G	-0.5 dB	0.0 dB	+2.0 dB	+3.5 dB
		F	190 Hz	1.00 kHz	2.00 kHz	6.70 kHz
		Q	0.11	4.5	0.56	0.11
26	Male Vocal 2		PEAKING	PEAKING	PEAKING	H.SHELF
		G	+2.0 dB	-5.0 dB	-2.5 dB	+4.0 dB
		F	170 Hz	236 Hz	2.65 kHz	6.70 kHz
		Q	0.11	10	5.6	—

#	Title	Parameter				
		LOW	L-MID	H-MID	HIGH	
27	Female Vo. 1		PEAKING	PEAKING	PEAKING	PEAKING
		G	-1.0 dB	+1.0 dB	+1.5 dB	+2.0 dB
		F	118 Hz	400 Hz	2.65 kHz	6.00 kHz
		Q	0.18	0.45	0.56	0.14
28	Female Vo. 2		L.SHELF	PEAKING	PEAKING	H.SHELF
		G	-7.0 dB	+1.5 dB	+1.5 dB	+2.5 dB
		F	112 Hz	335 Hz	2.00 kHz	6.70 kHz
		Q	—	0.16	0.2	—
29	Chorus & Harmo		PEAKING	PEAKING	PEAKING	PEAKING
		G	-2.0 dB	-1.0 dB	+1.5 dB	+3.0 dB
		F	90 Hz	850 Hz	2.12 kHz	4.50 kHz
		Q	2.8	2	0.7	7
30	Total EQ 1		PEAKING	PEAKING	PEAKING	H.SHELF
		G	-0.5 dB	0.0 dB	+3.0 dB	+6.5 dB
		F	95 Hz	950 Hz	2.12 kHz	16.0 kHz
		Q	7	2.2	5.6	—
31	Total EQ 2		PEAKING	PEAKING	PEAKING	H.SHELF
		G	+4.0 dB	+1.5 dB	+2.0 dB	+6.0 dB
		F	95 Hz	750 Hz	1.80 kHz	18.0 kHz
		Q	7	2.8	5.6	—
32	Total EQ 3		L.SHELF	PEAKING	PEAKING	H.SHELF
		G	+1.5 dB	+0.5 dB	+2.0 dB	+4.0 dB
		F	67 Hz	850 Hz	1.90 kHz	15.0 kHz
		Q	—	0.28	0.7	—
33	Bass Drum 3		PEAKING	PEAKING	PEAKING	PEAKING
		G	+3.5 dB	-10.0 dB	+3.5 dB	0.0 dB
		F	118 Hz	315 Hz	4.25 kHz	20.0 kHz
		Q	2	10	0.4	0.4
34	Snare Drum 3		L.SHELF	PEAKING	PEAKING	PEAKING
		G	0.0 dB	+2.0 dB	+3.5 dB	0.0 dB
		F	224 Hz	560 Hz	4.25 kHz	4.00 kHz
		Q	—	4.5	2.8	0.1
35	Tom-tom 2		L.SHELF	PEAKING	PEAKING	H.SHELF
		G	-9.0 dB	+1.5 dB	+2.0 dB	0.0 dB
		F	90 Hz	212 Hz	5.30 kHz	17.0 kHz
		Q	—	4.5	1.2	—
36	Piano 3		PEAKING	PEAKING	PEAKING	H.SHELF
		G	+4.5 dB	-13.0 dB	+4.5 dB	+2.5 dB
		F	100 Hz	475 Hz	2.36 kHz	10.0 kHz
		Q	8	10	9	—
37	Piano Low		PEAKING	PEAKING	PEAKING	H.SHELF
		G	-5.5 dB	+1.5 dB	+6.0 dB	0.0 dB
		F	190 Hz	400 Hz	6.70 kHz	12.5 kHz
		Q	10	6.3	2.2	—
38	Piano High		PEAKING	PEAKING	PEAKING	PEAKING
		G	-5.5 dB	+1.5 dB	+5.0 dB	+3.0 dB
		F	190 Hz	400 Hz	6.70 kHz	5.60 kHz
		Q	10	6.3	2.2	0.1
39	Fine-EQ Cass		L.SHELF	PEAKING	PEAKING	H.SHELF
		G	-1.5 dB	0.0 dB	+1.0 dB	+3.0 dB
		F	75 Hz	1.00 kHz	4.00 kHz	12.5 kHz
		Q	—	4.5	1.8	—
40	Narrator		PEAKING	PEAKING	PEAKING	H.SHELF
		G	-4.0 dB	-1.0 dB	+2.0 dB	0.0 dB
		F	106 Hz	710 Hz	2.50 kHz	10.0 kHz
		Q	4	7	0.63	—

Preset Gate Parameters

(fs = 44.1 kHz)

#	Title	Type	Parameter	Value
1	Gate	GATE	Threshold (dB)	-26
			Range (dB)	-56
			Attack (ms)	0
			Hold (ms)	2.56
			Decay (ms)	331
2	Ducking	DUCKING	Threshold (dB)	-19
			Range (dB)	-22
			Attack (ms)	93
			Hold (ms)	1.20 S
			Decay (ms)	6.32 S
3	A. Dr. BD	GATE	Threshold (dB)	-11
			Range (dB)	-53
			Attack (ms)	0
			Hold (ms)	1.93
			Decay (ms)	400
4	A. Dr. SN	GATE	Threshold (dB)	-8
			Range (dB)	-23
			Attack (ms)	1
			Hold (ms)	0.63
			Decay (ms)	238

Preset Compressor Parameters (fs = 44.1 kHz)

#	Title	Type	Parameter	Value
1	Comp	COMP	Threshold (dB)	-8
			Ratio (:1)	2.5
			Attack (ms)	60
			Out gain (dB)	0.0
			Knee	2
			Release (ms)	250
2	Expand	EXPAND	Threshold (dB)	-23
			Ratio (:1)	1.7
			Attack (ms)	1
			Out gain (dB)	3.5
			Knee	2
			Release (ms)	70
3	Compander (H)	COMPAND-H	Threshold (dB)	-10
			Ratio (:1)	3.5
			Attack (ms)	1
			Out gain (dB)	0.0
			Width (dB)	6
			Release (ms)	250
4	Compander (S)	COMPAND-S	Threshold (dB)	-8
			Ratio (:1)	4
			Attack (ms)	25
			Out gain (dB)	0.0
			Width (dB)	24
			Release (ms)	180
5	A. Dr. BD	COMP	Threshold (dB)	-24
			Ratio (:1)	3
			Attack (ms)	9
			Out gain (dB)	5.5
			Knee	2
			Release (ms)	58
6	A. Dr. BD	COMPAND-H	Threshold (dB)	-11
			Ratio (:1)	3.5
			Attack (ms)	1
			Out gain (dB)	-1.5
			Width (dB)	7
			Release (ms)	192
7	A. Dr. SN	COMP	Threshold (dB)	-17
			Ratio (:1)	2.5
			Attack (ms)	8
			Out gain (dB)	3.5
			Knee	2
			Release (ms)	12
8	A. Dr. SN	EXPAND	Threshold (dB)	-23
			Ratio (:1)	2
			Attack (ms)	0
			Out gain (dB)	0.5
			Knee	2
			Release (ms)	151
9	A. Dr. SN	COMPAND-S	Threshold (dB)	-8
			Ratio (:1)	1.7
			Attack (ms)	11
			Out gain (dB)	0.0
			Width (dB)	10
			Release (ms)	128
10	A. Dr. Tom	EXPAND	Threshold (dB)	-20
			Ratio (:1)	2
			Attack (ms)	2
			Out gain (dB)	5.0
			Knee	2
			Release (ms)	749

#	Title	Type	Parameter	Value
11	A. Dr. OverTop	COMPAND-S	Threshold (dB)	-24
			Ratio (:1)	2
			Attack (ms)	38
			Out gain (dB)	-3.5
			Width (dB)	54
			Release (ms)	842
12	E. B. Finger	COMP	Threshold (dB)	-12
			Ratio (:1)	2
			Attack (ms)	15
			Out gain (dB)	4.5
			Knee	2
			Release (ms)	470
13	E. B. Slap	COMP	Threshold (dB)	-12
			Ratio (:1)	1.7
			Attack (ms)	6
			Out gain (dB)	4.0
			Knee	hard
			Release (ms)	133
14	Syn. Bass	COMP	Threshold (dB)	-10
			Ratio (:1)	3.5
			Attack (ms)	9
			Out gain (dB)	3.0
			Knee	hard
			Release (ms)	250
15	Piano1	COMP	Threshold (dB)	-9
			Ratio (:1)	2.5
			Attack (ms)	17
			Out gain (dB)	1.0
			Knee	hard
			Release (ms)	238
16	Piano2	COMP	Threshold (dB)	-18
			Ratio (:1)	3.5
			Attack (ms)	7
			Out gain (dB)	6.0
			Knee	2
			Release (ms)	174
17	E. Guitar	COMP	Threshold (dB)	-8
			Ratio (:1)	3.5
			Attack (ms)	7
			Out gain (dB)	2.5
			Knee	4
			Release (ms)	261
18	A. Guitar	COMP	Threshold (dB)	-10
			Ratio (:1)	2.5
			Attack (ms)	5
			Out gain (dB)	1.5
			Knee	2
			Release (ms)	238
19	Strings1	COMP	Threshold (dB)	-11
			Ratio (:1)	2
			Attack (ms)	33
			Out gain (dB)	1.5
			Knee	2
			Release (ms)	749
20	Strings2	COMP	Threshold (dB)	-12
			Ratio (:1)	1.5
			Attack (ms)	93
			Out gain (dB)	1.5
			Knee	4
			Release (ms)	1.35 S

#	Title	Type	Parameter	Value
21	Strings3	COMP	Threshold (dB)	-17
			Ratio (:1)	1.5
			Attack (ms)	76
			Out gain (dB)	2.5
			Knee	2
			Release (ms)	186
22	BrassSection	COMP	Threshold (dB)	-18
			Ratio (:1)	1.7
			Attack (ms)	18
			Out gain (dB)	4.0
			Knee	1
			Release (ms)	226
23	Syn. Pad	COMP	Threshold (dB)	-13
			Ratio (:1)	2
			Attack (ms)	58
			Out gain (dB)	2.0
			Knee	1
			Release (ms)	238
24	SamplingPerc	COMPAND-S	Threshold (dB)	-18
			Ratio (:1)	1.7
			Attack (ms)	8
			Out gain (dB)	-2.5
			Width (dB)	18
			Release (ms)	238
25	Sampling BD	COMP	Threshold (dB)	-14
			Ratio (:1)	2
			Attack (ms)	2
			Out gain (dB)	3.5
			Knee	4
			Release (ms)	35
26	Sampling SN	COMP	Threshold (dB)	-18
			Ratio (:1)	4
			Attack (ms)	8
			Out gain (dB)	8.0
			Knee	hard
			Release (ms)	354
27	Hip Comp	COMPAND-S	Threshold (dB)	-23
			Ratio (:1)	20
			Attack (ms)	15
			Out gain (dB)	0.0
			Width (dB)	15
			Release (ms)	163
28	Solo Vocal1	COMP	Threshold (dB)	-20
			Ratio (:1)	2.5
			Attack (ms)	31
			Out gain (dB)	2.0
			Knee	1
			Release (ms)	342
29	Solo Vocal2	COMP	Threshold (dB)	-8
			Ratio (:1)	2.5
			Attack (ms)	26
			Out gain (dB)	1.5
			Knee	3
			Release (ms)	331
30	Chorus	COMP	Threshold (dB)	-9
			Ratio (:1)	1.7
			Attack (ms)	39
			Out gain (dB)	2.5
			Knee	2
			Release (ms)	226

#	Title	Type	Parameter	Value
31	Click Erase	EXPAND	Threshold (dB)	-33
			Ratio (:1)	2
			Attack (ms)	1
			Out gain (dB)	2.0
			Knee	2
			Release (ms)	284
32	Announcer	COMPAND-H	Threshold (dB)	-14
			Ratio (:1)	2.5
			Attack (ms)	1
			Out gain (dB)	-2.5
			Width (dB)	18
			Release (ms)	180
33	Limiter1	COMPAND-S	Threshold (dB)	-9
			Ratio (:1)	3
			Attack (ms)	20
			Out gain (dB)	-3.0
			Width (dB)	90
			Release (ms)	3.90 s
34	Limiter2	COMP	Threshold (dB)	0
			Ratio (:1)	∞
			Attack (ms)	0
			Out gain (dB)	0.0
			Knee	hard
			Release (ms)	319
35	Total Comp1	COMP	Threshold (dB)	-18
			Ratio (:1)	3.5
			Attack (ms)	94
			Out gain (dB)	2.5
			Knee	hard
			Release (ms)	447
36	Total Comp2	COMP	Threshold (dB)	-16
			Ratio (:1)	6
			Attack (ms)	11
			Out gain (dB)	6.0
			Knee	1
			Release (ms)	180

Dynamics Parameters

The dynamics effects for each channel strip include a Gate section (only for Input Channels) and a Comp section. The Gate section includes Gate and Ducking types. The Comp section includes Compressor, Expander, Compander Hard (COMP. (H)), and Compander Soft (COMP. (S)) types.

GATE Section (Only for Input Channels)

GATE

A gate attenuates signals below a set THRESHOLD level by a specified amount (RANGE).

Parameter	Range	Description
THRESHOLD (dB)	-54.0 to 0.0 (541 points)	This determines the level at which the gate effect is applied.
RANGE (dB)	-70 to 0 (71 points)	This determines the amount of attenuation when the gate closes.
ATTACK (ms)	0-120 (121 points)	This determines how fast the gate opens when the signal exceeds the threshold level.
HOLD (ms)	44.1kHz: 0.02 ms – 2.13 sec 48kHz: 0.02 ms – 1.96 sec 88.2kHz: 0.01 ms – 1.06 sec 96kHz: 0.01 ms – 981 ms (160 points)	This determines how long the gate stays open once the trigger signal has fallen below the threshold.
DECAY (ms)	44.1kHz: 6 ms – 46.0 sec 48kHz: 5 ms – 42.3 sec 88.2kHz: 3 ms – 23.0 sec 96kHz: 3 ms – 21.1 sec (160 points)	This determines how fast the gate closes once the hold time has expired. The value is expressed as the duration required for the level to change by 6 dB.

I/O Characteristics

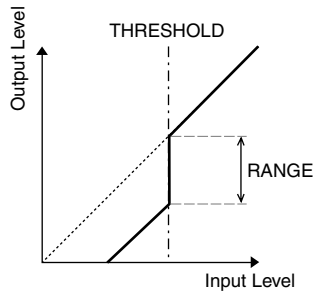

Time Series Analysis

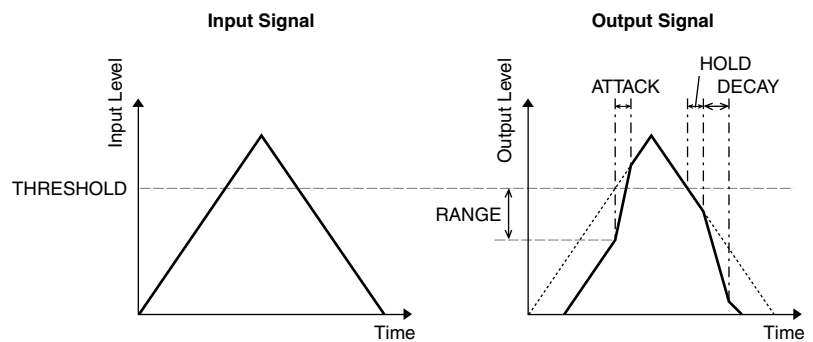

DUCKING

Ducking is commonly used for voice-over applications in which the background music level is reduced automatically when an announcer speaks. When the KEY IN source signal level exceeds the specified THRESHOLD, the output level is attenuated by a specified amount (RANGE).

Parameter	Range	Description
THRESHOLD (dB)	-54.0 to 0.0 (541 points)	This determines the level of trigger signal (KEY IN) required to activate ducking.
RANGE (dB)	-70 to 0 (71 points)	This determines the amount of attenuation when ducking is activated.
ATTACK (ms)	0-120 (121 points)	This determines how soon the signal is ducked once the ducker has been triggered.
HOLD (ms)	44.1kHz: 0.02 ms – 2.13 sec 48kHz: 0.02 ms – 1.96 sec 88.2kHz: 0.01 ms – 1.06 sec 96kHz: 0.01 ms – 981 ms (160 points)	This determines how long ducking remains active once the trigger signal has fallen below the THRESHOLD level.
DECAY (ms)	44.1kHz: 6 ms – 46.0 sec 48kHz: 5 ms – 42.3 sec 88.2kHz: 3 ms – 23.0 sec 96kHz: 3 ms – 21.1 sec (160 points)	This determines how soon the ducker returns to its normal gain once the trigger signal level drops below the threshold. The value is expressed as the duration required for the level to change by 6 dB.

I/O Characteristics

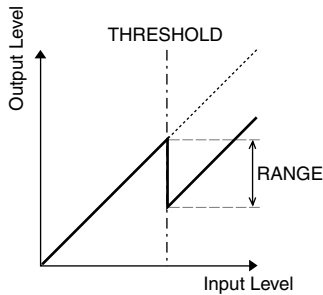

Time Series Analysis

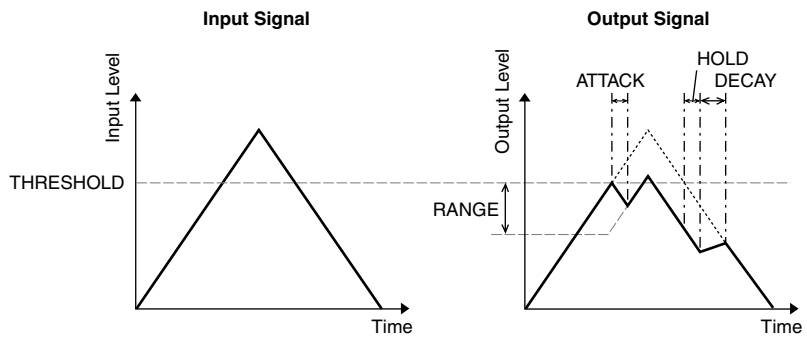

COMP Section

COMP

The COMP processor attenuates signals above a specified THRESHOLD by a specified RATIO. The COMP processor can also be used as a limiter, which, with a RATIO of $\infty:1$, reduces the level to the threshold. This means that the limiter's output level never actually exceeds the threshold.

Parameter	Range	Description
THRESHOLD (dB)	-54.0 to 0.0 (541 points)	This determines the level of input signal required to trigger the compressor.
RATIO	1.0:1, 1.1:1, 1.3:1, 1.5:1, 1.7:1, 2.0:1, 2.5:1, 3.0:1, 3.5:1, 4.0:1, 5.0:1, 6.0:1, 8.0:1, 10:1, 20:1, $\infty:1$ (16 points)	This determines the amount of compression, that is, the change in output signal level relative to change in input signal level.
ATTACK (ms)	0-120 (121 points)	This determines how soon the signal will be compressed once the compressor has been triggered.
RELEASE (ms)	44.1kHz: 6 ms - 46.0 sec 48kHz: 5 ms - 42.3 sec 88.2kHz: 3 ms - 23.0 sec 96kHz: 3 ms - 21.1 sec (160 points)	This determines how soon the compressor returns to its normal gain once the trigger signal level drops below the threshold. The value is expressed as the duration required for the level to change by 6 dB.
OUT GAIN (dB)	0.0 to +18.0 (180 points)	This sets the compressor's output signal level.
KNEE	Hard, 1-5 (6 points)	This determines how compression is applied at the threshold. For higher knee settings, compression is applied gradually as the signal exceeds the specified threshold, creating a more natural sound.

I/O Characteristics
(KNEE=hard, OUT GAIN=0.0dB)

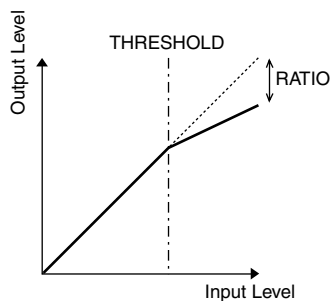

Time Series Analysis (RATIO= $\infty:1$)

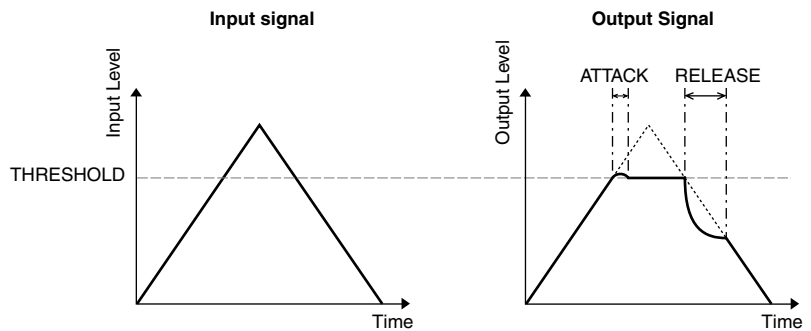

EXPAND

An expander attenuates signals below a specified THRESHOLD by a specified RATIO.

Parameter	Range	Description
THRESHOLD (dB)	-54.0 to 0.0 (541 points)	This determines the level of input signal required to trigger the expander.
RATIO	1.0:1, 1.1:1, 1.3:1, 1.5:1, 1.7:1, 2.0:1, 2.5:1, 3.0:1, 3.5:1, 4.0:1, 5.0:1, 6.0:1, 8.0:1, 10:1, 20:1, ∞:1 (16 points)	This determines the amount of expansion.
ATTACK (ms)	0-120 (121 points)	This determines how soon the expander returns to its normal gain once the trigger signal level exceeds the threshold.
RELEASE (ms)	44.1kHz: 6 ms – 46.0 sec 48kHz: 5 ms – 42.3 sec 88.2kHz: 3 ms – 23.0 sec 96kHz: 3 ms – 21.1 sec (160 points)	This determines how soon the signal is expanded once the signal level drops below the threshold. The value is expressed as the duration required for the level to change by 6 dB.
OUT GAIN (dB)	0.0 to +18.0 (180 points)	This sets the expander's output signal level.
KNEE	Hard, 1-5 (6 points)	This determines how expansion is applied at the threshold. For higher knee settings, expansion is applied gradually as the signal falls below the specified threshold, creating a more natural sound.

I/O Characteristics
(KNEE=hard, OUT GAIN=0.0dB)

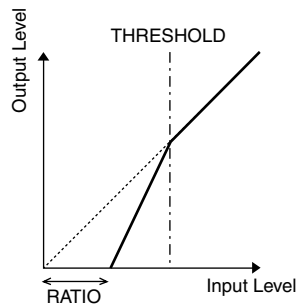

Time Series Analysis (RATIO=∞:1)

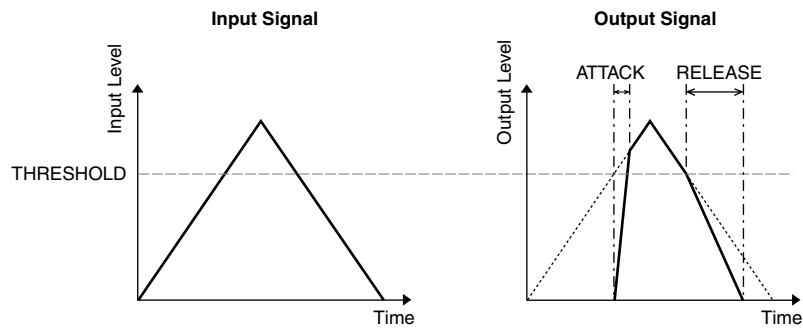

**COMPANDER HARD (H)
COMPANDER SOFT (S)**

The hard and soft companders combine the effects of the compressor, expander and limiter.

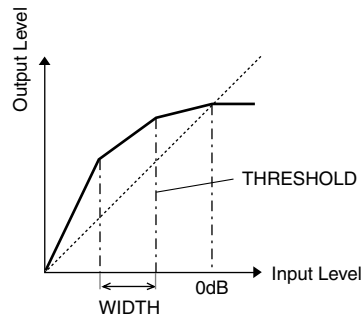

The companders function differently at the following levels:

- ① 0 dB and higher Functions as a limiter.
- ② Exceeding the threshold..... Functions as a compressor.
- ③ Below the threshold and width Functions as an expander.

The hard compander has an expansion ratio of 5:1, while the soft compander has an expansion ratio of 1.5:1. The expander is essentially turned off when the width is set to maximum. The compressor has a fixed knee setting of 2.

- * The gain is automatically adjusted according to the ratio and threshold values, and can be increased by up to 18 dB.
- * The OUT GAIN parameter enables you to compensate for the overall level change caused by the compression and expansion processes.

Parameter	Range	Description
THRESHOLD (dB)	-54.0 to 0.0 (541 points)	This determines the level at which compression is applied.
RATIO	1.0:1, 1.1:1, 1.3:1, 1.5:1, 1.7:1, 2.0:1, 2.5:1, 3.0:1, 3.5:1, 4.0:1, 5.0:1, 6.0:1, 8.0:1, 10:1, 20:1, (15 points)	This determines the amount of compression.
ATTACK (ms)	0-120 (121 points)	This determines how soon the signal is compressed or expanded once the compander has been triggered.
RELEASE (ms)	44.1kHz: 6 ms – 46.0 sec 48kHz: 5 ms – 42.3 sec 88.2kHz: 3 ms – 23.0 sec 96kHz: 3 ms – 21.1 sec (160 points)	This determines how soon the compressor or expander returns to the normal gain once the trigger signal level drops below or exceeds the threshold respectively. The value is expressed as the duration required for the level to change by 6 dB.
OUT GAIN (dB)	-18.0 to 0.0 (180 points)	This sets the compander's output signal level.
WIDTH (dB)	0-90 (91 points)	This determines how far below the threshold expansion will be applied. The expander is activated when the level drops below the threshold and width.

Appendix B: Specifications

General Spec

Number of scene memories		99	
Sampling Frequency	Internal	44.1 kHz, 48 kHz, 88.2 kHz, 96 kHz	
	External	Normal rate: 44.1 kHz–10% to 48 kHz+6% Double rate: 88.2 kHz–10% to 96 kHz+6%	
Signal Delay	fs=48 kHz	Less than 1.6 ms CH INPUT to STEREO OUT	
	fs=96 kHz	Less than 0.8 ms CH INPUT to STEREO OUT	
Fader		100 mm motorized × 17	
Fader Resolution		+10 to –138, –∞ dB input faders	
		0 to –138, –∞ dB master faders, stereo fader	
Total Harmonic Distortion ¹ (CH INPUT to STEREO OUT) (Input Gain=Min.)	fs=48 kHz	Less than 0.05% 20 Hz–20 kHz @ +14 dB into 600 Ω Less than 0.01% 1 kHz @ +24 dB into 600 Ω	
	fs=96 kHz	Less than 0.05% 20 Hz–40 kHz @ +14 dB into 600 Ω Less than 0.01% 1 kHz @ +24 dB into 600 Ω	
Frequency Response (CH INPUT to STEREO OUT)	fs=48 kHz	20 Hz–20 kHz, 0.5, –1.5 dB @ +4 dB into 600 Ω	
	fs=96 kHz	20 Hz–40 kHz, 0.5, –1.5 dB @ +4 dB into 600 Ω	
Dynamic Range (maximum level to noise level)		110 dB typ. DA Converter (STEREO OUT)	
		105 dB typ. AD+DA (to STEREO OUT) @ fs=48 kHz	
		105 dB typ. AD+DA (to STEREO OUT) @ fs=96 kHz	
Hum & Noise ² (20 Hz–20 kHz) Rs=150 Ω		–128 dB Equivalent Input Noise	
		–86 dB residual output noise. STEREO OUT (STEREO OUT off)	
		Input Gain=Max. Input Pad =0 dB	–86 dB (90 dB S/N) STEREO OUT (STEREO fader at nominal level and all CH INPUT faders at minimum level)
		Input Pad =0 dB Input Sensitivity =–60 dB	–64 dB (68 dB S/N) STEREO OUT (STEREO fader at nominal level and one CH INPUT fader at nominal level)
Maximum Voltage Gain		74 dB CH INPUT (CH1–12) to STEREO OUT/OMNI (BUS) OUT	
		40 dB CH INPUT (CH13–16) to STEREO OUT	
		74 dB CH INPUT (CH1–12) to OMNI (AUX) OUT (via pre input fader)	
		74 dB CH INPUT (CH1–12) to MONITOR OUT (via STEREO BUS)	
Crosstalk (@ 1 kHz) Input Gain=Min.		80 dB adjacent input channels (CH1–12)	
		80 dB adjacent input channels (CH13–16)	
		80 dB input to output	
AD Input (1–12)	Phantom switch	+48 V DC (each 4ch)	
	Pad switch	0/20 dB attenuation	
	Gain control	44 dB (–60 to –16), detented	
	Peak indicator	LED (red) turns on when post HA level reaches 3 dB below clipping at digital domain	
	Signal indicator	LED (green) turns on when post HA level reaches 20 dB below nominal at digital domain	
	AD converter	24-bit linear, 128-times oversampling (fs=44.1, 48 kHz), 64-times oversampling (fs=88.2, 96 kHz)	
AD Input (13–16)	Gain control	30 dB (–26 to +4), detented	
	Peak indicator	LED (red) turns on when post HA level reaches 3 dB below clipping at digital domain	
	Signal indicator	LED (green) turns on when post HA level reaches 20 dB below nominal at digital domain	
	AD converter	24-bit linear, 128-times oversampling (fs=44.1, 48 kHz), 64-times oversampling (fs=88.2, 96 kHz)	
	Input selector	CH15/16/2TR IN for CH15/16	

Digital Input (2TR IN DIGITAL, ADAT input)			
Option Input (SLOT)	Available cards	Optional digital interface cards (MY16, MY8, MY4 series)	
Input Channel CH1–32	Input patch	—	
	Phase	Normal/reverse	
	Gate-type ³	On/off	
		Key in: 12 ch Group (1–12, 13–24, 25–32)/AUX1–8	
	Comp-type ⁴	On/off	
		Key in: self /Stereo Link	
		Pre EQ/pre fader/post fader	
	Attenuator	–96.0 to +12.0 dB (0.1 dB step)	
	EQ	4-band PEQ (TYPE1) ⁵	
		On/off	
	Delay	0–43400 samples	
	On/off	—	
	Fader	100 mm motorized (INPUT/AUX1–8)	
	Aux send	On/off	
		AUX1–8; pre fader/post fader	
	Solo	On/off	
		Pre fader/after pan	
	Pan	127 positions (Left= 1–63, Center, Right= 1–63)	
	Surround pan	127 × 127 positions ([Left= 1–63, Center, Right= 1–63] × [Front= 1–63, Center, Rear= 1–63])	
	LFE level	–∞, –96 dB to +10 dB (256 step)	
Routing	STEREO, BUS1–8, DIRECT OUT		
Direct out	Pre EQ/pre fader/post fader		
Metering	Displayed on LCD		
	Peak hold on/off		
Stereo Input Channel CH1–4	Input patch (L/R)	—	
	Phase (L/R)	Normal/reverse	
	Attenuator (L/R)	–96.0 to +12.0 dB (0.1 dB step)	
	Equalizer	4band PEQ (TYPE1) ⁵	
	On/off	—	
	Fader	100 mm motorized	
		INPUT/AUX1–8 send	
	Aux send	On/off	
		AUX1–8; pre fader/post fader	
	Solo	On/off	
		Pre fader/after pan	
	Pan (L/R)	127 positions (Left= 1–63, Center, Right= 1–63)	
	Surround pan (L/R)	127 × 127 positions ([Left= 1–63, Center, Right= 1–63] × [Front= 1–63, Center, Rear= 1–63])	
	LFE level (L/R)	–∞, –96 dB to +10 dB (256 step)	
	Routing	STEREO, BUS1–8, DIRECT OUT	
Metering	Displayed on LCD		
	Peak hold on/off		
OSCILLATOR	Level	0 to –96 dB (1 dB step)	
	On/off	—	
	Waveform	Sine 100 Hz, sine 1 kHz, sine 10 kHz, pink noise, burst noise	
	Routing	BUS1–8, AUX1–8, STEREO L/R	
STEREO OUT	DA converter	24-bit linear, 128-times oversampling (@fs=44.1, 48 kHz), 64-times over-sampling (@fs=88.2, 96 kHz)	

MONITOR OUT	DA converter	24-bit linear, 128-times oversampling (@fs=44.1, 48 kHz), 64-times oversampling (@fs=88.2, 96 kHz)
OMNI OUT 1–4	Output patch	STEREO, BUS1–8, AUX1–8, DIRECT OUT 1–32, INSERT OUT (CH1–32, BUS1–8, AUX1–8, STEREO), CASCADE OUT (BUS1–8, AUX 1–8, STEREO, SOLO)
	DA converter	24-bit linear, 128-times oversampling (@fs=44.1, 48 kHz), 64-times oversampling (@fs=88.2, 96 kHz)
2TR OUT DIGITAL	Dither	On/off Word length 16, 20, 24-bit
	Output patch	STEREO, BUS1–8, AUX 1–8, DIRECT OUT 1–32, INSERT OUT (CH 1–32, BUS 1–8, AUX 1–8, STEREO), CASCADE OUT (BUS 1–8, AUX 1–8, STEREO, SOLO)
ADAT Output	Dither	On/off Word length 16, 20, 24-bit
	Output patch	STEREO, BUS1–8, AUX 1–8, DIRECT OUT 1–32, INSERT OUT (CH 1–32, BUS 1–8, AUX 1–8, STEREO), CASCADE OUT (BUS 1–8, AUX 1–8, STEREO, SOLO)
Option Output (SLOT)	Available card	Optional digital interface card (MY16, MY8, MY4 series)
	Dither	On/off Word length 16/20/24-bit
	Output patch	STEREO, BUS1–8, AUX 1–8, DIRECT OUT 1–32, INSERT OUT (CH 1–32, BUS 1–8, AUX 1–8, STEREO), CASCADE OUT (BUS 1–8, AUX 1–8, STEREO, SOLO)
STEREO	Comp-type ⁴	On/off
		Pre EQ/pre fader/post fader
	Attenuator	–96.0 to +12.0 dB (0.1 dB step)
	EQ	4-band PEQ ⁵
		On/off
	On/off	—
	Fader	100 mm motorized
	Balance	127 positions (Left=1–63, Center, Right=1–63)
Delay	0–29100 samples	
Metering	Displayed on LCD	
	Peak hold on/off	
	12-elements x2 LED meters	
BUS1–8	Comp-type ⁴	On/off
		Pre EQ/pre fader/post fader
	Attenuator	–96.0 to +12.0 dB (0.1 dB step)
	EQ	4-band PEQ ⁵
		On/off
	On/off	—
	Fader	100 mm motorized
	Delay	0–29100 samples
	Bus to stereo	Level (–∞, –138 dB–0 dB)
		On/off
Pan: 127 positions (Left=1–63, Center, Right=1–63)		
Metering	Displayed on LCD	
	Peak hold on/off	

AUX1-8	Comp-type⁴	On/off Pre EQ/pre fader/post fader
	Attenuator	-96.0 to +12.0 dB (0.1 dB step)
	EQ	4-band PEQ ⁵ On/off
	On/off	—
	Fader	100 mm motorized
	Delay	0–29100 samples
	Metering	Displayed on LCD Peak hold on/off
INTERNAL EFFECTS (EFFECT 1–4)	Number of effects	4@44.1kHz, 48kHz 2@88.2kHz, 96kHz
	Bypass	On/off
	In/out	2-in, 2-out
	Effect-in from	AUX1-8/INSERT OUT
	Effect-out to	Input patch
Power Requirements	U.S./Canada	120 V, 60 Hz 90 W
	Other	220–240 V, 50/60 Hz 90 W
Dimensions	(H x D x W)	150 x 548 x 436 mm
Net weight		15 kg
Operating free-air temperature range		10–35°C
Storage temperature range		-20–60°C
Supplied Accessories		AC Cable CD-ROM (Studio Manager) Owner's Manual Studio Manager Installation Guide
Options		Digital interface card (MY16, MY8, MY4 series) RACK MOUNT KIT: RK1

1. Total harmonic distortion is measured with a 6 dB/octave filter @ 80 kHz.
2. Hum & Noise are measured with a 6 dB/octave filter @ 12.7 kHz; equivalent to a 20 kHz filter with infinite dB/octave attenuation.
3. See "Gate Parameters" on page 284.
4. See "Comp Parameters" on page 284.
5. See "EQ Parameters" on page 283.

EQ Parameters

	LOW/HPF	L-MID	H-MID	HIGH /LPF
Q	0.1–10.0 (41 points) low shelving HPF	0.1–10.0 (41 points)		0.1–10.0 (41 points) high shelving LPF
F	21.2 Hz–20.0 kHz (1/12 oct step)			
G	±18 dB (0.1 dB step) HPF: on/off	±18 dB (0.1 dB step)		±18 dB (0.1 dB step) LPF: on/off

Gate Parameters

Gate	Threshold	-54 dB–0 dB (0.1 dB step)	
	Range	-70 dB–0 dB (1 dB step)	
	Attack	0 ms–120 ms (1 ms step)	
	Hold		0.02 ms–1.96 s (216 points) @ 48 kHz
			0.02 ms–2.13 s (216 points) @ 44.1 kHz
			0.01 ms–981 ms (216 points) @ 96 kHz
			0.01 ms–1.06 s (216 points) @ 88.2 kHz
	Decay		5 ms–42.3 s (160 points) @ 48 kHz
			6 ms–46.0 s (160 points) @ 44.1 kHz
			3 ms–21.1 s (160 points) @ 96 kHz
		3 ms–23.0 s (160 points) @ 88.2 kHz	
Ducking	Threshold	-54 dB–0 dB (0.1 dB step)	
	Range	-70 dB–0 dB (1 dB step)	
	Attack	0 ms–120 ms (1 ms step)	
	Hold		0.02 ms–1.96 s (216 points) @ 48 kHz
			0.02 ms–2.13 s (216 points) @ 44.1 kHz
			0.01 ms–981 ms (216 points) @ 96 kHz
			0.01 ms–1.06 s (216 points) @ 88.2 kHz
	Decay		5 ms–42.3 s (160 points) @ 48 kHz
			6 ms–46.0 s (160 points) @ 44.1 kHz
			3 ms–21.1 s (160 points) @ 96 kHz
		3 ms–23.0 s (160 points) @ 88.2 kHz	

Comp Parameters

Compressor	Threshold	-54 dB–0 dB (0.1 dB step)	
	Ratio (x :1)	x=1, 1.1, 1.3, 1.5, 1.7, 2, 2.5, 3, 3.5, 4, 5, 6, 8, 10, 20, ∞ (16 points)	
	Out gain	0 dB to +18 dB (0.1 dB step)	
	Knee	Hard, 1, 2, 3, 4, 5 (6 step)	
	Attack	0 ms–120 ms (1 ms step)	
	Release		5 ms–42.3 s (160 points) @ 48 kHz
			6 ms–46.0 s (160 points) @ 44.1 kHz
			3 ms–21.1 s (160 points) @ 96 kHz
		3 ms–23.0 s (160 points) @ 88.2 kHz	
Expander	Threshold	-54 dB to 0 dB (0.1 dB step)	
	Ratio (x :1)	x=1, 1.1, 1.3, 1.5, 1.7, 2, 2.5, 3, 3.5, 4, 5, 6, 8, 10, 20, ∞ (16 points)	
	Out gain	0 dB to +18 dB (0.1 dB step)	
	Knee	Hard, 1, 2, 3, 4, 5 (6 points)	
	Attack	0 ms–120 ms (1 ms step)	
	Release		5 ms–42.3 s (160 points) @ 48 kHz
			6 ms–46.0 s (160 points) @ 44.1 kHz
		3 ms–21.1 s (160 points) @ 96 kHz	
		3 ms–23.0 s (160 points) @ 88.2 kHz	

Compander H	Threshold	-54 dB to 0 dB (0.1 dB step)	
	Ratio (x :1)	x=1, 1.1, 1.3, 1.5, 1.7, 2, 2.5, 3, 3.5, 4, 5, 6, 8, 10, 20 (15 points)	
	Out gain	-18 dB to 0 dB (0.1 dB step)	
	Width	1 dB-90 dB (1 dB step)	
	Attack	0 ms-120 ms (1 ms step)	
	Release		5 ms-42.3 s (160 points) @ 48 kHz
			6 ms-46.0 s (160 points) @ 44.1 kHz
			3 ms-21.1 s (160 points) @ 96 kHz
		3 ms-23.0 s (160 points) @ 88.2 kHz	
Compander S	Threshold	-54 dB to 0 dB (0.1 dB step)	
	Ratio (x :1)	x=1, 1.1, 1.3, 1.5, 1.7, 2, 2.5, 3, 3.5, 4, 5, 6, 8, 10, 20 (15 points)	
	Out gain	-18 dB to 0 dB (0.1 dB step)	
	Width	1 dB-90 dB (1 dB step)	
	Attack	0 ms-120 ms (1 ms step)	
	Release		5 ms-42.3 s (160 points) @ 48 kHz
			6 ms-46.0 s (160 points) @ 44.1 kHz
			3 ms-21.1 s (160 points) @ 96 kHz
		3 ms-23.0 s (160 points) @ 88.2 kHz	

Libraries

Effect library (EFFECT 1-4)	Presets	53
	User memories	75
Compressor library	Presets	36
	User memories	92
Gate library	Presets	4
	User memories	124
EQ library	Presets	40
	User memories	160
Channel library	Presets	2
	User memories	127
Input patch library	Presets	1
	User memories	32
Output patch library	Presets	1
	User memories	32

Analog Input Spec

Input	PAD	GAIN	Actual Load Impedance	For Use With Nominal	Input level			Connector
					Sensitivity ¹	Nominal	Max. before clip	
INPUT A/B 1–12	0	–60 dB	3k Ω	50–600 Ω Mics & 600 Ω Lines	–70 dB (0.245 mV)	–60 dB (0.775 mV)	–40 dB (7.75 mV)	A: XLR-3-31 type (Balanced) ² B: Phone jack (TRS) (Balanced) ³
		–16 dB			–26 dB (38.8 mV)	–16 dB (123 mV)	+4 dB (1.23 V)	
	20	–6 dB (338 mV)			+4 dB (1.23 V)	+24 dB (12.28 V)		
INPUT 13–16	—	–26 dB	10k Ω	600 Ω Lines	–36 dB (12.3 mV)	–26 dB (38.8 mV)	–6 dB (388 mV)	Phone jack (TRS) (Balanced) ³
		+4 dB			–6 dB (388 mV)	+4 dB (1.23 V)	+24 dB (12.28 V)	
CH INSERT IN 1–12	—	—	10k Ω	600 Ω Lines	–12 dB (195 mV)	–2 dB (616 mV)	+18 dB (6.16 V)	Phone jack (TRS) (Unbalanced) ⁴
2TR IN [L, R]	—	—	10k Ω	600 Ω Lines	–10 dBV (316 mV)	–10 dBV (316 mV)	+10 dBV (3.16 V)	RCA pin jack (Unbalanced)

1. Sensitivity is the lowest level that will produce an output of +4 dB (1.23 V) or the nominal output level when the unit is set to maximum gain. (All faders and level controls are maximum position.)
2. XLR-3-31 type connectors are balanced (1=GND, 2=HOT, 3=COLD).
3. Phone jacks are balanced (Tip=HOT, Ring=COLD, Sleeve=GND).
4. CH INSERT IN/OUT phone jacks are unbalanced. (Tip=OUTPUT, Ring=INPUT, Sleeve=GND).

In these specifications, when dB represents a specific voltage, 0 dB is referenced to 0.775 Vrms.

For 2TR IN levels, 0 dBV is referenced to 1.00 Vrms.

All input AD converters (CH INPUT 1–16) are 24-bit linear, 128-times oversampling. (@fs=44.1, 48 kHz)

+48 V DC (phantom power) is supplied to CH INPUT (1–12) XLR type connectors.

Three PHANTOM +48V switches CH1–4, 5–8, 9–12 turn on the phantom power for inputs 1–4, 5–8, 9–12 respectively.

Analog Output Specs

Output	Actual Source Impedance	For Use With Nominal	Output level		Connector
			Nominal	Max. before clip	
STEREO OUT [L, R]	150 Ω	600 Ω Lines	+4 dB (1.23 V)	+24 dB (12.28 V)	XLR-3-32 type (Balanced) ¹
OMNI OUT 1–4	150 Ω	10k Ω Lines	+4 dB (1.23 V)	+24 dB (12.28 V)	Phone jack (TRS) (Balanced) ²
MONITOR OUT [L, R]	150 Ω	10k Ω Lines	+4 dB (1.23 V)	+24 dB (12.28 V)	Phone jack (TRS) (Balanced) ²
CH INSERT OUT 1–12	600 Ω	10k Ω Lines	–2 dB (616 mV)	+18 dB (6.16 V)	Phone jack (TRS) (Unbalanced) ³
2TR OUT [L, R]	600 Ω	10k Ω Lines	–10 dBV (316 mV)	+10 dBV (3.16 V)	RCA Pin Jack (Unbalanced)
PHONES	100 Ω	8 Ω Phones	4 mW	25 mW	Stereo Phone Jack (TRS) (Unbalanced) ⁴
		40 Ω Phones	12 mW	75 mW	

1. XLR-3-32 type connectors are balanced (1=GND, 2=HOT, 3=COLD).
2. Phone jacks are balanced (Tip=HOT, Ring=COLD, Sleeve=GND).
3. CH INSERT IN/OUT phone jacks are unbalanced. (Tip=OUTPUT, Ring=INPUT, Sleeve=GND).
4. PHONES stereo phone jack is unbalanced (Tip=LEFT, Ring=RIGHT, Sleeve=GND).

In these specifications, when dB represents a specific voltage, 0 dB is referenced to 0.775 Vrms.

2TR OUT [L, R] levels, 0 dBV is referenced to 1.00 Vrms.

All output DA converters are 24-bit, 128-times oversampling. (@fs=44.1, 48 kHz)

Digital Input Spec

Input	Format	Data length	Level	Connector
2TR IN DIGITAL	IEC-60958	24-bit	0.5 Vpp/75 Ω	RCA pin jack
ADAT IN	ADAT ¹	24-bit	—	OPTICAL

1. ALESIS proprietary multichannel optical digital interface format

Digital Output Spec

Output	Format	Data length	Level	Connector
2TR OUT DIGITAL	IEC-60958 ¹ Consumer use	24-bit ³	0.5V pp/75 Ω	RCA pin jack
ADAT OUT	ADAT ²	24-bit ³	—	OPTICAL

1. Channel status of 2TR OUT DIGITAL
Type: linear PCM
Category code: Digital signal mixer
Copy prohibit: NO
Emphasis: NO
Clock accuracy: Level II (1000 ppm)
Sampling rate: depends on the internal configuration
2. ALESIS proprietary multichannel optical digital interface format
3. Dither: word length 16/20/24 bit

I/O SLOT Spec

Each I/O SLOT accepts a Digital interface card. SLOT1 has a serial interface.

Maker	Model	Function	INPUT	OUTPUT 1	Format	Resolution	Frequency	The number of Available cards	Note
Yamaha	MY8-AT	Digital I/O	8	8	ADAT	24 bit	44.1/48 kHz	1	Can handle 24 bit/96 kHz by double channel mode
	MY16-AT		16	16					
	MY8-TD		8	8	TASCAM				
	MY16-TD		16	16					
	MY8-AE		8	8	AES/EBU				
	MY8-AEB		8	8					
	MY16-AE	16	16						
	MY8-AE96S	8	8	AES/EBU	44.1/48/88.2/96 kHz	Sampling Rate Converter for input			
	MY8-AE96	8	8						
	MY4-AD	ANALOG IN	4	—	—	24 bit	44.1/48 kHz		
	MY8-AD		8			20 bit			
	MY8-AD24								24 bit
	MY8-AD96		44.1/48/88.2/96 kHz						
	MY4-DA	ANALOG OUT	—	4	—	20 bit	44.1/48 kHz		
MY8-DA96	8								
MY8-ADDA96	ANALOG I/O	8	8	—	24 bit	44.1/48/88.2/96 kHz			
MY8-mLAN	mLAN Interface	8	8		IEEE1394	24 bit	44.1/48 kHz		
MY16-mLAN		16	16						
Waves	Y56K	Effect & I/O	8	8	ADAT	24 bit	44.1/48 kHz		
	Y96K						44.1/48/88.2/96 kHz		
Apogee	AP8AD	ANALOG IN	8	—	—	24 bit	44.1/48/88.2/96 kHz	4ch @fs=88.2, 96 kHz	
	AP8DA	ANALOG OUT	—	8					

1. Selectable from STEREO/BUS/AUX/DIRECT/OUT/INSERT OUT/CASCADE OUT (STEREO, BUS1~8, AUX1~8, SOLO). Details depend on each interface card.

CONTROL I/O Spec

I/O Port		Format	Level	Connector in Console
TO HOST USB		USB	0 V–3.3 V	B type USB connector
MIDI	IN ¹	MIDI	—	DIN Connector 5P
	OUT	MIDI	—	DIN Connector 5P
	THRU	MIDI	—	DIN Connector 5P
WORD CLOCK	IN	—	TTL/75 Ω	BNC Connector
	OUT	—	TTL/75 Ω	BNC Connector

1. MIDI IN can use as TIME CODE IN MTC.

Dimensions

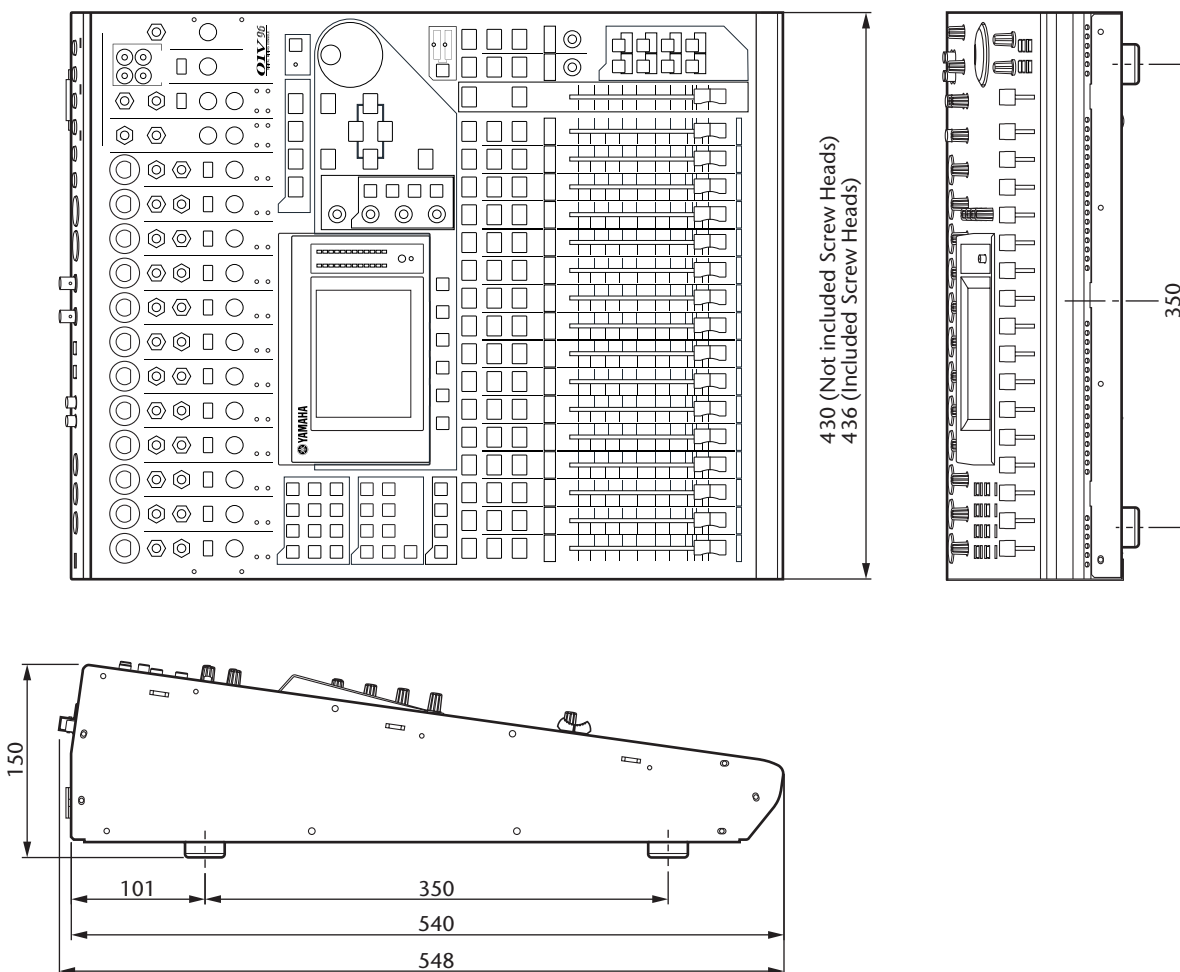

Unit: mm

Specifications and descriptions in this owner’s manual are for information purposes only. Yamaha Corp. reserves the right to change or modify products or specifications at any time without prior notice. Since specifications, equipment or options may not be the same in every locale, please check with your Yamaha dealer.

European Models

Purchaser/User Information specified in EN55103-1 and EN55103-2.

Inrush Current: 20 A

Conforms to Environments: E1, E2, E3 and E4

Appendix C: MIDI

Scene Memory to Program Change Table

Program Change #	Initial Scene #	User Scene #
1	01	
2	02	
3	03	
4	04	
5	05	
6	06	
7	07	
8	08	
9	09	
10	10	
11	11	
12	12	
13	13	
14	14	
15	15	
16	16	
17	17	
18	18	
19	19	
20	20	
21	21	
22	22	
23	23	
24	24	
25	25	
26	26	
27	27	
28	28	
29	29	
30	30	
31	31	
32	32	
33	33	
34	34	
35	35	
36	36	
37	37	
38	38	
39	39	
40	40	
41	41	
42	42	
43	43	

Program Change #	Initial Scene #	User Scene #
44	44	
45	45	
46	46	
47	47	
48	48	
49	49	
50	50	
51	51	
52	52	
53	53	
54	54	
55	55	
56	56	
57	57	
58	58	
59	59	
60	60	
61	61	
62	62	
63	63	
64	64	
65	65	
66	66	
67	67	
68	68	
69	69	
70	70	
71	71	
72	72	
73	73	
74	74	
75	75	
76	76	
77	77	
78	78	
79	79	
80	80	
81	81	
82	82	
83	83	
84	84	
85	85	
86	86	

Program Change#	Initial Scene #	User Scene #
87	87	
88	88	
89	89	
90	90	
91	91	
92	92	
93	93	
94	94	
95	95	
96	96	
97	97	
98	98	
99	99	
100	00	
101	—	
102	—	
103	—	
104	—	
105	—	
106	—	
107	—	
108	—	
109	—	
110	—	
111	—	
112	—	
113	—	
114	—	
115	—	
116	—	
117	—	
118	—	
119	—	
120	—	
121	—	
122	—	
123	—	
124	—	
125	—	
126	—	
127	—	
128	—	

Initial Parameter to Control Change Table

CHANNEL1

#	High	Mid	Low
0	NO ASSIGN		
1	FADER H	CHANNEL	INPUT1
2	FADER H	CHANNEL	INPUT2
3	FADER H	CHANNEL	INPUT3
4	FADER H	CHANNEL	INPUT4
5	FADER H	CHANNEL	INPUT5
6	FADER H	CHANNEL	INPUT6
7	FADER H	CHANNEL	INPUT7
8	FADER H	CHANNEL	INPUT8
9	FADER H	CHANNEL	INPUT9
10	FADER H	CHANNEL	INPUT10
11	FADER H	CHANNEL	INPUT11
12	FADER H	CHANNEL	INPUT12
13	FADER H	CHANNEL	INPUT13
14	FADER H	CHANNEL	INPUT14
15	FADER H	CHANNEL	INPUT15
16	FADER H	CHANNEL	INPUT16
17	FADER H	CHANNEL	INPUT17
18	FADER H	CHANNEL	INPUT18
19	FADER H	CHANNEL	INPUT19
20	FADER H	CHANNEL	INPUT20
21	FADER H	CHANNEL	INPUT21
22	FADER H	CHANNEL	INPUT22
23	FADER H	CHANNEL	INPUT23
24	FADER H	CHANNEL	INPUT24
25	NO ASSIGN		
26	NO ASSIGN		
27	NO ASSIGN		
28	NO ASSIGN		
29	NO ASSIGN		
30	FADER H	MASTER	STEREO
31	NO ASSIGN		
32	NO ASSIGN		
33	FADER L	CHANNEL	INPUT1
34	FADER L	CHANNEL	INPUT2
35	FADER L	CHANNEL	INPUT3
36	FADER L	CHANNEL	INPUT4
37	FADER L	CHANNEL	INPUT5
38	FADER L	CHANNEL	INPUT6
39	FADER L	CHANNEL	INPUT7
40	FADER L	CHANNEL	INPUT8
41	FADER L	CHANNEL	INPUT9
42	FADER L	CHANNEL	INPUT10
43	FADER L	CHANNEL	INPUT11
44	FADER L	CHANNEL	INPUT12
45	FADER L	CHANNEL	INPUT13
46	FADER L	CHANNEL	INPUT14
47	FADER L	CHANNEL	INPUT15
48	FADER L	CHANNEL	INPUT16
49	FADER L	CHANNEL	INPUT17
50	FADER L	CHANNEL	INPUT18
51	FADER L	CHANNEL	INPUT19
52	FADER L	CHANNEL	INPUT20
53	FADER L	CHANNEL	INPUT21
54	FADER L	CHANNEL	INPUT22
55	FADER L	CHANNEL	INPUT23
56	FADER L	CHANNEL	INPUT24

#	High	Mid	Low
57	NO ASSIGN		
58	NO ASSIGN		
59	NO ASSIGN		
60	NO ASSIGN		
61	NO ASSIGN		
62	FADER L	MASTER	STEREO
63	NO ASSIGN		
64	ON	CHANNEL	INPUT1
65	ON	CHANNEL	INPUT2
66	ON	CHANNEL	INPUT3
67	ON	CHANNEL	INPUT4
68	ON	CHANNEL	INPUT5
69	ON	CHANNEL	INPUT6
70	ON	CHANNEL	INPUT7
71	ON	CHANNEL	INPUT8
72	ON	CHANNEL	INPUT9
73	ON	CHANNEL	INPUT10
74	ON	CHANNEL	INPUT11
75	ON	CHANNEL	INPUT12
76	ON	CHANNEL	INPUT13
77	ON	CHANNEL	INPUT14
78	ON	CHANNEL	INPUT15
79	ON	CHANNEL	INPUT16
80	ON	CHANNEL	INPUT17
81	ON	CHANNEL	INPUT18
82	ON	CHANNEL	INPUT19
83	ON	CHANNEL	INPUT20
84	ON	CHANNEL	INPUT21
85	ON	CHANNEL	INPUT22
86	ON	CHANNEL	INPUT23
87	ON	CHANNEL	INPUT24
88	NO ASSIGN		
89	PAN	CHANNEL	INPUT1
90	PAN	CHANNEL	INPUT2
91	PAN	CHANNEL	INPUT3
92	PAN	CHANNEL	INPUT4
93	PAN	CHANNEL	INPUT5
94	PAN	CHANNEL	INPUT6
95	PAN	CHANNEL	INPUT7
102	PAN	CHANNEL	INPUT8
103	PAN	CHANNEL	INPUT9
104	PAN	CHANNEL	INPUT10
105	PAN	CHANNEL	INPUT11
106	PAN	CHANNEL	INPUT12
107	PAN	CHANNEL	INPUT13
108	PAN	CHANNEL	INPUT14
109	PAN	CHANNEL	INPUT15
110	PAN	CHANNEL	INPUT16
111	PAN	CHANNEL	INPUT17
112	PAN	CHANNEL	INPUT18
113	PAN	CHANNEL	INPUT19
114	PAN	CHANNEL	INPUT20
115	PAN	CHANNEL	INPUT21
116	PAN	CHANNEL	INPUT22
117	PAN	CHANNEL	INPUT23
118	PAN	CHANNEL	INPUT24
119	NO ASSIGN		

CHANNEL2

#	High	Mid	Low
0	NO ASSIGN		
1	FADER H	CHANNEL	INPUT25
2	FADER H	CHANNEL	INPUT26
3	FADER H	CHANNEL	INPUT27
4	FADER H	CHANNEL	INPUT28
5	FADER H	CHANNEL	INPUT29
6	FADER H	CHANNEL	INPUT30
7	FADER H	CHANNEL	INPUT31
8	FADER H	CHANNEL	INPUT32
9	FADER H	CHANNEL	ST-IN1
10	FADER H	CHANNEL	ST-IN2
11	FADER H	CHANNEL	ST-IN3
12	FADER H	CHANNEL	ST-IN4
13	FADER H	MASTER	BUS1
14	FADER H	MASTER	BUS2
15	FADER H	MASTER	BUS3
16	FADER H	MASTER	BUS4
17	FADER H	MASTER	BUS5
18	FADER H	MASTER	BUS6
19	FADER H	MASTER	BUS7
20	FADER H	MASTER	BUS8
21	FADER H	MASTER	AUX1
22	FADER H	MASTER	AUX2
23	FADER H	MASTER	AUX3
24	FADER H	MASTER	AUX4
25	FADER H	MASTER	AUX5
26	FADER H	MASTER	AUX6
27	FADER H	MASTER	AUX7
28	FADER H	MASTER	AUX8
29	NO ASSIGN		
30	ON	MASTER	STEREO
31	NO ASSIGN		
32	NO ASSIGN		
33	FADER L	CHANNEL	INPUT25
34	FADER L	CHANNEL	INPUT26
35	FADER L	CHANNEL	INPUT27
36	FADER L	CHANNEL	INPUT28
37	FADER L	CHANNEL	INPUT29
38	FADER L	CHANNEL	INPUT30
39	FADER L	CHANNEL	INPUT31
40	FADER L	CHANNEL	INPUT32
41	FADER L	CHANNEL	ST-IN1
42	FADER L	CHANNEL	ST-IN2
43	FADER L	CHANNEL	ST-IN3
44	FADER L	CHANNEL	ST-IN4
45	FADER L	MASTER	BUS1
46	FADER L	MASTER	BUS2
47	FADER L	MASTER	BUS3
48	FADER L	MASTER	BUS4
49	FADER L	MASTER	BUS5
50	FADER L	MASTER	BUS6
51	FADER L	MASTER	BUS7
52	FADER L	MASTER	BUS8
53	FADER L	MASTER	AUX1
54	FADER L	MASTER	AUX2
55	FADER L	MASTER	AUX3
56	FADER L	MASTER	AUX4
57	FADER L	MASTER	AUX5
58	FADER L	MASTER	AUX6

#	High	Mid	Low
59	FADER L	MASTER	AUX7
60	FADER L	MASTER	AUX8
61	NO ASSIGN		
62	BALANCE	MASTER	STEREO
63	NO ASSIGN		
64	ON	CHANNEL	INPUT25
65	ON	CHANNEL	INPUT26
66	ON	CHANNEL	INPUT27
67	ON	CHANNEL	INPUT28
68	ON	CHANNEL	INPUT29
69	ON	CHANNEL	INPUT30
70	ON	CHANNEL	INPUT31
71	ON	CHANNEL	INPUT32
72	ON	CHANNEL	ST-IN1
73	ON	CHANNEL	ST-IN2
74	ON	CHANNEL	ST-IN3
75	ON	CHANNEL	ST-IN4
76	ON	MASTER	BUS1
77	ON	MASTER	BUS2
78	ON	MASTER	BUS3
79	ON	MASTER	BUS4
80	ON	MASTER	BUS5
81	ON	MASTER	BUS6
82	ON	MASTER	BUS7
83	ON	MASTER	BUS8
84	NO ASSIGN		
85	NO ASSIGN		
86	NO ASSIGN		
87	NO ASSIGN		
88	NO ASSIGN		
89	PAN	CHANNEL	INPUT25
90	PAN	CHANNEL	INPUT26
91	PAN	CHANNEL	INPUT27
92	PAN	CHANNEL	INPUT28
93	PAN	CHANNEL	INPUT29
94	PAN	CHANNEL	INPUT30
95	PAN	CHANNEL	INPUT31
102	PAN	CHANNEL	INPUT32
103	PAN	CHANNEL	ST-IN1L
104	PAN	CHANNEL	ST-IN1R
105	PAN	CHANNEL	ST-IN2L
106	PAN	CHANNEL	ST-IN2R
107	PAN	CHANNEL	ST-IN3L
108	PAN	CHANNEL	ST-IN3R
109	PAN	CHANNEL	ST-IN4L
110	PAN	CHANNEL	ST-IN4R
111	ON	MASTER	AUX1
112	ON	MASTER	AUX2
113	ON	MASTER	AUX3
114	ON	MASTER	AUX4
115	ON	MASTER	AUX5
116	ON	MASTER	AUX6
117	ON	MASTER	AUX7
118	ON	MASTER	AUX8
119	NO ASSIGN		

CHANNEL3

#	High	Mid	Low
0	NO ASSIGN		
1	EQ	G LOW H	INPUT1
2	EQ	G LOW H	INPUT2
3	EQ	G LOW H	INPUT3
4	EQ	G LOW H	INPUT4
5	EQ	G LOW H	INPUT5
6	EQ	G LOW H	INPUT6
7	EQ	G LOW H	INPUT7
8	EQ	G LOW H	INPUT8
9	EQ	G LOW H	INPUT9
10	EQ	G LOW H	INPUT10
11	EQ	G LOW H	INPUT11
12	EQ	G LOW H	INPUT12
13	EQ	G LOW H	INPUT13
14	EQ	G LOW H	INPUT14
15	EQ	G LOW H	INPUT15
16	EQ	G LOW H	INPUT16
17	EQ	G LOW H	INPUT17
18	EQ	G LOW H	INPUT18
19	EQ	G LOW H	INPUT19
20	EQ	G LOW H	INPUT20
21	EQ	G LOW H	INPUT21
22	EQ	G LOW H	INPUT22
23	EQ	G LOW H	INPUT23
24	EQ	G LOW H	INPUT24
25	NO ASSIGN		
26	NO ASSIGN		
27	NO ASSIGN		
28	NO ASSIGN		
29	NO ASSIGN		
30	NO ASSIGN		
31	NO ASSIGN		
32	NO ASSIGN		
33	EQ	G LOW L	INPUT1
34	EQ	G LOW L	INPUT2
35	EQ	G LOW L	INPUT3
36	EQ	G LOW L	INPUT4
37	EQ	G LOW L	INPUT5
38	EQ	G LOW L	INPUT6
39	EQ	G LOW L	INPUT7
40	EQ	G LOW L	INPUT8
41	EQ	G LOW L	INPUT9
42	EQ	G LOW L	INPUT10
43	EQ	G LOW L	INPUT11
44	EQ	G LOW L	INPUT12
45	EQ	G LOW L	INPUT13
46	EQ	G LOW L	INPUT14
47	EQ	G LOW L	INPUT15
48	EQ	G LOW L	INPUT16
49	EQ	G LOW L	INPUT17
50	EQ	G LOW L	INPUT18
51	EQ	G LOW L	INPUT19
52	EQ	G LOW L	INPUT20
53	EQ	G LOW L	INPUT21
54	EQ	G LOW L	INPUT22
55	EQ	G LOW L	INPUT23
56	EQ	G LOW L	INPUT24
57	NO ASSIGN		
58	NO ASSIGN		

#	High	Mid	Low
59	NO ASSIGN		
60	NO ASSIGN		
61	NO ASSIGN		
62	NO ASSIGN		
63	NO ASSIGN		
64	EQ	F LOW	INPUT1
65	EQ	F LOW	INPUT2
66	EQ	F LOW	INPUT3
67	EQ	F LOW	INPUT4
68	EQ	F LOW	INPUT5
69	EQ	F LOW	INPUT6
70	EQ	F LOW	INPUT7
71	EQ	F LOW	INPUT8
72	EQ	F LOW	INPUT9
73	EQ	F LOW	INPUT10
74	EQ	F LOW	INPUT11
75	EQ	F LOW	INPUT12
76	EQ	F LOW	INPUT13
77	EQ	F LOW	INPUT14
78	EQ	F LOW	INPUT15
79	EQ	F LOW	INPUT16
80	EQ	F LOW	INPUT17
81	EQ	F LOW	INPUT18
82	EQ	F LOW	INPUT19
83	EQ	F LOW	INPUT20
84	EQ	F LOW	INPUT21
85	EQ	F LOW	INPUT22
86	EQ	F LOW	INPUT23
87	EQ	F LOW	INPUT24
88	NO ASSIGN		
89	EQ	Q LOW	INPUT1
90	EQ	Q LOW	INPUT2
91	EQ	Q LOW	INPUT3
92	EQ	Q LOW	INPUT4
93	EQ	Q LOW	INPUT5
94	EQ	Q LOW	INPUT6
95	EQ	Q LOW	INPUT7
102	EQ	Q LOW	INPUT8
103	EQ	Q LOW	INPUT9
104	EQ	Q LOW	INPUT10
105	EQ	Q LOW	INPUT11
106	EQ	Q LOW	INPUT12
107	EQ	Q LOW	INPUT13
108	EQ	Q LOW	INPUT14
109	EQ	Q LOW	INPUT15
110	EQ	Q LOW	INPUT16
111	EQ	Q LOW	INPUT17
112	EQ	Q LOW	INPUT18
113	EQ	Q LOW	INPUT19
114	EQ	Q LOW	INPUT20
115	EQ	Q LOW	INPUT21
116	EQ	Q LOW	INPUT22
117	EQ	Q LOW	INPUT23
118	EQ	Q LOW	INPUT24
119	NO ASSIGN		

CHANNEL4

#	High	Mid	Low
0	NO ASSIGN		
1	EQ	G LOW H	INPUT25
2	EQ	G LOW H	INPUT26
3	EQ	G LOW H	INPUT27
4	EQ	G LOW H	INPUT28
5	EQ	G LOW H	INPUT29
6	EQ	G LOW H	INPUT30
7	EQ	G LOW H	INPUT31
8	EQ	G LOW H	INPUT32
9	EQ	G LOW H	ST-IN1
10	EQ	G LOW H	ST-IN2
11	EQ	G LOW H	ST-IN3
12	EQ	G LOW H	ST-IN4
13	NO ASSIGN		
14	NO ASSIGN		
15	NO ASSIGN		
16	NO ASSIGN		
17	NO ASSIGN		
18	NO ASSIGN		
19	NO ASSIGN		
20	NO ASSIGN		
21	NO ASSIGN		
22	NO ASSIGN		
23	NO ASSIGN		
24	NO ASSIGN		
25	NO ASSIGN		
26	NO ASSIGN		
27	NO ASSIGN		
28	NO ASSIGN		
29	NO ASSIGN		
30	NO ASSIGN		
31	NO ASSIGN		
32	NO ASSIGN		
33	EQ	G LOW L	INPUT25
34	EQ	G LOW L	INPUT26
35	EQ	G LOW L	INPUT27
36	EQ	G LOW L	INPUT28
37	EQ	G LOW L	INPUT29
38	EQ	G LOW L	INPUT30
39	EQ	G LOW L	INPUT31
40	EQ	G LOW L	INPUT32
41	EQ	G LOW L	ST-IN1
42	EQ	G LOW L	ST-IN2
43	EQ	G LOW L	ST-IN3
44	EQ	G LOW L	ST-IN4
45	NO ASSIGN		
46	NO ASSIGN		
47	NO ASSIGN		
48	NO ASSIGN		
49	NO ASSIGN		
50	NO ASSIGN		
51	NO ASSIGN		
52	NO ASSIGN		
53	NO ASSIGN		
54	NO ASSIGN		
55	NO ASSIGN		
56	NO ASSIGN		
57	NO ASSIGN		
58	NO ASSIGN		

#	High	Mid	Low
59	NO ASSIGN		
60	NO ASSIGN		
61	NO ASSIGN		
62	NO ASSIGN		
63	NO ASSIGN		
64	EQ	F LOW	INPUT25
65	EQ	F LOW	INPUT26
66	EQ	F LOW	INPUT27
67	EQ	F LOW	INPUT28
68	EQ	F LOW	INPUT29
69	EQ	F LOW	INPUT30
70	EQ	F LOW	INPUT31
71	EQ	F LOW	INPUT32
72	EQ	F LOW	ST-IN1
73	EQ	F LOW	ST-IN2
74	EQ	F LOW	ST-IN3
75	EQ	F LOW	ST-IN4
76	NO ASSIGN		
77	NO ASSIGN		
78	NO ASSIGN		
79	NO ASSIGN		
80	NO ASSIGN		
81	NO ASSIGN		
82	NO ASSIGN		
83	NO ASSIGN		
84	NO ASSIGN		
85	NO ASSIGN		
86	NO ASSIGN		
87	NO ASSIGN		
88	NO ASSIGN		
89	EQ	Q LOW	INPUT25
90	EQ	Q LOW	INPUT26
91	EQ	Q LOW	INPUT27
92	EQ	Q LOW	INPUT28
93	EQ	Q LOW	INPUT29
94	EQ	Q LOW	INPUT30
95	EQ	Q LOW	INPUT31
102	EQ	Q LOW	INPUT32
103	EQ	Q LOW	ST-IN1
104	EQ	Q LOW	ST-IN2
105	EQ	Q LOW	ST-IN3
106	EQ	Q LOW	ST-IN4
107	NO ASSIGN		
108	NO ASSIGN		
109	NO ASSIGN		
110	NO ASSIGN		
111	NO ASSIGN		
112	NO ASSIGN		
113	NO ASSIGN		
114	NO ASSIGN		
115	NO ASSIGN		
116	NO ASSIGN		
117	NO ASSIGN		
118	NO ASSIGN		
119	NO ASSIGN		

CHANNELS

#	High	Mid	Low
0	NO ASSIGN		
1	EQ	G LO-MID H	INPUT1
2	EQ	G LO-MID H	INPUT2
3	EQ	G LO-MID H	INPUT3
4	EQ	G LO-MID H	INPUT4
5	EQ	G LO-MID H	INPUT5
6	EQ	G LO-MID H	INPUT6
7	EQ	G LO-MID H	INPUT7
8	EQ	G LO-MID H	INPUT8
9	EQ	G LO-MID H	INPUT9
10	EQ	G LO-MID H	INPUT10
11	EQ	G LO-MID H	INPUT11
12	EQ	G LO-MID H	INPUT12
13	EQ	G LO-MID H	INPUT13
14	EQ	G LO-MID H	INPUT14
15	EQ	G LO-MID H	INPUT15
16	EQ	G LO-MID H	INPUT16
17	EQ	G LO-MID H	INPUT17
18	EQ	G LO-MID H	INPUT18
19	EQ	G LO-MID H	INPUT19
20	EQ	G LO-MID H	INPUT20
21	EQ	G LO-MID H	INPUT21
22	EQ	G LO-MID H	INPUT22
23	EQ	G LO-MID H	INPUT23
24	EQ	G LO-MID H	INPUT24
25	NO ASSIGN		
26	NO ASSIGN		
27	NO ASSIGN		
28	NO ASSIGN		
29	NO ASSIGN		
30	NO ASSIGN		
31	NO ASSIGN		
32	NO ASSIGN		
33	EQ	G LO-MID L	INPUT1
34	EQ	G LO-MID L	INPUT2
35	EQ	G LO-MID L	INPUT3
36	EQ	G LO-MID L	INPUT4
37	EQ	G LO-MID L	INPUT5
38	EQ	G LO-MID L	INPUT6
39	EQ	G LO-MID L	INPUT7
40	EQ	G LO-MID L	INPUT8
41	EQ	G LO-MID L	INPUT9
42	EQ	G LO-MID L	INPUT10
43	EQ	G LO-MID L	INPUT11
44	EQ	G LO-MID L	INPUT12
45	EQ	G LO-MID L	INPUT13
46	EQ	G LO-MID L	INPUT14
47	EQ	G LO-MID L	INPUT15
48	EQ	G LO-MID L	INPUT16
49	EQ	G LO-MID L	INPUT17
50	EQ	G LO-MID L	INPUT18
51	EQ	G LO-MID L	INPUT19
52	EQ	G LO-MID L	INPUT20
53	EQ	G LO-MID L	INPUT21
54	EQ	G LO-MID L	INPUT22
55	EQ	G LO-MID L	INPUT23
56	EQ	G LO-MID L	INPUT24
57	NO ASSIGN		
58	NO ASSIGN		

#	High	Mid	Low
59	NO ASSIGN		
60	NO ASSIGN		
61	NO ASSIGN		
62	NO ASSIGN		
63	NO ASSIGN		
64	EQ	F LO-MID	INPUT1
65	EQ	F LO-MID	INPUT2
66	EQ	F LO-MID	INPUT3
67	EQ	F LO-MID	INPUT4
68	EQ	F LO-MID	INPUT5
69	EQ	F LO-MID	INPUT6
70	EQ	F LO-MID	INPUT7
71	EQ	F LO-MID	INPUT8
72	EQ	F LO-MID	INPUT9
73	EQ	F LO-MID	INPUT10
74	EQ	F LO-MID	INPUT11
75	EQ	F LO-MID	INPUT12
76	EQ	F LO-MID	INPUT13
77	EQ	F LO-MID	INPUT14
78	EQ	F LO-MID	INPUT15
79	EQ	F LO-MID	INPUT16
80	EQ	F LO-MID	INPUT17
81	EQ	F LO-MID	INPUT18
82	EQ	F LO-MID	INPUT19
83	EQ	F LO-MID	INPUT20
84	EQ	F LO-MID	INPUT21
85	EQ	F LO-MID	INPUT22
86	EQ	F LO-MID	INPUT23
87	EQ	F LO-MID	INPUT24
88	NO ASSIGN		
89	EQ	Q LO-MID	INPUT1
90	EQ	Q LO-MID	INPUT2
91	EQ	Q LO-MID	INPUT3
92	EQ	Q LO-MID	INPUT4
93	EQ	Q LO-MID	INPUT5
94	EQ	Q LO-MID	INPUT6
95	EQ	Q LO-MID	INPUT7
102	EQ	Q LO-MID	INPUT8
103	EQ	Q LO-MID	INPUT9
104	EQ	Q LO-MID	INPUT10
105	EQ	Q LO-MID	INPUT11
106	EQ	Q LO-MID	INPUT12
107	EQ	Q LO-MID	INPUT13
108	EQ	Q LO-MID	INPUT14
109	EQ	Q LO-MID	INPUT15
110	EQ	Q LO-MID	INPUT16
111	EQ	Q LO-MID	INPUT17
112	EQ	Q LO-MID	INPUT18
113	EQ	Q LO-MID	INPUT19
114	EQ	Q LO-MID	INPUT20
115	EQ	Q LO-MID	INPUT21
116	EQ	Q LO-MID	INPUT22
117	EQ	Q LO-MID	INPUT23
118	EQ	Q LO-MID	INPUT24
119	NO ASSIGN		

CHANNEL6

#	High	Mid	Low
0	NO ASSIGN		
1	EQ	G LO-MID H	INPUT25
2	EQ	G LO-MID H	INPUT26
3	EQ	G LO-MID H	INPUT27
4	EQ	G LO-MID H	INPUT28
5	EQ	G LO-MID H	INPUT29
6	EQ	G LO-MID H	INPUT30
7	EQ	G LO-MID H	INPUT31
8	EQ	G LO-MID H	INPUT32
9	EQ	G LO-MID H	ST-IN1
10	EQ	G LO-MID H	ST-IN2
11	EQ	G LO-MID H	ST-IN3
12	EQ	G LO-MID H	ST-IN4
13	NO ASSIGN		
14	NO ASSIGN		
15	NO ASSIGN		
16	NO ASSIGN		
17	NO ASSIGN		
18	NO ASSIGN		
19	NO ASSIGN		
20	NO ASSIGN		
21	NO ASSIGN		
22	NO ASSIGN		
23	NO ASSIGN		
24	NO ASSIGN		
25	NO ASSIGN		
26	NO ASSIGN		
27	NO ASSIGN		
28	NO ASSIGN		
29	NO ASSIGN		
30	NO ASSIGN		
31	NO ASSIGN		
32	NO ASSIGN		
33	EQ	G LO-MID L	INPUT25
34	EQ	G LO-MID L	INPUT26
35	EQ	G LO-MID L	INPUT27
36	EQ	G LO-MID L	INPUT28
37	EQ	G LO-MID L	INPUT29
38	EQ	G LO-MID L	INPUT30
39	EQ	G LO-MID L	INPUT31
40	EQ	G LO-MID L	INPUT32
41	EQ	G LO-MID L	ST-IN1
42	EQ	G LO-MID L	ST-IN2
43	EQ	G LO-MID L	ST-IN3
44	EQ	G LO-MID L	ST-IN4
45	NO ASSIGN		
46	NO ASSIGN		
47	NO ASSIGN		
48	NO ASSIGN		
49	NO ASSIGN		
50	NO ASSIGN		
51	NO ASSIGN		
52	NO ASSIGN		
53	NO ASSIGN		
54	NO ASSIGN		
55	NO ASSIGN		
56	NO ASSIGN		
57	NO ASSIGN		
58	NO ASSIGN		

#	High	Mid	Low
59	NO ASSIGN		
60	NO ASSIGN		
61	NO ASSIGN		
62	NO ASSIGN		
63	NO ASSIGN		
64	EQ	F LO-MID	INPUT25
65	EQ	F LO-MID	INPUT26
66	EQ	F LO-MID	INPUT27
67	EQ	F LO-MID	INPUT28
68	EQ	F LO-MID	INPUT29
69	EQ	F LO-MID	INPUT30
70	EQ	F LO-MID	INPUT31
71	EQ	F LO-MID	INPUT32
72	EQ	F LO-MID	ST-IN1
73	EQ	F LO-MID	ST-IN2
74	EQ	F LO-MID	ST-IN3
75	EQ	F LO-MID	ST-IN4
76	NO ASSIGN		
77	NO ASSIGN		
78	NO ASSIGN		
79	NO ASSIGN		
80	NO ASSIGN		
81	NO ASSIGN		
82	NO ASSIGN		
83	NO ASSIGN		
84	NO ASSIGN		
85	NO ASSIGN		
86	NO ASSIGN		
87	NO ASSIGN		
88	NO ASSIGN		
89	EQ	Q LO-MID	INPUT25
90	EQ	Q LO-MID	INPUT26
91	EQ	Q LO-MID	INPUT27
92	EQ	Q LO-MID	INPUT28
93	EQ	Q LO-MID	INPUT29
94	EQ	Q LO-MID	INPUT30
95	EQ	Q LO-MID	INPUT31
102	EQ	Q LO-MID	INPUT32
103	EQ	Q LO-MID	ST-IN1
104	EQ	Q LO-MID	ST-IN2
105	EQ	Q LO-MID	ST-IN3
106	EQ	Q LO-MID	ST-IN4
107	NO ASSIGN		
108	NO ASSIGN		
109	NO ASSIGN		
110	NO ASSIGN		
111	NO ASSIGN		
112	NO ASSIGN		
113	NO ASSIGN		
114	NO ASSIGN		
115	NO ASSIGN		
116	NO ASSIGN		
117	NO ASSIGN		
118	NO ASSIGN		
119	NO ASSIGN		

CHANNEL 7

#	High	Mid	Low
0	NO ASSIGN		
1	EQ	G HI-MID H	INPUT1
2	EQ	G HI-MID H	INPUT2
3	EQ	G HI-MID H	INPUT3
4	EQ	G HI-MID H	INPUT4
5	EQ	G HI-MID H	INPUT5
6	EQ	G HI-MID H	INPUT6
7	EQ	G HI-MID H	INPUT7
8	EQ	G HI-MID H	INPUT8
9	EQ	G HI-MID H	INPUT9
10	EQ	G HI-MID H	INPUT10
11	EQ	G HI-MID H	INPUT11
12	EQ	G HI-MID H	INPUT12
13	EQ	G HI-MID H	INPUT13
14	EQ	G HI-MID H	INPUT14
15	EQ	G HI-MID H	INPUT15
16	EQ	G HI-MID H	INPUT16
17	EQ	G HI-MID H	INPUT17
18	EQ	G HI-MID H	INPUT18
19	EQ	G HI-MID H	INPUT19
20	EQ	G HI-MID H	INPUT20
21	EQ	G HI-MID H	INPUT21
22	EQ	G HI-MID H	INPUT22
23	EQ	G HI-MID H	INPUT23
24	EQ	G HI-MID H	INPUT24
25	NO ASSIGN		
26	NO ASSIGN		
27	NO ASSIGN		
28	NO ASSIGN		
29	NO ASSIGN		
30	NO ASSIGN		
31	NO ASSIGN		
32	NO ASSIGN		
33	EQ	G HI-MID L	INPUT1
34	EQ	G HI-MID L	INPUT2
35	EQ	G HI-MID L	INPUT3
36	EQ	G HI-MID L	INPUT4
37	EQ	G HI-MID L	INPUT5
38	EQ	G HI-MID L	INPUT6
39	EQ	G HI-MID L	INPUT7
40	EQ	G HI-MID L	INPUT8
41	EQ	G HI-MID L	INPUT9
42	EQ	G HI-MID L	INPUT10
43	EQ	G HI-MID L	INPUT11
44	EQ	G HI-MID L	INPUT12
45	EQ	G HI-MID L	INPUT13
46	EQ	G HI-MID L	INPUT14
47	EQ	G HI-MID L	INPUT15
48	EQ	G HI-MID L	INPUT16
49	EQ	G HI-MID L	INPUT17
50	EQ	G HI-MID L	INPUT18
51	EQ	G HI-MID L	INPUT19
52	EQ	G HI-MID L	INPUT20
53	EQ	G HI-MID L	INPUT21
54	EQ	G HI-MID L	INPUT22
55	EQ	G HI-MID L	INPUT23
56	EQ	G HI-MID L	INPUT24
57	NO ASSIGN		
58	NO ASSIGN		

#	High	Mid	Low
59	NO ASSIGN		
60	NO ASSIGN		
61	NO ASSIGN		
62	NO ASSIGN		
63	NO ASSIGN		
64	EQ	F HI-MID	INPUT1
65	EQ	F HI-MID	INPUT2
66	EQ	F HI-MID	INPUT3
67	EQ	F HI-MID	INPUT4
68	EQ	F HI-MID	INPUT5
69	EQ	F HI-MID	INPUT6
70	EQ	F HI-MID	INPUT7
71	EQ	F HI-MID	INPUT8
72	EQ	F HI-MID	INPUT9
73	EQ	F HI-MID	INPUT10
74	EQ	F HI-MID	INPUT11
75	EQ	F HI-MID	INPUT12
76	EQ	F HI-MID	INPUT13
77	EQ	F HI-MID	INPUT14
78	EQ	F HI-MID	INPUT15
79	EQ	F HI-MID	INPUT16
80	EQ	F HI-MID	INPUT17
81	EQ	F HI-MID	INPUT18
82	EQ	F HI-MID	INPUT19
83	EQ	F HI-MID	INPUT20
84	EQ	F HI-MID	INPUT21
85	EQ	F HI-MID	INPUT22
86	EQ	F HI-MID	INPUT23
87	EQ	F HI-MID	INPUT24
88	NO ASSIGN		
89	EQ	Q HI-MID	INPUT1
90	EQ	Q HI-MID	INPUT2
91	EQ	Q HI-MID	INPUT3
92	EQ	Q HI-MID	INPUT4
93	EQ	Q HI-MID	INPUT5
94	EQ	Q HI-MID	INPUT6
95	EQ	Q HI-MID	INPUT7
102	EQ	Q HI-MID	INPUT8
103	EQ	Q HI-MID	INPUT9
104	EQ	Q HI-MID	INPUT10
105	EQ	Q HI-MID	INPUT11
106	EQ	Q HI-MID	INPUT12
107	EQ	Q HI-MID	INPUT13
108	EQ	Q HI-MID	INPUT14
109	EQ	Q HI-MID	INPUT15
110	EQ	Q HI-MID	INPUT16
111	EQ	Q HI-MID	INPUT17
112	EQ	Q HI-MID	INPUT18
113	EQ	Q HI-MID	INPUT19
114	EQ	Q HI-MID	INPUT20
115	EQ	Q HI-MID	INPUT21
116	EQ	Q HI-MID	INPUT22
117	EQ	Q HI-MID	INPUT23
118	EQ	Q HI-MID	INPUT24
119	NO ASSIGN		

CHANNEL8

#	High	Mid	Low
0	NO ASSIGN		
1	EQ	G HI-MID H	INPUT25
2	EQ	G HI-MID H	INPUT26
3	EQ	G HI-MID H	INPUT27
4	EQ	G HI-MID H	INPUT28
5	EQ	G HI-MID H	INPUT29
6	EQ	G HI-MID H	INPUT30
7	EQ	G HI-MID H	INPUT31
8	EQ	G HI-MID H	INPUT32
9	EQ	G HI-MID H	ST-IN1
10	EQ	G HI-MID H	ST-IN2
11	EQ	G HI-MID H	ST-IN3
12	EQ	G HI-MID H	ST-IN4
13	NO ASSIGN		
14	NO ASSIGN		
15	NO ASSIGN		
16	NO ASSIGN		
17	NO ASSIGN		
18	NO ASSIGN		
19	NO ASSIGN		
20	NO ASSIGN		
21	NO ASSIGN		
22	NO ASSIGN		
23	NO ASSIGN		
24	NO ASSIGN		
25	NO ASSIGN		
26	NO ASSIGN		
27	NO ASSIGN		
28	NO ASSIGN		
29	NO ASSIGN		
30	NO ASSIGN		
31	NO ASSIGN		
32	NO ASSIGN		
33	EQ	G HI-MID L	INPUT25
34	EQ	G HI-MID L	INPUT26
35	EQ	G HI-MID L	INPUT27
36	EQ	G HI-MID L	INPUT28
37	EQ	G HI-MID L	INPUT29
38	EQ	G HI-MID L	INPUT30
39	EQ	G HI-MID L	INPUT31
40	EQ	G HI-MID L	INPUT32
41	EQ	G HI-MID L	ST-IN1
42	EQ	G HI-MID L	ST-IN2
43	EQ	G HI-MID L	ST-IN3
44	EQ	G HI-MID L	ST-IN4
45	NO ASSIGN		
46	NO ASSIGN		
47	NO ASSIGN		
48	NO ASSIGN		
49	NO ASSIGN		
50	NO ASSIGN		
51	NO ASSIGN		
52	NO ASSIGN		
53	NO ASSIGN		
54	NO ASSIGN		
55	NO ASSIGN		
56	NO ASSIGN		
57	NO ASSIGN		
58	NO ASSIGN		

#	High	Mid	Low
59	NO ASSIGN		
60	NO ASSIGN		
61	NO ASSIGN		
62	NO ASSIGN		
63	NO ASSIGN		
64	EQ	F HI-MID	INPUT25
65	EQ	F HI-MID	INPUT26
66	EQ	F HI-MID	INPUT27
67	EQ	F HI-MID	INPUT28
68	EQ	F HI-MID	INPUT29
69	EQ	F HI-MID	INPUT30
70	EQ	F HI-MID	INPUT31
71	EQ	F HI-MID	INPUT32
72	EQ	F HI-MID	ST-IN1
73	EQ	F HI-MID	ST-IN2
74	EQ	F HI-MID	ST-IN3
75	EQ	F HI-MID	ST-IN4
76	NO ASSIGN		
77	NO ASSIGN		
78	NO ASSIGN		
79	NO ASSIGN		
80	NO ASSIGN		
81	NO ASSIGN		
82	NO ASSIGN		
83	NO ASSIGN		
84	NO ASSIGN		
85	NO ASSIGN		
86	NO ASSIGN		
87	NO ASSIGN		
88	NO ASSIGN		
89	EQ	Q HI-MID	INPUT25
90	EQ	Q HI-MID	INPUT26
91	EQ	Q HI-MID	INPUT27
92	EQ	Q HI-MID	INPUT28
93	EQ	Q HI-MID	INPUT29
94	EQ	Q HI-MID	INPUT30
95	EQ	Q HI-MID	INPUT31
102	EQ	Q HI-MID	INPUT32
103	EQ	Q HI-MID	ST-IN1
104	EQ	Q HI-MID	ST-IN2
105	EQ	Q HI-MID	ST-IN3
106	EQ	Q HI-MID	ST-IN4
107	NO ASSIGN		
108	NO ASSIGN		
109	NO ASSIGN		
110	NO ASSIGN		
111	NO ASSIGN		
112	NO ASSIGN		
113	NO ASSIGN		
114	NO ASSIGN		
115	NO ASSIGN		
116	NO ASSIGN		
117	NO ASSIGN		
118	NO ASSIGN		
119	NO ASSIGN		

CHANNEL9

#	High	Mid	Low
0	NO ASSIGN		
1	EQ	G HIGH H	INPUT1
2	EQ	G HIGH H	INPUT2
3	EQ	G HIGH H	INPUT3
4	EQ	G HIGH H	INPUT4
5	EQ	G HIGH H	INPUT5
6	EQ	G HIGH H	INPUT6
7	EQ	G HIGH H	INPUT7
8	EQ	G HIGH H	INPUT8
9	EQ	G HIGH H	INPUT9
10	EQ	G HIGH H	INPUT10
11	EQ	G HIGH H	INPUT11
12	EQ	G HIGH H	INPUT12
13	EQ	G HIGH H	INPUT13
14	EQ	G HIGH H	INPUT14
15	EQ	G HIGH H	INPUT15
16	EQ	G HIGH H	INPUT16
17	EQ	G HIGH H	INPUT17
18	EQ	G HIGH H	INPUT18
19	EQ	G HIGH H	INPUT19
20	EQ	G HIGH H	INPUT20
21	EQ	G HIGH H	INPUT21
22	EQ	G HIGH H	INPUT22
23	EQ	G HIGH H	INPUT23
24	EQ	G HIGH H	INPUT24
25	NO ASSIGN		
26	NO ASSIGN		
27	NO ASSIGN		
28	NO ASSIGN		
29	NO ASSIGN		
30	NO ASSIGN		
31	NO ASSIGN		
32	NO ASSIGN		
33	EQ	G HIGH L	INPUT1
34	EQ	G HIGH L	INPUT2
35	EQ	G HIGH L	INPUT3
36	EQ	G HIGH L	INPUT4
37	EQ	G HIGH L	INPUT5
38	EQ	G HIGH L	INPUT6
39	EQ	G HIGH L	INPUT7
40	EQ	G HIGH L	INPUT8
41	EQ	G HIGH L	INPUT9
42	EQ	G HIGH L	INPUT10
43	EQ	G HIGH L	INPUT11
44	EQ	G HIGH L	INPUT12
45	EQ	G HIGH L	INPUT13
46	EQ	G HIGH L	INPUT14
47	EQ	G HIGH L	INPUT15
48	EQ	G HIGH L	INPUT16
49	EQ	G HIGH L	INPUT17
50	EQ	G HIGH L	INPUT18
51	EQ	G HIGH L	INPUT19
52	EQ	G HIGH L	INPUT20
53	EQ	G HIGH L	INPUT21
54	EQ	G HIGH L	INPUT22
55	EQ	G HIGH L	INPUT23
56	EQ	G HIGH L	INPUT24
57	NO ASSIGN		
58	NO ASSIGN		

#	High	Mid	Low
59	NO ASSIGN		
60	NO ASSIGN		
61	NO ASSIGN		
62	NO ASSIGN		
63	NO ASSIGN		
64	EQ	F HIGH	INPUT1
65	EQ	F HIGH	INPUT2
66	EQ	F HIGH	INPUT3
67	EQ	F HIGH	INPUT4
68	EQ	F HIGH	INPUT5
69	EQ	F HIGH	INPUT6
70	EQ	F HIGH	INPUT7
71	EQ	F HIGH	INPUT8
72	EQ	F HIGH	INPUT9
73	EQ	F HIGH	INPUT10
74	EQ	F HIGH	INPUT11
75	EQ	F HIGH	INPUT12
76	EQ	F HIGH	INPUT13
77	EQ	F HIGH	INPUT14
78	EQ	F HIGH	INPUT15
79	EQ	F HIGH	INPUT16
80	EQ	F HIGH	INPUT17
81	EQ	F HIGH	INPUT18
82	EQ	F HIGH	INPUT19
83	EQ	F HIGH	INPUT20
84	EQ	F HIGH	INPUT21
85	EQ	F HIGH	INPUT22
86	EQ	F HIGH	INPUT23
87	EQ	F HIGH	INPUT24
88	NO ASSIGN		
89	EQ	Q HIGH	INPUT1
90	EQ	Q HIGH	INPUT2
91	EQ	Q HIGH	INPUT3
92	EQ	Q HIGH	INPUT4
93	EQ	Q HIGH	INPUT5
94	EQ	Q HIGH	INPUT6
95	EQ	Q HIGH	INPUT7
102	EQ	Q HIGH	INPUT8
103	EQ	Q HIGH	INPUT9
104	EQ	Q HIGH	INPUT10
105	EQ	Q HIGH	INPUT11
106	EQ	Q HIGH	INPUT12
107	EQ	Q HIGH	INPUT13
108	EQ	Q HIGH	INPUT14
109	EQ	Q HIGH	INPUT15
110	EQ	Q HIGH	INPUT16
111	EQ	Q HIGH	INPUT17
112	EQ	Q HIGH	INPUT18
113	EQ	Q HIGH	INPUT19
114	EQ	Q HIGH	INPUT20
115	EQ	Q HIGH	INPUT21
116	EQ	Q HIGH	INPUT22
117	EQ	Q HIGH	INPUT23
118	EQ	Q HIGH	INPUT24
119	NO ASSIGN		

CHANNEL10

#	High	Mid	Low
0	NO ASSIGN		
1	EQ	G HIGH H	INPUT25
2	EQ	G HIGH H	INPUT26
3	EQ	G HIGH H	INPUT27
4	EQ	G HIGH H	INPUT28
5	EQ	G HIGH H	INPUT29
6	EQ	G HIGH H	INPUT30
7	EQ	G HIGH H	INPUT31
8	EQ	G HIGH H	INPUT32
9	EQ	G HIGH H	ST-IN1
10	EQ	G HIGH H	ST-IN2
11	EQ	G HIGH H	ST-IN3
12	EQ	G HIGH H	ST-IN4
13	NO ASSIGN		
14	NO ASSIGN		
15	NO ASSIGN		
16	NO ASSIGN		
17	NO ASSIGN		
18	NO ASSIGN		
19	NO ASSIGN		
20	NO ASSIGN		
21	NO ASSIGN		
22	NO ASSIGN		
23	NO ASSIGN		
24	NO ASSIGN		
25	NO ASSIGN		
26	NO ASSIGN		
27	NO ASSIGN		
28	NO ASSIGN		
29	NO ASSIGN		
30	NO ASSIGN		
31	NO ASSIGN		
32	NO ASSIGN		
33	EQ	G HIGH L	INPUT25
34	EQ	G HIGH L	INPUT26
35	EQ	G HIGH L	INPUT27
36	EQ	G HIGH L	INPUT28
37	EQ	G HIGH L	INPUT29
38	EQ	G HIGH L	INPUT30
39	EQ	G HIGH L	INPUT31
40	EQ	G HIGH L	INPUT32
41	EQ	G HIGH L	ST-IN1
42	EQ	G HIGH L	ST-IN2
43	EQ	G HIGH L	ST-IN3
44	EQ	G HIGH L	ST-IN4
45	NO ASSIGN		
46	NO ASSIGN		
47	NO ASSIGN		
48	NO ASSIGN		
49	NO ASSIGN		
50	NO ASSIGN		
51	NO ASSIGN		
52	NO ASSIGN		
53	NO ASSIGN		
54	NO ASSIGN		
55	NO ASSIGN		
56	NO ASSIGN		
57	NO ASSIGN		
58	NO ASSIGN		

#	High	Mid	Low
59	NO ASSIGN		
60	NO ASSIGN		
61	NO ASSIGN		
62	NO ASSIGN		
63	NO ASSIGN		
64	EQ	F HIGH	INPUT25
65	EQ	F HIGH	INPUT26
66	EQ	F HIGH	INPUT27
67	EQ	F HIGH	INPUT28
68	EQ	F HIGH	INPUT29
69	EQ	F HIGH	INPUT30
70	EQ	F HIGH	INPUT31
71	EQ	F HIGH	INPUT32
72	EQ	F HIGH	ST-IN1
73	EQ	F HIGH	ST-IN2
74	EQ	F HIGH	ST-IN3
75	EQ	F HIGH	ST-IN4
76	NO ASSIGN		
77	NO ASSIGN		
78	NO ASSIGN		
79	NO ASSIGN		
80	NO ASSIGN		
81	NO ASSIGN		
82	NO ASSIGN		
83	NO ASSIGN		
84	NO ASSIGN		
85	NO ASSIGN		
86	NO ASSIGN		
87	NO ASSIGN		
88	NO ASSIGN		
89	EQ	Q HIGH	INPUT25
90	EQ	Q HIGH	INPUT26
91	EQ	Q HIGH	INPUT27
92	EQ	Q HIGH	INPUT28
93	EQ	Q HIGH	INPUT29
94	EQ	Q HIGH	INPUT30
95	EQ	Q HIGH	INPUT31
102	EQ	Q HIGH	INPUT32
103	EQ	Q HIGH	ST-IN1
104	EQ	Q HIGH	ST-IN2
105	EQ	Q HIGH	ST-IN3
106	EQ	Q HIGH	ST-IN4
107	NO ASSIGN		
108	NO ASSIGN		
109	NO ASSIGN		
110	NO ASSIGN		
111	NO ASSIGN		
112	NO ASSIGN		
113	NO ASSIGN		
114	NO ASSIGN		
115	NO ASSIGN		
116	NO ASSIGN		
117	NO ASSIGN		
118	NO ASSIGN		
119	NO ASSIGN		

CHANNEL11

#	High	Mid	Low
0	NO ASSIGN		
1	EQ	ATT H	INPUT1
2	EQ	ATT H	INPUT2
3	EQ	ATT H	INPUT3
4	EQ	ATT H	INPUT4
5	EQ	ATT H	INPUT5
6	EQ	ATT H	INPUT6
7	EQ	ATT H	INPUT7
8	EQ	ATT H	INPUT8
9	EQ	ATT H	INPUT9
10	EQ	ATT H	INPUT10
11	EQ	ATT H	INPUT11
12	EQ	ATT H	INPUT12
13	EQ	ATT H	INPUT13
14	EQ	ATT H	INPUT14
15	EQ	ATT H	INPUT15
16	EQ	ATT H	INPUT16
17	EQ	ATT H	INPUT17
18	EQ	ATT H	INPUT18
19	EQ	ATT H	INPUT19
20	EQ	ATT H	INPUT20
21	EQ	ATT H	INPUT21
22	EQ	ATT H	INPUT22
23	EQ	ATT H	INPUT23
24	EQ	ATT H	INPUT24
25	NO ASSIGN		
26	NO ASSIGN		
27	NO ASSIGN		
28	NO ASSIGN		
29	NO ASSIGN		
30	NO ASSIGN		
31	NO ASSIGN		
32	NO ASSIGN		
33	EQ	ATT L	INPUT1
34	EQ	ATT L	INPUT2
35	EQ	ATT L	INPUT3
36	EQ	ATT L	INPUT4
37	EQ	ATT L	INPUT5
38	EQ	ATT L	INPUT6
39	EQ	ATT L	INPUT7
40	EQ	ATT L	INPUT8
41	EQ	ATT L	INPUT9
42	EQ	ATT L	INPUT10
43	EQ	ATT L	INPUT11
44	EQ	ATT L	INPUT12
45	EQ	ATT L	INPUT13
46	EQ	ATT L	INPUT14
47	EQ	ATT L	INPUT15
48	EQ	ATT L	INPUT16
49	EQ	ATT L	INPUT17
50	EQ	ATT L	INPUT18
51	EQ	ATT L	INPUT19
52	EQ	ATT L	INPUT20
53	EQ	ATT L	INPUT21
54	EQ	ATT L	INPUT22
55	EQ	ATT L	INPUT23
56	EQ	ATT L	INPUT24
57	NO ASSIGN		
58	NO ASSIGN		

#	High	Mid	Low
59	NO ASSIGN		
60	NO ASSIGN		
61	NO ASSIGN		
62	NO ASSIGN		
63	NO ASSIGN		
64	EQ	HPF ON	INPUT1
65	EQ	HPF ON	INPUT2
66	EQ	HPF ON	INPUT3
67	EQ	HPF ON	INPUT4
68	EQ	HPF ON	INPUT5
69	EQ	HPF ON	INPUT6
70	EQ	HPF ON	INPUT7
71	EQ	HPF ON	INPUT8
72	EQ	HPF ON	INPUT9
73	EQ	HPF ON	INPUT10
74	EQ	HPF ON	INPUT11
75	EQ	HPF ON	INPUT12
76	EQ	HPF ON	INPUT13
77	EQ	HPF ON	INPUT14
78	EQ	HPF ON	INPUT15
79	EQ	HPF ON	INPUT16
80	EQ	HPF ON	INPUT17
81	EQ	HPF ON	INPUT18
82	EQ	HPF ON	INPUT19
83	EQ	HPF ON	INPUT20
84	EQ	HPF ON	INPUT21
85	EQ	HPF ON	INPUT22
86	EQ	HPF ON	INPUT23
87	EQ	HPF ON	INPUT24
88	NO ASSIGN		
89	EQ	LPF ON	INPUT1
90	EQ	LPF ON	INPUT2
91	EQ	LPF ON	INPUT3
92	EQ	LPF ON	INPUT4
93	EQ	LPF ON	INPUT5
94	EQ	LPF ON	INPUT6
95	EQ	LPF ON	INPUT7
102	EQ	LPF ON	INPUT8
103	EQ	LPF ON	INPUT9
104	EQ	LPF ON	INPUT10
105	EQ	LPF ON	INPUT11
106	EQ	LPF ON	INPUT12
107	EQ	LPF ON	INPUT13
108	EQ	LPF ON	INPUT14
109	EQ	LPF ON	INPUT15
110	EQ	LPF ON	INPUT16
111	EQ	LPF ON	INPUT17
112	EQ	LPF ON	INPUT18
113	EQ	LPF ON	INPUT19
114	EQ	LPF ON	INPUT20
115	EQ	LPF ON	INPUT21
116	EQ	LPF ON	INPUT22
117	EQ	LPF ON	INPUT23
118	EQ	LPF ON	INPUT24
119	NO ASSIGN		

CHANNEL12

#	High	Mid	Low
0	NO ASSIGN		
1	EQ	ATT H	INPUT25
2	EQ	ATT H	INPUT26
3	EQ	ATT H	INPUT27
4	EQ	ATT H	INPUT28
5	EQ	ATT H	INPUT29
6	EQ	ATT H	INPUT30
7	EQ	ATT H	INPUT31
8	EQ	ATT H	INPUT32
9	EQ	ATT H	ST-IN1L
10	EQ	ATT H	ST-IN1R
11	EQ	ATT H	ST-IN2L
12	EQ	ATT H	ST-IN2R
13	EQ	ATT H	ST-IN3L
14	EQ	ATT H	ST-IN3R
15	EQ	ATT H	ST-IN4L
16	EQ	ATT H	ST-IN4R
17	NO ASSIGN		
18	NO ASSIGN		
19	NO ASSIGN		
20	NO ASSIGN		
21	NO ASSIGN		
22	NO ASSIGN		
23	NO ASSIGN		
24	NO ASSIGN		
25	NO ASSIGN		
26	NO ASSIGN		
27	NO ASSIGN		
28	NO ASSIGN		
29	NO ASSIGN		
30	NO ASSIGN		
31	NO ASSIGN		
32	NO ASSIGN		
33	EQ	ATT L	INPUT25
34	EQ	ATT L	INPUT26
35	EQ	ATT L	INPUT27
36	EQ	ATT L	INPUT28
37	EQ	ATT L	INPUT29
38	EQ	ATT L	INPUT30
39	EQ	ATT L	INPUT31
40	EQ	ATT L	INPUT32
41	EQ	ATT L	ST-IN1L
42	EQ	ATT L	ST-IN1R
43	EQ	ATT L	ST-IN2L
44	EQ	ATT L	ST-IN2R
45	EQ	ATT L	ST-IN3L
46	EQ	ATT L	ST-IN3R
47	EQ	ATT L	ST-IN4L
48	EQ	ATT L	ST-IN4R
49	NO ASSIGN		
50	NO ASSIGN		
51	NO ASSIGN		
52	NO ASSIGN		
53	NO ASSIGN		
54	NO ASSIGN		
55	NO ASSIGN		
56	NO ASSIGN		
57	NO ASSIGN		
58	NO ASSIGN		

#	High	Mid	Low
59	NO ASSIGN		
60	NO ASSIGN		
61	NO ASSIGN		
62	NO ASSIGN		
63	NO ASSIGN		
64	EQ	HPF ON	INPUT25
65	EQ	HPF ON	INPUT26
66	EQ	HPF ON	INPUT27
67	EQ	HPF ON	INPUT28
68	EQ	HPF ON	INPUT29
69	EQ	HPF ON	INPUT30
70	EQ	HPF ON	INPUT31
71	EQ	HPF ON	INPUT32
72	EQ	HPF ON	ST-IN1
73	EQ	HPF ON	ST-IN2
74	EQ	HPF ON	ST-IN3
75	EQ	HPF ON	ST-IN4
76	NO ASSIGN		
77	NO ASSIGN		
78	NO ASSIGN		
79	NO ASSIGN		
80	NO ASSIGN		
81	NO ASSIGN		
82	NO ASSIGN		
83	NO ASSIGN		
84	NO ASSIGN		
85	NO ASSIGN		
86	NO ASSIGN		
87	NO ASSIGN		
88	NO ASSIGN		
89	EQ	LPF ON	INPUT25
90	EQ	LPF ON	INPUT26
91	EQ	LPF ON	INPUT27
92	EQ	LPF ON	INPUT28
93	EQ	LPF ON	INPUT29
94	EQ	LPF ON	INPUT30
95	EQ	LPF ON	INPUT31
102	EQ	LPF ON	INPUT32
103	EQ	LPF ON	ST-IN1
104	EQ	LPF ON	ST-IN2
105	EQ	LPF ON	ST-IN3
106	EQ	LPF ON	ST-IN4
107	NO ASSIGN		
108	NO ASSIGN		
109	NO ASSIGN		
110	NO ASSIGN		
111	NO ASSIGN		
112	NO ASSIGN		
113	NO ASSIGN		
114	NO ASSIGN		
115	NO ASSIGN		
116	NO ASSIGN		
117	NO ASSIGN		
118	NO ASSIGN		
119	NO ASSIGN		

CHANNEL13

#	High	Mid	Low
0	NO ASSIGN		
1	SURROUND	LFE H	INPUT1
2	SURROUND	LFE H	INPUT2
3	SURROUND	LFE H	INPUT3
4	SURROUND	LFE H	INPUT4
5	SURROUND	LFE H	INPUT5
6	SURROUND	LFE H	INPUT6
7	SURROUND	LFE H	INPUT7
8	SURROUND	LFE H	INPUT8
9	SURROUND	LFE H	INPUT9
10	SURROUND	LFE H	INPUT10
11	SURROUND	LFE H	INPUT11
12	SURROUND	LFE H	INPUT12
13	SURROUND	LFE H	INPUT13
14	SURROUND	LFE H	INPUT14
15	SURROUND	LFE H	INPUT15
16	SURROUND	LFE H	INPUT16
17	SURROUND	LFE H	INPUT17
18	SURROUND	LFE H	INPUT18
19	SURROUND	LFE H	INPUT19
20	SURROUND	LFE H	INPUT20
21	SURROUND	LFE H	INPUT21
22	SURROUND	LFE H	INPUT22
23	SURROUND	LFE H	INPUT23
24	SURROUND	LFE H	INPUT24
25	NO ASSIGN		
26	NO ASSIGN		
27	NO ASSIGN		
28	NO ASSIGN		
29	NO ASSIGN		
30	NO ASSIGN		
31	NO ASSIGN		
32	NO ASSIGN		
33	SURROUND	LFE L	INPUT1
34	SURROUND	LFE L	INPUT2
35	SURROUND	LFE L	INPUT3
36	SURROUND	LFE L	INPUT4
37	SURROUND	LFE L	INPUT5
38	SURROUND	LFE L	INPUT6
39	SURROUND	LFE L	INPUT7
40	SURROUND	LFE L	INPUT8
41	SURROUND	LFE L	INPUT9
42	SURROUND	LFE L	INPUT10
43	SURROUND	LFE L	INPUT11
44	SURROUND	LFE L	INPUT12
45	SURROUND	LFE L	INPUT13
46	SURROUND	LFE L	INPUT14
47	SURROUND	LFE L	INPUT15
48	SURROUND	LFE L	INPUT16
49	SURROUND	LFE L	INPUT17
50	SURROUND	LFE L	INPUT18
51	SURROUND	LFE L	INPUT19
52	SURROUND	LFE L	INPUT20
53	SURROUND	LFE L	INPUT21
54	SURROUND	LFE L	INPUT22
55	SURROUND	LFE L	INPUT23
56	SURROUND	LFE L	INPUT24
57	NO ASSIGN		
58	NO ASSIGN		

#	High	Mid	Low
59	NO ASSIGN		
60	NO ASSIGN		
61	NO ASSIGN		
62	NO ASSIGN		
63	NO ASSIGN		
64	SURROUND	DIV F	INPUT1
65	SURROUND	DIV F	INPUT2
66	SURROUND	DIV F	INPUT3
67	SURROUND	DIV F	INPUT4
68	SURROUND	DIV F	INPUT5
69	SURROUND	DIV F	INPUT6
70	SURROUND	DIV F	INPUT7
71	SURROUND	DIV F	INPUT8
72	SURROUND	DIV F	INPUT9
73	SURROUND	DIV F	INPUT10
74	SURROUND	DIV F	INPUT11
75	SURROUND	DIV F	INPUT12
76	SURROUND	DIV F	INPUT13
77	SURROUND	DIV F	INPUT14
78	SURROUND	DIV F	INPUT15
79	SURROUND	DIV F	INPUT16
80	SURROUND	DIV F	INPUT17
81	SURROUND	DIV F	INPUT18
82	SURROUND	DIV F	INPUT19
83	SURROUND	DIV F	INPUT20
84	SURROUND	DIV F	INPUT21
85	SURROUND	DIV F	INPUT22
86	SURROUND	DIV F	INPUT23
87	SURROUND	DIV F	INPUT24
88	NO ASSIGN		
89	EQ	ON	INPUT1
90	EQ	ON	INPUT2
91	EQ	ON	INPUT3
92	EQ	ON	INPUT4
93	EQ	ON	INPUT5
94	EQ	ON	INPUT6
95	EQ	ON	INPUT7
102	EQ	ON	INPUT8
103	EQ	ON	INPUT9
104	EQ	ON	INPUT10
105	EQ	ON	INPUT11
106	EQ	ON	INPUT12
107	EQ	ON	INPUT13
108	EQ	ON	INPUT14
109	EQ	ON	INPUT15
110	EQ	ON	INPUT16
111	EQ	ON	INPUT17
112	EQ	ON	INPUT18
113	EQ	ON	INPUT19
114	EQ	ON	INPUT20
115	EQ	ON	INPUT21
116	EQ	ON	INPUT22
117	EQ	ON	INPUT23
118	EQ	ON	INPUT24
119	NO ASSIGN		

CHANNEL14

#	High	Mid	Low
0	NO ASSIGN		
1	SURROUND	LFE H	INPUT25
2	SURROUND	LFE H	INPUT26
3	SURROUND	LFE H	INPUT27
4	SURROUND	LFE H	INPUT28
5	SURROUND	LFE H	INPUT29
6	SURROUND	LFE H	INPUT30
7	SURROUND	LFE H	INPUT31
8	SURROUND	LFE H	INPUT32
9	SURROUND	LFE H	ST-IN1L
10	SURROUND	LFE H	ST-IN1R
11	SURROUND	LFE H	ST-IN2L
12	SURROUND	LFE H	ST-IN2R
13	SURROUND	LFE H	ST-IN3L
14	SURROUND	LFE H	ST-IN3R
15	SURROUND	LFE H	ST-IN4L
16	SURROUND	LFE H	ST-IN4R
17	NO ASSIGN		
18	NO ASSIGN		
19	NO ASSIGN		
20	NO ASSIGN		
21	NO ASSIGN		
22	NO ASSIGN		
23	NO ASSIGN		
24	NO ASSIGN		
25	NO ASSIGN		
26	NO ASSIGN		
27	NO ASSIGN		
28	NO ASSIGN		
29	NO ASSIGN		
30	NO ASSIGN		
31	NO ASSIGN		
32	NO ASSIGN		
33	SURROUND	LFE L	INPUT25
34	SURROUND	LFE L	INPUT26
35	SURROUND	LFE L	INPUT27
36	SURROUND	LFE L	INPUT28
37	SURROUND	LFE L	INPUT29
38	SURROUND	LFE L	INPUT30
39	SURROUND	LFE L	INPUT31
40	SURROUND	LFE L	INPUT32
41	SURROUND	LFE L	ST-IN1L
42	SURROUND	LFE L	ST-IN1R
43	SURROUND	LFE L	ST-IN2L
44	SURROUND	LFE L	ST-IN2R
45	SURROUND	LFE L	ST-IN3L
46	SURROUND	LFE L	ST-IN3R
47	SURROUND	LFE L	ST-IN4L
48	SURROUND	LFE L	ST-IN4R
49	NO ASSIGN		
50	NO ASSIGN		
51	NO ASSIGN		
52	NO ASSIGN		
53	NO ASSIGN		
54	NO ASSIGN		
55	NO ASSIGN		
56	NO ASSIGN		
57	NO ASSIGN		
58	NO ASSIGN		

#	High	Mid	Low
59	NO ASSIGN		
60	NO ASSIGN		
61	NO ASSIGN		
62	NO ASSIGN		
63	NO ASSIGN		
64	SURROUND	DIV F	INPUT25
65	SURROUND	DIV F	INPUT26
66	SURROUND	DIV F	INPUT27
67	SURROUND	DIV F	INPUT28
68	SURROUND	DIV F	INPUT29
69	SURROUND	DIV F	INPUT30
70	SURROUND	DIV F	INPUT31
71	SURROUND	DIV F	INPUT32
72	SURROUND	DIV F	ST-IN1L
73	SURROUND	DIV F	ST-IN1R
74	SURROUND	DIV F	ST-IN2L
75	SURROUND	DIV F	ST-IN2R
76	SURROUND	DIV F	ST-IN3L
77	SURROUND	DIV F	ST-IN3R
78	SURROUND	DIV F	ST-IN4L
79	SURROUND	DIV F	ST-IN4R
80	NO ASSIGN		
81	NO ASSIGN		
82	NO ASSIGN		
83	NO ASSIGN		
84	NO ASSIGN		
85	NO ASSIGN		
86	NO ASSIGN		
87	NO ASSIGN		
88	NO ASSIGN		
89	EQ	ON	INPUT25
90	EQ	ON	INPUT26
91	EQ	ON	INPUT27
92	EQ	ON	INPUT28
93	EQ	ON	INPUT29
94	EQ	ON	INPUT30
95	EQ	ON	INPUT31
102	EQ	ON	INPUT32
103	EQ	ON	ST-IN1
104	EQ	ON	ST-IN2
105	EQ	ON	ST-IN3
106	EQ	ON	ST-IN4
107	NO ASSIGN		
108	NO ASSIGN		
109	NO ASSIGN		
110	NO ASSIGN		
111	NO ASSIGN		
112	NO ASSIGN		
113	NO ASSIGN		
114	NO ASSIGN		
115	NO ASSIGN		
116	NO ASSIGN		
117	NO ASSIGN		
118	NO ASSIGN		
119	NO ASSIGN		

CHANNEL15

#	High	Mid	Low
0	NO ASSIGN		
1	SURROUND	LR	INPUT1
2	SURROUND	LR	INPUT2
3	SURROUND	LR	INPUT3
4	SURROUND	LR	INPUT4
5	SURROUND	LR	INPUT5
6	SURROUND	LR	INPUT6
7	SURROUND	LR	INPUT7
8	SURROUND	LR	INPUT8
9	SURROUND	LR	INPUT9
10	SURROUND	LR	INPUT10
11	SURROUND	LR	INPUT11
12	SURROUND	LR	INPUT12
13	SURROUND	LR	INPUT13
14	SURROUND	LR	INPUT14
15	SURROUND	LR	INPUT15
16	SURROUND	LR	INPUT16
17	SURROUND	LR	INPUT17
18	SURROUND	LR	INPUT18
19	SURROUND	LR	INPUT19
20	SURROUND	LR	INPUT20
21	SURROUND	LR	INPUT21
22	SURROUND	LR	INPUT22
23	SURROUND	LR	INPUT23
24	SURROUND	LR	INPUT24
25	NO ASSIGN		
26	NO ASSIGN		
27	NO ASSIGN		
28	NO ASSIGN		
29	NO ASSIGN		
30	NO ASSIGN		
31	NO ASSIGN		
32	NO ASSIGN		
33	SURROUND	FR	INPUT1
34	SURROUND	FR	INPUT2
35	SURROUND	FR	INPUT3
36	SURROUND	FR	INPUT4
37	SURROUND	FR	INPUT5
38	SURROUND	FR	INPUT6
39	SURROUND	FR	INPUT7
40	SURROUND	FR	INPUT8
41	SURROUND	FR	INPUT9
42	SURROUND	FR	INPUT10
43	SURROUND	FR	INPUT11
44	SURROUND	FR	INPUT12
45	SURROUND	FR	INPUT13
46	SURROUND	FR	INPUT14
47	SURROUND	FR	INPUT15
48	SURROUND	FR	INPUT16
49	SURROUND	FR	INPUT17
50	SURROUND	FR	INPUT18
51	SURROUND	FR	INPUT19
52	SURROUND	FR	INPUT20
53	SURROUND	FR	INPUT21
54	SURROUND	FR	INPUT22
55	SURROUND	FR	INPUT23
56	SURROUND	FR	INPUT24
57	NO ASSIGN		
58	NO ASSIGN		

#	High	Mid	Low
59	NO ASSIGN		
60	NO ASSIGN		
61	NO ASSIGN		
62	NO ASSIGN		
63	NO ASSIGN		
64	SURROUND	WIDTH	INPUT1
65	SURROUND	WIDTH	INPUT2
66	SURROUND	WIDTH	INPUT3
67	SURROUND	WIDTH	INPUT4
68	SURROUND	WIDTH	INPUT5
69	SURROUND	WIDTH	INPUT6
70	SURROUND	WIDTH	INPUT7
71	SURROUND	WIDTH	INPUT8
72	SURROUND	WIDTH	INPUT9
73	SURROUND	WIDTH	INPUT10
74	SURROUND	WIDTH	INPUT11
75	SURROUND	WIDTH	INPUT12
76	SURROUND	WIDTH	INPUT13
77	SURROUND	WIDTH	INPUT14
78	SURROUND	WIDTH	INPUT15
79	SURROUND	WIDTH	INPUT16
80	SURROUND	WIDTH	INPUT17
81	SURROUND	WIDTH	INPUT18
82	SURROUND	WIDTH	INPUT19
83	SURROUND	WIDTH	INPUT20
84	SURROUND	WIDTH	INPUT21
85	SURROUND	WIDTH	INPUT22
86	SURROUND	WIDTH	INPUT23
87	SURROUND	WIDTH	INPUT24
88	NO ASSIGN		
89	SURROUND	DEPTH	INPUT1
90	SURROUND	DEPTH	INPUT2
91	SURROUND	DEPTH	INPUT3
92	SURROUND	DEPTH	INPUT4
93	SURROUND	DEPTH	INPUT5
94	SURROUND	DEPTH	INPUT6
95	SURROUND	DEPTH	INPUT7
102	SURROUND	DEPTH	INPUT8
103	SURROUND	DEPTH	INPUT9
104	SURROUND	DEPTH	INPUT10
105	SURROUND	DEPTH	INPUT11
106	SURROUND	DEPTH	INPUT12
107	SURROUND	DEPTH	INPUT13
108	SURROUND	DEPTH	INPUT14
109	SURROUND	DEPTH	INPUT15
110	SURROUND	DEPTH	INPUT16
111	SURROUND	DEPTH	INPUT17
112	SURROUND	DEPTH	INPUT18
113	SURROUND	DEPTH	INPUT19
114	SURROUND	DEPTH	INPUT20
115	SURROUND	DEPTH	INPUT21
116	SURROUND	DEPTH	INPUT22
117	SURROUND	DEPTH	INPUT23
118	SURROUND	DEPTH	INPUT24
119	NO ASSIGN		

CHANNEL16

#	High	Mid	Low
0	NO ASSIGN		
1	SURROUND	LR	INPUT25
2	SURROUND	LR	INPUT26
3	SURROUND	LR	INPUT27
4	SURROUND	LR	INPUT28
5	SURROUND	LR	INPUT29
6	SURROUND	LR	INPUT30
7	SURROUND	LR	INPUT31
8	SURROUND	LR	INPUT32
9	SURROUND	LR	ST-IN1L
10	SURROUND	LR	ST-IN1R
11	SURROUND	LR	ST-IN2L
12	SURROUND	LR	ST-IN2R
13	SURROUND	LR	ST-IN3L
14	SURROUND	LR	ST-IN3R
15	SURROUND	LR	ST-IN4L
16	SURROUND	LR	ST-IN4R
17	NO ASSIGN		
18	NO ASSIGN		
19	NO ASSIGN		
20	NO ASSIGN		
21	NO ASSIGN		
22	NO ASSIGN		
23	NO ASSIGN		
24	NO ASSIGN		
25	NO ASSIGN		
26	NO ASSIGN		
27	NO ASSIGN		
28	NO ASSIGN		
29	NO ASSIGN		
30	NO ASSIGN		
31	NO ASSIGN		
32	NO ASSIGN		
33	SURROUND	FR	INPUT25
34	SURROUND	FR	INPUT26
35	SURROUND	FR	INPUT27
36	SURROUND	FR	INPUT28
37	SURROUND	FR	INPUT29
38	SURROUND	FR	INPUT30
39	SURROUND	FR	INPUT31
40	SURROUND	FR	INPUT32
41	SURROUND	FR	ST-IN1L
42	SURROUND	FR	ST-IN1R
43	SURROUND	FR	ST-IN2L
44	SURROUND	FR	ST-IN2R
45	SURROUND	FR	ST-IN3L
46	SURROUND	FR	ST-IN3R
47	SURROUND	FR	ST-IN4L
48	SURROUND	FR	ST-IN4R
49	NO ASSIGN		
50	NO ASSIGN		
51	NO ASSIGN		
52	NO ASSIGN		
53	NO ASSIGN		
54	NO ASSIGN		
55	NO ASSIGN		
56	NO ASSIGN		
57	NO ASSIGN		
58	NO ASSIGN		

#	High	Mid	Low
59	NO ASSIGN		
60	NO ASSIGN		
61	NO ASSIGN		
62	NO ASSIGN		
63	NO ASSIGN		
64	SURROUND	WIDTH	INPUT25
65	SURROUND	WIDTH	INPUT26
66	SURROUND	WIDTH	INPUT27
67	SURROUND	WIDTH	INPUT28
68	SURROUND	WIDTH	INPUT29
69	SURROUND	WIDTH	INPUT30
70	SURROUND	WIDTH	INPUT31
71	SURROUND	WIDTH	INPUT32
72	SURROUND	WIDTH	ST-IN1L
73	SURROUND	WIDTH	ST-IN1R
74	SURROUND	WIDTH	ST-IN2L
75	SURROUND	WIDTH	ST-IN2R
76	SURROUND	WIDTH	ST-IN3L
77	SURROUND	WIDTH	ST-IN3R
78	SURROUND	WIDTH	ST-IN4L
79	SURROUND	WIDTH	ST-IN4R
80	NO ASSIGN		
81	NO ASSIGN		
82	NO ASSIGN		
83	NO ASSIGN		
84	NO ASSIGN		
85	NO ASSIGN		
86	NO ASSIGN		
87	NO ASSIGN		
88	NO ASSIGN		
89	SURROUND	DEPTH	INPUT25
90	SURROUND	DEPTH	INPUT26
91	SURROUND	DEPTH	INPUT27
92	SURROUND	DEPTH	INPUT28
93	SURROUND	DEPTH	INPUT29
94	SURROUND	DEPTH	INPUT30
95	SURROUND	DEPTH	INPUT31
102	SURROUND	DEPTH	INPUT32
103	SURROUND	DEPTH	ST-IN1L
104	SURROUND	DEPTH	ST-IN1R
105	SURROUND	DEPTH	ST-IN2L
106	SURROUND	DEPTH	ST-IN2R
107	SURROUND	DEPTH	ST-IN3L
108	SURROUND	DEPTH	ST-IN3R
109	SURROUND	DEPTH	ST-IN4L
110	SURROUND	DEPTH	ST-IN4R
111	NO ASSIGN		
112	NO ASSIGN		
113	NO ASSIGN		
114	NO ASSIGN		
115	NO ASSIGN		
116	NO ASSIGN		
117	NO ASSIGN		
118	NO ASSIGN		
119	NO ASSIGN		

MIDI Data Format

1. DATA FORMAT

1.1 CHANNEL MESSAGE

Command	rx/tx	function
8n NOTE OFF	rx	Control the internal effects
9n NOTE ON	rx	Control the internal effects
Bn CONTROL CHANGE	rx/tx	Control parameters
Cn PROGRAM CHANGE	rx/tx	Switch scene memories

1.2 SYSTEM COMMON MESSAGE

Command	rx/tx	function
F1 MIDI TIME CODE QUARTER FRAME	rx	MTC

1.3 SYSTEM REALTIME MESSAGE

Command	rx/tx	function
F8 TIMING CLOCK	rx	MIDI clock
FE ACTIVE SENSING	rx	Check MIDI cable connections
FF RESET	rx	Clear running status

1.4 EXCLUSIVE MESSAGE

1.4.1 Real Time System Exclusive

Command	rx/tx	function
F0 7F dd 06 ... F7 MMC COMMAND	tx	MMC command
F0 7F dd 07 ... F7 MMC RESPONSE	rx	MMC response
F0 7F dd 01 ... F7 MIDI TIME CODE	rx	MTC full message

1.4.2 System Exclusive Message

1.4.2.1 Bulk Dump

Command	rx/tx	function
F0 43 0n 7E ... F7 BULK DUMP DATA	rx/tx	BULK DUMP DATA
F0 43 2n 7E ... F7 BULK DUMP REQUEST	rx/tx	BULK DUMP REQUEST

The following data types of bulk dump are used on the 01V96.

Data name	tx/rx	function
'm'	tx/rx	Scene Memory & Request (compressed data)
'S'	tx/rx	Setup Memory & Request
'L'	tx/rx	User defined MIDI remote & Request
'V'	tx/rx	User defined keys & Request
'U'	tx/rx	User assignable layer & Request
'C'	tx/rx	Control change table & Request
'P'	tx/rx	Program change table & Request
'Q'	tx/rx	Equalizer library & Request
'Y'	tx/rx	Compressor library & Request
'G'	tx/rx	Gate library & Request
'E'	tx/rx	Effect library & Request
'H'	tx/rx	Channel library & Request
'R'	tx/rx	Input patch library & Request
'O'	tx/rx	Output patch library & Request
'N'	tx/rx	Plug-in Effect Card Data & Request

1.4.2.2 PARAMTER CHANGE

Command	rx/tx	function
F0 43 1n 3E 0D ... F7 PARAMETER CHANGE	rx/tx	01V96-specific parameter change
F0 43 3n 3E 0D ... F7 PARAMETER REQUEST	rx/tx	01V96-specific parameter change
F0 43 1n 3E 7F ... F7 PARAMETER CHANGE	rx/tx	General purpose digital mixer parameter change
F0 43 3n 3E 7F ... F7 PARAMETER REQUEST	rx/tx	General purpose digital mixer parameter request

The following data types of parameter change are used by the 01V96.

Type (HEX)	tx/rx	function
1 (01)	tx/rx	Edit buffer
2 (02)	tx/rx	Patch data
3 (03)	tx/rx	Setup data
4 (04)	tx/rx	Backup data
16 (10)	tx/rx	Function (recall, store, title, clear)
17 (11)	rx	Function (pair, copy)
18 (12)	rx	Function (effect)
19 (13)	tx/rx	Sort table
20 (14)	tx/rx	Function (attribute, link)
32 (20)	rx	Key remote
33 (21)	tx/rx	Remote meter
34 (22)	tx/rx	Remote time counter

* 'tx' indicates that the data can be transmitted from the 01V96, and 'rx' indicates that the data can be received by the 01V96.

2. Format Details

2.1 NOTE OFF (8n)

Reception

If [OTHER ECHO] is ON, these message are echoed from MIDI OUT. If the [Rx CH] matches, these messages are received and used to control effects.

STATUS	1000nnnn	8n	Note off message
DATA	0nnnnnnn	nn	Note number
	0vvvvvvv	vv	Velocity(ignored)

2.2 NOTE ON (9n)

Reception

If [OTHER ECHO] is ON, these messages are echoed from MIDI OUT. If the [Rx CH] matches, these messages are received and used to control effects.

STATUS	1001nnnn	9n	Note on message
DATA	0nnnnnnn	nn	Note number
	0vvvvvvv	vv	Velocity(1-127:on, 0:off)

2.3 CONTROL CHANGE (Bn)

Reception

If [Control Change ECHO] is ON, these messages are echoed from MIDI OUT. If [TABLE] is selected, these message are received if [Control Change Rx] is ON, and will control parameters according to the [Control assign table] settings. The parameters that can be set are defined in the Control Change Assign Parameter List.

If [NRPN] is selected, these messages are received if [Control Change Rx] is ON and the [Rx CH] matches, and will control the parameter that is specified by the four messages NRPN control number (62h, 63h) and Data Entry control number (06h, 26h). Parameter settings are defined in the Control Change Assign Parameter List.

Transmission

If [TABLE] is selected, operating a parameter specified in the [Control assign table] will cause these messages to be transmitted if [Control Change Tx] is ON. The parameters that can be specified are defined in the Control Change Assign Parameter List.

If [NRPN] is selected, operating a specified parameter will cause data to be transmitted on the [Tx CH] if [Control Change Tx] is ON, using the four messages NRPN control number (62h, 63h) and Data Entry control number (06h, 26h). Parameter settings are defined in the Control Change Assign Parameter List.

This data cannot be transmitted via control change to Studio Manager since there is no guarantee that the contents of the tables will match. (Parameter Change messages will always be used.)

If [TABLE] is selected

STATUS	1011nnnn	Bn	Control change
DATA	0nnnnnnn	nn	Control number (0-95, 102-119)
	0vvvvvvv	vv	Control Value (0-127)

If [NRPN] is selected

STATUS	1011nnnn	Bn	Control change
DATA	01100010	62	NRPN LSB
	0vvvvvvv	vv	LSB of parameter number
STATUS	1011nnnn	Bn	Control change *1
DATA	01100011	63	NRPN MSB
	0vvvvvvv	vv	MSB of parameter number
STATUS	1011nnnn	Bn	Control change *1
DATA	00000110	06	MSB of data entry
	0vvvvvvv	vv	MSB of parameter data
STATUS	1011nnnn	Bn	Control change *1
DATA	00100110	26	LSB of data entry
	0vvvvvvv	vv	LSB of parameter data

*1) The second and subsequent STATUS need not be added during transmission. Reception must be implemented so that reception occurs whether or not STATUS is present.

2.4 PROGRAM CHANGE (Cn)

Reception

If [Program Change ECHO] is ON, these messages are echoed from MIDI OUT.

If [Program Change RX] is ON and the [Rx CH] matches, these messages will be received. However if [OMNI] is ON, they will be received regardless of the channel. When a message is received, a Scene Memory will be recalled according to the settings of the [Program Change Table].

Transmission

If [Program Change TX] is ON, this message is transmitted according to the settings of the [Program Change Table] on the [Tx CH] channel when a scene memory is recalled.

If the recalled scene has been assigned to more than one program number, the lowest-numbered program number will be transmitted. Transmission to Studio Manager using Program Change messages will not be performed since there is no guarantee that the contents of the tables will match. (Parameter Changes will always be used.)

STATUS	1100nnnn	Cn	Program change
DATA	0nnnnnnn	nn	Program number (0-127)

2.5 TIMING CLOCK (F8)

Reception

It is used to control effects. This message is transmitted 24 times per quarter note.

STATUS	11111000	F8	Timing clock
--------	----------	----	--------------

2.6 ACTIVE SENSING (FE)

Reception

Once this message has been received, the failure to receive any message for an interval of 400 ms or longer will cause MIDI transmission to be initialized, such as by clearing the Running Status.

STATUS	11111110	FE	Active sensing
--------	----------	----	----------------

2.7 SYSTEM RESET (FF)

Reception

When this message is received, MIDI communications will be cleared, e.g., by clearing the Running Status.

STATUS	11111111	FF	System reset
--------	----------	----	--------------

2.8 SYSTEM EXCLUSIVE MESSAGE (F0)

2.8.1 MIDI MACHINE CONTROL (MMC)

These messages are transmitted when the Machine Control section of the 01V96 is operated. For details, refer to the MMC specification.

2.8.2 BULK DUMP

This message sends or receives the contents of various memories stored within the 01V96.

The basic format is as follows.

For DUMP DATA

F0 43 0n 7E cc cc <Model ID> tt mm mm [Data ...] cs F7

For DUMP REQUEST

F0 43 2n 7E <Model ID> tt mm mm F7

n	Device Number
cc cc	DATA COUNT (the number of bytes that follow this, ending before the checksum)
4C 4D 20 20 38 43 39 33	Model ID
tt	DATA TYPE
mm mm	DATA NUMBER
cs	CHECK SUM

A unique header (Model ID) is used to determine whether the device is a 01V96. CHECK SUM is obtained by adding the bytes that follow BYTE COUNT (LOW) and end before CHECK SUM, taking the binary complement of this sum, and then setting bit 7 to 0.

CHECK SUM = (~sum)&0x7F

Reception

This message is received if [Bulk RX] is ON and the [Rx CH] matches the device number included in the SUB STATUS.

When a bulk dump is received, it is immediately written into the specified memory.

When a bulk dump request is received, a bulk dump is immediately transmitted.

Transmission

This message is transmitted on the [Tx CH] by key operations in the [MIDI]-[BULK DUMP] screen.

A bulk dump is transmitted on the [Rx CH] in response to a bulk dump request.

The data area is handled by converting seven words of 8-bit data into eight words of 7-bit data.

Conversion from actual data into bulk data

```
d[0~6]: actual data
b[0~7]: bulk data
b[0] = 0;
for( I=0; I<7; I++){
    if( d[I]&0x80){
        b[0] |= 1<<(6-I);
    }
    b[I+1] = d[I]&0x7F;
}
```

Restoration from bulk data into actual data

```
d[0~6]: actual data
b[0~7]: bulk data
for( I=0; I<7; I++){
    b[0] <<= 1;
    d[I] = b[I+1]+(0x80&b[0]);
}
```

2.8.2.1 Scene memory bulk dump format (compress)

The 01V96 can transmit and receive scene memories in compressed form.

STATUS	11110000	F0	System exclusive message
ID No.	01000011	43	Manufacturer's ID number (YAMAHA)
SUB STATUS	0000nnnn	0n	n=0-15 (Device number=MIDI Channel)
FORMAT No.	01111110	7E	Universal bulk dump
COUNT HIGH	0ccccccc	ch	data count = ch * 128 + cl
COUNT LOW	0ccccccc	cl	
	01001100	4C	'L'
	01001101	4D	'M'
	00100000	20	''
	00100000	20	''
	00111000	38	'8'
	01000011	43	'C'
	00111001	39	'9'
	00110011	33	'3'
DATA NAME	01101101	6D	'm'
	0mmmmmmm	mh	m=0-99, 256, 8192(Scene0-99, EDIT BUFFER, UNDO)
	0mmmmmmm	ml	Receive is effective 1-99, 256, 8192

```

BLOCK INFO. 0ttttttt tt total block number(minimum number is 0)
              0bbbbbbb bb current block number(0-total block number)
DATA         0ddddd ds Scene data of block[bb]
              :
              :
              0ddddd de
CHECK SUM    0eeeeeee ee ee=(Invert('L'+...+de)+1)&0x7F
EOX         11110111 F7 End of exclusive
    
```

```

01000011 43 'C'
00111001 39 '9'
00110011 33 '3'
DATA NAME   01010011 53 'S'
00000010 02
00000000 00 No.256 = Current
EOX         11110111 F7 End of exclusive
    
```

2.8.2.2 Scene memory bulk dump request format (compress)

The second and third bytes of the DATA NAME indicate the scene number that is being requested. If this is 256, the data of the Edit Buffer will be bulk-dumped. If this is 8192, the data of the Undo Buffer will be bulk-dumped.

```

STATUS      11110000 F0 System exclusive message
ID No.      01000011 43 Manufacture's ID number (YAMAHA)
SUB STATUS  0010nnnn 2n n=0-15 (Device number=MIDI Channel)
FORMAT No.  01111110 7E Universal bulk dump
              01001100 4C 'L'
              01001101 4D 'M'
              00100000 20 ''
              00100000 20 ''
              00111000 38 '8'
              01000011 43 'C'
              00111001 39 '9'
              00110011 33 '3'
DATA NAME   01101101 6D 'm'
              0mmmmmmmm mh m=0-99, 256, 8192(Scene0-99, EDIT
              BUFFER, UNDO)
              0mmmmmmmm ml
EOX         11110111 F7 End of exclusive
    
```

2.8.2.3 Setup memory bulk dump format

Of the setup memory of the 01V96, this bulk-dumps data other than the User Define MIDI Remote, User Defined Keys, User Assignable Layer, Control Change Table, and Program Change Table.

```

STATUS      11110000 F0 System exclusive message
ID No.      01000011 43 Manufacture's ID number (YAMAHA)
SUB STATUS  0000nnnn 0n n=0-15 (Device number=MIDI Channel)
FORMAT No.  01111110 7E Universal bulk dump
COUNT HIGH 0ccccccc ch data count = ch * 128 + cl
COUNT LOW  0ccccccc cl
              01001100 4C 'L'
              01001101 4D 'M'
              00100000 20 ''
              00100000 20 ''
              00111000 38 '8'
              01000011 43 'C'
              00111001 39 '9'
              00110011 33 '3'
DATA NAME   01010011 53 'S'
              00000010 02
              00000000 00 No.256 = Current
BLOCK INFO. 0ttttttt tt total block number(minimum number is 0)
              0bbbbbbb bb current block number(0-total block number)
DATA         0ddddd ds Setup data of block[bb]
              :
              :
              0ddddd de
CHECK SUM    0eeeeeee ee ee=(Invert('L'+...+de)+1)&0x7F
EOX         11110111 F7 End of exclusive
    
```

2.8.2.4 Setup memory bulk dump request format

```

STATUS      11110000 F0 System exclusive message
ID No.      01000011 43 Manufacture's ID number (YAMAHA)
SUB STATUS  0010nnnn 2n n=0-15 (Device number=MIDI Channel)
FORMAT No.  01111110 7E Universal bulk dump
              01001100 4C 'L'
              01001101 4D 'M'
              00100000 20 ''
              00100000 20 ''
              00111000 38 '8'
    
```

2.8.2.5 User Defined MIDI Remote bulk dump format

The second and third bytes of the DATA NAME indicate the bank number. Be aware that the state of the transmission destination will (in some cases) change if the same bank is being used.

```

STATUS      11110000 F0 System exclusive message
ID No.      01000011 43 Manufacture's ID number (YAMAHA)
SUB STATUS  0000nnnn 0n n=0-15 (Device number=MIDI Channel)
FORMAT No.  01111110 7E Universal bulk dump
COUNT HIGH 0ccccccc ch data count = ch * 128 + cl
COUNT LOW  0ccccccc cl
              01001100 4C 'L'
              01001101 4D 'M'
              00100000 20 ''
              00100000 20 ''
              00110000 38 '8'
              01000011 43 'C'
              00111001 39 '9'
              00110011 33 '3'
DATA NAME   01001100 4C 'L'
              00000000 00
              0bbbbbbb bb b=0-3(bank no.1-4)
BLOCK INFO. 0ttttttt tt total block number(minimum number is 0)
              0bbbbbbb bb current block number(0-total block number)
DATA         0ddddd ds User define layer data of block[bb]
              :
              :
              0ddddd de
CHECK SUM    0eeeeeee ee ee=(Invert('L'+...+de)+1)&0x7F
EOX         11110111 F7 End of exclusive
    
```

2.8.2.6 User Defined MIDI Remote bulk dump request format

The second and third bytes of the DATA NAME indicate the bank number.

```

STATUS      11110000 F0 System exclusive message
ID No.      01000011 43 Manufacture's ID number (YAMAHA)
SUB STATUS  0010nnnn 2n n=0-15 (Device number=MIDI Channel)
FORMAT No.  01111110 7E Universal bulk dump
              01001100 4C 'L'
              01001101 4D 'M'
              00100000 20 ''
              00100000 20 ''
              00111000 38 '8'
              01000011 43 'C'
              00111001 39 '9'
              00110011 33 '3'
DATA NAME   01001100 4C 'L'
              00000000 00
              0bbbbbbb bb b=0-3(bank no.1-4)
EOX         11110111 F7 End of exclusive
    
```

2.8.2.7 User Defined Keys bulk dump format

The second and third bytes of the DATA NAME indicate the bank number. Be aware that the state of the transmission destination will (in some cases) change if the same bank is being used.

```

STATUS      11110000 F0 System exclusive message
ID No.      01000011 43 Manufacture's ID number (YAMAHA)
SUB STATUS  0000nnnn 0n n=0-15 (Device number=MIDI Channel)
FORMAT No.  01111110 7E Universal bulk dump
COUNT HIGH 0ccccccc ch data count = ch * 128 + cl
COUNT LOW  0ccccccc cl
              01001100 4C 'L'
              01001101 4D 'M'
              00100000 20 ''
    
```

```

00100000 20 ''
00111000 38 '8'
01000011 43 'C'
00111001 39 '9'
00110011 33 '3'
DATA NAME 01010110 56 'V'
00000000 00
0bbbbbbb bb b=0-7(bank no.A-H)
BLOCK INFO. 0ttttttt tt total block number(minimum number is 0)
0bbbbbbb bb current block number(0-total block number)
DATA 0ddddd ds User define key data of block[bb]
: :
0ddddd de
CHECK SUM 0eeeeeee ee ee=(Invert('L'+...+de)+1)&0x7F
EOX 11110111 F7 End of exclusive

```

2.8.2.8 User Defined Keys bulk dump request format

The second and third bytes of the DATA NAME indicate the bank number.

```

STATUS 11110000 F0 System exclusive message
ID No. 01000011 43 Manufacture's ID number (YAMAHA)
SUB STATUS 0010nnnn 2n n=0-15 (Device number=MIDI Channel)
FORMAT No. 01111110 7E Universal bulk dump
01001100 4C 'L'
01001101 4D 'M'
00100000 20 ''
00100000 20 ''
00111000 38 '8'
01000011 43 'C'
00111001 39 '9'
00110011 33 '3'
DATA NAME 01010110 56 'V'
00000000 00
0bbbbbbb bb b=0-7(bank no.A-H)
EOX 11110111 F7 End of exclusive

```

2.8.2.9 User Assignable Layer bulk dump format

The second and third bytes of the DATA NAME indicate the bank number. Be aware that the state of the transmission destination will (in some cases) change if the same bank is being used.

```

STATUS 11110000 F0 System exclusive message
ID No. 01000011 43 Manufacture's ID number (YAMAHA)
SUB STATUS 0000nnnn 0n n=0-15 (Device number=MIDI Channel)
FORMAT No. 01111110 7E Universal bulk dump
COUNT HIGH 0ccccccc ch data count = ch * 128 + cl
COUNT LOW 0ccccccc cl
01001100 4C 'L'
01001101 4D 'M'
00100000 20 ''
00100000 20 ''
00111000 38 '8'
01000011 43 'C'
00111001 39 '9'
00110011 33 '3'
DATA NAME 01010101 55 'U'
00000000 00
0bbbbbbb bb b=0-3(bank no.1-4)
BLOCK INFO. 0ttttttt tt total block number(minimum number is 0)
0bbbbbbb bb current block number(0-total block number)
DATA 0ddddd ds User assignable layer data of block[bb]
: :
0ddddd de
CHECK SUM 0eeeeeee ee ee=(Invert('L'+...+de)+1)&0x7F
EOX 11110111 F7 End of exclusive

```

2.8.2.10 User Assignable Layer bulk dump request format

The second and third bytes of the DATA NAME indicate the bank number.

```

STATUS 11110000 F0 System exclusive message
ID No. 01000011 43 Manufacture's ID number (YAMAHA)
SUB STATUS 0010nnnn 2n n=0-15 (Device number=MIDI Channel)
FORMAT No. 01111110 7E Universal bulk dump
01001100 4C 'L'
01001101 4D 'M'
00100000 20 ''
00100000 20 ''
00111000 38 '8'
01000011 43 'C'
00111001 39 '9'
00110011 33 '3'
DATA NAME 01010101 55 'U'
00000000 00
0bbbbbbb bb b=0-3(bank no.1-4)
EOX 11110111 F7 End of exclusive

```

2.8.2.11 Control change table bulk dump format

```

STATUS 11110000 F0 System exclusive message
ID No. 01000011 43 Manufacture's ID number (YAMAHA)
SUB STATUS 0000nnnn 0n n=0-15 (Device number=MIDI Channel)
FORMAT No. 01111110 7E Universal bulk dump
COUNT HIGH 0ccccccc ch data count = ch * 128 + cl
COUNT LOW 0ccccccc cl
01001100 4C 'L'
01001101 4D 'M'
00100000 20 ''
00100000 20 ''
00111000 38 '8'
01000011 43 'C'
00111001 39 '9'
00110011 33 '3'
DATA NAME 01000011 43 'C'
00000010 02
00000000 00 No.256 = Current
BLOCK INFO. 0ttttttt tt total block number(minimum number is 0)
0bbbbbbb bb current block number(0-total block number)
DATA 0ddddd ds Control change table data of block[bb]
: :
0ddddd de
CHECK SUM 0eeeeeee ee ee=(Invert('L'+...+de)+1)&0x7F
EOX 11110111 F7 End of exclusive

```

2.8.2.12 Control change table bulk dump request format

```

STATUS 11110000 F0 System exclusive message
ID No. 01000011 43 Manufacture's ID number (YAMAHA)
SUB STATUS 0010nnnn 2n n=0-15 (Device number=MIDI Channel)
FORMAT No. 01111110 7E Universal bulk dump
01001100 4C 'L'
01001101 4D 'M'
00100000 20 ''
00100000 20 ''
00111000 38 '8'
01000011 43 'C'
00111001 39 '9'
00110011 33 '3'
DATA NAME 01000011 43 'C'
00000010 02
00000000 00 No.256 = Current
EOX 11110111 F7 End of exclusive

```

2.8.2.13 Program change table bulk dump format

```

STATUS      11110000 F0 System exclusive message
ID No.      01000011 43 Manufacture's ID number (YAMAHA)
SUB STATUS  0000nnnn 0n n=0-15 (Device number=MIDI Channel)
FORMAT No.  01111110 7E Universal bulk dump
COUNT HIGH 0ccccccc ch data count = ch * 128 + cl
COUNT LOW  0ccccccc cl
             01001100 4C 'L'
             01001101 4D 'M'
             00100000 20 ''
             00100000 20 ''
             00111000 38 '8'
             01000011 43 'C'
             00111001 39 '9'
             00110011 33 '3'
DATA NAME   01010000 50 'P'
             00000010 02
             00000000 00 No.256 = Current
BLOCK INFO. 0ttttttt tt total block number(minimum number is 0)
             0bbbbbbb bb current block number(0-total block number)
DATA        0ddddddd ds Program change table data of block[bb]
             :
             :
             0ddddddd de
CHECK SUM   0eeeeeee ee ee=(Invert('L'+...+de)+1)&0x7F
EOX         11110111 F7 End of exclusive
    
```

2.8.2.14 Program change table bulk dump request format

```

STATUS      11110000 F0 System exclusive message
ID No.      01000011 43 Manufacture's ID number (YAMAHA)
SUB STATUS  0010nnnn 2n n=0-15 (Device number=MIDI Channel)
FORMAT No.  01111110 7E Universal bulk dump
COUNT HIGH 0ccccccc ch data count = ch * 128 + cl
COUNT LOW  0ccccccc cl
             01001100 4C 'L'
             01001101 4D 'M'
             00100000 20 ''
             00100000 20 ''
             00111000 38 '8'
             01000011 43 'C'
             00111001 39 '9'
             00110011 33 '3'
DATA NAME   01010000 50 'P'
             00000010 02
             00000000 00 No.256 = Current
EOX         11110111 F7 End of exclusive
    
```

2.8.2.15 Equalizer library bulk dump format

The second and third bytes of the DATA NAME indicate the bank number.
 0:Library no.1 – 199:Library no.200,
 256:CH1 – 287:CH32, 288:STEREO 1L – 295:STEREO 4R, 384:BUS1 –
 391:BUS8, 512:AUX1 – 519:AUX8, 768:STEREO, 8192:UNDO
 256 and following are data for the corresponding channel of the edit buffer.
 For reception by the 01V96, only the user area is valid. (40-199, 256-)

```

STATUS      11110000 F0 System exclusive message
ID No.      01000011 43 Manufacture's ID number (YAMAHA)
SUB STATUS  0000nnnn 0n n=0-15 (Device number=MIDI Channel)
FORMAT No.  01111110 7E Universal bulk dump
COUNT HIGH 0ccccccc ch data count = ch * 128 + cl
COUNT LOW  0ccccccc cl
             01001100 4C 'L'
             01001101 4D 'M'
             00100000 20 ''
             00100000 20 ''
             00111000 38 '8'
             01000011 43 'C'
             00111001 39 '9'
             00110011 33 '3'
DATA NAME   01010001 51 'Q'
             0mmmmmmm mh 0-199(EQ Library no.1-200),
             0mmmmmmm ml 256-(Channel current data)
BLOCK INFO. 0ttttttt tt total block number(minimum number is 0)
    
```

```

             0bbbbbbb bb current block number(0-total block number)
DATA        0ddddddd ds EQ Library data of block[bb]
             :
             :
             0ddddddd de
CHECK SUM   0eeeeeee ee ee=(Invert('L'+...+de)+1)&0x7F
EOX         11110111 F7 End of exclusive
    
```

2.8.2.16 Equalizer library bulk dump request format

The second and third bytes of the DATA NAME indicate the bank number. (See above)

```

STATUS      11110000 F0 System exclusive message
ID No.      01000011 43 Manufacture's ID number (YAMAHA)
SUB STATUS  0010nnnn 2n n=0-15 (Device number=MIDI Channel)
FORMAT No.  01111110 7E Universal bulk dump
             01001100 4C 'L'
             01001101 4D 'M'
             00100000 20 ''
             00100000 20 ''
             00111000 38 '8'
             01000011 43 'C'
             00111001 39 '9'
             00110011 33 '3'
DATA NAME   01010001 51 'Q'
             0mmmmmmm mh 0-199(EQ Library no.1-200),
             0mmmmmmm ml 256-(Channel current data)
EOX         11110111 F7 End of exclusive
    
```

2.8.2.17 Compressor library bulk dump format

The second and third bytes of the DATA NAME indicate the bank number.
 0:Library no.1 – 127:Library no.128,
 256:CH1 – 287:CH32, 384:BUS1 – 391:BUS8, 512:AUX1 – 519:AUX8, 768:STE-
 REO, 8192:UNDO
 256 and following are data for the corresponding channel of the edit buffer.
 For reception by the 01V96, only the user area is valid. (36-127, 256-)

```

STATUS      11110000 F0 System exclusive message
ID No.      01000011 43 Manufacture's ID number (YAMAHA)
SUB STATUS  0000nnnn 0n n=0-15 (Device number=MIDI Channel)
FORMAT No.  01111110 7E Universal bulk dump
COUNT HIGH 0ccccccc ch data count = ch * 128 + cl
COUNT LOW  0ccccccc cl
             01001100 4C 'L'
             01001101 4D 'M'
             00100000 20 ''
             00100000 20 ''
             00111000 38 '8'
             01000011 43 'C'
             00111001 39 '9'
             00110011 33 '3'
DATA NAME   01011001 59 'Y'
             0mmmmmmm mh 0-127(COMP Library no.1-128),
             0mmmmmmm ml 256-(Channel current data)
BLOCK INFO. 0ttttttt tt total block number(minimum number is 0)
             0bbbbbbb bb current block number(0-total block number)
DATA        0ddddddd ds COMP Library data of block[bb]
             :
             :
             0ddddddd de
CHECK SUM   0eeeeeee ee ee=(Invert('L'+...+de)+1)&0x7F
EOX         11110111 F7 End of exclusive
    
```

2.8.2.18 Compressor library bulk dump request format

The second and third bytes of the DATA NAME indicate the bank number. (See above)

```

STATUS      11110000 F0 System exclusive message
ID No.      01000011 43 Manufacture's ID number (YAMAHA)
SUB STATUS  0010nnnn 2n n=0-15 (Device number=MIDI Channel)
FORMAT No.  01111110 7E Universal bulk dump
             01001100 4C 'L'
             01001101 4D 'M'
             00100000 20 ''
             00100000 20 ''
             00111000 38 '8'
             01000011 43 'C'
             00111001 39 '9'
             00110011 33 '3'
DATA NAME   01011001 59 'Y'
             0mmmmmmmm mh 0-127(COMP Library no.1-128),
             0mmmmmmmm ml 256-(Channel current data)
EOX         11110111 F7 End of exclusive

```

2.8.2.19 Gate library bulk dump format

The second and third bytes of the DATA NAME indicate the bank number. 0:Library no.1 – 127:Library no.128, 256:CH1 – 287:CH32, 8192:UNDO 256 and following are data for the corresponding channel of the edit buffer. For reception by the 01V96, only the user area is valid. (4-127, 256-)

```

STATUS      11110000 F0 System exclusive message
ID No.      01000011 43 Manufacture's ID number (YAMAHA)
SUB STATUS  0000nnnn 0n n=0-15 (Device number=MIDI Channel)
FORMAT No.  01111110 7E Universal bulk dump
COUNT HIGH 0ccccccc ch data count = ch * 128 + cl
COUNT LOW  0ccccccc cl
             01001100 4C 'L'
             01001101 4D 'M'
             00100000 20 ''
             00100000 20 ''
             00111000 38 '8'
             01000011 43 'C'
             00111001 39 '9'
             00110011 33 '3'
DATA NAME   01000111 47 'G'
             0mmmmmmmm mh 0-127(GATE Library no.1-128),
             0mmmmmmmm ml 256-351(Channel current data)
BLOCK INFO. 0ttttttt tt total block number(minimum number is 0)
             0bbbbbbb bb current block number(0-total block number)
DATA        0ddddd ds GATE Library data of block[bb]
             :
             :
             0ddddd de
CHECK SUM   0eeeeeee ee ee=(Invert('L'+...+de)+1)&0x7F
EOX         11110111 F7 End of exclusive

```

2.8.2.20 Gate library bulk dump request format

The second and third bytes of the DATA NAME indicate the bank number. (See above)

```

STATUS      11110000 F0 System exclusive message
ID No.      01000011 43 Manufacture's ID number (YAMAHA)
SUB STATUS  0010nnnn 2n n=0-15 (Device number=MIDI Channel)
FORMAT No.  01111110 7E Universal bulk dump
             01001100 4C 'L'
             01001101 4D 'M'
             00100000 20 ''
             00100000 20 ''
             00111000 38 '8'
             01000011 43 'C'
             00111001 39 '9'
             00110011 33 '3'
DATA NAME   01000111 47 'G'
             0mmmmmmmm mh 0-127(GATE Library no.1-128),
             0mmmmmmmm ml 256-351(Channel current data)
EOX         11110111 F7 End of exclusive

```

2.8.2.21 Effect library bulk dump format

The second and third bytes of the DATA NAME indicate the bank number. 0:Library no.1 – 127:Library no.128, 256:EFFECT1 – 259:EFFECT4, 8192:UNDO 256-259 are the data for the corresponding area of the edit buffer. For reception by the 01V96, only the user area is valid. (xx-127, 256-259, 8192) (xx varies with the firmware version.)

```

STATUS      11110000 F0 System exclusive message
ID No.      01000011 43 Manufacture's ID number (YAMAHA)
SUB STATUS  0000nnnn 0n n=0-15 (Device number=MIDI Channel)
FORMAT No.  01111110 7E Universal bulk dump
COUNT HIGH 0ccccccc ch data count = ch * 128 + cl
COUNT LOW  0ccccccc cl
             01001100 4C 'L'
             01001101 4D 'M'
             00100000 20 ''
             00100000 20 ''
             00111000 38 '8'
             01000011 43 'C'
             00111001 39 '9'
             00110011 33 '3'
DATA NAME   01000101 45 'E'
             0mmmmmmmm mh 0-127(Effect Library no.1-128),
             0mmmmmmmm ml 256-259(Effect1-4 current)
BLOCK INFO. 0ttttttt tt total block number(minimum number is 0)
             0bbbbbbb bb current block number(0-total block number)
DATA        0ddddd ds Effect Library data of block[bb]
             :
             :
             0ddddd de
CHECK SUM   0eeeeeee ee ee=(Invert('L'+...+de)+1)&0x7F
EOX         11110111 F7 End of exclusive

```

2.8.2.22 Effect library bulk dump request format

The second and third bytes of the DATA NAME indicate the bank number. (See above)

```

STATUS      11110000 F0 System exclusive message
ID No.      01000011 43 Manufacture's ID number (YAMAHA)
SUB STATUS  0010nnnn 2n n=0-15 (Device number=MIDI Channel)
FORMAT No.  01111110 7E Universal bulk dump
             01001100 4C 'L'
             01001101 4D 'M'
             00100000 20 ''
             00100000 20 ''
             00111000 38 '8'
             01000011 43 'C'
             00111001 39 '9'
             00110011 33 '3'
DATA NAME   01000101 45 'E'
             0mmmmmmmm mh 0-127(Effect Library no.1-128),
             0mmmmmmmm ml 256-259(Effect1-4 current)
EOX         11110111 F7 End of exclusive

```

2.8.2.23 Channel library bulk dump format

The second and third bytes of the DATA NAME indicate the bank number. 0:Library no.0 – 128:Library no.128, 256:CH1 – 287:CH32, 288:STEREO 1L – 295:STEREO 4R, 384:BUS1 – 391:BUS8, 512:AUX1 – 519:AUX8, 768:STEREO, 8192:UNDO 256 and following are data for the corresponding channel of the edit buffer. For reception by the 01V96, only the user area is valid. (2-128, 256-)

```

STATUS      11110000 F0 System exclusive message
ID No.      01000011 43 Manufacture's ID number (YAMAHA)
SUB STATUS  0000nnnn 0n n=0-15 (Device number=MIDI Channel)
FORMAT No.  01111110 7E Universal bulk dump
COUNT HIGH 0ccccccc ch data count = ch * 128 + cl
COUNT LOW  0ccccccc cl
             01001100 4C 'L'
             01001101 4D 'M'
             00100000 20 ''
             00100000 20 ''
             00111000 38 '8'

```

```

01000011 43 'C'
00111001 39 '9'
00110011 33 '3'
DATA NAME 01001000 48 'H'
0mmmmmmmh mh 0-128(Channel Library no.0-128),
0mmmmmmml ml 256-(Current data)
BLOCK INFO. 0tttttttt tt total block number(minimum number is 0)
0bbbbbbbbb bb current block number(0-total block number)
DATA 0ddddd ds Channel Library data of block[bb]
:
:
0ddddd de
CHECK SUM 0eeeeeee ee ee=(Invert('L'+...+de)+1)&0x7F
EOX 11110111 F7 End of exclusive

```

2.8.2.24 Channel library bulk dump request format

The second and third bytes of the DATA NAME indicate the bank number. (See above)

```

STATUS 11110000 F0 System exclusive message
ID No. 01000011 43 Manufacture's ID number (YAMAHA)
SUB STATUS 0010nnnn 2n n=0-15 (Device number=MIDI Channel)
FORMAT No. 01111110 7E Universal bulk dump
01001100 4C 'L'
01001101 4D 'M'
00100000 20 ''
00100000 20 ''
00111000 38 '8'
01000011 43 'C'
00111001 39 '9'
00110011 33 '3'
DATA NAME 01001000 48 'H'
0mmmmmmmh mh 0-128(Channel Library no.0-128),
0mmmmmmml ml 256-(Current data)
EOX 11110111 F7 End of exclusive

```

2.8.2.25 Input patch library bulk dump format

The second and third bytes of the DATA NAME indicate the bank number. 0:Library no.0 – 32:Library no.32, 256:current input patch data, 8192:UNDO For reception by the 01V96, only the user area is valid. (1-32, 256, 8192)

```

STATUS 11110000 F0 System exclusive message
ID No. 01000011 43 Manufacture's ID number (YAMAHA)
SUB STATUS 0000nnnn 0n n=0-15 (Device number=MIDI Channel)
FORMAT No. 01111110 7E Universal bulk dump
COUNT HIGH 0ccccccc ch data count = ch * 128 + cl
COUNT LOW 0ccccccc cl
01001100 4C 'L'
01001101 4D 'M'
00100000 20 ''
00100000 20 ''
00111000 38 '8'
01000011 43 'C'
00111001 39 '9'
00110011 33 '3'
DATA NAME 01010010 52 'R'
0mmmmmmmh mh 0-32(Input patch Library no.0-32),
0mmmmmmml ml 256(Current data)
BLOCK INFO. 0tttttttt tt total block number(minimum number is 0)
0bbbbbbbbb bb current block number(0-total block number)
DATA 0ddddd ds Input patch Library data of block[bb]
:
:
0ddddd de
CHECK SUM 0eeeeeee ee ee=(Invert('L'+...+de)+1)&0x7F
EOX 11110111 F7 End of exclusive

```

2.8.2.26 Input patch library bulk dump request format

The second and third bytes of the DATA NAME indicate the bank number. (See above)

```

STATUS 11110000 F0 System exclusive message
ID No. 01000011 43 Manufacture's ID number (YAMAHA)
SUB STATUS 0010nnnn 2n n=0-15 (Device number=MIDI Channel)
FORMAT No. 01111110 7E Universal bulk dump
01001100 4C 'L'
01001101 4D 'M'
00100000 20 ''
00100000 20 ''
00111000 38 '8'
01000011 43 'C'
00111001 39 '9'
00110011 33 '3'
DATA NAME 01010010 52 'R'
0mmmmmmmh mh 0-32(Input patch Library no.0-32),
0mmmmmmml ml 256(Current data)
EOX 11110111 F7 End of exclusive

```

2.8.2.27 Output patch library bulk dump format

The second and third bytes of the DATA NAME indicate the bank number. 0:Library no.0 – 32:Library no.32, 256:current output patch data, 8192:UNDO For reception by the 01V96, only the user area is valid. (1-32, 256)

```

STATUS 11110000 F0 System exclusive message
ID No. 01000011 43 Manufacture's ID number (YAMAHA)
SUB STATUS 0000nnnn 0n n=0-15 (Device number=MIDI Channel)
FORMAT No. 01111110 7E Universal bulk dump
COUNT HIGH 0ccccccc ch data count = ch * 128 + cl
COUNT LOW 0ccccccc cl
01001100 4C 'L'
01001101 4D 'M'
00100000 20 ''
00100000 20 ''
00111000 38 '8'
01000011 43 'C'
00111001 39 '9'
00110011 33 '3'
DATA NAME 01001111 4F 'O'
0mmmmmmmh mh 0-32(Output patch Library no.0-32),
0mmmmmmml ml 256(Current data)
BLOCK INFO. 0tttttttt tt total block number(minimum number is 0)
0bbbbbbbbb bb current block number(0-total block number)
DATA 0ddddd ds Output patch Library data of block[bb]
:
:
0ddddd de
CHECK SUM 0eeeeeee ee ee=(Invert('L'+...+de)+1)&0x7F
EOX 11110111 F7 End of exclusive

```

2.8.2.28 Output patch library bulk dump request format

The second and third bytes of the DATA NAME indicate the bank number. (See above)

```

STATUS 11110000 F0 System exclusive message
ID No. 01000011 43 Manufacture's ID number (YAMAHA)
SUB STATUS 0010nnnn 2n n=0-15 (Device number=MIDI Channel)
FORMAT No. 01111110 7E Universal bulk dump
01001100 4C 'L'
01001101 4D 'M'
00100000 20 ''
00100000 20 ''
00111000 38 '8'
01000011 43 'C'
00111001 39 '9'
00110011 33 '3'
DATA NAME 01001111 4F 'O'
0mmmmmmmh mh 0-32(Output patch Library no.0-32),
0mmmmmmml ml 256(Current data)
EOX 11110111 F7 End of exclusive

```

2.8.2.29 Plug-in effect card bulk dump format

The second byte of the DATA NAME indicates the slot number.
0:SLOT 1

The data is not received if the Developer ID and Product ID are different than the card that is installed in the slot.

The data is not transmitted if a valid plug-in effect card is not installed.

```

STATUS      11110000 F0 System exclusive message
ID No.      01000011 43 Manufacture's ID number (YAMAHA)
SUB STATUS  0000nnnn 0n n=0-15 (Device number=MIDI Channel)
FORMAT No.  01111110 7E Universal bulk dump
COUNT HIGH 0ccccccc ch data count = ch * 128 + cl
COUNT LOW  0ccccccc cl
              01001100 4C 'L'
              01001101 4D 'M'
              00100000 20 ''
              00100000 20 ''
              00111000 38 '8'
              01000011 43 'C'
              00111001 39 '9'
              00110011 33 '3'
DATA NAME   01001110 4E 'N'
              0mmmmmmmm mh m=0(SLOT 1)
              0mmmmmmmm ml
BLOCK INFO. 0bbbbbbb bh current block number(0-total block number)
              0bbbbbbb bl
              0ttttttt th total block number(minimum number is 0)
              0ttttttt tl
              0000iiii oi Developer id (High)
              0000iiii oi Developer id (Low)
              0000jjjj oj Product id (High)
              0000jjjj oj Product id (Low)
DATA        0ddddddd ds Plug-in Effect card memory data of block[bb]
              :
              :
              0ddddddd de
CHECK SUM   0eeeeeee ee ee=(Invert('L'+...+de)+1)&0x7F
EOX         11110111 F7 End of exclusive

```

2.8.2.30 Plug-in effect card bulk dump request format

The second and third bytes of the DATA NAME indicate the slot number. (See above)

```

STATUS      11110000 F0 System exclusive message
ID No.      01000011 43 Manufacture's ID number (YAMAHA)
SUB STATUS  0010nnnn 2n n=0-15 (Device number=MIDI Channel)
FORMAT No.  01111110 7E Universal bulk dump
              01001100 4C 'L'
              01001101 4D 'M'
              00100000 20 ''
              00100000 20 ''
              00111000 38 '8'
              01000011 43 'C'
              00111001 39 '9'
              00110011 33 '3'
DATA NAME   01001110 4E 'N'
              0mmmmmmmm mh m=0(SLOT 1)
              0mmmmmmmm ml
EOX         11110111 F7 End of exclusive

```

2.8.3 PARAMETER CHANGE

2.8.3.1 Basic behavior

Reception

If [Parameter change ECHO] is ON, these messages are echoed.

If [Parameter change RX] is ON and the [Rx CH] matches the Device Number included in the SUB STATUS, these messages are received. A specific parameter is controlled when a Parameter Change is received. When a Parameter Request is received, the current value of the specified parameter will be transmitted as a Parameter Change with the Device Number set to [Rx CH].

Transmission

If [Parameter change TX] is ON and you operate a parameter for which Control Change transmission is not enabled, a parameter change will be transmitted with [Tx CH] as the Device Number.

As a response to a Parameter Request, a parameter change will be transmitted with [Rx CH] as the Device Number.

2.8.3.1.1 Parameter change basic format

```

STATUS      11110000 F0 System exclusive message
ID No.      01000011 43 Manufacture's ID number (YAMAHA)
SUB STATUS  0001nnnn 1n n=0-15 (Device number=MIDI Channel)
GROUP ID    00111110 3E MODEL ID (digital mixer)
MODEL ID    00001101 0D 01V96
ADDRESS     0ttttttt tt Data type
              0eeeeeee ee Element no.
              (If 'ee' is 0, 'ee' is expanded to two bytes)
              0ppppppp pp Parameter no.
              0ccccccc cc Channel no.
DATA * )    0ddddddd dd data
              :
              :
EOX         11110111 F7 End of exclusive

```

* For parameters with a data size of 2 or more, data for that size will be transmitted.

2.8.3.1.2 Parameter Change basic format (Universal format)

```

STATUS      11110000 F0 System exclusive message
ID No.      01000011 43 Manufacture's ID number (YAMAHA)
SUB STATUS  0001nnnn 1n n=0-15 (Device number=MIDI Channel)
GROUP ID    00111110 3E MODEL ID (digital mixer)
MODEL ID    01111111 7F Universal
ADDRESS     0ttttttt tt Data type
              0eeeeeee ee Element no.
              (If 'ee' is 0, 'ee' is expanded to two bytes)
              0ppppppp pp Parameter no.
              0ccccccc cc Channel no.
DATA * )    0ddddddd dd data
              :
              :
EOX         11110111 F7 End of exclusive

```

* For parameters with a data size of 2 or more, data for that size will be transmitted.

2.8.3.1.3 Parameter request basic format

```

STATUS      11110000 F0 System exclusive message
ID No.      01000011 43 Manufacture's ID number (YAMAHA)
SUB STATUS  0011nnnn 3n n=0-15 (Device number=MIDI Channel)
GROUP ID    00111110 3E MODEL ID (digital mixer)
MODEL ID    00001101 0D 01V96
ADDRESS     0ttttttt tt Data type
              0eeeeeee ee Element no.
              (If 'ee' is 0, 'ee' is expanded to two bytes)
              0ppppppp pp Parameter no.
              0ccccccc cc Channel no.
EOX         11110111 F7 End of exclusive

```

2.8.3.1.4 Parameter request basic format (Universal format)

```

STATUS      11110000 F0 System exclusive message
ID No.      01000011 43 Manufacture's ID number (YAMAHA)
SUB STATUS  0011nnnn 3n n=0-15 (Device number=MIDI Channel)
GROUP ID    00111110 3E MODEL ID (digital mixer)
MODEL ID    01111111 7F Universal
ADDRESS     0ttttttt tt Data type
              0eeeeeee ee Element no.
              (If 'ee' is 0, 'ee' is expanded to two bytes)
              0ppppppp pp Parameter no.
              0ccccccc cc Channel no.
EOX         11110111 F7 End of exclusive

```

2.8.3.1.5 Parameter Address

Consult your dealer for parameter address details.

2.8.3.2 Parameter change (Edit buffer)

STATUS	11110000	F0	System exclusive message
ID No.	01000011	43	Manufacture's ID number (YAMAHA)
SUB STATUS	0001nnnn	1n	n=0-15 (Device number=MIDI Channel)
GROUP ID	00111110	3E	MODEL ID (digital mixer)
MODEL ID	01111111	7F	Universal
ADDRESS	00000001	01	Edit Buffer
	0eeeeeee	ee	Element no. (If 'ee' is 0, 'ee' is expanded to two bytes)
	0pppppppp	pp	Parameter no.
	0ccccccc	cc	Channel no.
DATA	0ddddddd	dd	data
	:	:	
EOX	11110111	F7	End of exclusive

2.8.3.3 Parameter request (Edit buffer)

STATUS	11110000	F0	System exclusive message
ID No.	01000011	43	Manufacture's ID number (YAMAHA)
SUB STATUS	0011nnnn	3n	n=0-15 (Device number=MIDI Channel)
GROUP ID	00111110	3E	MODEL ID (digital mixer)
MODEL ID	01111111	7F	Universal
ADDRESS	00000001	01	Edit Buffer
	0eeeeeee	ee	Element no. (If 'ee' is 0, 'ee' is expanded to two bytes)
	0pppppppp	pp	Parameter no.
	0ccccccc	cc	Channel no.
EOX	11110111	F7	End of exclusive

2.8.3.4 Parameter change (Patch data)

STATUS	11110000	F0	System exclusive message
ID No.	01000011	43	Manufacture's ID number (YAMAHA)
SUB STATUS	0001nnnn	1n	n=0-15 (Device number=MIDI Channel)
GROUP ID	00111110	3E	MODEL ID (digital mixer)
MODEL ID	00001101	0D	01V96
ADDRESS	00000010	02	Patch data
	0eeeeeee	ee	Element no. (If 'ee' is 0, 'ee' is expanded to two bytes)
	0pppppppp	pp	Parameter no.
	0ccccccc	cc	Channel no.
DATA	0ddddddd	dd	data
	:	:	
EOX	11110111	F7	End of exclusive

2.8.3.5 Parameter request (Patch data)

STATUS	11110000	F0	System exclusive message
ID No.	01000011	43	Manufacture's ID number (YAMAHA)
SUB STATUS	0011nnnn	3n	n=0-15 (Device number=MIDI Channel)
GROUP ID	00111110	3E	MODEL ID (digital mixer)
MODEL ID	00001101	0D	01V96
ADDRESS	00000010	02	Patch data
	0eeeeeee	ee	Element no. (If 'ee' is 0, 'ee' is expanded to two bytes)
	0pppppppp	pp	Parameter no.
	0ccccccc	cc	Channel no.
EOX	11110111	F7	End of exclusive

2.8.3.6 Parameter change (Setup memory)

STATUS	11110000	F0	System exclusive message
ID No.	01000011	43	Manufacture's ID number (YAMAHA)
SUB STATUS	0001nnnn	1n	n=0-15 (Device number=MIDI Channel)
GROUP ID	00111110	3E	MODEL ID (digital mixer)
MODEL ID	00001101	0D	01V96
ADDRESS	00000011	03	Setup data
	0eeeeeee	ee	Element no. (If 'ee' is 0, 'ee' is expanded to two bytes)
	0pppppppp	pp	Parameter no.
	0ccccccc	cc	Channel no.
DATA	0ddddddd	dd	data

EOX	11110111	F7	End of exclusive
-----	----------	----	------------------

2.8.3.7 Parameter request (Setup memory)

STATUS	11110000	F0	System exclusive message
ID No.	01000011	43	Manufacture's ID number (YAMAHA)
SUB STATUS	0011nnnn	3n	n=0-15 (Device number=MIDI Channel)
GROUP ID	00111110	3E	MODEL ID (digital mixer)
MODEL ID	00001101	0D	01V96
ADDRESS	00000011	03	Setup data
	0eeeeeee	ee	Element no. (If 'ee' is 0, 'ee' is expanded to two bytes)
	0pppppppp	pp	Parameter no.
	0ccccccc	cc	Channel no.
EOX	11110111	F7	End of exclusive

2.8.3.8 Parameter change (Backup memory)

STATUS	11110000	F0	System exclusive message
ID No.	01000011	43	Manufacture's ID number (YAMAHA)
SUB STATUS	0001nnnn	1n	n=0-15 (Device number=MIDI Channel)
GROUP ID	00111110	3E	MODEL ID (digital mixer)
MODEL ID	00001101	0D	01V96
ADDRESS	00000100	04	Backup data
	0eeeeeee	ee	Element no. (If 'ee' is 0, 'ee' is expanded to two bytes)
	0pppppppp	pp	Parameter no.
	0ccccccc	cc	Channel no.
DATA	0ddddddd	dd	data
	:	:	
EOX	11110111	F7	End of exclusive

2.8.3.9 Parameter request (Backup memory)

STATUS	11110000	F0	System exclusive message
ID No.	01000011	43	Manufacture's ID number (YAMAHA)
SUB STATUS	0011nnnn	3n	n=0-15 (Device number=MIDI Channel)
GROUP ID	00111110	3E	MODEL ID (digital mixer)
MODEL ID	00001101	0D	01V96
ADDRESS	00000100	04	Backup data
	0eeeeeee	ee	Element no. (If 'ee' is 0, 'ee' is expanded to two bytes)
	0pppppppp	pp	Parameter no.
	0ccccccc	cc	Channel no.
EOX	11110111	F7	End of exclusive

2.8.3.10 Parameter change (Function call: Library store / recall)

Reception

When this is received, the specified memory/library will be stored/recalled. If this is received from Studio Manager or Cascade Link, the operation will be executed, and then the result of execution will be transmitted as a Parameter Response.

Transmission

If [Parameter change Tx] is ON, and you store or recall a memory/library for which Program Change transmission is not valid, this message will be transmitted with the Device Number set to the [Tx CH].

STATUS	11110000	F0	System exclusive message
ID No.	01000011	43	Manufacture's ID number (YAMAHA)
SUB STATUS	0001nnnn	1n	n=0-15 (Device number=MIDI Channel)
GROUP ID	00111110	3E	MODEL ID (digital mixer)
MODEL ID	01111111	7F	Universal
ADDRESS	00010000	10	Function call
	00ffffff	ff	function
	0mmmmmmm	mh	number High
	0mmmmmmm	ml	number Low
DATA	0ccccccc	ch	channel High
	0ccccccc	cl	channel Low
EOX	11110111	F7	End of exclusive

function	number	channel*1)	tx/rx
SCENE RECALL	0x00	0-99, 8192	256 tx/rx
EQ LIB RECALL	0x01	1-200, 8192	0-513 tx/rx
GATE LIB RECALL	0x02	1-128, 8192	0-95 tx/rx
COMP LIB RECALL	0x03	1-128, 8192	0-513 tx/rx
EFF LIB RECALL	0x04	1-128, 8192	0-3 tx/rx
CHANNEL LIB RECALL	0x06	0-128, 8192	0-513 tx/rx
INPATCH LIB RECALL	0x07	0-32, 8192	256 tx/rx
OUTPATCH LIB RECALL	0x08	0-32, 8192	256 tx/rx
SCENE STORE	0x20	1-99	256, 16383 tx/rx
EQ LIB STORE	0x21	41-200	0-513, 16383 tx/rx
GATE LIB STORE	0x22	5-128	0-31, 16383 tx/rx
COMP LIB STORE	0x23	37-128	0-513, 16383 tx/rx
EFF LIB STORE	0x24	xx(*2)-128	0-3, 16383 tx/rx
CHANNEL LIB STORE	0x26	1-128	0-513, 16383 tx/rx
INPATCH LIB STORE	0x27	1-32	256, 16383 tx/rx
OUTPATCH LIB STORE	0x28	1-32	256, 16383 tx/rx

*1) 0:CH1 – 31:CH32, 32:ST-IN1L - 39:ST-IN4R, 128:BUS1 – 135:BUS8, 256:AUX1 – 263:AUX8, 512:STEREO

Use 256 if the recall destination or store source is a single data item. Effect is 0:Effect 1–3:Effect 4

If the store destination is 16383 (0x3FFF), this indicates that the library data has been changed by an external cause (such as bulk reception)

(only transmitted by the 01V96)

*2) Varies with the firmware version.

2.8.3.11 Parameter change (Function call: title)

Reception

When this is received, the title of the specified memory/library will be changed. If this is received from Studio Manager or Cascade Link, the operation will be executed, and then the result of execution will be transmitted as a parameter response.

Transmission

In response to a request, this is transmitted with the device number set to the [Tx CH].

When the title is changed on the 01V96, this message will be transmitted with the device number set to [Tx CH].

STATUS	11110000	F0	System exclusive message
ID No.	01000011	43	Manufacturer's ID number (YAMAHA)
SUB STATUS	0001nnnn	1n	n=0-15 (Device number=MIDI Channel)
GROUP ID	00111110	3E	MODEL ID (digital mixer)
MODEL ID	01111111	7F	Universal
ADDRESS	00010000	10	Function call
	0100ffff	4f	title
	0mmmmmmmm	mh	number High
	0mmmmmmmm	ml	number Low
DATA	0ddddd	dd	title 1
	:	:	:
	0ddddd	dd	title x(depend on the library)
EOX	11110111	F7	End of exclusive

function	number	size	
SCENE LIB TITLE	0x40	0-99,256(0:response only)	16
EQ LIB TITLE	0x41	1-200(1-40:response only)	16
GATE LIB TITLE	0x42	1-128(1-4:response only)	16
COMP LIB TITLE	0x43	1-128(1-36:response only)	16
EFF LIB TITLE	0x44	1-128(1-xx(*1):response only)	16
CHANNEL LIB TITLE	0x46	0-128(0:response only)	16
INPATCH LIB TITLE	0x47	0-32(0:response only)	16
OUTPATCH LIB TITLE	0x48	0-32(0:response only)	16

*1) Varies with the firmware version.

2.8.3.12 Parameter request (Function call: title)

Reception

When this is received, a parameter change will be transmitted with the device number set to [Rx CH].

Refer to the above table for the Functions and Numbers.

STATUS	11110000	F0	System exclusive message
ID No.	01000011	43	Manufacturer's ID number (YAMAHA)
SUB STATUS	0011nnnn	3n	n=0-15 (Device number=MIDI Channel)
GROUP ID	00111110	3E	MODEL ID (digital mixer)
MODEL ID	01111111	7F	Universal

ADDRESS	00010000	10	Function call
	0100ffff	4f	title
	0mmmmmmmm	mh	number High
	0mmmmmmmm	ml	number Low
EOX	11110111	F7	End of exclusive

2.8.3.13 Parameter change (Function call: Scene/Library Clear)

Reception

When this is received, the specified memory/library will be cleared. If this is received from Studio Manager or Cascade Link, the operation will be executed, and then the result of execution will be transmitted as a parameter response.

Transmission

When a memory or library is cleared on the 01V96, this message will be transmitted with the device number set to [Tx CH].

STATUS	11110000	F0	System exclusive message
ID No.	01000011	43	Manufacturer's ID number (YAMAHA)
SUB STATUS	0001nnnn	1n	n=0-15 (Device number=MIDI Channel)
GROUP ID	00111110	3E	MODEL ID (digital mixer)
MODEL ID	01111111	7F	Universal
ADDRESS	00010000	10	Function call
	0110ffff	6f	clear function
	0mmmmmmmm	mh	number High
	0mmmmmmmm	ml	number Low
EOX	11110111	F7	End of exclusive

function	number	
SCENE LIB CLEAR	0x60	1-99
EQ LIB CLEAR	0x61	41-200
GATE LIB CLEAR	0x62	5-128
COMP LIB CLEAR	0x63	37-128
EFF LIB CLEAR	0x64	xx-128 (*1)
CHANNEL LIB CLEAR	0x66	1-128
INPATCH LIB CLEAR	0x67	1-32
OUTPATCH LIB CLEAR	0x68	1-32

*1) Varies with the firmware version.

2.8.3.14 Parameter change (Function call: attribute)

Reception

This is received if [Parameter change RX] is ON and the [Rx CH] matches the device number included in the SUB STATUS. This is echoed if [Parameter change ECHO] is ON.

When this is received, the attribute of the specified memory/library will be changed.

Transmission

In response to a request, a Parameter Change message will be transmitted on the [Rx CH].

If [Parameter change ECHO] is ON, this message will be retransmitted without change.

STATUS	11110000	F0	System exclusive message
ID No.	01000011	43	Manufacturer's ID number (YAMAHA)
SUB STATUS	0001nnnn	1n	n=0-15 (Device number=MIDI Channel)
GROUP ID	00111110	3E	MODEL ID (digital mixer)
MODEL ID	01111111	7F	Universal
ADDRESS	00010100	14	Function call
	0000ffff	0f	attribute
	0mmmmmmmm	mh	number High
	0mmmmmmmm	ml	number Low
DATA	0ttttttt	tt	attribute(protect:0x0001, normal:0x0000)
	0ttttttt	tt	
EOX	11110111	F7	End of exclusive

function	number	
SCENE LIB ATTRIBUTE	0x00	0-99(0:response only)

2.8.3.15 Parameter request (Function call: attribute)

Reception

This is received if [Parameter change RX] is ON and the [Rx CH] matches the device number included in the SUB STATUS. This is echoed if [Parameter change ECHO] is ON.

When this is received, a Parameter Change message will be transmitted on the [Rx CH].

Refer to the above table for the Functions and Numbers.

STATUS	11110000	F0	System exclusive message
ID No.	01000011	43	Manufacture's ID number (YAMAHA)
SUB STATUS	0011nnnn	3n	n=0-15 (Device number=MIDI Channel)
GROUP ID	00111110	3E	MODEL ID (digital mixer)
MODEL ID	01111111	7F	Universal
ADDRESS	00010100	14	Function call
	0000ffff	0F	attribute
	0mmmmmmm	mh	number High
	0mmmmmmm	ml	number Low
EOX	11110111	F7	End of exclusive

2.8.3.16 Parameter change (Function call: link)

Reception

This is received if [Parameter change RX] is ON and the [Rx CH] matches the device number included in the SUB STATUS. This is echoed if [Parameter change ECHO] is ON.

When this is received, the patch link data of the specified scene will be modified.

Transmission

In response to a request, a Parameter Change message will be transmitted on the [Rx CH].

If [Parameter change ECHO] is ON, this message will be retransmitted without change.

STATUS	11110000	F0	System exclusive message
ID No.	01000011	43	Manufacture's ID number (YAMAHA)
SUB STATUS	0001nnnn	1n	n=0-15 (Device number=MIDI Channel)
GROUP ID	00111110	3E	MODEL ID (digital mixer)
MODEL ID	01111111	7F	Universal
ADDRESS	00010100	14	Function call
	0010ffff	2F	link
	0mmmmmmm	mh	number High
	0mmmmmmm	ml	number Low
DATA	0iiiiiii	ih	inpatch
	0iiiiiii	il	
	0ooooooo	oh	outpatch
	0ooooooo	ol	
EOX	11110111	F7	End of exclusive

function	number
SCENE LIB LINK	0x20 0-99(0:response only)

2.8.3.17 Parameter request (Function call: link)

Reception

This is received if [Parameter change RX] is ON and the [Rx CH] matches the device number included in the SUB STATUS. This is echoed if [Parameter change ECHO] is ON.

When this is received, a Parameter Change message will be transmitted on the [Rx CH].

Refer to the above table for the Functions and Numbers.

STATUS	11110000	F0	System exclusive message
ID No.	01000011	43	Manufacture's ID number (YAMAHA)
SUB STATUS	0011nnnn	3n	n=0-15 (Device number=MIDI Channel)
GROUP ID	00111110	3E	MODEL ID (digital mixer)
MODEL ID	01111111	7F	Universal
ADDRESS	00010100	14	Function call
	0010ffff	2F	link
	0mmmmmmm	mh	number High
	0mmmmmmm	ml	number Low
EOX	11110111	F7	End of exclusive

2.8.3.18 Parameter change (Function call: pair, copy)

Reception

This is received if [Parameter change RX] is ON and the [Rx CH] matches the device number included in the SUB STATUS. This is echoed if [Parameter change ECHO] is ON.

When this is received, pairing will be enabled/disabled for the specified channel.

STATUS	11110000	F0	System exclusive message
ID No.	01000011	43	Manufacture's ID number (YAMAHA)
SUB STATUS	0001nnnn	1n	n=0-15 (Device number=MIDI Channel)
GROUP ID	00111110	3E	MODEL ID (digital mixer)

MODEL ID	01111111	7F	Universal
ADDRESS	00010001	11	Function call Pair
	0000ffff	0F	function
	0sssssss	sh	Source channel H
	0sssssss	sl	Source channel L
DATA	0ddddddd	dh	Destination channel H
	0ddddddd	dl	Destination channel L
EOX	11110111	F7	End of exclusive

function	channel
PAIR ON with COPY	0x00 *1)
PAIR ON with RESET BOTH	0x01 *1)
PAIR OFF	0x02 *1)

*1) 0:CH1 – 31:CH32, 128:BUS1 – 135:BUS8, 256:AUX1 – 263:AUX8, 512:STEREO
Effect is 0:Effect 1–3:Effect 4

- In the case of PAIR, you must specify channels for which pairing is possible.
- In the case of PAIR ON with COPY, you must specify Source Channel as the copy source, and Destination Channel as the copy destination.

2.8.3.19 Parameter change (Function call Event: Effect)

Reception

This is received if [Parameter change RX] is ON and the [Rx CH] matches the device number included in the SUB STATUS.

This is echoed if [Parameter change ECHO] is ON.

When this is received, the corresponding effect's function activates (depending on the effect type).

STATUS	11110000	F0	System exclusive message
ID No.	01000011	43	Manufacture's ID number (YAMAHA)
SUB STATUS	0001nnnn	1n	n=0-15 (Device number=MIDI Channel)
GROUP ID	00111110	3E	MODEL ID (digital mixer)
MODEL ID	01111111	7F	Universal
ADDRESS	00010010	12	Function call Effect Event
	0000ffff	0F	function
	00000000	00	
	0ppppppp	pp	Release:0, Press:1
DATA	00000000	00	
	0eeeeeee	ee	Effect number (0:Effect1 - 3:Effect4)
EOX	11110111	F7	End of exclusive

function	channel
Freeze Play button	0x00 0:Effect1-3:Effect4
Freeze Record button	0x01 0:Effect1-3:Effect4

- This does not activate when the effect type is different.

2.8.3.20 Parameter change (Sort Table)

When scene memory sort is executed on the 01V96, the memory sort table will be transmitted to Studio Manager.

Studio Manager will sort the memories according to this data.

If Studio Manager performs a scene memory sort, it will transmit this data to the 01V96.

STATUS	11110000	F0	System exclusive message
ID No.	01000011	43	Manufacture's ID number (YAMAHA)
SUB STATUS	0001nnnn	1n	n=0-15 (Device number=MIDI Channel)
GROUP ID	00111110	3E	MODEL ID (digital mixer)
MODEL ID	00001101	0D	01V96
ADDRESS	00010011	13	Library sort table
	0000ffff	0F	Library type
DATA	0ddddddd	ds	Data
	:	:	
	0ddddddd	de	Data
EOX	11110111	F7	End of exclusive

8-7 conversion is performed on the data area in the same way as for bulk.

2.8.3.21 Parameter request (Sort Table)

When the 01V96 receives this data, it will transmit Sort Table Data.

STATUS	11110000	F0	System exclusive message
ID No.	01000011	43	Manufacture's ID number (YAMAHA)
SUB STATUS	0011nnnn	3n	n=0-15 (Device number=MIDI Channel)
GROUP ID	00111110	3E	MODEL ID (digital mixer)
MODEL ID	00001101	0D	01V96
ADDRESS	00010011	13	Library sort table
	0000ffff	0f	Library type
EOX	11110111	F7	End of exclusive

2.8.3.22 Parameter change (Key remote)**Reception**

This is received if [Parameter change RX] is ON and the [Rx CH] matches the device number included in the SUB STATUS.

This is echoed if [Parameter change ECHO] is ON.

When this is received, the same processing that is executed when the key specified by Address is pressed (released).

Transmission

If [Parameter Change ECHO] is ON, this message is retransmitted without change.

STATUS	11110000	F0	System exclusive message
ID No.	01000011	43	Manufacture's ID number (YAMAHA)
SUB STATUS	0001nnnn	1n	n=0-15 (Device number=MIDI Channel)
GROUP ID	00111110	3E	MODEL ID (digital mixer)
MODEL ID	00001101	0D	01V96
ADDRESS	00100000	20	Key remote
	0kkkkkkk	kk	Key address H
	0kkkkkkk	kk	Key address M
	0kkkkkkk	kk	Key address L
DATA	0ppppppp	pp	Release:0, Press:1
EOX	11110111	F7	End of exclusive

2.8.3.23 Parameter change (Remote Meter)

When transmission is enabled by receiving a Request of Remote meter, the specified meter information is transmitted every 50 msec for 10 seconds. When you want to transmit meter information continuously, a Request must be transmitted continuously within every 10 seconds.

Reception

This is echoed if [Parameter change ECHO] is ON.

Transmission

When transmission has been enabled by a Request, the parameter specified by Address will be transmitted on the [Rx CH] channel at 50 msec intervals for a duration of 10 seconds.

Transmission will be disabled if the power is turned off and on again, or if the PORT setting is changed.

If [Parameter Change ECHO] is ON, this message is retransmitted without change.

STATUS	11110000	F0	System exclusive message
ID No.	01000011	43	Manufacture's ID number (YAMAHA)
SUB STATUS	0001nnnn	1n	n=0-15 (Device number=MIDI Channel)
GROUP ID	00111110	3E	MODEL ID (digital mixer)
MODEL ID	00001101	0D	01V96
ADDRESS	00100001	21	Remote meter
	0mmmmmm	mm	ADDRESS UL
	0mmmmmm	mm	ADDRESS LU
	0mmmmmm	mm	ADDRESS LL
DATA	0ddddddd	dd	Data1 H
	0ddddddd	dd	Data1 L
	:	:	
EOX	11110111	F7	End of exclusive

* Meter data uses the unmodified DECAY value of the DSP. The interpretation of the data will depend on the parameter.

2.8.3.24 Parameter request (Remote Meter)**Reception**

This is received if [Parameter change RX] is ON and the [Rx CH] matches the device number included in the SUB STATUS. This is echoed if [Parameter change ECHO] is ON.

When this is received, data of the specified address is transmitted on the [Rx

CH] at intervals of 50 msec as a rule (although this may not be the case if the port is being used by other communication), for a period of 10 seconds.

If Address UL= 0x7F is received, transmission of all meter data will be halted immediately. (disable)

Transmission

If [Parameter Change ECHO] is ON, this message is retransmitted without change.

STATUS	11110000	F0	System exclusive message
ID No.	01000011	43	Manufacture's ID number (YAMAHA)
SUB STATUS	0011nnnn	3n	n=0-15 (Device number=MIDI Channel)
GROUP ID	00111110	3E	MODEL ID (digital mixer)
MODEL ID	00001101	0D	01V96
ADDRESS	00100001	21	Remote meter
	0mmmmmm	mm	ADDRESS UL
	0mmmmmm	mm	ADDRESS LU
	0mmmmmm	mm	ADDRESS LL
	0ccccccc	ch	Count H
	0ccccccc	cl	Count L
EOX	11110111	F7	End of exclusive

2.8.3.25 Parameter change (Remote Time Counter)

When transmission is enabled by receiving a Request of Remote Time Counter, the Time Counter data is transmitted every 50 msec for 10 seconds. When you want to transmit Counter information continuously, a Request must be transmitted within every 10 seconds.

Reception

This is echoed if [Parameter change ECHO] is ON.

Transmission

When transmission is enabled by receiving a Request, the Time Counter information is transmitted on [RxCH] channel every 50 msec for 10 seconds. Transmission will be disabled if the power is turned off and on again, or if the PORT setting is changed.

If [Parameter Change ECHO] is ON, this message is retransmitted without change.

STATUS	11110000	F0	System exclusive message
ID No.	01000011	43	Manufacture's ID number (YAMAHA)
SUB STATUS	0001nnnn	1n	n=0-15 (Device number=MIDI Channel)
GROUP ID	00111110	3E	MODEL ID (digital mixer)
MODEL ID	00001101	0D	01V96
ADDRESS	00100010	22	Remote Time counter
	0000tttt	0t	0:Time code, 1:Measure.Beat.Clock
	0ddddddd	dd	Hour / Measure H
	0ddddddd	dd	Minute / Measure L
DATA	0ddddddd	dd	Second / Beat
	0ddddddd	dd	Frame / Clock
EOX	11110111	F7	End of exclusive

2.8.3.26 Parameter request (Remote Time Counter)**Reception**

This is received if [Parameter change RX] is ON and the [Rx CH] matches the device number included in the SUB STATUS. This is echoed if [Parameter change ECHO] is ON.

When this is received, the Time Counter information is transmitted on the [Rx CH] channel every 50 msec for 10 seconds.

When the second byte of Address is received on 0x7F, data transmission will be halted immediately. (disable)

Transmission

If [Parameter Change ECHO] is ON, this message is retransmitted without change.

STATUS	11110000	F0	System exclusive message
ID No.	01000011	43	Manufacture's ID number (YAMAHA)
SUB STATUS	0011nnnn	3n	n=0-15 (Device number=MIDI Channel)
GROUP ID	00111110	3E	MODEL ID (digital mixer)
MODEL ID	00001101	0D	01V96
ADDRESS	00100010	22	Remote Time counter
	0ddddddd	dd	0:Transmission request, 0x7F:Transmission stop request
EOX	11110111	F7	End of exclusive

Appendix D: Options

Rack Mounting the 01V96 Using RK1 Rack Mount Kit

You can rack mount the 01V96 using an optional RK1 Rack Mount Kit.

- 1 Hold one of the brackets against one side of the 01V96 so that the bracket ear projects to the side, and align three holes on the bracket with the holes on the side of the 01V96, as shown in the illustration below.
- 2 Affix the bracket using three screws included in the RK1 package.
- 3 Attach the other bracket to the other side of the 01V96 in the same way.

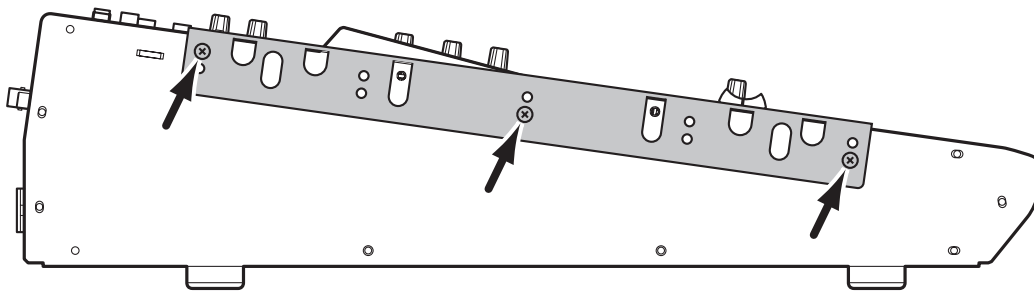

Index

Symbols

ø/INS/DLY DLY 1-16 page	80
ø/INS/DLY DLY 17-32 page	80
ø/INS/DLY Insert page	127, 160
ø/INS/DLY Out Dly page	99, 110
ø/INS/DLY Phase page	79
ø/INSERT/DELAY button	18
+48V ON/OFF switches	23

Numerics

1-16/17-32 buttons	19
1-8 buttons	21
2TR IN connectors	15, 70
2TR IN DIGITAL COAXIAL	24
2TR IN DIGITAL connector	71
2TRD	42
2TR OUT connectors	15, 70
2TR OUT DIGITAL COAXIAL	24
2TR OUT DIGITAL connector	71
2TRD	42

A

About the display	27
AC IN connector	25
AD input	14
AD output section	23
AD15/16 selector	15
adat	42
ADAT I/O card	72
ADAT IN/OUT connector	24, 71
AES/EBU I/O card	71
AMP SIMULATE	264
Analog inputs & outputs	69
Assigne	
Control changes	220
MIDI messages	209
Program changes	219
Remote Layer	189
USER DEFINED KEYS	197
Attenuator	83, 99, 110
Output signals	106
Auto Channel Select preference	231
Auto Direct Out On preference	232
Auto EQUALIZER Display preference	231
AUTO PAN	263
Auto PAN Display preference	231
Auto SOLO Display preference	231
Auto update function	169
Auto WORD CLOCK Display preference	231
AUX 1-AUX 8 buttons	17
Aux outs	109
Aux send mode	114, 118
Aux sends	113
Attenuating	110
Comp settings	111
Copying channel fader positions	120

Delaying	110
EQ settings	111, 113
Fixed mode	114
Panning	119
Setting from the control surface	113
Setting from the display	110, 113
Setting levels	113
Variable mode	115
Viewing settings	112
Viewing settings for multiple channels	117
Aux1 View1-16 page	117
Aux1 View17-STI page	117
AUX1-AUX8 button indicators	33

B

Balancing	104
Battery	242
Bulk dump	226
Messages	215
Bus out	97
Attenuating	99
Compressing	100
Delaying	99
EQ'ing	100
EQ'ing and Balancing	104
Naming	107
Pairing	105
Routing signals to the stereo bus	101
Setting from the control surface	104
Setting from the display	99
Setting the levels	104
Viewing the settings	102
BUS1-BUS8	139
Buttons	29

C

Cascade COMM Link preference	232
Cascading consoles	238
Cascade page	240
SYNC parameter	241
CATEGORY	73
CH1-4 ON/OFF switch	23
CH5-8 ON/OFF switch	23
CH9-12 ON/OFF switch	23
Changing names	229
Channel Copy Parameter preference	232
Channel faders	16
Channel ID/Channel preference	232
Channel library	177
Channel strip section	16
CHORUS	262
CLEAR button	22
Compressor library	184
Preset	185
Compressors	82, 100, 111
Compressor link	149
Linking	154
parameter table	284

Confirmation messages	30
Connections	37
Configuring a recording system that uses a DAW	39
Configuring a recording system with a hard disk recorder	38
Configuring an analog 24-channel mixing system	37
Contrast control	19
Control changes	215, 220
Control surface	13
AD input section	14
Channel strip section	16
Data entry section	22
DISPLAY ACCESS section	18
Display section	19
FADER MODE section	17
LAYER section	19
Monitor out & Headphones section	15
SCENE MEMORY section	21
SELECTED CHANNEL section	20
SOLO section	22
ST IN section	17
STEREO section	16
USER DEFINED KEYS section	21
COPY	74
Cursor buttons	22

D

Daisy chain distribution	40
Data entry section	22
DAW	206
Nuendo/Cubase SX	206
Other	206
Pro tools	190
Recording system	39
Remote	189
DEC & INC buttons	22
DEL button	30
Delay	80, 99, 110
DELAY SCALE	80
FB.GAIN	80
DELAY LCR	261
DELAY SCALE	80
DELAY+ER.	267
DELAY+REV	268
DELAY->ER.	267
DELAY->REV	268
Digital I/O section	24
Digital inputs & outputs	71
Dimensions	288
DIO Warning preference	231
DIO/Setup Cascade page	241
DIO/Setup Format page	74, 75
DIO/Setup Insert page	193
DIO/Setup Machine page	213
DIO/Setup Meter page	195
DIO/Setup MIDI/Host page	192, 212, 216, 241
DIO/Setup Monitor page	132
DIO/Setup Output Att page	106
DIO/Setup Prefer1 page	230

- DIO/Setup | Prefer2 page 230
DIO/Setup | Remote page 192, 208, 233
DIO/Setup | Surr Bus page 139
DIO/Setup | Word Clock page 41, 72
DIO/SETUP button 18
Direct outs 125
Display 19
DISPLAY ACCESS section 18
Display Brightness preference 233
Display section 19
DIST->DELAY 268
DISTORTION 264
Dithering 74
DIV 143
DOUBLE CHANNEL 75
DOUBLE SPEED 75
DUAL PITCH 263
DYNA. FILTER 264
DYNA. FLANGE 264
DYNA. PHASER 265
Dynamics | Comp Edit page
..... 82, 100, 111
Dynamics | Comp Lib page 184
Dynamics | Gate Edit page 81
Dynamics | Gate Lib page 183
DYNAMICS button 18
- E**
EARLY REF. 260
ECHO 262
EDIT indicator 27
Effect | FX1 Edit page 161
Effect | FX1 Lib page 179
Effect | FX2 Edit page 161
Effect | FX2 Lib page 179
Effect | FX3 Edit page 161
Effect | FX3 Lib page 179
Effect | FX4 Edit page 161
Effect | FX4 Lib page 179
Effect | P-In Edit page 163
EFFECT button 18
Effects
 Bypass 161
 Internal effects 157
 parameter tables 260
 Plug-ins 163
Effects library 179
 Preset 181
 programs 181
EMPHASIS 73
ENTER button 22
Enter titles
 Title edit window 30
EQ 84, 100, 104, 111, 113
 frequency 84
 gain 84
 Q 84
EQ | EQ Edit page 84, 100, 111
EQ | EQ Library page 186
EQ | Out Att page 99, 110
EQ button 18
EQ library 186
 Preset 187
- EQ link 149
- F**
F/R 143
F1–F4 buttons 19
Fader groups 149, 150
FADER MODE section 17
Fading 170
 ALL CLEAR 170
 AUX1–8 171
 BUS1–8 171
 Global fade time 170
 INPUT CH1–32 170
 ST IN 1–4 170
 STEREO 171
FAST 142
Fast Meter Fall Time preference 231
FB.GAIN 80
Features 11
 Channel configuration 12
 Effects 12
 Hardware 11
 Inputs and Outputs 11
 MIDI 12
 Remote control 12
 Scene memory 12
 Sonic specifications 11
 Surround sound 12
Fixed mode 114, 118
FLANGE 262
FREQUENCY control 20
FS 73
- G**
GAIN controls 15, 20, 70
Gain of the AD card 37
GANG 85
Gate library 183
GATE REVERB 260
Gates 81
 KEYIN SOURCE 81
 parameter table 284
Global Paste 173
Group 149
 Fader groups 150
 Mute groups 150
- H**
Hard disk
 Recording system 38
HIGH button 20
Higher sampling rates 75
HIGH-MID button 20
HOME button 17, 34
HOME button indicator 33
HORIZONTAL 93
HQ. PITCH 263
- I**
I/O card 71
 Installing 26
IEEE1394 72
- INDIVIDUAL 85
INIT 139
Initial Data Nominal preference 232
Initial Track Recording 49
Initializing the 01V96 243
Input channels 77
 Attenuating 83
 Compressing 82
 Delaying 80
 EQ 91
 EQ'ing 84
 Gating 81
 Levels 90
 Naming 94
 Pairing 92
 Panning 85, 90
 Routing 86
 Setting from the control surface .. 90
 Setting from the display 79
 Switching the signal phase 79
 Viewing the settings 87
INPUT connectors 14, 69
Input patch 121
 Initial settings 251
 Parameters 249
Input patch library 178
Input section 69
Input sensitivity
 GAIN controls 15
INS button 30
INSERT I/O connectors 14, 69
Insert in 129
Insert patching 127
Installing a card 26
INT 44.1k, INT 48k, INT 88.2, INT 96k
..... 42
Internal effects
 Aux sends 158
 Editing 161
 Effects processors 1–4 157
 Inserting into channels 160
 Meters 162
 MIX BALANCE 161
 TEMPO 162
Internet, yamaha web site 72
INV GANG 85
- K**
KEYIN SOURCE 81
- L**
LAST SOLO 132
LATCH 211
LAYER section 19
Layers 31
 Initial bank settings 256
LEARN button 210
Level controls 17
Levels 104, 113
LFE 143
Libraries 175
 Channel library 177
 Compressor library 184

- Effects library 179
 - EQ library 186
 - Gate library 183
 - General operation 175
 - Input patch library 178
 - Output patch library 179
 - specifications 285
 - Link 149
 - Compressors 154
 - EQ 154
 - LOW button 20
 - LOW-MID button 20
- M**
- M.BAND DYNA. 269
 - Machine control 212
 - MASTER button 19
 - MASTER MODE 36
 - Meter | CH1-32 page 34
 - Meter | Effect page 35
 - Meter | Master page 35
 - Meter | Position page 34
 - Meter | ST IN page 35
 - Meter | Stereo page 36
 - Metering 34
 - Meters
 - Stereo meters 19
 - MIDI 191, 215
 - Bulk dump 226
 - Bulk dump messages 215
 - Control changes 220
 - Data format 306
 - FADER H/L 224
 - Initial parameter to control change table 290
 - MIDI IN/THRU/OUT ports 25, 215
 - MIDI indicator 27
 - MIDI note on/off 215
 - Parameter changes 225
 - Parameters 221
 - Program changes 219
 - Scene memory to program change table 289
 - Setup 216
 - SLOT 216
 - System exclusive messages 215
 - Transmission and Reception 218
 - USB port 215
 - MIDI | Bulk page 226
 - MIDI | Ctl Asgn page 220
 - MIDI | Pgm Asgn page 219
 - MIDI | Setup page 218
 - MIDI button 18
 - MIDI IN/THRU/OUT ports 25
 - MIDI interface 191
 - MIDI machine control 215
 - MIDI remote 207
 - Banks 207
 - LATCH 211
 - LEARN button 210
 - MIDI messages 209
 - TARGET parameter 208
 - UNLATCH 211
 - MIDI Warning preference 231
 - MIDI/Control Section 25
 - mini-YGDAI I/O cards 71
 - MIX SOLO 132
 - MIXDOWN 132
 - Mixdown 47
 - mLAN I/O card 72
 - MMC 212, 215
 - MOD. DELAY 261
 - MOD. FILTER 264
 - MONITOR LEVEL control 15
 - Monitor out & Headphones section 15
 - MONITOR OUT connectors 23, 70
 - Monitor Source selector 15
 - Monitoring 131
 - Digital input channel status 73
 - LAST SOLO 132
 - MIX SOLO 132
 - MIXDOWN 132
 - MONO 133
 - RECORDING 132
 - Solo function 134
 - Solo safe function 133
 - Solo setup 132
 - MONO 133
 - MONO DELAY 260
 - MULTI FILTER 268
 - Multitrack recording 47
 - Mute groups 149, 150
 - Muting 200
- N**
- Naming 94, 107
 - Nominal Pan preference 231
 - Nuendo 189
 - Nuendo/Cubase SX 206
- O**
- OMNI OUT connectors 24, 44, 70
 - OMS 191
 - ON buttons 16, 17
 - Operating basics 27
 - About the display 27
 - AUX1–AUX8 button indicators 33
 - Buttons 29
 - Channel name 28
 - Confirmation messages 30
 - HOME button indicator 33
 - Metering 34
 - Page area 28
 - Page tabs 28
 - Page title 28
 - Parameter boxes 29
 - Rotary controls & faders 29
 - Sampling rate indicator 28
 - Selecting channels 32
 - Selecting display pages 28
 - Selecting fader modes 33
 - Selecting layers 31
 - Tab scroll arrows 28
 - Title edit window 30
 - OPERATION LOCK 237
 - Operation lock 237
 - Optional card 26
 - Installing 26
 - Options 6, 318
 - I/O card 71
 - RK1 318
 - Oscillator 234
 - Other functions 229
 - Preferences 230
 - Output patch 123
 - Initial settings 255
 - Parameters 253
 - Output patch library 179
 - Output section 70
- P**
- Package contents 6
 - PAD switches 15, 69
 - Pair Confirmation preference 231
 - PAIR/GROUP button 18
 - Pair/Grup | In Comp page 155
 - Pair/Grup | In EQ page 154
 - Pair/Grup | In Fader page 150
 - Pair/Grup | In Mute page 150
 - Pair/Grup | Input page 93
 - Pair/Grup | Out Comp page 155
 - Pair/Grup | Out EQ page 154
 - Pair/Grup | Out Fader page 150
 - Pair/Grup | Out Mute page 150
 - Pair/Grup | Output page 105
 - Pairing 92, 105
 - HORIZONTAL 93
 - Using the display 93
 - Using the SEL buttons 92
 - VERTICAL 93
 - PAN control 20
 - Pan/Route | Bus To St page 101
 - Pan/Route | Ch Edit page 142
 - Pan/Route | Pan page 90
 - Pan/Route | ROUT1-16 page 86
 - Pan/Route | ROUT17-ST1 page 86
 - Pan/Route | Surr ST IN page 146
 - Pan/Route | Surr1-16 page 146
 - Pan/Route | Surr17-32 page 146
 - PAN/ROUTING button 18
 - Pan/Surr | Surr Mode page 136
 - PAN/SURR LINK 137
 - Panning 85, 119
 - F.S 105
 - FOLLOW PAN 89
 - GANG 85
 - INDIVIDUAL 85
 - INV GANG 85
 - PAN buttons 86
 - Parameter boxes 29
 - Parameter changes 225
 - Parameter lists 247
 - Parameter wheel 22
 - Patch | 2TR Out page 125
 - Patch | Cascade In page 240
 - Patch | Direct Out page 125
 - Patch | Effect page 66, 158
 - Patch | IN LIB page 178

- Patch | IN Name page 94
Patch | In Name page 229
Patch | In Patch page 43, 122
Patch | Insert In page 129
Patch | Out LIB page 179
Patch | Out Name page 107, 230
Patch | Out Patch page 44, 124, 239
PATCH button 18, 122
Patch Confirmation preference 231
Patching 121
 2TR digital outputs 125
 ADAT OUT connector 124
 Direct outs 125
 Input and Output 43
 Input channels 43
 Input patching 121, 122
 Insert in 129
 Insert patching 127
 OMNI OUT connector 124
 Omni outs 44
 Output patching 123
 PATCH button 43
PEAK indicators 15, 70
Peak level 36
PHANTOM +48V 23
Phantom Power 69
 CH1–4 ON/OFF switch 23
 CH5–8 ON/OFF switch 23
 CH9–12 ON/OFF switch 23
Phase 79
PHASER 263
PHONES jack 15, 131
PHONES LEVEL control 15
PLUG-IN 227
Plug-ins 202
 Y56K 163
POWER ON/OFF switch 25
Power section 25
Prefer1 page 230
Prefer2 page 232
Preferences 230
Pro tools 189, 190, 200
 Automation 205
 Channel display mode 195
 Channel levels 199
 Control surface operation 196
 Explicit mute 200
 Flip mode 201
 Implicit mute 200
 Insert display mode 193
 Meter display mode 195
 MIDI 191
 Muting 201
 OMS 191
 Panning 200, 201
 Plug-ins 202
 Pre or Post 200
 Scrub & Shuttle 204
 Selecting 199
 Send levels 201
 Soloing 200
Program changes 215, 219
PROTECT button 168
- Q**
Q control 20
Q, EQ 84
- R**
Rear Panel
 PHANTOM +48V 23
Rear panel 23
 AD output section 23
 Digital I/O section 24
 MIDI/Control Section 25
 Power section 25
 SLOT section 25
RECALL button 21
Recall Confirmation preference 231
Recall safe function 172
RECORDING 132
Remote 189
 FRAMES 214
 Insert display mode 193
 LOCATE/TIME section 213
 Machine control 189, 212
 MACHINE CONTROL section 213
 MIDI messages 209
 MIDI remote 207
 Nuendo 189
 ProTools 189
 REMOTE 189
 Target parameter 192
 TRACK ARMING section 213
 TRANSPORT section 214
REMOTE button 19, 189
Remote Layer
 Nuendo/Cubase SX 206
 Pro tools 190
RESET BOTH 93
REV+CHORUS 265
REV+FLANGE 265
REV+SYMPHO. 266
REV->CHORUS 265
REV->FLANGE 266
REV->PAN 266
REV->SYMPHO. 266
REVERB HALL 260
REVERB PLATE 260
REVERB ROOM 260
REVERB STAGE 260
REVERSE GATE 260
RING MOD. 264
RK1 rack mount kit 318
ROTARY 264
Rotary controls & faders 29
Routing 86
Routing ST Pair Link preference 232
- S**
Sampling rates 72, 73
 DOUBLE CHANNEL 75
 DOUBLE SPEED 75
 Sampling rate indicator 28
 Setting the higher sampling rates 75
 SINGLE 76
 SRC sections 72
Scene | In Fade page 170
Scene | Out Fade page 171
Scene | Rcl Safe page 172
Scene | Scene page 168
Scene | Sort page 173
SCENE button 18
Scene MEM Auto Update preference 232
Scene memories 165
 Auto update function 169
 Edit indicators 166
 Fading 170
 PROTECT button 168
 Recall safe function 172
 Scene numbers 166
 Shadow memory 169
 Sorting 173
 Storing & Recalling 167
 Using the Scene Memory Page 168
 What is stored 165
Scene memory #00 166
Scene memory #Ud 166
SCENE MEMORY section 21
Scene numbers 166
Scene up/down buttons 21
SEL buttons 16, 17
SELECTED CHANNEL section 20
Selecting channels 32
Selecting display pages 28
Selecting fader modes 33
Setting levels 113
Setup 37
Shadow memory 169
SHIFT LOCK button 30
SIGNAL indicators 15, 70
SINGLE 76
SLOT 25, 42, 71, 216
SLOT section 25
Solo 132
 LAST SOLO 132
 LISTEN 132
 MIX SOLO 132
 MIXDOWN 132
 RECORDING 132
 SOLO 132
 Solo function 134
 SOLO SAFE CHANNEL 133
 Solo safe function 133
 SOLO TRIM 133
SOLO buttons 16, 17
SOLO indicator 22
SOLO section 22
Specifications 280
SRC sections 72
ST IN button 17
ST IN section 17
Star distribution 40
STEREO DELAY 261
STEREO fader 16

- Stereo meters 19
- Stereo out 97
- Attenuating 99
 - Compressing 100
 - Delaying 99
 - EQ'ing 100
 - EQ'ing and Balancing 104
 - Naming 107
 - Pairing 105
 - Setting from the control surface 104
 - Setting from the display 99
 - Setting the levels 104
 - Viewing the settings 102
- STEREO OUT connectors 24, 70
- STEREO section 16
- STORE button 21
- Store Confirmation preference 231
- Storing and Recalling 167
- Surround 135
- BUS1–BUS8 139
 - DIV 143
 - F.S 105
 - F/R 143
 - FAST 142
 - INIT 139
 - LFE 143
 - LINK 143
 - Pan graph 142
 - PAN/SURR LINK 137
 - Panning 142
 - PATTERN 143
 - Setting up and Selecting 136
 - ST LINK 143
 - SURROUND MODE 87, 137
 - Surround mode indicator 27
 - Trajectory patterns 142
- SURROUND MODE 137
- Surround mode indicator 27
- Surround modes 135, 136
- Factory-default 136
- SYMPHONIC 262
- SYNC parameter 241
- System exclusive messages 215
- System version 242
- ## T
- Tab scroll arrows 28
- Tab scroll buttons 20
- Target parameter 192
- Tascam I/O card 72
- Title edit window 30
- TO HOST USB port 25
- Trajectory patterns 143
- TREMOLO 263
- Tutorial 47
- Compressing 57
 - EQ'ing 56
 - Initial Track Recording 49
 - Internal Effects 66
 - Master Recorder 68
 - Mixdown 63
 - Monitoring Level 54, 61
- Overdubbing 60
- Pairing 50
- Recording 59, 62
- Routing 51
- Setting the Input Levels 49
- ## U
- UNLATCH 211
- USB 25
- OMS 191
 - USB port 215
- User assignable layer 233
- USER DEFINED KEYS 21
- Initial assignments 249
- User defined keys 235
- Utility | Battery page 242
- Utility | CH Status page 73
- Utility | Lock page 237
- Utility | Oscillator page 234
- Utility | User Def page 235
- UTILITY button 18
- ## V
- Variable mode 115, 118
- VERTICAL 93
- View | Fader page 88, 102, 112
- View | Library page 177
- View | Parameter page 87, 102, 112
- VIEW button 18
- ## W
- WC IN 42
- Web site 72
- Website 6
- Welcome 11
- Window
- Changing the surround mode ... 138
 - Channel Pairing 92
 - Copy operation 120
 - Password 237
 - Set Password 238
 - User Define Select 236
- WORD CLOCK IN connector 24
- WORD CLOCK OUT connector 24
- Wordclock 40
- About wordclock 40
 - Connections 40
 - Daisy chain distribution 40
 - Source 42
 - Specifying source 41
 - Star distribution 40
 - WC IN 42
- ## Y
- Y56K 163
- Yamaha web site 72
- Yamaha website 6

MIDI Implementation Chart

Function...		Transmitted	Recognized	Remarks
Basic Channel	Default Changed	1-16 1-16	1-16 1-16	Memorized
Mode	Default Messages Altered	X X *****	OMNI off/OMNI on X X	Memorized
Note Number	True Voice	X *****	0-127 X	
Velocity	Note On Note Off	X X	O O	Effect Control
After	Key's Ch's	X X	X X	
Pitch Bend		X	X	
Control Change	0-95,102-119	O	O	Assignable
Prog Change	:True#	0-127 *****	0-127 0-99	Assignable
System Exclusive		O	O	*1
System Common	:Song Pos :Song Sel :Tune	X X X	X X X	
System Real Time	:Clock :Commands	X X	O X	Effect Control
Aux Messages	:Local ON/OFF :All Notes OFF :Active Sense :Reset	X X X X	X X O O	
Notes	MTC quarter frame message is recognized. *1: Bulk Dump/Request, Parameter Change/Request, and MMC. For MIDI Remote, ALL messages can be transmitted.			

Mode 1: OMNI ON, POLY
Mode 3: OMNI OFF, POLY

Mode 2: OMNI ON, MONO
Mode 4: OMNI OFF, MONO

O: Yes
X: No

01V96 Block Diagram

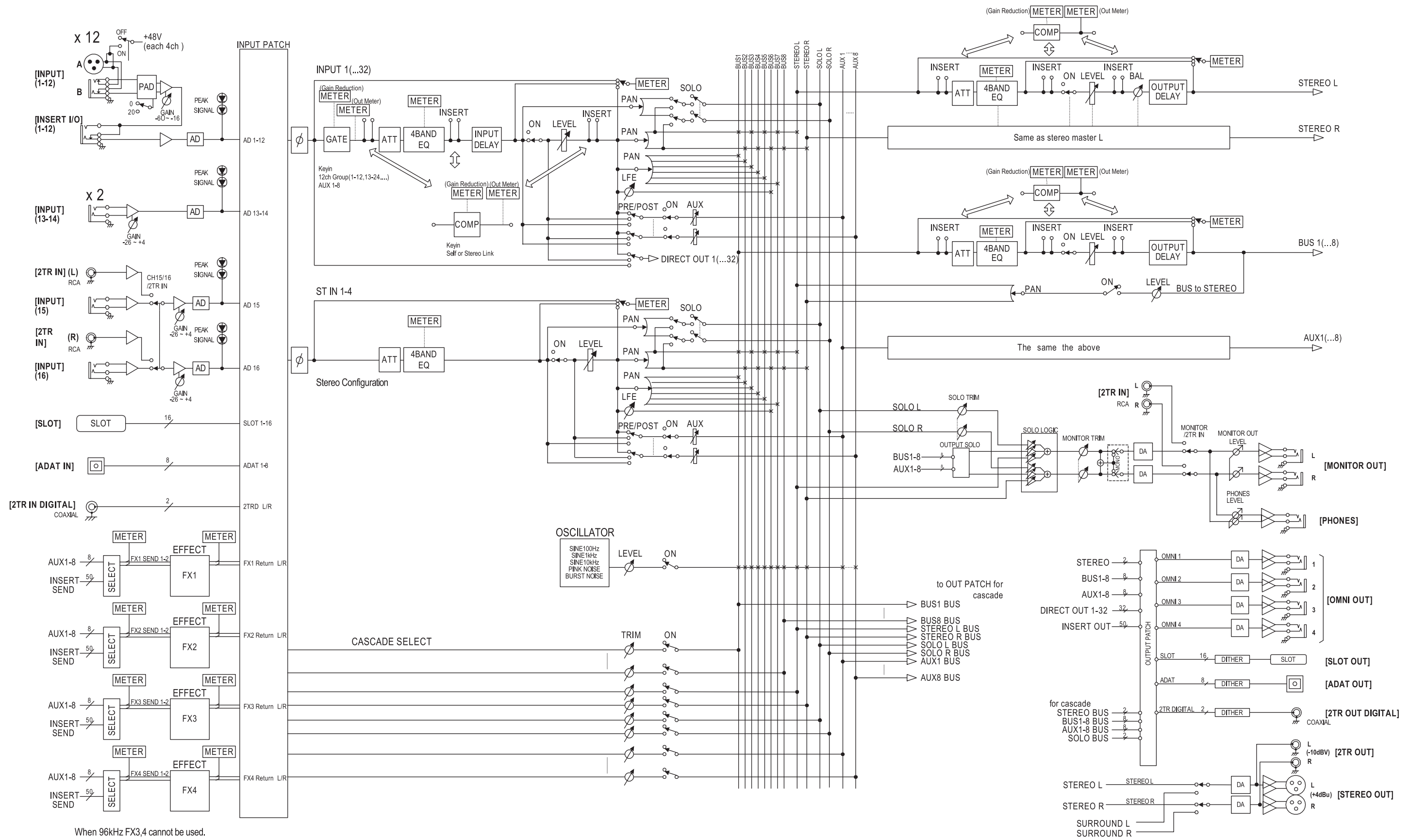

When 96kHz FX3,4 cannot be used.

01V96 Level Diagram

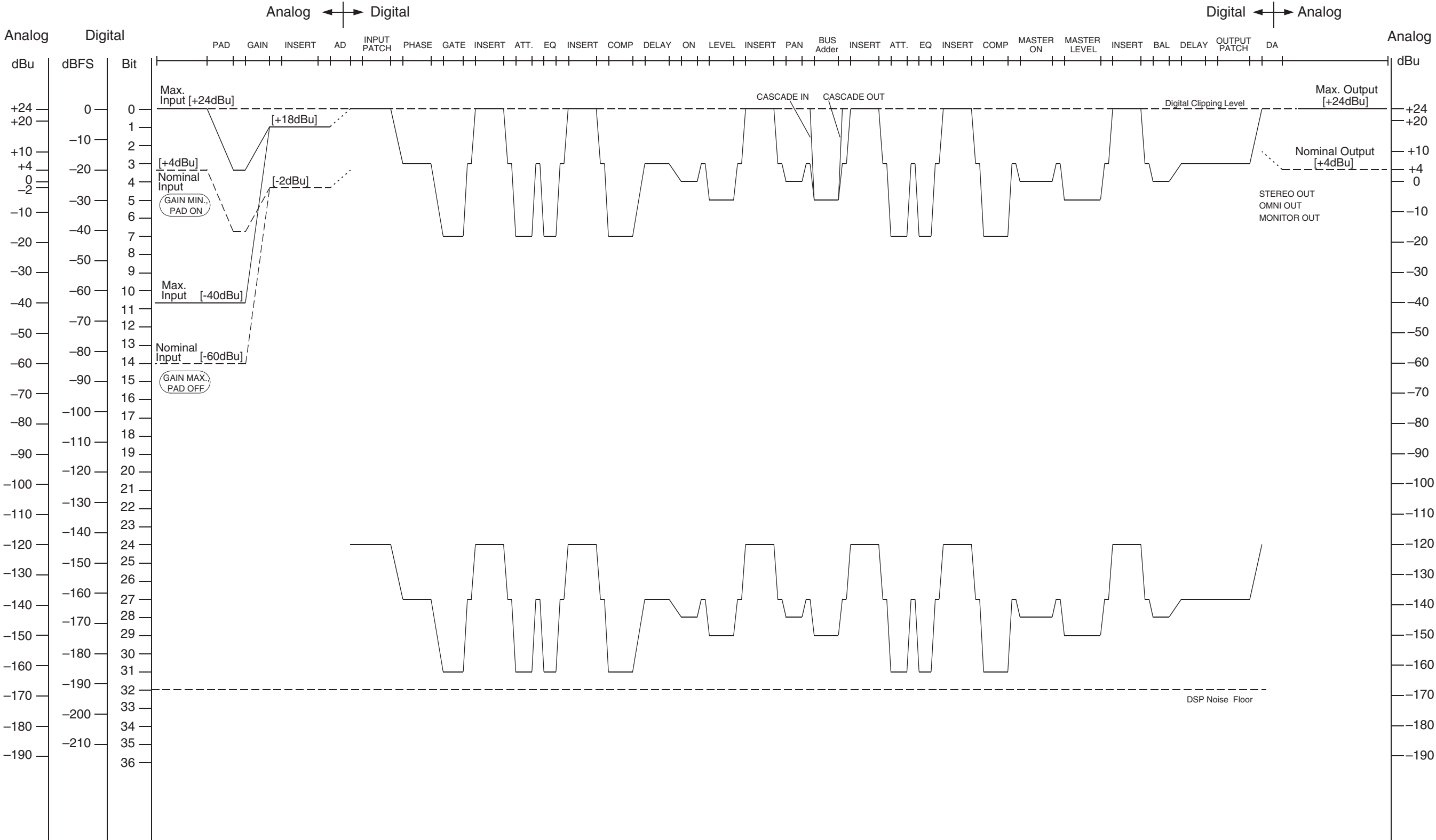

[0dBu = 0.775Vrms]
 [0dBFS = Full Scale]

For details of products, please contact your nearest Yamaha representative or the authorized distributor listed below.

Pour plus de détails sur les produits, veuillez-vous adresser à Yamaha ou au distributeur le plus proche de vous figurant dans la liste suivante.

Die Einzelheiten zu Produkten sind bei Ihrer unten aufgeführten Niederlassung und bei Yamaha Vertragshändlern in den jeweiligen Bestimmungsländern erhältlich.

Para detalles sobre productos, contacte su tienda Yamaha más cercana o el distribuidor autorizado que se lista debajo.

NORTH AMERICA

CANADA

Yamaha Canada Music Ltd.
135 Milner Avenue, Scarborough, Ontario,
M1S 3R1, Canada
Tel: 416-298-1311

U.S.A.

Yamaha Corporation of America
6600 Orangethorpe Ave., Buena Park, Calif. 90620,
U.S.A.
Tel: 714-522-9011

CENTRAL & SOUTH AMERICA

MEXICO

Yamaha de México S.A. de C.V.
Calz. Javier Rojo Gómez #1149,
Col. Guadalupe del Moral
C.P. 09300, México, D.F., México
Tel: 55-5804-0600

BRAZIL

Yamaha Musical do Brasil Ltda.
Av. Reboucas 2636-Pinheiros CEP: 05402-400
Sao Paulo-SP, Brasil
Tel: 011-3085-1377

ARGENTINA

Yamaha Music Latin America, S.A.
Sucursal de Argentina
Viamonte 1145 Piso2-B 1053,
Buenos Aires, Argentina
Tel: 1-4371-7021

PANAMA AND OTHER LATIN AMERICAN COUNTRIES/ CARIBBEAN COUNTRIES

Yamaha Music Latin America, S.A.
Torre Banco General, Piso 7, Urbanización Marbella,
Calle 47 y Aquilino de la Guardia,
Ciudad de Panamá, Panamá
Tel: +507-269-5311

EUROPE

THE UNITED KINGDOM

Yamaha-Kemble Music (U.K.) Ltd.
Sherbourne Drive, Tilbrook, Milton Keynes,
MK7 8BL, England
Tel: 01908-366700

GERMANY

Yamaha Music Central Europe GmbH
Siemensstraße 22-34, 25462 Rellingen, Germany
Tel: 04101-3030

SWITZERLAND/LIECHTENSTEIN

Yamaha Music Central Europe GmbH,
Branch Switzerland
Seefeldstrasse 94, 8008 Zürich, Switzerland
Tel: 01-383 3990

AUSTRIA

Yamaha Music Central Europe GmbH,
Branch Austria
Schleiergasse 20, A-1100 Wien, Austria
Tel: 01-60203900

CZECH REPUBLIC/SLOVAKIA/ HUNGARY/SLOVENIA

Yamaha Music Central Europe GmbH,
Branch Austria, CEE Department
Schleiergasse 20, A-1100 Wien, Austria
Tel: 01-602039025

POLAND

Yamaha Music Central Europe GmbH
Sp.z. o.o. Oddział w Polsce
ul. 17 Stycznia 56, PL-02-146 Warszawa, Poland
Tel: 022-868-07-57

THE NETHERLANDS/ BELGIUM/LUXEMBOURG

Yamaha Music Central Europe GmbH,
Branch Benelux
Clarissenhof 5-b, 4133 AB Vianen, The Netherlands
Tel: 0347-358 040

FRANCE

Yamaha Musique France
BP 70-77312 Marne-la-Vallée Cedex 2, France
Tel: 01-64-61-4000

ITALY

Yamaha Musica Italia S.P.A.
Combo Division
Viale Italia 88, 20020 Lainate (Milano), Italy
Tel: 02-935-771

SPAIN/PORTUGAL

Yamaha-Hazen Música, S.A.
Ctra. de la Coruna km. 17, 200, 28230
Las Rozas (Madrid), Spain
Tel: 91-639-8888

SWEDEN

Yamaha Scandinavia AB
J. A. Wettergrens Gata 1
Box 30053
S-400 43 Göteborg, Sweden
Tel: 031 89 34 00

DENMARK

YS Copenhagen Liaison Office
Generatorvej 6A
DK-2730 Herlev, Denmark
Tel: 44 92 49 00

NORWAY

Norsk filial av Yamaha Scandinavia AB
Grini Næringspark 1
N-1345 Østerås, Norway
Tel: 67 16 77 70

OTHER EUROPEAN COUNTRIES

Yamaha Music Central Europe GmbH
Siemensstraße 22-34, 25462 Rellingen, Germany
Tel: +49-4101-3030

AFRICA

Yamaha Corporation,
Asia-Pacific Music Marketing Group
Nakazawa-cho 10-1, Hamamatsu, Japan 430-8650
Tel: +81-53-460-2313

MIDDLE EAST

TURKEY/CYPRUS

Yamaha Music Central Europe GmbH
Siemensstraße 22-34, 25462 Rellingen, Germany
Tel: 04101-3030

OTHER COUNTRIES

Yamaha Music Gulf FZE
LB21-128 Jebel Ali Freezone
P.O.Box 17328, Dubai, U.A.E.
Tel: +971-4-881-5868

ASIA

THE PEOPLE'S REPUBLIC OF CHINA

Yamaha Music & Electronics (China) Co., Ltd.
25/F., United Plaza, 1468 Nanjing Road (West),
Jingan, Shanghai, China
Tel: 021-6247-2211

INDONESIA

PT. Yamaha Music Indonesia (Distributor)
PT. Nusantik
Gedung Yamaha Music Center, Jalan Jend. Gatot
Subroto Kav. 4, Jakarta 12930, Indonesia
Tel: 21-520-2577

KOREA

Yamaha Music Korea Ltd.
Tong-Yang Securities Bldg. 16F 23-8 Yoido-dong,
Youngdungpo-ku, Seoul, Korea
Tel: 02-3770-0660

MALAYSIA

Yamaha Music Malaysia, Sdn., Bhd.
Lot 8, Jalan Perbandaran, 47301 Kelana Jaya,
Petaling Jaya, Selangor, Malaysia
Tel: 3-78030900

SINGAPORE

Yamaha Music Asia Pte., Ltd.
#03-11 A-Z Building
140 Paya Lebar Road, Singapore 409015
Tel: 747-4374

TAIWAN

Yamaha KHS Music Co., Ltd.
3F, #6, Sec.2, Nan Jing E. Rd. Taipei.
Taiwan 104, R.O.C.
Tel: 02-2511-8688

THAILAND

Siam Music Yamaha Co., Ltd.
891/1 Siam Motors Building, 15-16 floor
Rama 1 road, Wangmai, Pathumwan
Bangkok 10330, Thailand
Tel: 02-215-2626

OTHER ASIAN COUNTRIES

Yamaha Corporation,
Asia-Pacific Music Marketing Group
Nakazawa-cho 10-1, Hamamatsu, Japan 430-8650
Tel: +81-53-460-2317

OCEANIA

AUSTRALIA

Yamaha Music Australia Pty. Ltd.
Level 1, 99 Queensbridge Street, Southbank,
Victoria 3006, Australia
Tel: 3-9693-5111

COUNTRIES AND TRUST TERRITORIES IN PACIFIC OCEAN

Yamaha Corporation,
Asia-Pacific Music Marketing Group
Nakazawa-cho 10-1, Hamamatsu, Japan 430-8650
Tel: +81-53-460-2313

HEAD OFFICE Yamaha Corporation, Pro Audio & Digital Musical Instrument Division
Nakazawa-cho 10-1, Hamamatsu, Japan 430-8650
Tel: +81-53-460-2441



Yamaha Manual Library
<http://www.yamaha.co.jp/manual/>

This document is printed on recycled
chlorine free (ECF) paper with soy ink.

U.R.G., Pro Audio & Digital Musical Instrument Division, Yamaha Corporation
© 2004 Yamaha Corporation

WE05050 604IPAP2.3-06C0
Printed in Japan